

BEN Series

Compact, Amplifier Built-In Type With Universal Voltage

■ Features

- Small and power supply built-in type
- Easy installation with LED indicators on product
- Light ON/Dark ON operation mode switch
- Status and output LED indication
- Built-in IC photo diode for disturbing light and electrical noise

 Please read "Safety Considerations" in operation manual before using.

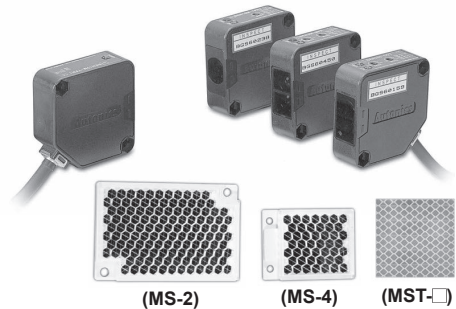

※MS-4, MST-□ is sold separately.

■ Specifications

• Free power, Relay contact output type

Model	BEN10M-TFR	BEN5M-MFR	BEN3M-PFR	BEN300-DFR
Sensing type	Through-beam	Retroreflective (standard type)	Retroreflective (built-in polarizing filter)	Diffuse reflective
Sensing distance	10m	5m ^{※1}	3m ^{※1}	300mm ^{※2}
Sensing target	Opaque materials of Min. Ø16mm	Opaque materials of Min. Ø60mm		Translucent, Opaque materials
Hysteresis	—			Max. 20% at rated setting distance
Response time	Max. 20ms			
Power supply	24-240VAC~ ±10% 50/60Hz, 24-240VDC= ±10% (ripple P-P: max. 10%)			
Current consumption	Max. 4VA			
Light source	Infrared LED (850nm)		Red LED (660nm)	Infrared LED (940nm)
Sensitivity adjustment	—		Sensitivity adjuster	
Operation mode	Light ON/Dark ON operation mode switch			
Control output	Relay contact output (relay contact capacity: 30VDC= 3A of resistive load, 250VAC~ 3A resistive load, relay contact composition: 1c)			
Relay life cycle	Mechanically: min. 50,000,000 operation, electrically: min. 100,000 operation			
Light receiving element	Photo IC			
Indicator	Operation indicator: red LED, Stability indicator: green LED (the red lamp on Emitter of transmitted beam type is for power indication)			
Insulation resistance	Over 20MΩ (at 500VDC megger)			
Insulation type	Double or strong insulation (mark:  , dielectric voltage between the measured input and the power: 1kV)			
Noise immunity	±1,000V the square wave noise (pulse width: 1μs) by the noise simulator			
Dielectric strength	1000VAC 50/60Hz for 1minute			
Vibration	Mechanical	1.5mm amplitude at frequency of 10 to 55Hz (for 1 min) in each X, Y, Z direction for 2 hours		
	Malfunction	1.5mm amplitude at frequency of 10 to 55Hz (for 1 min) in each X, Y, Z direction for 10 minutes		
Shock	Mechanical	500m/s ² (approx. 50G) in each X, Y, Z direction for 3 times		
	Malfunction	100m/s ² (approx. 10G) in each X, Y, Z direction for 3 times		
Environment	Ambient illumination	Sunlight: max. 11,000lx, incandescent lamp: max. 3,000lx (receiver illumination)		
	Ambient temperature	-20 to 65°C, storage: -25 to 70°C		
	Ambient humidity	35 to 85%RH, storage: 35 to 85%RH		
Protection structure	IP50 (IEC standard)			
Material	Case, case cover: heat resistant acrylonitrile butadiene styrene, sensing part: polycarbonate (with polarizing filter: polymethyl methacrylate), bracket: steel plate cold commercial, bolt: steel chromium molybdenum, nut: steel chromium molybdenum			
Cable	Ø5mm, 5-wire, 2m (emitter of through-beam type: Ø5mm, 2-wire, 2m) (AWG22, core diameter: 0.08mm, number of cores: 60, insulator out diameter: Ø1.25mm)			
Accessory	Individual	—		Reflector (MS-2)
	Common	Adjuster driver, fixing bracket, bolts, nuts		
Unit weight	Approx. 354g	Approx. 208g		Approx. 195g

※1: The sensing distance is specified with using the MS-2 reflector and the same as the MS-4 reflector. Sensing distance is the setting range of the reflector. The sensor can detect under 0.1m.

When using reflective tapes, the reflectivity will vary by the size of the tape. Please refer to the "■ Reflectivity by Reflective Tape Model" table before using the tapes.

※2: Non-glossy white paper 200×200mm.

※ The temperature or humidity mentioned in Environment indicates a non freezing or condensation environment.

Amplifier Built-in Type With Universal Voltage

● DC power, Solid state output type

Model	BEN10M-TDT	BEN5M-MDT	BEN3M-PDT	BEN300-DDT
Sensing type	Through-beam	Retroreflective	Retroreflective (with polarizing filter)	Diffuse reflective
Sensing distance	10m	5m ^{※1}	3m ^{※1}	300mm ^{※2}
Sensing target	Opaque materials of Min. Ø16mm	Opaque materials of Min. Ø60mm		Translucent, Opaque materials
Hysteresis	—			Max. 20% at rated setting distance
Response time	Max. 1ms			
Power supply	12-24VDC \pm 10% (ripple P-P: max. 10%)			
Current consumption	Max. 50mA			
Light source	Infrared LED (850nm)		Red LED (660nm)	Infrared LED (940nm)
Sensitivity adjustment	—		Sensitivity adjuster	
Operation mode	Light ON/Dark ON operation mode switch			
Control output	NPN open collector / PNP open collector simultaneous output ●Load voltage: max. 30VDC \pm ●Load current: max. 200mA ●Residual voltage - NPN: max. 1VDC \pm , PNP: max. 2.5VDC			
Protection circuit	Reverse polarity protection circuit, output overcurrent (short-circuit) protection circuit			
Light receiving element	Photo IC			
Indicator	Operation indicator: red, stability indicator: green (the red lamp on Emitter of transmitted beam type is for power indication)			
Insulation resistance	Over 20M Ω (at 500VDC megger)			
Noise immunity	\pm 240V the square wave noise (pulse width: 1 μ s) by the noise simulator			
Dielectric strength	1000VAC 50/60Hz for 1minute			
Vibration	1.5mm amplitude at frequency of 10 to 55Hz (for 1 min) in each X, Y, Z direction for 2 hours			
Shock	500m/s ² (approx. 50G) in each X, Y, Z direction for 3 times			
Environment	Ambient illumination	Sunlight: max. 11,000lx, incandescent lamp: max. 3,000lx (receiver illumination)		
	Ambient temperature	-20 to 65°C, storage: -25 to 70°C		
	Ambient humidity	35 to 85%RH, storage: 35 to 85%RH		
Protection structure	IP50 (IEC standard)			
Material	case, case cover: heat resistant acrylonitrile butadiene styrene, sensing part: polycarbonate (with polarizing filter: polymethyl methacrylate), bracket: steel plate cold commercial, bolt: steel chromium molybdenum, nut: steel chromium molybdenum			
Cable	Ø5mm, 4-wire, 2m (emitter of through-beam type: Ø5mm, 2-wire, 2m) (AWG22, core diameter: 0.08mm, number of cores: 60, insulator diameter: Ø1.25mm)			
Accessory	Individual	—		Reflector (MS-2)
	Common	Adjuster driver, Fixing bracket, Bolts, Nuts		
Approval	CE			
Unit weight	Approx. 342g	Approx. 200g	Approx. 187g	

※1: The sensing distance is specified with using the MS-2 reflector and the same as the MS-4 reflector. Sensing distance is the setting range of the reflector. The sensor can detect under 0.1m.
When using reflective tapes, the reflectivity will vary by the size of the tape. Please refer to the "Reflectivity By Reflective Tape Model" table before using the tapes.

※2: Non-glossy white paper 100×100mm.

※The temperature or humidity mentioned in Environment indicates a non freezing or condensation environment.

■ Feature data

◎ Through-beam type

● BEN10M-TFR ● BEN10M-TDT

Parallel shifting characteristic		Angle characteristic	
Measuring method	Data	Measuring method	Data

(A) Photoelectric Sensors
(B) Fiber Optic Sensors
(C) Door/Area Sensors
(D) Proximity Sensors
(E) Pressure Sensors
(F) Rotary Encoders
(G) Connectors/ Connector Cables/ Sensor Distribution Boxes/ Sockets
(H) Temperature Controllers
(I) SSRs / Power Controllers
(J) Counters
(K) Timers
(L) Panel Meters
(M) Tacho / Speed / Pulse Meters
(N) Display Units
(O) Sensor Controllers
(P) Switching Mode Power Supplies
(Q) Stepper Motors & Drivers & Controllers
(R) Graphic/ Logic Panels
(S) Field Network Devices
(T) Software

BEN Series

Feature Data

Retroreflective type (standard type)

- BEN5M-MFR • BEN5M-MDT

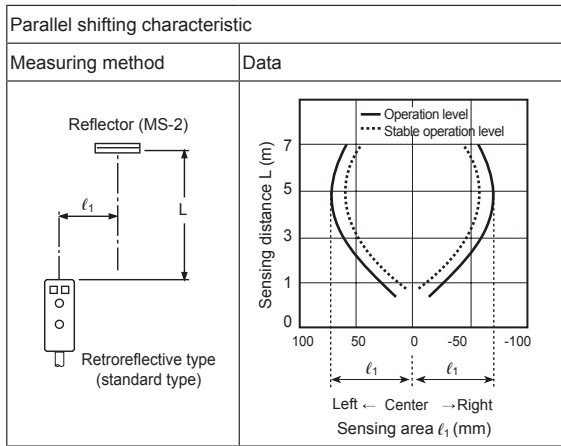

- BEN5M-MFR • BEN5M-MDT

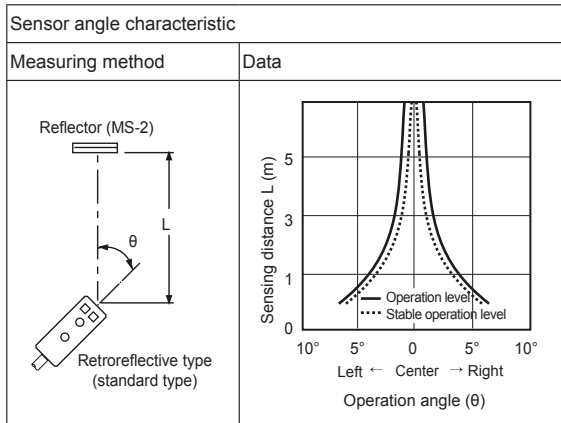

- BEN5M-MFR • BEN5M-MDT

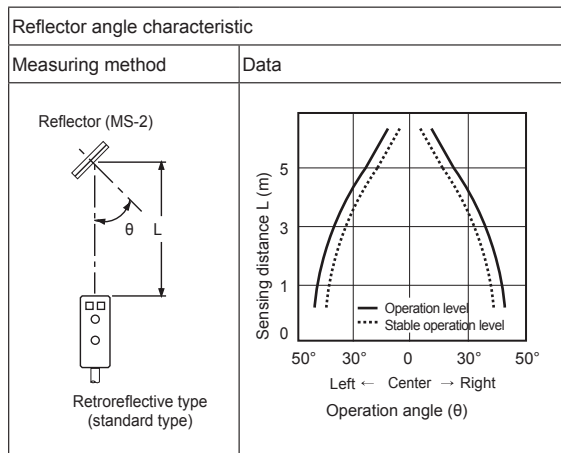

Retroreflective type (built-in polarizing filter)

- BEN3M-PFR • BEN3M-PDT

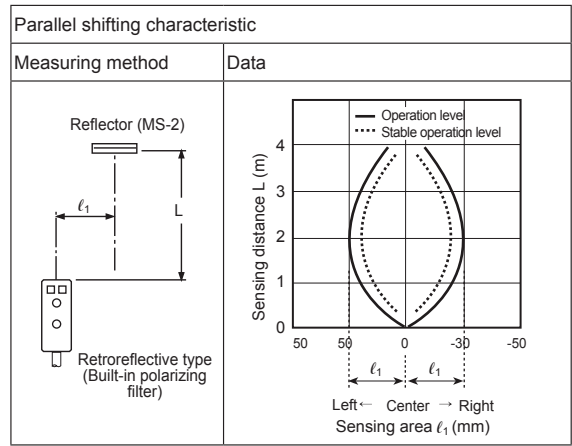

- BEN3M-PFR • BEN3M-PDT

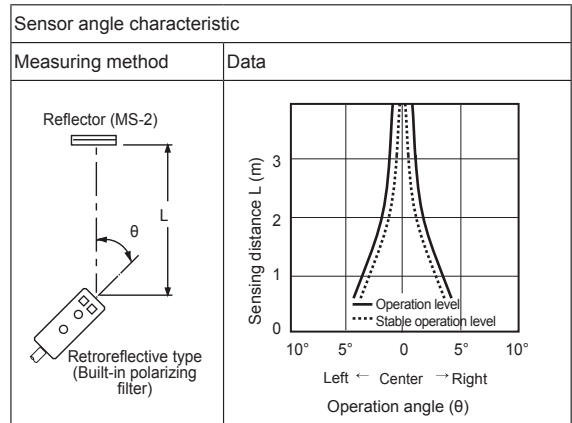

- BEN3M-PFR • BEN3M-PDT

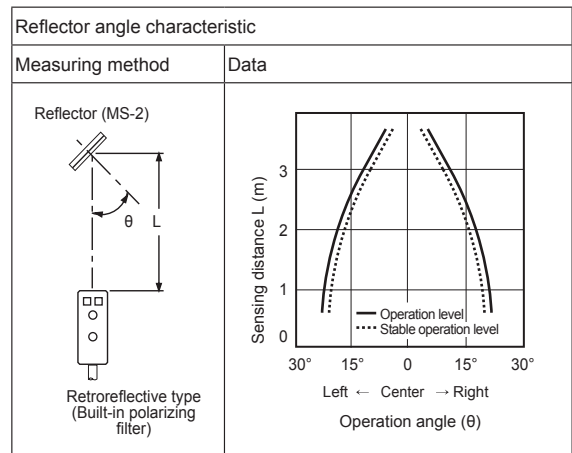

Amplifier Built-in Type With Universal Voltage

◎ Diffuse reflective type

● BEN300-DFR ● BEN300-DDT

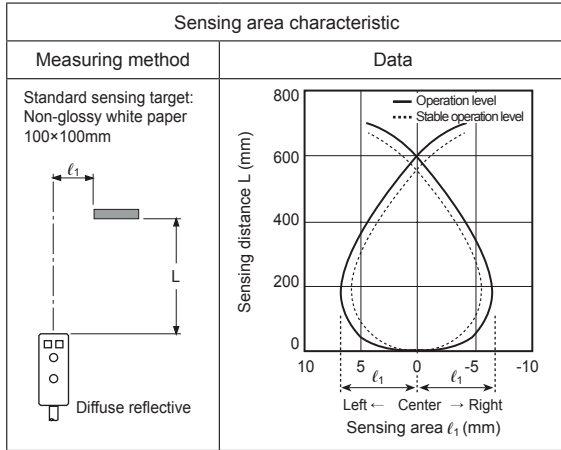

■ Operation Mode

Operation mode	Light ON
Receiver operation	Received light Interrupted light
Operation indicator (red LED)	ON OFF
Transistor output	ON OFF

Operation mode	Dark ON
Receiver operation	Received light Interrupted light
Operation indicator (red LED)	ON OFF
Transistor output	ON OFF

■ Control Output Diagram

● DC voltage (NPN/PNP synchronous output)

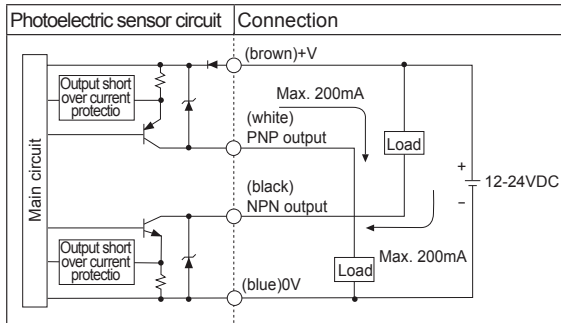

● Free power (Relay contact output)

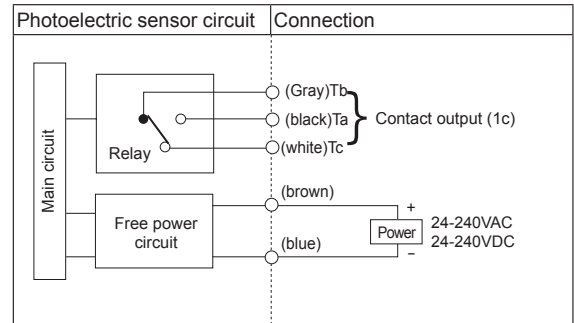

※In case of product with the output protection device, if terminals of control output are short circuited or overcurrent condition exists, the control output turns OFF due to protection circuit.

■ Operation Timing Diagram

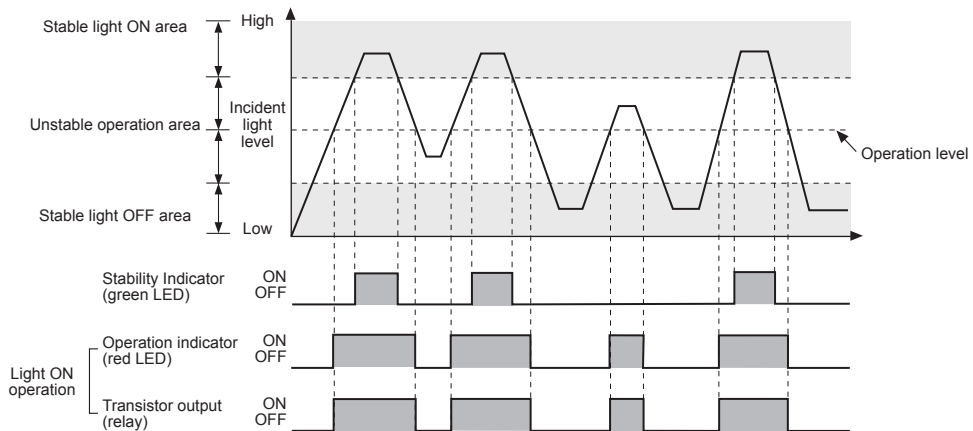

※The waveforms of “Operation indicator” and “Transistor output” are for Light ON operation. They are opposite operation for Dark ON operation.

- (A) Photoelectric Sensors
- (B) Fiber Optic Sensors
- (C) Door/Area Sensors
- (D) Proximity Sensors
- (E) Pressure Sensors
- (F) Rotary Encoders
- (G) Connectors/ Connector Cables/ Sensor Distribution Boxes/ Sockets
- (H) Temperature Controllers
- (I) SSRs / Power Controllers
- (J) Counters
- (K) Timers
- (L) Panel Meters
- (M) Tacho / Speed / Pulse Meters
- (N) Display Units
- (O) Sensor Controllers
- (P) Switching Mode Power Supplies
- (Q) Stepper Motors & Drivers & Controllers
- (R) Graphic/ Logic Panels
- (S) Field Network Devices
- (T) Software

BEN Series

■ Connections

Through-beam		Retroreflective	Diffuse reflective
<ul style="list-style-type: none"> • BEN10M-TFR1 • BEN10M-TFR2 	<ul style="list-style-type: none"> • BEN5M-MFR (standard type) • BEN3M-PFR (built-in polarizing filter) 	<ul style="list-style-type: none"> • BEN300-DFR 	
<ul style="list-style-type: none"> • BEN10M-TDT1 • BEN10M-TDT2 	<ul style="list-style-type: none"> • BEN5M-MDT (standard type) • BEN3M-PDT (built-in polarizing filter) 	<ul style="list-style-type: none"> • BEN300-DDT 	

※ Unused line must be insulated.

■ Dimensions

(unit: mm)

● Connect the bracket

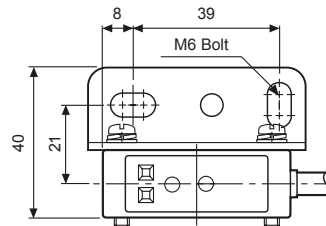
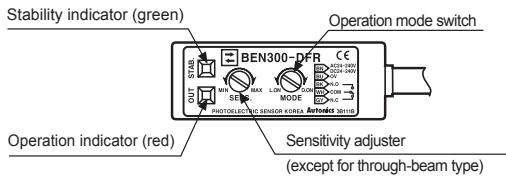

●Through-beam ●Retroreflective ●Diffuse reflective

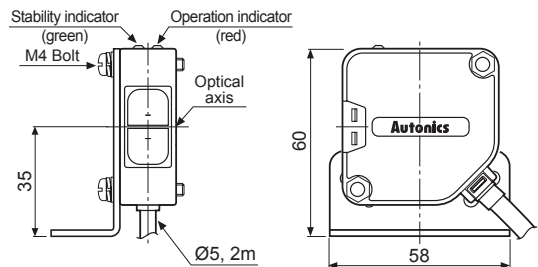
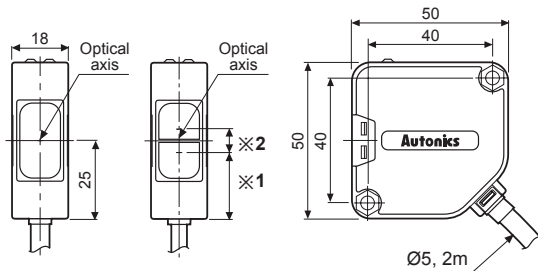

※1: Retroreflective: 21.25mm, Diffuse reflective: 20.25mm
 ※2: Retroreflective: 7.5mm, Diffuse reflective: 9.5mm

Amplifier Built-in Type With Universal Voltage

● Reflector

• MS-2

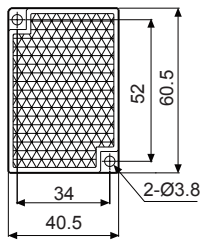

• MS-4 (sold separately)

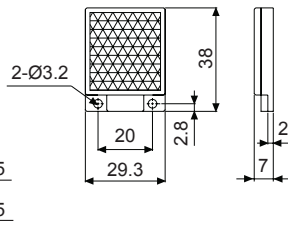

● Reflective tape (sold separately)

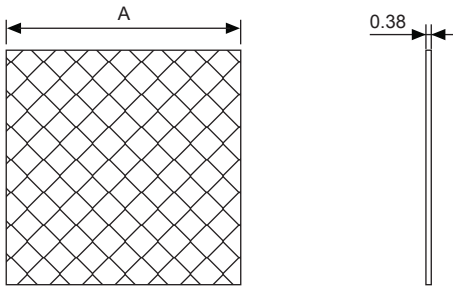

● Bracket

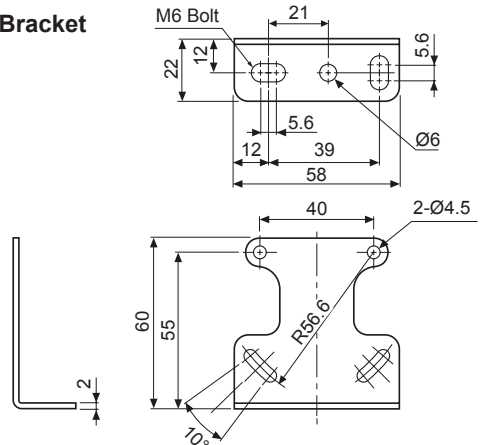

(unit: mm)

Model	A
MST-50-10	<input type="checkbox"/> 50
MST-100-5	<input type="checkbox"/> 100
MST-200-2	<input type="checkbox"/> 200

■ Mounting and sensitivity adjustment

◎ Through-beam type

1. Supply the power to the photoelectric sensor, after setting the emitter and the receiver facing each other.
 2. Set the receiver in center of position in the middle of the stability range of indicator by adjusting the receiver or the emitter right and left, up and down.
 3. After the adjustment, check the stability of operation by putting the object at the optical axis.
- ※If the sensing target is translucent body or smaller than $\varnothing 16\text{mm}$, it can be missed by sensor because light penetrate it.

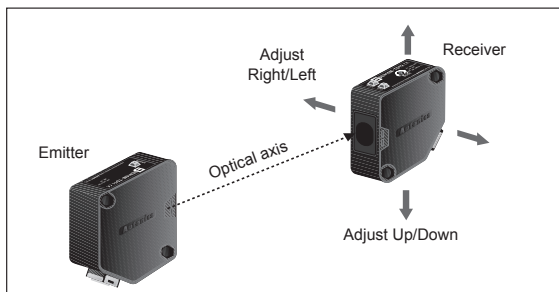

◎ Diffuse reflective type

1. The sensitivity should be adjusted depending on a sensing target or mounting place.
 2. Set the target at a position to be detected by the beam, then turn the sensitivity adjuster until position (a) where the operation indicator turns ON from min. position of the sensitivity adjuster.
 3. Take the target out of the sensing area, then turn the sensitivity adjuster until position (b) where the operation indicator turns ON. If the indicator dose not turn ON, max. position is (b).
 4. Set the sensitivity adjuster at the center of two switching position (a), (b).
- ※The sensing distance indicated on specification chart is for 100×100mm of non-glossy white paper. Be sure that it can be different by size, surface and gloss of target.

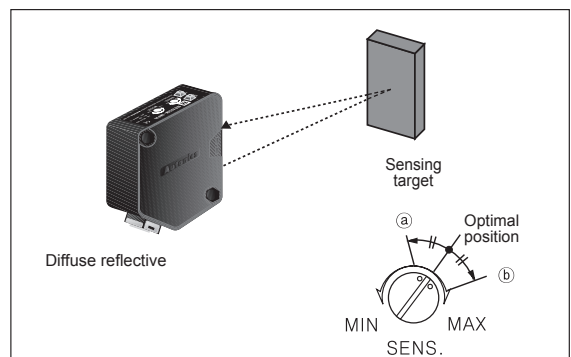

(A)	Photoelectric Sensors
(B)	Fiber Optic Sensors
(C)	Door/Area Sensors
(D)	Proximity Sensors
(E)	Pressure Sensors
(F)	Rotary Encoders
(G)	Connectors/ Connector Cables/ Sensor Distribution Boxes/ Sockets
(H)	Temperature Controllers
(I)	SSRs / Power Controllers
(J)	Counters
(K)	Timers
(L)	Panel Meters
(M)	Tacho / Speed / Pulse Meters
(N)	Display Units
(O)	Sensor Controllers
(P)	Switching Mode Power Supplies
(Q)	Stepper Motors & Drivers & Controllers
(R)	Graphic/ Logic Panels
(S)	Field Network Devices
(T)	Software

BEN Series

◎ Retroreflective type

1. Supply the power to the photoelectric sensor, after setting the photoelectric sensor and the reflector or reflective tape face to face.
2. Set the photoelectric sensor in the position which indicator turns on, by adjusting the reflector or the sensor right and left, up and down.
3. Fix both units tightly after checking that the unit detects the target.

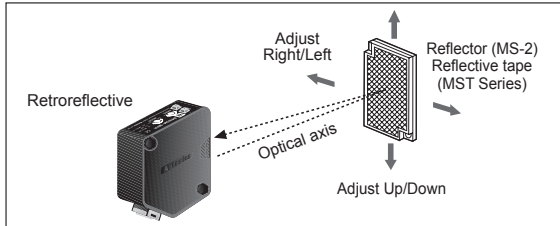

- ※If using more than 2 photoelectric sensors in parallel, the space among them should be more than 30cm.
- ※If reflectance of target is higher than non-glossy white paper, it might cause malfunction by reflection from the target when the target is near to photoelectric sensor. Therefore put enough space between the target and the photoelectric sensor or the surface of the target should be installed at angle of 30° to 45° against optical axis. (When a sensing target with high reflectance near by, photoelectric sensing with the polarizing filter should be used.)
- ※Sensitivity adjustment: Refer to the diffuse reflective type's.

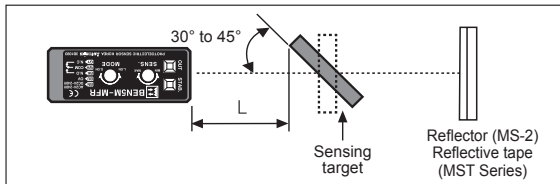

- ※If the mounting place is too narrow, please use MS-4 instead of MS-2.
- ※Please use reflective tape (MST series) for where a reflector is not installed.

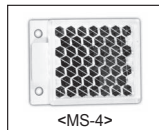

◎ Retroreflective type with polarizing filter

The light passed through the polarizing filter of the emitter reaches to the MS-2 reflector or reflective tape converting as horizontal direction. It reaches to the receiver element of polarizing filter converting as vertical by the MS-2 reflector or reflective tape. Therefore, this type can also detect reflective mirror.

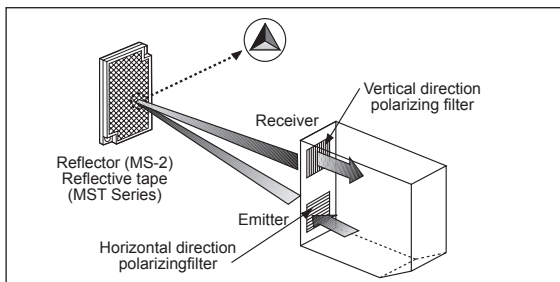

- ※Please use reflective tape (MST Series) for where a reflector is not installed.

■ Reflectivity by Reflective Tape Model

	Standard	Built-in polarizing filter
MST-50-10 (50×50mm)	90%	70%
MST-100-5 (100×100mm)	130%	90%
MST-200-2 (200×200mm)	140%	120%

- ※This reflectivity is based on the reflector (MS-2).
- ※Reflectivity may vary depending on usage environment and installation conditions. The sensing distance and minimum sensing target size increase as the size of the tape increases. Please check the reflectivity before using reflective tapes.
- ※For using reflective tape, installation distance should be min. 20mm.

X-ON Electronics

Largest Supplier of Electrical and Electronic Components

Click to view similar products for [Photoelectric Sensors](#) category:

Click to view products by [Autonics](#) manufacturer:

Other Similar products are found below :

[7442AD2X5FRX](#) [EX-19B-LP](#) [EX-19SB-PN](#) [7443AR0X5FRX](#) [7452AD4D4NNX](#) [7694ADE04DS2X](#) [FE7C-FRC6S-M](#) [FX-305](#) [PM-R24-R](#)
[Q45VR2FPQ](#) [13104RQD07](#) [E3JUXM4MN](#) [E3L2DC4](#) [E3S3LE21](#) [E3SCT11M1J03M](#) [E3SDS20E21](#) [E3VDS70C43S](#) [E3XNM16](#) [BR23P](#)
[HOA6563-001](#) [OJ-3307-30N8](#) [OS-311A-30](#) [P32013](#) [P34036](#) [P43004](#) [P60001](#) [PB10CNT15PO](#) [S14132](#) [935286-000](#) [S52101](#) [S56258](#) [FD-](#)
[SN500](#) [FE7B-FDRB6-M](#) [SU-79](#) [T36342](#) [T40300](#) [T60001](#) [PD60CNX20BP](#) [FX-302-HY](#) [FZS](#) [PM-T64W](#) [PZ2-51P](#) [CX-491-P-J](#) [CYNUTX10](#)
[UZB802](#) [UZB803](#) [UZFRG1](#) [UZFRG4](#) [UZFRT4](#) [UZFTT8](#)