

Through-beam Type Fiber Optic Units







FT/GT Series















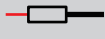



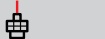

For your safety, read and follow the considerations written in the instruction manual, other manuals and Autonics website.

The specifications, dimensions, etc. are subject to change without notice for product improvement. Some models may be discontinued without notice.

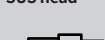
Icon Overview

-  **Std.** Standard:
Fiber optic units for general purpose
-  **Heat-resistant:**
Fiber optic units for the high-temperature environment (-60 to 350°C)
-  **Vacuum-resistant:**
Fiber optic units for the high-temperature (-60 to 250°C) and vacuum environment
-  **Bending-resistant (R5):**
Fiber optic units for withstanding repeated bending
-  **Flexible (R1, R2):**
Fiber optic units for withstanding repeated flexing

Line Up

| | Standard | Heat-resistant | Vacuum-resistant | Bending-resistant | Flexible |
|---|----------|---|---|--|--|
| Threaded head  | Std. |  |  |  |  |
| Cylindrical head  | Std. | | |  |  |
| Flat head  | | | | |  |
| L-shaped head  | Std. |  |  | | |
| Molded plastic head  | Std. | | | | |
| Perpendicular head  | |  | | |  |
| SUS head  | Std. | | | | |
| U-shaped head  | |  | | | |
| Wide area head  | | | |  |  |

Selection Guide

- The model starts with F is plastic, G is glass optical fibers. Glass fibers are for BF5 and BF4 series.
- Be sure to use the vacuum-resistant fiber mounting with the fiber optic coupler and the atmospheric side fiber (sold separately).
- The testing environments for sensing distance vary depending on the amplifiers.

| Amplifier | Testing environment |
|------------|---|
| BF5 | Red LED, Standard (STD) mode, Non-glossy white paper |
| BF4 | Red LED, Maximum sensitivity, Non-glossy white paper Green LED has 10% of sensing distance compare to the Red LED. In case of BF3, apply 40% of sensing distance. |

- The minimum detectable target came out with the maximum sensitivity of the BF4 series.
- For the detailed drawings and dimensions, follow the Autonics website.
- Be sure to use offered fiber cutter (FC-3) for FREE CUT models.
- Be sure to connect offered fiber optic adaptor for Adaptor models.
- The installation of the fiber optic unit may vary depending on the fiber optic amplifier. See the manual of the amplifier that you are using.

Through-beam Type: Threaded head

■ Standard

| Model | Bend radius | Ambient temperature | Sensing distance (Testing amplifier) | Min. target size | Dimensions (unit: mm) | FREE CUT/ Adaptor |
|-----------|-------------|---------------------|--------------------------------------|------------------|-----------------------|-------------------|
| FT-310-05 | R15 | -40 to 70 °C | 150 mm (BF4) | Ø 0.5 mm | | FREE CUT/ Adaptor |
| FT-320-05 | R15 | -40 to 70 °C | 150 mm (BF4) | Ø 0.5 mm | | FREE CUT/ Adaptor |
| FT-420-10 | R30 | -40 to 70 °C | 500 mm (BF4) | Ø 1 mm | | FREE CUT |

■ Heat-resistant

| Model | Bend radius | Ambient temperature | Sensing distance (Testing amplifier) | Min. target size | Dimensions (unit: mm) | FREE CUT/ Adaptor |
|-------------|-------------|---------------------|--------------------------------------|------------------|-----------------------|-------------------|
| FT-420-10H | R30 | -40 to 105 °C | 300 mm (BF4) | Ø 1 mm | | FREE CUT |
| FT-420-15H1 | R50 | -40 to 150 °C | 500 mm (BF4) | Ø 1 mm | | FREE CUT |
| GT-420-13H2 | R25 | -40 to 250 °C | 400 mm (BF4) | Ø 1 mm | | — |

■ Vacuum-resistant

| Model | Bend radius | Ambient temperature | Sensing distance (Testing amplifier) | Min. target size | Dimensions (unit: mm) | FREE CUT/ Adaptor |
|-------------|-------------|---------------------|--|-----------------------|-----------------------|-------------------|
| GT-410-12V2 | R25 | -60 to 250 °C | 420 mm ⁰¹⁾ (BF5) 340 mm ⁰²⁾ (BF5) | Ø 0.15 mm Ø 0.2 mm | | — |

01) Equipped with the atmospheric-side fiber optic unit (FU-VA01)

02) Equipped with the atmospheric-side fiber optic unit (FU-VA02)

Through-beam Type: Threaded head

■ Bending-resistant

| Model | Bend radius | Ambient temperature | Sensing distance (Testing amplifier) | Min. target size | Dimensions (unit: mm) | FREE CUT / Adaptor |
|------------|-------------|---------------------|--------------------------------------|------------------|-----------------------|--------------------|
| FT-320-06B | R5 | -40 to 60 °C | 110 mm (BF5) | Ø 0.3 mm | | FREE CUT |
| FT-420-13B | R5 | -40 to 60 °C | 400 mm (BF5) | Ø 0.6 mm | | FREE CUT |

■ Flexible

| Model | Bend radius | Ambient temperature | Sensing distance (Testing amplifier) | Min. target size | Dimensions (unit: mm) | FREE CUT / Adaptor |
|------------|-------------|---------------------|--------------------------------------|------------------|-----------------------|--------------------|
| FT-320-05R | R1 | -40 to 60 °C | 110 mm (BF5) | Ø 0.3 mm | | FREE CUT / Adaptor |
| FT-420-10R | R1 | -40 to 60 °C | 500 mm (BF5) | Ø 0.5 mm | | FREE CUT |

Through-beam Type: Cylindrical head

■ Standard

| Model | Bend radius | Ambient temperature | Sensing distance (Testing amplifier) | Min. target size | Dimensions (unit: mm) | FREE CUT / Adaptor |
|-------------|-------------|---------------------|--------------------------------------|------------------|-----------------------|--------------------|
| FTC-1520-05 | R15 | -40 to 70 °C | 150 mm (BF4) | Ø 0.5 mm | | FREE CUT/ Adaptor |
| FTC-220-05 | R15 | -40 to 70 °C | 150 mm (BF4) | Ø 0.5 mm | | FREE CUT/ Adaptor |
| FTC-320-10 | R30 | -40 to 70 °C | 150 mm (BF4) | Ø 1 mm | | FREE CUT |

■ Bending-resistant

| Model | Bend radius | Ambient temperature | Sensing distance (Testing amplifier) | Min. target size | Dimensions (unit: mm) | FREE CUT / Adaptor |
|--------------|-------------|---------------------|--------------------------------------|------------------|-----------------------|--------------------|
| FTC-1520-06B | R5 | -40 to 60 °C | 110 mm (BF4) | Ø 0.3 mm | | FREE CUT |

■ Flexible

| Model | Bend radius | Ambient temperature | Sensing distance (Testing amplifier) | Min. target size | Dimensions (unit: mm) | FREE CUT / Adaptor |
|-------------|-------------|---------------------|--------------------------------------|------------------|-----------------------|--------------------|
| FTC-220-05R | R1 | -40 to 60 °C | 110 mm (BF5) | Ø 0.3 mm | | FREE CUT/ Adaptor |

Through-beam Type: Flat head

■ Flexible

| Model | Bend radius | Ambient temperature | Sensing distance (Testing amplifier) | Min. target size | Dimensions (unit: mm) | FREE CUT / Adaptor |
|---------------|-------------|---------------------|--------------------------------------|------------------|--|--------------------|
| FTF-210-05R | R1 | -40 to 60 °C | 100 mm (BF5) | Ø 0.04 mm | <p>• Hood material: SUS303, flat view</p> | FREE CUT / Adaptor |
| FTFB-210-05R | R1 | -40 to 60 °C | 110 mm (BF5) | Ø 0.04 mm | <p>• Hood material: AL, side view + top view (Bending)</p> | FREE CUT / Adaptor |
| FTFN-210-05R | R1 | -40 to 60 °C | 110 mm (BF5) | Ø 0.04 mm | <p>• Hood material: SUS303, side view</p> | FREE CUT / Adaptor |
| FTFU-210-05R | R1 | -40 to 60 °C | 110 mm (BF5) | Ø 0.04 mm | <p>• Hood material: SUS303, top view</p> | FREE CUT / Adaptor |
| FTLU-310-10R | R1 | -40 to 60 °C | 500 mm (BF5) | Ø 0.06 mm | <p>• Hood material: AL, top view</p> | FREE CUT |
| FTLU1-310-10R | R1 | -40 to 60 °C | 500 mm (BF5) | Ø 0.06 mm | <p>• Hood material: AL, top view</p> | FREE CUT |
| FTLU2-310-10R | R1 | -40 to 60 °C | 500 mm (BF5) | Ø 0.06 mm | <p>• Hood material: AL, top view</p> | FREE CUT |

Through-beam Type: L-shaped head

■ Standard

| Model | Bend radius | Ambient temperature | Sensing distance (Testing amplifier) | Min. target size | Dimensions (unit: mm) | FREE CUT / Adaptor |
|------------|-------------|---------------------|--------------------------------------|------------------|-----------------------|--------------------|
| FTL-420-10 | R20 | -30 to 70 °C | 710 mm (BF5) | Ø 0.1 mm | | FREE CUT |

■ Heat-resistant

| Model | Bend radius | Ambient temperature | Sensing distance (Testing amplifier) | Min. target size | Dimensions (unit: mm) | FREE CUT / Adaptor |
|--------------|-------------|---------------------|--------------------------------------|------------------|-----------------------|--------------------|
| GTL-420-12H2 | R25 | -60 to 250 °C | 670 mm (BF5) | Ø 0.08 mm | | — |
| GTL-420-12H3 | R25 | -60 to 350 °C | 680 mm (BF5) | Ø 0.08 mm | | — |

■ Vacuum-resistant

| Model | Bend radius | Ambient temperature | Sensing distance (Testing amplifier) | Min. target size | Dimensions (unit: mm) | FREE CUT / Adaptor |
|--------------|-------------|---------------------|--|------------------|-----------------------|--------------------|
| GTL-410-12V2 | R25 | -60 to 250 °C | 420 mm ⁰¹⁾ (BF5) 340 mm ⁰²⁾ (BF5) | Ø 0.1 mm | | — |

01) Equipped with the atmospheric-side fiber optic unit (FU-VA01)

02) Equipped with the atmospheric-side fiber optic unit (FU-VA02)

Through-beam Type: Molded plastic head

■ Standard

| Model | Bend radius | Ambient temperature | Sensing distance (Testing amplifier) | Min. target size | Dimensions (unit: mm) | FREE CUT / Adaptor |
|------------|-------------|---------------------|--------------------------------------|------------------|-----------------------|--------------------|
| FTP-320-10 | R30 | -40 to 70 °C | 500 mm (BF4) | Ø 1 mm | | FREE CUT |

Through-beam Type: Perpendicular head

■ Heat-resistant

| Model | Bend radius | Ambient temperature | Sensing distance (Testing amplifier) | Min. target size | Dimensions (unit: mm) | FREE CUT / Adaptor |
|--------------|-------------|---------------------|--------------------------------------|------------------|-----------------------|--------------------|
| GTR-420-12H2 | R25 | -60 to 250 °C | 650 mm (BF5) | Ø 0.08 mm | | — |
| GTR-420-12H3 | R25 | -60 to 350 °C | 630 mm (BF5) | Ø 0.08 mm | | — |

■ Flexible

| Model | Bend radius | Ambient temperature | Sensing distance (Testing amplifier) | Min. target size | Dimensions (unit: mm) | FREE CUT / Adaptor |
|-------------|-------------|---------------------|--------------------------------------|------------------|--------------------------------|--------------------|
| FTR-410-10R | R1 | -40 to 60 °C | 460 mm (BF5) | Ø 0.5 mm | <p>• Hood material: SUS303</p> | FREE CUT |

Through-beam Type: SUS head

■ Standard

| Model | Bend radius | Ambient temperature | Sensing distance (Testing amplifier) | Min. target size | Dimensions (unit: mm) | FREE CUT / Adaptor |
|---------------|--------------------|---------------------|--------------------------------------|------------------|-----------------------|--------------------|
| FTS-320-05 | R15 (SUS part R10) | -40 to 70 °C | 150 mm (BF4) | Ø 0.5 mm | | FREE CUT / Adaptor |
| FTS1-320-05 | R15 (SUS part R10) | -40 to 70 °C | 150 mm (BF4) | Ø 0.5 mm | | FREE CUT / Adaptor |
| FTS2-320-05 | R15 (SUS part R10) | -40 to 70 °C | 150 mm (BF4) | Ø 0.5 mm | | FREE CUT / Adaptor |
| FTS-420-10 | R30 (SUS part R10) | -40 to 70 °C | 500 mm (BF4) | Ø 1 mm | | FREE CUT |
| FTS2-420-10 | R30 (SUS part R10) | -40 to 70 °C | 500 mm (BF4) | Ø 1 mm | | FREE CUT |
| FTCS-220-05 | R15 (SUS part R10) | -40 to 70 °C | 150 mm (BF4) | Ø 0.5 mm | | FREE CUT / Adaptor |
| FTCSN-2520-05 | R15 | -40 to 60 °C | 120 mm (BF5) | Ø 0.0125 mm | • Side view | — |

Through-beam Type: U-shaped head

■ Heat-resistant

| Model | Bend radius | Ambient temperature | Sensing distance (Testing amplifier) | Min. target size | Dimensions (unit: mm) | FREE CUT / Adaptor |
|-------------|-------------|---------------------|--------------------------------------|------------------|-----------------------|--------------------|
| GTU3-320-H2 | R25 | -60 to 250 °C | 20 mm (BF5) | Ø 2.5 mm | | — |

Sold Separately

■ Lens unit for long distance detection

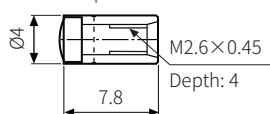
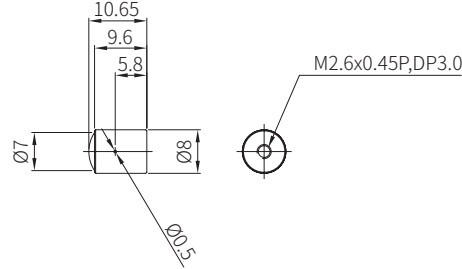
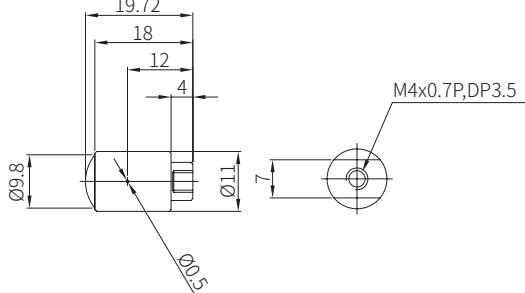
| Model | Ambient temperature | Magnification ⁰¹⁾ | Dimensions (unit: mm) |
|-----------|---------------------|------------------------------|--|
| FTL-M26 | -40 to 100 °C | ×5 | <p>• Mount the lens unit on the 3 mm of sensor tip at the front hood.</p>  |
| FTL-M26V3 | -60 to 350 °C | ×10 |  |
| FTL-M4V3 | -60 to 350 °C | ×15 |  |

01) The sensing distance may vary depending on the detection environment.

■ Fiber optic coupler (vacuum fiber optics component)

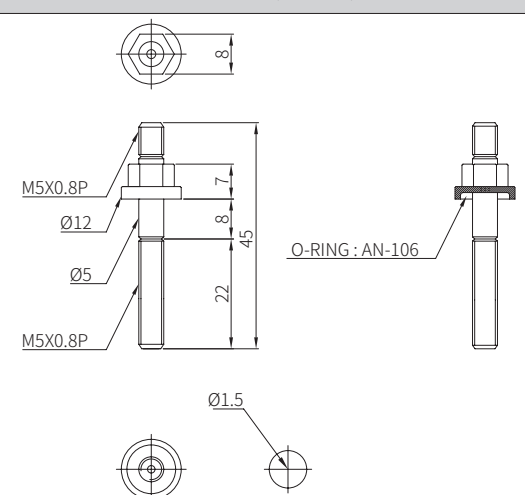
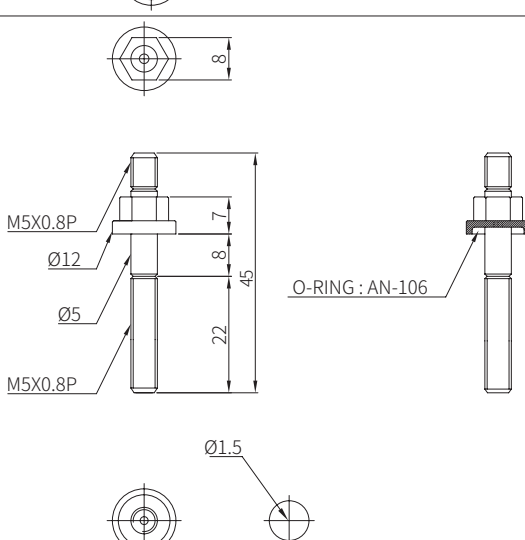
| Model | Ambient temperature | Dimensions (unit: mm) |
|---------|---------------------|---|
| FU-VC01 | -60 to 200 °C |  |
| FU-VC02 | -60 to 300 °C |  |

Sold Separately

■ Atmospheric-side fiber optic units

| Model | Bend radius | Ambient temperature | Dimensions (unit: mm) | FREE CUT |
|---------|-------------|---------------------|-----------------------|----------|
| FU-VA01 | R30 | -30 to 70 °C | | FREE CUT |
| FU-VA02 | R20 | -30 to 70 °C | | FREE CUT |

■ Protection tube for cable

| Model | Dimensions (unit: mm) |
|---------|-----------------------|
| FTH-305 | |
| FTH-310 | |
| FTH-405 | |
| FTH-410 | |
| FDH-605 | |
| FDH-610 | |

X-ON Electronics

Largest Supplier of Electrical and Electronic Components

Click to view similar products for [Fibre Optic Sensors](#) category:

Click to view products by [Autonics](#) manufacturer:

Other Similar products are found below :

[F04MA03123](#) [E32L56E1](#) [E32L56E2](#) [CCS-NFCB2-3](#) [SST553-02-DA](#) [CN-14A-R-C2](#) [CN-73-C1](#) [AU-F03-PNP-NO](#) [LL3-TB01](#) [FD-42G](#)
[E32-D11L 2M](#) [E32-T11L 2M](#) [1830L3500MSC](#) [FS-04D-100](#) [FS-15T-100](#) [FX-101-CC2](#) [FX-101P](#) [FX-101P-CC2](#) [FX-101P-Z](#) [FX-102-CC2](#)
[FD-31](#) [FD-62](#) [E3X-NA41 2M](#) [FT-F93](#) [FX-102P-CC2](#) [FX-502P](#) [FX-505P-C2](#) [CN-73-C2](#) [CN-24A-C5](#) [CN-24A-C2](#) [CN-14A-R-C5](#) [CN-14A-](#)
[R-C1](#) [FT-42](#) [FT-A11](#) [CS1W-PTS03](#) [E32-T16P](#) [E3NX-FA11 2M](#) [E32-TC50](#) [E32-DC200B](#) [SAIL-M8BW-4-10U](#) [YG8U14-050VA3XLEAX](#)
[YF2A15-100UB5XLEAX](#) [E32-T14L 2M](#) [LL3-DT01](#) [FD-S21](#) [FT-R43](#) [FX301](#) [FX311](#) [FX311P](#) [FXLE1](#)