

MX4W Series

DIN W96×H48mm 12-segment, LCD Display Multi Panel Meter

■ Features

- Improved visibility with LCD display
- Isolated input and power modules allows powering of multiple units using a single power supply
- Mounting space saving with compact design
 - : downsized back length by 78%, compared to another model in same DIN size (length of pannel back: 20mm)
- Various input options (by model)
 - Input options: DC voltage, DC current, AC voltage, AC current
- Max. measuring inputs: 500VDC, 500VAC, DC5A, AC5A
- Display range: -9999 to 9999
- High/Low scale function
- AC frequency measurement (measuring range: 0.100 to 1200Hz)
- Preset output: OUT1, OUT2 (NPN/PNP open collector output)
- Power factor display and output
 - : displays input of 1-5V, 4-20mA, etc as -0.50 to 1.00 to 0.50
- Various functions
 - : monitoring function for max. and min. display value, display cycle delay function, zero-point adjustment function, high display correction function, etc
- Power supply: 24-240VAC 50/60Hz, 24-240VDC universal

NEW



⚠ Please read "Safety considerations" in operation manual before using.



■ Ordering Information

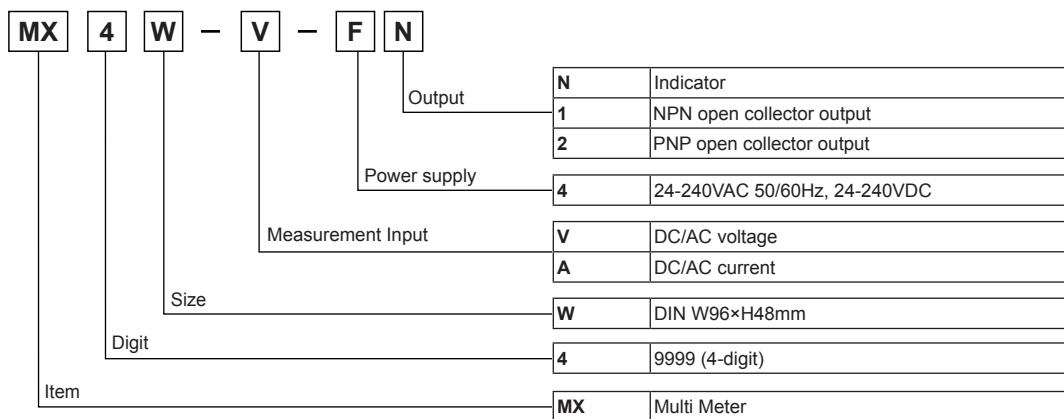

■ Unit Description

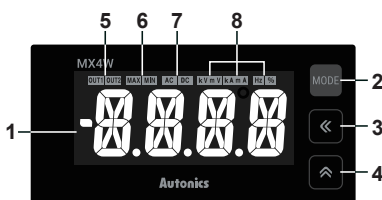

1. Measurement value display part

2. **MODE** key

: Press the key to enter parameter groups, return RUN mode, move parameters, or save the setting values.

3. **←** key

: Press the key to move digits, enter parameters, or move parameter setting values.

4. **→** key

: Press the key to change digit value, enter or change parameters, or change the parameter setting value.

5. Control output (OUT1/OUT2) indicator (red, indicator model: white)

: When input is over/below the range, **HHHH** or **LLLL** appears.

6. MAX/MIN indicator (green, indicator model: white)

: When input is over/below the range, **HHHH** or **LLLL** appears.

7. AC/DC indicator (green, indicator model: white)

8. Unit (V/mV/A/mA/Hz/%) indicator (yellow, indicator model: white)

LCD Display Multi Panel Meter

Specifications

Model	MX4W-V-F □	MX4W-A-F □
Measurement input	DC/AC voltage	DC/AC current
Max. allowable input	• DC input: approx. -110 to 110% of each measurement input range (when not using minus input: -10 to 110%) • AC input: approx. 110% of each measurement input range	
Power supply	24-240VAC~ 50/60Hz, 24-240VDC=	
Allowable voltage range	90 to 110% of the rated voltage	
Power supply	Max. 5VA (24-240VAC~ 50/60Hz), max. 3W (24-240VDC=)	
Display method※1	12-segment (measurement value display part: white, character height: 19mm), other display parts (red, green, yellow, indicator model: white) LCD method	
Display accuracy	23°C±5°C - DC input: ±0.1% F.S. ±2-digit, AC input: ±0.3% F.S. ±3-digit ※The terminal for 5A of current input, ±0.3% F.S. ±3-digit 0°C to 50°C - DC/AC input: ±0.5% F.S. ±3-digit ※The terminal for 5A of current input, ±1% F.S. ±3-digit	
Display cycle	0.2 to 5.0 sec (select per 0.1 sec)	
A/D conversion method	Sigma-Delta (Σ-Δ) analog-to-digital converter	
Sampling cycle	DC input: 50ms (resolution 1/20,000), AC input: 16.6ms (resolution 1/20,000)	
Max. display range	-9999 to 9999 (4-digit)	
Preset output※2	NPN/PNP open collector output • Load voltage: max. 30VDC= • Load current: max. 100mA • Residual voltage: max. 1VDC= (NPN), max. 2VDC (PNP)	
AC measurement※3	Select RMS value/AVG value measurement methods	
Frequency measurement※3	Measurement range: 0.100 to 1200Hz (varies depending on the decimal point)	
Insulation resistance	Over 100MΩ (at 500VDC megger)	
Dielectric strength	3,000VAC 50/60Hz for 1 min (between all terminals and case)	
Noise immunity	±2kV the square wave noise (pulse width: 1μs) by the noise simulator	
Vibration	Mechanical	0.75mm amplitude at frequency of 10 to 55Hz (for 1 min) in each X, Y, Z direction for 2 hours
	Malfunction	0.5mm amplitude at frequency of 10 to 55Hz (for 1 min) in each X, Y, Z direction for 10 min
Shock	Mechanical	100m/s ² (approx. 10G) in each X, Y, Z direction for 3 times
	Malfunction	300m/s ² (approx. 30G) in each X, Y, Z direction for 3 times
Environment	Ambient temp.	-10 to 50°C, storage: -20 to 60°C
	Ambient humi.	35 to 85%RH, storage: 35 to 85%RH
Insulation type	Double insulation or reinforced insulation (mark: □, dielectric strength between the measurement input part and the power part: 1kV)	
Approval	CE, 	
Weight※4	Approx. 100g (approx. 77g)	

※1: When using the unit at low temperature (below 0°C), display cycle is slow due to characteristics of LCD. Control output operates normally.

※2: Indicator model (MX4W-□-FN) does not have the function.

※3: AC, frequency measurement are available when input type is AC.

※4: The weight includes packaging. The weight in parenthesis is for unit only.

※Environment resistance is rated at no freezing or condensation.

Connections and Insulated Block Diagram

MX4W-V-F□

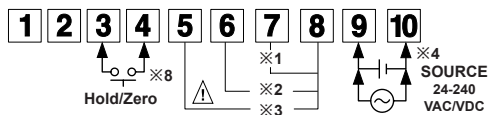

※1: DC±500mV/±200mV/±50mV, AC0-500mV/0-200mV/0-50mV

※2: DC±20V/±5V/1-5V/±2V, AC0-20V/0-5V/0-2V

※3: DC±500V/±200V/±50V, AC0-500V/0-200V/0-110V/0-50V

※4: For using DC power, connect wires regardless of polarity.

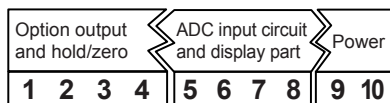

※Input and output are insulated from the power.

MX4W-A-F□

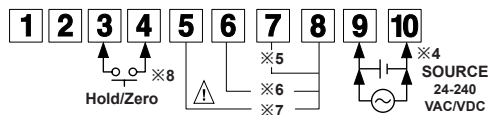

※5: DC±20mA/4-20mA/±5mA/±2mA, AC0-20mA/0-5mA/0-2mA

※6: DC±500mA/±200mA/±50mA, AC0-500mA/0-200mA/0-50mA

※7: DC±5A/±2A, AC0-5A/0-2A

※8: Indicator model does not have the hold/zero terminal.

NPN open collector output PNP open collector output

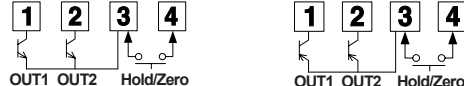

※Use terminals of size specified below.

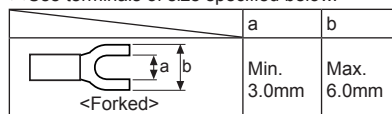

(A) Photoelectric Sensors

(B) Fiber Optic Sensors

(C) Door/Area Sensors

(D) Proximity Sensors

(E) Pressure Sensors

(F) Rotary Encoders

(G) Connectors/ Sockets

(H) Temperature Controllers

(I) SSRs / Power Controllers

(J) Counters

(K) Timers

(L) Panel Meters

(M) Tacho / Speed / Pulse Meters

(N) Display Units

(O) Sensor Controllers

(P) Switching Mode Power Supplies

(Q) Stepper Motors & Drivers & Controllers

(R) Graphic/ Logic Panels

(S) Field Network Devices

(T) Software

MX4W Series

■ Dimensions

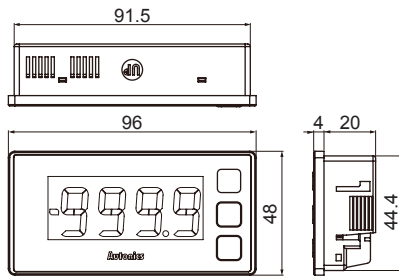

● Panel cut-out

(unit: mm)

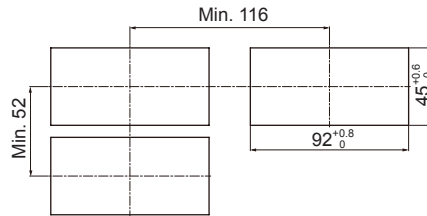

● Terminal cover

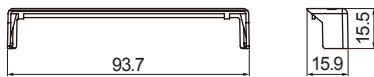

● Bracket

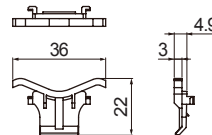

■ Parameter Group

◎ Parameter (0 to 2 group) setting

- Each parameter and corresponding setting value will flash alternately every 0.5 sec.
 - Press the **[MODE]** key to save the setting value and move to the next parameter.
 - If there is no key input for 60 sec, the unit will return to RUN mode.
 - Hold the **[MODE]** key for 3 sec to return to RUN mode.
 - Press the **[←]**, **[→]** keys to change the set value. (**[←]**): moves digits, (**[→]**): changes setting value)
- ※ : Dotted parameters may not appear by model type or other parameter settings.
 ※1: Refer to '■ Measurement Input.'

◎ Parameter 0 group

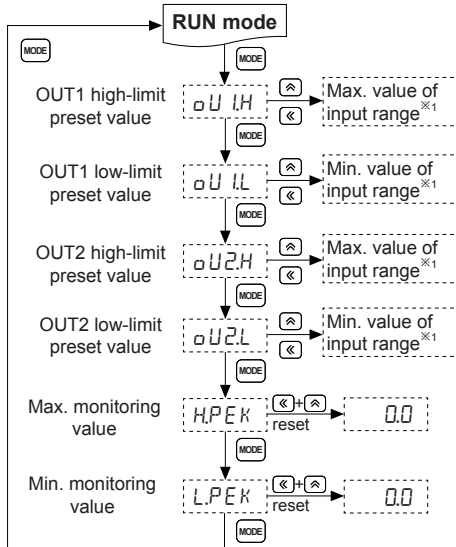

Does not appear when OUT1 preset output operation mode [OU1L] of parameter 2 group is set as OFFLOW.
 Setting range: -9999 to 9999

Does not appear when OUT1 preset output operation mode [OU1L] of parameter 2 group is set as OFFHIGH.
 Setting range: -9999 to 9999

Does not appear when OUT2 preset output operation mode [OU2L] of parameter 2 group is set as OFFLOW.
 Setting range: -9999 to 9999

Does not appear when OUT2 preset output operation mode [OU2L] of parameter 2 group is set as OFFHIGH.
 Setting range: -9999 to 9999

Do not appear when monitoring delay time [PERK] of parameter 2 group is set as 00 sec [005]. Hold the **[←]+[→]** for over 1 sec, to reset the parameter.

◎ Factory defaults

Parameter	MX4W-V (DC)	MX4W-V (±DC)	MX4W-V (AC)	MX4W-A (DC)	MX4W-A (±DC)	MX4W-A (AC)
OU1H ^{※1}	5000	5000	5000	5000	5000	5000
OU1L ^{※1}	0000	-5000	0000	0000	-5000	0000
OU2H ^{※1}	5000	5000	5000	5000	5000	5000
OU2L ^{※1}	0000	-5000	0000	0000	-5000	0000
HPEK	00	00	00	00	00	00
LPEK	00	00	00	00	00	00

※1: Does not appear in indicator models.

LCD Display Multi Panel Meter

Parameter 1 group

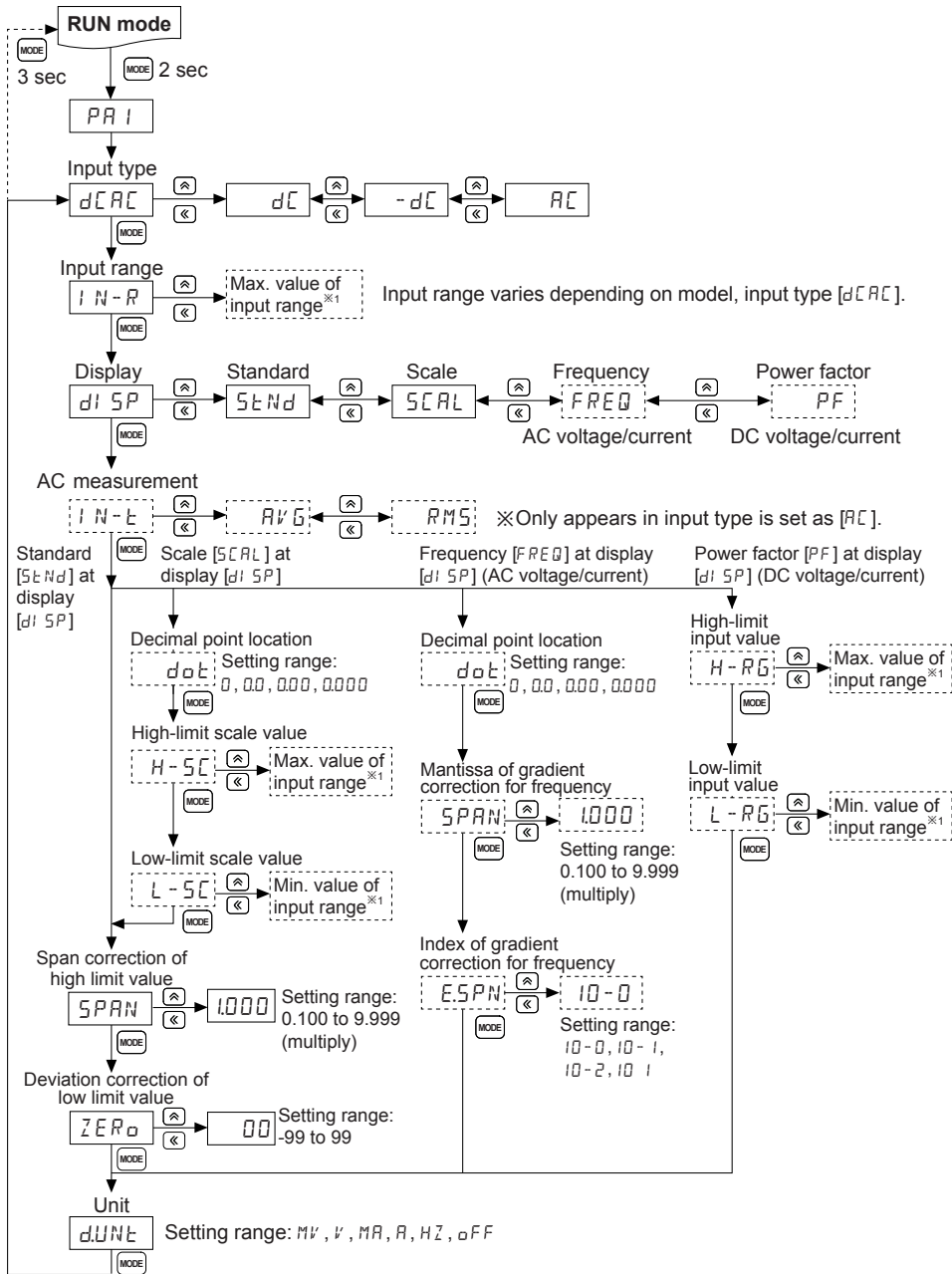

Factory defaults

Parameter	MX4W-V (DC)	MX4W-V (±DC)	MX4W-V (AC)	MX4W-A (DC)	MX4W-A (±DC)	MX4W-A (AC)
dC AC	dC	-dC	AC	dC	-dC	AC
IN-R	5000	-5000	5000	5000	-5000	5000
dISP	StNd	StNd	StNd	StNd	StNd	StNd
IN-t	—	—	—	—	—	—
dot	0000	0000	0000	0000	0000	0000
H-SC	5000	5000	5000	5000	5000	5000
L-SC	0000	-5000	0000	0000	0000	0000
SPAN	1000	1000	1000	1000	1000	1000
ZERO	00	00	00	00	00	00
ESPN	—	—	10-0	—	—	10-0
H-RG	5000	5000	—	5000	5000	—
L-RG	0000	-5000	—	0000	-5000	—
dUNt	V	V	V	A	A	A

- (A) Photoelectric Sensors
- (B) Fiber Optic Sensors
- (C) Door/Area Sensors
- (D) Proximity Sensors
- (E) Pressure Sensors
- (F) Rotary Encoders
- (G) Connectors/ Sockets
- (H) Temperature Controllers
- (I) SSRs / Power Controllers
- (J) Counters
- (K) Timers
- (L) Panel Meters
- (M) Tacho / Speed / Pulse Meters
- (N) Display Units
- (O) Sensor Controllers
- (P) Switching Mode Power Supplies
- (Q) Stepper Motors & Drivers & Controllers
- (R) Graphic/ Logic Panels
- (S) Field Network Devices
- (T) Software

MX4W Series

◎ Parameter 2 group

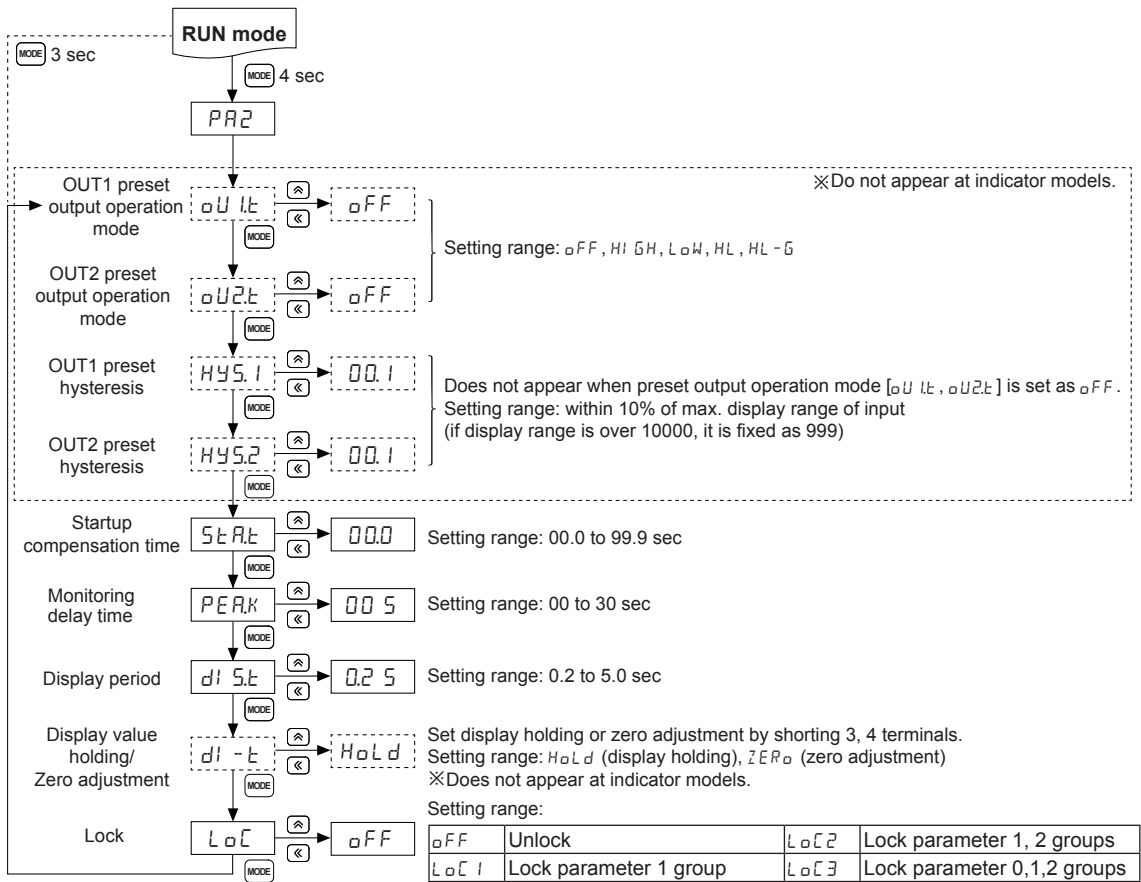

◎ Factory defaults

Parameter	MX4W-V (DC)	MX4W-V (±DC)	MX4W-V (AC)	MX4W-A (DC)	MX4W-A (±DC)	MX4W-A (AC)
<code>oU1t</code> ※1	<code>oFF</code>	<code>oFF</code>	<code>oFF</code>	<code>oFF</code>	<code>oFF</code>	<code>oFF</code>
<code>oU2t</code> ※1	<code>oFF</code>	<code>oFF</code>	<code>oFF</code>	<code>oFF</code>	<code>oFF</code>	<code>oFF</code>
<code>HYS1</code> ※1,2	<code>00.1</code>	<code>00.1</code>	<code>00.1</code>	<code>0001</code>	<code>0001</code>	<code>0001</code>
<code>HYS2</code> ※1,2	<code>00.1</code>	<code>00.1</code>	<code>00.1</code>	<code>0001</code>	<code>0001</code>	<code>0001</code>
<code>StARt</code>	<code>000</code>	<code>000</code>	<code>000</code>	<code>000</code>	<code>000</code>	<code>000</code>
<code>PEAK</code>	<code>005</code>	<code>005</code>	<code>005</code>	<code>005</code>	<code>005</code>	<code>005</code>
<code>diSt</code>	<code>0.25</code>	<code>0.25</code>	<code>0.25</code>	<code>0.25</code>	<code>0.25</code>	<code>0.25</code>
<code>di-t</code>	<code>HoLd</code>	<code>HoLd</code>	<code>HoLd</code>	<code>HoLd</code>	<code>HoLd</code>	<code>HoLd</code>
<code>LoC</code>	<code>oFF</code>	<code>oFF</code>	<code>oFF</code>	<code>oFF</code>	<code>oFF</code>	<code>oFF</code>

※1: Does not appear in indicator models.

※2: It will vary depending on input range [`N-R`] setting.

LCD Display Multi Panel Meter

■ Measurement Input

DC voltage				DC current			
Measurement input range	Display	Input impedance	Display range [5tNd]	Measurement input range	Display	Input impedance	Display range [5tNd]
0.0-500.0V	5000	4.062MΩ	0.0 to 500.0	0.000-5.000A	5000	0.02Ω	0.000 to 5.000
0-500V	500		0 to 500	0.00-5.00A	500		0.00 to 5.00
0.0-200.0V	2000		0.0 to 200.0	0.000-2.000A	2000		0.000 to 2.000
0-200V	200		0 to 200	0.00-2.00A	200		0.00 to 2.00
0.00-50.00V	5000		0.00 to 50.00	0.0-500.0mA	5000		0.0 to 500.0
0.0-50.0V	500	162kΩ	0.0 to 50.0	0-500mA	500	0.87Ω	0 to 500
0.00-20.00V	2000		0.00 to 20.00	0.0-200.0mA	2000		0.0 to 200.0
0.0-20.0V	200		0.0 to 20.0	0-200mA	200		0 to 200
0.000-5.000V	5000		0.000 to 5.000	0.00-50.00mA	5000		0.00 to 50.00
0.00-5.00V	500		0.00 to 5.00	0.0-50.0mA	500		0.0 to 50.0
1.000-5.000V	1-5a	4kΩ	1.000 to 5.000	0.00-20.00mA	2000	21.87Ω	0.00 to 20.00
1.00-5.00V	1-5b		1.00 to 5.00	0.0-20.0mA	200		0.0 to 20.0
0.000-2.000V	2000		0.000 to 2.000	4.00-20.00mA	4a20		4.00 to 20.00
0.00-2.00V	200		0.00 to 2.00	4.0-20.0mA	4b20		4.0 to 20.0
0.0-500.0mV	5000		0.0 to 500.0	0.000-5.000mA	5000		0.000 to 5.000
0-500mV	500	4.062MΩ	0 to 500	0.00-5.00mA	500	0.02Ω	0.00 to 5.00
0.0-200.0mV	2000		0.0 to 200.0	0.000-2.000mA	2000		0.000 to 2.000
0-200mV	200		0 to 200	0.00-2.00mA	200		0.00 to 2.00
0.00-50.00mV	5000		0.00 to 50.00	-5.000-5.000A	-5000		-5.000 to 5.000
0.0-50.0mV	500		0.0 to 50.0	-5.00-5.00A	-500		-5.00 to 5.00
-500.0-500.0V	-5000	162kΩ	-500.0 to 500.0	-2.000-2.000A	-2000	0.87Ω	-2.000 to 2.000
-500-500V	-500		-500 to 500	-2.00-2.00A	-200		-2.00 to 2.00
-200.0-200.0V	-2000		-200.0 to 200.0	-500.0-500.0mA	-5000		-500.0 to 500.0
-200-200V	-200		-200 to 200	-500-500mA	-500		-500 to 500
-50.00-50.00V	-5000		-50.00 to 50.00	-200.0-200.0mA	-2000		-200.0 to 200.0
-50.0-50.0V	-500	4kΩ	-50.0 to 50.0	-200-200mA	-200	21.87Ω	-200 to 200
-20.00-20.00V	-2000		-20.00 to 20.00	-50.00-50.00mA	-5000		-50.00 to 50.00
-20.0-20.0V	-200		-20.0 to 20.0	-50.0-50.0mA	-500		-50.0 to 50.0
-5.000-5.000V	-5000		-5.000 to 5.000	-20.00-20.00mA	-2000		-20.00 to 20.00
-5.00-5.00V	-500		-5.00 to 5.00	-20.0-20.0mA	-200		-20.0 to 20.0
-2.000-2.000V	-2000	4kΩ	-2.000 to 2.000	-5.000-5.000mA	-5000	0.02Ω	-5.000 to 5.000
-2.00-2.00V	-200		-2.00 to 2.00	-5.00-5.00mA	-500		-5.00 to 5.00
-500.0-500.0mV	-5000		-500.0 to 500.0	-2.000-2.000mA	-2000		-2.000 to 2.000
-500-500mV	-500		-500 to 500	-2.00-2.00mA	-200		-2.00 to 2.00
-200.0-200.0mV	-2000		-200.0 to 200.0				
-200-200mV	-200	-200 to 200					
-50.00-50.00mV	-5000	-50.00 to 50.00					
-50.0-50.0mV	-500	-50.0 to 50.0					

- ※Display range of [5tNd] will vary depending on the decimal point. (-9999 to 9999, -999.9 to 999.9, -99.99 to 99.99, -9.999 to 9.999)
- ※When changing measurement input type, 0.00□□/0.0□□□/MPK/LPEK/IdI SP/IN-t/da-t/H-SC/L-SC/SPAN/IZER/0.5PN/H-RG/L-RG/dUNt/I 0.0□□t/HY5□ parameters are reset.
- ※Frequency measurement range (AC voltage/current): 0.100 to 1200Hz
- ※Check the unit indicator when selecting measurement input type.
- ※Parameter setting order of input range [I N-R] is followed by the above table.
E.g.) AC current: 5000 → 500 → 2000 → ... → 2000 → 200
- ※When "HHHH" or "LLLL" is flashes with a certain measurement input, disconnect power supply and then check the cables.
- ※Connect to the input terminals whose 30% to 100% of the input range includes the max. value of the input range to measure.
When the max. input value is under the 30% of the input terminal range, display accuracy is degraded. When the max. input value is over the 100%, it may result in input terminal damage.

(A)	Photoelectric Sensors
(B)	Fiber Optic Sensors
(C)	Door/Area Sensors
(D)	Proximity Sensors
(E)	Pressure Sensors
(F)	Rotary Encoders
(G)	Connectors/ Sockets
(H)	Temperature Controllers
(I)	SSRs / Power Controllers
(J)	Counters
(K)	Timers
(L)	Panel Meters
(M)	Tacho / Speed / Pulse Meters
(N)	Display Units
(O)	Sensor Controllers
(P)	Switching Mode Power Supplies
(Q)	Stepper Motors & Drivers & Controllers
(R)	Graphic/ Logic Panels
(S)	Field Network Devices
(T)	Software

MX4W Series

Measurement Input

AC voltage				AC current			
Measurement input range	Display	Input impedance	Display range [SetNd]	Measurement input range	Display	Input impedance	Display range [SetNd]
0.0-500.0V	500.0	4.062MΩ	0.0 to 500.0	0.000-5.000A	5.000	0.02Ω	0.000 to 5.000
0-500V	500		0 to 500	0.00-5.00A	5.00		0.00 to 5.00
0.0-200.0V	200.0		0.0 to 200.0	0.000-2.000A	2.000		0.000 to 2.000
0-200V	200		0 to 200	0.00-2.00A	2.00		0.00 to 2.00
0.0-110.0V	110.0		0.0 to 110.0	0.0-500.0mA	500.0		0.0 to 500.0
0-110V	110		0 to 110	0-500mA	500		0 to 500
0.00-50.00V	50.00	162kΩ	0.00 to 50.00	0.0-200.0mA	200.0	0.87Ω	0.0 to 200.0
0.0-50.0V	50.0		0.0 to 50.0	0-200mA	200		0 to 200
0.00-20.00V	20.00		0.00 to 20.00	0.00-50.00mA	50.00		0.00 to 50.00
0.0-20.0V	20.0		0.0 to 20.0	0.0-50.0mA	50.0		0.0 to 50.0
0.000-5.000V	5.000		0.000 to 5.000	0.00-20.00mA	20.00		0.00 to 20.00
0.00-5.00V	5.00		0.00 to 5.00	0.0-20.0mA	20.0		0.0 to 20.0
0.000-2.000V	2.000	4kΩ	0.000 to 2.000	0.000-5.000mA	5.000	21.87Ω	0.000 to 5.000
0.00-2.00V	2.00		0.00 to 2.00	0.00-5.00mA	5.00		0.00 to 5.00
0.0-500.0mV	500.0		0.0 to 500.0	0.000-2.000mA	2.000		0.000 to 2.000
0-500mV	500		0 to 500	0.00-2.00mA	2.00		0.00 to 2.00
0.0-200.0mV	200.0		0.0 to 200.0				
0-200mV	200		0 to 200				
0.00-50.00mV	50.00		0.00 to 50.00				
0.0-50.0mV	50.0		0.0 to 50.0				

- ※Display range of [SCRL] will vary depending on the decimal point. (-9999 to 9999, -999.9 to 999.9, -99.99 to 99.99, -9.999 to 9.999)
- ※When changing measurement input type, \square U□H/□U□LHPK/LPEK/dI SPH N-tIdot/H-SC/L-SC/SPAN/ZERO/ESP/NH-RG/L-RG/dUNT/□U□t/HY□ parameters are reset.
- ※Frequency measurement range (AC voltage/current): 0.100 to 1200Hz
- ※Check the unit indicator when selecting measurement input type.
- ※Parameter setting order of input range [I N-R] is followed by the above table.
E.g.) AC current: 5.000 → 5.00 → 2.000 → ... → 2.000 → 2.00
- ※When "HHHH" or "LLLL" is flashes with a certain measurement input, disconnect power supply and then check the cables.
- ※Connect to the input terminals whose 30% to 100% of the input range includes the max. value of the input range to measure.
When the max. input value is under the 30% of the input terminal range, display accuracy is degraded. When the max. input value is over the 100%, it may result in input terminal damage.

Functions

AC frequency measurement

[PA 1 group: dI SP]

It measures input signal frequency when it is AC input. It uses fixed decimal point [PA1: dot], measured range can be changed by setting and measured range of decimal point position is as below chart. It is available to adjust the upper gradient at [PA 1: SPAN] and [PA 1: ESPN]. In order to measure frequency normally, input signal, over 10% F.S. of the measured range, should be supplied. Please select the proper point of

① Measuring range

Decimal point position	0.000	0.00	0.0	0
Measurement range	0.100 to 9.999Hz	0.10 to 99.99Hz	0.1 to 999.9Hz	1 to 1200Hz

※Accuracy of frequency measurement:

Below 1kHz, F.S. ±0.1rdg ±2-digit.

From 1kHz to 10kHz, F.S. ±0.3rdg ±2-digit.

② SPAN: 0.100 to 9.999 [Gradient adjustment of high value]

③ ESPN: 10⁻², 10⁻¹, 10⁰, 10¹ [Index adjustment of SPAN]

Error correction [PA 1 group: SPAN / ZERO]

It corrects display value error of measured input.

ZERO: -99 to 99 [Adjust deviation of low value]

SPAN: 0.100 to 9.999 [Correct gradient of high value]

Display value = (measured value × SPAN) + ZERO

E.g.) When the measured range is 0 to 500V, and the display range is 0 to 500.0. If the low display value is "12" to 0V input, set -12 as ZERO value to display "0.0" by adjusting offset of the low value. The display value to 500V measured input varies by adjusting the offset of low value. If this display value is "50.10", calculate 500.0/501.0 (desired display value/the display value), and set the 0.998 correction value as the SPAN to display 500.0 by adjusting gradient of high value.

※The offset correction range of ZERO is within -99 to 99 for D⁰, D⁻¹ digit regardless of decimal point.

※High limit error correction function is available as "Gradient correction function" and low limit error correction function is available as "Zero adjustment function".

LCD Display Multi Panel Meter

◎ Display scale [PA 1 group: H-5C/L-5C]

This function is to display setting (-1999 to 9999) of particular High/Low-limit value in order to display High/Low-limit value of measured input. If measured inputs are 'a' and 'b' and particular values are 'A' and 'B', it will display $a=A$, $b=B$ as below graphs.

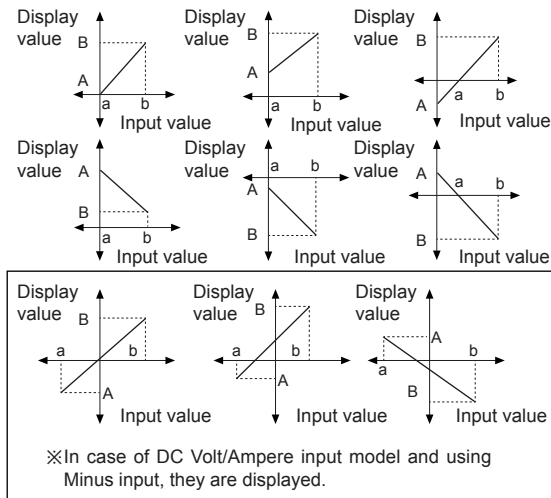

Display scale function is able to change display value for min./max. measured input by setting high limit scale H-5C and low limit scale L-5C in parameter 1 group.

E.g.) High limit scale value and low limit scale value setting (input range = 0 to 5V)

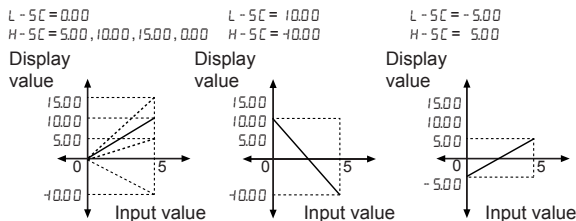

※When changing measured input, high limit scale value and low limit scale value are automatically changed as the default display range of the changed measured input.

◎ Power factor (PF) display [PA 1 group: H-RG/L-RG]

- This function displays LEAD and LAG by analog output signal from the power factor transducer.
- It is available to accept several outputs of the power factor transducer by high-limit [H-RG]/low-limit [L-RG] analog output value setting in the power factor transducer.
- Power factor value is displayed as $\cos\phi$ value -0.50 (LEAD) to 1.00 (LAG).
- LEAD is when current phase leads voltage phase, LAG is when current phase lags behind voltage phase. LEAD and LAG are invalid power.
- Setting range: From min. to max. selected value from measurement input range [N-R]

E.g.) When setting 200V in input range [N-R], H-RG and L-RG are available to set from -2000 to 2000. When setting 20V, H-RG and L-RG are available to set from -2000 to 2000. (※H-RG > L-RG)

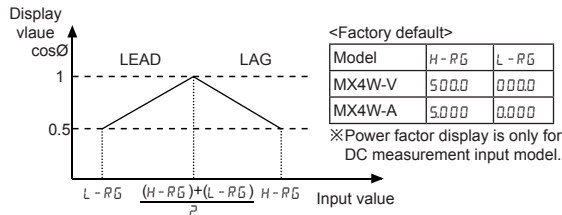

E.g. 1) When the output of the power factor transducer is DC 4-20mA,

- ① Connect the output to the input terminal 7 (+), 8 (-) of this unit, then set input range [N-R] as 4-20.
- ② When setting the input range as 4-20, L-RG is set as 4.00 and H-RG is set as 20.00 automatically. L-RG and H-RG is for the setting of the power factor transducer output.
- ③ If measured input is 4mA, it displays -0.50. For 12mA measured input, it displays 1.00 and for 20mA, it displays 0.50.

E.g. 2) When the output of the power factor transducer is DC1-5V,

- ① Connect the output to the input terminal 6 (+), 8 (-) of this unit, then set the input range [N-R] as 1-5.
- ② Set H-RG as 5.00 and L-RG as 1.00 for the output of the power factor transducer.
- ③ If measured input is 1V, it displays -0.50. For 3V measured input, it displays 1.00 and for 5V, it displays 0.50.

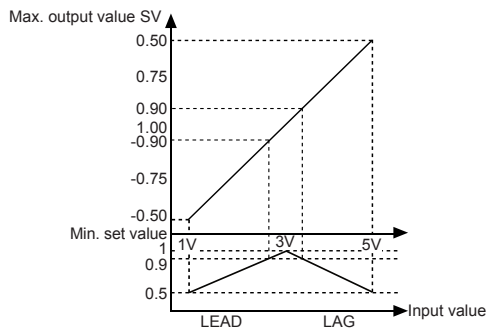

E.g. 3) When LEAD value is smaller than -0.90, LAG value is smaller than 0.90, and OUT1 is used,

- ① Set $OUT1$ as HL at parameter 2 group.
 - ② Set $OUT1H$ as 0.90 and $OUT1L$ as -0.90 at parameter 0 group.
- ※ $OUT2$ is also same setting as $OUT1$.

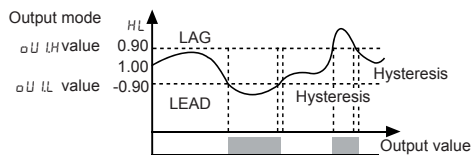

(A) Photoelectric Sensors

(B) Fiber Optic Sensors

(C) Door/Area Sensors

(D) Proximity Sensors

(E) Pressure Sensors

(F) Rotary Encoders

(G) Connectors/ Sockets

(H) Temperature Controllers

(I) SSRs / Power Controllers

(J) Counters

(K) Timers

(L) Panel Meters

(M) Tacho / Speed / Pulse Meters

(N) Display Units

(O) Sensor Controllers

(P) Switching Mode Power Supplies

(Q) Stepper Motors & Drivers & Controllers

(R) Graphic/ Logic Panels

(S) Field Network Devices

(T) Software

MX4W Series

◎ Gradient correction [PA 1 group: $SPRN$]

This function is to adjust the gradient of display value or scale value for input value (within measurement range). As followings (Image 1), input value (X) can be adjusted α , β times to display value (Y) by using gradient correction function [$SPRN$].

- Setting range: 0.100~9.999,
Factory default: 1.000 (unit: multiply)

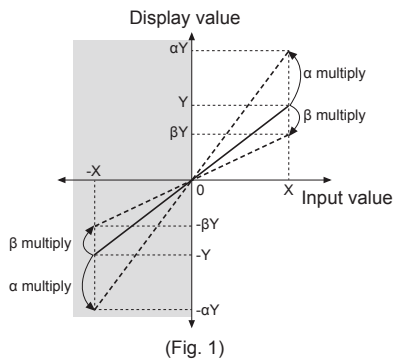

※ Gradient is adjusted based on input value '0'.

※ The part marked with the gray color is not displayed in following cases.

- Input type [dCC] is set to [dC] or [RC]

E.g. 1) Using both display scale [$L-SC/H-SC$] and gradient correction [$SPRN$] (AC input)

- ① In order to display 20V at measurement input range 0-50V as 5.000, set decimal point [dpt] as 0.000 when setting scale value.
- ② If set to display 20V as 5.000, maximum input value 50V is set to be displayed as 12.500. However it is impossible because maximum value of the display scale [$H-SC$] is 9.999. In this case, set gradient correction value [$SPRN$] \times high scale value [$H-SC$] to be 12.500.

$H-SC$	$L-SC$	$SPRN$	Note
12.500	0.000	1.000	Unavailable , because maximum setting value of high scale [$H-SC$] is 9.999.
6.250	0.000	2.000	Any setting value displays same display value.
3.125	0.000	4.000	
2.500	0.000	5.000	

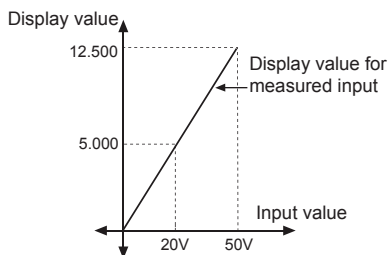

E.g. 2) Using both display scale [$L-SC/H-SC$] and gradient correction [$SPRN$] (DC minus input)

- ① In order to display -80mV at measurement input range -200-200mV as -160.0, set decimal point [dpt] as 0.000 when setting scale value.
- ② If set to display -80mV as -160.0, minimum input value -200mA is set to be displayed as -400.0. In this case, set gradient correction value [$SPRN$] \times high scale value [$L-SC$] to be -400.0.
Set high limit scale value as value of ($-[L-SC]$). If high limit scale value is set before, set low limit scale value as value of ($-[H-SC]$).

$H-SC$	$L-SC$	$SPRN$	Note
400.0	-400.0	1.000	Any setting value displays same display value.
200.0	-200.0	2.000	
100.0	-100.0	4.000	
80.0	-80.0	5.000	

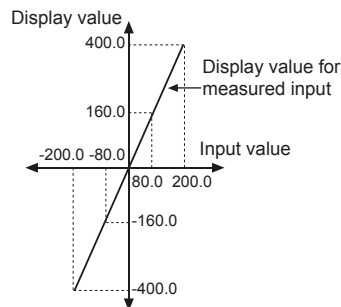

◎ Display cycle delay [PA 2 group: $d15t$]

In some applications the measured input may fluctuate which in turn causes the display to fluctuate. By adjusting the display cycle delay function time in the $d15t$ of parameter 2, the operator can adjust the display time within a range of 0.2 to 5 sec. For example, if the operator sets the display cycle time to 4.0 sec, the display value displayed will be the average input value over 4 sec and also will show any changes if any every 4 sec.

◎ Monitoring peak display value

[PA 0 group: $HPEK/LPEK$, PA 2 group: $PERK$]

It monitors max./min. value of display value based on the current displays value and then displays the data at $HPEK$, $LPEK$ of parameter 0. Set the delay time (0 to 30 sec) at $PERK$ of parameter 2 in order to prevent malfunction caused by initial overcurrent or overvoltage, when monitoring the peak value.

Delay time is 0 to 30 sec and it starts to monitor the peak value after the set time. When pressing the \llcorner \llcorner \llcorner keys for 1 sec at $HPEK$, $LPEK$ of parameter 0, the monitored data is reset.

※ $HPEK$, $LPEK$ parameters is not displayed when monitoring delay time [$PERK$] of parameter 2 group is set as 00 sec [00 5].

LCD Display Multi Panel Meter

◎ Preset output operation mode [PA 2 group: $\alpha U I L / \alpha U I L$]

Mode	Output operation	Operation
OFF		No output
HI GH		Period ON: Display value $\geq \alpha U I H$ Period OFF: Display value $\leq \alpha U I H - H Y S . I$
LOW		Period ON: Display value $\leq \alpha U I L$ Period OFF: Display value $\geq \alpha U I L + H Y S . I$
HL		Period ON: Display value $\leq \alpha U I L$ Display value $\geq \alpha U I H$ Period OFF: Display value $\geq \alpha U I L + H Y S . I$ Display value $\leq \alpha U I H - H Y S . I$
HL - G		Period ON: Display value $\geq \alpha U I L$ Display value $\leq \alpha U I H$ Period OFF: Display value $\leq \alpha U I H - H Y S . I$ Display value $\geq \alpha U I L + H Y S . I$

- ※ Set preset output mode separately for each OUT1/OUT2.
- ※ OUT1/OUT2 are operated individually depending on the set preset output operation mode.
- ※ High/low preset value parameters of the parameter 0 group appear by setting preset output operation mode.
- ※ When changing preset output operation mode, $\alpha U I L / \alpha U I L H Y S . I$ are reset.

◎ Zero adjustment

Forces the display value of measured input to 0 (zero).

- Zero adjustment range: -99 to 99
- Zero adjustment method:

① Hold $\leftarrow + \rightarrow$ keys for 3 sec at the same time.



② Set display holding/zero adjustment [$d I - L$] of parameter 2 group as zero adjustment [$Z E R O$]. Short 3, 4 terminals and zero adjustment is available.

※ When zero adjustment is completed by ① or ② method, the display part displays zero and the adjusted value is saved at [$Z E R O$] of parameter 1 group automatically.

※ If zero adjustment range is exceeded, the error [$\alpha V E R$] flashes twice and it returns to RUN mode, by maintaining previous setting value.

◎ Reset

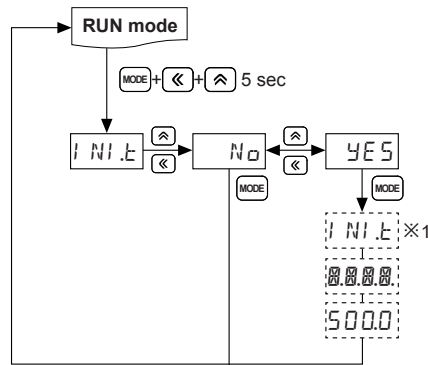

※1: Flashes twice sequentially and returns to RUN mode.

◎ Error display

Display	Description
HHHH	Flashes when measuring input is exceeded the max. allowable input (110%)
LLLL	Flashes when measuring input is exceeded the min. allowable input (-dC setting at dC RC: -110%, dC, RC setting at dC RC: -10%)
d-HH	Flashes when display input is exceeded the max. display range (9999)
d-L L	Flashes when display input is exceeded the min. display range (-9999)
F-HH	Flashes when measuring frequency is exceeded the max. measuring value (9999)
PF-H	Flashes when power factor display value to measured input is over than LAG 0.50
PF-L	Flashes when power factor display value to measured input is less than LEAD -0.50
$\alpha V E R$	Flashes when it exceeds zero adjustment range (± 99)

※ Error display is released automatically when it is in the measured and display range.

(A)	Photoelectric Sensors
(B)	Fiber Optic Sensors
(C)	Door/Area Sensors
(D)	Proximity Sensors
(E)	Pressure Sensors
(F)	Rotary Encoders
(G)	Connectors/ Sockets
(H)	Temperature Controllers
(I)	SSRs / Power Controllers
(J)	Counters
(K)	Timers
(L)	Panel Meters
(M)	Tacho / Speed / Pulse Meters
(N)	Display Units
(O)	Sensor Controllers
(P)	Switching Mode Power Supplies
(Q)	Stepper Motors & Drivers & Controllers
(R)	Graphic/ Logic Panels
(S)	Field Network Devices
(T)	Software

X-ON Electronics

Largest Supplier of Electrical and Electronic Components

Click to view similar products for [General Purpose Relays](#) category:

Click to view products by [Autonics](#) manufacturer:

Other Similar products are found below :

[APF30318](#) [JVN1AF-4.5V-F](#) [PCN-105D3MHZ](#) [5JO-10000S-SIL](#) [5JO-1000CD-SIL](#) [5JO-400CD-SIL](#) [LY2S-AC220/240](#) [LYQ20DC12](#)
[6031007G](#) [6131406HQ](#) [6-1393099-3](#) [6-1393099-8](#) [6-1393122-4](#) [6-1393123-2](#) [6-1393767-1](#) [6-1393843-7](#) [6-1415012-1](#) [6-1419102-2](#) [6-](#)
[1423698-4](#) [6-1608051-6](#) [6-1608067-0](#) [6-1616170-6](#) [6-1616248-2](#) [6-1616282-3](#) [6-1616348-2](#) [6-1616350-1](#) [6-1616350-8](#) [6-1616358-7](#) [6-](#)
[1616359-9](#) [6-1616360-9](#) [6-1616931-6](#) [6-1617039-1](#) [6-1617052-1](#) [6-1617090-2](#) [6-1617090-5](#) [6-1617347-5](#) [6-1617353-3](#) [6-1617801-8](#) [6-](#)
[1617802-2](#) [6-1618107-9](#) [6-1618248-4](#) [M83536/1-027M](#) [CX-4014](#) [MAHC-5494](#) [MAVCD-5419-6](#) [703XCX-120A](#) [7-1393100-5](#) [7-1393111-7](#)
[7-1393144-5](#) [7-1393767-8](#)