

# PRFDAW Series

## Full metal, Cylindrical, Long Sensing Distance, Spatter-Resistance, Cable Connector Type

NEW

### ■ Features

- Long sensing distance
- High impact and wear resistance to friction with the work or metallic brush (sensing face/housing material: stainless steel)
- Reduced possibility of malfunction by aluminum scraps
- Prevent malfunction due to spatter with PTFE coating
- Excellent noise immunity with specialized sensor IC
- Built-in surge protection circuit and output short over current protection circuit
- Stability indicator (green LED) and operation indicator (red LED)  
: excellent visibility with the 360° ring type indicator
- Equipped with the oil resistant cable
- Protection structure: IP67 (IEC standard)



**⚠ Please read "Safety Considerations" in operation manual before using.**



### ■ The Characteristic of Spatter-Resistance Type

The hot arc from arc welding machine is adhesive even with metals or plastics. Therefore, normal proximity sensor might have malfunction even though there are no sensing object if the arcs are put on the sensing surface. The arcs are not adhered on the sensing part of the spatter-resistance type proximity sensor as the part is coated with PTFE against thermal resistance.

Also, the protection cover sold optionally has the same function.

### ■ Durability Test

Highly resistant to the impact of removing welding sludge attached to the sensing face

#### ◎ Continuous hitting test

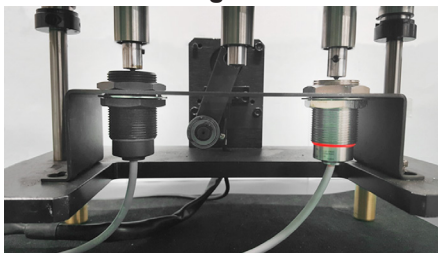

#### Test conditions

Hitting object: 1.3kg of weight  
Hitting speed: 48 times per 1 min  
The number of hitting times: 300 thousand times  
Test model: PRFDAW18

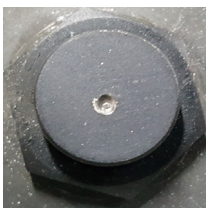

<Test result>

#### ◎ Metallic brush test



#### Test conditions

Testing object: stainless cup brush  
Rotation speed: 80RPM  
Testing time: 3 hours  
Test model: PRFDAW18



<Test result>

### ■ Electromagnetic Resistance Test

Large current from welding generates magnetic field which can affect the proximity sensor to malfunction due to noise. This product, however, can be used near strong noise without malfunctioning, thanks to excellent electromagnetic resistance. This test is conducted in the environment of welding.

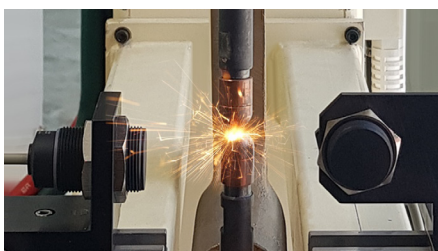

#### Test conditions

Welding current: 13,000A  
Installation direction: front and side  
Test model: PRFDAW Series

Diameter of sensing side	Minimum sensing distance between weld and sensor	
	Front	Side
12mm	No effect from noise	50mm
18mm	30mm	50mm
30mm	120mm	110mm

※ Minimum sensing distance can be different by welding environment.

# Full metal, Cylindrical, Long Sensing Distance, Spatter-Resistance, Cable Connector Type

## Effect of Aluminum Scraps

When aluminum scraps are attached or stacked at sensing side, the proximity sensor does not detect and sensing signal is OFF. However, the below cases may occur to sensing signal. In this case, remove the scraps.

- (1) When the size of aluminum scraps (d) is bigger than 2/3 of the sensing side size (D)  
 (2) When aluminum scraps are attached on the sensing side by external pressure

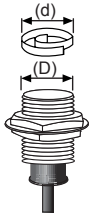

Model	Size	D (mm)
PRFDAW12	10	
PRFDAW18	16	
PRFDAW30	28	

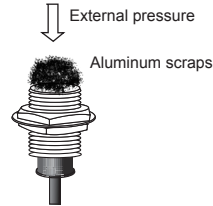

## Specifications

### DC 2-wire type

Model	PRFDAWT12-3DO-IV	PRFDAWT18-7DO-IV	PRFDAWT30-12DO-IV
Diameter of sensing side	12mm	18mm	30mm
Sensing distance <sup>※1</sup>	3mm	7mm	12mm
Installation	Shield (flush)		
Hysteresis	Max. 15% of sensing distance		
Standard sensing target	12×12×1mm (iron)	30×30×1mm (iron)	54×54×1mm (iron)
Setting distance	0 to 2.1mm	0 to 4.9mm	0 to 8.4mm
Power supply (operating voltage)	12-24VDC <sup>≒</sup> (10-30VDC <sup>≒</sup> )		
Leakage current	Max. 0.8mA		
Response frequency <sup>※2</sup>	80Hz	80Hz	50Hz
Residual voltage	Max. 3.5VDC <sup>≒</sup>		
Affection by Temp.	Max. ±20% for sensing distance at ambient temperature 20°C		
Control output	Max. 3 to 100mA		
Insulation resistance	Over 50MΩ (at 500VDC megger)		
Dielectric strength	1,000VAC 50/60Hz for 1 min		
Vibration	1.5mm amplitude at frequency 10 to 55Hz (for 1 min) in each X, Y, Z direction for 2 hours		
Shock	1,000m/s <sup>2</sup> (approx. 100G) in each X, Y, Z direction for 10 times		
Indicator	Stability indicator: green LED, Operation indicator: red LED		
Environment	Ambient temperature	-25 to 70°C, storage: -25 to 70°C	
	Ambient humidity	35 to 95%RH, storage: 35 to 95%RH	
Protection circuit	Surge protection circuit, output short over current protection circuit		
Protection	IP67 (IEC standard)		
Cable	Ø5mm, 2-wire, 300mm, M12 connector (AWG22, core diameter: 0.08mm, no. of cores: 60, insulator diameter: Ø1.25mm)		
Material	Case/Nut: stainless steel 303 (SUS 303, PTFE coated), washer: stainless steel 304 (SUS 304), sensing side: stainless steel 303 (SUS 303, PTFE coated, thickness of PRFDAWT12/18: 0.4mm, RFDAWT30: 0.5mm), oil resistant cable (gray): oil resistant polyvinyl chloride (PVC)		
Approval	CE		
Weight <sup>※3</sup>	Approx. 110g (approx. 83g)	Approx. 132g (approx. 97g)	Approx. 225g (approx. 170g)

※1: When using the nut which is not stainless steel 303 (SUS303) material such as brass, the sensing distance is variable.

※2: The response frequency is the average value. The standard sensing target is used and the width is set as 2 times of the standard sensing target, 1/2 of the sensing distance for the distance.

※3: The weight includes packaging. The weight in parenthesis is for unit only.

※Environment resistance is rated at no freezing or condensation.

(A) Photoelectric Sensors

(B) Fiber Optic Sensors

(C) Door/Area Sensors

(D) Proximity Sensors

(E) Pressure Sensors

(F) Rotary Encoders

(G) Connectors/ Connector Cables/ Sensor Distribution Boxes/Sockets

(H) Temperature Controllers

(I) SSRs / Power Controllers

(J) Counters

(K) Timers

(L) Panel Meters

(M) Tacho / Speed / Pulse Meters

(N) Display Units

(O) Sensor Controllers

(P) Switching Mode Power Supplies

(Q) Stepper Motors & Drivers & Controllers

(R) Graphic/ Logic Panels

(S) Field Network Devices

(T) Software

# PRFDAW Series

## ■ Dimensions

### ● PRFDAWT12-3DO-IV

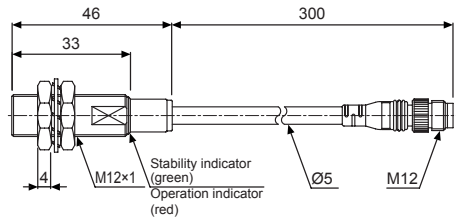
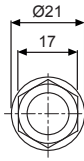

(unit: mm)

### ● PRFDAWT18-7DO-IV

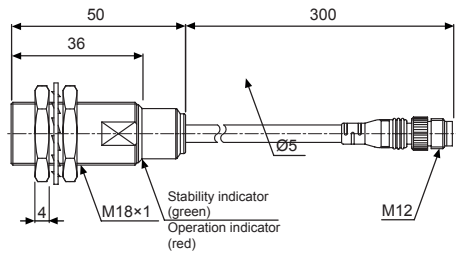
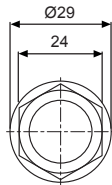

### ● PRFDAWT30-12DO-IV

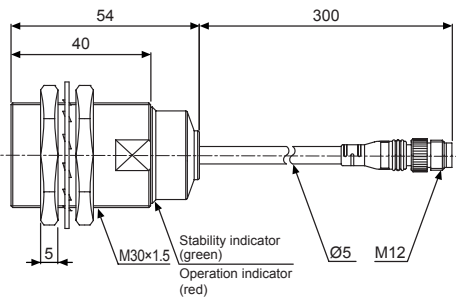
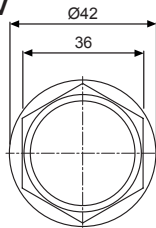

## ■ Control Output Diagram & Load Operating

### ● DC 2-wire type

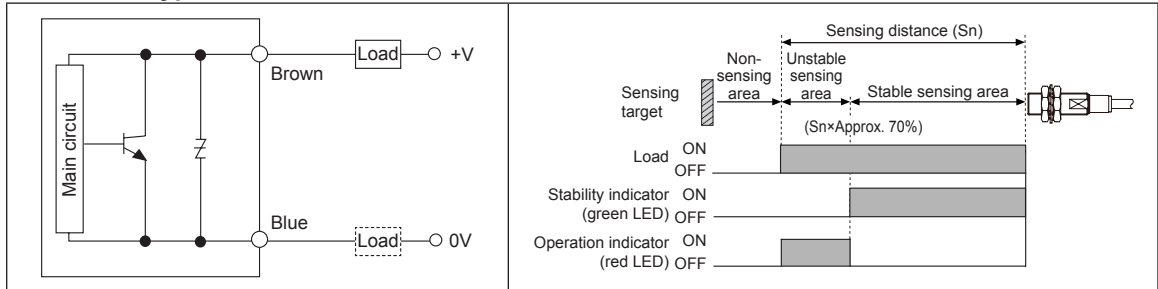

※When the sensing target is placed over approx. 70% of sensing distance (Sn), the operation indicator (red LED) turns ON.  
 When the target is placed within approx. 70% of sensing distance (Sn), the stability indicator (green LED) turns ON.  
 Use the sensor at the position where the stability indicator turns ON.

## ■ Connections

### ● DC 2-wire type (IEC standard)

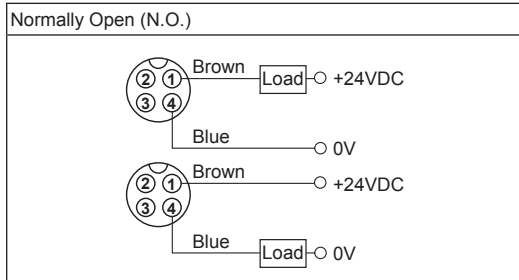

※②, ③ are N-C (Not Connected) terminals.  
 ※For the type and specifications of connector wires, please refer to G-5 page.

# Full metal, Cylindrical, Long Sensing Distance, Spatter-Resistance, Cable Connector Type

## ■ Sensing Distance Feature Data by Target Material and Size

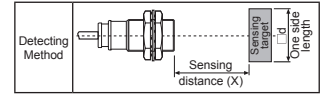

(A) Photoelectric Sensors

(B) Fiber Optic Sensors

(C) Door/Area Sensors

(D) Proximity Sensors

(E) Pressure Sensors

(F) Rotary Encoders

(G) Connectors/  
Connector Cables/  
Sensor Distribution  
Boxes/Sockets

(H) Temperature Controllers

(I) SSRs / Power Controllers

(J) Counters

(K) Timers

(L) Panel Meters

(M) Tacho / Speed / Pulse Meters

(N) Display Units

(O) Sensor Controllers

(P) Switching Mode Power Supplies

(Q) Stepper Motors & Drivers & Controllers

(R) Graphic/ Logic Panels

(S) Field Network Devices

(T) Software

### ● PRFDAWT12-3DO-IV

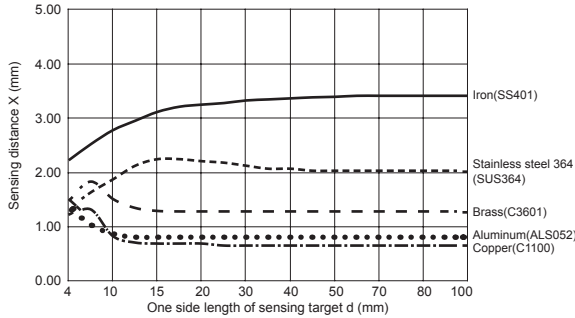

### ● PRFDAWT18-7DO-IV

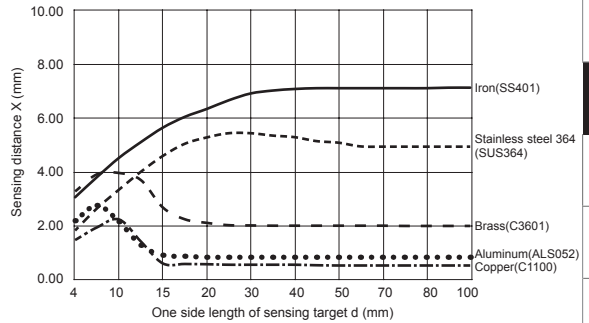

### ● PRFDAWT30-12DO-IV

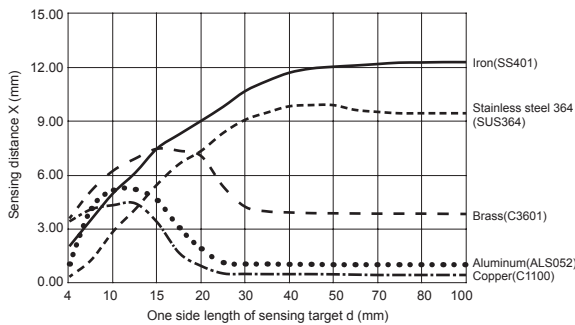

## ■ Sensing Distance Feature Data by Parallel (Left/Right) Movement

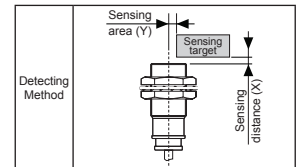

### ● PRFDAWT12-3DO-IV

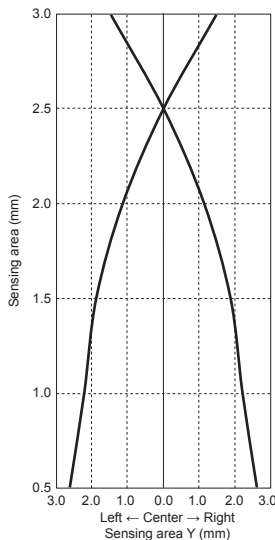

### ● PRFDAWT18-7DO-IV

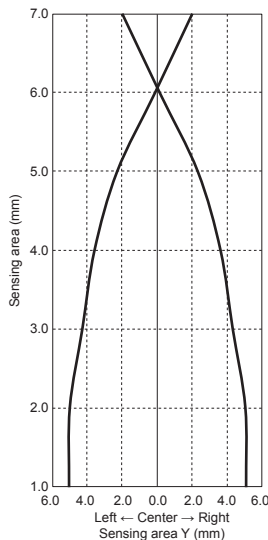

### ● PRFDAWT30-12DO-IV

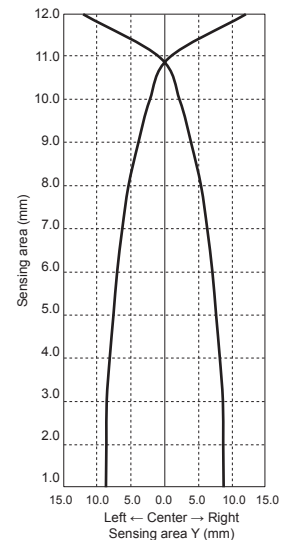

# PRFDAW Series

## ■ Proper Usage

### ◎ Load connections

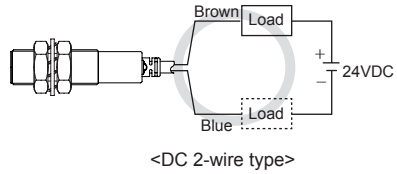
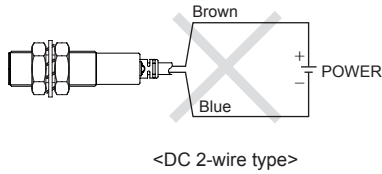

When using DC 2-wire type proximity sensor, the load must be connected, otherwise internal components may be damaged. The load can be connected to either wire.

### ◎ In case of the load current is small

#### ● DC 2-wire type

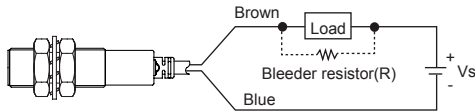

$$R \leq \frac{V_s}{I_o - I_{off}} \text{ (k}\Omega\text{)} \quad P > \frac{V_s^2}{R} \text{ (W)}$$

[ Vs: Power supply, I<sub>o</sub>: Min. action current of proximity sensor, I<sub>off</sub>: Return current of load, P : Number of Bleeder resistance watt ]

Please make the current on proximity sensor smaller than the return current of load by connecting a bleeder resistor in parallel.

※W value of Bleeder resistor should be bigger for proper heat dissipation.

### ◎ Mutual-interference & Influence by surrounding metals

When several proximity sensors are mounted close to one another a malfunction of the may be caused due to mutual interference. Therefore, be sure to keep a minimum distance between the two sensors as below chart indicates. Do NOT connect the sensors more than three in parallel.

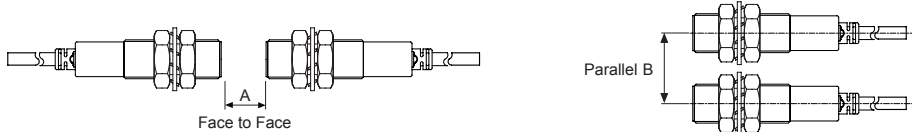

When sensors are mounted on metallic panel, it is required to protect the sensors from being affected by any metallic object except target. Therefore, be sure to provide a minimum distance as below chart indicates.

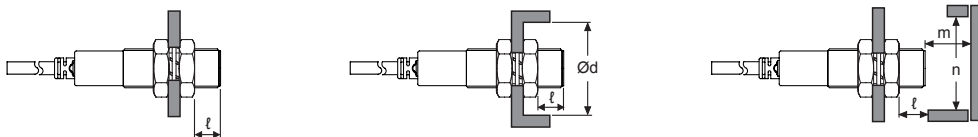

(unit: mm)

Model	PRFDAWT12-3DO-IV	PRFDAWT18-7DO-IV	PRFDAWT30-12DO-IV
Item			
A	40	65	110
B	35	60	100
l	0	0	0
Ød	12	18	30
m	12	28	48
n	40	60	100

## X-ON Electronics

Largest Supplier of Electrical and Electronic Components

*Click to view similar products for [Proximity Sensors](#) category:*

*Click to view products by [Autonics](#) manufacturer:*

Other Similar products are found below :

[01.001.5653.1](#) [70.340.1028.0](#) [70.360.2428.0](#) [70.364.4828.0](#) [70.810.1053.0](#) [72.360.1628.0](#) [73.363.6428.0](#) [9221350022](#) [980659-1](#) [QT-12](#)  
[E2EX10D1NN](#) [E2E-X14MD1-G](#) [E2E-X2D1-G](#) [E2EX2ME2N](#) [E2E-X3D1-N](#) [10M](#) [E2E-X4MD1-G](#) [E2FMX1R5D12M](#) [E2K-F10MC1](#) [5M](#)  
[EI1204TBOSL-6](#) [EI5515NPAP](#) [BSA-08-25-08](#) [IC08ANC15PO-K](#) [IMM2582C](#) [25.161.3253.0](#) [25.332.0653.1](#) [25.352.0653.0](#) [25.352.0753.0](#)  
[25.523.3253.0](#) [9151710023](#) [922FS1.5C-A4P-Z774](#) [SC606ABV0S30](#) [SM952A126100LE](#) [A1220EUA-T](#) [F3S-A162-U](#) [CL18](#) [QT-08L](#)  
[34.110.0010.0](#) [TL-C2MF1-M3-E4](#) [IA08BLF15NOM5](#) [IA08BSF15NOM5](#) [IA12ASF04DOM1](#) [IMM32188C](#) [IS2](#) [IS31SE5000-UTLS2-TR](#)  
[34.110.0021.0](#) [34.110.0022.0](#) [CA150-120VACDC](#) [VM18VA3000Q](#) [XS508BSCBL2](#) [XS512BLNAM12](#)