

# Ø22/25 mm Round Mount Emergency Stop Switches



## SF2ER Series PRODUCT MANUAL

For your safety, read and follow the considerations written in the instruction manual, other manuals and Autonics website.

The specifications, dimensions, etc. are subject to change without notice for product improvement. Some models may be discontinued without notice.

### Main Features

- Easy mounting and removing of Contact Units using a lever
- Adoptable maximum three contact units in series to improve wiring efficiency
- Available to install using either round or forked crimp terminals
- Oil resistant to IP65 protection structure
- Circuit interruption function with a direct opening mechanism for the occurrence of error such as contact weld
- Supplying a various kind of accessories for improving usability
  - Ø22/25mm guard ring for emergency stop switches
  - Ø22/25mm name plate for emergency stop switches
  - Ø22/25mm contact block for emergency stop switches

### Safety Considerations

- Observe all 'Safety Considerations' for safe and proper operation to avoid hazards.
- ⚠ symbol indicates caution due to special circumstances in which hazards may occur.

**⚠ Warning** Failure to follow instructions may result in serious injury or death.

- 01. Fail-safe device must be installed when using the unit with machinery that may cause serious injury or substantial economic loss. (e.g. nuclear power control, medical equipment, ships, vehicles, railways, aircraft, combustion apparatus, safety equipment, crime/disaster prevention devices, etc.)**  
Failure to follow this instruction may result in personal injury, economic loss or fire.
  - 02. System manager means followings;**
    - a personnel who is fully aware of installation, setting, operation, and maintenance of the product
    - a personnel who well observes standard/regulation/statute on the product by type of machine the product installed in and nation/region the product used in

Machine user means a personnel who is appropriately trained about using machine by the system manager, so that machine user can operate the machine correctly.  
System manager has duty to train the machine user about operation of the product. Machine user has to report directly to the system manager when unusual status has been found while system is operating.

Failure to follow this instruction may result in personal injury, economic loss or fire.
- 03. The product has to be installed, set, and combined with machine control system by the qualified system manager.**  
Failure to follow this instruction may result in personal injury due to unintended operation and unstable detection.
  - 04. Before using the product, check that function of the product operates as intended while machine is turned off after installation.**  
Failure to follow this instruction may result in personal injury due to unintended operation and unstable detection.
  - 05. Do not use the unit in the place where flammable/explosive/corrosive gas, high humidity, direct sunlight, radiant heat, vibration, impact, salinity, moisture, steam or dust may be present.**  
Failure to follow this instruction may result in explosion or fire.
  - 06. Do not disassemble or modify the unit.**  
Failure to follow this instruction may result in personal injury or fire due to loss of safety function.
  - 07. Do not defeat, tamper, modify, the switch.**  
Failure to follow this instruction may result in personal injury.
  - 08. Check the installed status of the switch, operating status of the switch, and signs of damage, modification, tampering of the switch at the following situation and on a weekly basis.**
    - when operating the safety system at first
    - when replacing component of the system
    - when the system has not been operated for a long time

Failure to follow this instruction may result in personal injury due to malfunction of the product and safety function.
  - 09. Do not connect, repair, inspect, or replace the unit while connected to a power source.**  
Failure to follow this instruction may result in fire.
  - 10. Check 'Connections' before wiring.**  
Failure to follow this instruction may result in fire.
  - 11. Normally Open (NO) Contacts cannot be used for emergency stop control circuits.**
  - 12. Keep away from high voltage lines or power lines to prevent surge and inductive noise, and make cable as short as possible.**  
In case installing power line and input signal line closely, use line filter or varistor at power line and shielded wire at input signal line.  
Do not use near the equipment which generates strong magnetic force or high frequency noise.  
Failure to follow this instruction may result in personal injury due to malfunction of the product and safety function.

**⚠ Caution** Failure to follow instructions may result in injury or product damage.

- 01. Use the unit within the rated specifications.**  
Failure to follow this instruction may result in fire or product damage.
- 02. Use a dry cloth to clean the unit, and do not use water or organic solvent.**  
Failure to follow this instruction may result in fire.
- 03. Keep the product away from metal chip, dust, and wire residue which flow into the unit.**  
Failure to follow this instruction may result in fire, product damage or malfunction.

## Cautions during Use

- Follow instructions in 'Cautions during Use'. Otherwise, it may cause unexpected accidents.
- Emergency stop pushbuttons are UL NISD Listed when mounted in a sealed, non-ventilated enclosure only.
- When installing the product, keep the minimum installation space between units.
- The switch must be properly assembled.
- While wiring or after wiring the contact block, do not pull the cable.
- Do not hit or flip the button, and use hand not any tool to push the button
- To unlock the switch, turn the button approximately 45° clockwise, and do not turn the button with excessive force.
- This unit may be used in the following environments.
  - Indoors (UL Type 1 Enclosure)
  - Altitude max. 2,000m
  - Pollution degree 3
  - Installation category III

## Ordering Information

This is only for reference, the actual product does not support all combinations. For selecting the specified model, follow the Autonics website.

SF2ER - ① ② ③ ④ - ⑤

### ① Operation

E: Push-lock, turn-reset

### ② Button

- 1: D30 (short head, non-illuminated)
- 2: D40 (short head, non-illuminated)

### ③ Color

R: Red

### ④ Contact block

- B: B contact: 1
- AB: A contact: 1, B contact: 1
- 2B: B contact: 2
- A2B: A contact: 1, B contact: 2
- 3B: B contact: 3

### ⑤ Mark

- No-mark: No-mark
- A: EMO
- S: EMS

## Sold Separately

- Protection guard ring
- Name plate
- Protection guard ring + Name plate set
- Radial support rubber packing / Radial support
- Contact block
- Switch nut fixing handle

## Specifications

Model	SF2ER-□□□□-□
<b>Rated voltage/current</b>	IEC: AC-15 (220 VAC~, 3 A), DC-13 (220 VDC=, 0.2 A) UL: A300, Q300
<b>Contact operating power</b>	3.0 to 8.0 N/ 1 contact
<b>Operation distance</b>	5.0 mm (0/0.5)
<b>Rotation angle</b>	CW (clock wise) 52 °
<b>Allowable operation frequency<sup>01)</sup></b>	Mechanical: 20 times/minute, electrical: 20 times/minute
<b>Life cycle</b>	Mechanical: ≥ 250,000 times, electrical: ≥ 100,000 times
<b>Applicable wire</b>	AWG 18 (0.823 mm <sup>2</sup> )
<b>Insulation resistance</b>	≥ 100 MΩ (500 VDC= megger)
<b>Dielectric strength</b>	2,500 VAC~ 50/60 Hz for 1 minute
<b>Vibration</b>	1.5 mm double amplitude at frequency of 10 to 55 Hz in each X, Y, Z direction for 2 hours
<b>Vibration (malfunction)</b>	1.5 mm double amplitude at frequency of 10 to 55 Hz in each X, Y, Z direction for 10 minutes
<b>Shock</b>	1,000 m/s <sup>2</sup> (≈ 100 g) in each X, Y, Z direction for 3 times
<b>Shock (malfunction)</b>	250 m/s <sup>2</sup> (≈ 25 g) in each X, Y, Z direction for 3 times
<b>Ambient temperature</b>	-20 to 65°C <sup>02)</sup> , storage: -40 to 70 °C (at no freezing or condensation)
<b>Ambient humidity</b>	35 to 85%RH, storage: 35 to 85%RH (at no freezing or condensation)
<b>Protection structure</b>	IP65 <sup>03)</sup> (oil resistant, IEC standards)
<b>Material</b>	Button: PC, body: PA6, lever in fixing unit: PA6
<b>Approval</b>	CE (TUV NORD) UK CA (UL) (S)
<b>Weight<sup>04)</sup></b>	≈ 66g

01) Setting and resetting once is counted as one operation.

02) UL approved ambient temperature: 55 °C

03) It is only for part from front of the panel. Protection structure is guaranteed only when the switch is installed on flat and smooth surface with mounting holes Ø22mm.

04) It is switch with three contact blocks.

## ■ Contact capacity

- IEC (EN60947-5-1)

Rated current		10 A			
Rated voltage		24 V	110 V	220 V	380 V
AC	Resistive load (AC-12)	10 A	10 A	6 A	3 A
	Inductive load (AC-15)	10 A	5 A	3 A	2 A
DC	Resistive load (DC-12)	10 A	2 A	0.6 A	0.2 A
	Inductive load (DC-13)	1.5 A	0.5 A	0.2 A	0.1 A

- UL / CSA (UL508, CSA C22.2 No. 14)

A300

Rated voltage	Through current	Current (A)		Volt ampere (VA)	
		Making	Breaking	Making	Breaking
AC120 V	10 A	60	6	7,200	720
AC240 V		30	3		

Q300

Rated voltage	Through current	Current (A)		Volt ampere (VA)	
		Making	Breaking	Making	Breaking
DC125 V	2.5 A	0.55	0.55	69	69
DC250 V		0.27	0.27		

## Dimensions

- Unit: mm, For the detailed drawings, follow the Autonics website.
- Drawings show the no-mark model.

### ■ D30 (short head, non-illuminated)

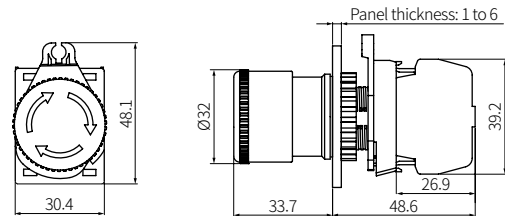

### ■ D40 (short head, non-illuminated)

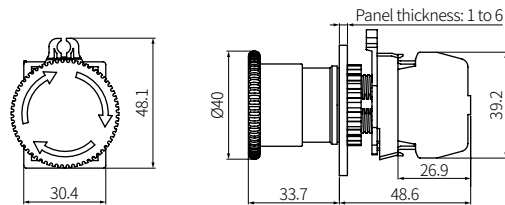

### ■ Panel cut-out

- General

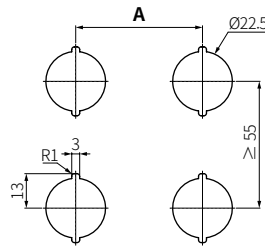

- For anti-rotation

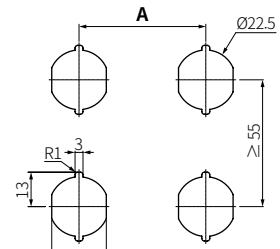

	D30	D40
A	≥ 33 mm	≥ 55 mm

- Panel thickness can differ depending on the use of the sold separately.

	General	With guard ring <sup>01)</sup>	With radial support
Panel thickness	1 to 6 mm	1 to 2.3 mm	1.5 to 6 mm

01) For the panel thickness when using embedded-type guard rings, refer to the product manual.

## Parts Descriptions

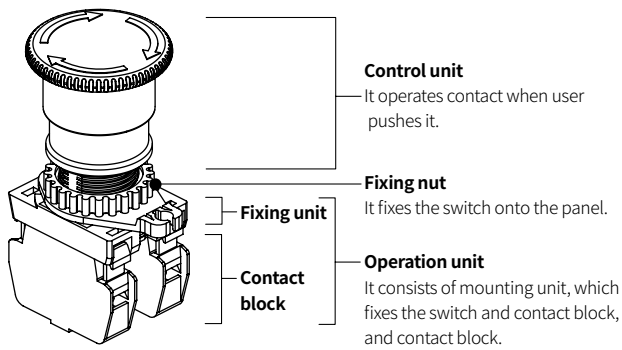

## Installation and Remove

### ■ Installation

1. Insert the control unit from the front side of panel in the ① direction.
2. Insert the fixing nut from the rare side of panel in the ② direction.
3. Turn the fixing nut in the ③ direction to tighten. (tighteng torque: 1.5 to 1.8 N m)  
Before tightening the fixing nut, be sure that there is rubber washer between the switch and panel.  
Tighten the fixing nut using the switch nut fixing handle (sold separately: SA-LH).  
The radial support (sold separately: BK-SF2ER-P) can be used for anti-rotation.  
For more information, refer to the product manual.
4. Put the oeration unit to the control unit in the ④ direction.

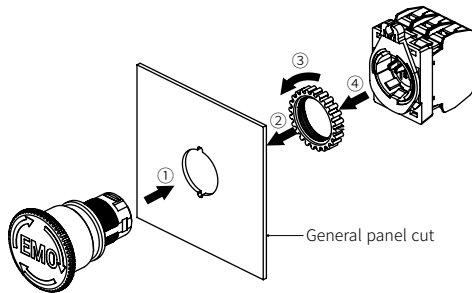

### ■ Removing

1. Turn the lever in the ① direction using the screwdriver.
2. Pull the operation unit in the ② direction to disassemble it.
3. Release the fixing nut in the ① direction to disassemble it.

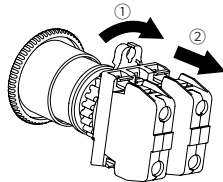

## Contact block

### ■ Assembling contact block

Insert the contact block in the arrow direction.

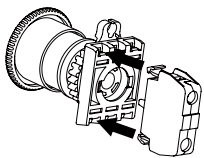

### ■ Disassembling contact block

Lift up the lever in the arrow direction with the screwdriver and to disassemble the contact block.

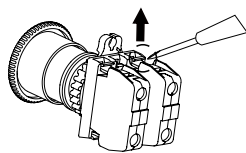

### ■ Wiring

- When wiring contact block, use phillips or slotted M3.5 screws with square washer.
- Applicable wire: AWG 18 (0.823 mm<sup>2</sup>)
- Tightening torque: 0.6 to 0.8 N m
- Unit: mm, Please use UL certified terminals.

Non-insulated terminal	Insulated terminal
<p>Spade terminal</p>	<p>Ring terminal</p>
<p>Spade terminal</p>	<p>Ring terminal</p>

## Sold Separately

### Guard ring

• Unit: mm, For the detailed drawings, follow the Autonics website.

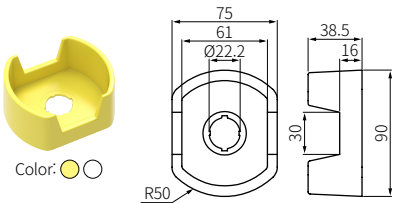
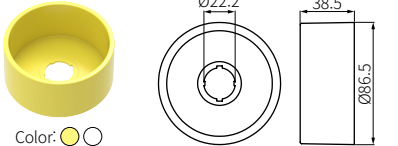
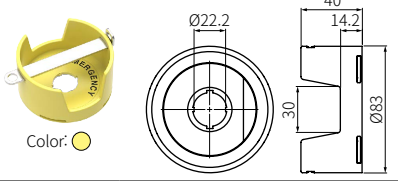
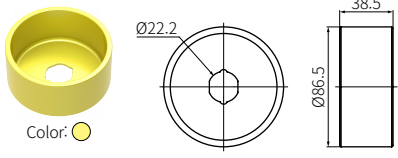
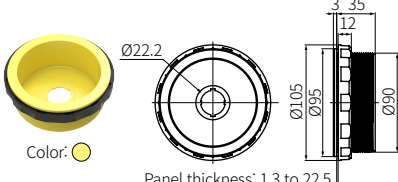
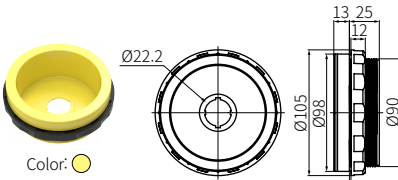
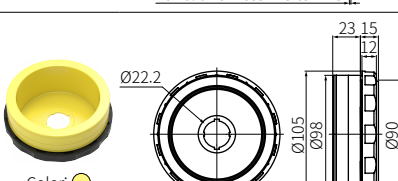

Item	Appearance	Model
Standard type		<ul style="list-style-type: none"> <li>● GUARD-SF2ER</li> <li>○ GUARD-SF2ER-W</li> </ul>
Circle type		<ul style="list-style-type: none"> <li>● GUARD2-SF2ER</li> <li>○ GUARD2-SF2ER-W</li> </ul>
Lock type		<p>This guard ring is sold only as protection guard ring + name plate set.</p> <p>(single metal latch sold separately: GUARD3-SF2ER-L)</p>
Metal type		GUARD2-SF2ER-M
Embedded type (no spacer)		GUARD4-SF2ER
Embedded type (spacer × 1)		GUARD41-SF2ER
Embedded type (spacer × 2)		GUARD42-SF2ER

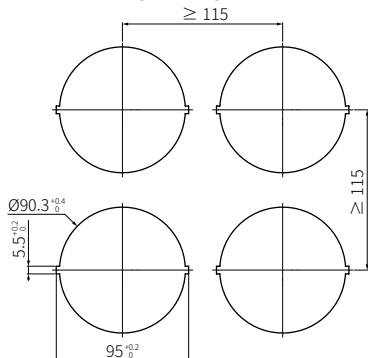
### Embedded type guard ring panel cut-out



### Name plate

• Unit: mm, For the detailed drawings, follow the Autonics website.

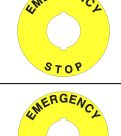
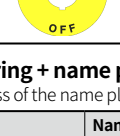
Item	Appearance	Model
Ø 90, STOP		SF2ER-B
Ø 90, OFF		SF2ER-B2
Ø 60, STOP		SF2ER-B3
Ø 60, OFF		SF2ER-B4

### Guard ring + name plate set

• The thickness of the name plate included in the guard ring + name plate set is 0.5 mm.

Guard ring	Name plate	Model
Standard type	Ø 60, STOP	GUARD-SF2ER-S
	Ø 60, OFF	GUARD-SF2ER-A
Standard type white	Ø 60, STOP	GUARD-SF2ER-S-W
	Ø 60, STOP	GUARD2-SF2ER-S
Circle type	Ø 60, OFF	GUARD2-SF2ER-A
	Ø 60, STOP	GUARD2-SF2ER-S-W
Lock type	Ø 60, STOP	GUARD3-SF2ER-S
	Ø 60, OFF	GUARD3-SF2ER-A
Metal type	Ø 60, STOP	GUARD2-SF2ER-S-M
	Ø 60, OFF	GUARD2-SF2ER-A-M

### Radial support

• Unit: mm, For the detailed drawings, follow the the Autonics website.

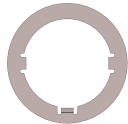
Item	Appearance	Model
Rubber packing		BK-SF2ER-RP
Radial support		BK-SF2ER-P

### Caution for installation

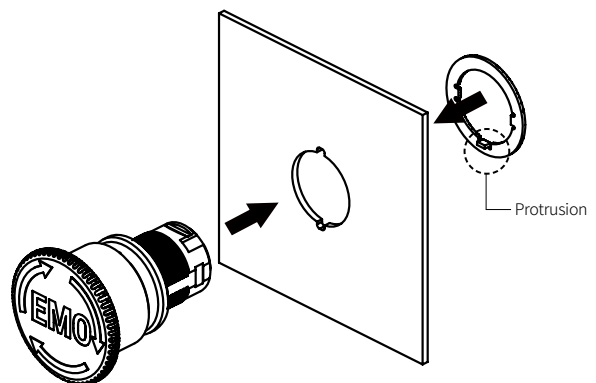

Place the protrusion of the radial support down and put it in the general panel hole.



■ Handle for tightening nut

Item	Appearance	Model
Switch nut fixing handle		SA-LH

■ Contact block

Item	Appearance	Model
A contact (Normally Open)		SFEA-CA
B contact (Normally Closed)		SFEA-CB

## X-ON Electronics

Largest Supplier of Electrical and Electronic Components

*Click to view similar products for [Pushbutton Switches](#) category:*

*Click to view products by [Autonics](#) manufacturer:*

Other Similar products are found below :

[8971K1133](#) [LW2L-M1C20M-A](#) [01-153.025](#) [M22-D-R-GB0/K11](#) [67021K512](#) [701PB580](#) [7199K101](#) [810K12910](#) [810KSV30B](#) [FLT 2U EE](#)  
[01A](#) [MML21EA2ADK](#) [MML21KA3ABK](#) [MML23KW3AA01W](#) [8418K2](#) [8442K3](#) [8450K1](#) [860K11911T01A](#) [861901](#) [861K11911T01A07](#)  
[861K13810T00A14](#) [861K13911](#) [8646AB6X718UL](#) [9533CD4+U574+U4922](#) [99-450.837](#) [99-453.837](#) [A2PMA1X03EC56](#) [A3A-7310](#) [A3A-](#)  
[7340](#) [12037A2ULCSA](#) [1203A2UL](#) [ABGW410-R](#) [1211390004](#) [ABN400-R](#) [121382](#) [1213C3](#) [HE3B-M2](#) [1211500044](#) [121194](#) [1212MRA](#)  
[1232A6NF](#) [121489](#) [1223A2ULCSA](#) [D5P-MT4](#) [13435AG](#) [13445AD29GX768](#) [AG23-L2](#) [AH165-2SGLG1TE3](#) [AH165-TGFY22](#) [AH165-](#)  
[TGL5Y11E3](#) [AH165-TGLR11AA3](#)