

Safety Door Switch



SFD Series PRODUCT MANUAL

For your safety, read and follow the considerations written in the instruction manual, other manuals and Autonics website.

The specifications, dimensions, etc. are subject to change without notice for product improvement. Some models may be discontinued without notice.

Main Features

- Available to change the direction of inserting the operation key by rotating head
: Inserting the operation key from 5 directions in the top and side
- Various kinds of contact composition
: 1 N.O.+1 N.C., 2 N.C., 1 N.O.+2 N.C., 3 N.C.
- Selectable between connector type which reduces working process and terminal type which is useful for maintenance
- Selectable head material between metal and plastic

Safety Considerations

- Observe all 'Safety Considerations' for safe and proper operation to avoid hazards.
- ⚠ symbol indicates caution due to special circumstances in which hazards may occur.

⚠ Warning Failure to follow instructions may result in serious injury or death.

- 01. Fail-safe device must be installed when using the unit with machinery that may cause serious injury or substantial economic loss.** (e.g. nuclear power control, medical equipment, ships, vehicles, railways, aircraft, combustion apparatus, safety equipment, crime/disaster prevention devices, etc.)
Failure to follow this instruction may result in personal injury, economic loss or fire.
- 02. System manager means followings;**
- a personnel who is fully aware of installation, setting, operation, and maintenance of the product
- a personnel who well observes standard/regulation/statute on the product by type of machine the product installed in and nation/region the product used in
Machine user means a personnel who is appropriately trained about using machine by the system manager, so that machine user can operate the machine correctly.
System manager has duty to train the machine user about operation of the product. Machine user has to report directly to the system manager when unusual status has been found while system is operating.
Failure to follow this instruction may result in personal injury, economic loss or fire.
- 03. The product has to be installed, set, and combined with machine control system by the qualified system manager.**
Failure to follow this instruction may result in personal injury due to unintended operation and unstable detection.
- 04. Before using the product, check that function of the product operates as intended while machine is turned off after installation.**
Failure to follow this instruction may result in personal injury due to unintended operation and unstable detection.
- 05. Do not use the unit in the place where flammable/explosive/corrosive gas, high humidity, direct sunlight, radiant heat, vibration, impact, salinity, moisture, or steam, or dust may be present.**
Failure to follow this instruction may result in explosion or fire.
- 06. Do not disassemble or modify the unit.**
Failure to follow this instruction may result in personal injury or fire due to loss of safety function.
- 07. Do not connect, repair, inspect, or replace the unit while connected to a power source.**
Failure to follow this instruction may cause the external devices connected to the product may unexpectedly operate.
- 08. Be cautious about the installing place of the operation key in order to protect worker from hitting the operation key when the door is opened.**
Failure to follow this instruction may result in personal injury.
- 09. Do not use a head of the door lock switch (SFDL Series).**
Failure to follow this instruction may result in personal injury or fire due to loss of safety function.
- 10. Install separate safety device to fix door closed, or door can be opened because of vibration or weight of the door.**
Failure to follow this instruction may result in personal injury.
- 11. Check the installed status of the switch, operating status of the switch, and signs of damage, modification, tampering of the switch at the following situation and on a weekly basis.**
- when operating the safety system at first
- when replacing component of the system
- when the system has not been operated for a long time
Failure to follow this instruction may result in personal injury due to malfunction of the product and safety function.
- 12. Check 'Connections' before wiring. And make sure that there are no safety problems.**
Failure to follow this instruction may result in personal injury or fire due to loss of safety function.

⚠ Caution Failure to follow instructions may result in injury or product damage.

- 01. Use the unit within the rated specifications.**
Failure to follow this instruction may result in fire or product damage.
- 02. Use a dry cloth to clean the unit, and do not use water or organic solvent.**
Failure to follow this instruction may result in fire.
- 03. Keep the door switch away from debris and tighten the screw securely when replacing the head.**
Failure to follow this instruction may result in malfunction.
- 04. Keep the product away from metal chip, dust, and wire residue which might flow into the unit.**
Failure to follow this instruction may result in fire, product damage or malfunction.
- 05. Do not use the switch as a guard door stopper. Install separate mechanical stopper.**
Failure to follow this instruction may result in product damage.
- 06. Carefully manage the spare operation key in order to prevent use of the key without permission.**
Failure to follow this instruction may result in loss of safety function due to insertion of the spare operation key.
- 07. Use only Autonics operation key.**
Failure to follow this instruction may result in product damage.
- 08. Install the operation key tightly within the range written in 'Installation' with welding, rivet, or special bolt in order not to be easily released from the switch.**
Failure to follow this instruction may result in product damage.

Cautions during Use

- Follow instructions in 'Cautions during Use'. Otherwise, it may cause unexpected accidents.
- Use the switch with the dedicated controller. Do not use the switch with another controller randomly.
- This unit may be used in the following environments.
 - Indoors (in the environment condition rated in 'Specifications')
 - Altitude max. 2,000m
 - Pollution degree 3
 - Installation category III
 - Enclosure Type I

Product Components

- Product
- Instruction manual

Sold Separately

- Operation key: SFD-K□□
- M12 Connector Cable: □□DH4-□□□
- Group locking device: SFD-LT□□ / Connecting cable: SFD-LT-C□

Ordering Information

This is only for reference, the actual product does not support all combinations. For selecting the specified model, follow the Autonics website.

SFD - ① ② - ③ ④

① Head materials

No mark: Plastic
M: Metallic

② Contact composition

AB: 1 N.O., 1 N.C.
2B: 2 N.C.
A2B: 1 N.O., 2 N.C.
3B: 3 N.C.

③ Connection outlet

No mark: 1
2: 2

④ Connection outlet specification

M20: M20 thread
G1/2: G1/2 thread
C: M12 connector

Contact Composition and Operation

Contact composition represents the locked status with the operation key inserted.

■: ON, □: OFF

Model	Contact	Contact composition	Contact operation	
			Operation key complete insertion	Operation key extraction
SFD-□AB-□□	1 N.C., 1 N.O.	① 11 — 12 ② 33 — 34	11-12 33-34	
SFD-□2B-□□	2 N.C.	① 11 — 12 ② 31 — 32	11-12 31-32	
SFD-□A2B-□□	2 N.C., 1 N.O.	① 11 — 12 ② 21 — 22 ③ 33 — 34	11-12 21-22 33-34	
SFD-□3B-□□	N.C. 3	① 11 — 12 ② 21 — 22 ③ 31 — 32	11-12 21-22 31-32	

Specifications

Model	SFD-□□-□M20	SFD-□□-□G1/2	SFD-□□-□C
Rated voltage/current for load	Resistive load: 6 A/250 VAC~, 0.6 A/250 VDC~ Inductive load (IEC): AC-15 3 A/240 VAC~, DC-13 0.27 A/250 VDC~ Inductive load (UL): A300, Q300		
Directing opening force	≥ 80 N		
Directing opening distance	≥ 10 mm		
Operating speed	0.05 to 1 m/s		
Operating frequency	≤ 20/min		
Insulation resistance	≥ 100 MΩ (500 VDC~ megger)		
Contact resistance	≤ 50 mΩ (initial value)		
Impulse dielectric strength	Between the terminals: 2 kV (IEC 60947-5-1) Between each terminal and non-live part: 5 kV (IEC 60947-5-1)		
Conditional short circuit current	100 A		
Life cycle	Electrical: ≥ 100,000 operations (240 VAC~ 6 A) Mechanical: ≥ 1,000,000 operations		
Vibration (malfunction)	0.75 mm amplitude at frequency of 10 to 55 Hz in each X, Y, Z direction for 10 min		
Shock	1,000 m/s ² (≈ 100 G) in each X, Y, Z direction for 3 times		
Shock (malfunction)	300 m/s ² (≈ 30 G) in each X, Y, Z direction for 3 times		
Ambient temperature	-30 to 70°C, storage: -40 to 70°C (no freezing or condensation)		
Ambient humidity	35 to 90%RH, storage: 35 to 90%RH (no freezing or condensation)		
Protection structure	IP67 (IEC standard, except for head)		
Material	Plastic head - polyamide 6, metallic head - zinc case; polyamide 6, operation key: stainless steel 304		
Approval	CE (TUV NORD) UK (BSI) S (EHL)		
Connection type	M20 connector cable	G1/2 connector cable	M12 plug connector
Unit weight (packaged)	• 1 connection outlet plastic: ≈ 80 g (≈ 120 g) • 2 connection outlet plastic: ≈ 110 g (≈ 150 g)		Plastic: ≈ 85 g (≈ 130 g) Metallic: ≈ 115 g (≈ 160 g)

01) UL approved ambient temperature: 65°C

02) Rated protection structure is for the switch body. Be cautious about preventing the head part from entering the foreign materials such as dust and water.

Dimensions

Unit: mm, For the detailed dimensions of the product, follow the Autonics web site.

■ Connector type

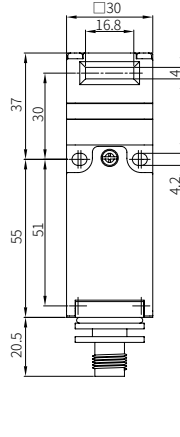
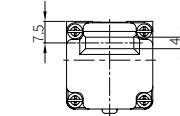

■ 1 connection outlet terminal type

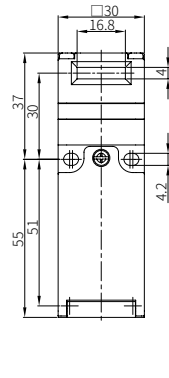
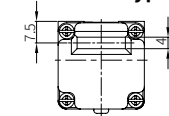

■ 2 connection outlet terminal type

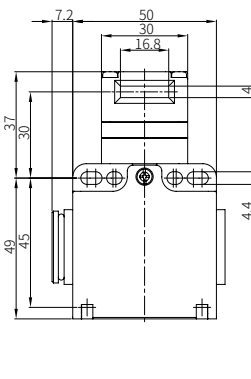
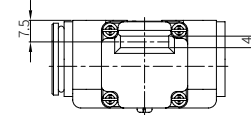

■ Mounting hole cut-out

• 1 connection outlet

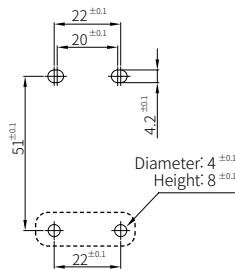

• 2 connection outlet

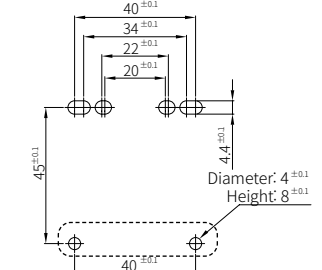

○ is installing spot of protrusion for fixing the switch firmly.

Unit Description

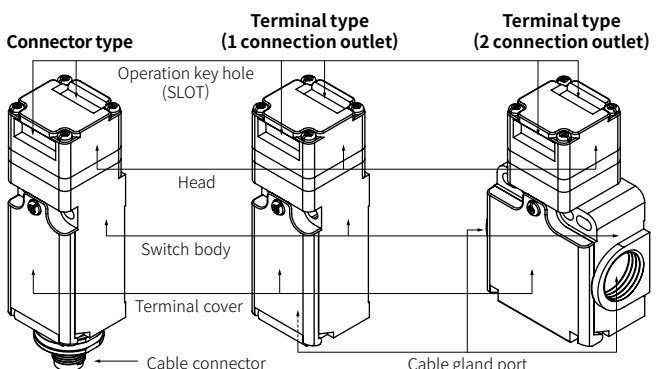

Installation

- The head of the switch can be rotated by loosening the four screws from the corners of the head and reinstalling the head in the desired orientation.
- Be sure to install the switch with the minimum radius at a hinged door as shown in the table. For more information about the operation keys, refer to the product manuals.

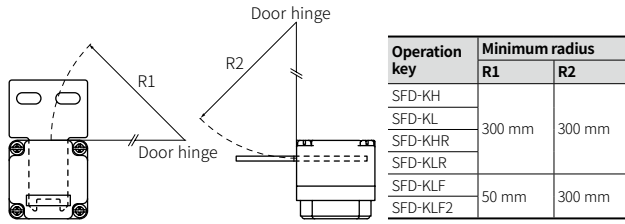

- Inspect the inserted operation key remains within the set zone (0.5 to 3 mm).
- Install the operation key within ± 1 mm from the center of the operation key hole.

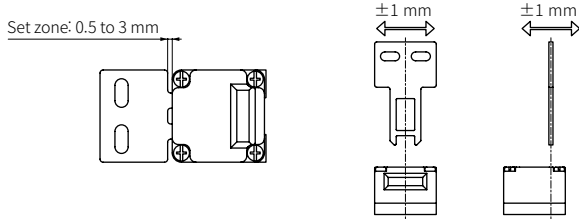

- Recommended screw tightening torque

Screw	Tightening torque
Terminal screw (M3.5)	0.6 to 0.8 N·m
Terminal block screw (M3)	0.3 to 0.5 N·m
Terminal cover screw (M3)	0.4 to 0.6 N·m
Head mounting screw (M3)	0.7 to 0.9 N·m
Cable gland	2.7 to 3.3 N·m
M22 NUT, G1/2 NUT	1.3 to 1.5 N·m

Connections

- When wiring with the ring crimp terminal, connect the terminals as shown in figure for the cable not to override to the case and cover.

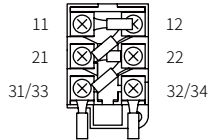

- M12 connector pin arrangement

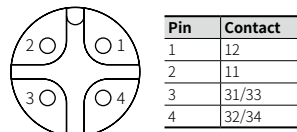

- Use the UL approved ring crimp terminal listed in below. Bend the terminal as following figure to use.

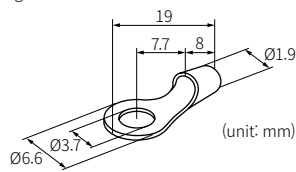

Manufacturer	Model
JST	FN0.5-3.7 (flared type) N0.5-3.7 (straight type)

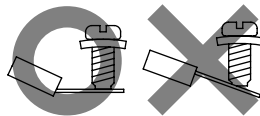

- Use lead wire sizes AWG20 (0.518 mm²) and prepare lead wires using the length given in the following diagram. If lead wires are too long or short, the cover may not be properly closed.

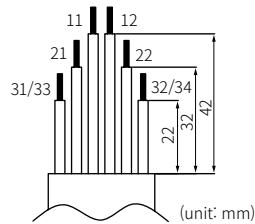

- Cable gland specification and recommended product

Thread spec	MFR	Model	Cable Ø
G1/2	CP SYSTEM	FCGL-G12B	4 - 8 mm
M20	LAPP	ST-M20X1.5 / 5311-1020	6 - 13 mm

- In case of using the cable gland with the 9 mm screw thread or longer, a gap between the switch and cable may affect the protection structure.
- Do not use metallic duct. Using metallic duct can result in electric shock due to the damage on the service entrance.

Sold Separately: Operation Key (SFD-K [])

- Unit: mm, For the detailed dimensions of the product, follow the Autonics web site.

■ SFD-KH

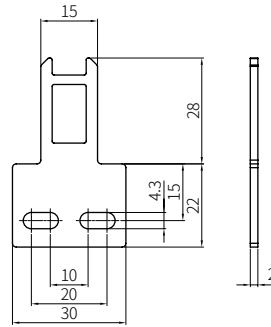

■ SFD-KL

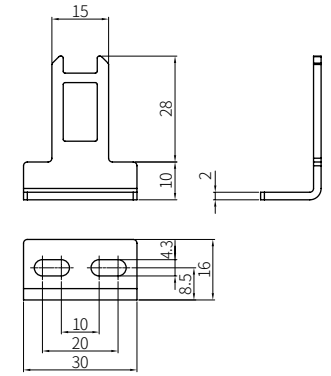

■ SFD-KHR

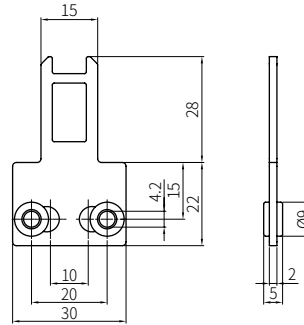

■ SFD-KLR

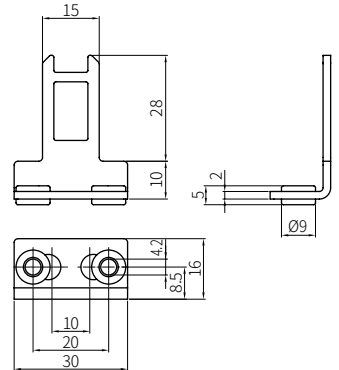

■ SFD-KLF, SFD-KLF2

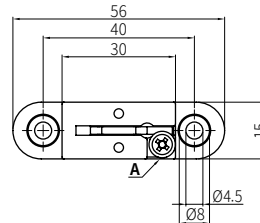



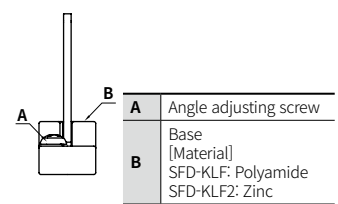
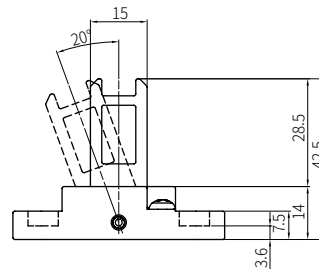
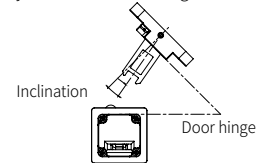

- When installing the switch on a hinged door, turn the angle adjustment screw to adjust the inclination of the control key toward the door hinge.



Sold Separately: Connector Cable

• For detailed information, refer to the 'M8/M12 Connector Cable' manual.

Appearance	Power	Connector 1	Connector 2	Length	Feature	Model
	DC	M12 (Socket-Female) 4-pin	4-wire	2 m	Oil resistant PVC	CIDH4-2
				3 m		CIDH4-3
				5 m		CIDH4-5
				7 m		CIDH4-7
	DC	M12 (Socket-Female) 4-pin	4-wire	2 m	Oil resistant PVC	CIDH4-2-A
				3 m		CIDH4-3-A
				5 m		CIDH4-5-A
				7 m		CIDH4-7-A
	DC	M12 (Socket-Female), L Type 4-pin	4-wire	2 m	Oil resistant PVC	CLDH4-2
				3 m		CLDH4-3
				5 m		CLDH4-5
				7 m		CLDH4-7
	DC	M12 (Socket-Female), L Type 4-pin	4-wire	2 m	Oil resistant PVC	CLDH4-2-A
				3 m		CLDH4-3-A
				5 m		CLDH4-5-A
				7 m		CLDH4-7-A
	DC	M12 (Socket-Female) 4-pin	M12 (Socket-Male) 4-pin	1 m	Oil resistant PVC	C1DH4-1
				3 m		C1DH4-3
				5 m		C1DH4-5
				7 m		C1DH4-7
	DC	M12 (Socket-Female), L Type 4-pin	M12 (Socket-Male), L Type 4-pin	1 m	Oil resistant PVC	C2DH4-1
				3 m		C2DH4-3
				5 m		C2DH4-5
				7 m		C2DH4-7
	DC	M12 (Socket-Female) 4-pin	M12 (Socket-Male), L Type 4-pin	1 m	Oil resistant PVC	C3DH4-1
				3 m		C3DH4-3
				5 m		C3DH4-5
				7 m		C3DH4-7
	DC	M12 (Socket-Female), L Type 4-pin	M12 (Socket-Male) 4-pin	1 m	Oil resistant PVC	C4DH4-1
				3 m		C4DH4-3
				5 m		C4DH4-5
				7 m		C4DH4-7

Sold Separately: Group Locking Device (SFT-LT□) / Connecting Cable (SFD-LT-C□)

Model	SFD-LT	SFD-LT2
Type	Side inserted type	Upside inserted type
Head material of the applied model	Metal	
Padlock ring diameter	Ø 5 to 7 mm	
Load	Max. 30 N	
Shock	300 m/s ² (≈ 30 G) X, Y, Z direction for 3 times	
Vibration	0.35 mm amplitude at frequency of 10 to 55 Hz in each X, Y, Z direction for 10 min	

Side inserted type: SFD-LT

• Unit: mm, For the detailed dimensions of the product, follow the Autonics web site.

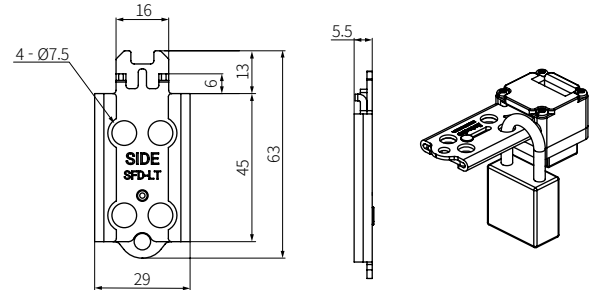

Upside inserted type: SFD-LT2

• Unit: mm, For the detailed dimensions of the product, follow the Autonics web site.

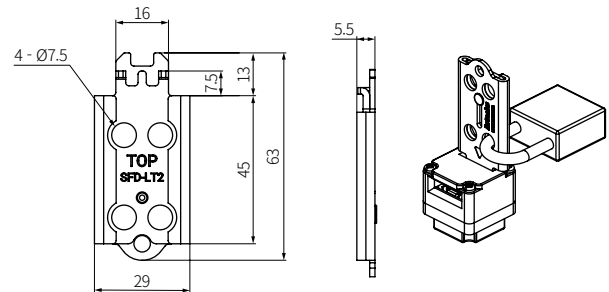

Cautions

- Head material: Use for the metal head of applied models.
- Select the padlock locked in the group locking device to be less than 2 kg. Failure to follow this instruction may result in product or safety switch damage.
- Do not apply excessive shock and vibration while installed in the group locking device. Failure to follow this instruction may result in product or safety switch damage.
- Install the group locking device to prevent interrupting other nearby devices.
- Fasten the group locking device in the correct direction.

SFD-LT

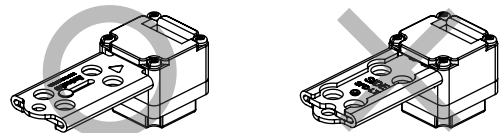

SFD-LT2

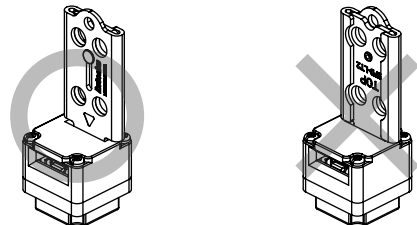

■ Installation

- This is the installation example of the side inserted type.

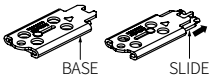

1. Push the SLIDE of the group locking device forward in the direction.

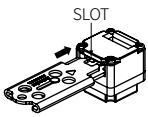

2. Insert the SLIDE into the operation key hole (SLOT).

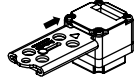

3. Push the BASE to the operation key hole (SLOT) to be fixed stably.

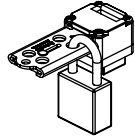

4. Fix the group locking device by fastening the padlock to its hole.

■ Group locking device connecting cable: SFD-LT-C□

- It is possible to prevent loss of the group locking device with the connecting cable(SFD-LT-C□).
- Unit: mm, For the detailed dimensions of the product, follow the Autonics web site.

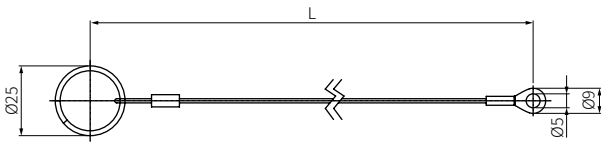

Model	Length (L)
SFD-LT-C20	200
SFD-LT-C30	300
SFD-LT-C40	400

X-ON Electronics

Largest Supplier of Electrical and Electronic Components

Click to view similar products for [Emergency Stop Switches / E-Stop Switches](#) category:

Click to view products by [Autonics](#) manufacturer:

Other Similar products are found below :

[50070974-003-01](#) [ES3S51653001](#) [AVD000T8](#) [D2D 1013H](#) [84-6820.0020A](#) [45-2C35.2920.110](#) [45-2C36.2820.000](#) [45-2D36.2920.000](#) [45-2D36.2A20.000](#) [84-5321.2B20](#) [84-5331.2B20](#) [84-5341.2B20](#) [84-6820.0040](#) [84-6841.2B40](#) [XY2CZ110](#) [TZ-75](#) [AZ 16-03ZVRK-M20](#) [BP 15](#)
[SCHRAUBENSATZ M5X12](#) [SCHRAUBENSATZ M5X16](#) [AZ 16-03ZI-B1](#) [MONTAGESATZ MS AZM 161 P](#) [AZ 16-03ZVK](#) [SLK-F-UC-55-R1-A0-L1-0](#) [SLC-M-024-20/20-R4](#) [F3S-TGR-NLPC-21-10](#) [XCSPA891](#) [84-5040.0130](#) [84-5141.2B40](#) [1.15.210.900/0000](#) [440K-T11338](#)
[XCSDMP5905](#) [XCSDMP5015](#) [XY2CZ404](#) [PPWP-A D1/2K XY ZC](#) [103045524](#) [XACA2113](#) [FD 2084-M2](#) [XCSDMC791L01M8](#)
[XACA6913](#) [CXM/CO/P/G/BB GREEN](#) [6016999193](#) [XB5AS84W3B41](#) [BNS 260-11Z-ST-R](#) [ZB2BV007](#) [XCSE7512](#) [ZQ 700-02](#)
[LPZP1B503](#) [XY2CZ105](#) [541059](#)