

# Safety Non-contact Door Switch



## SFN Series PRODUCT MANUAL

For your safety, read and follow the considerations written in the instruction manual, other manuals and Autonics website.

The specifications, dimensions, etc. are subject to change without notice for product improvement. Some models may be discontinued without notice.

### Features

- Vertical/Horizontal installation supported
- Available to install at back-forth, up-down, right-left moving door
- Connectible maximum 30 units to one controller
- Easy notification of operation status with an operation indicator (ON: green, OFF: red)

### Safety Considerations

- Observe all 'Safety Considerations' for safe and proper operation to avoid hazards.
- ⚠ symbol indicates caution due to special circumstances in which hazards may occur.

**⚠ Warning** Failure to follow instructions may result in serious injury or death.

- 01. Fail-safe device must be installed when using the unit with machinery that may cause serious injury or substantial economic loss. (e.g. nuclear power control, medical equipment, ships, vehicles, railways, aircraft, combustion apparatus, safety equipment, crime/disaster prevention devices, etc.)**  
Failure to follow this instruction may result in personal injury, economic loss or fire.
  - 02. System manager means followings;**
    - a personnel who is fully aware of installation, setting, operation, and maintenance of the product
    - a personnel who well observes standard/regulation/statute on the product by type of machine the product installed in and nation/region the product used in

Machine user means a personnel who is appropriately trained about using machine by the system manager, so that machine user can operate the machine correctly. System manager has duty to train the machine user about operation of the product. Machine user has to report directly to the system manager when unusual status has been found while system is operating.

Failure to follow this instruction may result in personal injury, economic loss or fire.
- 03. The product has to be installed, set, and combined with machine control system by the qualified system manager.**  
Failure to follow this instruction may result in personal injury due to unintended operation and unstable detection.
  - 04. Before using the product, check that function of the product operates as intended while machine is turned off after installation.**  
Failure to follow this instruction may result in personal injury due to unintended operation and unstable detection.
  - 05. Do not use the unit in the place where flammable/explosive/corrosive gas, high humidity, direct sunlight, radiant heat, vibration, impact, salinity, moisture, or steam, or dust may be present.**  
Failure to follow this instruction may result in explosion or fire.
  - 06. Do not disassemble or modify the unit.**  
Failure to follow this instruction may result in personal injury or fire due to loss of safety function.
  - 07. Do not defeat, tamper, modify, or bypass the switch and enter the door.**  
Failure to follow this instruction may result in personal injury.
  - 08. Check whether machine is stopped or not when the door is opened.**  
Failure to follow this instruction may result in personal injury.
  - 09. Check the installed status of the switch, operating status of the switch, and signs of damage, modification, tampering of the switch at the following situation and on a weekly basis.**
    - when operating the safety system at first
    - when replacing component of the system
    - when the system has not been operated for a long time

Failure to follow this instruction may result in personal injury due to malfunction of the product and safety function.
  - 10. Do not connect, repair, inspect, or replace the unit while connected to a power source.**  
Failure to follow this instruction may cause the external devices connected to the product may unexpectedly operate. Failure to follow this instruction may result in fire.
  - 11. Check 'Connections' before wiring. And make sure that there are no safety problems.**  
Failure to follow this instruction may result in personal injury or fire due to loss of safety function.
  - 12. Keep away from high voltage lines or power lines to prevent surge and inductive noise, and make cable as short as possible.**  
In case installing power line and input signal line closely, use line filter or varistor at power line and shielded wire at input signal line.  
Do not use near the equipment which generates strong magnetic force or high frequency noise.  
Failure to follow this instruction may result in personal injury due to malfunction of the product and safety function.

**⚠ Caution** Failure to follow instructions may result in injury or product damage.

- 01. Use the unit within the rated specifications.**  
Failure to follow this instruction may result in fire or product damage.
- 02. Use a dry cloth to clean the unit, and do not use water or organic solvent.**  
Failure to follow this instruction may result in fire.
- 03. Make cable as short as possible, and keep the length of the cable within 100m when extend the length of the cable.**  
Failure to follow this instruction may result in malfunction of the product and safety function due to surge.
- 04. When wiring two or more products in series, keep the total length of the cable within 100m.**  
Failure to follow this instruction may result in malfunction of the safety function due to voltage drop.
- 05. When installing two or more product adjacently, give at least 26mm interval.**  
Failure to follow this instruction may result in malfunction due to mutual interference.
- 06. Do not install the switch and actuator on the magnetic object. Use bolt and nut of stainless steel or non-magnetic material, when installing the switch and actuator.**  
Failure to follow this instruction may result in malfunction or affect sensing distance.
- 07. Do not use the switch as a guard door stopper. Install separate mechanical stopper.**  
Failure to follow this instruction may result in product damage.

**Cautions during Use**

- Follow instructions in 'Cautions during Use'. Otherwise, it may cause unexpected accidents.
- Use the switch with the dedicated actuator and controller. Do not use the switch with another actuator or controller randomly.  
The switch is cannot be used without the controller (SFC-N322).
- Power supply should be insulated and limited voltage/current or Class 2, SELV power supply device.
- When using switching mode power supply to supply the power, ground F.G. terminal and connect a condenser between 0V and F.G. terminal to remove noise.
- This unit may be used in the following environments.
  - Indoors (UL Type 1 Enclosure)
  - Altitude max. 2,000 m
  - Pollution degree 3
  - Installation category II

**Cautions during Installation**

- Install the unit correctly with the usage environment, location, and the designated specifications.
- When installing the product, tightening the screw of M4 × 20 mm with the tightening torque of 0.8N.m.
- Installing more than 2 non-contact door switches closely may result in malfunction due to mutual interference.
- Do not impact on the switch and excessively bend the cables.
- Install the switch to the sensing surface of the switch and the actuator be exactly parallel.

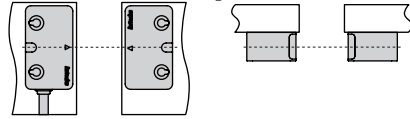

- Install the switch to the direction as below with the consideration of moving directions of the actuator.

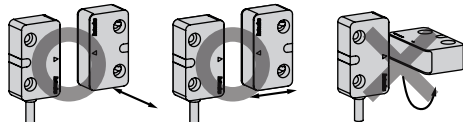

- Install the switch and actuator with a gap of minimum 1mm between them.
- Install the switch at the adjoining wall of the guard door and the actuator at guard door.

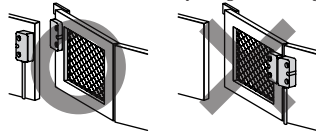

**Ordering Information**

This is only for reference, the actual product does not support all combinations. For selecting the specified model, follow the Autonics website.

SFN - ① - ②

**① Sensing type**

M: Magnet type

**② Cable**

020: cable type (2 m)

050: cable type (5 m)

W: cable connector type

**Product Components**

- Product
- Instruction manual

**Sold Separately**

- Safety controller non-contact door switch unit: SFC-N322
- M12 Connector cable: C1D5-□, CID5-□, CID5-□P
- Branch connector: CCD5-SFN, CYD5-SFN
- Loop connector: CND5-SFN

**Specifications**

<b>Model</b>	SFN-M-□
<b>Operating distance</b> <sup>01)</sup>	OFF→ON ≥ 5 mm
	ON→OFF ≤ 15 mm
<b>Approval</b>	CE (TUV NORD) UK  ENEC  ETL
<b>Unit weight (packaged)</b>	Cable type (2 m): ≈ 100.5 g (≈ 113.8 g)
	Cable type (5 m): ≈ 199.5 g (≈ 214.8 g)
	Cable connector type: ≈ 58.1 g (≈ 71.6 g)

01) It is rated at 23°C of ambient temperature, and it may be differed up to ± 20 % by ambient temperature.

<b>Power supply</b>	24 VDC± (± 10 %)
<b>Operating frequency</b>	100 Hz
<b>Power consumption</b> <sup>01)</sup>	≤ 0.8 W
<b>Auxiliary output</b>	PNP open collector output - 24 VDC±, 10 mA
<b>Operation indicator</b>	ON: green, OFF: red
<b>Life expectancy</b>	≥ 20,000,000 times (with low load)
<b>Insulation resistance</b>	≥ 50 MΩ (500 VDC± megger)
<b>Protection circuit</b>	Surge protection circuit, output short over current protection circuit, reverse polarity protection circuit
<b>Dielectric strength</b>	1,500 VAC~ 50/60Hz for 1 minute
<b>Vibration</b>	1.0 mm amplitude at frequency of 10 to 55 Hz in each X, Y, Z direction for 2 hours
<b>Vibration (malfunction)</b>	1.0 mm amplitude at frequency of 10 to 55 Hz in each X, Y, Z direction for 10 minutes
<b>Shock</b>	300 m/s <sup>2</sup> (≈ 30 G) in each X, Y, Z direction for 3 times
<b>Shock (malfunction)</b>	300m/s <sup>2</sup> (≈ 30G) in each X, Y, Z direction in output ON/OFF status for 3 times
<b>Ambient temperature</b>	-10 to 55 °C, storage : -20 to 60 °C (no freezing or condensation)
<b>Ambient humidity</b>	35 to 85 %RH, storage : 35 to 85 %RH (no freezing or condensation)
<b>Protection structure</b>	IP67 (IEC standard)
<b>Connection</b>	Cable type / cable connector type model
<b>Cable</b>	Ø 5 mm, 5-wire, cable type: 2 m / 5 m, cable connector type: 0.3 m
<b>Wire</b>	AWG26 (0.08 mm), 28-core, core diameter: Ø 0.74 mm
<b>Connector spec.</b>	M12 plug connector
<b>Material</b>	Body/CAP: PC

01) Power to the load is not included.

<b>Characteristic level / Safety category (with SFC-N322)</b>	IEC 61508 SIL 3
	IEC 62061 SIL CL 3
	ISO 13849-1 PL e Cat.4
	- HFT = 1
	- Diagnostic Coverage : 99 % (high)
	- MTTFd = 100 year (high)
	- Mission time = 20 year
	- PFH = 3.88E-09

Safety status in case of error: the switch does not have an internal error recognition function, so it cannot maintain a safety status in the event of error. Error recognition is processed in the connected controller (SFC-N322).

**Operation Distance**

- Operating distance represents the distance between the sensing surface of switch and that of actuator.
- Operating distance can be differed according to the moving direction of actuator from the switch. (at ambient temperature of 23 °C)
- The operating distance may be affected by metal or magnetic substances which is placed closely to the switch.

**■ OFF → ON operation**

Moving direction	Operating distance
Front - Back	≥ 5 mm
Top - Bottom	≥ 2 mm
Left - Right	≥ 5 mm

**■ ON → OFF operation**

Moving direction	Operating distance
Front - Back	≤ 15 mm
Top - Bottom	≥ 6 mm
Left - Right	≤ 15 mm

## Connections

Signal	Function	Pin	Color	Connects safety controller (SFC-N322)
Power input	VCC	1	Brown	D3
	GND	3	Blue	D4
Signal input	IN	2	White	D1
Signal output	OUT	4	Black	D2
Auxiliary output	AUX	5	Yellow	-

- M12 connector pin arrangement

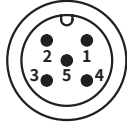

### ■ Connects with Safety Controller (SFC-N322)

- Up to 30 SFNs can be connected to one safety controller non-contact door switch unit (SFC-N322).
- In the case of the cable connector type, connect the branch connector (CCD5-SFN/CYD5-SFN, sold separately) and the loop connector (CND5-SFN, sold separately) using M12 connector cables (sold separately). For detailed explanation, refer to the product manual.

## Dimensions

- Unit: mm, For the detailed drawings, follow the Autonics website.

### ■ Cable type

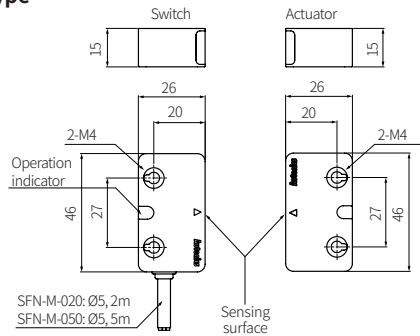

### ■ Cable connector type

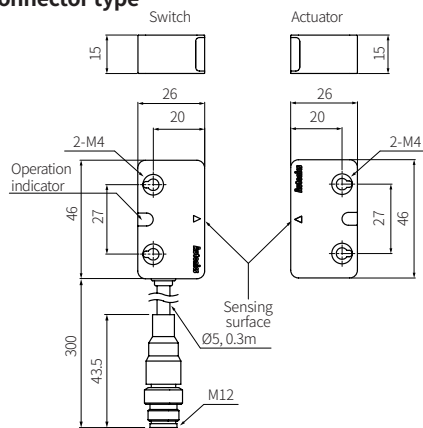

## Example of Multiple Connection with Safety Controller (SFC-N322)

- Up to 30 SFNs can be connected to one safety controller non-contact door switch unit (SFC-N322).
- For more information about safety controller, refer to the safety controller, SFC Series product manual.

### ■ Cable type

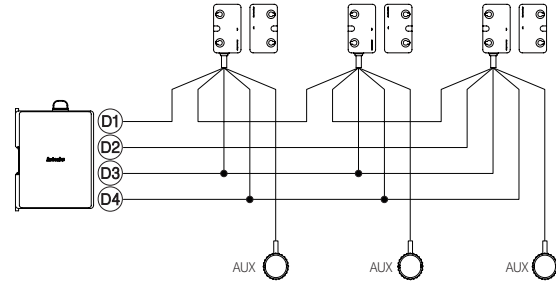

### ■ Cable connector type

- Required Sold Separately
  - M12 connector cable
  - Branch connector (CCD5-SFN/CYD5-SFN)
  - Loop connector (CND5-SFN)
- Check the socket/plug on the branch connector port to select M12 connector cables.
- Install the branch connector (CCD5-SFN/CYD5-SFN, sold separately) from the front.
- Connect a loop connector (CND5-SFN, sold separately) to the X3 port of the branch connector at the far end. If not, the safety controller (SFC-N322) indicator displays an error.

### • Connection example of branch connector cross type (CCD5-SFN)

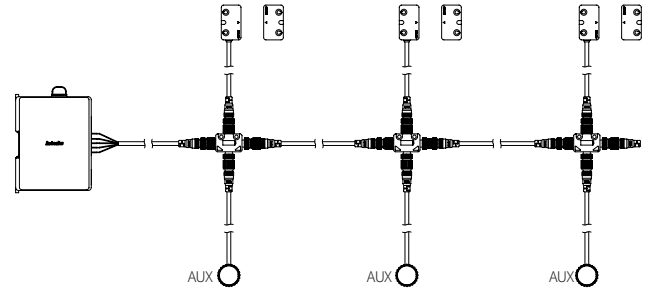

### • Connection example of branch connector Y type (CYD5-SFN)

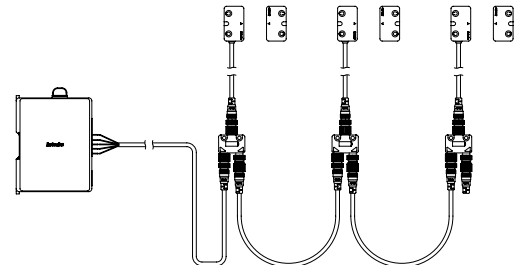

### Sold Separately: Branch Connector

- It is based on a front face. Be sure to the IN/OUT direction.
- Unit: mm, For the detailed drawings, follow the Autonics website.

#### ■ CCD5-SFN (cross type)

Dimension	Connection diagram										
<p>2-M12 Socket</p> <p>2-M12 Plug</p> <p>• Mounting hole 2-M4×0.7 TAP</p>	<table border="1"> <thead> <tr> <th>Port</th> <th>Connect to</th> </tr> </thead> <tbody> <tr> <td>X1</td> <td>Safety non-contact door switch SFN-M-W</td> </tr> <tr> <td>X2</td> <td>Safety controller SFC-N322</td> </tr> <tr> <td>X3</td> <td>Loop connector CND5-SFN</td> </tr> <tr> <td>X4</td> <td>Auxiliary output (AUX)</td> </tr> </tbody> </table>	Port	Connect to	X1	Safety non-contact door switch SFN-M-W	X2	Safety controller SFC-N322	X3	Loop connector CND5-SFN	X4	Auxiliary output (AUX)
Port	Connect to										
X1	Safety non-contact door switch SFN-M-W										
X2	Safety controller SFC-N322										
X3	Loop connector CND5-SFN										
X4	Auxiliary output (AUX)										

#### ■ CYD5-SFN (Y type)

Dimension	Connection diagram								
<p>2-M12 Socket</p> <p>M12 Plug</p> <p>• Mounting hole 2-M4×0.7 TAP</p>	<table border="1"> <thead> <tr> <th>Port</th> <th>Connect to</th> </tr> </thead> <tbody> <tr> <td>X1</td> <td>Safety non-contact door switch SFN-M-W</td> </tr> <tr> <td>X2</td> <td>Safety controller SFC-N322</td> </tr> <tr> <td>X3</td> <td>Loop connector CND5-SFN</td> </tr> </tbody> </table>	Port	Connect to	X1	Safety non-contact door switch SFN-M-W	X2	Safety controller SFC-N322	X3	Loop connector CND5-SFN
Port	Connect to								
X1	Safety non-contact door switch SFN-M-W								
X2	Safety controller SFC-N322								
X3	Loop connector CND5-SFN								

### Sold Separately: Loop Connector (CND5-SFN)

- Connect a loop connector to the X3 port of the branch connector at the far end.
- Unit: mm, For the detailed drawings, follow the Autonics website.

Dimension	Connection diagram
<p>M12 Socket</p>	

### Sold Separately: M12 Connector Cable

- For detailed information, refer to the 'M8/M12 Connector Cable' manual.

Appearance	Power	Connector 1	Connector 2	Length	Feature	Model
	DC	M12 (Socket-Female) 5-pin	M12 (Plug-Male) 5-pin	1 m	PVC	CID5-1
				2 m		CID5-2
				3 m		CID5-3
				5 m		CID5-5
				7 m		CID5-7
	DC	M12 (Socket-Female) 5-pin	5-wire	1 m	PVC	CID5-1
				2 m		CID5-2
				3 m		CID5-3
				5 m		CID5-5
				7 m		CID5-7
	DC	M12 (Plug-Male) 5-pin	5-wire	1 m	PVC	CID5-1P
				2 m		CID5-2P
				3 m		CID5-3P
				5 m		CID5-5P
				7 m		CID5-7P

## X-ON Electronics

Largest Supplier of Electrical and Electronic Components

*Click to view similar products for [Emergency Stop Switches / E-Stop Switches](#) category:*

*Click to view products by [Autonics](#) manufacturer:*

Other Similar products are found below :

[50070974-003-01](#) [ES3S51653001](#) [AVD000T8](#) [D2D 1013H](#) [84-6820.0020A](#) [45-2C35.2920.110](#) [45-2C36.2820.000](#) [45-2D36.2920.000](#) [45-2D36.2A20.000](#) [84-5321.2B20](#) [84-5331.2B20](#) [84-5341.2B20](#) [84-6820.0040](#) [84-6841.2B40](#) [XY2CZ110](#) [TZ-75](#) [AZ 16-03ZVRK-M20](#) [BP 15](#)  
[SCHRAUBENSATZ M5X12](#) [SCHRAUBENSATZ M5X16](#) [AZ 16-03ZI-B1](#) [MONTAGESATZ MS AZM 161 P](#) [AZ 16-03ZVK](#) [SLK-F-UC-55-R1-A0-L1-0](#) [SLC-M-024-20/20-R4](#) [F3S-TGR-NLPC-21-10](#) [XCSPA891](#) [84-5040.0130](#) [84-5141.2B40](#) [1.15.210.900/0000](#) [440K-T11338](#)  
[XCSDMP5905](#) [XCSDMP5015](#) [XY2CZ404](#) [PPWP-A D1/2K XY ZC](#) [103045524](#) [XACA2113](#) [FD 2084-M2](#) [XCSDMC791L01M8](#)  
[XACA6913](#) [CXM/CO/P/G/BB GREEN](#) [6016999193](#) [XB5AS84W3B41](#) [BNS 260-11Z-ST-R](#) [ZB2BV007](#) [XCSE7512](#) [ZQ 700-02](#)  
[LPZP1B503](#) [XY2CZ105](#) [541059](#)