

SR2/SR3 Series

3-Phase, Detachable/Integrated Heatsink Type SSR

■ Features

- Two mounting hole types and sizes
- Alarm output (overheating): Alarm output indicator (red LED), disconnect standard output, alarm output
- Dielectric strength: 4000 VAC (also 2,500VAC model)
- High heat dissipation efficiency with ceramic PCB and integrated heatsink
- Zero cross turn-on, random turn-on models available
- Zero cross turn-on, random turn-on models available
- Input indicator (green LED)
- Various mounting methods (DIN rail, panel) - SRH2/SRH3 series
*DIN rail mount not available for 50 A, 75 A load current models



⚠ Please read "Safety Considerations" in operation manual before using.



■ Ordering Information

SR	H	3	-	1	4	15	R		
								Function	No mark Zero cross turn-on
									R Random turn-on
								Rate load current (Resistive load)	15 15A
									30 30A
									40 40A
									50 50A
									75 75A
								Rated load voltage	2 24-240VAC
									4 48-480VAC
								Rated input voltage	1 4-30VDC
									2 24VAC
									4 90-240VAC
								Control phase	2 3-phase (2-pole)
									3 3-phase (3-pole)
								Type	No mark Detachable heatsink type
									H Integrated heat sink type
								Item	SR Solid State Relay

Model	Rated input voltage	Rated load current	Rated load voltage	Function
SR(H)2-1215	4-30VDC	15A	24-240VAC	Zero cross turn-on
SR(H)3-1215				
SR(H)2-4215	90-240VAC	30A		
SR(H)3-4215				
SR(H)2-1230	4-30VDC	50A		
SR(H)3-1230				
SR(H)2-4230	90-240VAC	75A		
SR(H)3-4230				
SR(H)2-1250	4-30VDC	75A		
SR(H)3-1250				
SR(H)2-4250	90-240VAC	75A		
SR(H)3-4250				
SR(H)2-1275	4-30VDC	75A		
SR(H)3-1275				
SR(H)2-4275	90-240VAC	75A		
SR(H)3-4275				

3-Phase, Detachable/Integrated Heatsink Type SSR

Model	Rated input voltage	Rated load current	Rated load voltage	Function
SR(H)2-1415	4-30VDC	15A	48-480VAC	Zero cross turn-on
SR(H)3-1415				Random turn-on
SR(H)2-1415R				Zero cross turn-on
SR(H)3-1415R	Zero cross turn-on			
SR(H)2-2415	24VAC			Zero cross turn-on
SR(H)3-2415	90-240VAC			Zero cross turn-on
SR(H)2-4415	4-30VDC	30A		Zero cross turn-on
SR(H)3-4415				Random turn-on
SR(H)2-1430				Zero cross turn-on
SR(H)3-1430	Random turn-on			
SR(H)2-1430R	24VAC			Zero cross turn-on
SR(H)3-1430R	90-240VAC			Zero cross turn-on
SR(H)2-2430	4-30VDC	40A		Zero cross turn-on
SR(H)3-2430				Random turn-on
SR(H)2-4430				Zero cross turn-on
SR(H)3-4430	24VAC			Zero cross turn-on
SR(H)2-1440	90-240VAC			Zero cross turn-on
SR(H)3-1440	4-30VDC			50A
SR(H)2-1440R		Random turn-on		
SR(H)3-1440R		Zero cross turn-on		
SR(H)2-2440	24VAC	Zero cross turn-on		
SR(H)3-2440	90-240VAC	Zero cross turn-on		
SR(H)2-4440	4-30VDC	75A	Zero cross turn-on	
SR(H)3-4440			Random turn-on	
SR(H)2-1450			Zero cross turn-on	
SR(H)3-1450	24VAC		Zero cross turn-on	
SR(H)2-1450R	90-240VAC		Zero cross turn-on	
SR(H)3-1450R	4-30VDC		75A	Zero cross turn-on
SR(H)2-2450		Random turn-on		
SR(H)3-2450		Zero cross turn-on		
SR(H)2-4450	24VAC	Zero cross turn-on		
SR(H)3-4450	90-240VAC	Zero cross turn-on		
SR(H)2-1475	4-30VDC	75A		Zero cross turn-on
SR(H)3-1475			Random turn-on	
SR(H)2-1475R			Zero cross turn-on	
SR(H)3-1475R	24VAC		Zero cross turn-on	
SR(H)2-2475	90-240VAC		Zero cross turn-on	
SR(H)3-2475	4-30VDC		75A	Zero cross turn-on
SR(H)2-4475		Random turn-on		
SR(H)3-4475		Zero cross turn-on		

- (A) Photoelectric Sensors
- (B) Fiber Optic Sensors
- (C) Door/Area Sensors
- (D) Proximity Sensors
- (E) Pressure Sensors
- (F) Rotary Encoders
- (G) Connectors/ Connector Cables/ Sensor Distribution Boxes/Sockets
- (H) Temperature Controllers
- (I) SSRs / Power Controllers
- (J) Counters
- (K) Timers
- (L) Panel Meters
- (M) Tacho / Speed / Pulse Meters
- (N) Display Units
- (O) Sensor Controllers
- (P) Switching Mode Power Supplies
- (Q) Stepper Motors & Drivers & Controllers
- (R) Graphic/ Logic Panels
- (S) Field Network Devices
- (T) Software

■ Specifications

○ Input

Rated input voltage range	4-30VDC ^{***}	24VACrms~ (50/60Hz)	90-240VACrms~ (50/60Hz)
Input voltage range	4-32VDC ^{***}	19-26.4VACrms~ (50/60Hz)	85-264VACrms~ (50/60Hz)
Max. input current	25mA	15mA	25mA
Pick-up voltage	Min. 4VDC ^{***}	Min. 19VACrms~	Min. 85VACrms~
Drop-out voltage	Max. 1VDC ^{***}	Max. 4VACrms~	Max. 10VACrms~
Turn-on time	Zero cross turn-on	Max. 0.5 cycle of load source + 1ms	Max. 1.5 cycle of load source + 1ms
	Random turn-on	Max. 1ms	—
Turn-off time	Max. 0.5 cycle of load source + 1ms	Max. 1.5 cycle of load source + 1ms	Max. 1.5 cycle of load source + 1ms

SR2/SR3 Series

■ Specifications

○ Output

Rated load voltage range	24-240VACrms~ (50/60Hz)					48-480VACrms~ (50/60Hz)				
Load voltage range	24-264VACrms~ (50/60Hz)					48-528VACrms~ (50/60Hz)				
Rated load current	Resistive load (AC-51) ^{※1}	15Arms	30Arms	50Arms	75Arms	15Arms	30Arms	40Arms	50Arms	75Arms
Min. load current		0.15Arms	0.2Arms	0.5Arms		0.5Arms				
Max. 1 cycle surge current (60Hz)		250A	400A	1000A		300A	500A		1000A	
Max. non-repetitive surge current (I ² t, t=8.3ms)		340A ² S	1000A ² S	4000A ² S		350A ² S	1000A ² S		4000A ² S	
Peak voltage (non-repetitive)		600V				1200V (Zero cross turn-on), 1000V (Random turn-on)				
Leakage current (Ta=25°C)		Max. 10mArms (240VAC~/60Hz)				Max. 10mArms (480VAC~/60Hz)				
Output on voltage drop [Vpk] (Max. load current)		Max. 1.6V								
Static off-state dv/dt		500V/μs								

※1: AC-51 is utilization category at IEC 60947-4-3.

○ Alarm output (Temperature overheat)

Rated input voltage range	4-30VDC ⁻⁻⁻	24VACrms~ (50/60Hz)	90-240VACrms~ (50/60Hz)
Load input voltage	Max. 30VDC ⁻⁻⁻	Max. 30VDC ⁻⁻⁻	Max. 30VDC ⁻⁻⁻
Load input current	Max. 100mA	Max. 50mA	Max. 50mA
Turn-off time	Max. 20ms	Max. 40ms	Max. 40ms

○ General specifications

Dielectric strength (Vrms)		<ul style="list-style-type: none"> ● 24-240VAC~ rated load current 15A/30A : 2500VAC 50/60Hz 1 min (Input-Output, Input/Output-Case)
		<ul style="list-style-type: none"> ● 24-240VAC~ rated load current 50A/75A ● 48-480VAC~ rated load current 15A/30A/40A/50A/75A : 4000VAC 50/60Hz 1 min (Input-Output, Input/Output-Case)
Insulation resistance		Over 100MΩ (at 500VDC megger) (Input-Output, Input/Output-Case)
Indicator		Input indicator: Green LED / Alarm output indicator: Red LED
Vibration	Mechanical	0.75mm amplitude at frequency of 10 to 55Hz (for 1 min) in each X, Y, Z direction for 1 hour
	Malfunction	0.5mm amplitude at frequency of 10 to 55Hz (for 1 min) in each X, Y, Z direction for 10 min
Shock	Mechanical	300m/s ² (approx. 30G) in each X, Y, Z direction for 3 times
	Malfunction	100m/s ² (approx. 30G) in each X, Y, Z direction for 3 times
Environment	Ambient temperature	-30 to 80°C (in case of the rated input voltage 90-240VAC~: -30 to 70°C), Storage: -30 to 100°C (The rated load current capacity is different depending on ambient temperature. Refer to '■ SSR Derating Curve'.)
	Ambient humidity	45 to 85%RH, Storage: 45 to 85%RH
Input terminal connection		Min. 1×0.5mm ² (1×AWG 20) Max. 1×1.5mm ² (1×AWG 16) or 2×1.5mm ² (2×AWG 16)
Output terminal connection		Min. 1×1.5mm ² (1×AWG 16) Max. 1×16mm ² (1×AWG 6) or 2×6mm ² (2×AWG 10)
Input terminal fixed torque		0.75 to 0.95N·m
Output terminal fixed torque		1.6 to 2.2N·m
Approval		
Weight ^{※1}		<ul style="list-style-type: none"> ● Detachable heatsink type : approx. 365g (approx. 275g) ● Integrated heat sink type - Rated load current 15A/30A/40A: approx. 896g (approx. 686g) Rated load current 50A: approx. 1508g (approx. 1268g) Rated load current 75A: approx. 2354g (approx. 2064g)

※1: The weight includes packaging. The weight in parenthesis is for unit only.

※Environment resistance is rated at no freezing or condensation.

※For wiring the terminal, an O-ring terminal must be used.

3-Phase, Detachable/Integrated Heatsink Type SSR

■ Dimensions

(unit: mm)

◎ Detachable heatsink type

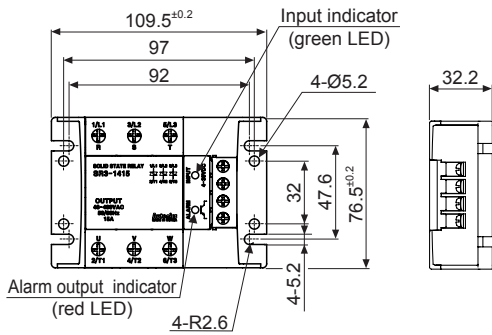

• Panel cut-out

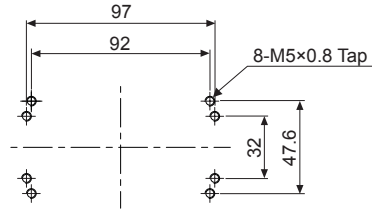

※Detachable heatsink type screw tightening torque for mounting: 2.5N·m to 3N·m

◎ Integrated heat sink (rated load current 15A/30A/40A)

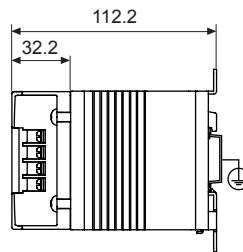
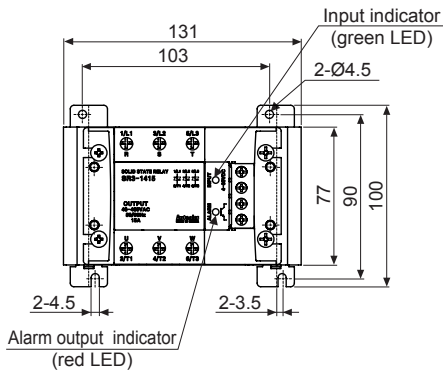

※DIN rail must be grounded.

• Cooling fan mounting hole (rated load current 30A/40A)

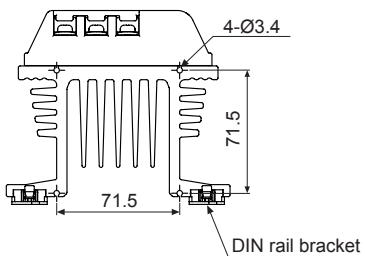

• Panel cut-out

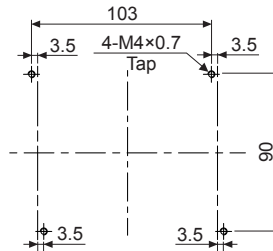

※Detachable heatsink type screw tightening torque for mounting: 1.35N·m

※For horizontal installation(when the heights of input part and output part are equal), it is recommended to apply 50% of rated load current.

(A)	Photoelectric Sensors
(B)	Fiber Optic Sensors
(C)	Door/Area Sensors
(D)	Proximity Sensors
(E)	Pressure Sensors
(F)	Rotary Encoders
(G)	Connectors/ Connector Cables/ Sensor Distribution Boxes/Sockets
(H)	Temperature Controllers
(I)	SSRs / Power Controllers
(J)	Counters
(K)	Timers
(L)	Panel Meters
(M)	Tacho / Speed / Pulse Meters
(N)	Display Units
(O)	Sensor Controllers
(P)	Switching Mode Power Supplies
(Q)	Stepper Motors & Drivers & Controllers
(R)	Graphic/ Logic Panels
(S)	Field Network Devices
(T)	Software

SR2/SR3 Series

◎ Integrated heat sink (rated load current 50A)

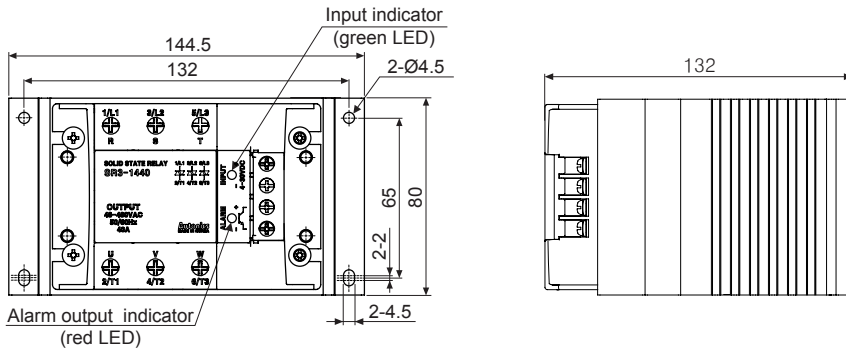

• Cooling fan mounting hole

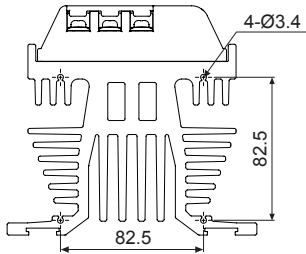

• Panel cut-out

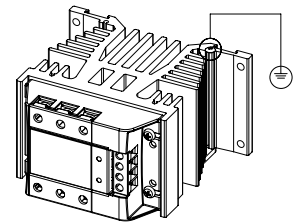
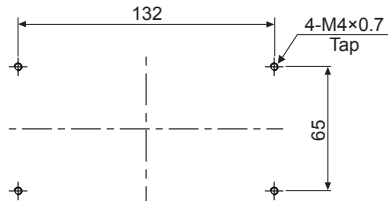

※Bolts for grounding must be grounded.

◎ Integrated heat sink (rated load current 75A)

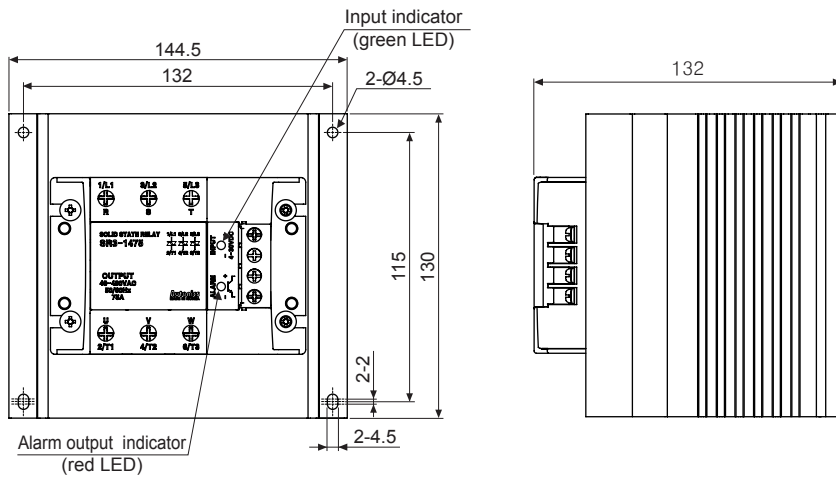

• Cooling fan mounting hole

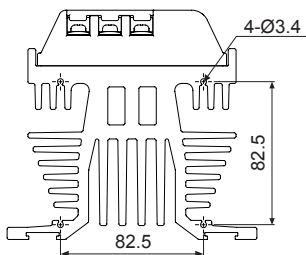

• Panel cut-out

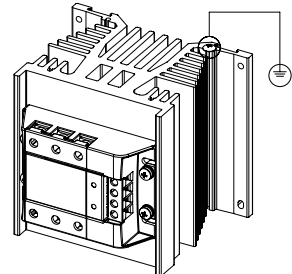
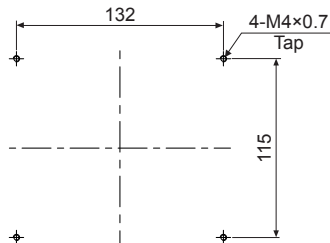

※Bolts for grounding must be grounded.

※Detachable heatsink type screw tightening torque for mounting:1.35N·m

※For horizontal installation (when the heights of input part and output part are equal), it is recommended to apply 50% of rated load current.

3-Phase, Detachable/Integrated Heatsink Type SSR

■ SSR Derating Curve

◎ SR(H)2/SR(H)3-1215

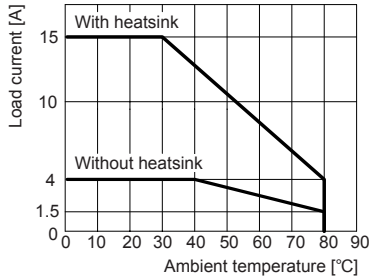

◎ SR(H)2/SR(H)3-1230

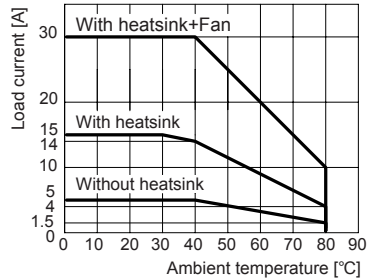

◎ SR(H)2/SR(H)3-1250/1450/1450R/2450

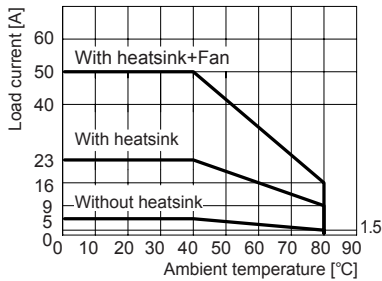

◎ SR(H)2/SR(H)3-1275/1475/1475R/2475

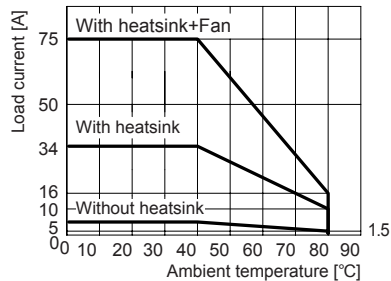

◎ SR(H)2/SR(H)3-1415/1415R/2415

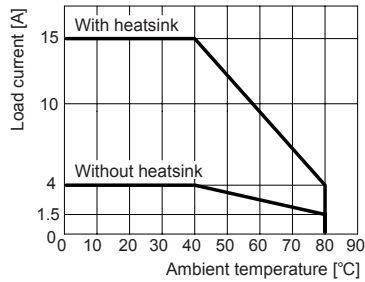

◎ SR(H)2/SR(H)3-1430/1430R/2430

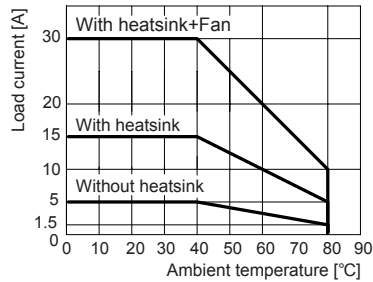

◎ SR(H)2/SR(H)3-1440/1440R/2440

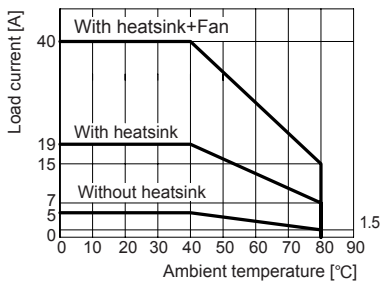

◎ SR(H)2/SR(H)3-4215

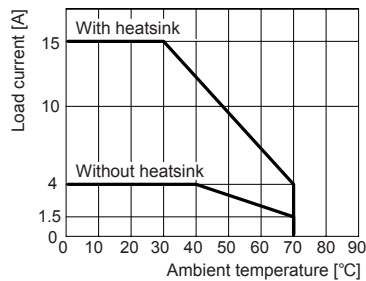

- (A) Photoelectric Sensors
- (B) Fiber Optic Sensors
- (C) Door/Area Sensors
- (D) Proximity Sensors
- (E) Pressure Sensors
- (F) Rotary Encoders
- (G) Connectors/ Connector Cables/ Sensor Distribution Boxes/Sockets
- (H) Temperature Controllers
- (I) SSRs / Power Controllers
- (J) Counters
- (K) Timers
- (L) Panel Meters
- (M) Tacho / Speed / Pulse Meters
- (N) Display Units
- (O) Sensor Controllers
- (P) Switching Mode Power Supplies
- (Q) Stepper Motors & Drivers & Controllers
- (R) Graphic/ Logic Panels
- (S) Field Network Devices
- (T) Software

SR2/SR3 Series

■ SSR Derating Curve

◎ SR(H)2/SR(H)3-4230

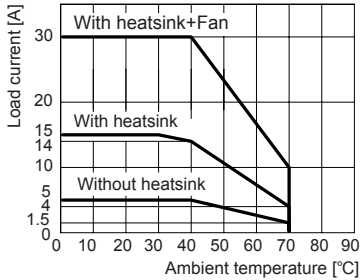

◎ SR(H)2/SR(H)3-4250/4450

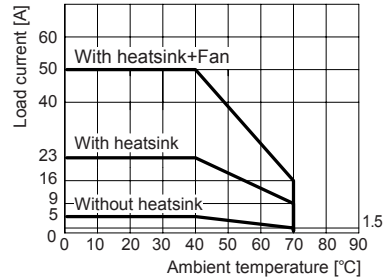

◎ SR(H)2/SR(H)3-4275/4475

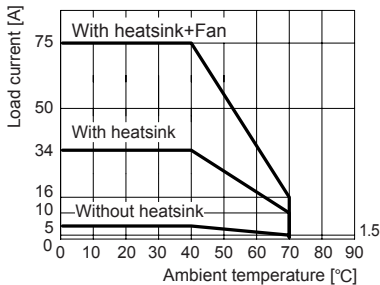

◎ SR(H)2/SR(H)3-4415

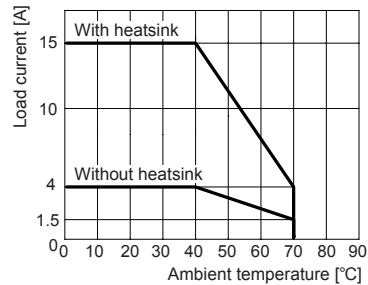

◎ SR(H)2/SR(H)3-4430

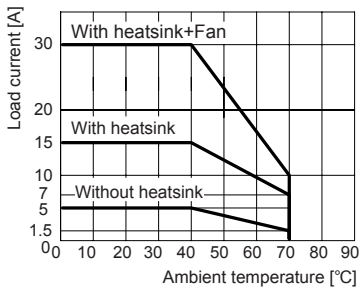

◎ SR(H)2/SR(H)3-4440

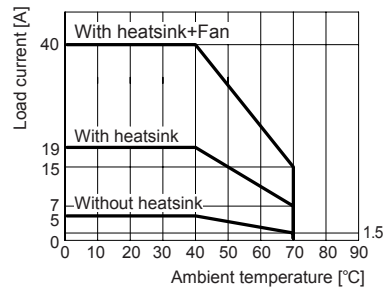

※The heatsink of the curves is dedicated for the SRH2/SRH3.

※Install SR2/SR3 Series on the metal plate (min. 130mm×120mm).

△Please supply less than 50% of the rated load current when installing several SSRs closely due to decreasing effectiveness of protection against heat.

◎ Specification of Fan

Load capacity	Fan type	Size (mm)	Rated air flow ^{※1}	
			m ³ /min	CFM
30A/40A	AC Fan	80×80	0.68	24.0
	DC Fan		1.25	44.0
50A/75A	AC Fan	92×92	1.13	40.0
	DC Fan		1.80	63.5

※1: The fan should be over the rated air flow value.

※Autonics does not provide or sell a fan. (Please buy a fan separately.)

3-Phase, Detachable/Integrated Heatsink Type SSR

■ Connections

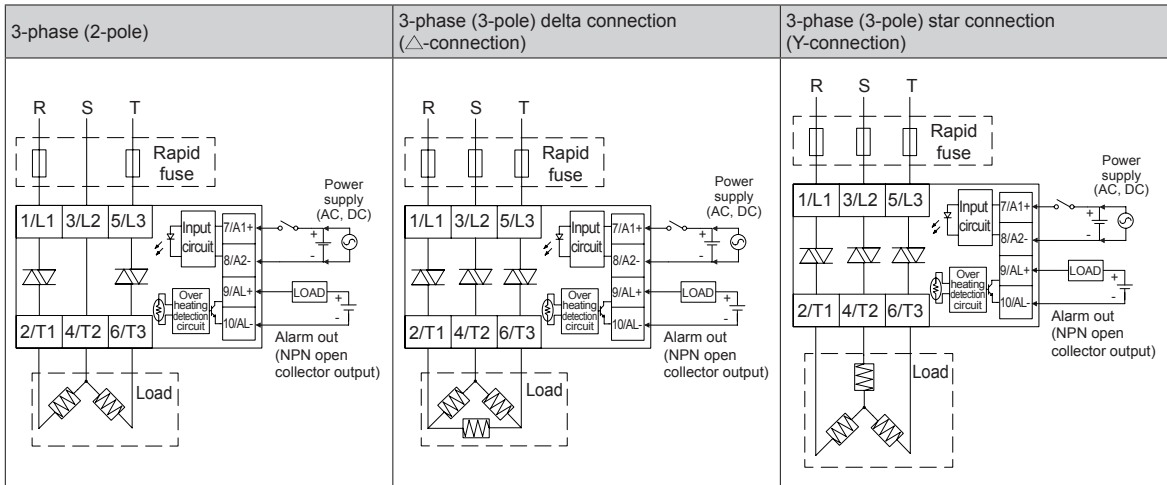

■ Proper Usage

⚠ High temperature caution

Make sure do not touch the heat sink or the unit body while power is supplied or right after load power is turned off. If not, it may cause a burn.

⚠ Cautions during use

- Attach a heatsink and ventilate for smooth convection current. If not, congested heat transfer may cause product failure or malfunction.
- Must ground heatsink or mounted DIN rail. Failure to follow this instruction may cause electric shock.
- For mounting multiple SSR, please keep certain installation intervals for heat prevention. For horizontal installation (when the heights of input part and output part are equal), it is recommended to apply less than 50% of the rated load current.
- Make sure do not touch the heatsink or the unit body while power is supplied or right after load power is turned OFF. If not, it may cause a burn.
- Connect the proper cable for the rated load current with output terminal.
- Use rapid fuse of which I^2t is under 1/2 of SSR I^2t in order to protect the unit from load's short-circuit current. In case of a short-circuit please replace the fuse which has same specification.
- In case that load's current is lower than SSR min. load current, connect dummy resistance to the load in parallel so as to make load's current higher than SSR min. load current.
- When selecting phase control with random turn-on model, install the noise filter between load and load's source.
- Make sure that the screw on output terminal is tightly fastened. Using the unit with loose bolt may cause product failure or malfunction.
- Do not touch the load's terminal even if output is OFF. It may cause electric shock.
- In case of 4-30VDC, 24VAC model, the signal input should be insulated and limited voltage/currentor Class 2, SELV power supply device.
- To attach the heatsink, use Thermal Grease as below or that of equal specification.
※Thermal Grease: GE TOSHIBA (YG6111), KANTO-KASEI (FLOIL G-600), SHINETSU (G746)
- Avoid following environments to install this unit.
 - Where temperature/humidity is over the rated specifications
 - Where dew condensation occurs due to temperature change
 - Where inflammable or corrosive gas exists
 - Where direct rays of light exist
 - Where severe shock, vibration or dust exists
 - Where near facilities generating strong magnetic forces or electric noise
- This product may be used in the following environments.
 - Indoors
 - Max. altitude: Under 2,000m
 - Pollution degree 2
 - Installation category III

(A) Photoelectric Sensors

(B) Fiber Optic Sensors

(C) Door/Area Sensors

(D) Proximity Sensors

(E) Pressure Sensors

(F) Rotary Encoders

(G) Connectors/ Connector Cables/ Sensor Distribution Boxes/Sockets

(H) Temperature Controllers

(I) SSRs / Power Controllers

(J) Counters

(K) Timers

(L) Panel Meters

(M) Tacho / Speed / Pulse Meters

(N) Display Units

(O) Sensor Controllers

(P) Switching Mode Power Supplies

(Q) Stepper Motors & Drivers & Controllers

(R) Graphic/ Logic Panels

(S) Field Network Devices

(T) Software

X-ON Electronics

Largest Supplier of Electrical and Electronic Components

Click to view similar products for [Solid State Relays - Industrial Mount](#) category:

Click to view products by [Autonics](#) manufacturer:

Other Similar products are found below :

[6225XXASRS-DC3](#) [D2440-C](#) [H10CA4890](#) [D4875C](#) [D53TP50DH-10](#) [1395831-1](#) [1616010-6](#) [BR312BY](#) [A-1326](#) [AQY210SXE01](#)
[AQY221N2SYD01](#) [AQY414SXE01](#) [26532764](#) [H10CA4850](#) [H12CA4890VL](#) [RA2410-D06](#) [D1202F](#) [D53TP50-10](#) [W230E-1-12](#) [W230T-3-](#)
[12](#) [W6125ASX-1](#) [W6225DSX-2](#) [W6240DSX-4](#) [W6240DTX-2](#) [1-1617030-3](#) [1-1617033-9](#) [1-1617033-7](#) [MS2-D2420](#) [MS2-D2430](#) [A-1440](#)
[4-1617080-0](#) [RJ1P60V50E](#) [RN1F48I50](#) [70.362.1028.0](#) [7-1393030-8](#) [Z5.509.0828.0](#) [W230E-2-5](#) [G3RV-SR700-D](#) [AC110](#) [G3RV-SR500-AL](#)
[AC100](#) [G3RV-SR500-D](#) [ACDC24](#) [G3RV-SR500-AL](#) [ACDC24](#) [G3RV-SR700-D](#) [ACDC24](#) [G3RV-SR700-AL](#) [ACDC24](#) [G3RV-SR500-D](#)
[DC12](#) [G3RV-SR700-A](#) [ACDC24](#) [G3RV-SR500-A](#) [ACDC24](#) [2912138](#) [2912141](#) [SSRDAC10](#) [1613353](#)