

Modular 2/4-Channel PID Temperature Controllers with Screwless Connector



TM Series PRODUCT MANUAL

For your safety, read and follow the considerations written in the instruction manual, other manuals and Autonics website.

The specifications, dimensions, etc are subject to change without notice for product improvement. Some models may be discontinued without notice.

Features

- Multi-channel (4-channel : TM4/2-channel : TM2) input and output control
- High-speed sampling cycle (4-channel : 100ms/2-channel : 50ms)
- Module connection and expansion with expansion connectors
 - Communication between modules
 - No additional power supply wiring
 - Expandable up to 31 units (124-channels/62-channels)
- Simultaneous heating and cooling control function
- Isolated input channels (dielectric strength : 1000VAC)
- Switch between current output and SSR drive output (TM2- 2C)
- Parameter configuration via PC (USB and RS485 communication)
 - DAQMaster software included (comprehensive device management software)
 - Communication converter sold separately : SCM-US (USB to serial converter), SCM-38I (RS-232C to RS485 converter), SCM-US48I (USB to RS485 converter)
- Easy wiring and maintenance with various connectors : sensor input connector, control output connector, power/communication connector
- Heater disconnect alarm function (CT input)
 - Current transformer (CT) sold separately : CSTC-E80LN, CSTC-E200LN, CSTS-E80PP
- Various input types and temperature ranges

Safety Considerations

- Observe all 'Safety Considerations' for safe and proper operation to avoid hazards.
- ⚠ symbol indicates caution due to special circumstances in which hazards may occur.

⚠ Warning Failure to follow instructions may result in serious injury or death

- 01. Fail-safe device must be installed when using the unit with machinery that may cause serious injury or substantial economic loss. (e.g. nuclear power control, medical equipment, ships, vehicles, railways, aircraft, combustion apparatus, safety equipment, crime/disaster prevention devices, etc.)**
Failure to follow this instruction may result in personal injury, economic loss or fire.
- 02. Do not use the unit in the place where flammable/explosive/corrosive gas, high humidity, direct sunlight, radiant heat, vibration, impact or salinity may be present.**
Failure to follow this instruction may result in explosion or fire.
- 03. Install on a device panel to use.**
Failure to follow this instruction may result in fire.
- 04. Do not connect, repair, or inspect the unit while connected to a power source.**
Failure to follow this instruction may result in fire.
- 05. Check 'Connections' before wiring.**
Failure to follow this instruction may result in fire.
- 06. Do not disassemble or modify the unit.**
Failure to follow this instruction may result in fire.

⚠ Caution Failure to follow instructions may result in injury or product damage

- 01. When connecting the power input and relay output, use AWG 26 to 12 cable and connecting the sensor input and communication cable without dedicated cable, use AWG 28 to 14 cable.**
Failure to follow this instruction may result in fire or malfunction due to contact failure.
- 02. Use the unit within the rated specifications.**
Failure to follow this instruction may result in fire or product damage
- 03. Use a dry cloth to clean the unit, and do not use water or organic solvent.**
Failure to follow this instruction may result in fire or electric shock.
- 04. Keep the product away from metal chip, dust, and wire residue which flow into the unit.**
Failure to follow this instruction may result in fire or product damage.

Cautions during Use

- Follow instructions in 'Cautions during Use'. Otherwise, it may cause unexpected accidents.
- Check the polarity of the terminals before wiring the temperature sensor.
For RTD temperature sensor, wire it as 3-wire type, using cables in same thickness and length.
For thermocouple (CT) temperature sensor, use the designated compensation wire for extending wire.
- Keep away from high voltage lines or power lines to prevent inductive noise.
In case of installing power line and input signal line closely, use line filter or varistor at power line and shielded wire at input signal line.
Do not use near the equipment which generates strong magnetic force or high frequency noise.
- Do not apply excessive power when connecting or disconnecting the connectors of the product.
- Install a power switch or circuit breaker in the easily accessible place for supplying or disconnecting the power.
- Do not use the unit for other purpose (e.g. voltmeter, ammeter), but temperature controller.
- When changing the input sensor, turn off the power first before changing.
After changing the input sensor, modify the value of the corresponding parameter.

- 24 VDC≡ model power supply should be insulated and limited voltage/current or Class 2, SELV power supply device.
- Do not overlapping communication line and power line.
Use twisted pair wire for communication line and connect ferrite bead at each end of line to reduce the effect of external noise.
- Make a required space around the unit for radiation of heat.
For accurate temperature measurement, warm up the unit over 20 min after turning on the power.
- Mounting multiple devices in any way other than the specified mounting method may cause heat to build up inside, which will shorten their service life. If there is a possibility of the ambient temperature rising to a temperature above the specified temperature range, take steps, such as installing fans, to cool the device. Be sure that the cooling method in not cooling just the terminal block. If only the terminal block is cooled, measurement errors may occur.
- Make sure that power supply voltage reaches to the rated voltage within 2 sec after supplying power.
- Do not wire to terminals which are not used.
- Install DIN rail vertically from the ground.
- This unit may be used in the following environments.
 - Indoors (in the environment condition rated in 'Specifications')
 - Altitude Max. 2,000 m
 - Pollution degree 2
 - Installation category II

Ordering Information

This is only for reference, the actual product does not support all combinations. For selecting the specified model, follow the Autonics website.

T	M	①	-	②	③	④	⑤
---	---	---	---	---	---	---	---

① Channel

- 2: 2 channels
- 4: 4 channels

② Alarm output

- 2: Alarm output 1/2 (2 channels)
- 4: Alarm output 1/2/3/4 (2 channels)
- N: None (4 channels)

③ Power supply

- 2: 24 VDC≡

④ Control output

- R: Relay
- S: SSR drive
- C: Selectable current or SSR drive output

⑤ Structure

- B: Basic module
- E: Expansion module
- Since the expansion module is not supplied with power/comm. terminal. Use it with the basic module.

Product Components

- Product (+ bracket)
- Instruction manual
- Side connector × 1
- Power/Comm. connector × 1 (only for basic module)

Sold Separately

- Current transformer (CT)
- Communication Converter: SCM-US / SCM-381 / SCM-US481 / SCM-WF48

Manual

For proper use of the product, refer to the manuals and be sure to follow the safety considerations in the manuals.
Download the manuals from the Autonics website.

Software

Download the installation file and the manuals from the Autonics website.

■ DAQMaster

DAQMaster is comprehensive device management program. It is available for parameter setting, monitoring.

Dimensions

- Unit: mm, For the detailed drawings, follow the Autonics website.
- Below is based on basic module.

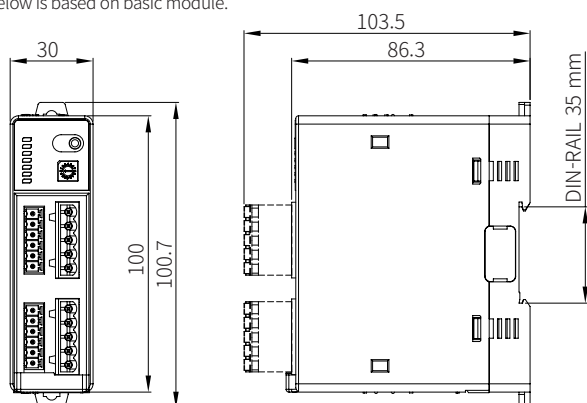

Specifications

Series	TM2	TM4
No. of channels	2 channels	4 channels
Power supply	24 VDC≡	
Permissible voltage range	90 to 110% of rated voltage	
Power consumption	≤ 5 W (for Max. load)	
Sampling period	50 ms (2 channels synchronous sampling)	100 ms (4 channels synchronous sampling)
Input specification	Refer to 'Input Type and Using Range'.	
Option input	CT input	<ul style="list-style-type: none"> • 0.0-50.0 A (primary current measurement range) • CT ratio: 1/1,000 • Measurement accuracy: ±5% F.S. ±1 digit
	Digital input	<ul style="list-style-type: none"> • Contact ON: ≤ 1 kΩ, OFF: ≥ 100 kΩ • Non contact residual voltage: ≤ 1.5 VDC≡ • leakage current: ≤ 0.1 mA • Outflow current: ≈ 0.5 mA per input
Control output	Relay	250 VAC~ 3 A 1a, 30 VDC≡ 3 A 1a
	SSR	12 VDC≡ ± 3 V, ≤ 30 mA
	Current	DC 4 - 20 mA or DC 0 - 20 mA (Load resistance: ≤ 500 Ω)
Alarm output	250 VAC~ 3 A 1a	-
RS485 Comm.	Modbus ASCII / RTU	
Display type	None- parameter setting and monitoring is available at external devices	
Control type	Heating, Cooling	ON/OFF, P, PI, PD, PID Control
	Heating & Cooling	
Hysteresis	1 to 100 (0.1 to 100) °C/°F	
Proportional band (P)	0.1 to 999.9 °C/°F	
Integral time (I)	0 to 9,999 sec	
Derivative time (D)	0 to 9,999 sec	
Control cycle (T)	0.1 to 120.0 sec	
Manual reset	0.0 to 100.0 %	
Relay life cycle	Mechanical	≥ 10,000,000 operations
	Electrical	≥ 100,000 operations (250 VAC~ 3 A load resistance)
Dielectric strength	Between the charging part and the case: 3,000 VAC~ 50/60 Hz for 1 min	
Vibration	0.75 mm amplitude at frequency of 5 to 55 Hz in each X, Y, Z direction for 2 hours	
Insulation resistance	100 MΩ (500 VDC≡ megger)	
Noise immunity	±0.5 kV square shaped noise (pulse width 1 μs) by noise simulator	
Ambient temperature	-10 to 50 °C, storage: -20 to 60 °C (no freezing or condensation)	
Ambient humidity	35 to 85%RH, storage: 35 to 85%RH (no freezing or condensation)	
Channel insulation	Dielectric strength 1,000 VAC~	
Insulation type	Double insulation or reinforced insulation (mark: □, dielectric strength between the measuring input part and the power part: 1 kV)	
Certification	CE, RoHS, REACH, ENEC	
Unit weight (packaged)	• Basic module: ≈ 152 g (≈ 217 g)	• Basic module: ≈ 174 g (≈ 239 g)
	• Expansion module: ≈ 143 g (≈ 208 g)	• Expansion module: ≈ 166 g (≈ 231 g)

Input Type and Using Range

The setting range of some parameters is limited when using the decimal point display.

Input type	Decimal point	Display method	Using range (°C)	Using range (°F)	
Thermo-couple	K (CA)	1	K (CA) .H	-200 to 1,350	-328 to 2,462
		0.1	K (CA) .L	-200.0 to 1,350.0	-328.0 to 2,462.0
	J (IC)	1	J (IC) .H	-200 to 800	-328 to 1,472
		0.1	J (IC) .L	-200.0 to 800.0	-328.0 to 1,472.0
	E (CR)	1	E (CR) .H	-200 to 800	-328 to 1,472
		0.1	E (CR) .L	-200.0 to 800.0	-328.0 to 1,472.0
	T (CC)	1	T (CC) .H	-200 to 400	-328 to 752
		0.1	T (CC) .L	-200.0 to 400.0	-328.0 to 752.0
	B (PR)	1	B (PR)	0 to 1,800	32 to 3,272
		1	R (PR)	0 to 1,750	32 to 3,182
	S (PR)	1	S (PR)	0 to 1,750	32 to 3,182
		1	N (NN)	-200 to 1,300	-328 to 2,372
C (TT) ⁰¹	1	C (TT)	0 to 2,300	32 to 4,172	
	1	G (TT) ⁰²	0 to 2,300	32 to 4,172	
L (IC)	1	L (IC) .H	-200 to 900	-328 to 1,652	
	0.1	L (IC) .L	-200.0 to 900.0	-328.0 to 1,652.0	
U (CC)	1	U (CC) .H	-200 to 400	-328 to 752	
	0.1	U (CC) .L	-200.0 to 400.0	-328.0 to 752.0	
RTD	Platinil II	1	PLII	0 to 1,400	32 to 2,552
		0.1	CU 50	-200.0 to 200.0	-328.0 to 392.0
	Cu100 Ω	1	CU 100	-200.0 to 200.0	-328.0 to 392.0
		0.1	JPt100.H	-200 to 600	-328 to 1,112
	JPt100 Ω	1	JPt100.L	-200.0 to 600.0	-328.0 to 1,112.0
		0.1	DPT50.L	-200.0 to 600.0	-328.0 to 1,112.0
	DPT50 Ω	1	DPT100.H	-200 to 600	-328 to 1,112
		0.1	DPT100.L	-200.0 to 600.0	-328.0 to 1,112.0
	DPT100 Ω	1	NI12	-80 to 260	-112 to 500
		0.1			

01) C (TT): Same as existing W5 (TT) type sensor

02) G (TT): Same as existing W (TT) type sensor

■ Measurement accuracy

Input type	Using temperature	Measurement accuracy
Thermo-couple	At room temperature (23 ± 5 °C)	(PV ± 0.5% or ± 1 °C higher one) ± 1-digit • Thermocouple K, J, T, N, E below -100 °C and L, U, PLII: ± 2 °C ± 1-digit • Thermocouple C, G and R, S below 200 °C: ± 3 °C ± 1-digit • Thermocouple B below 400 °C: there is no accuracy standards
	Out of room temperature range	(PV ± 0.5% or ± 2 °C higher one) ± 1-digit • RTD: (PV ± 0.5% or ± 3 °C higher one) ± 1-digit • Thermocouple R, S, B, C, G, L, U: (PV ± 0.5% or ± 5 °C higher one) ± 1-digit • Thermocouple below -100 °C: ± 5 °C

Communication Interface

■ RS485

Protocol	Modbus ASCII / RTU
Application standard	EIA RS485 compliance with
Maximum connection	31 units (address: 01 to 31)
Synchronization type	Asynchronous
Connection type	Two-wire half duplex
Comm. effective range	≤ 800 m
Comm. speed	2,400 / 4,800 / 9,600 (default) / 19,200 / 38,400 / 57,600 / 115,200 bps (parameter)
Response time	5 to 99 ms (default: 20 ms)
Start bit	1 bit (fixed)
Data bit	8 bit (fixed)
Parity bit	None (default) , Odd, Even
Stop bit	1 bit, 2 bit (default)

- When changing the setting value related to communication interface, reboot the device for normal operation.
- It is not allowed to set overlapping communication address at the same communication line.
- It is recommended to use Autonics communication converter. Please use twisted pair wire, which is suitable for RS485 communication.

■ Address

Set the communication address with the communication address setting switch (SW1, default: 1) and communication address group switch (SW2, default: +0).

- When setting as 0, it does not operate communication.

SW1																
SW2	0	1	2	3	4	5	6	7	8	9	A	B	C	D	E	F
■ +0	08	01	02	03	04	05	06	07	08	09	10	11	12	13	14	15
■ +16	16	17	18	19	20	21	22	23	24	25	26	27	28	29	30	31

Connections

■ TM2

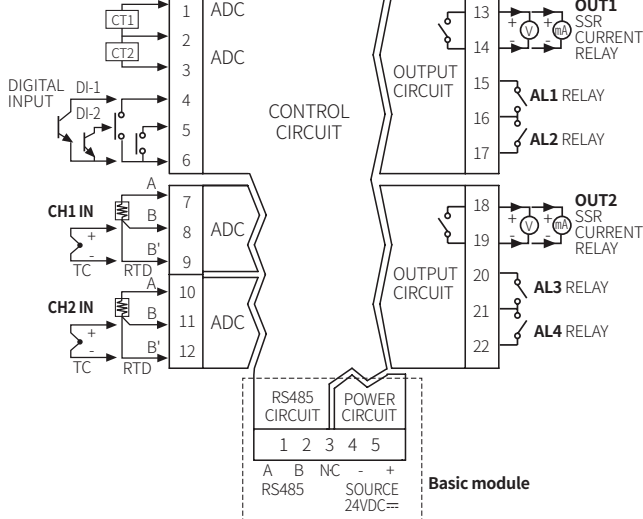

■ TM4

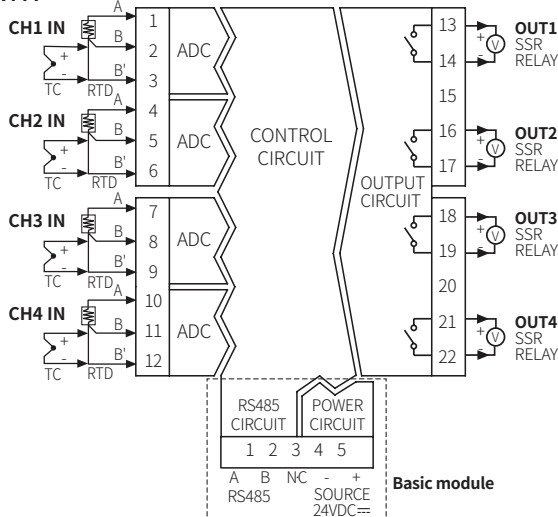

Crimp Terminal Specifications

- Unit: mm, Use the crimp terminal of follow shape.

■ Wire ferrule

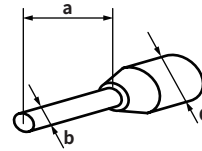

Terminal number	a	b	c
1 to 12	10	≤ 1.7	≤ 3.7
13 to 22	10	≤ 2.1	≤ 4.2

Installation Method

■ Connection between modules

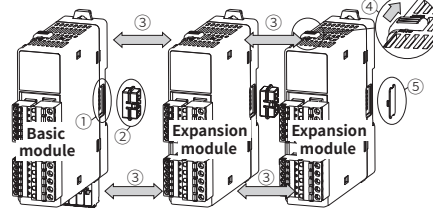

- Remove END cover (①) of each module (except END cover of the first and last module).
- Insert side connector (②) and connect them tightly to ③ direction (max. 30 units).
- Press lock switch (④) to lock direction.

- Supply adequate power for power input specifications and overall capacity.
(Max. power when connecting 31 modules:
31 units × 5 W = 155 W)

■ Connector

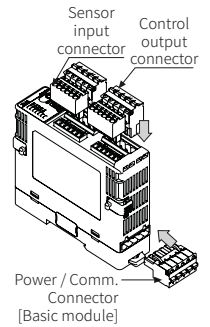

■ Mounting with bolts

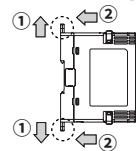

- Pull the rail lock at the top and bottom of the module to ① direction.
- Insert M4 bolts to ② direction and fix it on rail lock.
(Tightening torque: 0.5 to 0.9 N m)

■ Mounting on DIN rail

- Installation

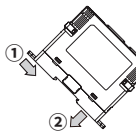

- Hang the top rail lock to DIN rail.
- Push to ① direction and press to ② direction.

- Separation

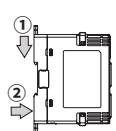

- Press the module to ① direction.
- Keep it pressed and pull it to ② direction.

■ Precautions

- Install the module vertically.
- Use end plates (sold separately, not available from Autonics) to fix firmly.

Errors

■ Indicator

Name	Status	Color	Description	Troubleshooting
PWR	ON	Red	□ channel error: Input < Input range, Input > Input range, Input sensor is open or not connected, Sensor internal communication error	When the error factor is resolved, it automatically returns to normal operation.
CH□	Flash ⁰¹⁾	Red		

01) Cycle: 0.5 sec

■ Communication output, DAQMaster

Communication output (decimal)	DAQMaster	Description	Troubleshooting
'31000'	Display 'OPEN'	Input sensor is open or not connected	When the error factor is resolved, it automatically returns to normal operation.
'30000'	Display 'HHHH' ⁰¹⁾	Input > Input range	
'-30000'	Display 'LLLL' ⁰¹⁾	Input < Input range	
'31500'	Display '31500'	Sensor internal communication error	Check the power supply (24VDC=). ⁰²⁾

01) When HHHH / LLLL error occurs, the control output may occur by recognizing the maximum or minimum input depending on the control type. Please be careful.

02) This error may occur when connecting only the loader port.

Unit Descriptions

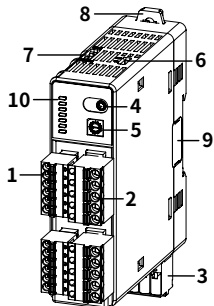

7. Lock switch

Used for fixing modules at top and bottom.

8. Rail lock

Used for installing at DIN rail or using bolts.

9. END cover

Remove it when connecting each module to connect an side connector for expansion.

10. Indicator

TM2

Indicator	Status	Initial power ON ⁰¹⁾	Control output	Auto tuning ⁰²⁾	Alarm output			
					N.O.	ON	N.C.	ON
PWR (Green) ⁰³⁾	ON	ON	ON					
CH1 (Red)	Flash (4,800 bps)	ON	Flash					
CH2 (Red)	Flash (9,600 bps)	ON	Flash					
AL1 (Yellow)	Flash (19,200 bps)	ON ⁰⁴⁾	OFF	OFF	ON	OFF	ON	ON
AL2 (Yellow)	Flash (38,400 bps)	ON ⁰⁵⁾	OFF	OFF	ON	OFF	ON	ON
AL3 (Yellow)	Flash (57,600 bps)	-	OFF	OFF	ON	OFF	ON	ON
AL4 (Yellow)	Flash (115,200 bps)	-	OFF	OFF	ON	OFF	ON	ON

TM4

Indicator	Status	Initial power ON ⁰¹⁾	Control output	Auto tuning ⁰²⁾
CH1 (Red)	Flash (4,800 bps)	ON	Flash	
CH2 (Red)	Flash (9,600 bps)	ON	Flash	
CH3 (Red)	Flash (19,200 bps)	ON	Flash	
CH4 (Red)	Flash (38,400 bps)	ON	Flash	
- (Yellow)	Flash (57,600 bps)	-	OFF	
- (Yellow)	Flash (115,200 bps)	-	OFF	

01) When power is supplied initially, the set communication speed LED flashes at 1 sec cycle for 5 sec.

02) The auto tuning CH LED flashes at 1 sec cycle in turn.

03) The PWR LED flashes during communication at 1 sec cycle in turn.

04) Turns ON when CH1 control method is heating & cooling control and cooling output occurs. (disable AL1 setting)

05) Turns ON when CH2 control method is heating & cooling control and cooling output occurs. (disable AL2 setting)

1. Sensor input connector

2. Control output connector

3. Power/Comm. Terminal (Basic module)

Refer to 'Connections' for the detail description about connector and terminal.

4. PC loader port

For serial communication between one module and PC to set parameter and monitoring by using communication converter.

5. Communication address setting switch (SW1)

6. Communication address group switch (SW2)

When setting the communication address over 16, select +16.

Sold Separately: Current Transformer (CT)

• Unit: mm

• The current for above CTs is 50A same but inner hole sizes are different. Please use this for your environment.

• Do not supply primary current in case that CT output is open. High voltage will be generated in CT output.

CSTC-E80LN

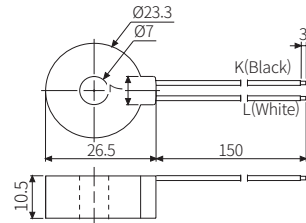

- Max. load current: 80A (50/60Hz)
- Current ratio: 1/1000
- Wire wounded resistance: $31\Omega \pm 10\%$

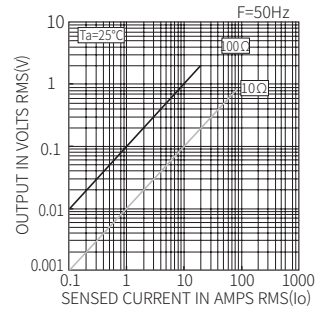

CSTC-E200LN

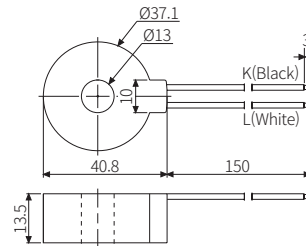

- Max. load current: 200A (50/60Hz)
- Current ratio: 1/1000
- Wire wounded resistance: $20\Omega \pm 10\%$

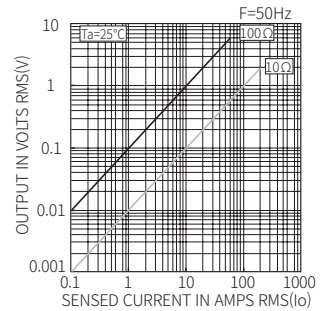

CSTS-E80PP

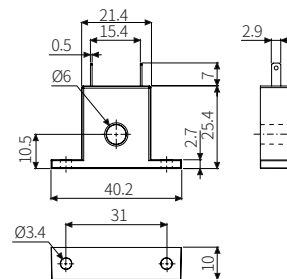

- Max. load current: 80A (50/60Hz)
- Current ratio: 1/1000
- Wire wounded resistance: $31\Omega \pm 10\%$

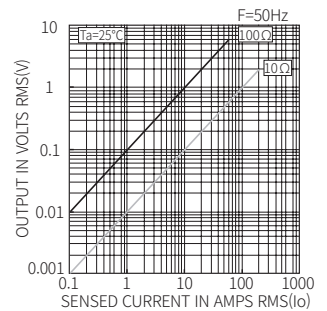

X-ON Electronics

Largest Supplier of Electrical and Electronic Components

Click to view similar products for [Temperature Controllers](#) category:

Click to view products by [Autonics](#) manufacturer:

Other Similar products are found below :

[E5C4Q40J999FAC120](#) [E5GNR03PFLKAC100240](#) [E53-Q3](#) [E5DC-RX2DSM-002](#) [E5LD-6C AC100V](#) [E5AN-HPRR2BM-500 AC100-240](#)
[E5AR-C4B AC100-240](#) [NX-TS2201](#) [E5GC-QX1D6M-015](#) [E5AN-HTAA3BFMD-500AC/DC24](#) [E5GC-QX2ACM-015](#) [NX-TS3102](#) [TK4W-](#)
[22RN](#) [TK4W-T4RN](#) [TK4H-24CN](#) [SCL250D-EM010](#) [AR663.B/P/P/P/WA/RS485](#) [AR663.B/P/P/S/WA](#) [TK4W-14RR](#) [ZAD-IP67](#)
[AR663.B/P/P/P/WU](#) [SCL13L-EM000](#) [2918121116021](#) [2918041110021](#) [2918121110021](#) [2924121106321](#) [TK4M-12CN](#) [TK4H-T4RN](#)
[TK4M-24CN](#) [AR663.B/P/P/P/WA](#) [AR662.B/P/P/P/WA](#) [TK4H-B4CN](#) [TK4H-A4RC](#) [2924161106321](#) [TK4M-24RR](#) [TM4-N2RE](#) [TM4-N2SE](#)
[SCL250L-EM010](#) [2918121106321](#) [E53-R](#) [E53-CN03N2](#) [E5EC-QX4DBM-000](#) [2897952](#) [E5DCQX2DSM-017](#) [E5DCCX2ASM-016](#)
[E5DCCX0ASM-015](#) [E5DCQX2DSM-002](#) [EJ1N-TC4A](#) [AKT7211100](#) [AR247/1/P/P/P/WA](#)