



SELECTION GUIDE

LED Solutions

High Brightness LEDs, Indicators
and Displays



broadcom.com

Broadcom is one of the largest producers of visible light-emitting diodes in the world.

Broadcom offers “one-stop shopping” with its wide array of LED (Light Emitting Diodes) Solutions. With our large manufacturing base and many years of experience from our HP and Agilent days, we are one of the largest producers of visible LEDs in the world and ships billions of products annually.

Broadcom employs the latest in material and process technology to produce superior LEDs. Our highly acclaimed AlInGaP (aluminium indium gallium phosphide) LED material offers high brightness and stable light output over thousands of hours with excellent meantime-before-failure (MTBF). With our cutting edge LED technology, our solution also offers dazzling blue and green colors with InGaN (indium gallium nitride) material, and very cost-effective GaP (gallium phosphide) based technology, perfect for low to moderate light output. Broadcom's LEDs create brilliant lights with rich life-like colors for our customers' applications which are longer lasting and at a globally competitive price. They are suitable for almost any applications that customers need today with wide selection of viewing and package options.

Key products range from high brightness and high power LEDs, surface mount lamps, PLCC surface mount LEDs, to standard brightness through-hole lamps, chip LEDs, flash LEDs and various LED displays. These LED Solutions address a wide range of markets, including electronic sign and signal, automotive, solid-state lighting, consumer electronics, home and mobile appliances.

For virtually all established and emerging applications, Broadcom has the right LED Solutions to meet your design requirements.

High Brightness LEDs

- 3** High Brightness Through-hole Lamps
- 15** High Brightness SMT Lamps
- 19** Surface Mount
- 41** Mini PLCC-2 Surface Mount LEDs
- 44** Envisium Surface Mount Power PLCC-4 LEDs
- 47** High Power LEDs
- 52** Moonstone® High Power LEDs
- 55** 1W 3030 High Power LEDs
- 57** 1W Tri-color High Power LEDs
- 58** 3W Tri-color High Power LEDs

LED Indicators and Displays

- 63** Standard Through-hole Lamps
- 70** Subminiature Lamps
- 74** Surface Mount Chip LEDs
- 87** Auto Focus Auxiliary Flash LEDs
- 90** Seven-Segment Displays
- 118** Light Bars and Bar Graph Arrays
- 122** Smart Displays

High Brightness Through-hole Lamps

Description

Broadcom offers two types of technology based LEDs AllnGaP and InGaN which are suitable for high brightness needs. Through Hole LEDs are offered in 4 mm and 5 mm package.

These devices are casted using advance optical grade epoxy, which provides superior high temperature performance and excellent moisture resistance.

These High Brightness Through Hole LEDs are suitable for application in traffic management, solar powered variable message signs and commercial outdoor advertising video displays.

Benefits

- Excellent product quality and reliability
- Wide range of products
- Competitive pricing
- Wide operating temperature range
- Low power consumption
 - High efficiency, low drive currents and low driving voltages required
- Colors available for AllnGaP LED lamps:
 - Red (626nm), Red Orange (615nm), Orange (605nm) and Amber (590nm)
- Colors available for InGaN LED lamps:
 - Blue (470nm), Green (525nm)
- Packaging options
 - Bulk
 - Ammopack

Applications

- Electronic signs and signals
 - Traffic signal
 - Variable message sign
 - Pedestrian signal
 - Work zone warning
 - Lights
- Solar powered sign
- Commercial Outdoor
- Advertising
 - Full color sign
 - Mono color sign



High Brightness 5mm Round LED Lamp

| Part Number | Color | Dominant Wavelength (nm) | Viewing Angle (°) | Standoff (Yes/NO) | Luminous Intensity (mcd) @ 20 mA | | Package Drawing |
|-----------------------------|------------|--------------------------|-------------------|-------------------|----------------------------------|-------|-----------------|
| | | | | | Min. | Max. | |
| 5 mm Round LED Lamps | | | | | | | |
| 8° Viewing Angle | | | | | | | |
| HLMP-EG08-X1000 | Red | 626 | 8 | No | 7200 | 21000 | A |
| HLMP-EG10-X1000 | Red | 626 | 8 | Yes | 7200 | 21000 | B |
| HLMP-EH08-Y2000 | Red-Orange | 615 | 8 | No | 9300 | 27000 | A |
| HLMP-EH10-Y2000 | Red-Orange | 615 | 8 | Yes | 9300 | 27000 | B |
| HLMP-EJ08-X1000 | Orange | 605 | 8 | No | 7200 | 21000 | A |
| HLMP-EJ10-X1000 | Orange | 605 | 8 | Yes | 7200 | 21000 | B |
| HLMP-EL08-X1000 | Amber | 590 | 8 | No | 7200 | 21000 | A |
| HLMP-EL10-X1000 | Amber | 590 | 8 | Yes | 7200 | 21000 | B |
| 5mm Round LED Lamps | | | | | | | |
| 15° Viewing Angle | | | | | | | |
| HLMP-EG1G-Y10DD | Red | 626 | 15 | No | 9300 | 21000 | A |
| HLMP-EG1H-Y10DD | Red | 626 | 15 | Yes | 9300 | 21000 | B |
| HLMP-EG1A-Z10DD | Red | 626 | 15 | No | 12000 | 21000 | A |
| HLMP-EG1B-Z10DD | Red | 626 | 15 | Yes | 12000 | 21000 | B |
| HLMP-EG1S-Z20DD | Red | 621 | 15 | No | 12000 | 27000 | A |
| HLMP-EG1T-Z20DD | Red | 621 | 15 | Yes | 12000 | 27000 | B |
| HLMP-EH1A-Z10DD | Red-Orange | 615 | 15 | No | 12000 | 21000 | A |
| HLMP-EH1B-Z10DD | Red-Orange | 615 | 15 | Yes | 12000 | 21000 | B |
| HLMP-EL1G-Y10DD | Amber | 590 | 15 | No | 9300 | 21000 | A |
| HLMP-EL1H-Y10DD | Amber | 590 | 15 | Yes | 9300 | 21000 | B |
| HLMP-EL1A-Z1KDD | Amber | 590 | 15 | No | 12000 | 21000 | A |
| HLMP-EL1B-Z1KDD | Amber | 590 | 15 | Yes | 12000 | 21000 | B |
| HLMP-EL1S-Z20DD | Amber | 590 | 15 | No | 12000 | 27000 | A |
| HLMP-EL1S-Z2KDD | Amber | 590 | 15 | No | 12000 | 27000 | A |
| HLMP-EL1S-Z2LDD | Amber | 590 | 15 | No | 12000 | 27000 | A |
| HLMP-EL1T-Z20DD | Amber | 590 | 15 | Yes | 12000 | 27000 | B |
| HLMP-EL1T-Z2KDD | Amber | 590 | 15 | Yes | 12000 | 27000 | B |
| HLMP-EL1T-Z2LDD | Amber | 590 | 15 | Yes | 12000 | 27000 | B |
| HLMP-CB1G-XZ0DD | Blue | 470 | 15 | No | 7200 | 16000 | C |
| HLMP-CB1H-XZ0DD | Blue | 470 | 15 | Yes | 7200 | 16000 | D |
| HLMP-CB1A-XY0DD | Blue | 470 | 15 | No | 7200 | 12000 | C |
| HLMP-CB1A-XYBDD | Blue | 470 | 15 | No | 7200 | 12000 | C |
| HLMP-CB1A-XYCDD | Blue | 470 | 15 | No | 7200 | 12000 | C |
| HLMP-CB1B-XY0DD | Blue | 470 | 15 | Yes | 7200 | 12000 | D |
| HLMP-CB1B-XYBDD | Blue | 470 | 15 | Yes | 7200 | 12000 | D |
| HLMP-CB1B-XYCDD | Blue | 470 | 15 | Yes | 7200 | 12000 | D |
| HLMP-CM1G-350DD | Green | 525 | 15 | No | 27000 | 59000 | C |
| HLMP-CM1H-350DD | Green | 525 | 15 | Yes | 27000 | 59000 | D |
| HLMP-CM1A-560DD | Green | 525 | 15 | No | 45000 | 76000 | C |
| HLMP-CM1B-560DD | Green | 525 | 15 | Yes | 45000 | 76000 | D |

High Brightness 5mm Round LED Lamp

| Part Number | Color | Dominant Wavelength (nm) | Viewing Angle (°) | Standoff (Yes/NO) | Luminous Intensity (mcd) @ 20 mA | | Package Drawing |
|--------------------------|------------|--------------------------|-------------------|-------------------|----------------------------------|-------|-----------------|
| | | | | | Min. | Max. | |
| 15° Viewing Angle | | | | | | | |
| HLMP-CE17-240DD | Cyan | 505 | 15 | No | 21000 | 45000 | C |
| HLMP-CE17-24CDD | Cyan | 505 | 15 | No | 21000 | 45000 | C |
| HLMP-CE17-24QDD | Cyan | 505 | 15 | No | 21000 | 45000 | C |
| HLMP-CE18-240DD | Cyan | 505 | 15 | Yes | 21000 | 45000 | D |
| HLMP-CE18-24CDD | Cyan | 505 | 15 | Yes | 21000 | 45000 | D |
| HLMP-CE18-24QDD | Cyan | 505 | 15 | Yes | 21000 | 45000 | D |
| 23° Viewing Angle | | | | | | | |
| HLMP-EG2G-XZ0DD | Red | 626 | 23 | No | 7200 | 16000 | A |
| HLMP-EG2H-XZ0DD | Red | 626 | 23 | Yes | 7200 | 16000 | B |
| HLMP-EG2S-XZ0DD | Red | 621 | 23 | No | 7200 | 16000 | A |
| HLMP-EG2T-XZ0DD | Red | 621 | 23 | Yes | 7200 | 16000 | B |
| HLMP-EG2U-Z10DD | Red | 622 | 23 | No | 12000 | 21000 | A |
| HLMP-EG2V-Z10DD | Red | 622 | 23 | Yes | 12000 | 21000 | B |
| HLMP-EG2A-XY0DD | Red | 626 | 23 | No | 7200 | 12000 | A |
| HLMP-EG2B-XY0DD | Red | 626 | 23 | Yes | 7200 | 12000 | B |
| HLMP-EH2A-YZ0DD | Red-Orange | 615 | 23 | No | 9300 | 12000 | A |
| HLMP-EH2B-YZ0DD | Red-Orange | 615 | 23 | Yes | 9300 | 12000 | B |
| HLMP-EL2G-WY0DD | Amber | 590 | 23 | No | 5500 | 12000 | A |
| HLMP-EL2H-WY0DD | Amber | 590 | 23 | Yes | 5500 | 12000 | B |
| HLMP-EL2A-YZKDD | Amber | 590 | 23 | No | 9300 | 16000 | A |
| HLMP-EL2B-XYKDD | Amber | 590 | 23 | Yes | 7200 | 12000 | B |
| HLMP-EL2S-XZ0DD | Amber | 590 | 23 | No | 7200 | 16000 | A |
| HLMP-EL2S-XZKDD | Amber | 590 | 23 | No | 7200 | 16000 | A |
| HLMP-EL2S-XZLDD | Amber | 590 | 23 | No | 7200 | 16000 | A |
| HLMP-EL2T-XZ0DD | Amber | 590 | 23 | Yes | 7200 | 16000 | B |
| HLMP-EL2T-XZKDD | Amber | 590 | 23 | Yes | 7200 | 16000 | B |
| HLMP-EL2T-XZLDD | Amber | 590 | 23 | Yes | 7200 | 16000 | B |
| HLMP-EL2U-Z10DD | Amber | 590 | 23 | No | 12000 | 21000 | A |
| HLMP-EL2U-Z1KDD | Amber | 590 | 23 | No | 12000 | 21000 | A |
| HLMP-EL2U-Z1LDD | Amber | 590 | 23 | No | 12000 | 21000 | A |
| HLMP-EL2V-Z10DD | Amber | 590 | 23 | Yes | 12000 | 21000 | B |
| HLMP-EL2V-Z1KDD | Amber | 590 | 23 | Yes | 12000 | 21000 | B |
| HLMP-EL2V-Z1LDD | Amber | 590 | 23 | Yes | 12000 | 21000 | B |



























High Brightness 5mm Round LED Lamp

| Part Number | Color | Dominant Wavelength (nm) | Viewing Angle (°) | Standoff (Yes/NO) | Luminous Intensity (mcd) @ 20 mA | | Package Drawing |
|--------------------------|------------|--------------------------|-------------------|-------------------|----------------------------------|-------|-----------------|
| | | | | | Min. | Max. | |
| 23° Viewing Angle | | | | | | | |
| HLMP-CB2G-UW0DD | Blue | 470 | 23 | No | 3200 | 7200 | C |
| HLMP-CB2H-UW0DD | Blue | 470 | 23 | Yes | 3200 | 7200 | D |
| HLMP-CB2A-VW0DD | Blue | 470 | 23 | No | 4200 | 7200 | C |
| HLMP-CB2A-VWBDD | Blue | 470 | 23 | No | 4200 | 7200 | C |
| HLMP-CB2A-VWCDD | Blue | 470 | 23 | No | 4200 | 7200 | C |
| HLMP-CB2B-VW0DD | Blue | 470 | 23 | Yes | 4200 | 7200 | D |
| HLMP-CB2B-VWBDD | Blue | 470 | 23 | Yes | 4200 | 7200 | D |
| HLMP-CB2B-VWCDD | Blue | 470 | 23 | Yes | 4200 | 7200 | D |
| HLMP-CM2G-130DD | Green | 525 | 23 | No | 16000 | 35000 | C |
| HLMP-CM2H-130DD | Green | 525 | 23 | Yes | 16000 | 35000 | D |
| HLMP-CM2A-230DD | Green | 525 | 23 | No | 21000 | 35000 | C |
| HLMP-CM2B-230DD | Green | 525 | 23 | Yes | 21000 | 35000 | D |
| HLMP-CE20-Z20DD | Cyan | 505 | 23 | No | 12000 | 27000 | C |
| HLMP-CE20-Z2CDD | Cyan | 505 | 23 | No | 12000 | 27000 | C |
| HLMP-CE20-Z2QDD | Cyan | 505 | 23 | No | 12000 | 27000 | C |
| HLMP-CE21-Z20DD | Cyan | 505 | 23 | Yes | 12000 | 27000 | D |
| HLMP-CE21-Z2CDD | Cyan | 505 | 23 | Yes | 12000 | 27000 | D |
| HLMP-CE21-Z2QDD | Cyan | 505 | 23 | Yes | 12000 | 27000 | D |
| 30° Viewing Angle | | | | | | | |
| HLMP-EG3G-VX0DD | Red | 626 | 30 | No | 4200 | 9300 | A |
| HLMP-EG3H-VX0DD | Red | 626 | 30 | Yes | 4200 | 9300 | B |
| HLMP-EG3S-VX0DD | Red | 621 | 30 | No | 4200 | 9300 | A |
| HLMP-EG3T-VX0DD | Red | 621 | 30 | Yes | 4200 | 9300 | B |
| HLMP-EG3A-WX0DD | Red | 626 | 30 | No | 5500 | 9300 | A |
| HLMP-EG3B-WX0DD | Red | 626 | 30 | Yes | 5500 | 9300 | B |
| HLMP-EG3U-XY0DD | Red | 622 | 30 | No | 7200 | 12000 | A |
| HLMP-EG3V-XY0DD | Red | 622 | 30 | Yes | 7200 | 12000 | B |
| HLMP-EH3A-WX0DD | Red-Orange | 615 | 30 | No | 5500 | 9300 | A |
| HLMP-EH3B-WX0DD | Red-Orange | 615 | 30 | Yes | 5500 | 9300 | B |

High Brightness 5mm Round LED Lamp

| Part Number | Color | Dominant Wavelength (nm) | Viewing Angle (°) | Standoff (Yes/NO) | Luminous Intensity (mcd) @ 20 mA | | Package Drawing |
|--------------------------|-------|--------------------------|-------------------|-------------------|----------------------------------|-------|-----------------|
| | | | | | Min. | Max. | |
| 30° Viewing Angle | | | | | | | |
| HLMP-EL3G-VX0DD | Amber | 590 | 30 | No | 4200 | 9300 | A |
| HLMP-EL3H-VX0DD | Amber | 590 | 30 | Yes | 4200 | 9300 | B |
| HLMP-EL3A-WXKDD | Amber | 590 | 30 | No | 5500 | 9300 | A |
| HLMP-EL3B-WXKDD | Amber | 590 | 30 | Yes | 5500 | 9300 | B |
| HLMP-EL3S-VX0DD | Amber | 590 | 30 | No | 4200 | 9300 | A |
| HLMP-EL3S-VXKDD | Amber | 590 | 30 | No | 4200 | 9300 | A |
| HLMP-EL3S-VXLDD | Amber | 590 | 30 | No | 4200 | 9300 | A |
| HLMP-EL3T-VX0DD | Amber | 590 | 30 | Yes | 4200 | 9300 | B |
| HLMP-EL3T-VXKDD | Amber | 590 | 30 | Yes | 4200 | 9300 | B |
| HLMP-EL3T-VXLDD | Amber | 590 | 30 | Yes | 4200 | 9300 | B |
| HLMP-EL3U-XY0DD | Amber | 590 | 30 | No | 7200 | 12000 | A |
| HLMP-EL3U-XYKDD | Amber | 590 | 30 | No | 7200 | 12000 | A |
| HLMP-EL3U-XYLDD | Amber | 590 | 30 | No | 7200 | 12000 | A |
| HLMP-EL3V-XY0DD | Amber | 590 | 30 | Yes | 7200 | 12000 | B |
| HLMP-EL3V-XYKDD | Amber | 590 | 30 | Yes | 7200 | 12000 | B |
| HLMP-EL3V-XYLDD | Amber | 590 | 30 | Yes | 7200 | 12000 | B |
| HLMP-CB3G-TV0DD | Blue | 470 | 30 | No | 2500 | 5500 | C |
| HLMP-CB3H-TV0DD | Blue | 470 | 30 | Yes | 2500 | 5500 | D |
| HLMP-CB3A-UV0DD | Blue | 470 | 30 | No | 3200 | 5500 | C |
| HLMP-CB3A-UVBDD | Blue | 470 | 30 | No | 3200 | 5500 | C |
| HLMP-CB3A-UVCDD | Blue | 470 | 30 | No | 3200 | 5500 | C |
| HLMP-CB3B-UV0DD | Blue | 470 | 30 | Yes | 3200 | 5500 | D |
| HLMP-CB3B-UVBDD | Blue | 470 | 30 | Yes | 3200 | 5500 | D |
| HLMP-CB3B-UVCDD | Blue | 470 | 30 | Yes | 3200 | 5500 | D |
| HLMP-CM3G-Y10DD | Green | 525 | 30 | No | 9300 | 21000 | C |
| HLMP-CM3H-Y10DD | Green | 525 | 30 | Yes | 9300 | 21000 | D |
| HLMP-CM3A-Z10DD | Green | 525 | 30 | No | 12000 | 21000 | C |
| HLMP-CM3A-Z1BDD | Green | 525 | 30 | No | 12000 | 21000 | C |
| HLMP-CM3A-Z1CDD | Green | 525 | 30 | No | 12000 | 21000 | C |
| HLMP-CM3B-Z10DD | Green | 525 | 30 | Yes | 12000 | 21000 | D |
| HLMP-CM3B-Z1BDD | Green | 525 | 30 | Yes | 12000 | 21000 | D |
| HLMP-CM3B-Z1CDD | Green | 525 | 30 | Yes | 12000 | 21000 | D |
| HLMP-CE32-Y10DD | Cyan | 505 | 30 | No | 9300 | 21000 | C |
| HLMP-CE32-Y1CDD | Cyan | 505 | 30 | No | 9300 | 21000 | C |
| HLMP-CE32-Y1QDD | Cyan | 505 | 30 | No | 9300 | 21000 | C |
| HLMP-CE33-Y10DD | Cyan | 505 | 30 | Yes | 9300 | 21000 | D |
| HLMP-CE33-Y1CDD | Cyan | 505 | 30 | Yes | 9300 | 21000 | D |
| HLMP-CE33-Y1QDD | Cyan | 505 | 30 | Yes | 9300 | 21000 | D |

High Brightness Oval LED Lamp

| Part Number | Color | Dominant Wavelength (nm) | Viewing Angle (°) | Standoff (Yes/NO) | Luminous Intensity (mcd) @ 20 mA | | Lead Frame Orientation | Package Drawing | Remarks |
|------------------------------------|---|--------------------------|-------------------|-------------------|----------------------------------|------|------------------------|-----------------|---------------------------------|
| | | | | | Min. | Max. | | | |
| 4 mm Standard Oval LED Lamp | | | | | | | | | |
| 42° x 95° Viewing Angle | | | | | | | | | |
| HLMP-LG3V-WX0DD |  Red | 621 | 42 x 95 | Yes | 1380 | 1990 | Parallel | E | For full color sign application |
| HLMP-LM3V-24PDD |  Green | 525 | 42 x 95 | Yes | 3500 | 6050 | Parallel | E | |
| HLMP-LB3V-TV0DD |  Blue | 468 | 42 x 95 | Yes | 800 | 1380 | Parallel | E | |
| 45° x 90° Viewing Angle | | | | | | | | | |
| HLMP-LG3Y-Y10DD |  Red | 621 | 45 x 90 | Yes | 1990 | 3500 | Parallel | E | For full color sign application |
| HLMP-LM3Y-35PDD |  Green | 525 | 45 x 90 | Yes | 4200 | 7260 | Parallel | E | |
| HLMP-LM3U-46PDD |  Green | 525 | 45 x 90 | Yes | 5040 | 8710 | Parallel | E | |
| HLMP-LB3Y-VW0DD |  Blue | 468 | 45 x 90 | Yes | 1150 | 1660 | Parallel | E | |
| 60° x 110° Viewing Angle | | | | | | | | | |
| HLMP-LG3W-VW0DD |  Red | 621 | 50 x 105 | Yes | 1150 | 1660 | Parallel | E | For full color sign application |
| HLMP-LM3W-12PDD |  Green | 525 | 60 x 110 | Yes | 2900 | 4200 | Parallel | E | |
| HLMP-LB3W-STPDD |  Blue | 468 | 60 x 110 | Yes | 660 | 960 | Parallel | E | |
| 50° x 100° Viewing Angle | | | | | | | | | |
| HLMP-LH65-XY0DD |  Red Orange | 615 | 50x100 | Yes | 1660 | 2400 | Parallel | E | For mono color sign application |
| HLMP-LL65-XYKDD |  Amber | 590 | 50x100 | Yes | 1660 | 2400 | Parallel | E | |
| 4mm Standard Oval LED Lamp | | | | | | | | | |
| 40° x 100° Viewing Angle | | | | | | | | | |
| HLMP-LG71-VY0DD |  Red | 626 | 40x100 | Yes | 1150 | 2400 | Parallel | E | For full color sign application |
| HLMP-LM71-Z30DD |  Green | 525 | 40x100 | Yes | 2400 | 5040 | Parallel | E | |
| HLMP-LB71-SV0DD |  Blue | 470 | 40x100 | Yes | 660 | 1380 | Parallel | E | |
| HLMP-LG75-XY0DD |  Red | 626 | 40x100 | Yes | 1660 | 2400 | Parallel | E | |
| HLMP-LG73-XZ0DD |  Red | 626 | 40x100 | Yes | 1660 | 2900 | Parallel | E | |
| HLMP-LM75-34CDD |  Green | 530 | 40x100 | Yes | 4200 | 6050 | Parallel | E | |
| HLMP-LM73-35PDD |  Green | 530 | 40x100 | Yes | 4200 | 7260 | Parallel | E | |
| HLMP-LB72-UWPDD |  Blue | 470 | 40x100 | Yes | 960 | 1660 | Parallel | E | |
| 4 mm Super Oval LED Lamp | | | | | | | | | |
| 60° x 120° Viewing Angle | | | | | | | | | |
| HLMP-SL20-MPODD |  Amber | 590 | 60x120 | Yes | 520 | 1150 | Perpendicular | F | For mono color sign application |
| HLMP-RL20-MPODD |  Amber | 590 | 60x120 | Yes | 520 | 1150 | Parallel | G | |
| 5 mm Standard Oval LED Lamp | | | | | | | | | |
| 40° x 100° Viewing Angle | | | | | | | | | |
| HLMP-HG64-WX0DD |  Red | 626 | 40x100 | No | 1380 | 1990 | Parallel | H | For full color sign application |
| HLMP-HG65-WX0DD |  Red | 626 | 40x100 | Yes | 1380 | 1990 | Parallel | I | |
| HLMP-HM64-34BDD |  Green | 525 | 40x100 | No | 4200 | 6050 | Parallel | H | |
| HLMP-HM65-34BDD |  Green | 525 | 40x100 | Yes | 4200 | 6050 | Parallel | I | |

High Brightness Oval LED Lamp

| Part Number | Color | Dominant Wavelength (nm) | Viewing Angle (°) | Standoff (Yes/NO) | Luminous Intensity (mcd) @ 20 mA | | Lead Frame Orientation | Package Drawing | Remarks |
|-----------------|------------|--------------------------|-------------------|-------------------|----------------------------------|------|------------------------|-----------------|---------------------------------|
| | | | | | Min. | Max. | | | |
| HLMP-HG74-XY0DD | Red | 626 | 40x100 | No | 1660 | 2400 | Parallel | H | For full color sign application |
| HLMP-HG75-XY0DD | Red | 626 | 40x100 | Yes | 1660 | 2400 | Parallel | I | |
| HLMP-HM74-34CDD | Green | 530 | 40x100 | No | 4200 | 6050 | Parallel | H | |
| HLMP-HM75-34CDD | Green | 530 | 40x100 | Yes | 4200 | 6050 | Parallel | I | |
| HLMP-HB74-UVCDD | Blue | 470 | 40x100 | No | 960 | 1380 | Parallel | H | |
| HLMP-HB75-UVCDD | Blue | 470 | 40x100 | Yes | 960 | 1380 | Parallel | I | |
| HLMP-HH64-WX0DD | Red Orange | 615 | 40x100 | No | 1380 | 1990 | Parallel | H | |
| HLMP-HH65-WX0DD | Red Orange | 615 | 40x100 | Yes | 1380 | 1990 | Parallel | I | |
| HLMP-HL64-XYKDD | Amber | 590 | 40x100 | No | 1660 | 2400 | Parallel | H | |
| HLMP-HL64-XYLDD | Amber | 590 | 40x100 | No | 1660 | 2400 | Parallel | H | |
| HLMP-HL65-XYKDD | Amber | 590 | 40x100 | Yes | 1660 | 2400 | Parallel | I | |
| HLMP-HL65-XYLDD | Amber | 590 | 40x100 | Yes | 1660 | 2400 | Parallel | I | |
| HLMP-HG70-VX0DD | Red | 626 | 40x100 | No | 1150 | 1990 | Parallel | H | |
| HLMP-HG71-VX0DD | Red | 626 | 40x100 | Yes | 1150 | 1990 | Parallel | I | |
| HLMP-HB70-TVBD | Blue | 470 | 40x100 | No | 800 | 1380 | Parallel | H | |
| HLMP-HB70-TVCD | Blue | 470 | 40x100 | No | 800 | 1380 | Parallel | H | |
| HLMP-HB71-TVBD | Blue | 470 | 40x100 | Yes | 800 | 1380 | Parallel | I | |
| HLMP-HB71-TVCD | Blue | 470 | 40x100 | Yes | 800 | 1380 | Parallel | I | |
| HLMP-HM70-23BD | Green | 525 | 40x100 | No | 3500 | 5040 | Parallel | H | |
| HLMP-HM70-23CD | Green | 525 | 40x100 | No | 3500 | 5040 | Parallel | H | |
| HLMP-HM71-23BD | Green | 525 | 40x100 | Yes | 3500 | 5040 | Parallel | I | |
| HLMP-HM71-23CD | Green | 525 | 40x100 | Yes | 3500 | 5040 | Parallel | I | |
| HLMP-HG7U-XY0DD | Red | 621 | 40x100 | No | 1660 | 2400 | Parallel | H | |
| HLMP-HG7U-XZ0DD | Red | 621 | 40x100 | No | 1660 | 2900 | Parallel | H | |
| HLMP-HG7Y-XY0DD | Red | 621 | 40x100 | Yes | 1660 | 2400 | Parallel | I | |
| HLMP-HG7Y-XZ0DD | Red | 621 | 40x100 | Yes | 1660 | 2900 | Parallel | I | |
| HLMP-HL7U-XYKDD | Amber | 590 | 40x100 | No | 1660 | 2400 | Parallel | H | |
| HLMP-HL7U-XYLDD | Amber | 590 | 40x100 | No | 1660 | 2400 | Parallel | H | |
| HLMP-HL7U-XZKDD | Amber | 590 | 40x100 | No | 1660 | 2900 | Parallel | H | |
| HLMP-HL7U-XZLDD | Amber | 590 | 40x100 | No | 1660 | 2900 | Parallel | H | |
| HLMP-HL7Y-XYKDD | Amber | 590 | 40x100 | Yes | 1660 | 2400 | Parallel | I | |
| HLMP-HL7Y-XYLDD | Amber | 590 | 40x100 | Yes | 1660 | 2400 | Parallel | I | |
| HLMP-HL7Y-XZKDD | Amber | 590 | 40x100 | Yes | 1660 | 2900 | Parallel | I | |
| HLMP-HL7Y-XZLDD | Amber | 590 | 40x100 | Yes | 1660 | 2900 | Parallel | I | |
| HLMP-HM7U-35PDD | Green | 525 | 40x100 | No | 4200 | 7260 | Parallel | H | |
| HLMP-HM7Y-35PDD | Green | 525 | 40x100 | Yes | 4200 | 7260 | Parallel | I | |
| HLMP-HB7U-VXPDD | Blue | 468 | 40x100 | No | 1150 | 1990 | Parallel | H | |

High Brightness Oval LED Lamp

| Part Number | Color | Dominant Wavelength (nm) | Viewing Angle (°) | Standoff (Yes/NO) | Luminous Intensity (mcd) @ 20 mA | | Lead Frame Orientation | Package Drawing | Remarks |
|-------------------------------------|------------|--------------------------|-------------------|-------------------|----------------------------------|------|------------------------|-----------------|---------------------------------|
| | | | | | Min. | Max. | | | |
| 5 mm Standard Oval LED Lamps | | | | | | | | | |
| 40° x 100° Viewing Angle | | | | | | | | | |
| HLMP-HB7Y-VXPDD | Blue | 468 | 40x100 | Yes | 1150 | 1990 | Parallel | I | For mono color sign application |
| 5 mm Mini Oval LED Lamps | | | | | | | | | |
| 30° x 70° Viewing Angle | | | | | | | | | |
| HLMP-AG64-Z10DD | Red | 626 | 30x70 | No | 2400 | 3500 | Parallel | J | For full color sign application |
| HLMP-AG65-Z10DD | Red | 626 | 30x70 | Yes | 2400 | 3500 | Parallel | K | |
| HLMP-AM64-460DD | Green | 525 | 30x70 | No | 5040 | 8710 | Parallel | J | |
| HLMP-AM65-45BDD | Green | 525 | 30x70 | Yes | 5040 | 7260 | Parallel | K | |
| HLMP-AG74-120DD | Red | 626 | 30x70 | No | 2900 | 4200 | Parallel | J | |
| HLMP-AG75-120DD | Red | 626 | 30x70 | Yes | 2900 | 4200 | Parallel | K | |
| HLMP-AM74-56CDD | Green | 530 | 30x70 | No | 6050 | 8710 | Parallel | J | |
| HLMP-AM75-56CDD | Green | 530 | 30x70 | Yes | 6050 | 8710 | Parallel | K | |
| HLMP-AB74-WXBDD | Blue | 470 | 30x70 | No | 1380 | 1990 | Parallel | J | |
| HLMP-AB75-WXBDD | Blue | 470 | 30x70 | Yes | 1380 | 1990 | Parallel | K | |
| HLMP-AH64-Z10DD | Red Orange | 615 | 30x70 | No | 2400 | 3500 | Parallel | J | For mono color sign application |
| HLMP-AH65-Z10DD | Red Orange | 615 | 30x70 | Yes | 2400 | 3500 | Parallel | K | |
| HLMP-AJ66-Z10DD | Orange | 605 | 30x70 | No | 2400 | 3500 | Parallel | J | |
| HLMP-AJ67-Z10DD | Orange | 605 | 30x70 | Yes | 2400 | 3500 | Parallel | K | |
| HLMP-AL64-23KDD | Amber | 590 | 30x70 | No | 3500 | 5040 | Parallel | J | |
| HLMP-AL65-23KDD | Amber | 590 | 30x70 | Yes | 3500 | 5040 | Parallel | K | |
| HLMP-AG70-Z20DD | Red | 626 | 30x70 | No | 2400 | 4200 | Parallel | J | |
| HLMP-AG71-Z20DD | Red | 626 | 30x70 | Yes | 2400 | 4200 | Parallel | K | |
| HLMP-AL70-13KDD | Amber | 590 | 30x70 | No | 2900 | 5040 | Parallel | J | |
| HLMP-AL70-13LDD | Amber | 590 | 30x70 | No | 2900 | 5040 | Parallel | J | |
| HLMP-AL71-13KDD | Amber | 590 | 30x70 | Yes | 2900 | 5040 | Parallel | K | |
| HLMP-AL71-13LDD | Amber | 590 | 30x70 | Yes | 2900 | 5040 | Parallel | K | |
| HLMP-AB70-TWBDD | Blue | 470 | 30x70 | No | 800 | 1660 | Parallel | J | |
| HLMP-AB70-TWCDD | Blue | 470 | 30x70 | No | 800 | 1660 | Parallel | J | |
| HLMP-AB71-TWBDD | Blue | 470 | 30x70 | Yes | 800 | 1660 | Parallel | K | |
| HLMP-AB71-TWCDD | Blue | 470 | 30x70 | Yes | 800 | 1660 | Parallel | K | |
| HLMP-AM70-35BDD | Green | 525 | 30x70 | No | 4200 | 7260 | Parallel | J | |
| HLMP-AM70-35CDD | Green | 525 | 30x70 | No | 4200 | 7260 | Parallel | J | |
| HLMP-AM71-35BDD | Green | 525 | 30x70 | Yes | 4200 | 7260 | Parallel | K | |
| HLMP-AM71-35CDD | Green | 525 | 30x70 | Yes | 4200 | 7260 | Parallel | K | |

High Brightness Lamps

High Brightness LED Lamps 1.3:1
Intensity Bin Limits (mcd at 20mA)

| Bin ID | Min. | Max. |
|--------|-------|-------|
| D | 65 | 85 |
| E | 85 | 110 |
| F | 110 | 140 |
| G | 140 | 180 |
| H | 180 | 240 |
| J | 240 | 310 |
| K | 310 | 400 |
| L | 400 | 520 |
| M | 520 | 680 |
| N | 680 | 880 |
| P | 880 | 1150 |
| Q | 1150 | 1500 |
| R | 1500 | 1900 |
| S | 1900 | 2500 |
| T | 2500 | 3200 |
| U | 3200 | 4200 |
| V | 4200 | 5500 |
| W | 5500 | 7200 |
| X | 7200 | 9300 |
| Y | 9300 | 12000 |
| Z | 12000 | 16000 |
| 1 | 16000 | 21000 |
| 2 | 21000 | 27000 |
| 3 | 27000 | 35000 |
| 4 | 35000 | 45000 |
| 5 | 45000 | 59000 |
| 6 | 59000 | 76000 |

Tolerance for each bin limit is $\pm 15\%$ High Brightness LED Lamps 1.2:1
Intensity Bin Limits (mcd at 20mA)

| Bin ID | Min. | Max. |
|--------|-------|-------|
| P | 380 | 460 |
| Q | 460 | 550 |
| R | 550 | 660 |
| S | 660 | 800 |
| T | 800 | 960 |
| U | 960 | 1150 |
| V | 1150 | 1380 |
| W | 1380 | 1660 |
| X | 1660 | 1990 |
| Y | 1990 | 2400 |
| Z | 2400 | 2900 |
| 1 | 2900 | 3500 |
| 2 | 3500 | 4200 |
| 3 | 4200 | 5040 |
| 4 | 5040 | 6050 |
| 5 | 6050 | 7260 |
| 6 | 7260 | 8710 |
| 7 | 8710 | 10460 |
| 8 | 10460 | 12560 |
| 9 | 12560 | 15100 |

Tolerance for each bin limit is $\pm 15\%$

Color Bin Structure

| Bin ID | Wavelength (nm) | | Remark | |
|--------------------------------|-----------------|-------|--------|--------|
| | Min. | Max. | | |
| Red | | | | |
| -- | 618.0 | 630.0 | Type 1 | |
| -- | 620.0 | 630.0 | Type 2 | |
| Red Orange ¹ | | | | |
| -- | 612.0 | 619.0 | Type 1 | |
| -- | 612.0 | 621.7 | Type 2 | |
| Orange ¹ | | | | |
| 1 | 600.0 | 604.0 | Type 1 | |
| 2 | 604.0 | 608.0 | | |
| 3 | 608.0 | 612.0 | | |
| 2 | 599.5 | 604.5 | Type 2 | |
| 4 | 604.5 | 610.5 | | |
| Amber | | | | |
| 1 | 584.5 | 587.0 | | |
| 2 | 587.0 | 589.5 | | |
| 4 | 589.5 | 592.0 | | |
| 6 | 592.0 | 594.5 | | |
| Green ¹ | | | | |
| 1 | 520.0 | 524.0 | | Type 1 |
| 2 | 524.0 | 528.0 | | |
| 3 | 528.0 | 532.0 | | |
| 4 | 532.0 | 536.0 | | |
| 5 | 536.0 | 540.0 | | |
| 1 | 519.0 | 523.0 | Type 2 | |
| 2 | 523.0 | 527.0 | | |
| 3 | 527.0 | 531.0 | | |
| 4 | 531.0 | 535.0 | | |
| 5 | 535.0 | 539.0 | | |
| Blue | | | | |
| 1 | 460.0 | 464.0 | | |
| 2 | 464.0 | 468.0 | | |
| 3 | 468.0 | 472.0 | | |
| 4 | 472.0 | 476.0 | | |
| 5 | 476.0 | 480.0 | | |

Note 1: There are 2 types of color bin limits. Please refer to individual datasheet for details.Tolerance for each bin limit is $\pm 0.5\text{nm}$

Package Drawings

5 mm Round LED Lamp

A: Non-standoff

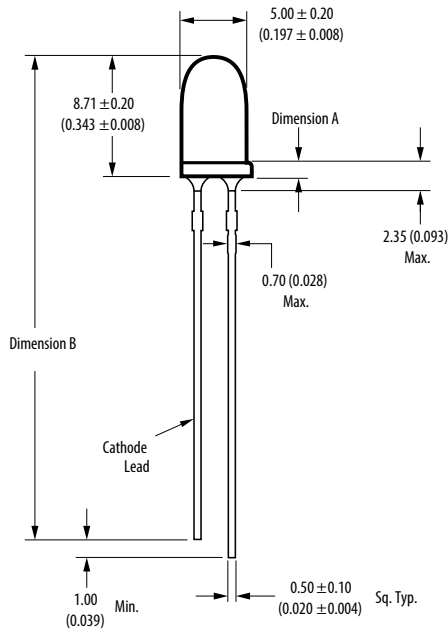

B: Standoff

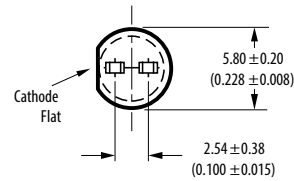
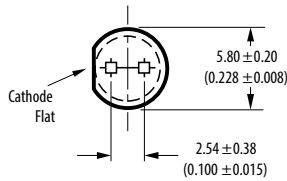
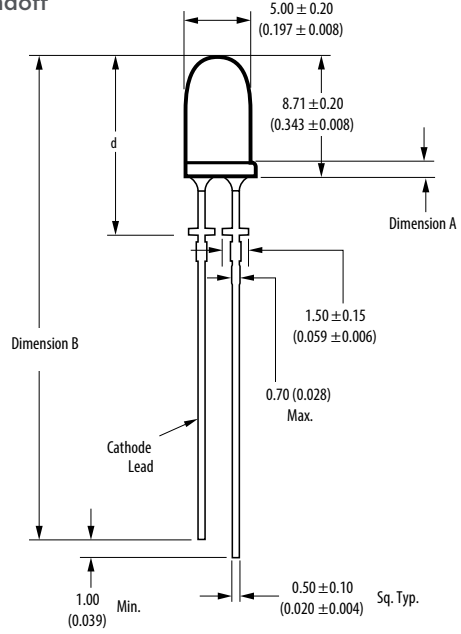

Note:
Please refer to individual datasheet for Dimension A, B and D.

5 mm Round LED Lamp

C: Non-standoff

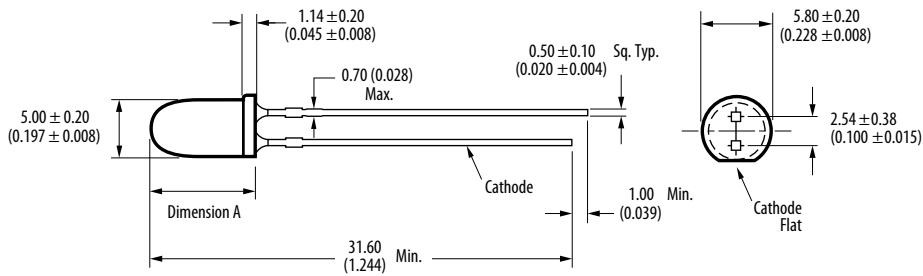

D: Standoff

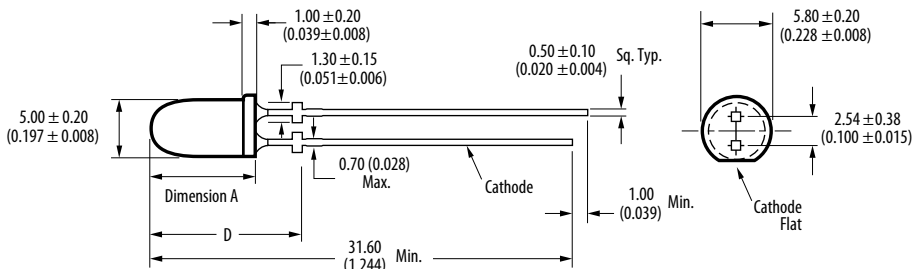

Note:
Please refer to individual datasheet for dimension A and D.

4 mm Standard Oval LED Lamp

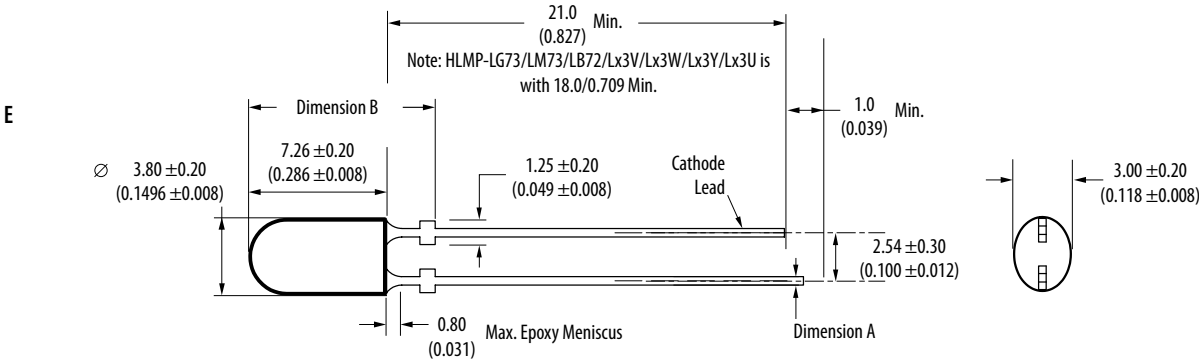

Note:
Please refer to individual datasheet for dimension A and dimension B.

4 mm Super Oval LED Lamp 60° x 120° Viewing Angle

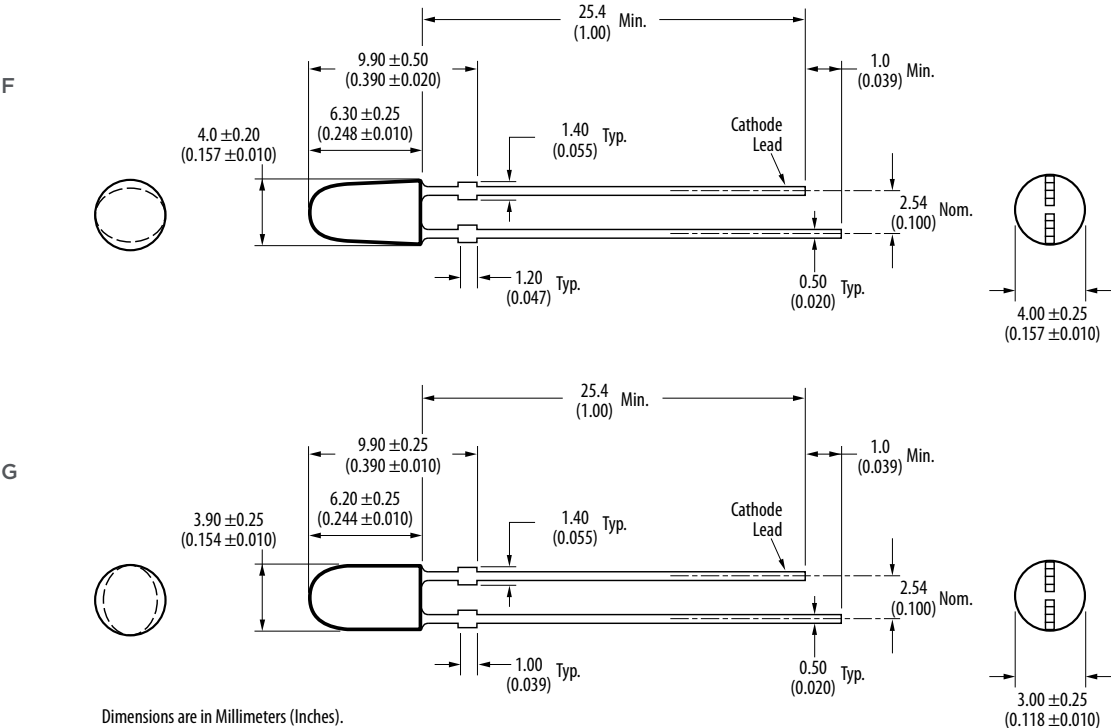

Package Drawings

5 mm Standard Oval LED Lamp 40° x 100° Viewing Angle

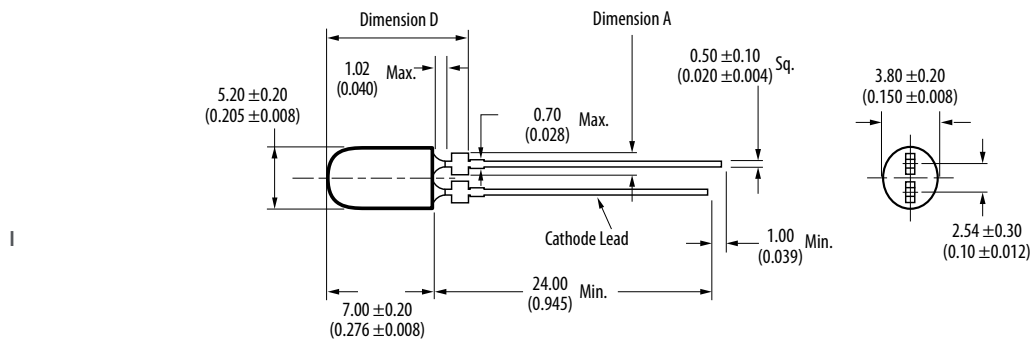
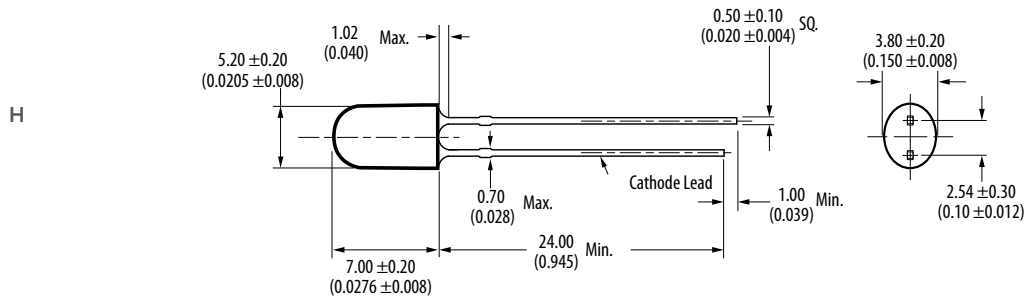

5mm Mini Oval LED Lamp 30° x 70° Viewing Angle

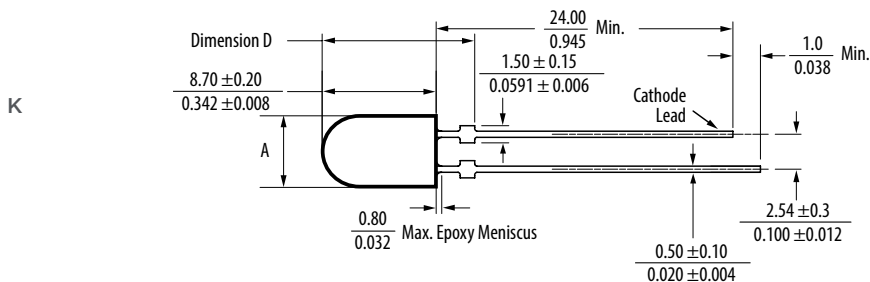
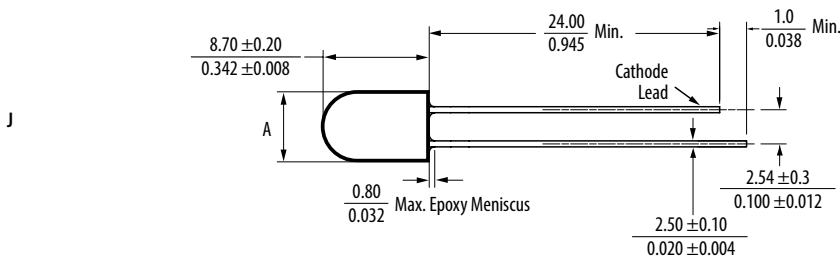

Note:
For all package drawings above, the dimension are in millimeters (inches).
Please refer to individual datasheet for dimension A, B and D.

High Brightness SMT Lamps

Description

Broadcom offers industry's first Surface Mount High Brightness Round and Oval LED lamps for electronic sign application. These SMT lamps are compatible with industrial reflow soldering processes and made with advanced optical grade epoxy to provide superior performance in outdoor application.

Applications

- Electronic signs and signals
 - Traffic signal
 - Variable message signs
 - Full color signs
 - Mono color signs



Benefits

- Compact form factor with well defined spatial radiation pattern
- High Brightness AlInGaP and InGaN material available in Red, Amber, Green and Blue
- Moisture sensitivity level (MSL) 2A compatible with industrial reflow soldering process
- Lens features: Tinted for SMT Round
 - Tinted and diffused for SMT Oval

High Brightness SMT Round and Oval Lamps

| Part Number | Color | Typ. Dominant Wavelength (nm) | Typ. Viewing Angle (°) | Lens Tinted | Lens Diffused | Luminous Intensity (mcd) @ 20 mA | | Package Drawing |
|--------------------------|-------|-------------------------------|------------------------|-------------|---------------|----------------------------------|-------|-----------------|
| | | | | | | Min. | Max. | |
| SMT Round Lamps | | | | | | | | |
| 30° Viewing Angle | | | | | | | | |
| ALMD-EG3D-VX002 | Red | 626 | 30 | Yes | No | 4200 | 9300 | A |
| ALMD-EL3D-VX002 | Amber | 590 | 30 | Yes | No | 4200 | 9300 | |
| ALMD-CM3D-XZ002 | Green | 525 | 30 | Yes | No | 7200 | 16000 | |
| ALMD-CB3D-SU002 | Blue | 470 | 30 | Yes | No | 1900 | 5500 | |
| ALMD-EG3E-VX002 | Red | 626 | 30 | Yes | No | 4200 | 9300 | C |
| ALMD-EL3E-VX002 | Amber | 590 | 30 | Yes | No | 4200 | 9300 | |
| ALMD-CM3E-Y1002 | Green | 525 | 30 | Yes | No | 9300 | 21000 | |
| ALMD-CB3E-SU002 | Blue | 470 | 30 | Yes | No | 1900 | 4200 | |
| ALMD-CM3F-Y1002 | Green | 525 | 30 | Yes | No | 9300 | 21000 | |
| ALMD-CB3F-TV002 | Blue | 470 | 30 | Yes | No | 2500 | 5500 | |

High Brightness SMT Round and Oval Lamps

| Part Number | Color | Typ. Dominant Wavelength (nm) | Typ. Viewing Angle (°) | Lens Tinted | Lens Diffused | Luminous Intensity (mcd) @ 20 mA | | Package Drawing | |
|--------------------------|-------|-------------------------------|------------------------|-------------|---------------|----------------------------------|-------|-----------------|--|
| | | | | | | Min. | Max. | | |
| SMT Round Lamps | | | | | | | | | |
| 23° Viewing Angle | | | | | | | | | |
| ALMD-EG2E-XZ002 | Red | 621 | 23 | Yes | No | 7200 | 16000 | C | |
| ALMD-EL2E-XZ002 | Amber | 590 | 23 | Yes | No | 7200 | 16000 | C | |
| ALMD-EL2E-XZK02 | Amber | 590 | 23 | Yes | No | 7200 | 16000 | C | |
| ALMD-EL2E-XZL02 | Amber | 590 | 23 | Yes | No | 7200 | 16000 | C | |
| ALMD-CM2F-12002 | Green | 525 | 23 | Yes | No | 16000 | 27000 | C | |
| ALMD-CM2F-12B02 | Green | 525 | 23 | Yes | No | 16000 | 27000 | C | |
| ALMD-CM2F-12C02 | Green | 525 | 23 | Yes | No | 16000 | 27000 | C | |
| ALMD-CB2E-UV002 | Blue | 470 | 23 | Yes | No | 3200 | 5500 | C | |
| ALMD-CB2E-UVB02 | Blue | 470 | 23 | Yes | No | 3200 | 5500 | C | |
| ALMD-CB2E-UVC02 | Blue | 470 | 23 | Yes | No | 3200 | 5500 | C | |
| 15° Viewing Angle | | | | | | | | | |
| ALMD-EG1E-Z2002 | Red | 621 | 15 | Yes | No | 12000 | 27000 | C | |
| ALMD-EL1E-Z2002 | Amber | 590 | 15 | Yes | No | 12000 | 27000 | C | |
| ALMD-EL1E-Z2K02 | Amber | 590 | 15 | Yes | No | 12000 | 27000 | C | |
| ALMD-EL1E-Z2L02 | Amber | 590 | 15 | Yes | No | 12000 | 27000 | C | |
| ALMD-CM1F-34002 | Green | 525 | 15 | Yes | No | 27000 | 45000 | C | |
| ALMD-CM1F-34B02 | Green | 525 | 15 | Yes | No | 27000 | 45000 | C | |
| ALMD-CM1F-34C02 | Green | 525 | 15 | Yes | No | 27000 | 45000 | C | |
| ALMD-CB1E-VW002 | Blue | 470 | 15 | Yes | No | 4200 | 7200 | C | |
| ALMD-CB1E-VWB02 | Blue | 470 | 15 | Yes | No | 4200 | 7200 | C | |
| ALMD-CB1E-VWC02 | Blue | 470 | 15 | Yes | No | 4200 | 7200 | C | |

High Brightness SMT Round and Oval Lamps

| Part Number | Color | Typ. Dominant Wavelength (nm) | Typ. Viewing Angle (°) | Lens Tinted | Lens Diffused | Luminous Intensity (mcd) @ 20 mA | | Package Drawing |
|---------------------------------|-------|-------------------------------|------------------------|-------------|---------------|----------------------------------|------|-----------------|
| | | | | | | Min. | Max. | |
| SMT Oval Lamps | | | | | | | | |
| 40° × 100° Viewing Angle | | | | | | | | |
| ALMD-LG36-WZ002 | Red | 626 | 40 x 100 | Yes | Yes | 1380 | 2900 | B |
| ALMD-LL36-WZ002 | Amber | 590 | 40 x 100 | Yes | Yes | 1380 | 2900 | |
| ALMD-LM36-14002 | Green | 525 | 40 x 100 | Yes | Yes | 2900 | 6050 | |
| ALMD-LB36-SV002 | Blue | 470 | 40 x 100 | Yes | Yes | 660 | 1380 | |
| ALMD-LG37-XZ002 | Red | 626 | 40 x 100 | Yes | Yes | 1660 | 2900 | D |
| ALMD-LL37-XZ002 | Amber | 590 | 40 x 100 | Yes | Yes | 1660 | 2900 | |
| ALMD-LM37-24002 | Green | 525 | 40 x 100 | Yes | Yes | 3500 | 6050 | |
| ALMD-LB37-SU002 | Blue | 470 | 40 x 100 | Yes | Yes | 660 | 1150 | |
| ALMD-LM38-24002 | Green | 525 | 40 x 100 | Yes | Yes | 3500 | 6050 | |
| ALMD-LB38-TV002 | Blue | 470 | 40 x 100 | Yes | Yes | 800 | 1380 | |

High Brightness SMT Round Lamps
1.3:1 Intensity Bin Limits (mcd at 20mA)

| Bin ID | Min. | Max. |
|--------|-------|-------|
| S | 1900 | 2500 |
| T | 2500 | 3200 |
| U | 3200 | 4200 |
| V | 4200 | 5500 |
| W | 5500 | 7200 |
| X | 7200 | 9300 |
| Y | 9300 | 12000 |
| Z | 12000 | 16000 |
| 1 | 16000 | 21000 |
| 2 | 21000 | 27000 |
| 3 | 27000 | 35000 |
| 4 | 35000 | 45000 |

Tolerance of each bin limit is ± 15%

High Brightness SMT Oval Lamps
1.2:1 Intensity Bin Limits (mcd at 20mA)

| Bin ID | Min. | Max. |
|--------|------|------|
| R | 550 | 660 |
| S | 660 | 800 |
| T | 800 | 960 |
| U | 960 | 1150 |
| V | 1150 | 1380 |
| W | 1380 | 1660 |
| X | 1660 | 1990 |
| Y | 1990 | 2400 |
| Z | 2400 | 2900 |
| 1 | 2900 | 3500 |
| 2 | 3500 | 4200 |
| 3 | 4200 | 5040 |
| 4 | 5040 | 6050 |

Tolerance of each bin limit is ± 15%

Color Bin Structure

| Bin ID | Wavelength (nm) | |
|--------|-----------------|-------|
| | Min. | Max. |
| Red | 618.0 | 630.0 |

Tolerance for each bin limits is ± 0.05nm

| Bin ID | Wavelength (nm) | |
|--------|-----------------|-------|
| | Min. | Max. |
| Amber | | |
| 1 | 584.5 | 587.0 |
| 2 | 587.0 | 589.5 |
| 4 | 589.5 | 592.0 |
| 6 | 592.5 | 594.0 |

Tolerance for each bin limits is ± 0.05nm

| Bin ID | Wavelength (nm) | |
|--------|-----------------|-------|
| | Min. | Max. |
| Green | | |
| 1 | 519.0 | 523.0 |
| 2 | 523.0 | 527.0 |
| 3 | 527.0 | 531.0 |
| 4 | 531.0 | 535.0 |
| 5 | 535.0 | 539.0 |

Tolerance for each bin limits is ± 0.05nm

| Bin ID | Wavelength (nm) | |
|--------|-----------------|-------|
| | Min. | Max. |
| Blue | | |
| 1 | 460.0 | 464.0 |
| 2 | 464.0 | 468.0 |
| 3 | 468.0 | 472.0 |
| 4 | 472.0 | 476.0 |
| 5 | 476.0 | 480.0 |

Tolerance for each bin limits is ± 0.05nm

Package Drawings

High Brightness SMT Lamps Package Drawing

Package Drawing A

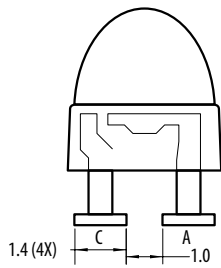
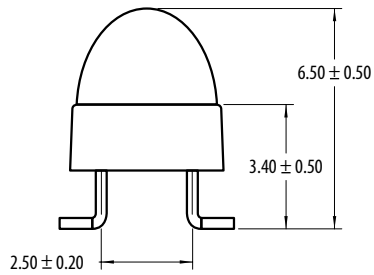
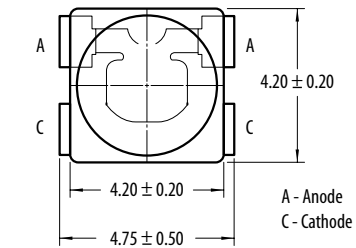

Package Drawing B

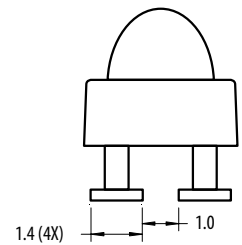
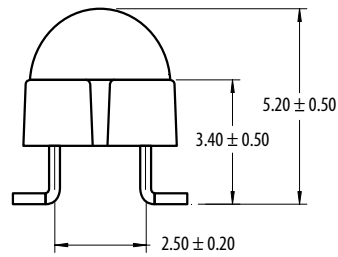
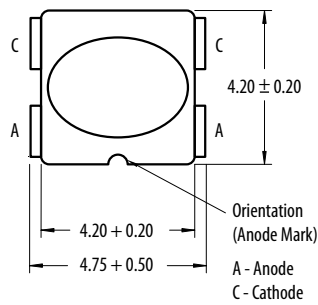

Package Drawing C

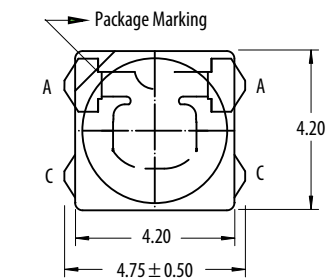

A: Anode
C: Cathode

Package Drawing D

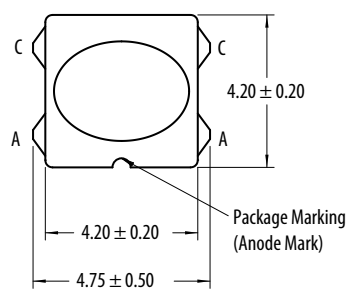

A - Anode
C - Cathode

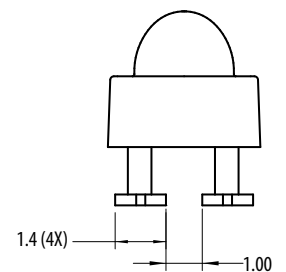
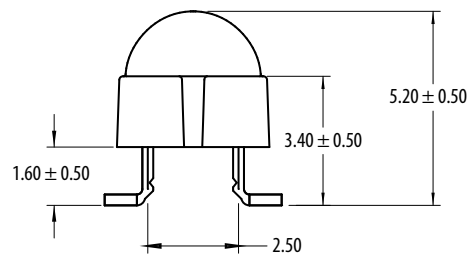
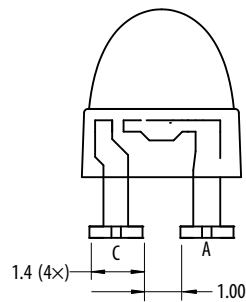
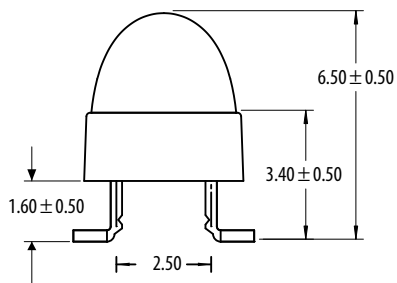

- Notes:
1. All dimensions in millimeters (inches).
2. Tolerance is ± 0.20 mm unless other specified.

Surface Mount

Description

This surface-mount LED comes in PLCC standard package dimension and DFN package. PLCC has a substrate made up of a molded plastic reflector sitting on top of a bent lead frame. The die is attached within the reflector cavity and the cavity is encapsulated by epoxy or silicone material.

DFN LEDs (Dual flat no-leads) are in small form factor and higher thermal efficiency. It offers great performance on a small surface area with the use of very flat lead frames and large outer contact faces acting as heat sink.

The SMT LED products with a viewing angle of 120° is ideal for instruments/switch/icon back lighting. With additional lens in 30° and 50° variants, these products are especially fitting to applications for traffic lights, CHMSL and displays. Its external reflector makes easy coupling with light pipe/light guide for an even-larger area back lighting. The package design coupled with careful selection of component materials allow these products to perform with high reliability in a larger temperature range -40°C to 100°C. The high reliability feature is crucial to Automotive Interior and Indoor ESS.

The surface-mount LED is designed to be compatible with industrial reflow soldering process.

Benefits

- Industry Standard PLCC SMT package
 - No change in existing board layout, drop-in replacement for the existing PLCC SMT LEDs
- High brightness using AlInGaP and InGaN dice technologies
- Available in various colors
 - Red, Red Orange, Orange, Amber, Yellow Green, Emerald Green, Green, Blue and White
 - Bi-colors in various combinations
 - Tri-colors in Red, Green and Blue
- Available in viewing angle of 30°, 50° and 120°
 - Well-suited for backlighting applications
- High volume, high reliability
 - Cost-effective solution
- Black surface and black body options to enhance contrast for display application
- Amusement lighting
- Decorative lighting
- Audio system illumination
- Gaming machine

Applications

- Interior automotive
 - Instrument panel backlighting
 - Central console backlighting
 - Instrument panel backlighting
 - Cabin backlighting
- Exterior automotive
 - Turn signals
 - Side repeater lamps



- CHMSLs (center high-mounted stop light)
- Rear combination lamps
- Puddle lights
- Electronic Signs and Signals
 - Interior full color sign
 - Variable message sign
- Electronic Signs and Signals
 - Interior full color sign
 - Variable message sign
- Office Automation, Electrical Appliances, Industrial Equipment
 - Front panel backlighting
 - Push button backlighting
 - Display backlighting
- amusement lighting
- Decorative lighting
- Audio system illumination
- Gaming machine

PLCC Surface Mount LEDs-PLCC-2 White

| Part Number | Color | Chromaticity | | Viewing Angle | Intensity | | Vf typ. | Test Current |
|-----------------|-------------|--------------|------|---------------|-----------|------|---------|--------------|
| | | x | y | | Min. | Max. | | |
| HSMW-A100-V40J1 | InGaN White | 0.31 | 0.31 | 120 | 715 | 1800 | 3.4 | 20 |

Notes:

1. The luminous intensity $I_{v, \theta_{1/2}}$ is measured at the mechanical axis of the lamp package. The actual peak of the spatial radiation pattern may not be aligned with this axis.
2. The chromaticity coordinates are derived from the CIE 1931 Chromaticity Diagram and represents the perceived color of the device.
3. $\theta_{1/2}$ is the off-axis angle where the luminous intensity is 1/2 the peak intensity.

PLCC Surface Mount LEDs–PLCC-2

| Part Number | Color | Dominant Wavelength | Viewing Angle | Intensity | | Vf typ. | Test Current |
|-----------------|---------------|---------------------|---------------|-----------|------|---------|--------------|
| | | | | | | | |
| HSMS-A100-J00J1 | Red | 626 | 120 | 4.5 | – | 2.2 | 20 |
| HSMH-A100-L00J1 | Red | 637 | 120 | 11.2 | – | 1.9 | 20 |
| HSMC-A100-Q00J1 | Red | 626 | 120 | 71.5 | – | 1.9 | 20 |
| HSMC-A101-S40J1 | Red | 626 | 120 | 180 | 450 | 1.9 | 20 |
| ASMT-URB4-PU802 | Red | 626 | 120 | 560 | 1400 | 1.9 | 20 |
| HSMJ-A100-T40J1 | Red Orange | 615 | 120 | 285 | 715 | 1.9 | 20 |
| HSMJ-A101-S00J1 | Red Orange | 615 | 120 | 180 | – | 1.9 | 20 |
| ASMT-UHB4-PU802 | Red Orange | 615 | 120 | 560 | 1400 | 1.9 | 20 |
| HSMD-A100-J00J1 | Orange | 602 | 120 | 4.4 | – | 2.2 | 20 |
| HSML-A100-Q00J1 | Orange | 605 | 120 | 71.5 | – | 1.9 | 20 |
| HSMY-A100-J00J1 | Amber | 585 | 120 | 4.5 | – | 2.2 | 20 |
| HSMA-A101-S70J1 | Amber | 590 | 120 | 224 | 450 | 1.9 | 20 |
| ASMT-UAB4-PU802 | Amber | 590 | 120 | 560 | 1400 | 1.9 | 20 |
| HSMG-A100-J02J1 | Yellow Green | 569 | 120 | 4.5 | – | 2.2 | 20 |
| HSME-A100-M02J1 | Yellow Green | 569 | 120 | 18 | – | 1.9 | 20 |
| HSMG-A100-H01J1 | Emerald Green | 560 | 120 | 2.8 | – | 2.2 | 20 |
| HSME-A100-L01J1 | Emerald Green | 560 | 120 | 11.2 | – | 1.9 | 20 |
| HSMM-A100-U4PJ1 | Green | 525 | 120 | 450 | 1125 | 3.4 | 20 |
| ASMT-UGB5-NW705 | Green | 525 | 120 | 1400 | 2850 | 3.4 | 20 |
| HSMN-A100-S4YJ1 | Blue | 470 | 120 | 180 | 450 | 3.4 | 20 |
| ASMT-UBB5-NS8Q2 | Blue | 470 | 120 | 224 | 560 | 3.4 | 20 |

Notes:

1. The luminous intensity I_{v_2} is measured at the mechanical axis of the lamp package. The actual peak of the spatial radiation pattern may not be aligned with this axis.
2. The dominant wavelength, λ_p , is derived from the CIE Chromaticity Diagram and represents the color of the device.
3. $\theta_{1/2}$ is the off-axis angle where the luminous intensity is 1/2 the peak intensity.

PLCC-2 White (ASMT-UWB1)

| Part Number | Color | CCT (K) | CRI | Viewing Angle $2\theta_{1/2}$ (°) | Luminous Intensity (mcd) | | | Test Current (mA) |
|-----------------|-------------|-------------|-----|--------------------------------------|--------------------------|------|------|-------------------|
| | | | | | Min | Typ | Max | |
| ASMT-UWB1-NX702 | InGaN White | 4500 - 8000 | 70 | 120 | 2240 | 2300 | 4500 | 20 |
| ASMT-UWB1-NX712 | InGaN White | 2700 - 4000 | 70 | 120 | 2240 | 2300 | 4500 | 20 |
| ASMT-UWB1-NX7A2 | InGaN White | 8000 | 70 | 120 | 2240 | 2300 | 4500 | 20 |
| ASMT-UWB1-NX7B2 | InGaN White | 6500 | 70 | 120 | 2240 | 2300 | 4500 | 20 |
| ASMT-UWB1-NX7C2 | InGaN White | 5700 | 70 | 120 | 2240 | 2300 | 4500 | 20 |
| ASMT-UWB1-NX7D2 | InGaN White | 5000 | 70 | 120 | 2240 | 2300 | 4500 | 20 |
| ASMT-UWB1-NX7E2 | InGaN White | 4500 | 70 | 120 | 2240 | 2300 | 4500 | 20 |
| ASMT-UWB1-NX7F2 | InGaN White | 4000 | 70 | 120 | 2240 | 2300 | 4500 | 20 |
| ASMT-UWB1-NX3G2 | InGaN White | 3500 | 70 | 120 | 1800 | 2300 | 3550 | 20 |
| ASMT-UWB1-NX3H2 | InGaN White | 3000 | 70 | 120 | 1800 | 2300 | 3550 | 20 |
| ASMT-UWB1-NX3J2 | InGaN White | 2700 | 70 | 120 | 1800 | 2300 | 3550 | 20 |
| ASMT-UWB2-NX302 | InGaN White | 4500 - 8000 | 80 | 120 | 1800 | 2300 | 3550 | 20 |
| ASMT-UWB2-NX3A2 | InGaN White | 8000 | 80 | 120 | 1800 | 2300 | 3550 | 20 |
| ASMT-UWB2-NX3B2 | InGaN White | 6500 | 80 | 120 | 1800 | 2300 | 3550 | 20 |
| ASMT-UWB2-NX3C2 | InGaN White | 5700 | 80 | 120 | 1800 | 2300 | 3550 | 20 |
| ASMT-UWB2-NX3D2 | InGaN White | 5000 | 80 | 120 | 1800 | 2300 | 3550 | 20 |
| ASMT-UWB2-NX3E2 | InGaN White | 4500 | 80 | 120 | 1800 | 2300 | 3550 | 20 |
| ASMT-UWB2-NW7F2 | InGaN White | 4000 | 80 | 120 | 1400 | 1500 | 2850 | 20 |
| ASMT-UWB2-NW7G2 | InGaN White | 3500 | 80 | 120 | 1400 | 1500 | 2850 | 20 |
| ASMT-UWB2-NW7H2 | InGaN White | 3000 | 80 | 120 | 1400 | 1500 | 2850 | 20 |
| ASMT-UWB2-NW7J2 | InGaN White | 2700 | 80 | 120 | 1400 | 1500 | 2850 | 20 |

Tolerance $\pm 12\%$

PLCC Surface Mount LEDs Power-PLCC-4

| Part Number | Color | Typ. Dominant Wavelength λ_b [1] (nm) | Viewing Angle $2\theta_{1/2}$ [2] (°) | Min. I_v (mcd) | Max. I_v (mcd) | Typ. V_f (V) | Test Current (mA) |
|-----------------|---------------|---|---------------------------------------|------------------|------------------|----------------|-------------------|
| HSMC-A401-U80M1 | Red | 626 | 120 | 560 | 1400 | 2.2 | 50 |
| ASMT-SRB4-PW505 | Red | 626 | 120 | 1125 | 3550 | 2.2 | 50 |
| HSMA-A401-U80M1 | Amber | 590 | 120 | 560 | 1400 | 2.2 | 50 |
| HSMA-A401-V30M1 | Amber | 590 | 120 | 715 | 1400 | 2.2 | 50 |
| ASMT-SAB4-PW505 | Amber | 590 | 120 | 1125 | 3550 | 2.2 | 50 |
| HSML-A401-U40M1 | Orange | 605 | 120 | 450 | 1125 | 2.2 | 50 |
| HSMJ-A401-U40M1 | Red Orange | 615 | 120 | 450 | 1125 | 2.2 | 50 |
| ASMT-SHB4-PW905 | Red Orange | 615 | 120 | 1125 | 3550 | 2.2 | 50 |
| HSME-A401-P4PM1 | Emerald Green | 567 | 120 | 45 | 112.5 | 2.2 | 50 |
| HSMH-A400-V8QM2 | Green | 525 | 120 | 1400 | 3550 | 3.8 | 30 |
| HSMH-A400-W8YM2 | Green | 525 | 120 | 1400 | 3550 | 3.8 | 30 |
| ASMT-SGB5-NW703 | Green | 525 | 120 | 1400 | 2850 | 3.2 | 30 |
| HSMH-A400-S8PM2 | Blue | 470 | 120 | 224 | 560 | 3.8 | 30 |
| HSMN-A400-S8QM2 | Blue | 470 | 120 | 224 | 560 | 3.8 | 30 |
| ASMT-SBB5-NT703 | Blue | 470 | 120 | 355 | 715 | 3.2 | 30 |

Notes:

1. The dominant wavelength, λ_b , is derived from the CIE Chromaticity Diagram and represents the color of the device.
2. $\theta_{1/2}$ is the off-axis angle where the luminous intensity is 1/2 the peak intensity.
3. The luminous intensity, I_v , is measured at the mechanical axis of the lamp package. The actual peak of the spatial radiation pattern may not be aligned with this axis.

Power PLCC-4 White

| Part Number | Color | Chromaticity | | Viewing Angle | Intensity | | | Vf typ. | Test Current |
|-----------------|-------------|--------------|-------|---------------|-----------|------|------|---------|--------------|
| | | x | y | | Min. | Typ. | Max. | | |
| HSMW-A400-U00M2 | InGaN White | 0.31 | 0.31 | 120 | 450 | 700 | - | 3.8 | 30 |
| ASMT-SWBM-NV803 | InGaN White | 0.318 | 0.318 | 120 | 900 | 1100 | 2240 | 3.5 | 30 |

Notes:

1. The luminous intensity I_v , is measured at the mechanical axis of the lamp package. The actual peak of the spatial radiation pattern may not be aligned with this axis.
2. I_v Tolerance = $\pm 12\%$.
3. The chromaticity coordinates are derived from the CIE 1931 Chromaticity Diagram and represent the perceived color of the device.
4. $\theta_{1/2}$ is the off-axis angle where the luminous intensity is $\frac{1}{2}$ the peak intensity.

Power PLCC-4 with Lens

| Part Number | Color | Dominant Wavelength λ_b [1] (nm) | Viewing Angle $2\theta_{1/2}$ (°) | Min. I_v (mcd) | Max. I_v (mcd) | Typ. V_f (V) | Test Current (mA) |
|-----------------|---------------------|--|-----------------------------------|------------------|------------------|----------------|-------------------|
| HSMC-A431-Y80M1 | AllInGaP Red | 626 | 30 | 3550 | 9000 | 2.2 | 50 |
| HSMC-A431-X90M1 | AllInGaP Red | 626 | 30 | 2240 | 7150 | 2.2 | 50 |
| HSMC-A461-V00M1 | AllInGaP Red | 626 | 50 | 715 | - | 2.2 | 50 |
| HSMJ-A430-W50M1 | AllInGaP Red Orange | 615 | 30 | 1125 | 3550 | 2.2 | 50 |
| HSMJ-A431-X90M1 | AllInGaP Red Orange | 615 | 30 | 2240 | 7150 | 2.2 | 50 |
| HSMJ-A461-W40M1 | AllInGaP Red Orange | 615 | 50 | 1125 | 2850 | 2.2 | 50 |
| HSML-A431-X90M1 | AllInGaP Orange | 605 | 30 | 2240 | 7150 | 2.2 | 50 |
| HSML-A461-W40M1 | AllInGaP Orange | 605 | 50 | 1125 | 2850 | 2.2 | 50 |
| HSMA-A431-Y00M1 | AllInGaP Amber | 590 | 30 | 2850 | - | 2.2 | 50 |
| HSMA-A431-Z50M1 | AllInGaP Amber | 590 | 30 | 4500 | 14000 | 2.2 | 50 |
| HSMA-A461-X83M1 | AllInGaP Amber | 590 | 50 | 2240 | 5600 | 2.2 | 50 |
| HSMH-A430-Y7YM2 | InGaN Green | 525 | 30 | 3550 | 7150 | 3.9 | 30 |
| HSMN-A430-V7YM2 | InGaN Blue | 470 | 30 | 900 | 1800 | 3.9 | 30 |

Notes:

1. The luminous intensity, I_v , is measured at the mechanical axis of the lamp package. The actual peak of the spatial radiation pattern may not be aligned with this axis.
2. I_v tolerance $\pm 12\%$.
3. The dominant wavelength, λ_b , is derived from the CIE Chromaticity Diagram and represents the color of the device.
4. $\theta_{1/2}$ is the off-axis angle where the luminous intensity is $\frac{1}{2}$ the peak intensity.

PLCC Surface Mount LEDs

Bicolor PLCC-4

| Part Number | Color | Min. I _v @ 20mA | | Typ. I _v (mcd) @ 20mA |
|-----------------|----------------------|----------------------------|------|-------------------------------------|
| | | Bin ID | mcd | |
| HSMF-A201-A00J1 | GaP Red | K2 | 8 | 16 |
| | GaP Yellow Green | L1 | 10 | 20 |
| HSMF-A202-A00J1 | GaP Red | K2 | 8 | 16 |
| | GaP Yellow | K1 | 6.3 | 12 |
| HSMF-A203-A00J1 | GaP Red | K2 | 8 | 16 |
| | GaP Emerald Green | J1 | 4 | 8 |
| HSMF-A204-A00J1 | GaP Orange | K2 | 8 | 16 |
| | GaP Yellow Green | L1 | 10 | 20 |
| HSMF-A205-A00J1 | GaP Orange | K2 | 8 | 16 |
| | GaP Emerald Green | J1 | 4 | 8 |
| HSMF-A206-A00J1 | GaP Yellow | K2 | 8 | 16 |
| | GaP Yellow Green | L1 | 10 | 20 |
| HSMF-A211-A00J1 | AlGaAs Red | L2 | 12.5 | 25 |
| | GaP Yellow Green | L1 | 10 | 20 |
| HSMF-A212-A00J1 | AlGaAs Red | L2 | 12.5 | 25 |
| | GaP Yellow | K1 | 6.3 | 12 |
| HSMF-A222-A00J1 | AllnGaP Red | P1 | 40 | 80 |
| | AllnGaP Amber | P1 | 40 | 80 |
| HSMF-A226-A00J1 | AllnGaP Amber | P2 | 50 | 100 |
| | AllnGaP Yellow Green | M2 | 20 | 60 |

0.2W SMT White LED

| Part Number | Package Dimensions | CCT (K) | Viewing Angle (°) | Min Flux (lm) | Max Flux (lm) | Forward Voltage (Vf) If=60mA | Max Forward Current (mA) |
|------------------|--------------------|---------|-------------------|---------------|---------------|---------------------------------|--------------------------|
| ASMD-FWG3-NMSA6 | 3.0 x 1.4 x 0.7 | 2700 | 120 | 18 | 28 | 3.02 | 90 |
| ASMD-FWG3-NMSB6 | 3.0 x 1.4 x 0.7 | 3000 | 120 | 18 | 28 | 3.02 | 90 |
| ASMD-FWG3-NPTC6 | 3.0 x 1.4 x 0.7 | 3500 | 120 | 20 | 30 | 3.02 | 90 |
| ASMD-FWG3-NPTD6 | 3.0 x 1.4 x 0.7 | 4000 | 120 | 20 | 30 | 3.02 | 90 |
| ASMD-FWG3-NPTE6 | 3.0 x 1.4 x 0.7 | 5000 | 120 | 20 | 30 | 3.02 | 90 |
| ASMD-FWG3-NPTF6 | 3.0 x 1.4 x 0.7 | 5700 | 120 | 20 | 30 | 3.02 | 90 |
| ASMD-FWG3-NPTG6 | 3.0 x 1.4 x 0.7 | 6200 | 120 | 20 | 30 | 3.02 | 90 |
| ASMD-FWG3-NPTH6 | 3.0 x 1.4 x 0.7 | 6500 | 120 | 20 | 30 | 3.02 | 90 |
| ASMD-FWG3-NPTJ6 | 3.0 x 1.4 x 0.7 | 6800 | 120 | 20 | 30 | 3.02 | 90 |
| ASMW- FWG0-NJLH6 | 3.5 x 2.8 x 0.7 | 3000 | 120 | 20 | 26 | 3.11 | 100 |
| ASMW- FWG0-NJLF6 | 3.5 x 2.8 x 0.7 | 4000 | 120 | 20 | 26 | 3.11 | 100 |
| ASMW- FWG0-NJLB6 | 3.5 x 2.8 x 0.7 | 6500 | 120 | 20 | 26 | 3.11 | 100 |

0.5W SMT Mono Color LED

| Part Number | Color | Package Dimensions | Dominant Wavelength λ_p ^[1] (nm) | Viewing Angle ^[2] (°) | Min. Flux (lm) | Max. Flux (lm) | Forward Voltage (V _f) I _f =150mA | Test Current (mA) |
|-----------------|------------|--------------------|---|----------------------------------|----------------|----------------|--|-------------------|
| ASMT-QABD-AEFOE | Amber | 2.8 x 3.5 x 1.9 | 593.1 | 120 | 11.5 | 25.5 | 2.5 | 150 |
| ASMT-QABE-ANQOE | Amber | 2.8 x 3.5 x 1.9 | 593.1 | 120 | 19.6 | 26.9 | 2.25 | 150 |
| ASMW-LA00-AUWOE | Amber | 3.5 x 2.8 x 0.7 | 589 | 120 | 26 | 35 | 2.3 | 150 |
| ASMT-QHBD-AFHOE | Red Orange | 2.8 x 3.5 x 1.9 | 616.1 | 120 | 11.5 | 25.5 | 2.5 | 150 |
| ASMT-QHBE-ANQOE | Red Orange | 2.8 x 3.5 x 1.9 | 616.1 | 120 | 19.6 | 26.9 | 2.25 | 150 |
| ASMW-LH00-AUWOE | Red Orange | 3.5 x 2.8 x 0.7 | 613 | 120 | 26 | 35 | 2.3 | 150 |
| ASMT-QRBD-AEFOE | Red | 2.8 x 3.5 x 1.9 | 621.1 | 120 | 11.5 | 25.5 | 2.5 | 150 |
| ASMT-QRBE-ANQOE | Red | 2.8 x 3.5 x 1.9 | 621.1 | 120 | 19.6 | 26.9 | 2.25 | 150 |
| ASMW-LR00-ASUOE | Red | 3.5 x 2.8 x 0.7 | 623 | 120 | 21 | 29 | 2.3 | 150 |
| ASMT-QBB3-NBDOE | Blue | 2.8 x 3.5 x 1.9 | 460 | 120 | 5.5 | 11.5 | 3.5 | 150 |
| ASMW-LM00-NGJOE | Deep Blue | 3.5 x 2.8 x 0.7 | 456 | 120 | 8 | 11 | 3.08 | 150 |
| ASMT-QGBE-NGHOE | Green | 2.8 x 3.5 x 1.9 | 522 | 120 | 19 | 33 | 3.6 | 150 |
| ASMW-LG00-NWYOE | Green | 3.5 x 2.8 x 0.7 | 529 | 120 | 32 | 41 | 3.16 | 150 |

Notes:

1. The dominant wavelength, λ_p , is derived from the CIE Chromaticity diagram and represents the color of the device.
2. $\theta_{1/2}$ is the off-axis angle where the luminous intensity is 1/2 the peak intensity.
3. Φ_v is the total luminous flux output as measured with an integrating sphere at mono pulse conditions.
4. Tolerance = $\pm 12\%$.

0.5W SMT White LED

| Part Number | Package Dimensions | CCT (K) | Viewing Angle ^[1] (°) | Min. Flux (lm) | Max. Flux (lm) | Forward Voltage (V _f) I _f =150mA | Max Forward Current (mA) |
|-----------------|--------------------|---------|----------------------------------|----------------|----------------|--|--------------------------|
| ASMD-LWG3-NPSAD | 3.0 x 1.4 x 0.7 | 2700 | 120 | 20 | 28 | 2.99 | 200 |
| ASMD-LWG3-NPSBD | 3.0 x 1.4 x 0.7 | 3000 | 120 | 20 | 28 | 2.99 | 200 |
| ASMD-LWG3-NQTCD | 3.0 x 1.4 x 0.7 | 3500 | 120 | 22 | 30 | 2.99 | 200 |
| ASMD-LWG3-NQTDD | 3.0 x 1.4 x 0.7 | 4000 | 120 | 22 | 30 | 2.99 | 200 |
| ASMD-LWG3-NQTED | 3.0 x 1.4 x 0.7 | 5000 | 120 | 22 | 30 | 2.99 | 200 |
| ASMD-LWG3-NQTFD | 3.0 x 1.4 x 0.7 | 5700 | 120 | 22 | 30 | 2.99 | 200 |
| ASMD-LWG3-NQTGD | 3.0 x 1.4 x 0.7 | 6200 | 120 | 22 | 30 | 2.99 | 200 |
| ASMD-LWG3-NQTHD | 3.0 x 1.4 x 0.7 | 6500 | 120 | 22 | 30 | 2.99 | 200 |
| ASMD-LWG3-NQTJD | 3.0 x 1.4 x 0.7 | 6800 | 120 | 22 | 30 | 2.99 | 200 |
| ASMF-LWG4-NQTAD | 3.0 x 3.0 x 0.6 | 2700 | 120 | 22 | 30 | 2.9 | 240 |
| ASMF-LWG4-NQTB | 3.0 x 3.0 x 0.6 | 3000 | 120 | 22 | 30 | 2.9 | 240 |
| ASMF-LWG4-NRUCD | 3.0 x 3.0 x 0.6 | 3500 | 120 | 24 | 32 | 2.9 | 240 |
| ASMF-LWG4-NRUDD | 3.0 x 3.0 x 0.6 | 4000 | 120 | 24 | 32 | 2.9 | 240 |
| ASMF-LWG4-NRUED | 3.0 x 3.0 x 0.6 | 5000 | 120 | 24 | 32 | 2.9 | 240 |
| ASMF-LWG4-NRUFD | 3.0 x 3.0 x 0.6 | 5700 | 120 | 24 | 32 | 2.9 | 240 |
| ASMF-LWG4-NRUGD | 3.0 x 3.0 x 0.6 | 6200 | 120 | 24 | 32 | 2.9 | 240 |
| ASMF-LWG4-NRUHD | 3.0 x 3.0 x 0.6 | 6500 | 120 | 24 | 32 | 2.9 | 240 |
| ASMF-LWG4-NRUJD | 3.0 x 3.0 x 0.6 | 6800 | 120 | 24 | 32 | 2.9 | 240 |

Notes:

1. $\theta_{1/2}$ is the off-axis angle where the luminous intensity is 1/2 the peak intensity.
2. Tolerance = $\pm 12\%$

High Brightness Tricolor PLCC4 & PLCC6

| Part Number | Color | Package | Package Dimension | Viewing Angle (°) | Dominant Wavelength (nm) | Min Intensity (mcd) @ 20mA | | Typ IV @ 20mA mcd | Features |
|-----------------|-------|---------|-------------------|-------------------|--------------------------|----------------------------|-------|----------------------|-------------------------------|
| | | | | | | Bin | mcd | | |
| ASMB-BTE1-0B332 | Red | PLCC-4 | 3.5x 2.8x 1.9 | 110 | 622 | U1 | 450 | 630 | Black Body White Reflector |
| | Green | | | | 529 | W1 | 1125 | 1500 | |
| | Blue | | | | 469 | T1 | 285 | 350 | |
| ASMB-BTE2-0C332 | Red | PLCC-4 | 3.5 x 2.8 x 1.9 | 110 | 620 | R2 | 140 | 240 | Black Body White Reflector |
| | Green | | | | 522 | V2 | 900 | 1100 | |
| | Blue | | | | 468 | S2 | 224 | 260 | |
| ASMB-MTB0-0A302 | Green | PLCC-4 | 3.5x 2.8x 1.9 | 115 | 625 | U1 | 450 | 540 | Black Surface |
| | Blue | | | | 530 | W1 | 1125 | 1600 | |
| | Blue | | | | 470 | T1 | 285 | 350 | |
| ASMB-MTB1-0A302 | Red | PLCC-4 | 3.5x 2.8x 1.9 | 115 | 625 | U1 | 450 | 540 | Black Surface |
| | Green | | | | 530 | W1 | 1125 | 1600 | |
| | Blue | | | | 470 | T1 | 285 | 350 | |
| ASMB-MTC1-0A3A2 | Red | PLCC-6 | 3.4 x 2.8 x 1.8 | 105 | 625 | S1 | 180 | 280 | Black Body |
| | Green | | | | 528 | U2 | 560 | 850 | |
| | Blue | | | | 470 | R1 | 112.5 | 170 | |
| ASMB-TTB0-0A3A2 | Red | PLCC-6 | 3.5 x 3.5 x 2.8 | 115 | 621 | U2 | 560 | 790 | Black Surface |
| | Green | | | | 530 | X1 | 1800 | 2400 | |
| | Blue | | | | 470 | T2 | 355 | 500 | |
| ASMB-TTB2-0C3A2 | Red | PLCC-6 | 3.5 x 3.5 x 2.8 | 115 | 621 | U2 | 560 | 790 | Black Surface |
| | Green | | | | 530 | W2 | 1400 | 200 | |
| | Blue | | | | 470 | T1 | 285 | 380 | |
| ASMT-YTB2-0BB02 | Red | PLCC-6 | 3.4 x 2.8x 1.8 | 120 | 626 | U2 | 560 | 745 | Black Surface |
| | Green | | | | 525 | W1 | 1125 | 1600 | |
| | Blue | | | | 470 | T1 | 285 | 380 | |
| ASMT-YTB7-0AA02 | Red | PLCC-6 | 3.4 x 2.8x 1.8 | 120 | 622 | U2 | 560 | 650 | Black Surface |
| | Green | | | | 530 | W2 | 1400 | 1900 | |
| | Blue | | | | 470 | T1 | 285 | 384 | |
| ASMT-YTC2-0BB02 | Red | PLCC-6 | 3.4 x 2.8x 1.8 | 120 | 626 | T2 | 355 | 450 | Black Body |
| | Green | | | | 525 | U1 | 450 | 560 | |
| | Blue | | | | 470 | R2 | 140 | 180 | |
| ASMT-YTC7-0AA02 | Red | PLCC-6 | 3.4 x 2.8x 1.8 | 110 | 622 | S2 | 224 | 330 | Black Body |
| | Green | | | | 530 | U2 | 560 | 1125 | |
| | Blue | | | | 470 | R1 | 112.5 | 160 | |
| ASMT-YTD2-0BB02 | Red | PLCC-6 | 3.4 x 2.8x 1.8 | 120 | 626 | U2 | 560 | 745 | White Surface |
| | Green | | | | 525 | W1 | 1125 | 1600 | |
| | Blue | | | | 470 | T1 | 285 | 380 | |
| ASMT-YTD7-0AA02 | Red | PLCC-6 | 3.4 x 2.8x 1.8 | 120 | 622 | U2 | 560 | 650 | White Surface |
| | Green | | | | 530 | W1 | 1400 | 1900 | |
| | Blue | | | | 470 | T1 | 285 | 384 | |
| ASMT-YTD9-0AA02 | Red | PLCC-6 | 3.4 x 2.8x 1.8 | 120 | 626 | U2 | 560 | 1125 | White Surface |
| | Green | | | | 525 | W2 | 1400 | 2850 | |
| | Blue | | | | 470 | T1 | 285 | 560 | |

Subminiature Tricolor PLCC4

| Part Number | Color | Package | Package Dimension | Viewing Angle (°) | Dominant Wavelength (nm) | Min Intensity (mcd) | Typ IV (mcd) | Test Current (mA) | Features |
|-----------------|-------|---------|-------------------|-------------------|--------------------------|---------------------|--------------|-------------------|------------|
| ASMB-LTC1-0A3A5 | Red | PLCC-4 | 2.1 x 2.1 x 1.0 | 105 | 621 | 52.0 | 62.0 | 5 | Black Body |
| | Green | | | | 529 | 124.0 | 196.0 | 5 | |
| | Blue | | | | 467 | 28.8 | 43.0 | 5 | |

High Brightness Tricolor DFN6

| Part Number | Color | Package | Silicone/ Epoxy | Package Dimensions | ESD protection | Typical Intensity (mcd) | Typical Chromaticity Coordinate | Test Current | Package appearance |
|-----------------|---------------|---------|-----------------|--------------------|----------------|-------------------------|---------------------------------|--------------------------------|--------------------|
| ASMB-6WDO-0A101 | RGB mix white | DFN6 | Silicone | 3.5 x 2.8 x 0.6 | No | 1900 | 0.3, 0.3 | Red 14mA, Green 11mA, Blue 9mA | White |
| ASMB-6WZO-0A101 | RGB mix white | DFN6 | Silicone | 3.5 x 2.8 x 0.6 | Yes | 1900 | 0.3, 0.3 | Red 14mA, Green 11mA, Blue 9mA | White |
| ASMB-6EDO-0A101 | RGB mix white | DFN6 | Epoxy | 3.5 x 2.8 x 0.6 | No | 1900 | 0.3, 0.3 | Red 14mA, Green 11mA, Blue 9mA | White |
| ASMB-6EZO-0A101 | RGB mix white | DFN6 | Epoxy | 3.5 x 2.8 x 0.6 | Yes | 1900 | 0.3, 0.3 | Red 14mA, Green 11mA, Blue 9mA | White |

PLCC-2 (ASMT-UWB1)

ASMT-UWB1-N X₂ X₃ X₄ 2



Color Bin Limits

Individual reel will contain parts from one sub bin only.

| Sub Bin | Chromaticity Coordinates | | | | |
|---------|--------------------------|--------|--------|--------|--------|
| 1A | x | 0.2950 | 0.2920 | 0.2984 | 0.3009 |
| | y | 0.2970 | 0.3060 | 0.3133 | 0.3042 |
| 1B | x | 0.2920 | 0.2895 | 0.2962 | 0.2984 |
| | y | 0.3060 | 0.3135 | 0.3220 | 0.3133 |
| 1C | x | 0.2984 | 0.2962 | 0.3028 | 0.3048 |
| | y | 0.3133 | 0.3220 | 0.3304 | 0.3207 |
| 1D | x | 0.2984 | 0.3048 | 0.3068 | 0.3009 |
| | y | 0.3207 | 0.3290 | 0.3186 | 0.3113 |
| 2A | x | 0.3048 | 0.3130 | 0.3144 | 0.3068 |
| | y | 0.3207 | 0.3290 | 0.3186 | 0.3113 |
| 2B | x | 0.3028 | 0.3115 | 0.3130 | 0.3048 |
| | y | 0.3304 | 0.3391 | 0.3290 | 0.3207 |
| 2C | x | 0.3115 | 0.3205 | 0.3213 | 0.3130 |
| | y | 0.3391 | 0.3481 | 0.3373 | 0.3290 |
| 2D | x | 0.3130 | 0.3213 | 0.3221 | 0.3144 |
| | y | 0.3290 | 0.3373 | 0.3261 | 0.3186 |
| 3A | x | 0.3215 | 0.3290 | 0.3290 | 0.3222 |
| | y | 0.3350 | 0.3417 | 0.3300 | 0.3243 |
| 3B | x | 0.3207 | 0.3290 | 0.3290 | 0.3215 |
| | y | 0.3462 | 0.3538 | 0.3417 | 0.3350 |
| 3C | x | 0.3290 | 0.3376 | 0.3371 | 0.3290 |
| | y | 0.3538 | 0.3616 | 0.3490 | 0.3417 |
| 3D | x | 0.3290 | 0.3371 | 0.3366 | 0.3290 |
| | y | 0.3417 | 0.3490 | 0.3369 | 0.3300 |
| 4A | x | 0.3371 | 0.3451 | 0.3440 | 0.3366 |
| | y | 0.3490 | 0.3554 | 0.3427 | 0.3369 |
| 4B | x | 0.3376 | 0.3463 | 0.3451 | 0.3371 |
| | y | 0.3616 | 0.3687 | 0.3554 | 0.3490 |
| 4C | x | 0.3463 | 0.3551 | 0.3533 | 0.3451 |
| | y | 0.3687 | 0.3760 | 0.3620 | 0.3554 |
| 4D | x | 0.3451 | 0.3533 | 0.3515 | 0.3440 |
| | y | 0.3554 | 0.3620 | 0.3487 | 0.3427 |
| 5A | x | 0.3530 | 0.3615 | 0.3590 | 0.3512 |
| | y | 0.3597 | 0.3659 | 0.3521 | 0.3465 |
| 5B | x | 0.3548 | 0.3641 | 0.3615 | 0.3530 |
| | y | 0.3736 | 0.3804 | 0.3659 | 0.3597 |
| 5C | x | 0.3641 | 0.3736 | 0.3702 | 0.3615 |
| | y | 0.3804 | 0.3874 | 0.3722 | 0.3659 |
| 5D | x | 0.3615 | 0.3702 | 0.3670 | 0.3590 |
| | y | 0.3659 | 0.3722 | 0.3578 | 0.3521 |

Intensity Bin Limits

| Bin ID | Min. (mcd) | Max. (mcd) |
|--------|------------|------------|
| X1 | 1800 | 2240 |
| X2 | 2240 | 2850 |
| Y1 | 2850 | 3550 |
| Y2 | 3550 | 4500 |
| Z1 | 4500 | 5600 |
| Z2 | 5600 | 7150 |

Tolerance of each bin $\pm 12\%$

| | | | | | |
|----|---|--------|--------|--------|--------|
| 6A | x | 0.3670 | 0.3702 | 0.3825 | 0.3783 |
| | y | 0.3578 | 0.3722 | 0.3798 | 0.3646 |
| 6B | x | 0.3702 | 0.3736 | 0.3869 | 0.3825 |
| | y | 0.3722 | 0.3874 | 0.3958 | 0.3798 |
| 6C | x | 0.3825 | 0.3869 | 0.4006 | 0.3950 |
| | y | 0.3798 | 0.3958 | 0.4044 | 0.3875 |
| 6D | x | 0.3783 | 0.3825 | 0.3950 | 0.3898 |
| | y | 0.3646 | 0.3798 | 0.3875 | 0.3716 |
| 7A | x | 0.3889 | 0.3941 | 0.4080 | 0.4017 |
| | y | 0.3690 | 0.3848 | 0.3916 | 0.3751 |
| 7B | x | 0.3941 | 0.3996 | 0.4146 | 0.4080 |
| | y | 0.3848 | 0.4015 | 0.4089 | 0.3916 |
| 7C | x | 0.4080 | 0.4146 | 0.4299 | 0.4221 |
| | y | 0.3916 | 0.4089 | 0.4165 | 0.3984 |
| 7D | x | 0.4017 | 0.4080 | 0.4221 | 0.4147 |
| | y | 0.3751 | 0.3916 | 0.3984 | 0.3814 |
| 8A | x | 0.4147 | 0.4221 | 0.4342 | 0.4259 |
| | y | 0.3814 | 0.3984 | 0.4028 | 0.3853 |
| 8B | x | 0.4221 | 0.4299 | 0.4430 | 0.4342 |
| | y | 0.3984 | 0.4165 | 0.4212 | 0.4028 |
| 8C | x | 0.4342 | 0.4430 | 0.4562 | 0.4465 |
| | y | 0.4028 | 0.4212 | 0.4260 | 0.4071 |
| 8D | x | 0.4259 | 0.4342 | 0.4465 | 0.4373 |
| | y | 0.3853 | 0.4028 | 0.4071 | 0.3893 |
| 9A | x | 0.4373 | 0.4465 | 0.4582 | 0.4483 |
| | y | 0.3893 | 0.4071 | 0.4099 | 0.3919 |
| 9B | x | 0.4465 | 0.4562 | 0.4687 | 0.4582 |
| | y | 0.4071 | 0.4260 | 0.4289 | 0.4099 |
| 9C | x | 0.4582 | 0.4687 | 0.4813 | 0.4700 |
| | y | 0.4099 | 0.4289 | 0.4319 | 0.4126 |
| 9D | x | 0.4483 | 0.4582 | 0.4700 | 0.4593 |
| | y | 0.3919 | 0.4099 | 0.4126 | 0.3944 |

Intensity Bin Select (X₂X₃)

Individual reel will contain parts from one half bin only.

| X ₂ | Minimum Iv Bin |
|----------------|--|
| X ₃ | Maximum Iv Bin |
| 0 | Full Distribution |
| 3 | 3 half bins starting from X ₂ 1 |
| 4 | 4 half bins starting from X ₂ 1 |
| 5 | 5 half bins starting from X ₂ 1 |
| 7 | 3 half bins starting from X ₂ 2 |
| 8 | 4 half bins starting from X ₂ 2 |
| 9 | 5 half bins starting from X ₂ 2 |

Color Bin Limits

Individual reel will contain parts from one sub bin only.

| Bin | Sub Bin |
|-----|--|
| A | 1A, 1B, 1C, 1D |
| B | 2A, 2B, 2C, 2D |
| C | 3A, 3B, 3C, 3D |
| D | 4A, 4B, 4C, 4D |
| E | 5A, 5B, 5C, 5D |
| F | 6A, 6B, 6C, 6D |
| G | 7A, 7B, 7C, 7D |
| H | 8A, 8B, 8C, 8D |
| J | 9A, 9B, 9C, 9D |
| K | 1A, 1B, 1C, 1D, 2A, 2B, 2C, 2D |
| L | 2A, 2B, 2C, 2D, 3A, 3B, 3C, 3D |
| M | 3A, 3B, 3C, 3D, 4A, 4B, 4C, 4D |
| N | 4A, 4B, 4C, 4D, 5A, 5B, 5C, 5D |
| P | 5A, 5B, 5C, 5D, 6A, 6B, 6C, 6D |
| R | 7A, 7B, 7C, 7D, 8A, 8B, 8C, 8D |
| S | 8A, 8B, 8C, 8D, 9A, 9B, 9C, 9D |
| O | 1A, 1B, 1C, 1D, 2A, 2B, 2C, 2D, 3A, 3B, 3C, 3D, 4A, 4B, 4C, 4D, 5A, 5B, 5C, 5D |
| 1 | 6A, 6B, 6C, 6D, 7A, 7B, 7C, 7D, 8A, 8B, 8C, 8D, 9A, 9B, 9C, 9D |

Forward Voltage Bin

| Bin | Min (V) | Max (V) |
|-----|---------|---------|
| F03 | 2.4 | 2.6 |
| F04 | 2.6 | 2.8 |
| F05 | 2.8 | 3 |
| F06 | 3.2 | 3.2 |

Tolerance $\pm 0.1V$

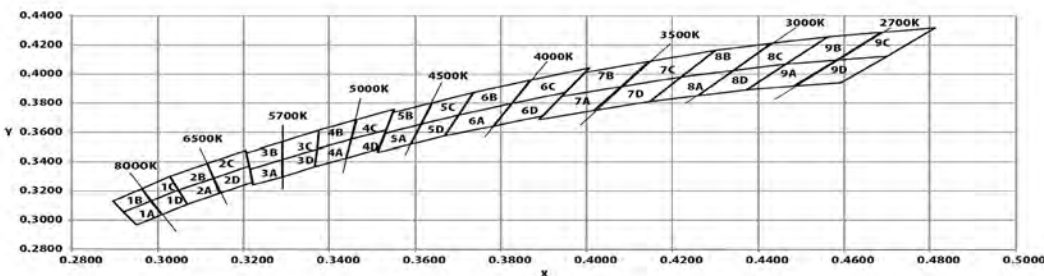

PLCC2, Power PLCC-4, Bicolor PLCC-4 and Tricolor PLCC-4

HSMx-Axxx-X₁-X₂-X₃-X₄-X₅



Intensity Bin Select (X₂, X₃)

Individual reel will contain parts from 1 half bin only. Single color (see data sheet for bicolor and tricolor).

| X ₁ | Minimum Iv Bin |
|----------------|--|
| X ₂ | Number of half Bins |
| 0 | Full Distribution |
| 2 | 2 half bins starting from X ₅ 1 |
| 3 | 3 half bins starting from X ₅ 1 |
| 4 | 4 half bins starting from X ₅ 1 |
| 5 | 5 half bins starting from X ₅ 1 |
| 6 | 2 half bins starting from X ₅ 2 |
| 7 | 3 half bins starting from X ₅ 2 |
| 8 | 4 half bins starting from X ₅ 2 |
| 9 | 5 half bins starting from X ₅ 2 |

Color Bin Selection (X₃)

Individual reel will contain parts from 1 full bin only. Single color (see data sheet for bicolor and tricolor).

| X ₃ | |
|----------------|-----------------------|
| 0 | Full Distribution |
| Z | A and B only |
| Y | B and C only |
| W | C and D only |
| V | D and E only |
| U | E and F only |
| T | F and G only |
| S | G and H only |
| Q | A, B and C only |
| P | B, C and D only |
| N | C, D and E only |
| M | D, E and F only |
| L | E, F and G only |
| K | F, G and H only |
| 1 | A, B, C and D only |
| 2 | E, F, G and H only |
| 3 | B, C, D and E only |
| 4 | C, D, E and F only |
| 5 | A, B, C, D and E only |
| 6 | B, C, D, E and F only |

Color Bin Limits for HSMW-Axxx

| Bin ID | Limits (Chromaticity Coordinates) | | | | |
|--------|-----------------------------------|-------|-------|-------|-------|
| A | X | 0.352 | 0.365 | 0.365 | 0.352 |
| | Y | 0.377 | 0.395 | 0.360 | 0.341 |
| B | X | 0.340 | 0.352 | 0.352 | 0.340 |
| | Y | 0.360 | 0.377 | 0.341 | 0.325 |
| C | X | 0.327 | 0.340 | 0.340 | 0.327 |
| | Y | 0.342 | 0.360 | 0.325 | 0.306 |
| D | X | 0.315 | 0.327 | 0.327 | 0.315 |
| | Y | 0.325 | 0.342 | 0.306 | 0.290 |
| E | X | 0.302 | 0.315 | 0.315 | 0.302 |
| | Y | 0.307 | 0.325 | 0.290 | 0.271 |
| F | X | 0.290 | 0.302 | 0.302 | 0.290 |
| | Y | 0.290 | 0.307 | 0.271 | 0.255 |

Tolerance of each bin limit = ± 0.02

Intensity Bin Limits

| Bin ID | Intensity (mcd) | |
|--------|-----------------|----------|
| | Min. | Max. |
| J1 | 4.50 | 5.60 |
| J2 | 5.60 | 7.20 |
| K1 | 7.20 | 9.00 |
| K2 | 9.00 | 11.20 |
| L1 | 11.20 | 14.00 |
| L2 | 14.00 | 18.00 |
| M1 | 18.00 | 22.40 |
| M2 | 22.40 | 28.50 |
| N1 | 28.50 | 35.50 |
| N2 | 35.50 | 45.00 |
| P1 | 45.00 | 56.00 |
| P2 | 56.00 | 71.50 |
| Q1 | 71.50 | 90.00 |
| Q2 | 90.00 | 112.50 |
| R1 | 112.50 | 140.00 |
| R2 | 140.00 | 180.00 |
| S1 | 180.00 | 224.00 |
| S2 | 224.00 | 285.00 |
| T1 | 285.00 | 355.00 |
| T2 | 355.00 | 450.00 |
| U1 | 450.00 | 560.00 |
| U2 | 560.00 | 715.00 |
| V1 | 715.00 | 900.00 |
| V2 | 900.00 | 1125.00 |
| W1 | 1125.00 | 1400.00 |
| W2 | 1400.00 | 1800.00 |
| X1 | 1800.00 | 2240.00 |
| X2 | 2240.00 | 2850.00 |
| Y1 | 2850.00 | 3550.00 |
| Y2 | 3550.00 | 4500.00 |
| Z1 | 4500.00 | 5600.00 |
| Z2 | 5600.00 | 7150.00 |
| 11 | 7150.00 | 9000.00 |
| 12 | 9000.00 | 11250.00 |
| 21 | 11250.00 | 14000.00 |
| 22 | 14000.00 | 18000.00 |

Tolerance of each bin limit = ± 12%

Color Coordinates Chart for HSMW-Axxx

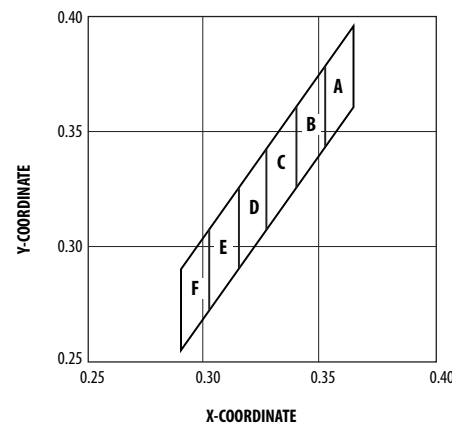

Color Bin Limits

| Color/Bin | Wavelength (nm) | |
|----------------------------|-----------------|-------|
| | Min. | Max. |
| Blue | | |
| A | 460.0 | 465.0 |
| B | 465.0 | 470.0 |
| C | 470.0 | 475.0 |
| D | 475.0 | 480.0 |
| Cyan | | |
| A | 490.0 | 495.0 |
| B | 495.0 | 500.0 |
| C | 500.0 | 505.0 |
| D | 505.0 | 510.0 |
| Green | | |
| A | 515.0 | 520.0 |
| B | 520.0 | 525.0 |
| C | 525.0 | 530.0 |
| D | 530.0 | 535.0 |
| Yellow Green/Emerald Green | | |
| A | 552.5 | 555.5 |
| B | 555.5 | 558.5 |
| C | 558.5 | 561.5 |
| D | 561.5 | 564.5 |
| E | 564.5 | 567.5 |
| F | 567.5 | 570.5 |
| G | 570.5 | 573.5 |
| H | 573.5 | 576.5 |
| Amber | | |
| A | 582.0 | 584.5 |
| B | 584.5 | 587.0 |
| C | 587.0 | 589.5 |
| D | 589.5 | 592.0 |
| E | 592.0 | 594.5 |
| F | 594.5 | 597.0 |
| Orange | | |
| A | 597.0 | 600.0 |
| B | 600.0 | 603.0 |
| C | 603.0 | 606.0 |
| D | 606.0 | 609.0 |
| E | 609.0 | 612.0 |
| Red Orange | | |
| A | 611.0 | 616.0 |
| B | 616.0 | 620.0 |
| Red | | |
| Full Distribution | 620i | 635 |

Tolerance of each bin limit = ± 1nm

Tricolor/Power PLCC-4

| Tricolor/Power PLCC-4 | | Bicolor PLCC-4 | |
|-----------------------|-------------------|----------------|-------------------|
| 1 | Cathode (Color 1) | 1 | Cathode (Color 1) |
| 2 | Common Anode | 2 | Anode (Color 1) |
| 3 | Cathode (Color 3) | 3 | Cathode (Color 2) |
| 4 | Cathode (Color 2) | 4 | Anode (Color 2) |

ASMD-FWG3-Nxxx6

Part Numbering System

| | | | | | | | | | | | | | | |
|---|---|---|---|---|---|---|----------------|---|---|---|----------------|----------------|----------------|----------------|
| A | S | M | B | - | F | W | X ₁ | 3 | - | N | X ₂ | X ₃ | X ₄ | X ₅ |
|---|---|---|---|---|---|---|----------------|---|---|---|----------------|----------------|----------------|----------------|

| Code | Description | Option | | | |
|----------------|-----------------------|----------------|-------------|---|----------------------|
| X ₁ | Color Rendering Index | G | CRI ≥ 80 | | |
| X ₂ | Minimum flux bin | M | 18 - 19 lm | | |
| | | N | 19 - 20 lm | | |
| | | P | 20 - 22 lm | | |
| | | Q | 22 - 24 lm | | |
| | | R | 24 - 26 lm | | |
| X ₃ | Maximum flux bin | S | 26 - 28 lm | | |
| | | T | 28 - 30 lm | | |
| | | A | 2700K | | |
| | | B | 3000K | | |
| X ₄ | Color Bin | C | 3500K | | |
| | | D | 4000K | | |
| | | E | 5000K | | |
| | | F | 5700K | | |
| | | G | 6200K | | |
| | | H | 6500K | | |
| | | J | 6800K | | |
| | | X ₅ | Test Option | 6 | Test current = 60 mA |

Example: ASMD-FWG3-NMSB6

- X₁ = G CRI ≥ 80
- X₂ = Q Minimum flux bin M
- X₃ = T Maximum flux bin 5
- X₄ = B Color bin 3000K with bin ID 29S
- X₅ = D Test current = 60 mA

Bin Information

Forward Voltage Bin (VF) Limits

| Bin ID | Forward Voltage, VF (V) at 65 mA | |
|--------|----------------------------------|------|
| | Min. | Max. |
| G03 | 2.8 | 2.9 |
| G04 | 2.9 | 3.0 |
| G05 | 3.0 | 3.1 |
| G06 | 3.1 | 3.2 |
| G07 | 3.2 | 3.3 |

Tolerance: ±0.1 V

Example of bin information on reel and packaging label:

- CAT: Q Flux bin Q
- BIN: 29S Bin ID 29S
- VF: G05 VF bin G05

Flux Bin (CAT) Limits

| Bin ID | Luminous Flux, ΦV (lm) at 65 mA | |
|--------|---------------------------------|------|
| | Min. | Max. |
| Q | 22 | 24 |
| R | 24 | 26 |
| S | 26 | 28 |
| T | 28 | 30 |
| U | 30 | 32 |

Tolerance: ±12 %

Chromaticity Diagram

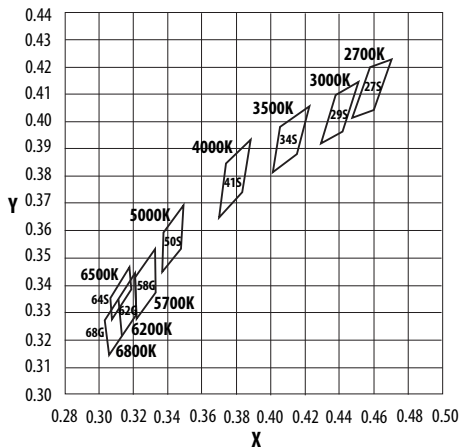

Color Bin (BIN) Limits

| CCT | Chromaticity Coordinates | | |
|------|--------------------------|--------|--------|
| | Bin ID | x | y |
| 2700 | 27S | 0.4475 | 0.4012 |
| | | 0.4582 | 0.4199 |
| | | 0.4708 | 0.4228 |
| | | 0.4598 | 0.4041 |
| 3000 | 29S | 0.4295 | 0.3918 |
| | | 0.4381 | 0.4097 |
| | | 0.4515 | 0.4145 |
| | | 0.4420 | 0.3962 |
| 3500 | 34S | 0.4006 | 0.3811 |
| | | 0.4061 | 0.3980 |
| | | 0.4226 | 0.4056 |
| | | 0.4150 | 0.3881 |
| 4000 | 41S | 0.3699 | 0.3646 |
| | | 0.3743 | 0.3846 |
| | | 0.3885 | 0.3934 |
| | | 0.3835 | 0.3741 |
| 5000 | 50S | 0.3372 | 0.3449 |
| | | 0.3378 | 0.3596 |
| | | 0.3496 | 0.3694 |
| | | 0.3478 | 0.3533 |
| 5700 | 58G | 0.3220 | 0.3280 |
| | | 0.3209 | 0.3425 |
| | | 0.3330 | 0.3533 |
| | | 0.3329 | 0.3375 |
| 6200 | 62G | 0.3133 | 0.3214 |
| | | 0.3113 | 0.3350 |
| | | 0.3208 | 0.3444 |
| | | 0.3219 | 0.3296 |
| 6500 | 64S | 0.3079 | 0.3274 |
| | | 0.3068 | 0.3354 |
| | | 0.3181 | 0.3467 |
| | | 0.3192 | 0.3387 |
| 6800 | 68G | 0.3061 | 0.3145 |
| | | 0.3035 | 0.3272 |
| | | 0.3113 | 0.3350 |
| | | 0.3133 | 0.3214 |

Tolerance: ±0.01

ASMD-LWG3-NxxxD

Part Numbering System

| | | | | | | | | | | | | | | |
|---|---|---|---|---|---|---|----------------|---|---|---|----------------|----------------|----------------|----------------|
| A | S | M | B | - | L | W | X ₁ | 3 | - | N | X ₂ | X ₃ | X ₄ | X ₅ |
|---|---|---|---|---|---|---|----------------|---|---|---|----------------|----------------|----------------|----------------|

| Code | Description | Option | |
|----------------|-----------------------|--------|----------------------|
| X ₁ | Color Rendering Index | G | CRI ≥ 80 |
| X ₂ | Minimum flux bin | P | 20 - 22 lm |
| | | Q | 22 - 24 lm |
| | | R | 24 - 26 lm |
| | | S | 26 - 28 lm |
| | | T | 28 - 30 lm |
| X ₃ | Maximum flux bin | R | 24 - 26 lm |
| | | S | 26 - 28 lm |
| | | T | 28 - 30 lm |
| | | | |
| X ₄ | Color Bin | A | 2700K |
| | | B | 3000K |
| | | C | 3500K |
| | | D | 4000K |
| | | E | 5000K |
| | | F | 5700K |
| | | G | 6200K |
| | | H | 6500K |
| | | J | 6800K |
| | | | |
| X ₅ | Test Option | 6 | Test current = 65 mA |

Example: ASMD-FWG3-NMSB6

- X₁ = G CRI ≥ 80
- X₂ = Q Minimum flux bin Q
- X₃ = T Maximum flux bin T
- X₄ = B Color bin 3000K with bin ID 29S
- X₅ = D Test current = 65 mA

Bin Information

Forward Voltage Bin (VF) Limits

| Bin ID | Forward Voltage, VF (V) at 65 mA | |
|--------|----------------------------------|------|
| | Min. | Max. |
| G03 | 2.8 | 2.9 |
| G04 | 2.9 | 3.0 |
| G05 | 3.0 | 3.1 |
| G06 | 3.1 | 3.2 |
| G07 | 3.2 | 3.3 |

Tolerance: ±0.1 V

Example of bin information on reel and packaging label:

- CAT: Q Flux bin Q
- BIN: 29S Bin ID 29S
- VF: G05 VF bin G05

Flux Bin (CAT) Limits

| Bin ID | Luminous Flux, ΦV (lm) at 65 mA | |
|--------|---------------------------------|------|
| | Min. | Max. |
| Q | 22 | 24 |
| R | 24 | 26 |
| S | 26 | 28 |
| T | 28 | 30 |
| U | 30 | 32 |

Tolerance: ±12 %

Chromaticity Diagram

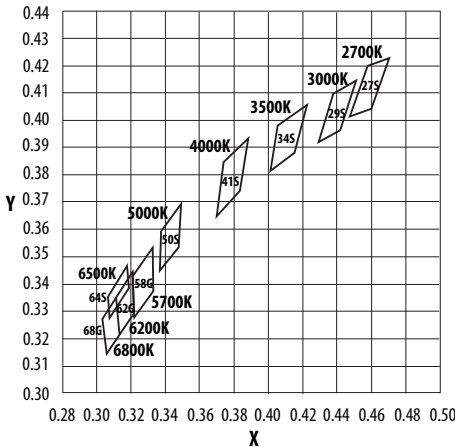

Color Bin (BIN) Limits

| CCT | Chromaticity Coordinates | | |
|------|--------------------------|--------|--------|
| | Bin ID | x | y |
| 2700 | 27S | 0.4475 | 0.4012 |
| | | 0.4582 | 0.4199 |
| | | 0.4708 | 0.4228 |
| | | 0.4598 | 0.4041 |
| 3000 | 29S | 0.4295 | 0.3918 |
| | | 0.4381 | 0.4097 |
| | | 0.4515 | 0.4145 |
| | | 0.4420 | 0.3962 |
| 3500 | 34S | 0.4006 | 0.3811 |
| | | 0.4061 | 0.3980 |
| | | 0.4226 | 0.4056 |
| | | 0.4150 | 0.3881 |
| 4000 | 41S | 0.3699 | 0.3646 |
| | | 0.3743 | 0.3846 |
| | | 0.3885 | 0.3934 |
| | | 0.3835 | 0.3741 |
| 5000 | 50S | 0.3372 | 0.3449 |
| | | 0.3378 | 0.3596 |
| | | 0.3496 | 0.3694 |
| | | 0.3478 | 0.3533 |
| 5700 | 58G | 0.3220 | 0.3280 |
| | | 0.3209 | 0.3425 |
| | | 0.3330 | 0.3533 |
| | | 0.3329 | 0.3375 |
| 6200 | 62G | 0.3133 | 0.3214 |
| | | 0.3113 | 0.3350 |
| | | 0.3208 | 0.3444 |
| | | 0.3219 | 0.3296 |
| 6500 | 64S | 0.3079 | 0.3274 |
| | | 0.3068 | 0.3354 |
| | | 0.3181 | 0.3467 |
| | | 0.3192 | 0.3387 |
| 6800 | 68G | 0.3061 | 0.3145 |
| | | 0.3035 | 0.3272 |
| | | 0.3113 | 0.3350 |
| | | 0.3133 | 0.3214 |

Tolerance ±0.01

ASMF-LWG4-NxxxD

Part Numbering System

| | | | | | | | | | | | | | | |
|---|---|---|---|---|---|---|----------------|---|---|---|----------------|----------------|----------------|----------------|
| A | S | M | B | - | L | W | X ₁ | 0 | - | N | X ₂ | X ₃ | X ₄ | X ₅ |
|---|---|---|---|---|---|---|----------------|---|---|---|----------------|----------------|----------------|----------------|

| Code | Description | Option | |
|----------------|-----------------------|----------------|-------------|
| X ₁ | Color Rendering Index | G | CRI ≥ 80 |
| X ₂ | Minimum flux bin | Q | 20 - 22 lm |
| X ₃ | Maximum flux bin | R | 22 - 24 lm |
| | | S | 24 - 26 lm |
| | | T | 26 - 28 lm |
| | | U | 30 - 32 lm |
| X ₄ | Color Bin | A | 2700K |
| | | B | 3000K |
| | | C | 3500K |
| | | D | 4000K |
| | | E | 5000K |
| | | F | 5700K |
| | | G | 6200K |
| | | H | 6500K |
| | | J | 6800K |
| | | X ₅ | Test Option |

Example: ASMD-FWG3-NMSB6

- X₁ = G CRI ≥ 80
- X₂ = Q Minimum flux bin Q
- X₃ = T Maximum flux bin T
- X₄ = B Color bin 3000K with bin ID 29S
- X₅ = D Test current = 65 mA

Bin Information

Forward Voltage Bin (VF) Limits

| Bin ID | Forward Voltage, VF (V) at 65 mA | |
|--------|----------------------------------|------|
| | Min. | Max. |
| G01 | 2.6 | 2.7 |
| G02 | 2.7 | 2.8 |
| G03 | 2.8 | 2.9 |
| G04 | 2.9 | 3.0 |
| G05 | 3.0 | 3.1 |

Tolerance: ±0.1 V

Example of bin information on reel and packaging label:

- CAT: Q Flux bin Q
- BIN: 29S Bin ID 29S
- VF: G05 VF bin G05

Color Bin (BIN) Limits

| CCT | Chromaticity Coordinates | | |
|------|--------------------------|--------|--------|
| | Bin ID | x | y |
| 2700 | 27S | 0.4475 | 0.4012 |
| | | 0.4582 | 0.4199 |
| | | 0.4708 | 0.4228 |
| | | 0.4598 | 0.4041 |
| 3000 | 29S | 0.4295 | 0.3918 |
| | | 0.4381 | 0.4097 |
| | | 0.4515 | 0.4145 |
| | | 0.4420 | 0.3962 |
| | | 0.4226 | 0.4056 |
| 3500 | 34S | 0.4006 | 0.3811 |
| | | 0.4061 | 0.3980 |
| | | 0.4150 | 0.3881 |
| 4000 | 41S | 0.3699 | 0.3646 |
| | | 0.3743 | 0.3846 |
| | | 0.3885 | 0.3934 |
| | | 0.3835 | 0.3741 |
| | | 0.3478 | 0.3533 |
| 5000 | 50S | 0.3372 | 0.3449 |
| | | 0.3378 | 0.3596 |
| | | 0.3496 | 0.3694 |
| | | 0.3478 | 0.3533 |
| | | 0.3220 | 0.3280 |
| 5700 | 58G | 0.3220 | 0.3280 |
| | | 0.3209 | 0.3425 |
| | | 0.3330 | 0.3533 |
| | | 0.3329 | 0.3375 |
| | | 0.3133 | 0.3214 |
| 6200 | 62G | 0.3133 | 0.3214 |
| | | 0.3113 | 0.3350 |
| | | 0.3208 | 0.3444 |
| | | 0.3219 | 0.3296 |
| | | 0.3079 | 0.3274 |
| 6500 | 64S | 0.3079 | 0.3274 |
| | | 0.3068 | 0.3354 |
| | | 0.3181 | 0.3467 |
| | | 0.3192 | 0.3387 |
| | | 0.3061 | 0.3145 |
| 6800 | 68G | 0.3061 | 0.3145 |
| | | 0.3035 | 0.3272 |
| | | 0.3113 | 0.3350 |
| | | 0.3133 | 0.3214 |

Tolerance ±0.01

Flux Bin (CAT) Limits

| Bin ID | Luminous Flux, ΦV (lm) at 65 mA | |
|--------|---------------------------------|------|
| | Min. | Max. |
| Q | 22 | 24 |
| R | 24 | 26 |
| S | 26 | 28 |
| T | 28 | 30 |
| U | 30 | 32 |

Tolerance: ±12 %

Chromaticity Diagram

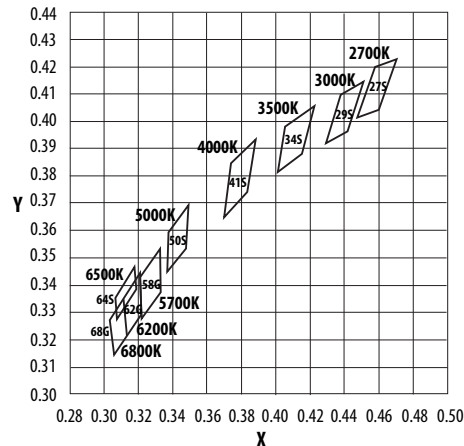

ASMW-FWGO-Nxxx6

Part Numbering System

| | | | | | | | | | | | | | | |
|---|---|---|---|---|---|---|----|---|---|---|----------------|----------------|----------------|----------------|
| A | S | M | W | - | F | W | x1 | 0 | - | N | X ₂ | X ₃ | X ₄ | X ₅ |
|---|---|---|---|---|---|---|----|---|---|---|----------------|----------------|----------------|----------------|

| Code | Description | Option | Sub Bins | |
|----------------|-----------------------|--------|----------------------|----------------|
| X ₁ | Color Rendering Index | G | CRI ≥ 80 | |
| X ₂ | Minimum flux bin | H | 19.0 - 20.0lm | |
| X ₃ | Maximum flux bin | J | 20.0 - 22.0lm | |
| | | K | 22.0 - 24.0lm | |
| | | L | 24.0 - 26.0lm | |
| X ₄ | Color Bin | H | 3000K | 8A, 8B, 8C, 8D |
| | | F | 4000K | 6A, 6B, 6C, 6D |
| | | B | 6500K | 2A, 2B, 2C, 2D |
| X ₅ | Test Option | 6 | Test current = 60 mA | |

Example: ASMW-FWGO-NHKKH6

- X₁ = G CRI ≥ 80
- X₂ = H Minimum flux bin H
- X₃ = K Maximum flux bin K
- X₄ = H 3000K with sub bins 8A, 8B, 8C, 8D
- X₅ = 6 Test current = 60 mA

Bin Information

Forward Voltage Bin (VF) Limits

| Bin ID | Forward Voltage, VF (V) at 65 mA | |
|--------|----------------------------------|------|
| | Min. | Max. |
| G03 | 2.8 | 2.9 |
| G04 | 2.9 | 3.0 |
| G05 | 3.0 | 3.1 |
| G06 | 3.1 | 3.2 |
| G07 | 3.2 | 3.3 |

Tolerance: ±0.1 V

Flux Bin (CAT) Limits

| Bin ID | Luminous Flux (lm) | |
|--------|--------------------|------|
| | Min. | Max. |
| H | 19.0 | 20.0 |
| J | 20.0 | 22.0 |
| K | 22.0 | 24.0 |
| L | 24.0 | 26.0 |

Tolerance: ±12 %

Color Bins (BIN)

| CCT | Bin ID | Cx | Cy |
|-------|--------|--------|--------|
| 3000K | 8A | 0.1686 | 0.6821 |
| | | 0.1097 | 0.8067 |
| | | 0.1329 | 0.7983 |
| | | 0.1856 | 0.6759 |
| | 8B | 0.1856 | 0.6759 |
| | | 0.1329 | 0.7983 |
| | | 0.1561 | 0.7865 |
| | | 0.2027 | 0.6673 |
| | 8C | 0.2027 | 0.6673 |
| | | 0.1561 | 0.7865 |
| | | 0.1784 | 0.7734 |
| | | 0.2192 | 0.6576 |
| 8D | 0.4259 | 0.3853 | |
| | 0.4342 | 0.4028 | |
| | 0.4465 | 0.4071 | |
| | 0.4373 | 0.3893 | |
| 4000K | 6A | 0.3670 | 0.3578 |
| | | 0.3702 | 0.3722 |
| | | 0.3825 | 0.3798 |
| | | 0.3783 | 0.3646 |
| | 6B | 0.3702 | 0.3722 |
| | | 0.3736 | 0.3874 |
| | | 0.3869 | 0.3958 |
| | | 0.3825 | 0.3798 |
| | 6C | 0.3825 | 0.3798 |
| | | 0.3869 | 0.3958 |
| | | 0.4006 | 0.4044 |
| | | 0.3950 | 0.3875 |
| 6D | 0.3783 | 0.3646 | |
| | 0.3825 | 0.3798 | |
| | 0.3950 | 0.3875 | |
| | 0.3898 | 0.3716 | |

Color Bins (BIN) cont.

| CCT | Bin ID | Cx | Cy |
|-------|--------|--------|--------|
| 6500K | 2A | 0.3048 | 0.3207 |
| | | 0.3130 | 0.3290 |
| | | 0.3144 | 0.3186 |
| | | 0.3068 | 0.3113 |
| | 2B | 0.3028 | 0.3304 |
| | | 0.3115 | 0.3391 |
| | | 0.3130 | 0.3290 |
| | | 0.3048 | 0.3207 |
| | 2C | 0.3115 | 0.3391 |
| | | 0.3205 | 0.3481 |
| | | 0.3213 | 0.3373 |
| | | 0.3130 | 0.3290 |
| | DD | 0.3130 | 0.3290 |
| | | 0.3213 | 0.3373 |
| | | 0.3221 | 0.3261 |
| | | 0.3144 | 0.3186 |

Tolerance ±0.01

Example of bin information on reel and packaging label:

- CAT: J Flux bin J
- BIN: 2A Color sub-bin 2A
- VF: G05 VF bin G05

Chromaticity Diagram (3000K, 4000K and 6500K)

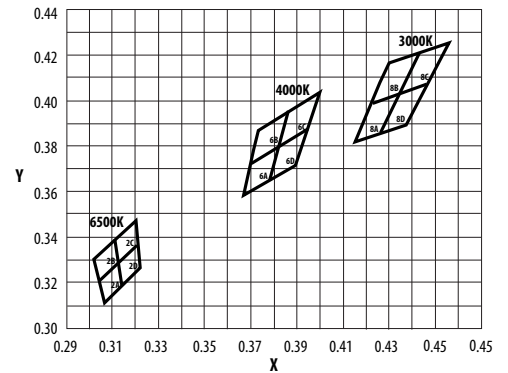

PLCC Surface Mount LEDs

ASMT-SWBM-N X₂-X₃-X₄-X₅

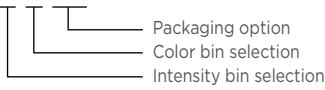

Intensity Bin Selection (X₂X₃)

Individual reel will contain parts from one half bin only.

| X ₂ | Minimum I _V Bin |
|----------------|--|
| X ₃ | Number of half bins |
| 0 | Full Distribution |
| 2 | 2 half bins starting from X ₂ 1 |
| 3 | 3 half bins starting from X ₂ 1 |
| 4 | 4 half bins starting from X ₂ 1 |
| 5 | 5 half bins starting from X ₂ 1 |
| 6 | 2 half bins starting from X ₂ 2 |
| 7 | 3 half bins starting from X ₂ 2 |
| 8 | 4 half bins starting from X ₂ 2 |
| 9 | 5 half bins starting from X ₂ 2 |

Intensity Bin Limits

| Bin ID | Min. (mcd) | Max. (mcd) |
|--------|------------|------------|
| N1 | 28.50 | 35.50 |
| N2 | 35.50 | 45.00 |
| P1 | 45.00 | 56.00 |
| P2 | 56.00 | 71.50 |
| Q1 | 71.50 | 90.00 |
| Q2 | 90.00 | 112.50 |
| R1 | 112.50 | 140.00 |
| R2 | 140.00 | 180.00 |
| S1 | 180.00 | 224.00 |
| S2 | 224.00 | 285.00 |
| T1 | 285.00 | 355.00 |
| T2 | 355.00 | 450.00 |
| U1 | 450.00 | 560.00 |
| U2 | 560.00 | 715.00 |
| V1 | 715.00 | 900.00 |
| V2 | 900.00 | 1125.00 |
| W1 | 1125.00 | 1400.00 |
| W2 | 1400.00 | 1800.00 |

Tolerance of each bin limit = ± 12%

Long Life PLCC-4 ASMT-SWBM Packaging Option (X₄X₅)

| X ₄ X ₅ | Test Current | Package Type | Reel Size |
|-------------------------------|--------------|---------------|-----------|
| M1 | 50 mA | Top Mount | 7/13 Inch |
| M2 | 30 mA | Top Mount | 7/13 Inch |
| J1 | 20 mA | Top Mount | 7 Inch |
| J4 | 20 mA | Top Mount | 13 Inch |
| H1 | 20 mA | Reverse Mount | 7 Inch |
| H4 | 20 mA | Reverse Mount | 13 Inch |

Color Bin Selection (X₄)

Individual reel will contain parts from one full bin only.

| X ₄ | Color Bin Selection |
|----------------|--------------------------|
| 0 | Full Distributon |
| A | 1 and 2 only |
| B | 2 and 3 only |
| C | 3 and 4 only |
| D | 4 and 5 only |
| E | 5 and 6 only |
| F | 6 and 7 only |
| G | 1, 2 and 3 only |
| H | 2, 3 and 4 only |
| J | 3, 4 and 5 only |
| K | 4, 5 and 6 only |
| L | 5, 6 and 7 only |
| M | 1, 2, 3 and 4 only |
| N | 2, 3, 4 and 5 only |
| P | 3, 4, 5 and 6 only |
| Q | 4, 5, 6 and 7 only |
| R | 1, 2, 3, 4 and 5 only |
| S | 2, 3, 4, 5 and 6 only |
| T | 3, 4, 5, 6, and 7 only |
| U | 1, 2, 3, 4, 5 and 6 only |
| V | 2, 3, 4, 5,6 and 7 only |
| Z | Special Color Bin |

Packaging Option (X₅)

| X ₅ | Test Current | Package Type | Reel Size |
|----------------|--------------|--------------|-----------|
| 3 | 30 mA | Top Mount | 7 inch |

V_F Bin Limits

| Bin ID | Min. | Max. |
|--------|------|------|
| S3 | 3.20 | 3.80 |
| S4 | 3.80 | 4.35 |

Tolerance of each bin limit = ± 0.1V

Color Bin Limits

| Bin ID | Limits (Chromaticity Coordinates) | | | | |
|--------|-----------------------------------|-------|-------|-------|-------|
| 1 | x | 0.296 | 0.291 | 0.310 | 0.313 |
| | y | 0.259 | 0.268 | 0.297 | 0.284 |
| 2 | x | 0.291 | 0.285 | 0.307 | 0.310 |
| | y | 0.268 | 0.279 | 0.312 | 0.297 |
| 3 | x | 0.313 | 0.310 | 0.330 | 0.330 |
| | y | 0.284 | 0.297 | 0.330 | 0.310 |
| 4 | x | 0.310 | 0.307 | 0.330 | 0.330 |
| | y | 0.297 | 0.312 | 0.347 | 0.330 |
| 5 | x | 0.330 | 0.330 | 0.338 | 0.352 |
| | y | 0.310 | 0.330 | 0.342 | 0.344 |
| 6 | x | 0.330 | 0.330 | 0.347 | 0.345 |
| | y | 0.330 | 0.347 | 0.371 | 0.352 |
| 7 | x | 0.352 | 0.338 | 0.364 | 0.360 |
| | y | 0.344 | 0.342 | 0.380 | 0.357 |
| 8 | x | 0.345 | 0.347 | 0.367 | 0.364 |
| | y | 0.352 | 0.371 | 0.401 | 0.380 |

Tolerance of each bin limit = ± 0.02

Color Coordinates Chart for ASMT-SWBM

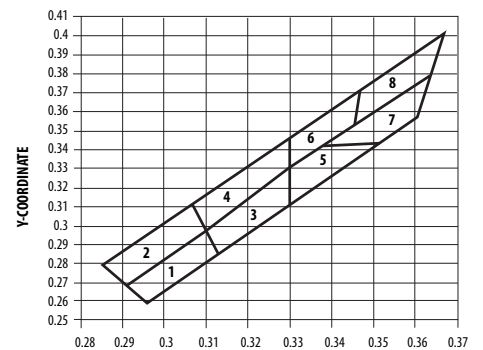

High Brightness Tricolor PLCC-4 and PLCC-6

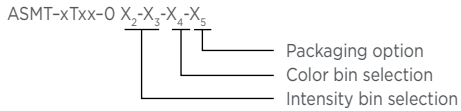

For ASMB-BTE1

| X ₂ | Min Iv Bin (Minimum Intensity Bin) | | |
|----------------|------------------------------------|-------|------|
| | Red | Green | Blue |
| B | U1 | W1 | T1 |

For ASMB-MTBO/MTB1

| X ₂ | Min Iv Bin (Minimum Intensity Bin) | | |
|----------------|------------------------------------|-------|------|
| | Red | Green | Blue |
| A | U1 | W1 | T1 |

For ASMB-MTC1

| X ₂ | Min Iv Bin (Minimum Intensity Bin) | | |
|----------------|------------------------------------|-------|------|
| | Red | Green | Blue |
| A | S1 | U2 | R1 |

For ASMB-TTBO/TTB2

| X ₂ | Min Iv Bin (Minimum Intensity Bin) | | |
|----------------|------------------------------------|-------|------|
| | Red | Green | Blue |
| A | U2 | X1 | T2 |
| C | U2 | W2 | T1 |

For ASMT-YTB2/YTD2

| X ₂ | Min Iv Bin (Minimum Intensity Bin) | | |
|----------------|------------------------------------|-------|------|
| | Red | Green | Blue |
| B | U2 | W1 | T1 |

For ASMT-YTC2

| X ₂ | Min Iv Bin (Minimum Intensity Bin) | | |
|----------------|------------------------------------|-------|------|
| | Red | Green | Blue |
| A | T2 | U1 | R2 |

For ASMT-YTB7/D7

| X ₂ | Min Iv Bin (Minimum Intensity Bin) | | |
|----------------|------------------------------------|-------|------|
| | Red | Green | Blue |
| A | U2 | W2 | T1 |

For ASMT-YTC7

| X ₂ | Min Iv Bin (Minimum Intensity Bin) | | |
|----------------|------------------------------------|-------|------|
| | Red | Green | Blue |
| A | S2 | U2 | R1 |

For ASMB-BTE1 /MTBO/MTB1/TTBO/TTB2

| X ₃ | Number of Half Bin from X2 | | |
|----------------|----------------------------|-------|------|
| | Red | Green | Blue |
| 3 | 3 | 3 | 3 |

For ASMT-YTB2/YTD2

| X ₃ | Number of Half Bin from X2 | | |
|----------------|----------------------------|-------|------|
| | Red | Green | Blue |
| B | 3 | 3 | 3 |

For ASMT-YTC2/YTB7/YTD7/YTC7

| X ₃ | Number of Half Bin from X2 | | |
|----------------|----------------------------|-------|------|
| | Red | Green | Blue |
| A | 3 | 3 | 3 |

Intensity Bin Limits

| Bin ID | Min (mcd) | Max (mcd) |
|--------|-----------|-----------|
| R1 | 112.5 | 140 |
| R2 | 140 | 180 |
| S1 | 180 | 224 |
| S2 | 224 | 285 |
| T1 | 285 | 355 |
| T2 | 355 | 450 |
| U1 | 450 | 560 |
| U2 | 560 | 715 |
| V1 | 715 | 900 |
| V2 | 900 | 1125 |
| W1 | 1125 | 1400 |
| W2 | 1400 | 1800 |
| X1 | 1800 | 2240 |
| X2 | 2250 | 2850 |
| Y1 | 2850 | 3550 |

Tolerance of each bin limit = ± 12%

Color Bin Selection (X₄)

For ASMB-MTBO/MTB1

| X ₄ | Color Bin Combination | | |
|----------------|-----------------------|-------|-------|
| | Red | Green | Blue |
| A | Full Distribution | A,B,D | A,B,C |

For ASMB-BTE1

| X ₄ | Color Bin Combination | | |
|----------------|-----------------------|-------|-------|
| | Red | Green | Blue |
| 3 | Full Distribution | A,B,D | A,B,C |

Color Bin Selection (X₄)

For ASMB-TTBO/TTB2

| X ₄ | Color Bin Combination | | |
|----------------|-----------------------|-------|-------|
| | Red | Green | Blue |
| A | Full distribution | E,A,B | A,B,C |

For ASMT-YTB2/YTC2/YTD2

| X ₄ | Color Bin Combination | | |
|----------------|-----------------------|-------|-----------|
| | Red | Green | Blue |
| 0 | Full distribution | A,B,C | A,B,C,D,E |

For ASMT-YTB7/YTC7/YTD7

| X ₄ | Color Bin Combination | | |
|----------------|-----------------------|-------|---------|
| | Red | Green | Blue |
| 0 | Full distribution | A,B,C | A,B,C,D |

For ASMB-6Wx0/6Ex0

| X ₂ | Intensity Bin Range |
|----------------|--------------------------------|
| A | 1600- 2600 |
| X ₃ | Number of intensity bin |
| 1 | 1 |
| | Color bin |
| 0 | Full dsitribution |
| X ₄ | Test Current |
| 1 | Red 14mA, Green 11mA, Blue 9mA |

Note: please refer to respective datasheet for color bin limits information

Packaging Option (X5):Please refer to respective data sheet for related information.

Super 0.5W Power PLCC-4

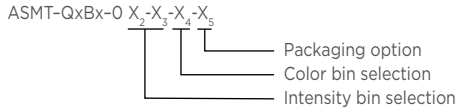

Flux Bin Selection (X₂X₃)

Individual reel will contain parts from one bin only.

| X ₂ | Min Flux Bin |
|----------------|--------------|
| X ₃ | Max Flux Bin |

Flux Bin Limits

| Bin ID | Min. (lm) | Max. (lm) |
|--------|-----------|-----------|
| O | 3.40 | 4.30 |
| A | 4.30 | 5.50 |
| B | 5.50 | 7.00 |
| C | 7.00 | 9.00 |
| D | 9.00 | 11.50 |
| E | 11.50 | 15.00 |
| F | 15.00 | 19.50 |
| G | 19.50 | 25.50 |
| H | 25.50 | 33.00 |
| J | 33.00 | 43.00 |
| K | 43.00 | 56.00 |
| L | 56.00 | 73.00 |

Tolerance of each bin limit = ± 12%

V_F Binning for AllInGaP Devices (ASMT-QAxx/QHxx/QRxx)

| Bin ID | Min. | Max. |
|--------|------|------|
| 2D | 2.35 | 2.50 |
| 2E | 2.50 | 2.65 |
| 2F | 2.65 | 2.80 |
| 2G | 2.80 | 2.95 |
| 2H | 2.95 | 3.10 |
| 2J | 3.10 | 3.25 |
| 2K | 3.25 | 3.40 |
| 2L | 3.40 | 3.55 |
| 2M | 3.55 | 3.70 |
| 2N | 3.70 | 3.85 |

Tolerance of each bin limit = ± 0.1V

Color Bin Selection (X₄)

Individual reel will contain parts from one full bin only.

| X ₄ | |
|----------------|-----------------------|
| O | Full Distribution |
| A | 1 and 2 only |
| B | 2 and 3 only |
| C | 3 and 4 only |
| D | 4 and 5 only |
| E | 5 and 6 only |
| G | 1, 2 and 3 only |
| H | 2, 3 and 4 only |
| J | 3, 4 and 5 only |
| K | 4, 5 and 6 only |
| M | 1, 2, 3 and 4 only |
| N | 2, 3, 4 and 5 only |
| P | 3, 4, 5 and 6 only |
| R | 1, 2, 3, 4 and 5 only |
| S | 2, 3, 4, 5 and 6 only |
| Z | Special Color Bin |

V_F Bin Limits for InGaN Devices (ASMT-QBxx/QGxx)

| Bin ID | Min. | Max. |
|--------|------|------|
| S5 | 3.20 | 3.50 |
| S6 | 3.50 | 3.80 |
| S7 | 3.80 | 4.10 |

Tolerance of each bin limit = ± 0.1V

Color Bin Limits

| Color/Bin | Wavelength (nm) | |
|-------------------|-----------------|-------|
| | Min. | Max. |
| Blue | | |
| 1 | 460.0 | 465.0 |
| 2 | 465.0 | 470.0 |
| 8 | 450.0 | 455.0 |
| 9 | 455.0 | 460.0 |
| Green | | |
| 1 | 515.0 | 520.0 |
| 2 | 520.0 | 525.0 |
| 3 | 525.0 | 530.0 |
| 4 | 530.0 | 535.0 |
| Amber | | |
| 2 | 583.0 | 586.0 |
| 3 | 586.0 | 589.0 |
| 4 | 589.0 | 592.0 |
| 5 | 592.0 | 595.0 |
| 6 | 595.0 | 598.0 |
| Red Orange | | |
| 1 | 611.0 | 616.0 |
| 2 | 616.0 | 620.0 |
| 3 | 620.0 | 625.0 |
| Red | | |
| Full Distribution | 620.0 | 635.0 |

Tolerance of each bin limit = ±1nm

Packaging Option (X₅)

| X ₅ | Test Current) | Package Type | Reel Size |
|----------------|---------------|--------------|-----------|
| E | 150 mA | Top Mount | 7 inch |

Super 0.5W White Power PLCC-4

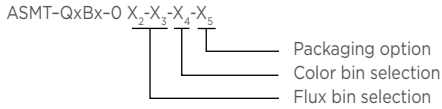

Flux Bin Selection (X₂X₃)

Individual reel will contain parts from one bin only

| | |
|----------------|--------------|
| X ₂ | Min Flux Bin |
| X ₃ | Min Flux Bin |

Flux Bin Limits

| Bin ID | Min. (lm) | Max. (lm) |
|--------|-----------|-----------|
| O | 3.40 | 4.30 |
| A | 4.30 | 5.50 |
| B | 5.50 | 7.00 |
| C | 7.00 | 9.00 |
| D | 9.00 | 11.50 |
| E | 11.50 | 15.00 |
| F | 15.00 | 19.50 |
| G | 19.50 | 25.50 |
| H | 25.50 | 33.00 |
| J | 33.00 | 43.00 |
| K | 43.00 | 56.00 |
| L | 56.00 | 73.00 |

Tolerance of each bin limit = ± 12%

Color Bin Selection (X₄) for ASMT-QWBx

Individual reel will contain parts from one sub bin only.

| X ₄ | |
|----------------|------------------------|
| O | Full Distribution |
| A | 5K and 5L only |
| B | 6K and 6L only |
| C | 7K and 7L only |
| D | 8K and 8L only |
| E | 5K and 6K only |
| F | 5L and 6L only |
| G | 6K and 7K only |
| H | 6L and 7L only |
| J | 7K and 8K only |
| K | 7L and 8L only |
| L | 5K, 5L, 6K and 6L only |
| M | 6K, 6L, 7K and 7L only |
| N | 7K, 7L, 8K and 8L only |
| Z | Special binning |

Color Bin Limits for ASMT-QWBx

| Bin ID | Sub Bin ID | Limits (Chromaticity Coordinates) | | | | |
|--------|------------|-----------------------------------|-------|-------|-------|-------|
| 5K | 5Ka | x | 0.296 | 0.304 | 0.302 | 0.294 |
| | | y | 0.259 | 0.270 | 0.276 | 0.264 |
| | 5Kb | x | 0.294 | 0.302 | 0.300 | 0.291 |
| | | y | 0.264 | 0.276 | 0.281 | 0.268 |
| | 5Kc | x | 0.304 | 0.313 | 0.312 | 0.302 |
| | | y | 0.270 | 0.284 | 0.291 | 0.276 |
| | 5Kd | x | 0.302 | 0.312 | 0.310 | 0.300 |
| | | y | 0.276 | 0.291 | 0.297 | 0.281 |
| 5L | 5La | x | 0.291 | 0.300 | 0.298 | 0.288 |
| | | y | 0.268 | 0.281 | 0.288 | 0.274 |
| | 5Lb | x | 0.288 | 0.298 | 0.295 | 0.285 |
| | | y | 0.274 | 0.288 | 0.294 | 0.279 |
| | 5Lc | x | 0.300 | 0.310 | 0.309 | 0.298 |
| | | y | 0.281 | 0.297 | 0.305 | 0.288 |
| | 5Ld | x | 0.298 | 0.309 | 0.307 | 0.295 |
| | | y | 0.288 | 0.305 | 0.312 | 0.294 |
| 6K | 6Ka | x | 0.313 | 0.322 | 0.321 | 0.312 |
| | | y | 0.284 | 0.297 | 0.305 | 0.291 |
| | 6Kb | x | 0.312 | 0.321 | 0.320 | 0.310 |
| | | y | 0.291 | 0.305 | 0.314 | 0.297 |
| | 6Kc | x | 0.322 | 0.330 | 0.330 | 0.321 |
| | | y | 0.297 | 0.310 | 0.320 | 0.305 |
| | 6Kd | x | 0.321 | 0.330 | 0.330 | 0.320 |
| | | y | 0.305 | 0.320 | 0.330 | 0.314 |

Tolerance of each bin limit = ± 0.02

Color Bin Limits cont.

| Bin ID | Sub Bin ID | Limits (Chromaticity Coordinates) | | | | |
|--------|------------|-----------------------------------|-------|-------|-------|-------|
| 6L | 6La | x | 0.310 | 0.320 | 0.319 | 0.309 |
| | | y | 0.297 | 0.314 | 0.322 | 0.305 |
| | 6Lb | x | 0.309 | 0.319 | 0.318 | 0.307 |
| | | y | 0.305 | 0.322 | 0.329 | 0.312 |
| | 6Lc | x | 0.320 | 0.330 | 0.330 | 0.319 |
| | | y | 0.314 | 0.330 | 0.339 | 0.322 |
| | 6Ld | x | 0.319 | 0.330 | 0.330 | 0.318 |
| | | y | 0.322 | 0.339 | 0.347 | 0.329 |
| 7K | 7Ka | x | 0.330 | 0.336 | 0.337 | 0.330 |
| | | y | 0.310 | 0.320 | 0.330 | 0.320 |
| | 7Kb | x | 0.330 | 0.337 | 0.337 | 0.330 |
| | | y | 0.320 | 0.330 | 0.341 | 0.330 |
| | 7Kc | x | 0.336 | 0.343 | 0.344 | 0.337 |
| | | y | 0.320 | 0.331 | 0.341 | 0.330 |
| | 7Kd | x | 0.337 | 0.344 | 0.345 | 0.337 |
| | | y | 0.330 | 0.341 | 0.352 | 0.341 |
| 7L | 7La | x | 0.330 | 0.337 | 0.337 | 0.330 |
| | | y | 0.330 | 0.341 | 0.349 | 0.339 |
| | 7Lb | x | 0.330 | 0.337 | 0.338 | 0.330 |
| | | y | 0.339 | 0.349 | 0.358 | 0.347 |
| | 7Lc | x | 0.337 | 0.345 | 0.346 | 0.337 |
| | | y | 0.341 | 0.352 | 0.362 | 0.349 |
| | 7Ld | x | 0.337 | 0.346 | 0.347 | 0.338 |
| | | y | 0.349 | 0.362 | 0.371 | 0.358 |
| 8K | 8Ka | x | 0.343 | 0.351 | 0.352 | 0.344 |
| | | y | 0.331 | 0.343 | 0.354 | 0.341 |
| | 8Kb | x | 0.344 | 0.352 | 0.354 | 0.345 |
| | | y | 0.341 | 0.354 | 0.364 | 0.352 |
| | 8Kc | x | 0.351 | 0.360 | 0.362 | 0.352 |
| | | y | 0.343 | 0.357 | 0.369 | 0.354 |
| | 8Kd | x | 0.352 | 0.362 | 0.364 | 0.354 |
| | | y | 0.354 | 0.369 | 0.380 | 0.364 |
| 8L | 8La | x | 0.345 | 0.354 | 0.355 | 0.346 |
| | | y | 0.352 | 0.364 | 0.375 | 0.362 |
| | 8Lb | x | 0.346 | 0.355 | 0.356 | 0.347 |
| | | y | 0.362 | 0.375 | 0.385 | 0.371 |
| | 8Lc | x | 0.354 | 0.364 | 0.366 | 0.355 |
| | | y | 0.364 | 0.380 | 0.391 | 0.375 |
| | 8Ld | x | 0.355 | 0.366 | 0.367 | 0.356 |
| | | y | 0.375 | 0.391 | 0.401 | 0.385 |

Tolerance of each bin limit = ± 0.02

Color Coordinates Chart for ASMT-QWBx

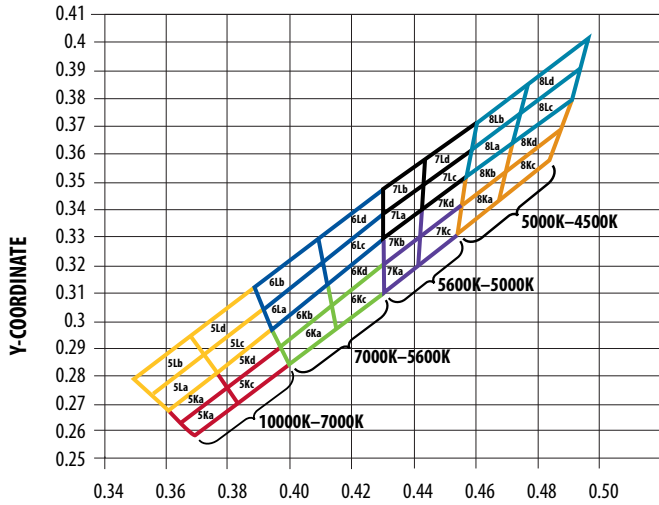

Color Coordinates Chart for ASMT-QYBx

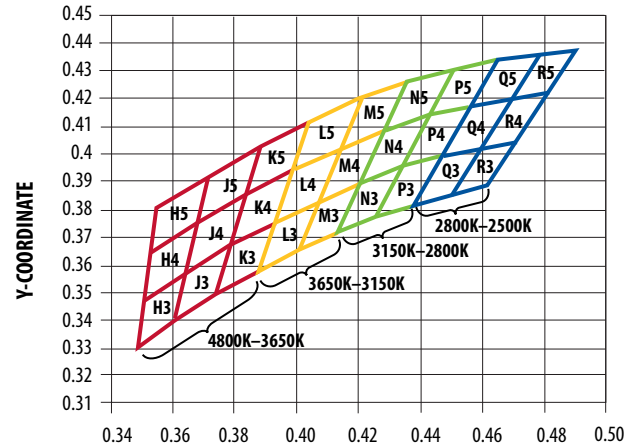

Color Bin Selection (X₁) for ASMT-QYBx

Individual reel will contain parts from one sub bin only.

| X ₁ | |
|----------------|-----------------------|
| O | Full Distribution |
| A | H, J and K only |
| B | H, J, K, L and M only |
| C | L and M only |
| D | L, M, N and P only |
| E | N and P only |
| F | N, P, Q and R only |
| G | Q and R only |
| Z | Special Color Bin |

Color Bin Limits for ASMT-QYBx

| Bin ID | Sub Bin ID | Limits (Chromaticity Coordinates) | | | | |
|--------|------------|-----------------------------------|-------|-------|-------|-------|
| L | L3 | x | 0.387 | 0.400 | 0.407 | 0.393 |
| | | y | 0.358 | 0.366 | 0.384 | 0.376 |
| | L4 | x | 0.393 | 0.407 | 0.414 | 0.399 |
| | | y | 0.376 | 0.384 | 0.402 | 0.395 |
| M | L5 | x | 0.399 | 0.414 | 0.421 | 0.405 |
| | | y | 0.395 | 0.402 | 0.420 | 0.412 |
| | M3 | x | 0.400 | 0.413 | 0.421 | 0.407 |
| | | y | 0.366 | 0.372 | 0.390 | 0.384 |
| N | M4 | x | 0.407 | 0.421 | 0.429 | 0.414 |
| | | y | 0.384 | 0.390 | 0.409 | 0.402 |
| | M5 | x | 0.414 | 0.429 | 0.436 | 0.421 |
| | | y | 0.402 | 0.409 | 0.426 | 0.420 |
| P | N3 | x | 0.413 | 0.425 | 0.434 | 0.421 |
| | | y | 0.372 | 0.378 | 0.396 | 0.390 |
| | N4 | x | 0.421 | 0.434 | 0.443 | 0.429 |
| | | y | 0.390 | 0.396 | 0.414 | 0.409 |
| Q | N5 | x | 0.429 | 0.443 | 0.451 | 0.436 |
| | | y | 0.409 | 0.414 | 0.430 | 0.426 |
| | P3 | x | 0.425 | 0.438 | 0.447 | 0.434 |
| | | y | 0.378 | 0.382 | 0.400 | 0.396 |
| R | P4 | x | 0.434 | 0.447 | 0.456 | 0.443 |
| | | y | 0.396 | 0.400 | 0.417 | 0.414 |
| | P5 | x | 0.443 | 0.456 | 0.465 | 0.451 |
| | | y | 0.414 | 0.417 | 0.434 | 0.430 |
| Z | Q3 | x | 0.438 | 0.450 | 0.460 | 0.447 |
| | | y | 0.382 | 0.386 | 0.403 | 0.400 |
| | Q4 | x | 0.447 | 0.460 | 0.470 | 0.456 |
| | | y | 0.400 | 0.403 | 0.420 | 0.417 |
| Q5 | x | 0.456 | 0.470 | 0.479 | 0.465 | |
| | y | 0.417 | 0.420 | 0.436 | 0.434 | |

Color Bin Limits for ASMT-QYBx

| Bin ID | Sub Bin ID | Limits (Chromaticity Coordinates) | | | | |
|--------|------------|-----------------------------------|-------|-------|-------|-------|
| R | R3 | x | 0.450 | 0.462 | 0.472 | 0.460 |
| | | y | 0.386 | 0.389 | 0.405 | 0.403 |
| | R4 | x | 0.460 | 0.472 | 0.482 | 0.470 |
| | | y | 0.403 | 0.405 | 0.422 | 0.420 |
| R5 | x | 0.470 | 0.482 | 0.491 | 0.479 | |
| | y | 0.420 | 0.422 | 0.437 | 0.436 | |

Tolerance of each bin limit = ± 0.02

Color Bin Limits for ASMT-QWBx

| Bin ID | Sub Bin ID | Limits (Chromaticity Coordinates) | | | | |
|--------|------------|-----------------------------------|-------|-------|-------|-------|
| H | H3 | x | 0.348 | 0.360 | 0.364 | 0.350 |
| | | y | 0.332 | 0.341 | 0.358 | 0.348 |
| | H4 | x | 0.350 | 0.364 | 0.367 | 0.352 |
| | | y | 0.348 | 0.358 | 0.376 | 0.365 |
| J | H5 | x | 0.352 | 0.367 | 0.371 | 0.354 |
| | | y | 0.365 | 0.376 | 0.392 | 0.381 |
| | J3 | x | 0.360 | 0.373 | 0.378 | 0.364 |
| | | y | 0.341 | 0.350 | 0.368 | 0.358 |
| K | J4 | x | 0.364 | 0.378 | 0.383 | 0.367 |
| | | y | 0.358 | 0.368 | 0.386 | 0.376 |
| | J5 | x | 0.367 | 0.383 | 0.388 | 0.371 |
| | | y | 0.376 | 0.386 | 0.403 | 0.392 |
| L | K3 | x | 0.373 | 0.387 | 0.393 | 0.378 |
| | | y | 0.350 | 0.358 | 0.376 | 0.368 |
| | K4 | x | 0.378 | 0.393 | 0.399 | 0.383 |
| | | y | 0.368 | 0.376 | 0.395 | 0.386 |
| M | K5 | x | 0.383 | 0.399 | 0.405 | 0.388 |
| | | y | 0.386 | 0.395 | 0.412 | 0.403 |

Packaging Option (X₅)

| X ₅ | Test Current | Package Type | Reel Size |
|----------------|--------------|--------------|-----------|
| E | 150 mA | Top Mount | 7 inch |

0.5W Power PLCC4 Cool White and Warm White Luminous Flux Bin and Color Bin (ASMT-QWBx/ASMT-QYBx)

Super 0.5W Power PLCC4 Cool White (ASMT-QWBx)

ASMT-QWBx-N X₂-X₃-X₄-E

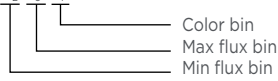

Super 0.5W Power PLCC4 Warm White (ASMT-QYBx)

ASMT-QYBx-N X₂-X₃-X₄-E

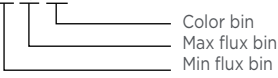

Color Bin (X₄)

Individual reel will contain parts from one sub bin only.

| Sub Bin | Chromaticity Coordinates | | | | |
|---------|--------------------------|--------|--------|--------|--------|
| | | 0.2950 | 0.2920 | 0.2984 | 0.3009 |
| 1A | x | 0.2950 | 0.2920 | 0.2984 | 0.3009 |
| | y | 0.2970 | 0.3060 | 0.3133 | 0.3042 |
| 1B | x | 0.2920 | 0.2895 | 0.2962 | 0.2984 |
| | y | 0.3060 | 0.3135 | 0.3220 | 0.3133 |
| 1C | x | 0.2984 | 0.2962 | 0.3028 | 0.3048 |
| | y | 0.3133 | 0.3220 | 0.3304 | 0.3207 |
| 1D | x | 0.2984 | 0.3048 | 0.3068 | 0.3009 |
| | y | 0.3133 | 0.3207 | 0.3113 | 0.3042 |
| 2A | x | 0.3048 | 0.3130 | 0.3144 | 0.3068 |
| | y | 0.3207 | 0.3290 | 0.3186 | 0.3113 |
| 2B | x | 0.3028 | 0.3115 | 0.3130 | 0.3048 |
| | y | 0.3304 | 0.3391 | 0.3290 | 0.3207 |
| 2C | x | 0.3115 | 0.3205 | 0.3213 | 0.3130 |
| | y | 0.3391 | 0.3481 | 0.3373 | 0.3290 |
| 2D | x | 0.3130 | 0.3213 | 0.3221 | 0.3144 |
| | y | 0.3290 | 0.3373 | 0.3261 | 0.3186 |
| 3A | x | 0.3215 | 0.3290 | 0.3290 | 0.3222 |
| | y | 0.3350 | 0.3417 | 0.3300 | 0.3243 |
| 3B | x | 0.3207 | 0.3290 | 0.3290 | 0.3215 |
| | y | 0.3462 | 0.3538 | 0.3417 | 0.3350 |
| 3C | x | 0.3290 | 0.3376 | 0.3371 | 0.3290 |
| | y | 0.3538 | 0.3616 | 0.3490 | 0.3417 |
| 3D | x | 0.3290 | 0.3371 | 0.3366 | 0.3290 |
| | y | 0.3417 | 0.3490 | 0.3369 | 0.3300 |
| 4A | x | 0.3371 | 0.3451 | 0.3440 | 0.3366 |
| | y | 0.3490 | 0.3554 | 0.3427 | 0.3369 |
| 4B | x | 0.3376 | 0.3463 | 0.3451 | 0.3371 |
| | y | 0.3616 | 0.3687 | 0.3554 | 0.3490 |
| 4C | x | 0.3463 | 0.3551 | 0.3533 | 0.3451 |
| | y | 0.3687 | 0.3760 | 0.3620 | 0.3554 |
| 4D | x | 0.3451 | 0.3533 | 0.3515 | 0.3440 |
| | y | 0.3554 | 0.3620 | 0.3487 | 0.3427 |
| 5A | x | 0.3530 | 0.3615 | 0.3590 | 0.3512 |
| | y | 0.3597 | 0.3659 | 0.3521 | 0.3465 |
| 5B | x | 0.3548 | 0.3641 | 0.3615 | 0.3530 |
| | y | 0.3736 | 0.3804 | 0.3659 | 0.3597 |
| 5C | x | 0.3641 | 0.3736 | 0.3702 | 0.3615 |
| | y | 0.3804 | 0.3874 | 0.3722 | 0.3659 |
| 5D | x | 0.3615 | 0.3702 | 0.3670 | 0.3590 |
| | y | 0.3659 | 0.3722 | 0.3578 | 0.3521 |

Flux Bin Selection (X₂X₃)

Individual reel will contain parts from one bin only.

| | |
|----------------|--------------|
| X ₂ | Min Flux Bin |
| X ₃ | Min Flux Bin |

Flux Bin Limits

| Bin ID | Min. (lm) | Max. (lm) |
|--------|-----------|-----------|
| A | 18.1 | 23.5 |
| B | 23.5 | 30.6 |
| C | 30.6 | 35.2 |
| D | 35.2 | 39.8 |
| E | 39.8 | 45.7 |
| F | 45.7 | 51.7 |
| G | 51.7 | 56.8 |
| H | 56.8 | 62 |
| J | 62 | 67.2 |
| K | 67.2 | 73.9 |

Tolerance of each bin limit = ± 12%.

Color Bin (X₄) cont.

| | | | | | |
|----|---|--------|--------|--------|--------|
| 6A | x | 0.3670 | 0.3702 | 0.3825 | 0.3783 |
| | y | 0.3578 | 0.3722 | 0.3798 | 0.3646 |
| 6B | x | 0.3702 | 0.3736 | 0.3869 | 0.3825 |
| | y | 0.3722 | 0.3874 | 0.3958 | 0.3798 |
| 6C | x | 0.3825 | 0.3869 | 0.4006 | 0.3950 |
| | y | 0.3798 | 0.3958 | 0.4044 | 0.3875 |
| 6D | x | 0.3783 | 0.3825 | 0.3950 | 0.3898 |
| | y | 0.3646 | 0.3798 | 0.3875 | 0.3716 |
| 7A | x | 0.3889 | 0.3941 | 0.4080 | 0.4017 |
| | y | 0.3690 | 0.3848 | 0.3916 | 0.3751 |
| 7B | x | 0.3941 | 0.3996 | 0.4146 | 0.4080 |
| | y | 0.3848 | 0.4015 | 0.4089 | 0.3916 |
| 7C | x | 0.4080 | 0.4146 | 0.4299 | 0.4221 |
| | y | 0.3916 | 0.4089 | 0.4165 | 0.3984 |
| 7D | x | 0.4017 | 0.4080 | 0.4221 | 0.4147 |
| | y | 0.3751 | 0.3916 | 0.3984 | 0.3814 |
| 8A | x | 0.4147 | 0.4221 | 0.4342 | 0.4259 |
| | y | 0.3814 | 0.3984 | 0.4028 | 0.3853 |
| 8B | x | 0.4221 | 0.4299 | 0.4430 | 0.4342 |
| | y | 0.3984 | 0.4165 | 0.4212 | 0.4028 |
| 8C | x | 0.4342 | 0.4430 | 0.4562 | 0.4465 |
| | y | 0.4028 | 0.4212 | 0.4260 | 0.4071 |
| 8D | x | 0.4259 | 0.4342 | 0.4465 | 0.4373 |
| | y | 0.3853 | 0.4028 | 0.4071 | 0.3893 |

Color Bin (X₄)

Individual reel will contain parts from one sub bin only.

| X ₄ | Sub Bin |
|----------------|--|
| A | 1A, 1B, 1C, 1D |
| B | 2A, 2B, 2C, 2D |
| C | 3A, 3B, 3C, 3D |
| D | 4A, 4B, 4C, 4D |
| E | 5A, 5B, 5C, 5D |
| F | 6A, 6B, 6C, 6D |
| G | 7A, 7B, 7C, 7D |
| H | 8A, 8B, 8C, 8D |
| J | 9A, 9B, 9C, 9D |
| K | 1A, 1B, 1C, 1D, 2A, 2B, 2C, 2D |
| L | 2A, 2B, 2C, 2D, 3A, 3B, 3C, 3D |
| M | 3A, 3B, 3C, 3D, 4A, 4B, 4C, 4D |
| N | 4A, 4B, 4C, 4D, 5A, 5B, 5C, 5D |
| P | 5A, 5B, 5C, 5D, 6A, 6B, 6C, 6D |
| R | 7A, 7B, 7C, 7D, 8A, 8B, 8C, 8D |
| S | 8A, 8B, 8C, 8D, 9A, 9B, 9C, 9D |
| 0 | 1A, 1B, 1C, 1D, 2A, 2B, 2C, 2D, 3A, 3B, 3C, 3D, 4A, 4B, 4C, 4D, 5A, 5B, 5C, 5D, 6A, 6B, 6C, 6D |
| 1 | 7A, 7B, 7C, 7D, 8A, 8B, 8C, 8D, 9A, 9B, 9C, 9D |

Forward Voltage Bin

| Bin | Min (V) | Max (V) |
|-----|---------|---------|
| F05 | 2.80 | 3.00 |
| F06 | 3.00 | 3.20 |
| F07 | 3.20 | 3.40 |
| F08 | 3.40 | 3.60 |

Tolerance ± 0.1V

Color Bin (X₄) cont.

| | | | | | |
|----|---|--------|--------|--------|--------|
| 9A | x | 0.4373 | 0.4465 | 0.4582 | 0.4483 |
| | y | 0.3893 | 0.4071 | 0.4099 | 0.3919 |
| 9B | x | 0.4465 | 0.4562 | 0.4687 | 0.4582 |
| | y | 0.4071 | 0.4260 | 0.4289 | 0.4099 |
| 9C | x | 0.4582 | 0.4687 | 0.4813 | 0.4700 |
| | y | 0.4099 | 0.4289 | 0.4319 | 0.4126 |
| 9D | x | 0.4483 | 0.4582 | 0.4700 | 0.4593 |
| | y | 0.3919 | 0.4099 | 0.4126 | 0.3944 |

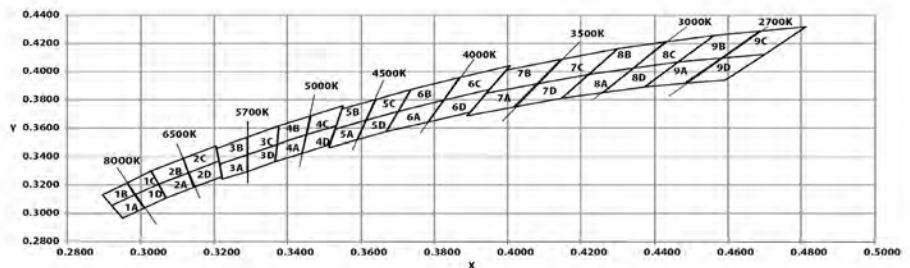

Subminiature Tricolor PLCC4 ASMB-LTC1

Part Numbering System

| | | | | | | | | | | | | | | |
|---|---|---|---|---|---|---|---|---|---|---|----------------|----------------|----------------|----------------|
| A | S | M | B | - | L | T | C | 1 | - | O | X ₁ | X ₂ | X ₃ | X ₄ |
|---|---|---|---|---|---|---|---|---|---|---|----------------|----------------|----------------|----------------|

| Code | Description | Option | | |
|----------------|--------------------------|--------|---|--|
| X ₁ | Minimum intensity bin | A | Red: bin P1 Green: bin Q2 Blue: bin N1 | Red: bin P1, P2, Q1 Green: bin Q2, R1, R2 Blue: bin N1, N2, P1 |
| X ₂ | Number of intensity bins | 3 | 3 intensity bins from minimum | |
| X ₃ | Color bin combination | A | Red: full distribution Green: bin A, B, C Blue: bin A, B, C | |
| X ₄ | Test option | 5 | Test current R/G/B=5mA | |

Bin Information

Intensity Bins (CAT)

| Color | Bin ID | Luminous Intensity (mcd) | |
|-------|--------|--------------------------|-------|
| | | Min. | Max. |
| Red | P1 | 52.0 | 69.0 |
| | P2 | 69.0 | 92.0 |
| | Q1 | 92.0 | 124.0 |
| Green | Q2 | 124.0 | 160.0 |
| | R1 | 160.0 | 215.0 |
| | R2 | 215.0 | 288.0 |
| Blue | N1 | 28.8 | 39.0 |
| | N2 | 39.0 | 52.0 |
| | P1 | 52.0 | 69.0 |

Tolerance ±12%

Color Bin (BIN) Red

| Bin ID | Dominant wavelength (nm) | | Chromaticity coordinates (for reference only) | |
|--------|--------------------------|------|---|--------|
| | Min. | Max. | Cx | Cy |
| - | 617 | 630 | 0.6674 | 0.3158 |
| | | | 0.6850 | 0.3149 |
| | | | 0.7079 | 0.2920 |
| | | | 0.6892 | 0.2941 |

Tolerance ±1 nm

Color Bin (BIN) Green

| Bin ID | Dominant wavelength (nm) | | Chromaticity coordinates (for reference only) | |
|--------|--------------------------|------|---|--------|
| | Min. | Max. | Cx | Cy |
| A | 523 | 526 | 0.1686 | 0.6821 |
| | | | 0.1097 | 0.8067 |
| | | | 0.1329 | 0.7983 |
| | | | 0.1856 | 0.6759 |
| B | 526 | 529 | 0.1856 | 0.6759 |
| | | | 0.1329 | 0.7983 |
| | | | 0.1561 | 0.7865 |
| | | | 0.2027 | 0.6673 |
| C | 529 | 532 | 0.2027 | 0.6673 |
| | | | 0.1561 | 0.7865 |
| | | | 0.1784 | 0.7734 |
| | | | 0.2192 | 0.6576 |

Tolerance ±1 nm

Color Bin (BIN) Blue

| Bin ID | Dominant wavelength (nm) | | Chromaticity coordinates (for reference only) | |
|--------|--------------------------|------|---|--------|
| | Min. | Max. | Cx | Cy |
| A | 465 | 468 | 0.1454 | 0.0546 |
| | | | 0.1355 | 0.0399 |
| | | | 0.1291 | 0.0494 |
| | | | 0.1393 | 0.0636 |
| B | 468 | 471 | 0.1393 | 0.0636 |
| | | | 0.1291 | 0.0494 |
| | | | 0.1215 | 0.0626 |
| | | | 0.1321 | 0.0761 |
| C | 471 | 474 | 0.1321 | 0.0761 |
| | | | 0.1215 | 0.0626 |
| | | | 0.1128 | 0.0799 |
| | | | 0.1238 | 0.0926 |

Tolerance ±1 nm

Package Drawings

PLCC-2 Top Mount

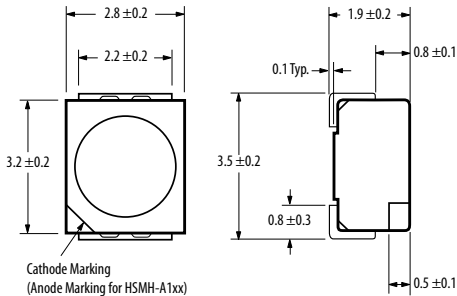

PLCC-2 Reverse Mount

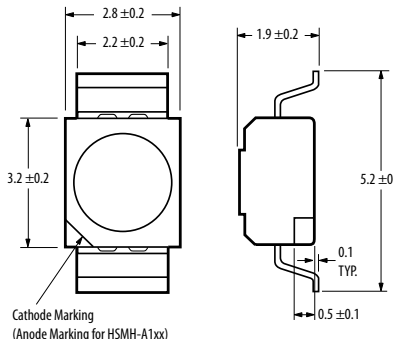

Power PLCC-4 with Lens

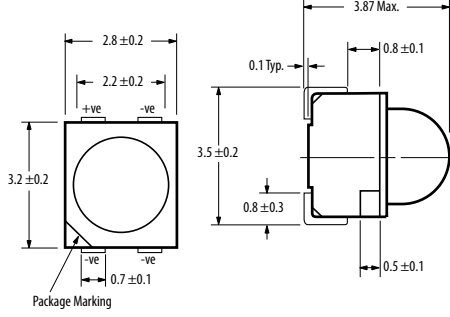

BiColor/TriColor PLCC4/Power PLCC-4

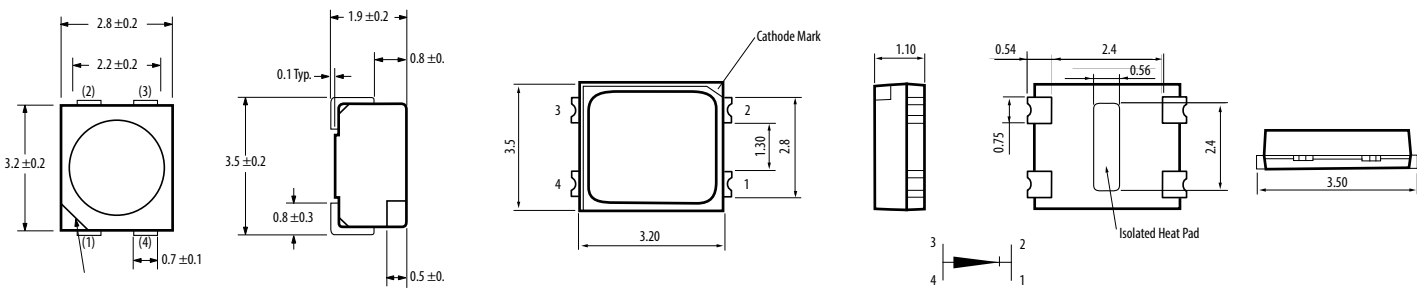

Super 0.5W Power PLCC-4

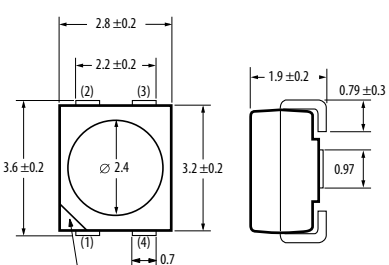

High Brightness Tricolor PLCC-4

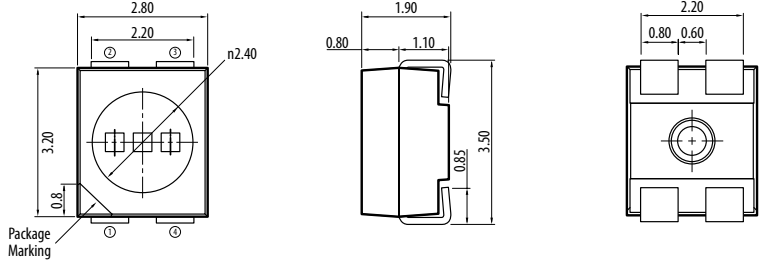

ASMD-LWG3/FWG3 -Nxxxx

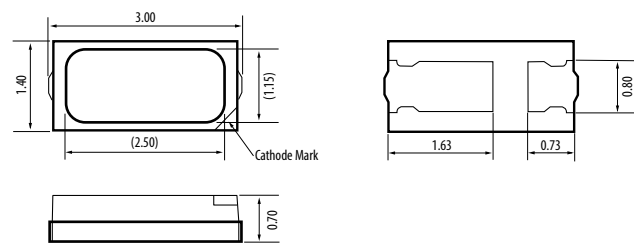

ASMF-LWG4-NxxxD

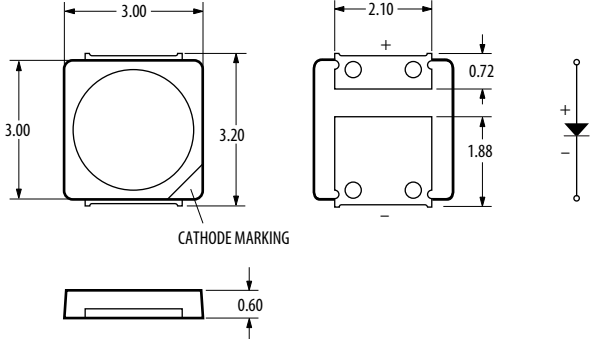

- Notes:
1. All dimensions in millimeters.
 2. Tolerance is ±0.2mm unless otherwise specified.
 3. Dimensions in brackets are for reference only.
 4. Terminal finish: Silver plating.

Package Drawings

High Brightness Tricolor PLCC-6 ASMB-TTB0/TTB2

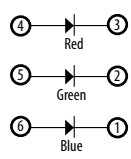
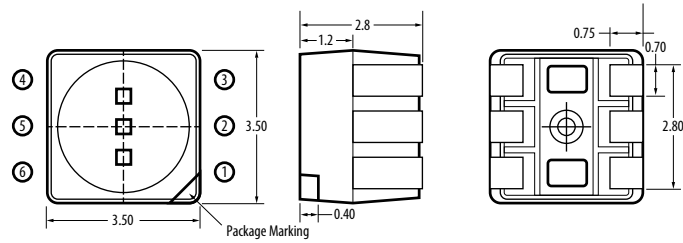

Note:
Refer to respective product datasheet for pin configuration.

Note:
Diagram represents the overall package dimension for ASMT-YTB2/YTC2/YTD2/YTB7/YTC7/YTD7. ASMTYTC2/YTC7 is black body, while ASMT-YTD2/YTD7 is white surface.

High Brightness Tricolor PLCC-6 ASMT-YTB2/YTC2/YTD2/YTB7/YTC7/YTD7

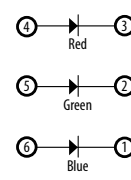
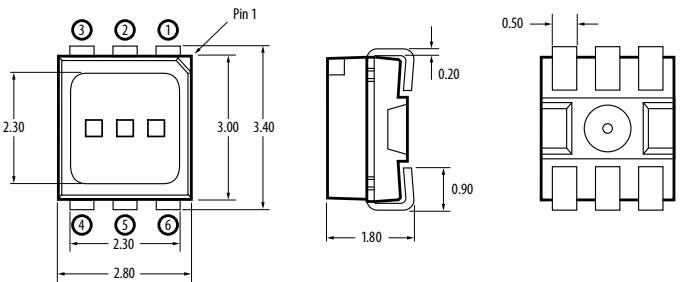

PLCC4 ASMB-LTC1

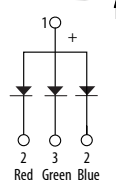
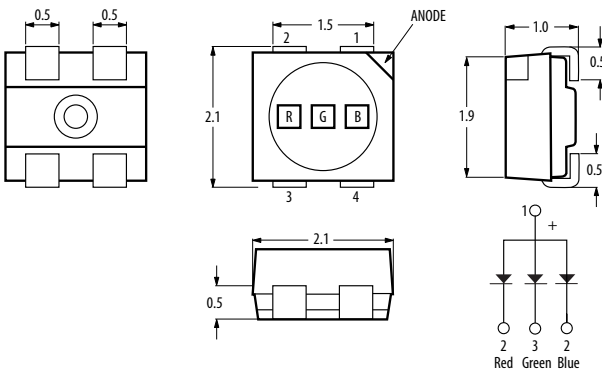

High Brightness Tricolor DFN6 ASMB-6WDO/6EDO

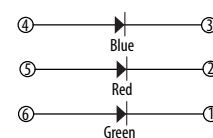
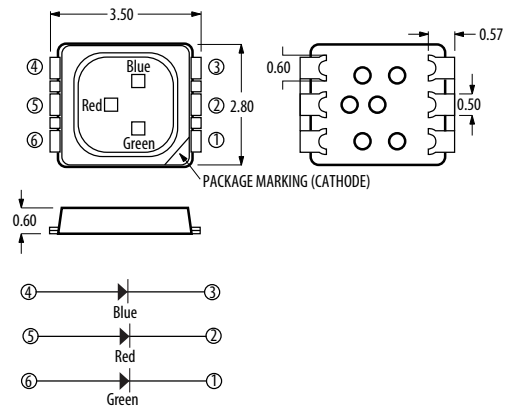

High Brightness Tricolor DFN6 ASMB-6WZO/6EZO

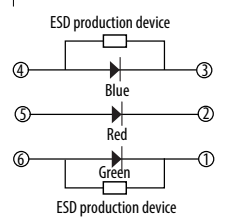
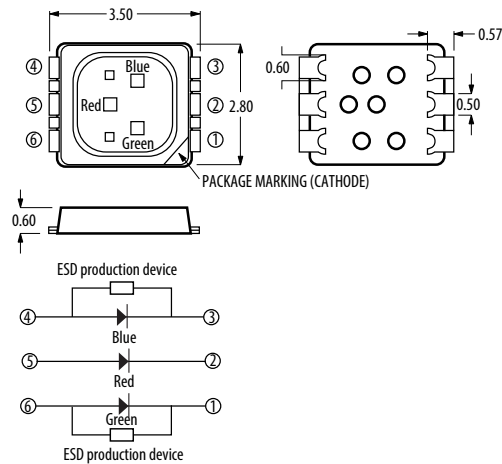

Mini PLCC-2 Surface Mount LEDs

Description

Broadcom's ASMT-TxBM-Nxxxx Mini PLCC-2 SMT LEDs are designed specifically for use in Automotive Interior applications. They have a wide viewing angle of 110 degree making them ideally suited for instrument cluster panel, push button, HVAC and ambient decorative lighting applications in automotive interiors.

The LEDs are packed in EIA-compliant tape and reel to facilitate easy pick and place assembly. Every reel will be shipped in single intensity and color bin, to provide close uniformity.

Benefits

- Industry standard Mini PLCC-2
- High reliability LED package

- High brightness using InGaN dice technologies
- High optical efficiency
- Wide viewing angle at 110°
- Available is 8mm carrier tape on 7-inch reel
- Stable and consistent performance with minimum degradation
- JEDEC MSL

Applications

- Interior automotive
- Instrument panel backlighting
- Central console backlighting
- Navigation and audio system backlighting
- Push button backlighting
- Ambient illumination
- Car puddle lighting



Mini PLCC2

| Part Number | Color | Color Temperature | Intensity Bin (Luminous Intensity @ 20mA) | Luminous Intensity @ 20mA (typ) | Max.Current | Viewing Angle | Packaging |
|-----------------|------------|-------------------|---|---------------------------------|-------------|---------------|-----------|
| ASMT-TWBM-NV702 | Cool White | 4500 - 8000K | T2 (355 - 450 mcd) U1 (450 - 560 mcd) U2 (560 - 715 mcd) V1 (715 - 900 mcd) V2 (900 - 1125 mcd) W1 (1125-1400mcd) W2 (1400-1800mcd) | 1100 | 20mA | 120° | Reel |
| ASMT-TBBM-NS402 | Blue | Not Applicable | P2 (56 - 71.5 mcd) Q1 (71.5 - 90 mcd) Q2 (90 - 112.5 mcd) R1 (112.5 - 140 mcd) R2 (140 - 180 mcd) S1 (180-224mcd) S2 (224-285mcd) T1 (285-355mcd) T2 (355-450mcd) | 285 | 20mA | 120° | Reel |
| ASMT-TGBM-NU3B2 | Green | Not Applicable | T1 (285 - 355 mcd) T2 (355 - 450 mcd) U1 (450 - 560 mcd) U2 (560 - 715 mcd) V1 (715 - 900 mcd) | 600 | 20mA | 120° | Reel |

Notes:

1. $\theta_{1/2}$ is the off-axis angle where the luminous intensity is $\frac{1}{2}$ the peak intensity.
2. Φ_V is the total luminous flux output as measured with an integrating sphere at mono pulse conditions.
3. Tolerance = $\pm 12\%$.

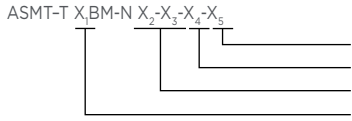

Packaging option
 Color bin selection
 Intensity bin selection
 Color
 B - Blue
 G - Green
 W - White

Part Numbering System

Device Color (X₁)

| | |
|---|-------|
| B | Blue |
| G | Green |

Intensity Bin Select (X₂X₃)

Individual reel will contain parts from one half bin only.

| | |
|----------------|-------------------------------|
| X ₂ | Min IV Bin |
| X ₃ | Number of half bins |
| 0 | Full Distribution |
| 2 | 2 half bins starting from X21 |
| 3 | 3 half bins starting from X21 |
| 4 | 4 half bins starting from X21 |
| 5 | 5 half bins starting from X21 |
| 6 | 2 half bins starting from X22 |
| 7 | 3 half bins starting from X22 |
| 8 | 4 half bins starting from X22 |
| 9 | 5 half bins starting from X22 |

Intensity Bin Limits

| Bin ID | Min (mcd) | Max (mcd) |
|--------|-----------|-----------|
| P1 | 45.0 | 56.0 |
| P2 | 56.0 | 71.5 |
| Q1 | 71.5 | 90.0 |
| Q2 | 90.0 | 112.5 |
| R1 | 112.5 | 140.0 |
| R2 | 140.0 | 180.0 |
| S1 | 180.0 | 224.0 |
| S2 | 224.0 | 285.0 |
| T1 | 285.0 | 355.0 |
| T2 | 355.0 | 450.0 |
| U1 | 450.0 | 560.0 |
| U2 | 560.0 | 715.0 |
| V1 | 715.0 | 900.0 |
| V2 | 900.0 | 1125.0 |

Tolerance of each bin limit = ± 12%

Color Bin Select (X₄)

Individual reel will contain parts from one half bin only.

| X ₄ | |
|----------------|-------------------|
| O | Full Distribution |
| A | 1 and 2 only |
| B | 2 and 3 only |
| C | 3 and 4 only |
| G | 1, 2 and 3 only |
| H | 2, 3 and 4 only |
| Z | Special binning |

Color Bin Limits

| Blue | Min. (nm) | Max. (nm) |
|------|-----------|-----------|
| 1 | 460.0 | 465.0 |
| 2 | 465.0 | 470.0 |
| 3 | 470.0 | 475.0 |
| 4 | 475.0 | 480.0 |

| Green | Min. (nm) | Max. (nm) |
|-------|-----------|-----------|
| 1 | 515.0 | 520.0 |
| 2 | 520.0 | 525.0 |
| 3 | 525.0 | 530.0 |
| 4 | 530.0 | 535.0 |

Tolerance of each bin limit = ± 1%

Packaging Option (X₅)

| Option | Test Current | Package Type | Reel Size |
|--------|--------------|--------------|-----------|
| 2 | 20mA | Top Mount | 7 inch |

Device Color (X₁)

| | |
|---|-------|
| W | White |
|---|-------|

Intensity Bin Select (X₂X₃)

Individual reel will contain parts from one half bin only.

| | |
|----------------|-------------------------------|
| X ₂ | Min IV Bin |
| X ₃ | Number of half bins |
| 0 | Full Distribution |
| 2 | 2 half bins starting from X21 |
| 3 | 3 half bins starting from X21 |
| 4 | 4 half bins starting from X21 |
| 5 | 5 half bins starting from X21 |
| 6 | 2 half bins starting from X22 |
| 7 | 3 half bins starting from X22 |
| 8 | 4 half bins starting from X22 |
| 9 | 5 half bins starting from X22 |

Intensity Bin Limits

| Bin ID | Min (mcd) | Max (mcd) |
|--------|-----------|-----------|
| T1 | 285.0 | 355.0 |
| T2 | 355.0 | 450.0 |
| U1 | 450.0 | 560.0 |
| U2 | 560.0 | 715.0 |
| V1 | 715.0 | 900.0 |
| V2 | 900.0 | 1125.0 |
| W1 | 1125.0 | 1400.00 |
| W2 | 1400.00 | 1800.00 |

| Bin ID | Min (mcd) | Max (mcd) |
|--------|-----------|-----------|
| X1 | 1800.00 | 2240.00 |
| X2 | 2240.00 | 2850.00 |

Tolerance of each bin limit = ± 12%

Color Bin Select (X₄)

Individual reel will contain parts from one half bin only.

| X ₄ | |
|----------------|------------------------|
| O | Full Distribution |
| A | 5K and 5L only |
| B | 6K and 6L only |
| C | 7K and 7L only |
| D | 8K and 8L only |
| E | 5K and 6K only |
| F | 5L and 6L only |
| G | 6K and 7K only |
| H | 6L and 7L only |
| J | 7K and 8K only |
| K | 7L and 8L only |
| L | 5K, 5L, 6K and 6L only |
| M | 6K, 6L, 7K and 7L only |
| N | 7K, 7L, 8K and 8L only |
| Z | Special binning |

Color Bin Limits

| Blue | Min. (nm) | Max. (nm) |
|------|-----------|-----------|
| 1 | 460.0 | 465.0 |
| 2 | 465.0 | 470.0 |
| 3 | 470.0 | 475.0 |
| 4 | 475.0 | 480.0 |

| Green | Min. (nm) | Max. (nm) |
|-------|-----------|-----------|
| 1 | 515.0 | 520.0 |
| 2 | 520.0 | 525.0 |
| 3 | 525.0 | 530.0 |
| 4 | 530.0 | 535.0 |

Tolerance of each bin limit = ± 1%

Packaging Option (X₅)

| Option | Test Current | Package Type | Reel Size |
|--------|--------------|--------------|-----------|
| 2 | 20mA | Top Mount | 7 inch |

Color Bin (X_d)

Individual reel will contain parts from one sub bin only.

| Bin ID | Sub Bin ID | Limits (Chromaticity Coordinates) | | | | |
|--------|------------|-----------------------------------|-------|-------|-------|-------|
| 5K | 5Ka | x | 0.296 | 0.304 | 0.302 | 0.294 |
| | | y | 0.259 | 0.270 | 0.276 | 0.264 |
| | 5Kb | x | 0.294 | 0.302 | 0.300 | 0.291 |
| | | y | 0.264 | 0.276 | 0.281 | 0.268 |
| | 5Kc | x | 0.304 | 0.313 | 0.312 | 0.302 |
| | | y | 0.270 | 0.284 | 0.291 | 0.276 |
| | 5Kd | x | 0.302 | 0.312 | 0.310 | 0.300 |
| | | y | 0.276 | 0.291 | 0.297 | 0.281 |
| 5L | 5La | x | 0.291 | 0.300 | 0.298 | 0.288 |
| | | y | 0.268 | 0.281 | 0.288 | 0.274 |
| | 5Lb | x | 0.288 | 0.298 | 0.295 | 0.285 |
| | | y | 0.274 | 0.288 | 0.294 | 0.279 |
| | 5Lc | x | 0.300 | 0.310 | 0.309 | 0.298 |
| | | y | 0.281 | 0.297 | 0.305 | 0.288 |
| | 5Ld | x | 0.298 | 0.309 | 0.307 | 0.295 |
| | | y | 0.288 | 0.305 | 0.312 | 0.294 |
| 6K | 6Ka | x | 0.313 | 0.322 | 0.321 | 0.312 |
| | | y | 0.284 | 0.297 | 0.305 | 0.291 |
| | 6Kb | x | 0.312 | 0.321 | 0.320 | 0.310 |
| | | y | 0.291 | 0.305 | 0.314 | 0.297 |
| | 6Kc | x | 0.322 | 0.330 | 0.330 | 0.321 |
| | | y | 0.297 | 0.310 | 0.320 | 0.305 |
| | 6Kd | x | 0.321 | 0.330 | 0.330 | 0.320 |
| | | y | 0.305 | 0.320 | 0.330 | 0.314 |
| 6L | 6La | x | 0.310 | 0.320 | 0.319 | 0.309 |
| | | y | 0.297 | 0.314 | 0.322 | 0.305 |
| | 6Lb | x | 0.309 | 0.319 | 0.318 | 0.307 |
| | | y | 0.305 | 0.322 | 0.329 | 0.312 |
| | 6Lc | x | 0.320 | 0.330 | 0.330 | 0.319 |
| | | y | 0.314 | 0.330 | 0.339 | 0.322 |
| | 6Ld | x | 0.319 | 0.330 | 0.330 | 0.318 |
| | | y | 0.322 | 0.339 | 0.347 | 0.329 |

| Bin ID | Sub Bin ID | Limits (Chromaticity Coordinates) | | | | |
|--------|------------|-----------------------------------|-------|-------|-------|-------|
| 7K | 7Ka | x | 0.330 | 0.336 | 0.337 | 0.330 |
| | | y | 0.310 | 0.320 | 0.330 | 0.320 |
| | 7Kb | x | 0.330 | 0.337 | 0.337 | 0.330 |
| | | y | 0.320 | 0.330 | 0.341 | 0.330 |
| | 7Kc | x | 0.336 | 0.343 | 0.344 | 0.337 |
| | | y | 0.320 | 0.331 | 0.341 | 0.330 |
| | 7Kd | x | 0.337 | 0.344 | 0.345 | 0.337 |
| | | y | 0.330 | 0.341 | 0.352 | 0.341 |
| 7L | 7La | x | 0.330 | 0.337 | 0.337 | 0.330 |
| | | y | 0.330 | 0.341 | 0.349 | 0.339 |
| | 7Lb | x | 0.330 | 0.337 | 0.338 | 0.330 |
| | | y | 0.339 | 0.349 | 0.358 | 0.347 |
| | 7Lc | x | 0.337 | 0.345 | 0.346 | 0.337 |
| | | y | 0.341 | 0.352 | 0.362 | 0.349 |
| | 7Ld | x | 0.337 | 0.346 | 0.347 | 0.338 |
| | | y | 0.349 | 0.362 | 0.371 | 0.358 |
| 8K | 8Ka | x | 0.343 | 0.351 | 0.352 | 0.344 |
| | | y | 0.331 | 0.343 | 0.354 | 0.341 |
| | 8Kb | x | 0.344 | 0.352 | 0.354 | 0.345 |
| | | y | 0.341 | 0.354 | 0.364 | 0.352 |
| | 8Kc | x | 0.351 | 0.360 | 0.362 | 0.352 |
| | | y | 0.343 | 0.357 | 0.369 | 0.354 |
| | 8Kd | x | 0.352 | 0.362 | 0.364 | 0.354 |
| | | y | 0.354 | 0.369 | 0.380 | 0.364 |
| 8L | 8La | x | 0.345 | 0.354 | 0.355 | 0.346 |
| | | y | 0.352 | 0.364 | 0.375 | 0.362 |
| | 8Lb | x | 0.346 | 0.355 | 0.356 | 0.347 |
| | | y | 0.362 | 0.375 | 0.385 | 0.371 |
| | 8Lc | x | 0.354 | 0.364 | 0.366 | 0.355 |
| | | y | 0.364 | 0.380 | 0.391 | 0.375 |
| | 8Ld | x | 0.355 | 0.366 | 0.367 | 0.356 |
| | | y | 0.375 | 0.391 | 0.401 | 0.385 |

Tolerance of each bin limit = ±0.02

Color Coordinates Chart

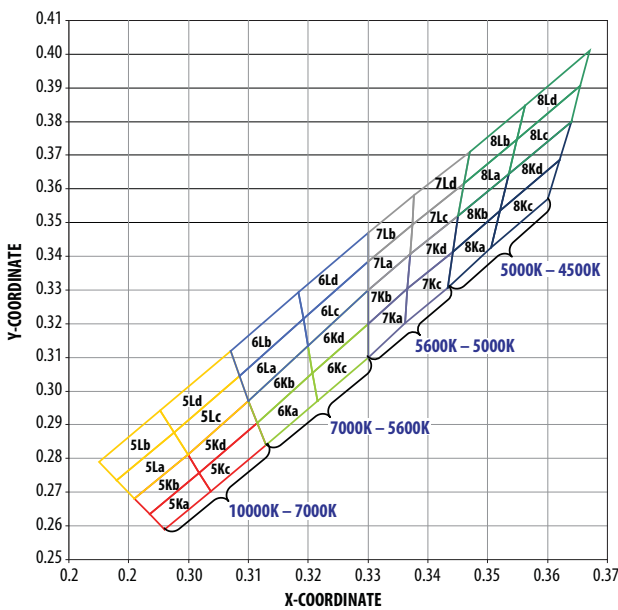

Package Drawing

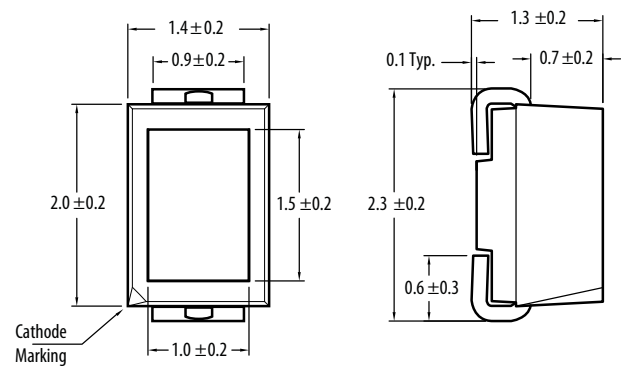

- Notes:
1. All dimensions in millimeters.
 2. Terminal Finish: Ag plating.
 3. Encapsulation material: Silicone resin.

Envisium Power PLCC-4 Surface Mount LEDs

Description

Envisium is the premier class of mid-Power LEDs using TS AlInGaP chip technology. Envisium LEDs offer unparalleled performance, engineering and design flexibility.

Envisium Power PLCC-4 SMT LEDs, available in red, red-orange and amber, fill the need for mid-power illumination capabilities between Broadcom's conventional PLCC-4 products, and the Super 0.5W Power PLCC-4. The Power PLCC-4 package can be driven at high current due to its superior design, and is able to dissipate the heat more efficiently than conventional PLCC-2 SMT LEDs. It also offers much higher quality and reliability and superior mechanical characteristics to reduce tombstoning, prevent delamination and improve pick-and-place assembly.

The reliability and performance characteristics of these mid-power LEDs, such as their -40°C to $+100^{\circ}\text{C}$ operating temperature range, make them uniquely suitable for use in harsh conditions such as automotive applications, and in electronic signs and signals. To facilitate easy pick and place assembly, the LEDs are packed in EIA-compliant tape and reel. Every reel is shipped in single intensity and color bin (except for red) to provide close uniformity.

These LEDs are compatible with both IR solder reflow and through-the-wave (TTW) soldering processes, in, to provide close uniformity.

Benefits

- Industry Standard PLCC-4 (plastic leaded chip carrier) form factor
- High reliability power PLCC-4 package
- High brightness with optimum flux performance using TS AlInGaP dice technologies
- Available in red, red orange and amber colors
- High optical efficiency
- Higher ambient temperature at the same current possible compared to PLCC-2
- Super wide 120-degree viewing angle
- Well-suited for backlighting applications
- Supplied in EIA-standard 8 mm carrier tape on 7 inch reel
- Compatible with both IR and TTW soldering processes



Applications

- Interior automotive
 - Instrument panel backlighting
 - Central console backlighting
 - Navigation and audio system lighting
 - Push button backlighting
- Exterior automotive
 - Turn signals
 - Side repeater lamps
 - CHMSLs (center high-mounted stop light)
 - Rear combination lamps
 - Puddle lights
- Electronic signs and signals
 - Channel lettering
 - Contour lighting
 - Indoor variable message signs
- Office automation, home appliances, industrial equipment
 - Front panel backlighting
 - Push button backlighting
 - Display backlighting

Envisium PLCC-4 Surface Mount LED

| Part Number | Color | Typ. Dominant Wavelength λ_D (nm) ¹ | Typ. Viewing Angle $2\theta_{1/2}$ (°) ² | Intensity Bin | Min. IV (mcd) | Max. IV (mcd) | Total Flux Φ_V (mlm) ^{4,5} Typ. | Typ. VF (V) | Test Current (mA) |
|-----------------|--------------------|--|---|---------------|---------------|---------------|---|-------------|-------------------|
| ASMC-PRB9-TV005 | AlInGaP Red | 630.0 | 120 | V1 | 630.00 | 1000.00 | 2600.00 | 2.8 | 50 |
| | | 630.0 | 120 | V2 | 790.00 | 1260.00 | 3300.00 | 2.8 | 50 |
| | | 630.0 | 120 | W1 | 1000.00 | 1600.00 | - | 2.8 | 50 |
| ASMC-PHB9-TW005 | AlInGaP Red Orange | 617.0 | 120 | W1 | 1000.00 | 1600.00 | 4300.00 | 2.8 | 50 |
| | | 617.0 | 120 | W2 | 1200.00 | 2020.00 | 5000.00 | 2.8 | 50 |
| | | 617.0 | 120 | X1 | 1580.00 | 2500.00 | - | 2.8 | 50 |
| ASMC-PAB9-TV005 | AlInGaP Amber | 592.0 | 120 | V1 | 630.00 | 1000.00 | 3000.00 | 2.8 | 50 |
| | | 592.0 | 120 | V2 | 790.00 | 1260.00 | 3800.00 | 2.8 | 50 |
| | | 592.0 | 120 | W1 | 1000.00 | 1600.00 | - | 2.8 | 50 |

Notes:

- The dominant wavelength, λ_D , is derived from the CIE Chromaticity Diagram and represents the color of the device.
- $\theta_{1/2}$ is the off-axis angle where the luminous intensity is 1/2 the peak intensity.
- The luminous intensity, I_V , is measured at the mechanical axis of the lamp package. The actual peak of the spatial radiation pattern may not be aligned with this axis.
- Φ is the total luminous flux output as measured with an integrating sphere at mono pulse conditions.

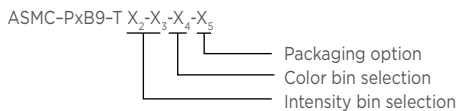
Color Bin Selection (X_4)

An individual reel will contain parts from one bin only.

| X_4 | |
|-------|-----------------------|
| O | Full Distribution |
| A | 1 and 2 only |
| B | 2 and 3 only |
| C | 3 and 4 only |
| D | 4 and 5 only |
| E | 5 and 6 only |
| G | 1, 2 and 3 only |
| H | 2, 3 and 4 only |
| J | 3, 4 and 5 only |
| K | 4, 5 and 6 only |
| M | 1, 2, 3 and 4 only |
| N | 2, 3, 4 and 5 only |
| P | 3, 4, 5 and 6 only |
| R | 1, 2, 3, 4 and 5 only |
| S | 2, 3, 4, 5 and 6 only |

Intensity Bin Selection (X_2 , X_3)

| X_2 | Min. I_V Bin |
|-------|-------------------------------------|
| X_3 | Number of half bins |
| 0 | Full Distribution |
| 2 | 2 half bins starting from $X_{2,1}$ |
| 3 | 3 half bins starting from $X_{2,1}$ |
| 4 | 4 half bins starting from $X_{2,1}$ |
| 5 | 5 half bins starting from $X_{2,1}$ |
| 6 | 2 half bins starting from $X_{2,2}$ |
| 7 | 3 half bins starting from $X_{2,2}$ |
| 8 | 4 half bins starting from $X_{2,2}$ |
| 9 | 5 half bins starting from $X_{2,2}$ |

Color Bin Limits

| Amber/ Yellow | Min. (nm) | Max. (nm) |
|------------------|-----------|-----------|
| 1 | 582.0 | 584.5 |
| 2 | 584.5 | 587.0 |
| 3 | 587.0 | 589.5 |
| 4 | 589.5 | 592.0 |
| 5 | 592.0 | 594.5 |
| 6 | 594.5 | 597.0 |

| Red Orange | Min. (nm) | Max.(nm) |
|------------|-----------|----------|
| 1 | 611.0 | 616.0 |
| 2 | 616.0 | 620.0 |

| Red | Min. (nm) | Max. (nm) |
|-------------------|-----------|-----------|
| Full Distribution | | |

Tolerance of each bin limit = ± 1 nm

Intensity Bin Limits

| Bin ID | Min. (mcd) | Max. (mcd) |
|--------|------------|------------|
| V1 | 715.00 | 900.00 |
| V2 | 900.00 | 1125.00 |
| W1 | 1125.00 | 1400.00 |
| W2 | 1400.00 | 1800.00 |
| X1 | 1800.00 | 2240.00 |
| X2 | 2240.00 | 2850.00 |

Tolerance of each bin limit = $\pm 12\%$

Packaging Option (X_5)

| X_5 | Test Current | Package Type | Reel Size |
|-------|--------------|--------------|-----------|
| 5 | 50 mA | Top Mount | 7 inch |

Package Drawing

Envisium PLCC-4 Surface Mount LED

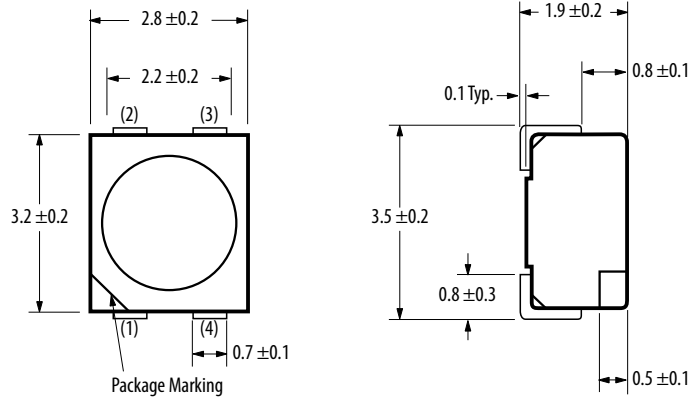

Note:
All dimensions in millimeters.

Envisium Power PLCC-4

| | |
|---|---------|
| 1 | Cathode |
| 2 | Anode |
| 3 | Cathode |
| 4 | Cathode |

High Power LEDs

Description

Broadcom's High Power and Mini High Power LED is a high performance, energy efficient device which can handle high thermal and high driving current. The White High Power LED is available in a wide range of color. For white color, the color temperature ranges from 2700K to 10000K.

The low profile package design and ultra small footprint is suitable for a wide variety of applications especially where space and height is a constraint.

The package is compatible with reflow soldering process. It is packed in EIA-compliant tape and reel option.

Benefits

- Available in full range of colors: Red, Red Orange, Amber, Green, Blue, Royal Blue, Cyan, Cool White, Neutral White and Warm White
- Energy efficient
- Compatible with reflow soldering process
- High current operation
- Long operation life
- Wide viewing angle
- Silicone encapsulation
- Non-ESD sensitive (threshold > 16kV)

Applications

- Sign backlight
- Safety, exit and emergency sign lightings
- Specialty lighting such as task lighting and reading lights
- Retail display
- Commercial lighting
- Accent or marker lightings, strip or step lightings
- Portable lightings, bicycle head lamp, torch lights
- Decorative lighting
- Architectural lighting
- Street lighting
- Tunnel lighting
- Contour lighting
- Traffic signals



1W High Power LEDs

| Part Number | Color | Color Temperature (K)/ Wavelength (nm) | Flux Bin (Luminous Flux/Radiometric Power @ 350mA) | Luminous Flux (lm) @ 350mA (typ) | Luminous Flux (lm) @ 700mA (typ) | Max. Current | Viewing Angle | Electrically Isolated Metal Slug | Packaging |
|-----------------|---------------|--|--|----------------------------------|----------------------------------|--------------|---------------|----------------------------------|------------------------------|
| ASMT-AW00-NUW01 | Cool White | 4500 - 10,000K (1) | U(87.4-99.6lm); V(99.6-113.6lm); W(113.6-129.5lm) | 95lm | - | 500mA | 140 | Yes | Tube and Reel ⁽²⁾ |
| ASMT-AN00-NUW01 | Neutral White | 4500 - 10,000K (1) | U(87.4-99.6lm); V(99.6-113.6lm); W(113.6-129.5lm) | 90lm | - | 500mA | 140 | Yes | Tube and Reel ⁽²⁾ |
| ASMT-AY00-NUV00 | Warm White | 2700 - 3500K ⁽¹⁾ | U(87.4-99.6lm); V(99.6-113.6lm) | 95lm | - | 500mA | 140 | Yes | Tube ⁽²⁾ |
| ASMT-AL00-NQS00 | Royal Blue | 440-460nm ^(3, 4) | Q(435-515mW); R(515-595mW); S(595-685mW) | 550mW | - | 500mA | 140 | Yes | Tube ⁽²⁾ |
| ASMT-AB00-NMPO0 | Blue | 460-480nm ⁽³⁾ | M(13.9-18.1lm); N(18.1-23.5lm); P(23.5-30.6lm) | 18lm | - | 500mA | 140 | Yes | Tube ⁽²⁾ |
| ASMT-AC00-NSU00 | Cyan | 490-520nm ⁽³⁾ | S(51.7-67.2lm); T(67.2-87.4lm); U(87.4-99.6lm) | 75lm | - | 500mA | 140 | Yes | Tube ⁽²⁾ |
| ASMT-AG00-NUV00 | Green | 515-535nm ⁽³⁾ | U(87.4-99.6lm); V(99.6-113.6lm) | 105lm | - | 500mA | 140 | Yes | Tube ⁽²⁾ |
| ASMT-AA00-ARS00 | Amber | 587-597nm ⁽³⁾ | R(39.8-51.7lm); S(51.7-67.2lm) | 50lm | - | 500mA | 140 | No | Tube ⁽²⁾ |
| ASMT-AH03-ATU00 | Red-Orange | 610-620nm | T(67.2-87.4lm); U(87.4-99.6lm) | 75lm | - | 500mA | 140 | No | Tube ⁽²⁾ |
| ASMT-AR00-ARS00 | Red | 620-635nm | R(39.8-51.7lm); S(51.7-67.2lm) | 50lm | - | 500mA | 140 | No | Tube ⁽²⁾ |
| ASMT-AR00-AST00 | Red | 620-635nm | S(51.7-67.2lm); T(67.2-87.4lm) | 65lm | - | 500mA | 140 | No | Tube ⁽²⁾ |

Notes:

1. Narrow Color Temperature selections are available on request.
2. All above listed LEDs are also available in Reel packing.
3. Narrow color bin selections for blue, green, amber, royal-blue, and cyan are available on request.
4. For royal-blue, the wavelength shown in the above table is peak wavelength.

3W High Power LEDs

| Part Number | Color | Color Temperature (K)/ Wavelength (nm) | Flux Bin (Luminous Flux/Radiometric Power @ 350mA) | Luminous Flux (lm) @ 350mA (typ) | Luminous Flux (lm) @ 700mA (typ) | Max. Current | Viewing Angle | Electrically Isolated Metal Slug | Packaging |
|-----------------|---------------|--|---|----------------------------------|----------------------------------|--------------|---------------|----------------------------------|---------------------|
| ASMT-AW31-NVX00 | Cool White | 4500-10000K | V(99.6-113.6lm); W(113.6-129.5lm); X(129.5-147.7lm) | 120lm | 205lm | 700mA | 140 | Yes | Tube ⁽²⁾ |
| ASMT-AN31-NWX00 | Neutral White | 3500-4500K | W(113.6-129.5lm); X(129.5-147.7lm) | 120lm | 205lm | 700mA | 140 | Yes | Tube ⁽²⁾ |
| ASMT-AY31-NUW00 | Warm White | 2,700 - 3,500K ⁽¹⁾ | U(87.4-99.6lm); V(99.6-113.6lm); W(113.6-129.5lm) | 95lm | 162lm | 700mA | 140 | Yes | Tube ⁽²⁾ |
| ASMT-AB31-NNP00 | Blue | 455-475nm | N(18.1-23.5lm); P(23.5-30.6lm) | 23 | 39 | 700mA | 140 | Yes | Tube ⁽²⁾ |
| ASMT-AL31-NRS00 | Royal Blue | 440-460nm ^(3,4) | R(515-595mW); S(595-685mW) | 600mW | 1022mW | 700mA | 140 | Yes | Tube ⁽²⁾ |
| ASMT-AG31-NUV00 | Green | 515-535nm ⁽³⁾ | U(87.4-99.6lm); V(99.6-113.6lm) | 105lm | 168lm | 700mA | 140 | Yes | Tube ⁽²⁾ |
| ASMT-AA30-ARS00 | Amber | 587-597nm ⁽³⁾ | R(39.8-51.7lm); S(51.7-67.2lm) | 50lm | 94lm | 700mA | 140 | No | Tube ⁽²⁾ |
| ASMT-AH33-ATU00 | Red-Orange | 610-620nm | T(67.2-87.4lm); U(87.4-99.6lm) | 75lm | 140m | 700mA | 140 | No | Tube ⁽²⁾ |
| ASMT-AR30-ARS00 | Red | 620-635nm | R(39.8-51.7lm); S(51.7-67.2lm) | 50lm | 94lm | 700mA | 140 | No | Tube ⁽²⁾ |
| ASMT-AR30-AST00 | Red | 620-635nm | S(51.7-67.2lm); T(67.2-87.4lm) | 60lm | 112lm | 700mA | 140 | Yes | Tube ⁽²⁾ |

Notes:

1. Narrow Color Temperature selections are available on request.
2. All above listed LEDs are also available in Reel packing.
3. Narrow color bin selections for blue, green, amber and royal-blue are available on request.
4. For royal-blue, the wavelength shown in the above table is peak wavelength.

1W Mini High Power LEDs

| Part Number | Color | Color Temperature (K)/ Wavelength (nm) | Flux Bin (Luminous Flux/Radiometric Power @ 350mA) | Luminous Flux (lm) @ 350mA (typ) | Luminous Flux (lm) @ 700mA (typ) | Max. Current | Viewing Angle | Electrically Isolated Metal Slug | Packaging |
|-----------------|---------------|--|--|----------------------------------|----------------------------------|--------------|---------------|----------------------------------|-------------|
| ASMT-JW11-NWX01 | Cool White | 4500 - 10,000K ⁽¹⁾ | W(113.6-129.5lm); X (129.5-147.7lm) | 120lm | - | 500mA | 140 | Yes | Tape & Reel |
| ASMT-JN11-NWX01 | Neutral White | 3500 - 4500K ⁽¹⁾ | W(113.6-129.5lm); X (129.5-147.7lm) | 120lm | - | 500mA | 140 | Yes | Tape & Reel |
| ASMT-JY11-NVW01 | Warm White | 2700 - 3500K ⁽¹⁾ | V(99.6-113.6lm); W(113.6-129.5lm) | 105lm | - | 500mA | 140 | Yes | Tape & Reel |
| ASMT-JL11-NQS01 | Royal Blue | 440-460nm ^(2,3) | Q(435-515mW), R(515-595mW), S(595-685mW) | 550mW | - | 500mA | 165 | Yes | Tape & Reel |
| ASMT-JB11-NNQ01 | Blue | 455-475nm ⁽²⁾ | N(275-355mW); P(355-435mW); Q(435-515mW) | 24lm | - | 500mA | 165 | Yes | Tape & Reel |
| ASMT-JC11-NTU01 | Cyan | 490-520nm ⁽²⁾ | T(67.2-87.4lm); U(87.4-99.6lm) | 75lm | - | 500mA | 165 | Yes | Tape & Reel |
| ASMT-JG11-NUW01 | Green | 515-535nm ⁽²⁾ | U(87.4-99.6lm); V(99.6-113.6lm); W(113.6-129.5lm) | 110lm | - | 500mA | 165 | Yes | Tape & Reel |
| ASMT-JA10-ARS01 | Amber | 587-597nm ⁽²⁾ | R(39.8-51.7lm); S(51.7-67.2lm) | 48lm | - | 500mA | 165 | No | Tape & Reel |
| ASMT-JH13-AST01 | Red-Orange | 610-620nm | T(67.2-87.4lm); S(51.7-67.2lm) | 62lm | - | 500mA | 165 | No | Tape & Reel |
| ASMT-JR10-AST01 | Red | 620-635nm | S(51.7-67.2lm); T(67.2-87.4lm) | 60lm | - | 500mA | 165 | Yes | Tape & Reel |

Notes:

- Narrow Color Temperature selections are available on request.
- Narrow color bin selections for blue, green, amber, royal-blue, and cyan are available on request.
- For royal-blue, the wavelength shown in the above table is peak wavelength.

3W Mini High Power LEDs

| Part Number | Color | Color Temperature (K)/ Wavelength (nm) | Flux Bin (Luminous Flux/Radiometric Power @ 350mA) | Luminous Flux (lm) @ 350mA (typ) | Luminous Flux (lm) @ 700mA (typ) | Max. Current | Viewing Angle | Electrically Isolated Metal Slug | Packaging |
|-----------------|---------------|--|--|----------------------------------|----------------------------------|--------------|---------------|----------------------------------|-------------|
| ASMT-JW32-NWY01 | Cool White | 4500-10000K | W(113.6-129.5lm); X(129.5-147.7lm); Y(147.7-168.4lm) | 140 | 239 | 700mA | 140 | Yes | Tape & Reel |
| ASMT-JW32-NWYJ1 | Cool White | 5000-6300K | W(113.6-129.5lm); X(129.5-147.7lm); Y(147.7-168.4lm) | 140 | 239 | 700mA | 140 | Yes | Tape & Reel |
| ASMT-JN32-NWY01 | Neutral White | 3500-4500K | W(113.6-129.5lm); X(129.5-147.7lm); Y(147.7-168.4lm) | 140 | 239 | 700mA | 140 | Yes | Tape & Reel |
| ASMT-JN32-NWYH1 | Neutral White | 3800-4500K | W(113.6-129.5lm); X(129.5-147.7lm); Y(147.7-168.4lm) | 140 | 239 | 700mA | 140 | Yes | Tape & Reel |
| ASMT-JY32-NWY01 | Warm White | 2700-3500K | W(113.6-129.5lm); X(129.5-147.7lm); Y(147.7-168.4lm) | 130 | 222 | 700mA | 140 | Yes | Tape & Reel |
| ASMT-JY32-NWYK1 | Warm White | 3050-3500K | W(113.6-129.5lm); X(129.5-147.7lm); Y(147.7-168.4lm) | 130 | 222 | 700mA | 140 | Yes | Tape & Reel |
| ASMT-JL31-NRS01 | Royal Blue | 440-460nm ⁽³⁾ | R(515-595mW); S(595-685lm) | 600mW | 1020mW | 700mA | 165 | Yes | Tape & Reel |
| ASMT-JG31-NUW01 | Green | 515-535nm ⁽²⁾ | U(87.4-99.6lm); V(99.6-113.6lm); W(113.6-129.5lm) | 110lm | 176lm | 700mA | 165 | Yes | Tape & Reel |
| ASMT-JA30-ARS01 | Amber | 587-597nm ⁽²⁾ | R(39.8-51.7lm); S(51.7-67.2lm) | 48lm | 86lm | 700mA | 165 | No | Tape & Reel |
| ASMT-JH33-AST01 | Red-Orange | 610-620nm | T(67.2-87.4lm); S(51.7-67.2lm) | 62lm | 112lm | 700mA | 165 | No | Tape & Reel |
| ASMT-JR30-AST01 | Red | 620-635nm | S(51.7-67.2lm); T(67.2-87.4lm) | 58lm | 104lm | 700mA | 165 | Yes | Tape & Reel |
| ASMT-JD33-ANQ01 | Deep Red | 650-670nm ⁽³⁾ | N(275-355mW); P(355-435mW); Q(435-515mW) | 395mW | 790mW | 700mA | 165 | Yes | Tape & Reel |

Notes:

- Narrow Color Temperature selections are available on request.
- Narrow color bin selections for blue, green, amber and royal-blue are available on request.
- For royal-blue and deep red, the wavelength shown in the above table is peak wavelength.

High CRI 3W Mini High Power LEDs

| Part Number | Color | Color Temperature K)/ Wavelength (nm) | Flux Bin (Luminous Flux/Radiometric Power @ 350mA) | Luminous Flux (lm) @ 350mA (typ) | Luminous Flux (lm) @ 700mA (typ) | Max. Current | Viewing Angle | Electrically Isolated Metal Slug | Packaging |
|-----------------|---------------|---------------------------------------|--|----------------------------------|----------------------------------|--------------|---------------|----------------------------------|-------------|
| ASMT-JW33-NVW00 | Cool White | 4500-10000K | V(99.6-113.6lm); W(113.6-129.5lm) | 110lm | 196lm | 700mA | 140 | Yes | Tape & Reel |
| ASMT-JN33-NVW00 | Neutral White | 3500-4500K | V(99.6-113.6lm); W(113.6-129.5lm) | 110lm | 196lm | 700mA | 140 | Yes | Tape & Reel |
| ASMT-JY33-NTU01 | Warm White | 2700-3500K | T(67.2-87.4lm); U(87.4-99.6lm); V(99.6-113.6lm) | 90lm | 160lm | 700mA | 140 | Yes | Tape & Reel |

Notes:

1. Narrow Color Temperature selections are available on request.

Package Drawings

1W & 3W High Power LED

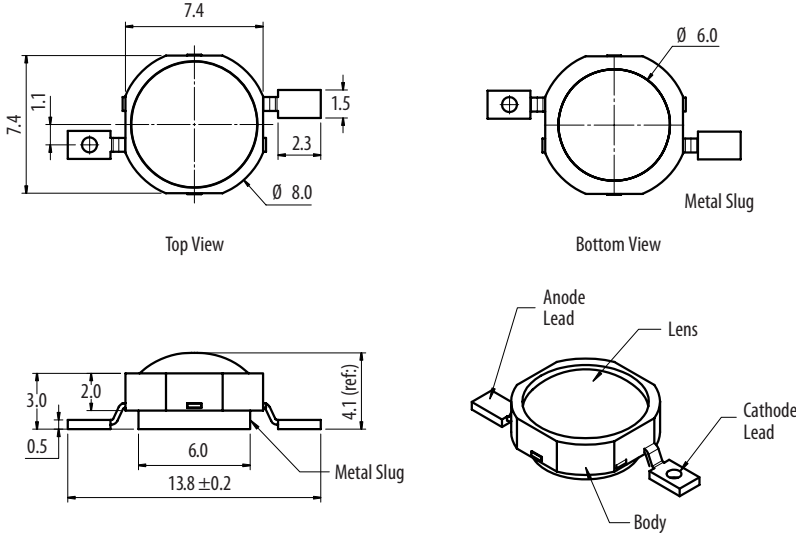

1W & 3W Mini High Power LED

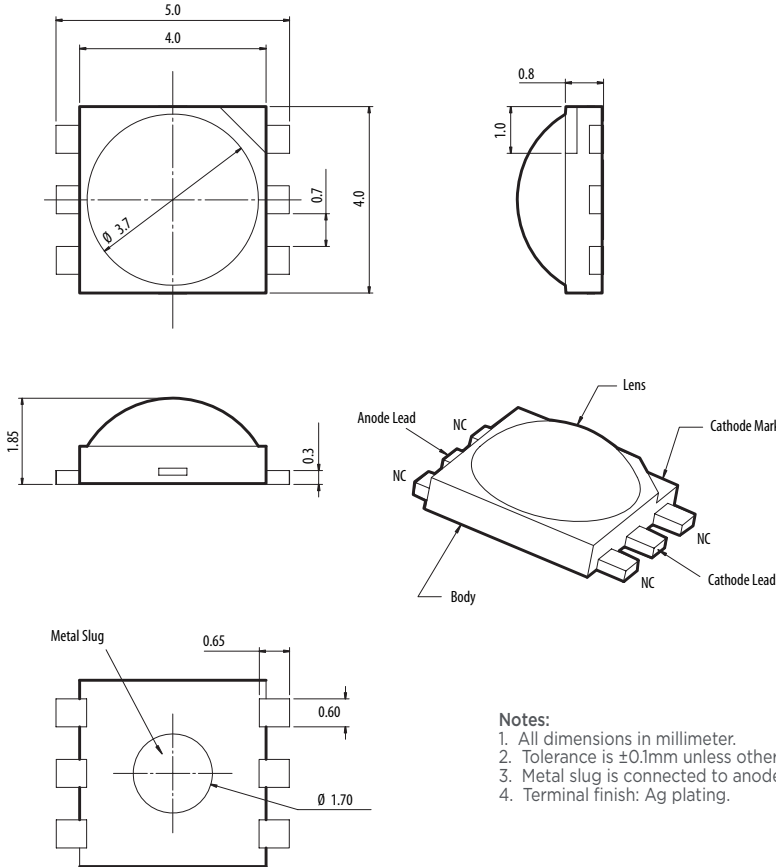

- Notes:**
1. All dimensions in millimeter.
 2. Tolerance is ± 0.1 mm unless otherwise specified.
 3. Metal slug is connected to anode for electrically non-isolated package.
 4. Terminal finish: Ag plating.

Moonstone® High Power LEDs

Description

Broadcom's Moonstone High Power LED is a high-performance, energy-efficient device that can handle high thermal and high-driving current. The exposed pad design has excellent heat transfer from the package to the motherboard. The low-profile package design is suitable for a wide variety of applications, especially where height is a constraint. The package is compatible with the SMT reflow soldering process. This will give more freedom and flexibility to the light source designer.

Benefits

- Available in White, Blue, Green, Red and Amber color
- Energy efficient
- Exposed pad for excellent heat transfer
- Suitable for SMT process
- High-current operation
- Long operation life
- Wide viewing angle
- Silicone encapsulation
- Available in emitter and module

Applications

- Portable (flashlight, bicycle headlight)
- Reading light
- Architectural lighting
- Garden lighting
- Decorative lighting
- Street lighting
- Retail lighting
- Contour lighting
- Sign backlighting

Specifications

- InGaN: 3.2V (typ.) at 350mA; 3.6V (typ.) at 700mA
- AlInGaP: 2.1V (typ.) at 350mA
- Viewing angle of 120° and 110°



1W Moonstone™ High Power LEDs

| Part Number | Color | Color Temperature (K)/ Wavelength (nm) | Flux Bin (Luminous Flux/Radiometric Power @ 350mA) | Luminous Flux (lm) @ 350mA (typ) | Luminous Flux (lm) @ 500mA (typ) | Max. Current | Viewing Angle | Electrically Isolated Metal Slug | Packaging |
|-----------------|------------|--|--|----------------------------------|----------------------------------|--------------|---------------|----------------------------------|---------------------|
| ASMT-MW06-NM00 | Cool White | 4,000 - 10,000K | M(95-110lm); N (110-125lm) | 105 | 144 | 500mA | 110 | Yes | Tube |
| ASMT-MWB6-NM00 | Cool White | 4,000 - 10,000K | M(95-110lm); N (110-125lm) | 100 | 137 | 500mA | 110 | Yes | Tube |
| ASMT-MW04-NM00 | Cool White | 4,000 - 10,000K | M (95-110lm); N (110-125lm) | 105 | - | 350mA | 110 | Yes | Tube ⁽²⁾ |
| ASMT-MWB4-NM00 | Cool White | 4,000 - 10,000K | M (95-110lm); N (110-125lm) | 95 | - | 350mA | 110 | Yes | Tube ⁽²⁾ |
| ASMT-MY06-NM00 | Warm White | 2,600K-4,000K | M (95-110lm); N (110-125lm) | 100 | 137 | 500mA | 110 | Yes | Tube ⁽²⁾ |
| ASMT-MYB6-NM00 | Warm White | 2,600K-4,000K | M (95-110lm); N (110-125lm); | 98 | 134 | 500mA | 110 | Yes | Tube ⁽²⁾ |
| ASMT-MY04-NLM00 | Warm White | 2,600K-4,000K | L (73-95lm); M (95-110lm) | 100 | - | 350mA | 110 | Yes | Tube ⁽²⁾ |
| ASMT-MYB4-NLM00 | Warm White | 2,600K-4,000K | L (73-95lm); M (95-110lm) | 90 | - | 350mA | 110 | Yes | Tube ⁽²⁾ |
| ASMT-MB00-NDF00 | Blue | 455-475nm ⁽³⁾ | D(11.5-15lm); E(15-19.5lm); F(19.5-25.5lm) | 15 | - | 350mA | 120 | Yes | Tube ⁽²⁾ |
| ASMT-MG00-NLM00 | Green | 515-535nm ⁽³⁾ | L(73.0-95.0lm); M(95.0-124.0lm) | 85 | - | 350mA | 120 | Yes | Tube ⁽²⁾ |
| ASMT-MA00-AHJ00 | Amber | 582-594.5nm ⁽³⁾ | H(33-43lm); J(43-56lm) | 40lm | - | 350mA | 120 | No | Tube ⁽²⁾ |
| ASMT-MR00-AHJ00 | Red | 620-635nm | H(33-43lm); J(43-56lm) | 40 | - | 350mA | 120 | No | Tube ⁽²⁾ |

Notes:

1. Narrow Color Temperature selections are available on request.
2. All above listed LEDs are also available in Reel packing.
3. Narrow color bin selections for blue, green and amber are available on request.

3W Moonstone™ High Power LEDs

| Part Number | Color | Color Temperature (K)/ Wavelength (nm) | Flux Bin (Luminous Flux/Radiometric Power @ 350mA) | Luminous Flux (lm) @ 350mA (typ) | Luminous Flux (lm) @ 700mA (typ) | Max. Current | Viewing Angle | Electrically Isolated Metal Slug | Packaging |
|-----------------|---------------------|--|--|----------------------------------|----------------------------------|--------------|---------------|----------------------------------|---------------------|
| ASMT-MW22-NNP00 | Cool White | 4000-10000K | N(110-125lm); P(125-140lm) | 120 | 205 | 700mA | 110 | Yes | Tube ⁽²⁾ |
| ASMT-MWE2-NNP00 | Cool White Diffused | 4000-10000K | N(110-125lm); P(125-140lm) | 115 | 196 | 700mA | 110 | Yes | Tube ⁽²⁾ |
| ASMT-MY22-NMP00 | Warm White | 2600-4000K | M(95-110lm); N(110-125lm), P(125-140lm) | 100 | 170 | 700mA | 110 | Yes | Tube ⁽²⁾ |
| ASMT-MYE2-NMP00 | Warm White Diffused | 2600-4000K | M(95-110lm); N(110-125lm), P(125-140lm) | 98 | 167 | 700mA | 110 | Yes | Tube ⁽²⁾ |

Notes:

1. Narrow Color Temperature selections are available on request.
2. All above listed LEDs are also available in Reel packing.

3W RGB Tri-Color Moonstone™ High Power LED

| Part Number | Color | Color Temperature (K)/ Wavelength (nm) | Flux Bin (Luminous Flux/Radiometric Power @ 350mA) | Luminous Flux (lm) @ 700mA (typ) | Max. Current | Viewing Angle | Electrically Isolated Metal Slug | Packaging |
|-----------------|-------|--|--|----------------------------------|--------------|---------------|----------------------------------|---------------|
| ASMT-MT00-00001 | Red | 620-635nm | H(33-43lm); J(43-56lm) | 40 | 350mA | 120 | No | Tape and Reel |
| | Green | 515 - 535nm ⁽¹⁾ | L(73-95lm); M(95-124lm) | 85 | 350mA | 120 | Yes | |
| | Blue | 455 - 475nm ⁽¹⁾ | E(15-19.5lm), F(19.5-25.5lm), G(25.5-33lm) | 22 | 350mA | 120 | Yes | |

Notes:

1. Narrow Color Temperature selections are available on request.

Package Drawings

Moonstone LED Emitters

1W and 3W Moonstone

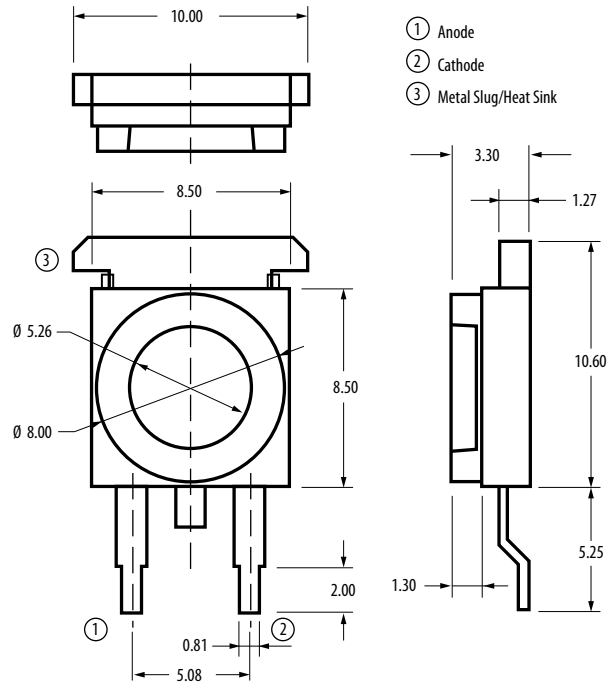

- Notes:
1. All Dimensions in millimeters.
 2. Tolerance is ± 0.1 mm unless otherwise specified.
 3. Metal slug is connected to anode for electrically non-isolated option.

3W RGB Tri-color Moonstone

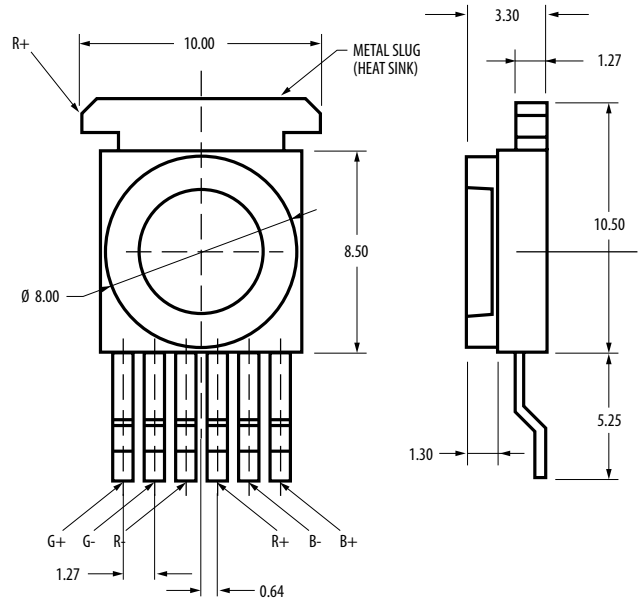

- Notes:
1. All dimensions in millimeters.
 2. Tolerance is ± 0.1 mm unless otherwise specified.
 3. Metal slug is connected to the anode of Red.

1W 3030 High Power LEDs

Description

The Broadcom 1W High Power White LED is a high performance energy efficient device that can handle high thermal and high driving current.

The package is compatible with reflow soldering process. To facilitate easy pick-and-place assembly, the LEDs are packed in tape and reel. Every reel is shipped in single intensity and color bin to provide close uniformity.

Applications

- Retail display lighting
- Under cabinet lighting
- Incandescent lamp replacement
- Indoor commercial and residential lighting
- Indoor decorative lighting



Benefits

- Available in 2700K, 3000K, 3500K, 4000K, 5000K, 5700K, 6200K, and 6500K
- Small footprint and low profile
- Energy efficient
- Compatible with reflow soldering process
- High current operation
- Long operation life
- Wide viewing angle
- Silicone encapsulation
- MSL 3 products

1W 3030 White High Power LEDs

| Part Number | Color | Color Temperature (K) | Luminous Flux, Φ_V (lm) | | | Test Current (mA) | Viewing Angle (°) | CRI |
|-----------------|-------------|-----------------------|------------------------------|-------|-------|-------------------|-------------------|-----|
| | | | Min | Typ | Max | | | |
| ASMF-PWG2-N45H0 | InGaN White | 6500 | 98.0 | 105.0 | 118.4 | 150 | 120 | 80 |
| ASMF-PWG2-N45G0 | InGaN White | 6200 | 98.0 | 105.0 | 118.4 | 150 | 120 | 80 |
| ASMF-PWG2-N45F0 | InGaN White | 5700 | 98.0 | 105.0 | 118.4 | 150 | 120 | 80 |
| ASMF-PWG2-N45E0 | InGaN White | 5000 | 98.0 | 105.0 | 118.4 | 150 | 120 | 80 |
| ASMF-PWG2-N45D0 | InGaN White | 4000 | 98.0 | 105.0 | 118.4 | 150 | 120 | 80 |
| ASMF-PWG2-N35C0 | InGaN White | 3500 | 89.2 | 102.0 | 118.4 | 150 | 120 | 80 |
| ASMF-PWG2-N35B0 | InGaN White | 3000 | 89.2 | 100.0 | 118.4 | 150 | 120 | 80 |
| ASMF-PWG2-N35A0 | InGaN White | 2700 | 89.2 | 100.0 | 118.4 | 150 | 120 | 80 |

1W 3030 White High Power LEDs

Part Numbering System

| | | | | | | | | | | | | | | |
|---|---|---|---|---|---|---|----|---|---|---|----------------|----------------|----------------|---|
| A | S | M | F | - | P | W | x1 | 2 | - | N | X ₂ | X ₃ | X ₄ | 0 |
|---|---|---|---|---|---|---|----|---|---|---|----------------|----------------|----------------|---|

| Code | Description | Option | |
|----------------|-----------------------|--------|------------------|
| X ₁ | Color Rendering Index | A | CRI ≥ 80 |
| X ₂ | Minimum flux bin | 3 | 89.2-98.0 lm |
| X ₃ | Maximum flux bin | 4 | 98.0-107.7 lm |
| | | 5 | 107.7-118.4 lm |
| X ₄ | Color bin | A | 2700K (bin: 27S) |
| | | B | 3000K (bin: 29S) |
| | | C | 3500K (bin: 34S) |
| | | D | 4000K (bin: 41S) |
| | | E | 5000K (bin: 50S) |
| | | F | 5700K (bin: 58G) |
| | | G | 6200K (bin: 62G) |
| | | H | 6500K (bin: 64S) |

Example: ASMF-PWG2-N35A0

X₁ = G CRI ≥ 80
 X₂ = 3 Minimum flux bin 3
 X₃ = 5 Maximum flux bin 5
 X₄ = A Color bin 27S

Bin Information

Intensity Bins (CAT)

| Bin ID | Luminous Flux (lm) | |
|--------|--------------------|-------|
| | Min. | Max. |
| 3 | 89.2 | 98.0 |
| 4 | 98.0 | 107.7 |
| 5 | 107.7 | 118.4 |

Tolerance ±12%

Forward Voltage Bins (VF)

| Bin ID | Forward voltage (V) | |
|--------|---------------------|------|
| | Min. | Max. |
| F21 | 6.0 | 6.2 |
| F22 | 6.2 | 6.4 |
| F23 | 6.4 | 6.6 |
| F24 | 6.6 | 6.8 |
| F25 | 6.8 | 7.0 |

Tolerance ±0.1V

Chromaticity Diagram

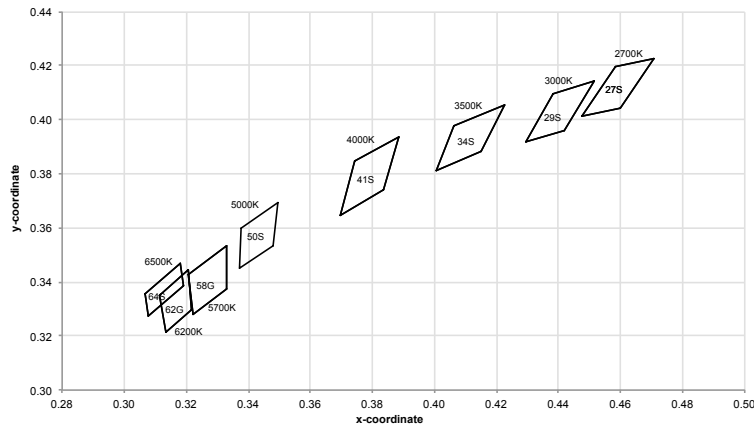

Color Bins (BIN)

| CCT | Bin ID | Chromaticity coordinates | |
|------|--------|--------------------------|--------|
| | | X | y |
| 2700 | 27S | 0.4475 | 0.4012 |
| | | 0.4582 | 0.4199 |
| | | 0.4708 | 0.4228 |
| | | 0.4598 | 0.4041 |
| 3000 | 29S | 0.4295 | 0.3918 |
| | | 0.4381 | 0.4097 |
| | | 0.4515 | 0.4145 |
| | | 0.4420 | 0.3962 |
| 3500 | 34S | 0.4006 | 0.3811 |
| | | 0.4061 | 0.3980 |
| | | 0.4226 | 0.4056 |
| | | 0.4150 | 0.3881 |
| 4000 | 41S | 0.3699 | 0.3646 |
| | | 0.3743 | 0.3846 |
| | | 0.3885 | 0.3934 |
| | | 0.3835 | 0.3741 |
| 5000 | 50S | 0.3372 | 0.3449 |
| | | 0.3378 | 0.3596 |
| | | 0.3496 | 0.3694 |
| | | 0.3478 | 0.3533 |
| 5700 | 58G | 0.3220 | 0.3280 |
| | | 0.3209 | 0.3425 |
| | | 0.3330 | 0.3533 |
| | | 0.3329 | 0.3375 |
| 6200 | 62G | 0.3133 | 0.3214 |
| | | 0.3113 | 0.3350 |
| | | 0.3208 | 0.3444 |
| | | 0.3219 | 0.3296 |
| 6500 | 64S | 0.3079 | 0.3274 |
| | | 0.3068 | 0.3354 |
| | | 0.3181 | 0.3467 |
| | | 0.3192 | 0.3387 |

Tolerance ±0.01

Example of bin information on label:

CAT: 3 Flux bin 3
 BIN: 27S Color bin 27S
 VF: F21 VF bin F21

1W Tri-color High Power LEDs

Description

The 1W Tri-Color High Power LED Light Source is a high performance energy efficient device which can handle high thermal and high driving current.

The low profile package design is suitable for a wide variety of applications especially where height is a constraint.

The package is compatible with eflow soldering process. This will give more freedom and flexibility to the light source designer.

Benefits

- Available in tri-color
- Energy efficient
- Compatible with reflow soldering process
- High current operation
- Long operation life
- Silicone encapsulation
- MSL 1 products
- MSL 3 products



Applications

- Sign backlight
- Retail display
- Commercial lighting
- Decorative lighting
- Architectural lighting

1W Tri-color High Power LEDs

| Part Number | Color | Wavelength (nm) | Flux Bin (Luminous Flux @ 150mA) | Luminous Flux (lm) @ 150mA (typ) | Max. Current | Viewing Angle |
|-----------------|-------|-----------------|----------------------------------|----------------------------------|--------------|---------------|
| ASMG-PT00-00001 | Red | 620-630nm | 25-35lm | 28lm | 200mA | 155 |
| | Green | 525-535nm | 38-54lm | 45lm | 200mA | 155 |
| | Blue | 455-460nm | 8.1-11.5lm | 9.5lm | 200mA | 155 |

Part Numbering System

| | | | | | | | | | | | | | | |
|---|---|---|---|---|---|----------------|---|---|---|---|----------------|----------------|----------------|---|
| A | S | M | G | - | P | X ₁ | 0 | 0 | - | 0 | X ₂ | X ₃ | X ₄ | 1 |
|---|---|---|---|---|---|----------------|---|---|---|---|----------------|----------------|----------------|---|

| Code | Description | Option | |
|----------------|-----------------------|--------|----------------------|
| X ₁ | Color | T | Tri-color |
| X ₂ | Minimum flux bin (lm) | 00 | Red: 25.0 - 35.0lm |
| X ₃ | Maximum flux bin (lm) | | Green: 38.0 - 54.0lm |
| X ₄ | Color bin | 0 | Blue: 8.1 - 11.5lm |
| | | | Full distribution |

Bin Information

Flux Bin Limit (CAT)

| Bin ID | Bin | Luminous Flux (lm) | |
|--------|-----|--------------------|------|
| | | Min. | Max. |
| Red | | 25.0 | 35.0 |
| Green | | 38.0 | 54.0 |
| Blue | | 8.1 | 11.5 |

Tolerance = ±10%

Color bin Limit (BIN)

| Bin ID | Bin | Luminous Flux (lm) | |
|--------|-----|--------------------|-------|
| | | Min. | Max. |
| Red | 4 | 620.0 | 630.0 |
| Green | 2 | 525.0 | 535.0 |
| Blue | A | 455.0 | 460.0 |

Tolerance = ±1.0nm

Example of bin information on reel and packaging label:

BIN: 42A Red color bin 4
 Green color bin 2
 Blue color bin A

3W Tri-color High Power LEDs

Description

The 3W Tri-Color High Power LED Light Source is a high performance energy efficient device which can handle high thermal and high driving current.

The low profile package design is suitable for a wide variety of applications especially where height is a constraint.

The package is compatible with reflow soldering process. This will give more freedom and flexibility to the light source designer.

Benefits

- Available in tri-color
- Energy efficient
- Compatible with reflow soldering process
- High current operation
- Long operation life
- Silicone encapsulation
- MSL 1 products

Applications

- Sign backlight
- Retail display
- Commercial lighting
- Decorative lighting
- Architectural lighting



3W Tri-color High Power LEDs

| Part Number | Color | Wavelength (nm) | Flux Bin (Luminous Flux @ 350mA) | Luminous Flux (lm) @ 350mA (typ) | Max. Current | Viewing Angle |
|-----------------|-------|-----------------|----------------------------------|----------------------------------|--------------|---------------|
| ASMG-ST00-00001 | Red | 613.5-631nm | 45-65lm | 55lm | 350mA | 135 |
| | Green | 515-535nm | 80-112lm | 95lm | 350mA | 170 |
| | Blue | 455-475nm | 18-26lm | 20lm | 350mA | 135 |

Part Numbering System

| | | | | | | | | | | | | | | |
|---|---|---|---|---|---|---|---|---|---|---|----------------|----------------|----------------|---|
| A | S | M | G | - | S | T | 0 | 0 | - | 0 | X ₁ | X ₂ | X ₃ | 1 |
|---|---|---|---|---|---|---|---|---|---|---|----------------|----------------|----------------|---|

| Code | Description | Option | |
|-------------------------------|---------------------|--------|--|
| X ₁ X ₂ | Flux bin selection | 00 | Red: 45-65lm Green: 80-112lm Blue: 18-26lm |
| X ₃ | Color bin selection | 0 | Red: bin 2 and 4 Green: bin A,1,2 and 3 Blue : bin A,1,2 and 3 |

Bin Information

Flux Bin Limit (CAT)

| Bin ID | Bin | Luminous Flux (lm) | |
|--------|-----|--------------------|------|
| | | Min. | Max. |
| Red | | 45 | 65 |
| Green | | 80 | 112 |
| Blue | | 18 | 26 |

Tolerance = ±10%

Color bin Limit (BIN)

| Color | Bin | Dominant Wavelength (nm) @ 350mA | |
|-------|-----|----------------------------------|-------|
| | | Min. | Max. |
| Red | 2 | 613.5 | 620.5 |
| | 4 | 620.5 | 631.0 |
| Green | A | 515.0 | 520.0 |
| | 1 | 520.0 | 525.0 |
| | 2 | 525.0 | 530.0 |
| | 3 | 530.0 | 535.0 |
| Blue | A | 455.0 | 460.0 |
| | 1 | 460.0 | 465.0 |
| | 2 | 465.0 | 470.0 |
| | 3 | 470.0 | 475.0 |

Tolerance = ±1 nm

Example of bin information on reel and packaging label:

BIN: 2A3 Red color bin 2
 Green color bin A
 Blue color bin 3

Package Drawings

1W 3030 White High Power LEDs

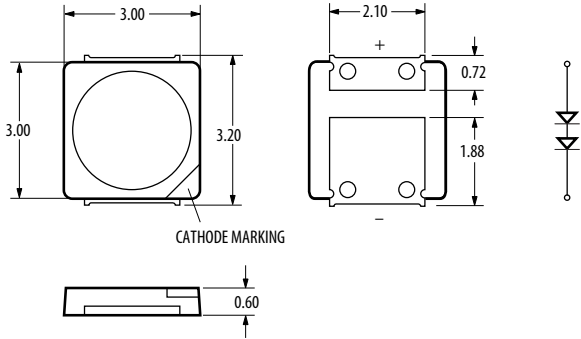

- Notes:**
1. All dimensions in millimeters (mm).
 2. Tolerance is $\pm 0.20\text{mm}$ unless otherwise specified.
 3. Encapsulation = silicone.
 4. Terminal finish = silver plating.

1W Tri-color High Power LEDs

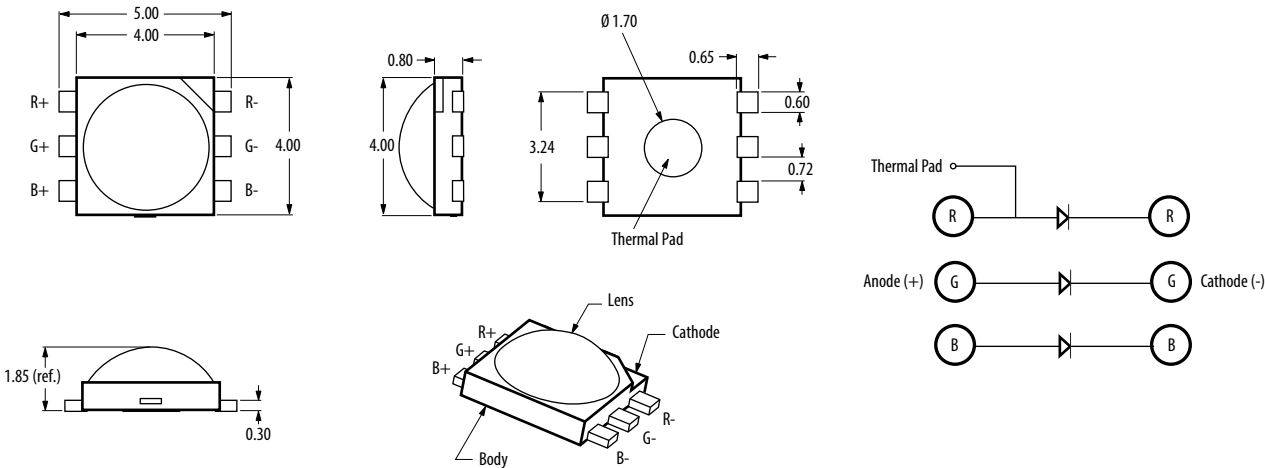

- Notes:**
1. All dimensions in millimeters (mm).
 2. Tolerance is $\pm 0.20\text{mm}$ unless otherwise specified.
 3. Encapsulation = silicone.
 4. Terminal finish = silver plating.
 5. Thermal pad is connected to anode of Red.

Package Drawings

3W Tri-color High Power LEDs

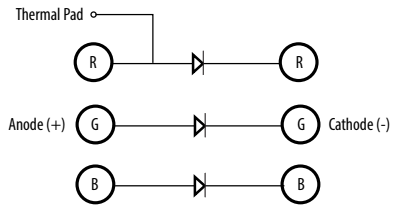
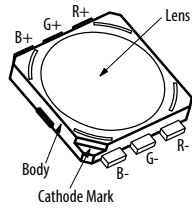
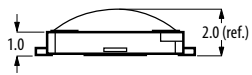
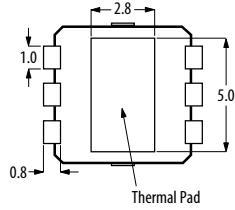
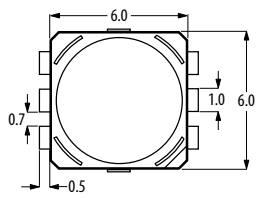

Notes:

1. All dimensions in millimeters (mm).
2. Tolerance is $\pm 0.20\text{mm}$ unless otherwise specified.
3. Encapsulation = silicone.
4. Terminal finish = silver plating.
5. Thermal pad is connected to anode of Red.

Standard Through-hole Lamps

Description

Broadcom offers four types of technology-based LEDs. GaP and AlGaAs based technologies are suitable for low to moderate light output requirements. AllnGaP and InGaN product offering are suitable for high brightness needs. Through-hole LEDs are offered in a variety of packages such as 3 mm, 5 mm, rectangular, bicolor, integrated resistors in standard and low current options.

These devices are molded from advanced optical grade epoxy, which provide superior high temperature performance and excellent moisture resistance.

Through-hole LEDs are suitable for all applications requiring backlighting and status indication. Consumer electronics and automotive interiors use LEDs to add value to their products. Low power consumption, high reliability and a broad range of colors and packages are just a few reasons why.

Benefits

- Excellent product quality and reliability
- Wide range of products
- Competitive pricing
- Wide operating temperature range
- With minor electrical/optical changes
- Lower power consumption
 - High efficiency, low drive currents and low driving voltages required
- Thin, light weight and robust packaging
 - Excellent performance even under vibration and mechanical shock

- Different material technologies available in standard GaP LED lamps
 - Choice of colors (560 nm – 626 nm): Green, Yellow, Amber, Orange and Red
- Red color using AlGaAs technology.
- Five colors available with high luminous intensity in AllnGaP LED lamps
 - Amber (590 nm), Red (626 nm), Deep Red (635 nm), Orange (605 nm) and Red-Orange (615 nm)
- Two colors available with high luminous intensity in InGaN LED lamps
 - Blue (470 nm) and Green (527 nm)
- Several packaging options
 - Different sizes with a clear or diffused lens, several lead configurations and different spatial radiation patterns available in bulk, ammo-pack, right angle housing and tape and reel



Applications

- Consumer
 - Ovens, washers, etc.
 - Audio, hi-fi and electrical appliances
 - Gaming and vending machines
 - Electronic toys and games
- Industrial
 - Sensors
 - Instruments
 - Measurement equipment
- Automotive and Other
 - Automotive interior
 - Exercise equipment
 - Medical equipment
 - Front panel industrial equipment

Standard Through-hole LED Lamps

| Part Number | Color | Dominant Wavelength (nm) | Viewing Angle | Lens | Intensity | | Vf Typ. (V) | Test Current (mA) |
|--|-----------------------|--------------------------|---------------|----------------------------|------------|------------|-------------|-------------------|
| | | | | | Min. (mcd) | Typ. (mcd) | | |
| 3 mm (T1) LED Lamps – Standard Current | | | | | | | | |
| HLMP-1301-G0002 | GaP Red | 626 | 60° | Tinted, Diffused | 8.6 | 11 | 1.9 | 10 |
| HLMP-1321 | GaP Red | 626 | 45° | Tinted, Non-diffused | 8.6 | 30 | 1.9 | 10 |
| HLMP-1340 | GaP Red | 626 | 45° | Micro-tinted, Non-diffused | 35.2 | 55 | 1.9 | 20 |
| HLMP-1401-E0000 | GaP Yellow | 585 | 60° | Tinted, Diffused | 5.7 | - | 2 | 10 |
| HLMP-1440 | GaP Yellow | 585 | 45° | Micro-tinted, Non-diffused | 23.5 | 45 | 2.1 | 20 |
| HLMP-1503 | GaP Green | 569 | 60° | Tinted, Diffused | 4.2 | 8.5 | 2.1 | 10 |
| HLMP-1521 | GaP Green | 569 | 45° | Tinted, Non-diffused | 6.7 | 22 | 2.1 | 10 |
| HLMP-1540 | GaP Green | 569 | 45° | Untinted, Non-diffused | 27.3 | 45 | 2.2 | 20 |
| HLMP-K101 | AlGaAs Red | 637 | 60° | Tinted, Diffused | 22 | 45 | 1.8 | 20 |
| HLMP-K105 | AlGaAs Red | 637 | 45° | Untinted, Non-diffused | 35.2 | 65 | 1.8 | 20 |
| HLMP-K640 | GaP Green | 560 | 45° | Untinted, Non-diffused | 4.2 | 21 | 2.2 | 20 |
| HLMP-Y601-J0000 | AllnGaP Red | 627 | 45 | Untinted, Non-diffused | 240 | 680 | 2.2 | 20 |
| HLMP-Y651-G0000 | AllnGaP Deep Red | 638 | 45 | Untinted, Non-diffused | 140 | 300 | 2.2 | 20 |
| HLMP-Y701-G0000 | AllnGaP Amber | 592 | 45 | Untinted, Non-diffused | 140 | 400 | 2.2 | 20 |
| HLMP-Y802-F0000 | AllnGaP Green | 572 | 45 | Tinted, Non-diffused | 110 | 240 | 2.4 | 20 |
| HLMP-Y901-J0000 | AllnGaP Yellow Orange | 605 | 45 | Untinted, Non-diffused | 240 | 680 | 2 | 20 |
| HLMP-Y951-K0000 | AllnGaP Red Orange | 615 | 45 | Untinted, Non-diffused | 310 | 680 | 2 | 20 |
| HLMP-KA45-E0000 | InGaN Blue | 464 | 50 | Untinted, Non-diffused | 85 | 480 | 3.5 | 20 |
| 3 mm (T1) LED Lamps – Autoinsertable | | | | | | | | |
| HLMP-NG05 | AllnGaP Red | 626 | 45° | Micro-tinted, Non-diffused | 90.2 | 435 | 1.90 | 20 |
| HLMP-NG07 | AllnGaP Red | 626 | 60° | Micro-tinted, Non-diffused | 90.2 | 435 | 1.90 | 20 |
| HLMP-NL06 | AllnGaP Amber | 590 | 60° | Micro-tinted, Non-diffused | 96.2 | 450 | 2.02 | 20 |
| HLMP-NS30-J0000 | InGaN Blue | 470 | 30° | Untinted, Non-diffused | 240 | 550 | 3.6 | 20 |
| HLMP-NM31-R0000 | InGaN Green | 529 | 30° | Untinted, Non-diffused | 1500 | 2800 | 3.3 | 20 |
| HL3P-BA60-J00DD | AllnGaP Amber | 587 | 60° | Tinted, Diffused | 240 | 450 | 2.0 | 20 |
| HL3P-BF60-C00DD | AllnGaP Yellow Green | 570 | 60° | Tinted, Diffused | 50 | 100 | 2.0 | 20 |
| HL3P-BJ60-J00DD | AllnGaP Orange | 605 | 60° | Tinted, Diffused | 240 | 450 | 2.0 | 20 |
| HL3P-BR60-J00DD | AllnGaP Red | 627 | 60° | Tinted, Diffused | 240 | 380 | 2.0 | 20 |
| HL3P-NA45-J00DD | AllnGaP Amber | 587 | 45° | Untinted, Non diffused | 240 | 600 | 2.0 | 20 |
| HL3P-NF45-D00DD | AllnGaP Yellow Green | 570 | 45° | Untinted, Non diffused | 65 | 200 | 2.0 | 20 |
| HL3P-NJ45-J00DD | AllnGaP Orange | 605 | 45° | Untinted, Non diffused | 240 | 600 | 2.0 | 20 |
| HL3P-NR45-J00DD | AllnGaP Red | 627 | 45° | Untinted, Non diffused | 240 | 500 | 2.0 | 20 |
| 3 mm (T1) 5V, 12V Integrated Resistor LED Lamps | | | | | | | | |
| HLMP-1621 ^[1] | GaP Yellow | 585 | 60° | Tinted, Diffused | 2.2 | 8 | 8 | - |
| HLMP-1640-B00A2 ^[2] | GaP Green | 569 | 60° | Tinted, Diffused | 1.6 | 8 | 8 | - |











Notes:

1. Operating Voltage = 12V.
2. Operating Voltage = 5V.

Standard Through-hole LED Lamps

| Part Number | Color | Dominant Wavelength (nm) | Viewing Angle | Lens | Intensity | | Vf Typ. (V) | Test Current (mA) |
|--|----------------------|--------------------------|---------------|----------------------------|------------|------------|-------------|-------------------|
| | | | | | Min. (mcd) | Typ. (mcd) | | |
| 5mm (T1 3/4) LED Lamps - Standard Current | | | | | | | | |
| HLMP-3301 | GaP Red | 626 | 60° | Tinted, Diffused | 5.4 | 7 | 1.9 | 10 |
| HLMP-3401 | GaP Yellow | 585 | 60° | Tinted, Diffused | 5.7 | 8 | 2 | 10 |
| HLMP-3507 | GaP Green | 569 | 60° | Tinted, Diffused | 4.2 | 5.2 | 2.1 | 10 |
| HLMP-3950 | GaP Green | 569 | 24° | Micro-tinted, Non-diffused | 111.7 | 265 | 2.2 | 20 |
| HLMP-C008-U0000 | AllnGaP Red | 626 | 8° | Untinted, Non-diffused | 2900 | 6000 | 1.9 | 20 |
| HLMP-C025-P0000 | AllnGaP Red | 626 | 25° | Untinted, Non-diffused | 500 | 1000 | 1.9 | 20 |
| HLMP-C208-S0000 | AllnGaP Amber | 590 | 8° | Untinted, Non-diffused | 2600 | 3000 | 1.9 | 20 |
| HLMP-C225-O0000 | AllnGaP Amber | 590 | 25° | Untinted, Non-diffused | 450 | 800 | 1.9 | 20 |
| HLMP-C608-R0000 | AllnGaP Red | 635 | 8° | Untinted, Non-diffused | 1000 | 2000 | 1.9 | 20 |
| HLMP-C625-P0000 | AllnGaP Red | 635 | 25° | Untinted, Non-diffused | 500 | 700 | 1.9 | 20 |
| HLMP-DB25-B0000 | GaN Blue | 462 | 25° | Untinted, Non-diffused | 40 | 100 | 4 | 20 |
| HLMP-DM25-J0000 | InGaN Green | 527 | 25° | Untinted, Non-diffused | 240 | 970 | 3.8 | 20 |
| HLMP-DS25-F0000 | InGaN Blue | 470 | 25° | Untinted, Non-diffused | 110 | 260 | 3.6 | 20 |
| HL5P-BA60-K0000 | AllnGaP Amber | 587 | 60° | Tinted, Diffused | 310 | 460 | 2.0 | 20 |
| HL5P-BF60-D0000 | AllnGaP Yellow Green | 570 | 60° | Tinted, Diffused | 65 | 100 | 2.0 | 20 |
| HL5P-BJ60-K0000 | AllnGaP Orange | 605 | 60° | Tinted, Diffused | 310 | 440 | 2.0 | 20 |
| HL5P-BR60-J0000 | AllnGaP Red | 627 | 60° | Tinted, Diffused | 240 | 360 | 2.0 | 20 |
| HL5P-NA45-M0000 | AllnGaP Amber | 587 | 45° | Untinted, Non diffused | 520 | 850 | 2.0 | 20 |
| HL5P-NF45-G0000 | AllnGaP Yellow Green | 570 | 45° | Untinted, Non diffused | 140 | 250 | 2.0 | 20 |
| HL5P-NJ45-M0000 | AllnGaP Orange | 605 | 45° | Untinted, Non diffused | 520 | 850 | 2.0 | 20 |
| HL5P-NR45-K0000 | AllnGaP Red | 627 | 45° | Untinted, Non diffused | 310 | 500 | 2.0 | 20 |
| HL5P-NA25-P0000 | AllnGaP Amber | 587 | 25° | Untinted, Non diffused | 880 | 1400 | 2.0 | 20 |
| HL5P-NF25-J0000 | AllnGaP Yellow Green | 570 | 25° | Untinted, Non diffused | 240 | 500 | 2.0 | 20 |
| HL5P-NJ25-P0000 | AllnGaP Orange | 605 | 25° | Untinted, Non diffused | 880 | 1400 | 2.0 | 20 |
| HL5P-NR25-N0000 | AllnGaP Red | 627 | 25° | Untinted, Non diffused | 680 | 1000 | 2.0 | 20 |
| 5 mm (T1 3/4) LED Lamps – Low Current | | | | | | | | |
| HLMP-4700 | GaP Red | 626 | 50° | Tinted, Diffused | 1.3 | 2.3 | 1.7 | 2 |
| HLMP-4719 | GaP Yellow | 585 | 50° | Tinted, Diffused | 0.9 | 2.1 | 1.8 | 2 |
| HLMP-4740 | GaP Green | 569 | 50° | Tinted, Diffused | 1 | 2.3 | 1.9 | 2 |
| HLMP-D150 | AlGaAs Red | 637 | 65° | Tinted, Diffused | 1.3 | 3 | 1.6 | 1 |

Standard Through-hole Lamps

| Part Number | Color | Dominant Wavelength (nm) | Viewing Angle | Lens | Intensity | | Vf Typ. (V) | Test Current (mA) |
|--|--|--------------------------|---------------|------------------------|------------|------------|-------------|-------------------|
| | | | | | Min. (mcd) | Typ. (mcd) | | |
| 2 mm x 5 mm Rectangular LED Lamps | | | | | | | | |
| HLMP-S201 |  GaP Red | 626 | 110° | Tinted, Diffused | 3.4 | 7.5 | 1.9 | 20 |
| HLMP-S301 |  GaP Yellow | 585 | 110° | Tinted, Diffused | 2.2 | 4 | 2.1 | 20 |
| HLMP-S501 |  GaP Green | 569 | 110° | Tinted, Diffused | 4.2 | 8 | 2.2 | 20 |
| 2mm x 5mm Bicolor Rectangular LED Lamps | | | | | | | | |
| HLMP-0800 |  GaP Green | 570 | 100° | Untinted, Diffused | 2.6 | - | 2.2 | 20 |
| |  GaP Red | 626 | 100° | Untinted, Diffused | 2.1 | - | 1.9 | 20 |
| HLMP-0805 |  GaP Green | 570 | 100° | Untinted, Diffused | 2.6 | - | 2.2 | 20 |
| |  GaP Yellow | 585 | 100° | Untinted, Diffused | 1.4 | - | 2.1 | 20 |
| 5 mm (T1 3/4) LED Lamps — Bicolor | | | | | | | | |
| HLMP-4000 |  GaP Green | 570 | 65° | Untinted, Diffused | 4.2 | - | 2.2 | 10 |
| |  GaP Red | 626 | 65° | Untinted, Diffused | 2.1 | - | 1.9 | 10 |
| HLMP-4015 |  GaP Green | 570 | 65° | Untinted, Non-Diffused | 20 | - | 2.2 | 20 |
| |  GaP Yellow | 585 | 65° | Untinted, Non-Diffused | 20 | - | 2.6 | 20 |

Intensity Bin Limits

| Bin ID | Intensity (mcd) | |
|--------|-----------------|-------|
| | Min. | Max. |
| A | 0.6 | 0.9 |
| B | 0.9 | 1.5 |
| C | 1.5 | 2.4 |
| D | 2.4 | 3.8 |
| E | 3.8 | 6.1 |
| F | 6.1 | 9.7 |
| G | 9.7 | 15.5 |
| H | 15.5 | 24.8 |
| I | 24.8 | 39.6 |
| J | 39.6 | 63.4 |
| K | 63.4 | 101.5 |
| L | 101.5 | 162.4 |
| M | 162.4 | 234.6 |
| N | 234.6 | 340.0 |
| O | 340 | 540 |
| P | 540 | 850 |
| Q | 850 | 1200 |
| R | 1200 | 1700 |
| S | 1700 | 2400 |
| T | 2400 | 3400 |
| U | 3400 | 4900 |
| V | 4900 | 7100 |
| W | 7100 | 10200 |
| X | 10200 | 14800 |
| Y | 14800 | 21400 |
| Z | 21400 | 30900 |

Tolerance: ±18%

| Bin ID | Intensity (mcd) | |
|--------|-----------------|-------|
| | Min. | Max. |
| A | 1.0 | 1.6 |
| B | 1.6 | 2.5 |
| C | 2.5 | 4.0 |
| D | 4.0 | 6.5 |
| E | 6.5 | 10.3 |
| F | 10.3 | 16.6 |
| G | 16.6 | 26.5 |
| H | 26.5 | 42.3 |
| I | 42.3 | 67.7 |
| J | 67.7 | 108.2 |
| K | 108.2 | 173.2 |
| L | 173.2 | 250.0 |
| M | 250 | 360 |
| N | 360 | 510 |
| O | 510 | 800 |
| P | 800 | 1250 |
| Q | 1250 | 1800 |
| R | 1800 | 2900 |
| S | 2900 | 4700 |
| T | 4700 | 7200 |
| U | 7200 | 11700 |
| V | 11700 | 18000 |
| W | 18000 | 27000 |

Tolerance: ±18%

| Bin ID | Intensity (mcd) | |
|--------|-----------------|-------|
| | Min. | Max. |
| A | 1.1 | 1.8 |
| B | 1.8 | 2.9 |
| C | 2.9 | 4.7 |
| D | 4.7 | 7.6 |
| E | 7.6 | 12.0 |
| F | 12.0 | 19.1 |
| G | 19.1 | 30.7 |
| H | 30.7 | 49.1 |
| I | 49.1 | 78.5 |
| J | 78.5 | 125.7 |
| K | 125.7 | 201.1 |
| L | 201.1 | 289.0 |
| M | 289 | 417 |
| N | 417 | 680 |
| O | 680 | 1100 |
| P | 1100 | 1800 |
| Q | 1800 | 2700 |
| R | 2700 | 4300 |
| S | 4300 | 6800 |
| T | 6800 | 10800 |
| U | 10800 | 16000 |
| V | 16000 | 25000 |
| W | 25000 | 40000 |



* Except InGaN Green

Tolerance: ±18%

| Bin ID | Intensity (mcd) | |
|--------|-----------------|-------|
| | Min. | Max. |
| A | 30 | 40 |
| B | 40 | 50 |
| C | 50 | 65 |
| D | 65 | 85 |
| E | 85 | 110 |
| F | 110 | 140 |
| G | 140 | 180 |
| H | 180 | 240 |
| J | 240 | 310 |
| K | 310 | 400 |
| L | 400 | 520 |
| M | 520 | 680 |
| N | 680 | 880 |
| P | 880 | 1150 |
| Q | 1150 | 1500 |
| R | 1500 | 1900 |
| S | 1900 | 2500 |
| T | 2500 | 3200 |
| U | 3200 | 4200 |
| V | 4200 | 5500 |
| W | 5500 | 7200 |
| X | 7200 | 9300 |
| Y | 9300 | 12000 |

Tolerance: ±15%

Color Bin Limits

| Bin ID | | Dominant Wavelength (nm) | |
|--|--|--------------------------|-------|
| | | Min. | Max. |
| Orange  | | | |
| 2 | | 599.5 | 602.0 |
| 3 | | 602.0 | 604.5 |
| 4 | | 604.5 | 607.5 |
| 5 | | 607.5 | 610.5 |
| Yellow  | | Min. | Max. |
| 1 | | 582.0 | 584.5 |
| 3 | | 584.5 | 587.0 |
| 2 | | 587.0 | 589.5 |
| 4 | | 589.5 | 592.0 |
| 5 | | 592.0 | 593.0 |
| Amber  | | Min. | Max. |
| 1 | | 584.5 | 587.0 |
| 2 | | 587.0 | 589.5 |
| 4 | | 589.5 | 592.0 |
| 6 | | 592.0 | 594.5 |
| 7 | | 594.5 | 597.0 |
| Emerald Green  | | Min. | Max. |
| 1 | | 582.0 | 584.5 |
| 3 | | 584.5 | 587.0 |
| 2 | | 587.0 | 589.5 |
| 4 | | 589.5 | 592.0 |
| 5 | | 592.0 | 593.0 |

Tolerance: ±1.0nm

| Bin ID | | Dominant Wavelength (nm) | |
|---|--|--------------------------|-------|
| | | Min. | Max. |
| Green (except InGaN Green)  | | | |
| 6 | | 561.5 | 564.5 |
| 5 | | 564.5 | 567.5 |
| 4 | | 567.5 | 570.5 |
| 3 | | 570.5 | 573.5 |
| 2 | | 573.5 | 576.5 |
| Yellow  | | Min. | Max. |
| 1 | | 520.0 | 524.0 |
| 3 | | 524.0 | 528.0 |
| 2 | | 528.0 | 532.0 |
| 4 | | 532.0 | 536.0 |
| 5 | | 536.0 | 540.0 |
| Blue  | | Min. | Max. |
| 1 | | 460.0 | 464.0 |
| 2 | | 464.0 | 468.0 |
| 3 | | 468.0 | 472.0 |
| 4 | | 472.0 | 476.0 |
| 5 | | 476.0 | 480.0 |

Tolerance: ±1.0nm

Package Drawings

3 mm (T1) LED Lamps - Autoinsertable Package

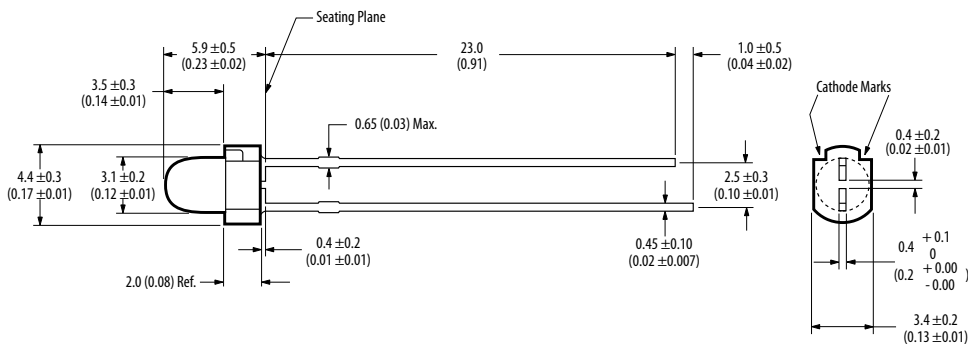

3 mm (T1) LED Lamps Package

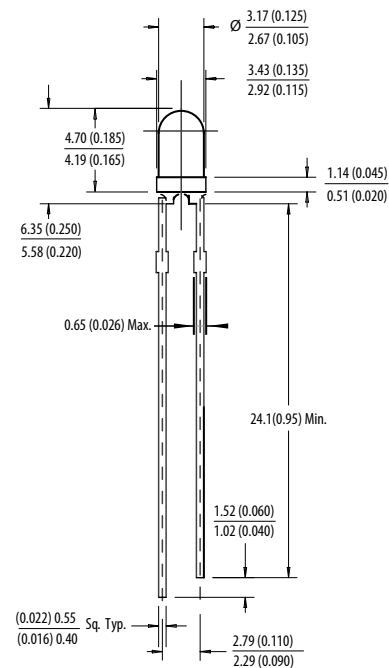

For HL3P-xxxx series

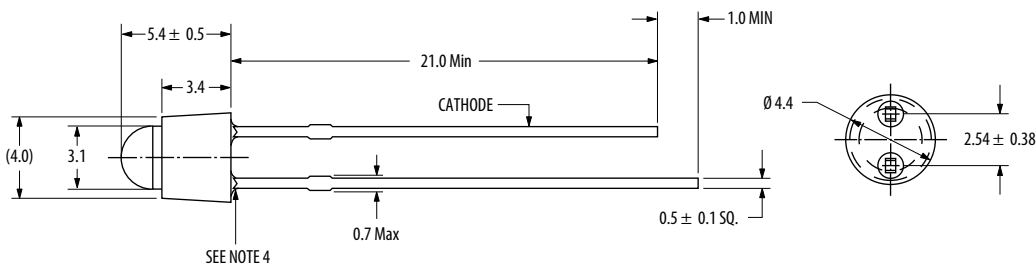

- Notes:
1. All dimensions in millimeters (inches). Dimension in bracket is for reference only.
 2. Tolerance is ± 0.30 mm unless otherwise specified.
 3. Lead spacing is measured at where the leads emerge from the package.
 4. Epoxy meniscus is 1.0mm max below the body.

3 mm (T1) AlInGaP LED Lamps Package

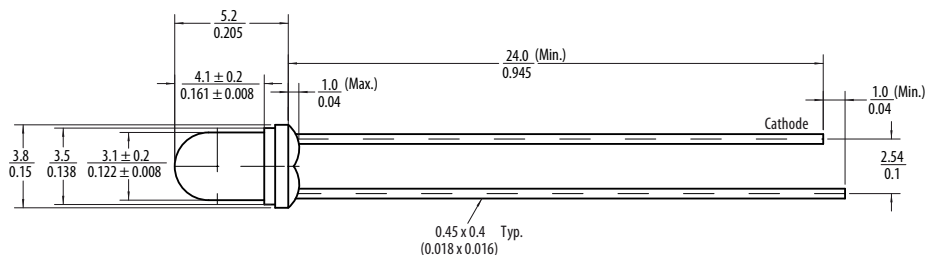

- Notes:
1. All dimensions in millimeters (inches).
 2. Leads are mild steel. Solder coated.
 3. Epoxy Meniscus of 0.8 mm (0.03 in.) maximum may extend to the leads.

Subminiature Lamps

Description

Broadcom's Subminiature Lamps are designed for modern printed circuit (PC) boards, replacing through-hole mounted components for many traditional functions with smaller components, sized for closer placement.

Subminiature lamp components are available in several lead configurations and can be used for top mount, reverse mount, and through-hole applications. The lead configurations are 'Gull Wing'-011 option, 'Yoke Bend'-021 option and 'Z Bend'-031 option. A variety of packages are available, such as flat top, dome and rectangular in standard or low current options.

Besides this, PCB based subminiature lamps are available as well. These lamps come in un-tinted, non-diffused package to cater for various product themes and ease handling applications. The small size, narrow footprint and high brightness make these LEDs excellent for backlighting, status indication and panel illumination applications.

Benefits

- Excellent product quality
- Wide range of product offering
- Competitive pricing
- Can be used with surface mount or through-hole applications
- High reliability
 - No replacement for life of equipment
- Wide operating temperature range
 - Minor electrical/optical changes

- Lower power consumption
 - High efficiency, low drive currents required, low driving voltages
- Thin, light-weight and robust packaging
 - Excellent performance even under vibration and mechanical shock
- Different thin material technologies available
 - Several colors available in GaP
 - Choice of colors (560 - 626 nm): Green, Yellow, Amber, Orange, Red and Deep Red
- Three colors available in AlnGaP
 - Amber (590 nm), Red (626 nm) and Orange (605 nm)
- Two colors available in InGaN
 - Blue (472 nm), Green (526 nm)
- Several lead configuration options
 - Gull-wing, Yoke-bend and Z-bend
- Several packaging options
 - Different sizes and spatial radiation patterns available in bulk, right angle housing, and tape and reel



Applications

- Industrial and Communication
 - Front panel and symbol indicator
 - Keypad and push button backlighting
- Consumer
 - CD player, hi-fi audio and electrical appliances
 - Keypad and push button backlighting
- Automotive
 - Dashboard panel and symbol backlighting
 - Car radio indicators

Domed Subminiature Lamps

| Part Number | Color | Dominant Wavelength (nm) | Viewing Angle | Lens | Intensity | | Vf Typ. (V) | Test Current (mA) |
|-----------------|---------------------|--------------------------|---------------|------------------------|------------|------------|-------------|-------------------|
| | | | | | Min. (mcd) | Typ. (mcd) | | |
| HLMP-Q106-R00xx | Deep Red | 644 | 15° | Untinted, Non-diffused | 100 | 400 | 1.9 | 20 |
| HLMA-QG00-S00xx | AllInGaP Red | 626 | 15° | Untinted, Non-diffused | 160 | 500 | 1.9 | 20 |
| HLMT-QG00-T00xx | AllInGaP Red | 622 | 15° | Untinted, Non-diffused | 250 | 1000 | 2 | 20 |
| HLMP-6300-F00xx | GaP Red | 626 | 90° | Tinted, Diffused | 1 | 10 | 1.8 | 10 |
| HLMA-QH00-S00xx | AllInGaP Red-Orange | 615 | 15° | Untinted, Non-diffused | 160 | 500 | 1.9 | 20 |
| HLMT-QH00-T00xx | AllInGaP Red-Orange | 615 | 15° | Untinted, Non-diffused | 250 | 500 | 2 | 20 |
| HLMA-QJ00-S00xx | AllInGaP Orange | 605 | 15° | Untinted, Non-diffused | 160 | 500 | 1.9 | 20 |
| HLMA-QL00-S00xx | AllInGaP Amber | 590 | 15° | Untinted, Non-diffused | 160 | 500 | 1.9 | 20 |
| HLMT-QL00-Txxxx | AllInGaP Amber | 590 | 15° | Untinted, Non-diffused | 250 | - | 2 | 20 |
| HLMP-6400-F00xx | GaP Yellow | 585 | 90° | Tinted, Diffused | 1 | 9 | 2 | 10 |
| HLMP-6500-F00xx | GaP Green | 569 | 90° | Tinted, Diffused | 1 | 7 | 2.1 | 10 |
| HLMP-6505-L00xx | GaP Green | 569 | 28° | Untinted, Non-diffused | 10 | 40 | 2.1 | 10 |
| HLMP-QB00-S00xx | InGaN Blue | 468 | 20° | Untinted, Non-diffused | - | 160 | 290 | 3.7 |
| HLMP-QM00-S00xx | InGaN Green | 525 | 20° | Untinted, Non-diffused | - | 160 | 690 | 3.7 |

Domed Subminiature Lamps — Low Current

| | | | | | | | | |
|-----------------|------------|-----|-----|------------------|-----|-----|-----|-----|
| HLMP-Q150-F00xx | AlGaAs Red | 637 | 90° | Tinted, Diffused | 1 | 1.8 | 1.8 | 1.6 |
| HLMP-7000-D00xx | GaP Red | 626 | 90° | Tinted, Diffused | 0.4 | 1 | 1.4 | 1.8 |
| HLMP-7019-D00xx | GaP Yellow | 585 | 90° | Tinted, Diffused | 0.4 | 0.6 | 1.6 | 2 |
| HLMP-7040-D00xx | GaP Green | 569 | 90° | Tinted, Diffused | 0.4 | 0.6 | 1.4 | 2.1 |

Domed Subminiature Lamps — Resistor

| Part Number | Color | Dominant Wavelength (nm) | Viewing Angle | Lens | Intensity | | Vf Typ. (V) | Test Current (mA) |
|-----------------|------------|--------------------------|---------------|------------------|------------|------------|-------------|-------------------|
| | | | | | Min. (mcd) | Typ. (mcd) | | |
| HLMP-6600-G00xx | GaP Red | 626 | 90° | Tinted, Diffused | 1.6 | 5 | 9.6 | 5 |
| HLMP-6620-F00xx | GaP Red | 626 | 90° | Tinted, Diffused | 1 | 2 | 3.5 | 5 |
| HLMP-6720-F00xx | GaP Yellow | 585 | 90° | Tinted, Diffused | 0.9 | 2 | 3.5 | 5 |
| HLMP-6800-G00xx | GaP Green | 569 | 90° | Tinted, Diffused | 1.6 | 5 | 9.6 | 5 |
| HLMP-6820-F00xx | GaP Green | 569 | 90° | Tinted, Diffused | 1 | 2 | 3.5 | 5 |

Flat Top Subminiature Lamps

| | | | | | | | | |
|-----------------|---------------------|-----|------|------------------------|-----|-----|-----|----|
| HLMP-P105-L00xx | AlGaAs Red | 637 | 125° | Untinted, Non-diffused | 10 | 30 | 1.8 | 20 |
| HLMA-PG00-N00xx | AllInGaP Red | 626 | 125° | Untinted, Non-diffused | 25 | 75 | 1.9 | 20 |
| HLMT-PG00-P00xx | AllInGaP Red | 622 | 125° | Untinted, Non-diffused | 40 | 150 | 2 | 20 |
| HLMP-P205-F00xx | GaP Red | 626 | 125° | Untinted, Non-diffused | 1 | 8 | 1.8 | 10 |
| HLMT-PH00-P00xx | AllInGaP Red Orange | 615 | 125° | Untinted, Non-diffused | 40 | 120 | 2 | 20 |
| HLMA-PJ00-N00xx | AllInGaP Orange | 605 | 125° | Untinted, Non-diffused | 25 | 75 | 2 | 20 |
| HLMA-PL00-N00xx | AllInGaP Amber | 590 | 125° | Untinted, Non-diffused | 25 | 75 | 1.9 | 20 |
| HLMT-PL00-POWxx | AllInGaP Amber | 590 | 125° | Untinted, Non-diffused | 40 | 150 | 2.4 | 20 |
| HLMP-P505-G00xx | GaP Green | 569 | 125° | Untinted, Non-diffused | 1.6 | 6.5 | 2.1 | 10 |
| HLMP-P605-F00xx | GaP Emerald Green | 560 | 125° | Untinted, Non-diffused | 1 | 1.5 | 2.2 | 10 |
| HLMP-PB00-N00xx | InGaN Blue | 468 | 90° | Untinted, Non-diffused | 25 | 60 | 3.7 | 20 |
| HLMP-PM00-N00xx | InGaN Green | 528 | 90° | Untinted, Non-diffused | 25 | 200 | 3.7 | 20 |

PCB Based Subminiature Lamps

| | | | | | | | | |
|-----------------|----------------|-----|-----|------------------------|-----|-----|-----|----|
| ASMT-BA20-AS000 | AllInGaP Amber | 590 | 15° | Untinted, Non-diffused | 180 | 750 | 2.0 | 20 |
| ASMT-BG20-AS000 | AllInGaP Green | 569 | 15° | Untinted, Non-diffused | 180 | 650 | 2.0 | 20 |
| ASMT-BR20-AS000 | AllInGaP Red | 626 | 15° | Untinted, Non-diffused | 180 | 650 | 2.0 | 20 |
| ASMT-BB20-NS000 | InGaN Blue | 468 | 15° | Untinted, Non-diffused | 180 | 650 | 3.2 | 20 |

Note: "xx" at the end of the part number refers to the mechanical option number. Refer to table on the next page.

Subminiature Lamps are also available in the following options:





| Mechanical Option Number | Description |
|--------------------------|---|
| 10 | Right Angle |
| 11 | Tape and Reel, 1500 lamps per reel |
| 12 | Gull Wing, Bulk Packaging |
| 21 | Yoke Lead, Tape and Reel, 1500 lamps per reel |
| 22 | Yoke Lead, Bulk Packaging |
| 31 | Z-Bend, Tape and Reel, 1500 lamps per reel |
| 32 | Z-Bend, Bulk Packaging |

Intensity Bin Limits

| Bin ID | Intensity (mcd) | |
|--------|-----------------|------|
| | Min. | Max. |
| A | 0.10 | 0.20 |
| B | 0.16 | 0.32 |
| C | 0.25 | 0.50 |
| D | 0.40 | 0.80 |
| E | 0.63 | 1.25 |
| F | 1.0 | 2.0 |
| G | 1.6 | 3.2 |
| H | 2.5 | 5.0 |
| J | 4.0 | 8.0 |
| K | 6.3 | 12.5 |
| L | 10 | 20 |
| M | 16 | 32 |
| N | 25 | 50 |
| P | 40 | 80.0 |
| Q | 63 | 125 |
| R | 100 | 200 |
| S | 160 | 320 |
| T | 250 | 500 |
| U | 400 | 800 |
| V | 630 | 1250 |
| W | 1000 | 2000 |
| X | 1600 | 3200 |
| Y | 2500 | 5000 |

Tolerance: ±18%

Color Bin Limits

| Bin ID | Intensity (mcd) | |
|---|-----------------|-------|
| | Min. | Max. |
| Red Orange  | | |
| 1 | 617.5 | 625.0 |
| 2 | 621.0 | 628.5 |
| 3 | 624.5 | 632.0 |
| Orange  | | |
| 1 | 596.5 | 600.0 |
| 2 | 599.0 | 602.5 |
| 3 | 601.5 | 604.0 |
| 4 | 603.8 | 608.2 |
| 5 | 606.8 | 611.2 |
| 6 | 609.8 | 614.2 |
| 7 | 612.8 | 617.2 |
| 8 | 615.8 | 620.2 |
| Yellow  | | |
| 1 | 581.5 | 585.0 |
| 3 | 584.0 | 587.5 |
| 2 | 586.5 | 590.0 |
| 4 | 589.0 | 592.5 |
| 5 | 591.5 | 593.5 |
| 6 | 591.5 | 595.0 |
| 7 | 594.0 | 597.5 |
| Green (except InGaN Green)  | | |
| 4 | 567 | 571 |
| 3 | 570 | 574 |
| 2 | 573 | 577 |
| Emerald Green  | | |
| 9 | 552.0 | 556.0 |
| 8 | 555.0 | 559.0 |
| 7 | 558.0 | 562.0 |
| 6 | 561.0 | 565.0 |

| Bin ID | Intensity (mcd) | |
|---|-------------------|-------|
| | Min. | Max. |
| InGaN Green  | | |
| 0 | Full distribution | |
| 1 | 520.0 | 530.0 |
| 2 | 530.0 | 540.0 |
| 3 | 520.0 | 525.5 |
| 4 | 525.0 | 530.0 |
| 5 | 530.0 | 535.0 |
| 6 | 535.0 | 540.0 |
| InGaN Blue  | | |
| 0 | Full distribution | |
| 1 | 460.0 | 464.0 |
| 2 | 464.0 | 468.0 |
| 3 | 468.0 | 472.0 |
| 4 | 472.0 | 476.0 |
| 5 | 476.0 | 480.0 |
| 6 | 480.0 | 484.0 |

Tolerance = ±1nm

Package Drawings

Surface Mount Subminiature LED Lamps Package Dimensions

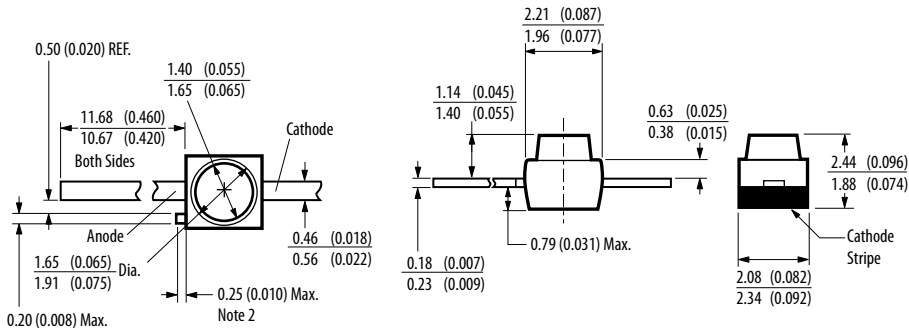

Flat Top Subminiature Lamps

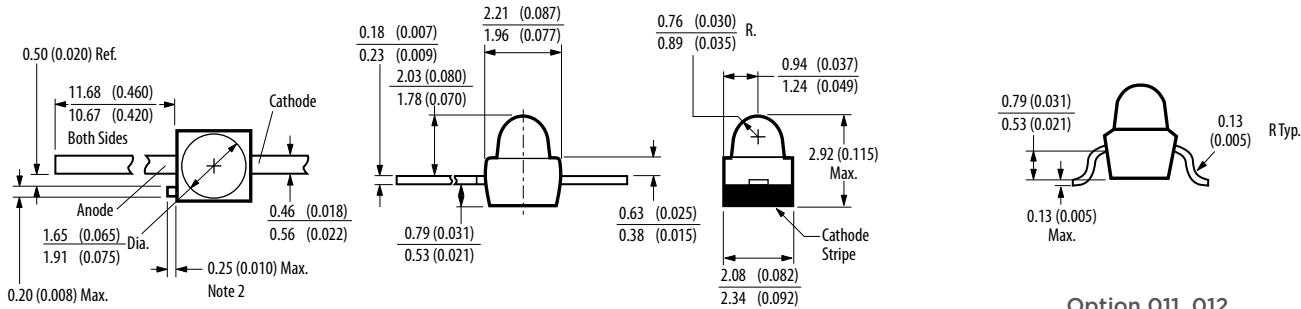

Option 011, 012

- Notes:
 1. All dimensions in millimeters (inches).
 2. Protruding support tab is connected to Cathode Lead.

Domed Subminiature Lamps

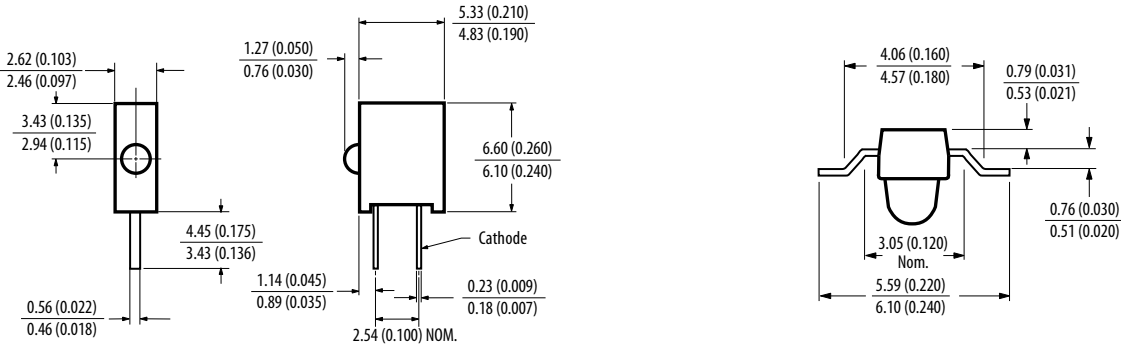

Option 010

Option 031, 032

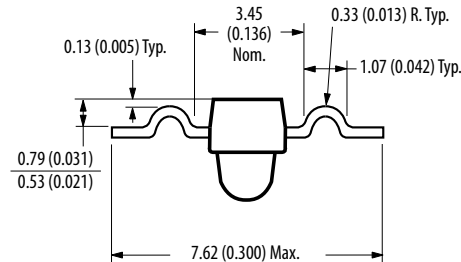

Option 021, 022

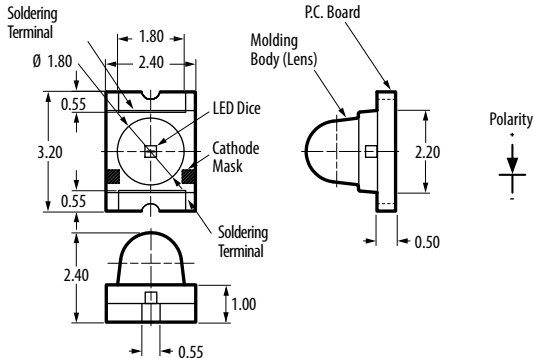

PCB Based Subminiature Lamps

Surface Mount Chip LEDs

Description

For applications that require small size, high efficiency and low power consumption, Broadcom offers an extensive range of high quality ChipLEDs to meet demands for virtually any surface mount lighting requirement.

Broadcom's ChipLEDs are available in standard and high-brightness colors, using Broadcom's proven AlGaAs, AlInGaP and InGaN processes to give you the broadest range of colors from a single supplier.

Broadcom's ChipLEDs use the industry standard footprint, with top-mount, reverse-mount and right-angle-mount packaging options. They also have the lowest profile in the industry and are positioned to support high volume, cost-effective solutions.

ChipLED products are used in a variety of applications including LCD and push button backlighting for cellular phones, white goods and appliances, industrial measurement and control systems, and for symbol lighting and status indication in computer peripherals and consumer goods.

Low power consumption, small size and easy assembly make the ChipLED ideal for backlighting handsets as well as backlighting industrial displays.

Benefits

- Small size
 - Saves PC board space
- Wide viewing angle
 - Well-suited for backlighting applications
- Intensity and color bin uniformity
 - Can be closely mounted without any intensity variations
- Available in multiple colors
 - Amber, Red, AlGaAs Red, Green, Orange, Yellow, InGaN Blue, InGaN Green, bicolor and tricolor combinations
- Variety of packages and mounting options:
 - Top, reverse and right angle auto mountable
- Industry standard footprint
 - No change in existing board layout
- High volume, high reliability
 - Cost-effective solution

Applications

- Telecommunications
 - Keypad and LCD backlighting for mobile phones, pagers and cordless phones
- Industrial
 - Status and symbol indicator
 - Keypad and LCD backlighting
- Consumer
 - White goods and appliances
- Computer Peripherals
 - Status indicator
- Indoor Full/Mono color sign
 - Automotive interior

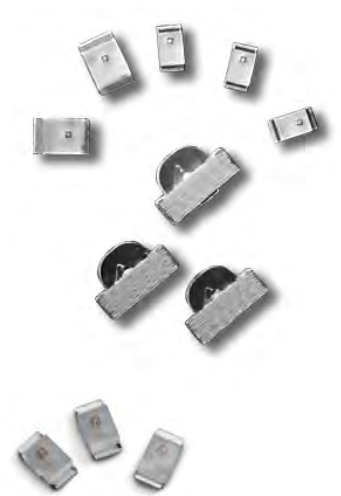

Surface Mount Chip LEDs

| Part Number | Color | Dominant Wavelength (nm) | Viewing Angle | Lens | Intensity | | Vf Typ. (V) | Test Current (mA) |
|--|----------------------|--------------------------|---------------|----------|------------|------------|-------------|-------------------|
| | | | | | Min. (mcd) | Typ. (mcd) | | |
| Top Mount 1206 Industrial Footprint with 1.1 mm Height (C150)* | | | | | | | | |
| 3 3.2 x 1.6 x 1.1 mm (L x W x H).2 x 1.6 x 1.1 mm (L x W x H) | | | | | | | | |
| HSMH-C150 | AS AlGaAs Red | 639 | 170° | Diffused | 7.2 | 17 | 1.8 | 20 |
| HSMD-C150 | GaP Orange | 604 | 170° | Diffused | 2.8 | 8 | 2.2 | 20 |
| HSMG-C150 | GaP Green | 572 | 170° | Diffused | 4.5 | 15 | 2.2 | 20 |
| HSMS-C150 | GaP Red | 626 | 170° | Diffused | 2.8 | 10 | 2.1 | 20 |
| HSMY-C150 | GaP Yellow | 586 | 170° | Diffused | 2.8 | 8 | 2.1 | 20 |
| HSMQ-C150 | InGaN Green | 527 | 140° | Diffused | 45 | 145 | 3.4 | 20 |
| HSMR-C150 | InGaN Blue | 473 | 140° | Diffused | 18 | 55 | 3.4 | 20 |
| HSME-C150 | AS AllnGaP Green | 572 | 170° | Diffused | 18 | 50 | 2.1 | 20 |
| Top Mount 1206 Industrial Footprint with 1.10mm Height (C350) | | | | | | | | |
| 3.2 x 1.6 x 1.1 mm (L x W x H) | | | | | | | | |
| HSMA-C350 | AllnGaP Amber | 589 | 70° | Diffused | 180 | 285 | 2 | 20 |
| HSMC-C350 | AllnGaP Red | 630 | 70° | Diffused | 112.5 | 180 | 2 | 20 |
| HSME-C350 | AllnGaP Yellow Green | 570 | 70° | Diffused | 71.5 | 112.5 | 2 | 20 |
| HSML-C350 | AllnGaP Orange | 603 | 70° | Diffused | 112.5 | 180 | 2 | 20 |
| HSMQ-C350 | InGaN Green | 528 | 70° | Diffused | 450 | 715 | 3.4 | 20 |
| Top Mount 1206 Industrial Footprint with 1.85mm Height (C380) | | | | | | | | |
| 3.2 x 1.6 x 1.85 mm (L x W x H) | | | | | | | | |
| HSMA-C380 | AllnGaP Amber | 589 | 15° | Diffused | 715 | 1125 | 2 | 20 |
| HSMC-C380 | AllnGaP Red | 630 | 15° | Diffused | 450 | 715 | 2 | 20 |
| HSME-C380 | AllnGaP Yellow Green | 570 | 15° | Diffused | 285 | 450 | 2 | 20 |
| HSML-C380 | AllnGaP Orange | 603 | 15° | Diffused | 450 | 715 | 2 | 20 |
| HSMQ-C380 | InGaN Green | 528 | 15° | Diffused | 1800 | 2850 | 3.4 | 20 |
| Top Mount 0805 Industrial Footprint with 0.8 mm Height (C170)** | | | | | | | | |
| 2.0 x 1.25 x 0.8 mm (L x W x H) | | | | | | | | |
| HSMH-C170 | AS AlGaAs Red | 639 | 170° | Diffused | 7.2 | 17 | 1.8 | 20 |
| HSMD-C170 | GaP Orange | 604 | 170° | Diffused | 2.8 | 8 | 2.2 | 20 |
| HSMG-C170 | GaP Green | 572 | 170° | Diffused | 4.5 | 15 | 2.2 | 20 |
| HSMS-C170 | GaP Red | 626 | 170° | Diffused | 2.8 | 10 | 2.1 | 20 |
| HSMY-C170 | GaP Yellow | 586 | 170° | Diffused | 2.8 | 8 | 2.1 | 20 |
| HSMA-C170 | AS AllnGaP Amber | 592 | 170° | Diffused | 28.5 | 90 | 1.9 | 20 |
| HSMC-C170 | AS AllnGaP Red | 626 | 170° | Diffused | 28.5 | 90 | 1.9 | 20 |
| HSML-C170 | AS AllnGaP Orange | 605 | 170° | Diffused | 28.5 | 90 | 1.9 | 20 |
| HSMZ-C170 | AS AllnGaP Red | 631 | 170° | Diffused | 45 | 165 | 2.2 | 20 |
| HSMN-C170 | InGaN Green | 525 | 170° | Diffused | 45 | 120 | 3.3 | 20 |
| HSMN-C170 | InGaN Blue | 470 | 170° | Diffused | 11.2 | 35 | 3.3 | 20 |
| HSMQ-C170 | InGaN Green | 527 | 140° | Diffused | 45 | 145 | 3.4 | 20 |
| HSMR-C170 | InGaN Blue | 473 | 140° | Diffused | 18 | 55 | 3.4 | 20 |
| HSME-C170 | AS AllnGaP Green | 572 | 170° | Diffused | 18 | 50 | 2.1 | 20 |
| HSMA-C170-T0000 | AllnGaP Amber | 592 | 155° | Diffused | 285 | 426 | 2 | 20 |
| HSMC-C170-T0000 | AllnGaP Red | 626 | 140° | Diffused | 285 | 450 | 2 | 20 |
| HSML-C170-T0000 | AllnGaP Orange | 605 | 140° | Diffused | 285 | 450 | 2 | 20 |
| HSMQ-C170-T0000 | InGaN Green | 527 | 140° | Diffused | 285 | 580 | 3.4 | 20 |
| HSMR-C170-R0000 | InGaN Blue | 466 | 155° | Diffused | 146.25 | 170 | 3.4 | 20 |

*Quantity: 3,000 per 7 inch reel



























**Quantity: 4,000 per 7 inch reel

Surface Mount Chip LEDs

| Part Number | Color | Dominant Wavelength (nm) | Viewing Angle | Lens | Intensity | | Vf Typ. (V) | Test Current (mA) |
|--|-------------------|--------------------------|---------------|----------|------------|------------|-------------|-------------------|
| | | | | | Min. (mcd) | Typ. (mcd) | | |
| Top Mount 0603 Industrial Footprint with 0.8 mm Height (C190)** | | | | | | | | |
| 1.6 x 0.8 x 0.8 mm (L x W x H) | | | | | | | | |
| HSMH-C190 | AS AlGaAs Red | 639 | 170° | Diffused | 7.2 | 17 | 1.8 | 20 |
| HSMD-C190 | GaP Orange | 604 | 170° | Diffused | 2.8 | 8 | 2.2 | 20 |
| HSMG-C190 | GaP Green | 572 | 170° | Diffused | 4.5 | 5 | 2.2 | 20 |
| HSMS-C190 | GaP Red | 626 | 170° | Diffused | 2.8 | 10 | 2.1 | 20 |
| HSMY-C190 | GaP Yellow | 586 | 170° | Diffused | 2.8 | 8 | 2.1 | 20 |
| HSMA-C190 | AS AllnGaP Amber | 592 | 170° | Diffused | 28.5 | 90 | 1.9 | 20 |
| HSMC-C190 | AS AllnGaP Red | 626 | 170° | Diffused | 28.5 | 90 | 1.9 | 20 |
| HSML-C190 | AS AllnGaP Orange | 605 | 170° | Diffused | 28.5 | 90 | 1.9 | 20 |
| HSMZ-C190 | AS AllnGaP Red | 631 | 170° | Diffused | 45 | 165 | 2.2 | 20 |
| HSMN-C190 | InGaN Green | 525 | 170° | Diffused | 45 | 120 | 3.3 | 20 |
| HSMQ-C190 | InGaN Blue | 470 | 170° | Diffused | 11.2 | 35 | 3.3 | 20 |
| HSMQ-C190 | InGaN Green | 527 | 140° | Diffused | 45 | 145 | 3.4 | 20 |
| HSMR-C190 | InGaN Blue | 473 | 140° | Diffused | 18 | 55 | 3.4 | 20 |
| HSME-C190 | AS AllnGaP Green | 572 | 170° | Diffused | 18 | 50 | 2.1 | 20 |
| Top Mount 0603 Industrial Footprint with 0.6 mm Height (C191)** | | | | | | | | |
| 1.6 x 0.8 x 0.6 mm (L x W x H) | | | | | | | | |
| HSMH-C191 | AS AlGaAs Red | 639 | 170° | Diffused | 7.2 | 17 | 1.8 | 20 |
| HSMD-C191 | GaP Orange | 604 | 170° | Diffused | 2.8 | 8 | 2.2 | 20 |
| HSMG-C191 | GaP Green | 572 | 170° | Diffused | 4.5 | 5 | 2.2 | 20 |
| HSMS-C191 | GaP Red | 626 | 170° | Diffused | 2.8 | 10 | 2.1 | 20 |
| HSMY-C191 | GaP Yellow | 586 | 170° | Diffused | 2.8 | 8 | 2.1 | 20 |
| HSMA-C191 | AS AllnGaP Amber | 592 | 170° | Diffused | 28.5 | 90 | 1.9 | 20i |
| HSMC-C191 | AS AllnGaP Red | 626 | 170° | Diffused | 28.5 | 90 | 1.9 | 20 |
| HSML-C191 | AS AllnGaP Orange | 605 | 170° | Diffused | 28.5 | 90 | 1.9 | 20 |
| HSMN-C191 | InGaN Blue | 470 | 170° | Diffused | 11.2 | 35 | 3.3 | 20 |
| HSMQ-C191 | InGaN Green | 527 | 140° | Diffused | 45 | 145 | 3.4 | 20 |
| HSMR-C191 | InGaN Blue | 473 | 140° | Diffused | 18 | 55 | 3.4 | 20 |
| HSME-C191 | AS AllnGaP Green | 572 | 170° | Diffused | 18 | 50 | 2.1 | 20 |
| HSMK-C191 | InGaN Cyan | 496 | 170° | Diffused | 71.5 | 285 | 3.4 | 20 |
| HSMA-C191-T0000 | AllnGaP Amber | 592 | 155° | Diffused | 285 | 385 | 2 | 20 |
| HSMC-C191-T0000 | AllnGaP Red | 626 | 125° | Diffused | 285 | 450 | 2 | 20 |
| HSML-C191-T0000 | AllnGaP Orange | 605 | 125° | Diffused | 285 | 450 | 2 | 20 |
| HSMQ-C191-T0000 | InGaN Green | 527 | 140° | Diffused | 285 | 580 | 3.4 | 20 |
| HSMR-C191-S0000 | InGaN Blue | 466 | 145° | Diffused | 180 | 208 | 3.4 | 20 |



























**Quantity: 4,000 per 7 inch reel

Surface Mount Chip LEDs

| Part Number | Color | Dominant Wavelength (nm) | Viewing Angle | Lens | Intensity | | Vf Typ. (V) | Test Current (mA) | |
|--|---|--------------------------|---------------|------|------------|------------|-------------|-------------------|----|
| | | | | | Min. (mcd) | Typ. (mcd) | | | |
| Top Mount 0805 Industrial Footprint with 0.4 mm Height (C177)** | | | | | | | | | |
| 2.00 x 1.25 x 0.4 mm (L x W x H) | | | | | | | | | |
| HSMD-C177 |  | GaP Orange | 604 | 130° | Diffused | 2.8 | 8 | 2.2 | 20 |
| HSMG-C177 |  | GaP Green | 572 | 130° | Diffused | 4.5 | 5 | 2.2 | 20 |
| HSMS-C177 |  | GaP Red | 626 | 130° | Diffused | 2.8 | 10 | 2.1 | 20 |
| HSMA-C177 |  | AS AllnGaP Amber | 592 | 130° | Diffused | 28.5 | 90 | 1.9 | 20 |
| HSMC-C177 |  | AS AllnGaP Red | 626 | 130° | Diffused | 28.5 | 90 | 1.9 | 20 |
| HSML-C177 |  | AS AllnGaP Orange | 605 | 130° | Diffused | 28.5 | 90 | 1.9 | 20 |
| HSME-C177 |  | AS AllnGaP Green | 572 | 130° | Diffused | 18 | 50 | 2.1 | 20 |
| Top Mount 0603 Industrial Footprint with 0.4 mm Height (C197)** | | | | | | | | | |
| 1.6 x 0.8 x 0.4 mm (L x W x H) | | | | | | | | | |
| HSMD-C197 |  | GaP Orange | 604 | 130° | Diffused | 2.8 | 8 | 2.2 | 20 |
| HSMG-C197 |  | GaP Green | 572 | 130° | Diffused | 4.5 | 5 | 2.2 | 20 |
| HSMS-C197 |  | GaP Red | 626 | 130° | Diffused | 2.8 | 10 | 2.1 | 20 |
| HSMY-C197 |  | GaP Yellow | 586 | 130° | Diffused | 2.8 | 8 | 2.1 | 20 |
| HSMA-C197 |  | AS AllnGaP Amber | 592 | 130° | Diffused | 28.5 | 90 | 1.9 | 20 |
| HSMC-C197 |  | AS AllnGaP Red | 626 | 130° | Diffused | 28.5 | 90 | 1.9 | 20 |
| HSML-C197 |  | AS AllnGaP Orange | 605 | 130° | Diffused | 28.5 | 90 | 1.9 | 20 |
| HSME-C197 |  | AS AllnGaP Green | 572 | 130° | Diffused | 18 | 50 | 2.1 | 20 |
| Top Mount 0402 Industrial Footprint with 0.4 mm Height (C280)** | | | | | | | | | |
| 1.0 x 0.5 x 0.4 mm (L x W x H) | | | | | | | | | |
| HSMA-C280 |  | AS AllnGaP Amber | 592 | 130° | Diffused | 28.5 | 90 | 1.9 | 20 |
| HSMC-C280 |  | AS AllnGaP Red | 626 | 130° | Diffused | 28.5 | 90 | 1.9 | 20 |
| HSMG-C280 |  | GaP Green | 572 | 130° | Diffused | 4.5 | 15 | 2.2 | 20 |
| HSMS-C280 |  | GaP Red | 626 | 130° | Diffused | 2.8 | 10 | 2.1 | 20 |
| HSMY-C280 |  | GaP Yellow | 586 | 130° | Diffused | 2.8 | 8 | 2.1 | 20 |
| HSME-C280 |  | AllnGaP green | 572 | 130° | Diffused | 28.5 | 45 | 1.9 | 20 |
| HSMQ-C280 |  | InGaN green | 522 | 130° | Diffused | 112.5 | 222.8 | 3.4 | 20 |
| HSMR-C280 |  | InGaN blue | 465 | 130° | Diffused | 28.5 | 80 | 3.2 | 20 |
| Top Mount 0402 Industrial Footprint with 0.25mmHheight (C290)** | | | | | | | | | |
| 1.0 x 0.5 x 0.25 mm (L x W x H) | | | | | | | | | |
| HSMA-C290 |  | AllnGaP Amber | 589 | 135° | Diffused | 45 | 79 | 2 | 20 |
| HSMC-C290 |  | AllnGaP Red | 624 | 135° | Diffused | 28.5 | 97 | 2 | 20 |
| HSME-C290 |  | AllnGaP Yellow | 572 | 135° | Diffused | 28.5 | 63 | 2 | 20 |
| HSML-C290 |  | AllnGaP Orange | 605 | 135° | Diffused | 71.5 | 89 | 2 | 20 |

**Quantity: 4,000 per 7 inch reel

Surface Mount Chip LEDs

| Part Number | Color | Dominant Wavelength (nm) | Viewing Angle | Lens | Intensity | | Vf Typ. (V) | Test Current (mA) | |
|---|---|--------------------------|---------------|------|--------------|------------|-------------|-------------------|----|
| | | | | | Min. (mcd) | Typ. (mcd) | | | |
| Top Mount 0603 Industrial Footprint with 0.35 mm Height (C130)** | | | | | | | | | |
| 1.6 x 0.8 x 0.35 mm (L x W x H) | | | | | | | | | |
| HSMA-C130 |  | AllInGaP Amber | 592 | 110° | Diffused | 28.5 | 87 | 2 | 20 |
| HSMC-C130 |  | AllInGaP Red | 626 | 110° | Diffused | 28.5 | 131 | 1.9 | 20 |
| HSME-C130 |  | AllInGaP Green | 572 | 110° | Diffused | 18 | 54 | 1.9 | 20 |
| HSML-C130 |  | AllInGaP Orange | 605 | 110° | Diffused | 28.5 | 139 | 1.9 | 20 |
| HSMR-C130 |  | InGaN Blue | 473 | 145° | Diffused | 18 | 55 | 3.4 | 20 |
| HSMQ-C130 |  | InGaN green | 527 | 120 | Diffused | 285 | 350 | 3.4 | 20 |
| Right Angle 1 mm Height (C110)* | | | | | | | | | |
| 3.2 x 1.5 x 1.0 mm (L x W x H) | | | | | | | | | |
| HSMH-C110 |  | AS AlGaAs Red | 639 | 130° | Non-diffused | 7.2 | 17 | 1.8 | 20 |
| HSMC-C110 |  | GaP Orange | 604 | 130° | Non-diffused | 2.8 | 8 | 2.2 | 20 |
| HSMG-C110 |  | GaP Green | 572 | 130° | Non-diffused | 4.5 | 15 | 2.2 | 20 |
| HSMS-C110 |  | GaP Red | 626 | 130° | Non-diffused | 2.8 | 10 | 2.1 | 20 |
| HSMY-C110 |  | GaP Yellow | 586 | 130° | Non-diffused | 2.8 | 8 | 2.1 | 20 |
| HSMA-C110 |  | AS AllInGaP Amber | 592 | 130° | Non-diffused | 28.5 | 95 | 1.9 | 20 |
| HSMC-C110 |  | AS AllInGaP Red | 626 | 130° | Non-diffused | 28.5 | 95 | 1.9 | 20 |
| HSML-C110 |  | AS AllInGaP Orange | 605 | 130° | Non-diffused | 28.5 | 95 | 1.9 | 20 |
| HSMZ-C110 |  | AS AllInGaP Red | 631 | 130° | Non-diffused | 45 | 170 | 2.2 | 20 |
| HSMC-C110 |  | InGaN Green | 525 | 130° | Non-diffused | 45 | 126 | 3.3 | 20 |
| HSMN-C110 |  | InGaN Blue | 470 | 130° | Non-diffused | 11.2 | 39 | 3.3 | 20 |
| HSMQ-C110 |  | InGaN Green | 527 | 130° | Non-diffused | 45 | 150 | 3.4 | 20 |
| HSMR-C110 |  | InGaN Blue | 473 | 130° | Non-diffused | 18 | 60 | 3.4 | 20 |
| HSME-C110 |  | AS AllInGaP Green | 572 | 130° | Non-diffused | 18 | 52 | 2.1 | 20 |
| Right Angle 1.6mm Height (C400)* | | | | | | | | | |
| 3.2 x 2.55 x 1.6 mm (Lx W x H) | | | | | | | | | |
| HSMA-C400 |  | AllInGaP Amber | 588 | 90° | Diffused | 28.5 | 45 | 2 | 20 |
| HSMC-C400 |  | AllInGaP Red | 623 | 90° | Diffused | 28.5 | 45 | 2 | 20 |
| HSME-C400 |  | AllInGaP Yellow Green | 573 | 90° | Diffused | 28.5 | 45 | 2 | 20 |
| HSML-C400 |  | AllInGaP Orange | 606 | 90° | Diffused | 28.5 | 45 | 2 | 20 |
| HSMQ-C400 |  | InGaN Green | 522 | 130° | Diffused | 285 | 450 | 3.4 | 20 |
| Top Mount 0603 Industrial Footprint with 0.2mm height (CB20)* | | | | | | | | | |
| 1.6 x 0.8 x 0.2 mm (L x W x H) | | | | | | | | | |
| ASMT-CB20 |  | InGaN Blue | 473 | 120° | Diffused | 11.2 | 25 | 2.85 | 5 |

*Quantity: 3,000 per 7 inch reel

**Quantity: 4,000 per 7 inch reel

Surface Mount Chip LEDs

| Part Number | Color | Dominant Wavelength (nm) | Viewing Angle | Lens | Intensity | | Vf Typ. (V) | Test Current (mA) |
|---|----------------------|------------------------------------|---------------|--------------|------------|------------|-------------|-------------------|
| | | | | | Min. (mcd) | Typ. (mcd) | | |
| Right Angle 0.6 mm Height (C120)** | | | | | | | | |
| 1.6 x 1.0 x 0.6 mm (L x W x H) | | | | | | | | |
| HSMH-C120 | AS AlGaAs | 639 | 155° | Non-diffused | 7.2 | 17 | 1.8 | 20 |
| HSMD-C120 | GaP Orange | 604 | 155° | Non-diffused | 2.8 | 8 | 2.2 | 20 |
| HSMG-C120 | GaP Green | 572 | 155° | Non-diffused | 4.5 | 15 | 2.2 | 20 |
| HSMA-C120 | AS AllnGaP Amber | 592 | 155° | Non-diffused | 28.5 | 90 | 1.9 | 20 |
| HSMC-C120 | AS AllnGaP Red | 626 | 155° | Non-diffused | 28.5 | 90 | 1.9 | 20 |
| HSML-C120 | AS AllnGaP Orange | 605 | 155° | Non-diffused | 28.5 | 90 | 1.9 | 20 |
| HSMM-C120 | InGaN Green | 525 | 155° | Non-diffused | 45 | 120 | 3.4 | 20 |
| HSMN-C120 | InGaN Blue | 470 | 155° | Non-diffused | 11.2 | 30 | 3.4 | 20 |
| HSMQ-C120 | InGaN Green | 527 | 155° | Non-diffused | 45 | 145 | 3.4 | 20 |
| HSMR-C120 | InGaN Blue | 473 | 155° | Non-diffused | 18 | 55 | 3.4 | 20 |
| HSME-C120 | AS AllnGaP Green | 572 | 155° | Non-diffused | 18 | 52 | 2.1 | 20 |
| Right Angle 0.4 mm Height (Cx00)** | | | | | | | | |
| 1.6 x 1.0 x 0.4 mm (L x W x H) | | | | | | | | |
| ASMT-CA00 | AllnGaP Amber | 592 | 150° | Non-diffused | 28.5 | 90 | 1.9 | 20 |
| ASMT-CR00 | AllnGaP Red | 626 | 150° | Non-diffused | 28.5 | 90 | 1.9 | 20 |
| ASMT-CG00 | InGaN Green | 527 | 150° | Non-diffused | 45 | 225 | 3.1 | 20 |
| ASMT-CB00 | InGaN Blue | 473 | 150° | Non-diffused | 7.2 | 18 | 2.85 | 5 |
| ASMT-CW00 | InGaN White | Chromaticity Coordinates Bin A1-D2 | 170° | Diffused | 18 | 35 | 2.85 | 5 |
| Right Angle 0.3mm Height (C230)** | | | | | | | | |
| 1.0 x 0.55 x 0.3 mm (L x W x H) | | | | | | | | |
| HSMA-C230 | AllnGaP Amber | 589 | 140° | Diffused | 28.5 | 70 | 2 | 20 |
| HSMC-C230 | AllnGaP Red | 622 | 140° | Diffused | 28.5 | 120 | 2 | 20 |
| HSME-C230 | AllnGaP Yellow Green | 572 | 140° | Diffused | 28.5 | 70 | 2 | 20 |
| HSML-C230 | AllnGaP Orange | 605 | 140° | Diffused | 28.5 | 120 | 2 | 20 |
| HSMQ-C230 | InGaN Green | 523 | 140° | Diffused | 112.5 | 210 | 3.4 | 20 |
| HSMR-C230 | InGaN Blue | 468 | 175° | Diffused | 18 | 28.5 | 2.85 | 5 |
| Reverse Mount (C265)* | | | | | | | | |
| 3.4 x 1.25 x 1.1 mm (L x W x H) | | | | | | | | |
| HSMA-C265 | AS AllnGaP Amber | 592 | 150° | Non-diffused | 28.5 | 75 | 1.9 | 20 |
| HSMC-C265 | AS AllnGaP Red | 626 | 150° | Non-diffused | 28.5 | 75 | 1.9 | 20 |
| HSME-C265 | AS AllnGaP Green | 572 | 170° | Non-diffused | 18 | 50 | 2.1 | 20 |
| HSML-C265 | AS AllnGaP Orange | 605 | 150° | Non-diffused | 28.5 | 75 | 1.9 | 20 |
| HSMG-C265 | GaP Green | 572 | 170° | Non-diffused | 4.5 | 15 | 2.2 | 20 |
| HSMH-C265 | AS AlGaAs Red | 639 | 170° | Non-diffused | 7.2 | 17 | 1.8 | 20 |
| HSMQ-C265 | InGaN Green | 527 | 150° | Non-diffused | 45 | 140 | 3.4 | 20 |
| HSMR-C265 | InGaN Blue | 473 | 150 | Non-diffused | 18 | 45 | 3.4 | 20 |

*Quantity: 3,000 per 7 inch reel

**Quantity: 4,000 per 7 inch reel

Surface Mount Chip LEDs

| Part Number | Color | Dominant Wavelength (nm) | Viewing Angle | Lens | Intensity | | Vf Typ. (V) | Test Current (mA) |
|--|----------------------|--------------------------|---------------|----------|------------|------------|-------------|-------------------|
| | | | | | Min. (mcd) | Typ. (mcd) | | |
| Bicolor Top Mount 1210 Industrial Footprint (C15x)* | | | | | | | | |
| 3.2 x 2.7 x 1.1 mm (L x W x H) | | | | | | | | |
| HSMF-C153 | GaP Yellow | 586 | 170° | Diffused | 2.8 | 8 | 2.1 | 20 |
| | GaP Red | 626 | 170° | Diffused | 2.8 | 10 | 2.1 | 20 |
| HSMF-C155 | GaP Green | 572 | 170° | Diffused | 4.5 | 15 | 2.2 | 20 |
| | GaP Red | 626 | 170° | Diffused | 2.8 | 10 | 2.1 | 20 |
| HSMF-C156 | GaP Green | 572 | 170° | Diffused | 4.5 | 15 | 2.2 | 20 |
| | GaP Yellow | 586 | 170° | Diffused | 2.8 | 8 | 2.1 | 20 |
| HSMF-C157 | GaP Green | 572 | 170° | Diffused | 4.5 | 15 | 2.2 | 20 |
| | GaP Orange | 604 | 170° | Diffused | 2.8 | 8 | 2.2 | 20 |
| HSMF-C158 | AllnGaP Green | 572 | 170° | Diffused | 28.5 | 45 | 2.1 | 20 |
| | AllnGaP Amber | 592 | 170° | Diffused | 28.5 | 55 | 1.9 | 20 |
| HSMF-C150 | AllnGaP Red | 632 | 170° | Diffused | 18 | 79 | 1.9 | 20 |
| | AllnGaP Green | 572 | 170° | Diffused | 18 | 45 | 2.1 | 20 |
| HSMF-C15A | AllnGaP Red | 632 | 170° | Diffused | 18 | 79 | 1.9 | 20 |
| | AllnGaP Amber | 592 | 170° | Diffused | 28.5 | 55 | 1.9 | 20 |
| Bicolor Top Mount 0605 Industrial Footprint (C17x)* | | | | | | | | |
| 1.6 x 1.25 x 0.4 mm (L x W x H) | | | | | | | | |
| HSMF-C171 | AllnGaP Orange | 605 | 140° | Diffused | 28.5 | 45 | 2 | 10 |
| | InGaN Blue | 467 | 150° | Diffused | 18 | 28.5 | 3.4 | 10 |
| HSMF-C172 | AllnGaP Orange | 605 | 140° | Diffused | 28.5 | 45 | 2 | 20 |
| | AllnGaP Yellow Green | 570 | 140° | Diffused | 28.5 | 45 | 2 | 20 |
| HSMF-C173 | AllnGaP Red | 624 | 140° | Diffused | 28.5 | 45 | 2 | 20 |
| | InGaN Green | 525 | 150° | Diffused | 71.5 | 112.5 | 3.4 | 20 |
| HSMF-C174 | AllnGaP Red | 624 | 140° | Diffused | 28.5 | 45 | 2 | 20 |
| | AllnGaP Yellow Green | 570 | 140° | Diffused | 28.5 | 45 | 2 | 20 |
| HSMF-C175 | AllnGaP Amber | 589 | 140° | Diffused | 28.5 | 45 | 2 | 20 |
| | AllnGaP Yellow Green | 570 | 140° | Diffused | 28.5 | 45 | 2 | 20 |
| HSMF-C176 | InGaN Blue | 467 | 150° | Diffused | 18 | 28.5 | 3.4 | 10 |
| | InGaN Green | 525 | 150° | Diffused | 71.5 | 112.5 | 3.4 | 10 |
| HSMF-C177 | AllnGaP Orange | 605 | 140° | Diffused | 28.5 | 45 | 2 | 10 |
| | InGaN Green | 525 | 150° | Diffused | 180 | 285 | 3.4 | 10 |

*Quantity: 3,000 per 7 inch reel

Surface Mount Chip LEDs

| Part Number | Color | Dominant Wavelength (nm) | Viewing Angle | Lens | Intensity | | Vf Typ. (V) | Test Current (mA) |
|---|----------------|--------------------------|---------------|----------|------------|------------|-------------|-------------------|
| | | | | | Min. (mcd) | Typ. (mcd) | | |
| Bicolor Top Mount 0603 Industrial Footprint (C16x)* | | | | | | | | |
| 1.6 x 0.8 x 0.5 mm (L x W x H) | | | | | | | | |
| HSMF-C162 | AllInGaP Amber | 592 | 120° | Diffused | 28.5 | 90 | 1.9 | 20 |
| | AllInGaP Red | 626 | 120° | Diffused | 28.5 | 90 | 1.9 | 20 |
| HSMF-C163 | InGaN Green | 525 | 120° | Diffused | 18 | 45 | 3.4 | 10 |
| | AllInGaP Red | 626 | 120° | Diffused | 11.2 | 35 | 1.8 | 10 |
| HSMF-C164 | InGaN Blue | 470 | 120° | Diffused | 2.8 | 10 | 3.4 | 10 |
| | AllInGaP Red | 626 | 120° | Diffused | 11.2 | 35 | 1.8 | 10 |
| HSMF-C165 | GaP Green | 572 | 120° | Diffused | 4.5 | 15 | 2.2 | 20 |
| | GaP Red | 626 | 120° | Diffused | 2.8 | 10 | 2.1 | 20 |
| HSMF-C166 | GaP Green | 572 | 120° | Diffused | 4.5 | 15 | 2.2 | 20 |
| | GaP Yellow | 586 | 120° | Diffused | 2.8 | 8 | 2.1 | 20 |
| HSMF-C167 | GaP Green | 572 | 120° | Diffused | 4.5 | 15 | 2.2 | 20 |
| | GaP Orange | 604 | 120° | Diffused | 2.8 | 8 | 2.2 | 20 |
| HSMF-C169 | InGaN Blue | 470 | 120° | Diffused | 2.8 | 10 | 3.4 | 10 |
| | AllInGaP Amber | 592 | 120° | Diffused | 11.2 | 35 | 1.8 | 10 |
| HSMF-C16M | AllInGaP Red | 632 | 120° | Diffused | 45 | 104.4 | 1.9 | 20 |
| | AllInGaP Green | 570 | 120° | Diffused | 45 | 55.4 | 2.1 | 20 |
| Tricolor Top Mount 1210 Industrial Footprint (C118)* | | | | | | | | |
| 3.2 x 2.7 x 1.1 mm (L x W x H) | | | | | | | | |
| HSMF-C118 | AllInGaP Red | 623 | 140° | Diffused | 18 | 28.5 | 2 | 10 |
| | InGaN Green | 529 | 140° | Diffused | 71.5 | 112.5 | 3.4 | 10 |
| | InGaN Blue | 468 | 140° | Diffused | 18 | 28.5 | 3.4 | 10 |
| Tricolor Top Mount 0805 Industrial Footprint (C129)* | | | | | | | | |
| 2.0 x 1.3 x 0.5 mm (L x W x H) | | | | | | | | |
| HSMF-C129 | AllInGaP Red | 623 | 140° | Diffused | 18 | 28.5 | 2 | 10 |
| | InGaN Green | 529 | 140° | Diffused | 71.5 | 112.5 | 3.4 | 10 |
| | InGaN Blue | 468 | 140° | Diffused | 18 | 28.5 | 3.4 | 10 |
| Tricolor Right Angle with 1.0 mm Height (C11x)* | | | | | | | | |
| 2.5 x 1.0 x 1.0 mm (L x W x H) | | | | | | | | |
| HSMF-C113 | AllInGaP Red | 626 | 120° | Diffused | 28.5 | 80 | 1.9 | 20 |
| | AllInGaP Green | 572 | 125° | Diffused | 18 | 50 | 2 | 20 |
| | InGaN Blue | 470 | 125° | Diffused | 28.5 | 60 | 3.4 | 20 |
| HSMF-C115 | AllInGaP Red | 626 | 120° | Diffused | 28.5 | 80 | 1.9 | 20 |
| | InGaN Green | 525 | 125° | Diffused | 71.5 | 170 | 3.4 | 20 |
| | InGaN Blue | 470 | 125° | Diffused | 28.5 | 60 | 3.4 | 20 |

*Quantity: 3,000 per 7 inch reel

Surface Mount Chip LEDs

| Part Number | Color | Dominant Wavelength (nm) | Viewing Angle | Lens | Intensity | | Vf Typ. (V) | Test Current (mA) |
|--|-----------------------|--------------------------|---------------|--------------|------------|------------|-------------|-------------------|
| | | | | | Min. (mcd) | Typ. (mcd) | | |
| Tricolor Top Mount with 0.35mm Height (C114)** | | | | | | | | |
| 1.6 x 0.8 x 0.45 mm (L x W x H) | | | | | | | | |
| HSMF-C114 | AllInGaP Red | 626 | 140° | Diffused | 28.5 | 85 | 1.9 | 20 |
| | InGaN Green | 525 | 145° | Diffused | 45 | 180 | 3.4 | 20 |
| | InGaN Blue | 470 | 145° | Diffused | 28.5 | 70 | 3.4 | 20 |
| Tricolor Top Mount 0606 Industrial Footprint (C125) | | | | | | | | |
| 1.6 x 1.6 x 0.4 mm (L x W x H) | | | | | | | | |
| HSMF-C125 | AllInGaP Red | 623 | 150° | Diffused | 45 | 71.5 | 1.9 | 10 |
| | InGaN Green | 522 | 150° | Diffused | 112.5 | 180 | 2.93 | 10 |
| | InGaN Blue | 467 | 150° | Diffused | 28.5 | 45 | 2.95 | 10 |
| Bicolor Right Angle 0.1 mm height (C14x) | | | | | | | | |
| 3.0 x 2.0 x 1.0 (L x W x H) | | | | | | | | |
| HSMF-C142 | AllInGaP Deep Red | 632 | 120° | Non diffused | 18 | 79 | 1.9 | 20 |
| | AllInGaP Green | 570 | 120° | Non diffused | 18 | 33 | 2.1 | 20 |
| HSMF-C143 | AllInGaP Amber | 589 | 120° | Non diffused | 28.5 | 103 | 1.9 | 20 |
| | AllInGaP Green | 570 | 120° | Non diffused | 18 | 33 | 2.1 | 20 |
| HSMF-C144 | AllInGaP Red | 632 | 120° | Non diffused | 18 | 79 | 1.9 | 20 |
| | AllInGaP Green | 570 | 120° | Non diffused | 18 | 33 | 2.1 | 20 |
| HSMF-C145 | AllInGaP Red | 632 | 120° | Non diffused | 18 | 79 | 1.9 | 20 |
| | AllInGaP Green | 523 | 120° | Non diffused | 45 | 223 | 3.4 | 20 |
| HSMF-C146 | AllInGaP Red | 632 | 120° | Non diffused | 18 | 79 | 1.9 | 20 |
| | InGaN Blue | 459 | 120° | Non diffused | 28.5 | 75 | 3.2 | 20 |
| Leadframe-based (ASMT-Rx45) | | | | | | | | |
| 1.6 x 0.8 x 0.45 mm (L x W x H) | | | | | | | | |
| ASMT-RR45 | AllInGaP Red | 622 | 145° | Diffused | 50 | 120 | 2 | 20 |
| ASMT-RF45 | AllInGaP Yellow Green | 573 | 145° | Diffused | 30 | 60 | 2 | 20 |
| ASMT-RA45 | AllInGaP Amber | 591 | 145° | Diffused | 40 | 90 | 2 | 20 |

**Quantity: 4,000 per 7 inch reel

Color Bin Limits

| Package | Color Bin | Wavelength (nm) | |
|----------------|-------------------|-----------------|-------|
| | | Min. | Max. |
| GaN/InGaN Blue | A | 460.0 | 465.0 |
| | B | 465.0 | 470.0 |
| | C | 470.0 | 475.0 |
| | D | 475.0 | 480.0 |
| InGaN Green | A | 515.0 | 520.0 |
| | B | 520.0 | 525.0 |
| | C | 525.0 | 530.0 |
| | D | 530.0 | 535.0 |
| Orange | A | 597.0 | 600.0 |
| | B | 600.0 | 603.0 |
| | C | 603.0 | 606.0 |
| | D | 606.0 | 609.0 |
| | E | 609.0 | 612.0 |
| | F | 612.0 | 615.0 |
| Red | Full Distribution | | |
| AlGaAs Red | Full Distribution | | |

Tolerance: ± 1.0 nm

| Package | Color Bin | Wavelength (nm) | |
|---------|-----------|-----------------|-------|
| | | Min. | Max. |
| Green | A | 561.5 | 564.5 |
| | B | 564.5 | 567.5 |
| | C | 567.5 | 570.5 |
| | D | 570.5 | 573.5 |
| | E | 573.5 | 576.5 |
| Yellow | A | 582.0 | 584.5 |
| | B | 584.5 | 587.0 |
| | C | 587.0 | 589.5 |
| | D | 589.5 | 592.0 |
| | E | 592.0 | 594.5 |
| | F | 594.5 | 597.0 |
| Amber | A | 582.0 | 584.5 |
| | B | 584.5 | 587.0 |
| | C | 587.0 | 589.5 |
| | D | 589.5 | 592.0 |
| | E | 592.0 | 594.5 |
| | F | 594.5 | 597.0 |

Tolerance: ± 1.0 nm

Surface Mount ChipLEDs

Standard Intensity Bin Limits

| Bin ID | Intensity (mcd) | |
|--------|-----------------|---------|
| | Min. | Max. |
| A | 0.11 | 0.18 |
| B | 0.18 | 0.29 |
| C | 0.29 | 0.45 |
| D | 0.45 | 0.72 |
| E | 0.72 | 1.10 |
| F | 1.10 | 1.80 |
| G | 1.80 | 2.80 |
| H | 2.80 | 4.50 |
| J | 4.50 | 7.20 |
| K | 7.20 | 11.20 |
| L | 11.20 | 18.00 |
| M | 18.00 | 28.50 |
| N | 28.50 | 45.00 |
| P | 45.00 | 71.50 |
| Q | 71.50 | 112.50 |
| R | 112.50 | 180.00 |
| S | 180.00 | 285.00 |
| T | 285.00 | 450.00 |
| U | 450.00 | 715.00 |
| V | 715.00 | 1125.00 |
| W | 1125.00 | 1800.00 |
| X | 1800.00 | 2850.00 |
| Y | 2850.00 | 4500.00 |

Tolerance: $\pm 15\%$

Package Drawings

HSMx-C177

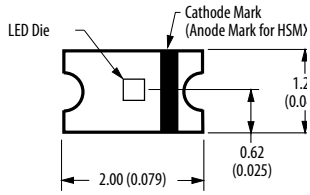

HSMx-C120/ASMT-Cx00

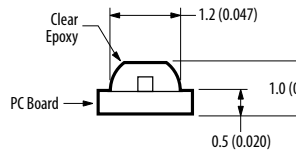

HSMx-C150

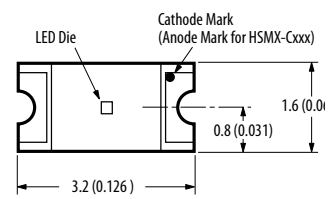

HSMx-C190/C191/C130

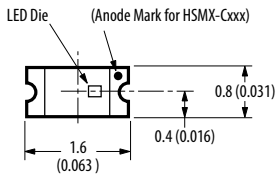

HSMx-C265

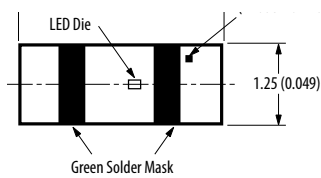

HSMx-C280

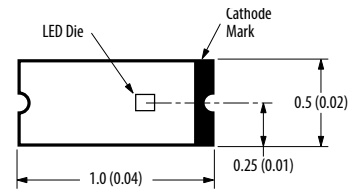

HSMx-C170

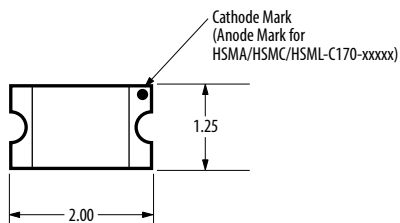

HSMx-C191

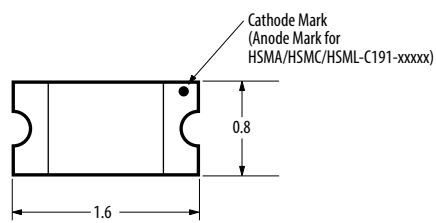

HSMx-C290

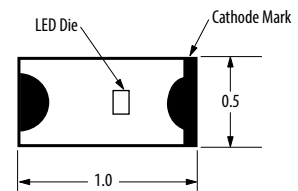

- Notes:**
1. All dimensions in millimeters (inches).
 2. Tolerance is $\pm 0.1\text{mm}$ (± 0.004 in.) unless otherwise specified.

HSMF-C15x

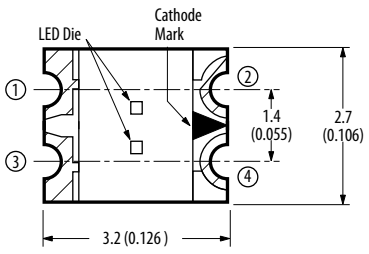

HSMF-C16x

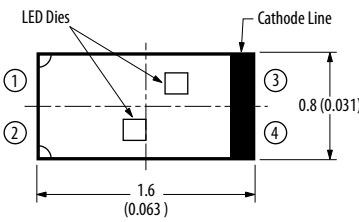

HSMF-C118

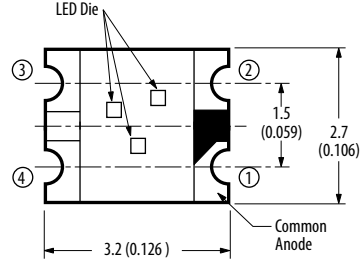

HSMF-C114

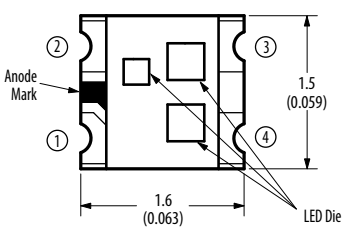

HSMF-C113/C115

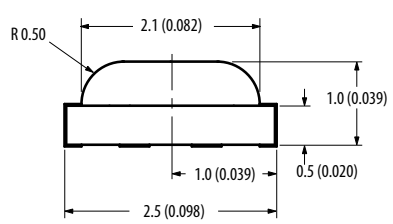

HSMx-C110

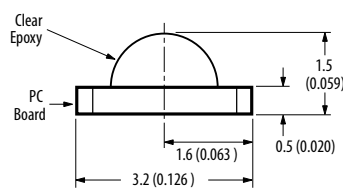

HSMx-C350

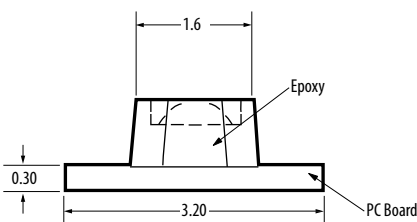

HSMx-C380

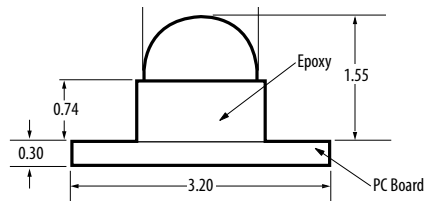

HSMx-C400

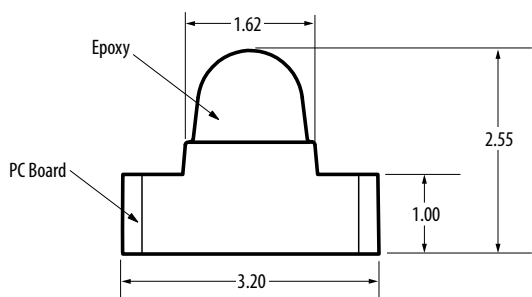

Notes:
 1. All dimensions in millimeters (inches).
 2. Tolerance is $\pm 0.1\text{mm}$ (± 0.004 in.) unless otherwise specified.

Package Drawings

HSMx-C230

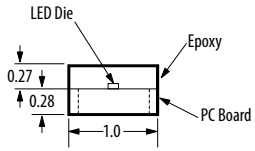

HSMF-C17x

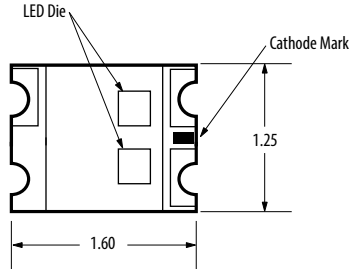

HSMF-C129

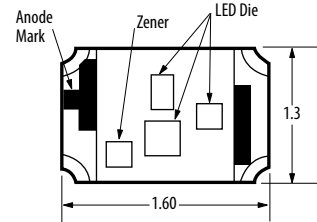

ASMT-RX45

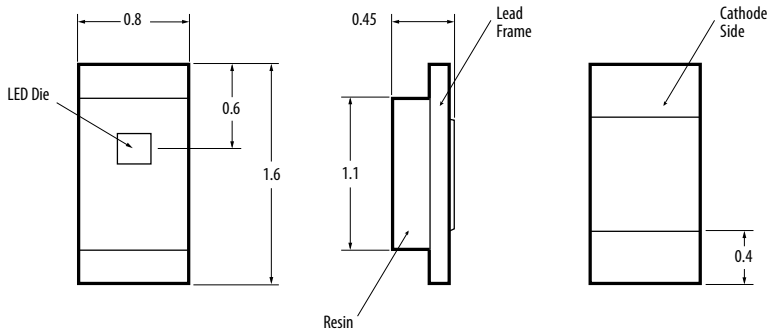

HSMF-C125

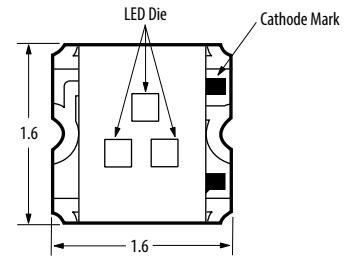

HSMx-C197

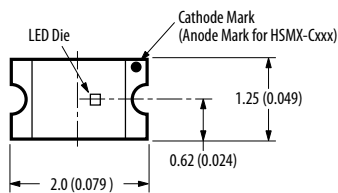

HSMx-C170

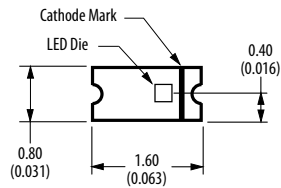

Notes:
1. All dimensions in millimeters (inches).
2. Tolerance is $\pm 0.1\text{mm}$ (± 0.004 in.) unless otherwise specified.

Auto Focus Auxiliary Flash LED

Description

Broadcom offers Auto Focus Auxiliary Flash LEDs in the standard, low profile and miniature package. These are surface mount dome lamps that use an untinted, non-diffused lens to provide a high luminous intensity within a narrow radiation pattern.

These narrow angle SMT lamp packages are designed for applications which require long distance illumination and narrow beam pattern such as auxiliary flash for auto-focus function in digital still cameras. The miniature and low profile package are also suitable for applications that have constraints in design area. These devices are compatible with Pb-free reflow soldering process.

The standard Auto Focus Auxiliary Flash LEDs are available in 530nm Green and 605nm Orange. The miniature package is available in 605nm Orange.

Benefits

- Smooth, consistent narrow radiation pattern
- Viewing angle optimized for auto focus function
- 3m illumination distance
- Miniature package: 18° view angle
- Standard package: Small footprint with 4.8L x 4.8W x 5.33H mm
- Low profile package: 12° viewing angle for Orange; 14° viewing angle for Green low profile package: 3.6L x 3.2W x 3.4H mm package dimension
- Good intensity output
- Compatible with 2x solder reflow
- Clear, non-diffused epoxy
- Allows easy assembly and PCB space saving.
- Compatible with reflow soldering
- IEC/EN 60825-1 eye safety class 1
- RoHS compliant

Application

- Digital still camera



Standard Auto Focus Auxiliary Flash LED

| Part Number | Color | Dominant Wavelength (nm) | Viewing Angle | Lens | Intensity | | | Vf Typ. (V) | Test Current (mA) | Device Height |
|-----------------|----------------|--------------------------|---------------|-------|-----------|-----------|--------------------------|-------------|-------------------|---------------|
| | | | | | Min. (cd) | Typ. (cd) | Max. I _v (cd) | | | |
| ASMT-FJ60-AFJ00 | AllnGaP Orange | 605 | 10° | Clear | - | 29 | - | 2.1 | 20 | 4.35mm |
| ASMT-FJ10-AHJ00 | AllnGaP Orange | 605 | 8° | Clear | 9 | 22 | - | 2 | 20 | 5.33mm |
| ASMT-FG10-NFJ00 | InGaN Green | 530 | 6° | Clear | 18 | 40 | 56 | 3.3 | 20 | 5.33mm |
| ASMT-FJ70-AFJ00 | AllnGaP Orange | 605 | 12° | Clear | 15 | 25 | 56 | 2.1 | 20 | 3.40mm |
| ASMT-FG70-NFJ00 | InGaN Green | 525 | 14° | Clear | 15 | 22 | 56 | 3.3 | 20 | 3.40mm |

Miniature Auto Focus Auxiliary Flash LED

| Part Number | Color | Dominant Wavelength (nm) | Viewing Angle | Lens | Intensity | | | Vf Typ. (V) | Test Current (mA) |
|-----------------|----------------|--------------------------|---------------|-------|-----------|-----------|--------------------------|-------------|-------------------|
| | | | | | Min. (cd) | Typ. (cd) | Max. I _v (cd) | | |
| ASMT-FJ30-AB000 | AllnGaP Orange | 605 | 12° | Clear | 5.5 | - | - | 2 | 20 |

Side Firing Auto Focus Auxiliary Flash LED

| Part Number | Color | Dominant Wavelength (nm) | Viewing Angle | Lens | Intensity | | | Vf Typ. (V) | Test Current (mA) |
|-----------------|----------------|--------------------------|---------------|-------|-----------|-----------|--------------------------|-------------|-------------------|
| | | | | | Min. (cd) | Typ. (cd) | Max. I _v (cd) | | |
| ASMT-FJ80-AFJ00 | AllnGaP Orange | 605 | 10° | Clear | 15 | 25 | - | 2 | 20 |

Iv Bin Category

| Bin ID | Intensity (cd) | |
|--------|----------------|------|
| | Min. | Max. |
| B | 5.5 | 7.0 |
| C | 7.0 | 9.0 |
| D | 9.0 | 11.5 |
| E | 11.5 | 15.0 |
| F | 15.0 | 19.5 |
| F+ ** | 18.0 | 19.5 |
| G | 19.5 | 25.5 |
| H | 25.5 | 33.0 |
| I | 33.0 | 43.0 |
| J | 43.0 | 56.0 |

Iv Tolerance = ±15%

** For ASMT-FG10-NFJ00 only

Color Bin Category

| Bin ID | Wavelength (nm) | |
|--------------------------|-----------------|------|
| | Min. | Max. |
| Orange (ASMT-FJ10-xxxxx) | | |
| A | 600 | 604 |
| B | 604 | 608 |
| C | 608 | 612 |
| Orange (ASMT-FJ30-xxxxx) | | |
| 1 | 597 | 600 |
| 2 | 600 | 603 |
| 3 | 603 | 606 |
| 4v | 606 | 609 |
| 5 | 609 | 612 |
| Green | | |
| A | 515 | 520 |
| B | 520 | 525 |
| C | 525 | 530 |
| D | 530 | 535 |

Tolerance = ±1nm

Package Drawings

Standard Auto Focus Auxiliary Flash LED with 4.35mm Height

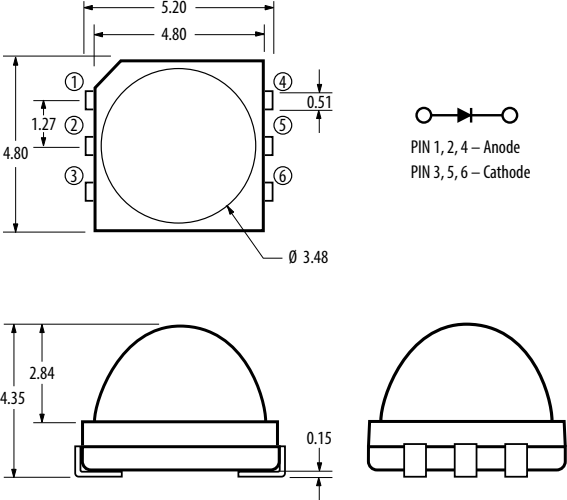

Miniature Auto Focus Auxiliary Flash LED

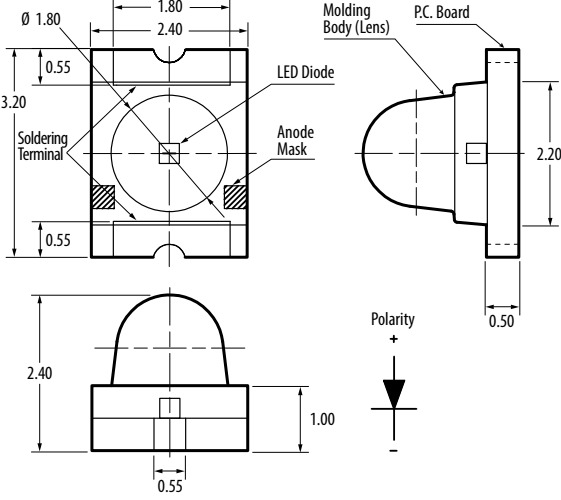

Standard Auto Focus Auxiliary Flash LED with 5.33 Height

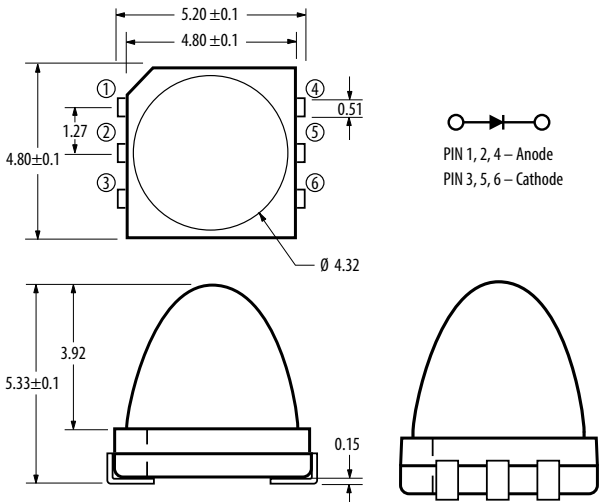

Standard Auto Focus Flash LED with 3.40mm Height

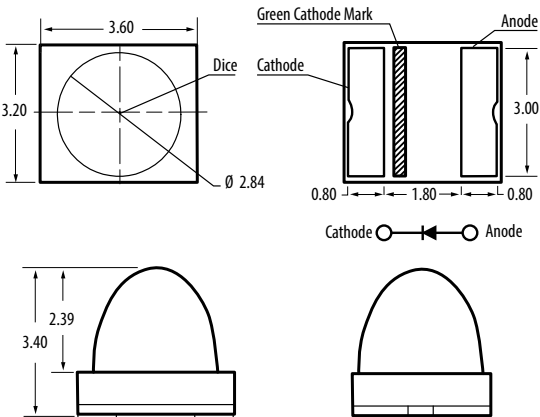

Side Firing Auto Focus Auxiliary Flash LED

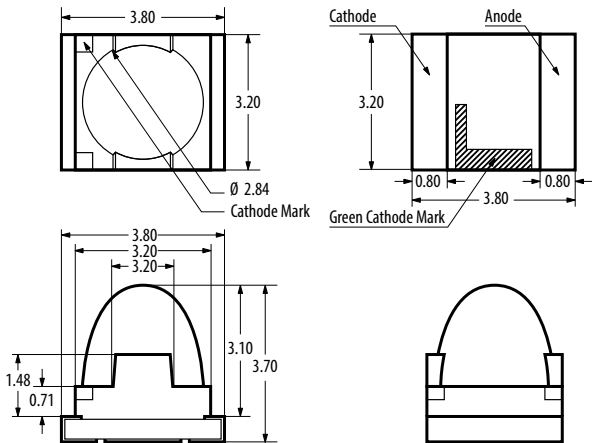

Notes:
 1. All dimensions in millimeters.
 2. Tolerance is ±0.1mm unless otherwise specified.

Seven-Segment Displays

Description

Broadcom offers a full range of seven-segment displays from low cost, standard brightness displays to high ambient light displays that produce up to 78 mcd per segment. Dual and single digit displays are available in assorted character heights and colors. They are divided into two platforms to address different market requirements in both industrial and consumer markets. Displays for industrial markets are designed for high-reliability applications and feature extremely durable packaging for high temperature environments. Consumer applications are designed for cost-sensitive, general-purpose display applications.

Benefits

- Semiconductor (LED) light source
 - Cost-effective solutions
 - Flexibility for designers
 - Light weight
- Lower power consumption
 - Electrical power savings
 - Low heat generation
 - Low current devices available
- Mechanically rugged
 - No wire filaments
 - No moving parts
 - Not sensitive to mechanical shock and vibration
- Essentially monochromatic light
 - No color filter required
 - Maximum use of visible light
 - Easy for the eye to discern against distracting backgrounds in sunlight and adverse weather conditions
 - High light output
 - Industry standard size and pinout
 - Categorized for luminous intensity (yellow and green categorized for color)

Industrial Applications: High Performance Seven-segment Display Package

Industrial grade products provide high peak current, automated IV/ color binning and the availability of intensity and color selection. Ideal for high reliability applications such as temperature controllers, this package is extremely durable in high temperature environments with better heat dissipation through a mild steel leadframe.

Key benefits for the leadframe platform

- Heat dissipation from the package is faster than other PCB display products
- Brightness (Iv) degradation reduced over time
- Lead stability and consistency
- Solder coated leads result in better solderability

Consumer Applications: Standard Seven-segment Display Package

Designed for the cost-competitive general purpose commercial LED display applications, this package is built with a PCB substrate using ultrasonic stitch-to-stitch bonding with aluminum wire.

Key benefits for the PCB platform

- Competitive prices
- Broadcom quality, reliability and technical support

Broadcom is committed to support the market by offering display performance and features that are specific to the designer's application requirements.

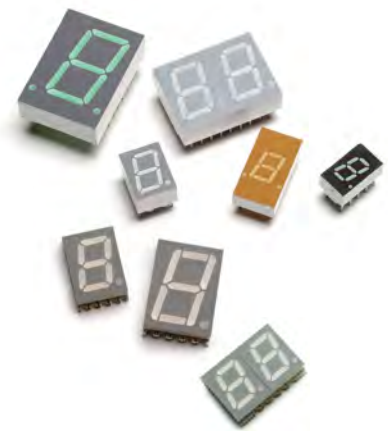

Typical Industrial Applications

High performance seven-segment Displays:

- Temperature controllers
- Test and measurement instrumentation
- Power converters
- Home appliance displays
- Automotive and avionic instrumentation
- Fuel pump displays
- Digital panel meters

Typical Consumer Applications



Standard seven-segment displays:



- Cable set-top boxes
- Electronics displays
- Gaming machines
- Point of sale terminals
- Answering machines
- Exercise equipment



Through-hole Seven-Segment Displays—Leadframe Platform

| Part Number | Face Color | Pin Configuration | Intensity (μcd) | | Iv Test Current (mA) | Vf Typ. (V) | Vf Test Current (mA) |
|--|------------|-------------------|------------------------------|------|----------------------|-------------|----------------------|
| | | | Min. | Typ. | | | |
| 7.6 mm (0.3") Micro Bright Displays (right decimal point) | | | | | | | |
| GaP Red 626 nm | | | | | | | |
| HDSP-7501 | Grey | Common Anode | 360 | 980 | 5 | 2 | 20 |
| HDSP-A211 | Black | Common Anode | 360 | 980 | 5 | 2 | 20 |
| HDSP-7503 | Grey | Common Cathode | 360 | 980 | 5 | 2 | 20 |
| HDSP-A213 | Black | Common Cathode | 360 | 980 | 5 | 2 | 20 |
| GaP Orange 600 nm | | | | | | | |
| HDSP-A401 | Grey | Common Anode | 354 | 720 | 5 | 2 | 20 |
| HDSP-A403 | Grey | Common Cathode | 354 | 720 | 5 | 2 | 20 |
| GaP Yellow 586 nm | | | | | | | |
| HDSP-7401 | Grey | Common Anode | 225 | 480 | 5 | 2.2 | 20 |
| HDSP-7403 | Grey | Common Cathode | 225 | 480 | 5 | 2.2 | 20 |
| High Performance GaP Green 571 nm | | | | | | | |
| HDSP-7801 | Grey | Common Anode | 860 | 3000 | 10 | 2.1 | 10 |
| HDSP-A511 | Black | Common Anode | 860 | 3000 | 10 | 2.1 | 10 |
| HDSP-7803 | Grey | Common Cathode | 860 | 3000 | 10 | 2.1 | 10 |
| HDSP-A513 | Black | Common Cathode | 860 | 3000 | 10 | 2.1 | 10 |
| AlGaAs Red 637 nm | | | | | | | |
| HDSP-A151 | Grey | Common Anode | 690 | 1400 | 20 | 1.8 | 20 |
| HDSP-A153 | Grey | Common Cathode | 690 | 1400 | 20 | 1.8 | 20 |
| 7.6 mm (0.3") Micro Bright Low Current Displays (right decimal point) | | | | | | | |
| AlGaAs Red 637 nm | | | | | | | |
| HDSP-A101 | Grey | Common Anode | 315 | 600 | 1 | 1.6 | 1 |
| HDSP-A103 | Grey | Common Cathode | 315 | 600 | 1 | 1.6 | 1 |
| HDSP-A113 | Black | Common Cathode | 315 | 600 | 1 | 1.6 | 1 |
| GaP Red 626 nm | | | | | | | |
| HDSP-7511 | Grey | Common Anode | 160 | 270 | 2 | 1.6 | 2 |
| HDSP-7513 | Grey | Common Cathode | 160 | 270 | 2 | 1.6 | 2 |
| GaP Yellow 585 nm | | | | | | | |
| HDSP-A801 | Grey | Common Anode | 250 | 420 | 4 | 1.7 | 4 |
| HDSP-A803 | Grey | Common Cathode | 250 | 420 | 4 | 1.7 | 4 |
| GaP Green 571 nm | | | | | | | |
| HDSP-A901 | Grey | Common Anode | 250 | 475 | 4 | 1.9 | 4 |
| HDSP-A903 | Grey | Common Cathode | 250 | 475 | 4 | 1.9 | 4 |





Through-hole Seven-Segment Displays—Leadframe Platform

| Part Number | Face Color | Pin Configuration | Intensity (μcd) | | Iv Test Current (mA) | Vf Typ. (V) | Vf Test Current (mA) |
|---|------------|-------------------|------------------------------|------|----------------------|-------------|----------------------|
| | | | Min. | Typ. | | | |
| 7.6 mm (0.3") Micro Bright Overflow Displays (right decimal point) | | | | | | | |
| GaP Red 626 nm  | | | | | | | |
| HDSP-7507 | Grey | Common Anode | 360 | 980 | 5 | 2 | 20 |
| HDSP-7508 | Grey | Common Cathode | 360 | 980 | 5 | 2 | 20 |
| HDSP-7517 | Grey | Common Anode | 160 | 270 | 2 | 1.6 | 2 |
| GaP Green 571 nm  | | | | | | | |
| HDSP-7807 | Grey | Common Anode | 860 | 3000 | 10 | 2.1 | 10 |
| HDSP-7808 | Grey | Common Cathode | 860 | 3000 | 10 | 2.1 | 10 |

| Part Number | Face Color | Pin Configuration | Intensity (μcd) | | Iv Test Current (mA) | Vf Typ. (V) | Vf Test Current (mA) |
|---|------------|-------------------|------------------------------|------|----------------------|-------------|----------------------|
| | | | Min. | Typ. | | | |
| AlGaAs Red 637 nm (right hand decimal)  | | | | | | | |
| HDSP-A107 | Grey | Common Anode | 135 | 600 | 1 | 1.6 | 1 |
| HDSP-A108 | Grey | Common Cathode | 135 | 600 | 1 | 1.6 | 1 |
| GaP Green 571 nm  | | | | | | | |
| HDSP-A907 | Grey | Common Anode | 250 | 475 | 5 | 1.9 | 4 |
| HDSP-A908 | Grey | Common Cathode | 250 | 475 | 5 | 1.9 | 4 |

| Part Number | Face Color | Pin Configuration | Intensity | | Iv Test Current (mA) | Vf Typ. (V) | Vf Test Current (mA) | Decimal Point |
|--|------------|-------------------|-----------|------|----------------------|-------------|----------------------|---------------|
| | | | Min. | Typ. | | | | |
| 7.6 mm (0.3") Single Digit Displays | | | | | | | | |
| GaP Red 626 nm  | | | | | | | | |
| 5082-7610 | Red | Common Anode | 340 | 800 | 5 | 2.1 | 20 | Left |
| 5082-7611 | Red | Common Anode | 340 | 800 | 5 | 2.1 | 20 | Right |
| 5082-7613 | Red | Common Cathode | 340 | 800 | 5 | 2.1 | 20 | Right |
| GaP Yellow 586 nm  | | | | | | | | |
| 5082-7620 | Yellow | Common Anode | 205 | 620 | 5 | 2.2 | 20 | Left |
| 5082-7621 | Yellow | Common Anode | 205 | 620 | 5 | 2.2 | 20 | Right |
| 5082-7623 | Yellow | Common Cathode | 205 | 620 | 5 | 2.2 | 20 | Right |
| GaP Green 571 nm  | | | | | | | | |
| HDSP-3600 | Green | Common Anode | 860 | 2700 | 10 | 2.1 | 10 | Left |
| HDSP-3601 | Green | Common Anode | 860 | 2700 | 10 | 2.1 | 10 | Right |
| HDSP-3603 | Green | Common Cathode | 860 | 2700 | 10 | 2.1 | 10 | Right |

Through-hole Seven-Segment Displays—Leadframe Platform

| Part Number | Face Color | Pin Configuration | Intensity (μcd) | | Iv Test Current (mA) | Vf Typ. (V) | Vf Test Current (mA) |
|---|------------|-------------------|------------------------------|------|----------------------|-------------|----------------------|
| | | | Min. | Typ. | | | |
| 8 mm (0.31") Micro Bright Displays (right decimal point) | | | | | | | |
| AlGaAs Red 637 nm  | | | | | | | |
| HDSP-U101 | Grey | Common Anode | 315 | 600 | 1 | 1.8 | 20 |
| HDSP-U111 | Black | Common Anode | 315 | 600 | 1 | 1.8 | 20 |
| HDSP-U103 | Grey | Common Cathode | 315 | 600 | 1 | 1.8 | 20 |
| HDSP-U113 | Black | Common Cathode | 315 | 600 | 1 | 1.8 | 20 |
| GaP Red 626 nm  | | | | | | | |
| HDSP-U201 | Grey | Common Anode | 360 | 980 | 5 | 2 | 20 |
| HDSP-U211 | Black | Common Anode | 360 | 980 | 5 | 2 | 20 |
| HDSP-U203 | Grey | Common Cathode | 360 | 980 | 5 | 2 | 20 |
| HDSP-U213 | Black | Common Cathode | 360 | 980 | 5 | 2 | 20 |
| GaP Orange 600 nm  | | | | | | | |
| HDSP-U401 | Grey | Common Anode | 360 | 980 | 5 | 2 | 20 |
| HDSP-U411 | Black | Common Anode | 360 | 980 | 5 | 2 | 20 |
| HDSP-U403 | Grey | Common Cathode | 360 | 980 | 5 | 2 | 20 |
| HDSP-U413 | Black | Common Cathode | 360 | 980 | 5 | 2 | 20 |
| GaP Yellow 586 nm  | | | | | | | |
| HDSP-U301 | Grey | Common Anode | 225 | 480 | 5 | 2.2 | 20 |
| HDSP-U311 | Black | Common Anode | 225 | 480 | 5 | 2.2 | 20 |
| HDSP-U303 | Grey | Common Cathode | 225 | 480 | 5 | 2.2 | 20 |
| HDSP-U313 | Black | Common Cathode | 225 | 480 | 5 | 2.2 | 20 |
| GaP Green 571 nm  | | | | | | | |
| HDSP-U501 | Grey | Common Anode | 860 | 3000 | 10 | 2.1 | 10 |
| HDSP-U511 | Black | Common Anode | 860 | 3000 | 10 | 2.1 | 10 |
| HDSP-U503 | Grey | Common Cathode | 860 | 3000 | 10 | 2.1 | 10 |
| HDSP-U513 | Black | Common Cathode | 860 | 3000 | 10 | 2.1 | 10 |

Through-hole Seven-Segment Displays—Leadframe Platform











| Part Number | Face Color | Pin Configuration | Intensity (μcd) | | Iv Test Current (mA) | Vf Typ. (V) | Vf Test Current (mA) |
|---|------------|-------------------|------------------------------|-------|----------------------|-------------|----------------------|
| | | | Min. | Typ. | | | |
| 10 mm (0.4") Single Digit Displays (right decimal point) | | | | | | | |
| AlGaAs Red 637 nm | | | | | | | |
| HDSP-F111 | Black | Common Anode | 330 | 650 | 1 | 1.6 | 1 |
| HDSP-F101 | Grey | Common Anode | 330 | 650 | 1 | 1.6 | 1 |
| HDSP-F113 | Black | Common Cathode | 330 | 650 | 1 | 1.6 | 1 |
| HDSP-F103 | Grey | Common Cathode | 330 | 650 | 1 | 1.8 | 1 |
| HDSP-F151 | Grey | Common Anode | 7500 | 15000 | 20 | 1.8 | 20 |
| HDSP-F153 | Grey | Common Cathode | 7500 | 15000 | 20 | 1.8 | 20 |
| HDSP-F161 | Black | Common Anode | 7500 | 15000 | 20 | 1.8 | 20 |
| GaP Red 626 nm | | | | | | | |
| HDSP-F211 | Black | Common Anode | 420 | 1200 | 5 | 2 | 20 |
| HDSP-F201 | Grey | Common Anode | 420 | 1200 | 5 | 2 | 20 |
| HDSP-F213 | Black | Common Cathode | 420 | 1200 | 5 | 2 | 20 |
| HDSP-F203 | Grey | Common Cathode | 420 | 1200 | 5 | 2 | 20 |
| GaP Orange 603 nm | | | | | | | |
| HDSP-F401 | Grey | Common Anode | 420 | 1200 | 5 | 2 | 20 |
| HDSP-F413 | Black | Common Cathode | 420 | 1200 | 5 | 2 | 20 |
| HDSP-F403 | Grey | Common Cathode | 420 | 1200 | 5 | 2 | 20 |
| GaP Yellow 586 nm | | | | | | | |
| HDSP-F301 | Grey | Common Anode | 290 | 800 | 5 | 2.2 | 20 |
| HDSP-F303 | Grey | Common Cathode | 290 | 800 | 5 | 2.2 | 20 |
| GaP Green 571 nm | | | | | | | |
| HDSP-F511 | Black | Common Anode | 1030 | 3500 | 10 | 2.1 | 10 |
| HDSP-F501 | Grey | Common Anode | 1030 | 3500 | 10 | 2.1 | 10 |
| HDSP-F513 | Black | Common Cathode | 1030 | 3500 | 10 | 2.1 | 10 |
| HDSP-F503 | Grey | Common Cathode | 1030 | 3500 | 10 | 2.1 | 10 |
| 10 mm (0.4") Overflow Displays (right decimal point) | | | | | | | |
| AlGaAs Red 637 nm | | | | | | | |
| HDSP-F107 | Grey | Common Anode | 330 | 650 | 1 | 1.6 | 1 |
| HDSP-F108 | Grey | Common Cathode | 330 | 650 | 1 | 1.6 | 1 |
| HDSP-F157 | Grey | Common Anode | 7500 | 15000 | 20 | 1.8 | 20 |
| HDSP-F158 | Grey | Common Cathode | 7500 | 15000 | 20 | 1.8 | 20 |
| GaP Red 626 nm | | | | | | | |
| HDSP-F207 | Grey | Common Anode | 420 | 1200 | 5 | 2 | 20 |
| HDSP-F208 | Grey | Common Cathode | 420 | 1200 | 5 | 2 | 20 |

Through-hole Seven-Segment Displays—Leadframe Platform

| Part Number | Face Color | Pin Configuration | Intensity | | Iv Test Current (mA) | Vf Typ. (V) | Vf Test Current (mA) | Decimal Point |
|--|------------|-------------------|-----------|-------|----------------------|-------------|----------------------|---------------|
| | | | Min. | Typ. | | | | |
| 10.9 mm (0.43") Single Digit Displays | | | | | | | | |
| AlGaAs Red 637 nm | | | | | | | | |
| HDSP-E101 | Grey | Common Anode | 390 | 650 | 1 | 1.6 | 1 | Right |
| HDSP-E103 | Grey | Common Cathode | 390 | 650 | 1 | 1.6 | 1 | Right |
| HDSP-E151 | Grey | Common Anode | 8500 | 15000 | 20 | 1.8 | 20 | Right |
| HDSP-E153 | Grey | Common Cathode | 8500 | 15000 | 20 | 1.8 | 20 | Right |
| GaP Red 626 nm | | | | | | | | |
| 5082-7650 | Red | Common Anode | 340 | 1115 | 5 | 2.1 | 20 | Left |
| 5082-7651 | Red | Common Anode | 340 | 1115 | 5 | 2.1 | 20 | Right |
| 5082-7653 | Red | Common Cathode | 340 | 1115 | 5 | 2.1 | 20 | Right |
| GaP Red 626 nm – Low Current | | | | | | | | |
| HDSP-3351 | Red | Common Anode | 200 | 300 | 2 | 1.6 | 2 | Right |
| HDSP-3353 | Red | Common Cathode | 200 | 300 | 2 | 1.6 | 2 | Right |
| GaP Yellow 586 nm | | | | | | | | |
| 5082-7661 | Yellow | Common Anode | 290 | 835 | 5 | 2.2 | 20 | Right |
| 5082-7663 | Yellow | Common Cathode | 290 | 835 | 5 | 2.2 | 20 | Right |
| GaP Green 571 nm | | | | | | | | |
| HDSP-4600 | Grey | Common Anode | 1030 | 4000 | 10 | 2.1 | 10 | Left |
| HDSP-4601 | Grey | Common Anode | 1030 | 4000 | 10 | 2.1 | 10 | Right |
| HDSP-4603 | Grey | Common Cathode | 1030 | 4000 | 10 | 2.1 | 10 | Right |
| 10.9mm (0.43") Overflow Displays | | | | | | | | |
| HDSP-3356 | Red | Universal | 200 | 300 | 2 | 1.6 | 2 | Right |

| Part Number | Face Color | Pin Configuration | Intensity | | Iv Test Current (mA) | Vf Typ. (V) | Vf Test Current (mA) | Decimal Point |
|-------------------------------------|------------|-------------------|-----------|------|----------------------|-------------|----------------------|---------------|
| | | | Min. | Typ. | | | | |
| GaP Red 626 nm – Low Current | | | | | | | | |
| 5082-7656 | Red | - | 340 | 1115 | 5 | 2.1 | 20 | Right |
| GaP Yellow 586 nm | | | | | | | | |
| 5082-7666 | Yellow | - | 290 | 835 | 5 | 2.2 | 20 | Right |
| GaP Green 571 nm | | | | | | | | |
| HDSP-4606 | Grey | - | 1030 | 4000 | 10 | 2.1 | 10 | Right |

Through-hole Seven-Segment Displays—Leadframe Platform

| Part Number | Face Color | Pin Configuration | Intensity (μcd) | | Iv Test Current (mA) | Vf Typ. (V) | Vf Test Current (mA) |
|---|------------|-------------------|------------------------------|-------|----------------------|-------------|----------------------|
| | | | Min. | Typ. | | | |
| 14.2 mm (0.56") Single Digit Displays (right decimal point) | | | | | | | |
| AlGaAs Red 637 nm  | | | | | | | |
| HDSP-H111 | Black | Common Anode | 400 | 700 | 1 | 1.6 | 1 |
| HDSP-H101 | Grey | Common Anode | 400 | 700 | 1 | 1.6 | 1 |
| HDSP-H113 | Black | Common Cathode | 400 | 700 | 1 | 1.6 | 1 |
| HDSP-H103 | Grey | Common Cathode | 400 | 700 | 1 | 1.6 | 1 |
| HDSP-H151 | Grey | Common Anode | 9100 | 16000 | 20 | 1.8 | 20 |
| HDSP-H153 | Grey | Common Cathode | 9100 | 16000 | 20 | 1.8 | 20 |
| GaP Red 626 nm  | | | | | | | |
| HDSP-H211 | Black | Common Anode | 900 | 2800 | 10 | 2 | 20 |
| HDSP-5501 | Grey | Common Anode | 900 | 2800 | 10 | 2.1 | 20 |
| HDSP-H213 | Black | Common Cathode | 900 | 2800 | 10 | 2 | 20 |
| HDSP-5503 | Grey | Common Cathode | 900 | 2800 | 10 | 2.1 | 20 |
| GaP Red 626 nm – Low Current  | | | | | | | |
| HDSP-5551 | Grey | Common Anode | 270 | 370 | 2 | 1.6 | 2 |
| HDSP-5553 | Grey | Common Cathode | 270 | 370 | 2 | 1.6 | 2 |
| GaP Orange 600 nm  | | | | | | | |
| HDSP-H413 | Black | Common Cathode | 1190 | 2000 | 10 | 2 | 20 |
| GaP Yellow 586 nm  | | | | | | | |
| HDSP-5701 | Grey | Common Anode | 600 | 1800 | 10 | 2.1 | 20 |
| HDSP-5703 | Grey | Common Cathode | 600 | 1800 | 10 | 2.1 | 20 |
| GaP Green 571 nm  | | | | | | | |
| HDSP-H511 | Black | Common Anode | 900 | 2500 | 10 | 2.1 | 10 |
| HDSP-5601 | Grey | Common Anode | 900 | 2500 | 10 | 2.1 | 10 |
| HDSP-H513 | Black | Common Cathode | 900 | 2500 | 10 | 2.1 | 10 |
| HDSP-5603 | Grey | Common Cathode | 900 | 2500 | 10 | 2.1 | 10 |
| 14.2 mm (0.56") Overflow Displays (right decimal point) | | | | | | | |
| AlGaAs Red 637 nm  | | | | | | | |
| HDSP-H107 | Grey | Common Anode | 400 | 700 | 1 | 1.6 | 1 |
| HDSP-H108 | Grey | Common Cathode | 400 | 700 | 1 | 1.6 | 1 |
| HDSP-H157 | Grey | Common Anode | 9100 | 16000 | 20 | 1.8 | 20 |
| HDSP-H158 | Grey | Common Cathode | 9100 | 16000 | 20 | 1.8 | 20 |
| GaP Red 626 nm  | | | | | | | |
| HDSP-5507 | Grey | Common Anode | 900 | 2800 | 10 | 2.1 | 20 |
| HDSP-5508 | Grey | Common Cathode | 900 | 2800 | 10 | 2.1 | 20 |
| GaP Red 626 nm – Low Current  | | | | | | | |
| HDSP-5557 | Grey | Common Anode | 270 | 370 | 2 | 1.6 | 2 |
| HDSP-5558 | Grey | Common Cathode | 270 | 370 | 2 | 1.6 | 2 |
| GaP Green 571 nm  | | | | | | | |
| HDSP-5607 | Grey | Common Anode | 900 | 2500 | 10 | 2.1 | 10 |
| HDSP-5608 | Grey | Common Cathode | 900 | 2500 | 10 | 2.1 | 10 |

Through-hole Seven-Segment Displays—Leadframe Platform









| Part Number | Face Color | Pin Configuration | Intensity (μcd) | | Iv Test Current (mA) | Vf Typ. (V) | Vf Test Current (mA) |
|--|------------|-------------------|------------------------------|------|----------------------|-------------|----------------------|
| | | | Min. | Typ. | | | |
| 14.2 mm (0.56") Dual Digit Displays (right decimal point) | | | | | | | |
| AlGaAs Red 637 nm | | | | | | | |
| HDSP-K121 | Grey | Common Anode | 400 | 700 | 1 | 1.6 | 1 |
| HDSP-K123 | Grey | Common Cathode | 400 | 700 | 1 | 1.6 | 1 |
| AlGaAs Red 637 nm - Low Current | | | | | | | |
| HDSP-K111 | Black | Common Anode | 400 | 700 | 1 | 1.6 | 1 |
| HDSP-K113 | Black | Common Cathode | 400 | 700 | 1 | 1.6 | 1 |
| GaP Red 626 nm | | | | | | | |
| HDSP-5521 | Grey | Common Anode | 900 | 2800 | 10 | 2.1 | 20 |
| HDSP-5523 | Grey | Common Cathode | 900 | 2800 | 10 | 2.1 | 20 |
| HDSP-K211 | Black | Common Anode | 900 | 2800 | 10 | 2.0 | 20 |
| HDSP-K213 | Black | Common Anode | 900 | 2800 | 10 | 2.0 | 20 |
| GaP Yellow 586 nm | | | | | | | |
| HDSP-5721 | Grey | Common Anode | 600 | 1800 | 10 | 2.1 | 10 |
| HDSP-5723 | Grey | Common Cathode | 600 | 1800 | 10 | 2.1 | 10 |
| GaP Green 571 nm | | | | | | | |
| HDSP-5621 | Grey | Common Anode | 900 | 2500 | 10 | 2.1 | 10 |
| HDSP-5623 | Grey | Common Cathode | 900 | 2500 | 10 | 2.1 | 10 |
| HDSP-K511 | Black | Common Anode | 900 | 2500 | 10 | 2.1 | 10 |
| HDSP-K513 | Black | Common Cathode | 900 | 2500 | 10 | 2.1 | 10 |

| Part Number | Face Color | Pin Configuration | Intensity | | Iv Test Current (mA) | Vf Typ. (V) | Vf Test Current (mA) | Decimal Point |
|---|------------|-------------------|-----------|-----------------------|----------------------|-------------|----------------------|---------------|
| | | | Min. | Typ. | | | | |
| 20 mm (0.8") Single Digit Displays | | | | | | | | |
| AlGaAs Red 637 nm | | | | | | | | |
| HDSP-N101 | Grey | Common Anode | 270 | 590 | 1 | 1.6 | 1 | Right |
| HDSP-N103 | Grey | Common Cathode | 270 | 590 | 1 | 1.6 | 1 | Right |
| HDSP-N105 | Grey | Common Cathode | 270 | 590 | 1 | 1.6 | 1 | Left |
| HDSP-N150 | Grey | Common Anode | 6000 | 14000 | 20 | 1.8 | 20 | Left |
| HDSP-N151 | Grey | Common Anode | 6000 | 14000 | 20 | 1.8 | 20 | Right |
| HDSP-N153 | Grey | Common Cathode | 6000 | 14000 | 20 | 1.8 | 20 | Right |
| GaP Red 626 nm | | | | | | | | |
| HDSP-3900 | Grey | Common Anode | 3350 | 48000 | 20 | 2.6 | 100 | Left |
| HDSP-3901 | Grey | Common Anode | 3350 | 7000 Peak (1/5 df) | | 2.6 | 100 | Right |
| HDSP-3903 | Grey | Common Cathode | 3350 | 7000 | | 2.6 | 100 | Right |
| HDSP-3905 | Grey | Common Cathode | 3350 | 7000 | | 2.6 | 100 | Left |
| GaP Yellow 586 nm | | | | | | | | |
| HDSP-4201 | Grey | Common Anode | 2200 | 7000 | | 2.6 | 100 | Right |
| HDSP-4203 | Grey | Common Cathode | 2200 | 7000 | | 2.6 | 100 | Right |
| GaP Green 571 nm | | | | | | | | |
| HDSP-8601 | Grey | Common Anode | 680 | 1500 | 10 | 2.1 | 10 | Right |
| HDSP-8603 | Grey | Common Cathode | 680 | 1500 | 10 | 2.1 | 10 | Right |









Through-hole Seven-Segment Displays—PCB Platform

| Part Number | Face Color | Pin Configuration | Intensity (μcd) | | Iv Test Current (mA) | Vf Typ. (V) | Vf Test Current (mA) | Decimal Point |
|--|------------|-------------------|------------------------------|-------|----------------------|-------------|----------------------|---------------|
| | | | Min. | Typ. | | | | |
| 7.62 mm (0.3") Single Digit Display | | | | | | | | |
| GaP Red 620 nm | | | | | | | | |
| HDSP-333E | Grey | Common Cathode | 800 | 1800 | 10 | 2.05 | 20 | Right |
| GaP Green 573 nm | | | | | | | | |
| HDSP-333G | Grey | Common Cathode | 800 | 2000 | 10 | 2.25 | 20 | Right |
| AlGaAs Red 643 nm | | | | | | | | |
| HDSP-333A | Grey | Common Cathode | 2001 | 4200 | 10 | 1.85 | 20 | Right |
| 9.1 mm (0.36") Single Digit Display | | | | | | | | |
| AlGaAs Red 643 nm | | | | | | | | |
| HDSP-C3A1 | Grey | Common Anode | - | 7500 | 10 | 1.85 | 20 | Right |
| HDSP-C3A3 | Grey | Common Cathode | - | 7500 | 10 | 1.85 | 20 | Right |
| GaAsP Red 626 nm | | | | | | | | |
| HDSP-C3E1 | Grey | Common Anode | - | 1100 | 10 | 2.0 | 20 | Right |
| HDSP-C3E3 | Grey | Common Cathode | - | 1100 | 10 | 2.0 | 20 | Right |
| AllnGaP Deep Red 635 nm | | | | | | | | |
| HDSP-H3A1 | Grey | Common Anode | - | 12000 | 10 | 2.0 | 20 | Right |
| HDSP-H3A3 | Grey | Common Cathode | - | 12000 | 10 | 2.0 | 20 | Right |
| AllnGaP Red 625 nm | | | | | | | | |
| HDSP-H3E1 | Grey | Common Anode | - | 15000 | 10 | 2.0 | 20 | Right |
| HDSP-H3E3 | Grey | Common Cathode | - | 15000 | 10 | 2.0 | 20 | Right |
| AllnGaP Orange 605 nm | | | | | | | | |
| HDSP-H3L1 | Grey | Common Anode | - | 13000 | 10 | 2.0 | 20 | Right |
| HDSP-H3L3 | Grey | Common Cathode | - | 13000 | 10 | 2.0 | 20 | Right |
| AllnGaP Green 573 nm | | | | | | | | |
| HDSP-H3G1 | Grey | Common Anode | - | 5000 | 10 | 2.0 | 20 | Right |
| HDSP-H3G3 | Grey | Common Cathode | - | 5000 | 10 | 2.0 | 20 | Right |
| 10 mm (0.4") Slim Font Single Digit Display | | | | | | | | |
| GaP Red 625 nm | | | | | | | | |
| HDSP-301E | Grey | Common Anode | 1100 | 1100 | 10 | 1.90 | 20 | Right |
| HDSP-303E | Grey | Common Cathode | 1100 | 1100 | 10 | 1.90 | 20 | Right |
| GaP Green 573 nm | | | | | | | | |
| HDSP-301G | Grey | Common Anode | 1800 | 2800 | 10 | 2.25 | 20 | Right |
| HDSP-303G | Grey | Common Cathode | 1800 | 2800 | 10 | 2.25 | 20 | Right |
| AlGaAs Red 643 nm | | | | | | | | |
| HDSP-301A | Grey | Common Anode | 280 | 450 | 1 | 1.80 | 20 | Right |
| HDSP-303A | Grey | Common Cathode | 280 | 450 | 1 | 1.80 | 20 | Right |
| GaP Yellow 590 nm | | | | | | | | |
| HDSP-301Y | Grey | Common Anode | 1100 | 1800 | 10 | 2.15 | 20 | Right |
| HDSP-303Y | Grey | Common Cathode | 1100 | 1800 | 10 | 2.15 | 20 | Right |









Through-hole Seven-Segment Displays—PCB Platform

| Part Number | Face Color | Pin Configuration | Intensity (μcd) | | Iv Test Current (mA) | Vf Typ. (V) | Vf Test Current (mA) | Decimal Point |
|--|------------|-------------------|------------------------------|------|----------------------|-------------|----------------------|---------------|
| | | | Min. | Typ. | | | | |
| 10.16 mm (0.4") Single Digit Display | | | | | | | | |
| GaP Red 620 nm  | | | | | | | | |
| HDSP-311E | Grey | Common Anode | 1250 | 3200 | 10 | 2.05 | 20 | Right |
| HDSP-313E | Grey | Common Cathode | 1250 | 3200 | 10 | 2.05 | 20 | Right |
| GaP Green 573 nm  | | | | | | | | |
| HDSP-311G | Grey | Common Anode | 1250 | 3200 | 10 | 2.25 | 20 | Right |
| HDSP-313G | Grey | Common Cathode | 1250 | 3200 | 10 | 2.25 | 20 | Right |
| AlGaAs Red 643 nm  | | | | | | | | |
| HDSP-311A | Grey | Common Anode | 3200 | 7500 | 10 | 1.85 | 20 | Right |
| HDSP-313A | Grey | Common Cathode | 3200 | 7500 | 10 | 1.85 | 20 | Right |
| GaP Yellow 590 nm  | | | | | | | | |
| HDSP-311Y | Grey | Common Anode | 800 | 1500 | 10 | 2.15 | 20 | Right |
| HDSP-313Y | Grey | Common Cathode | 800 | 1500 | 10 | 2.15 | 20 | Right |
| 10.16 mm (0.4") Dual Digit Display | | | | | | | | |
| GaP Red 620 nm  | | | | | | | | |
| HDSP-G01E | Grey | Common Anode | 1250 | 2600 | 10 | 2.05 | 20 | - |
| HDSP-G03E | Grey | Common Cathode | 1250 | 2600 | 10 | 2.05 | 20 | - |
| GaP Green 573 nm  | | | | | | | | |
| HDSP-G01G | Grey | Common Anode | 1250 | 3200 | 10 | 2.25 | 20 | - |
| HDSP-G03G | Grey | Common Cathode | 1250 | 3200 | 10 | 2.25 | 20 | - |
| AlGaAs Red 643 nm  | | | | | | | | |
| HDSP-G01A | Grey | Common Anode | 3200 | 6500 | 10 | 1.85 | 20 | - |
| HDSP-G03A | Grey | Common Cathode | 3200 | 6500 | 10 | 1.85 | 20 | - |
| GaP Yellow 590 nm  | | | | | | | | |
| HDSP-G01Y | Grey | Common Anode | 800 | 1500 | 10 | 2.15 | 20 | - |
| HDSP-G03Y | Grey | Common Cathode | 800 | 1500 | 10 | 2.15 | 20 | - |











Through-hole Seven-Segment Displays—PCB Platform

| Part Number | Face Color | Pin Configuration | Intensity (μcd) | | Iv Test Current (mA) | Vf Typ. (V) | Vf Test Current (mA) | Decimal Point |
|---|------------|-------------------|------------------------------|-------|----------------------|-------------|----------------------|---------------|
| | | | Min. | Typ. | | | | |
| 0.56" Slim Font Single Digit Display | | | | | | | | |
| GaP Red 625 nm  | | | | | | | | |
| HDSP-561E | Grey | Common Anode | 1100 | 1800 | 10 | 1.90 | 20 | Right |
| HDSP-563E | Grey | Common Cathode | 1100 | 1800 | 10 | 1.90 | 20 | Right |
| GaP Green 573 nm  | | | | | | | | |
| HDSP-561G | Grey | Common Anode | 1800 | 2800 | 10 | 2.25 | 20 | Right |
| HDSP-563G | Grey | Common Cathode | 1800 | 2800 | 10 | 2.25 | 20 | Right |
| AlGaAs Red 643 nm  | | | | | | | | |
| HDSP-561A | Grey | Common Anode | 280 | 450 | 1 | 2.1 | 20 | Right |
| HDSP-563A | Grey | Common Cathode | 280 | 450 | 1 | 2.1 | 20 | Right |
| GaP Yellow 590 nm  | | | | | | | | |
| HDSP-561Y | Grey | Common Anode | 1800 | 2800 | 10 | 1.80 | 20 | Right |
| HDSP-563Y | Grey | Common Cathode | 1800 | 2800 | 10 | 1.80 | 20 | Right |
| 13.1mm (0.52") Single Digit Display | | | | | | | | |
| AlGaAs Red 643 nm  | | | | | | | | |
| HDSP-C5A1 | Grey | Common Anode | - | 16000 | 10 | 1.85 | 20 | Right |
| HDSP-C5A3 | Grey | Common Cathode | - | 16000 | 10 | 1.85 | 20 | Right |
| AllnGaP Deep Red 635 nm  | | | | | | | | |
| HDSP-H5A1 | Grey | Common Anode | - | 35000 | 10 | 2.0 | 20 | Right |
| HDSP-H5A3 | Grey | Common Cathode | - | 35000 | 10 | 2.0 | 20 | Right |
| AllnGaP Red 625 nm  | | | | | | | | |
| HDSP-H5E1 | Grey | Common Anode | - | 40000 | 10 | 2.0 | 20 | Right |
| HDSP-H5E3 | Grey | Common Cathode | - | 40000 | 10 | 2.0 | 20 | Right |
| AllnGaP Orange 605 nm  | | | | | | | | |
| HDSP-H5L1 | Grey | Common Anode | - | 40000 | 10 | 2.0 | 20 | Right |
| HDSP-H5L3 | Grey | Common Cathode | - | 40000 | 10 | 2.0 | 20 | Right |
| AllnGaP Green 573 nm  | | | | | | | | |
| HDSP-H5G1 | Grey | Common Anode | - | 15000 | 10 | 2.0 | 20 | Right |
| HDSP-H5G3 | Grey | Common Cathode | - | 15000 | 10 | 2.0 | 20 | Right |







Through-hole Seven-Segment Displays—PCB Platform

| Part Number | Face Color | Pin Configuration | Intensity (μcd) | | Iv Test Current (mA) | Vf Typ. (V) | Vf Test Current (mA) | Decimal Point |
|--|------------|-------------------|------------------------------|------|----------------------|-------------|----------------------|---------------|
| | | | Min. | Typ. | | | | |
| 14.2 mm (0.56") Single Digit Display | | | | | | | | |
| GaP Red 620 nm  | | | | | | | | |
| HDSP-511E | Grey | Common Anode | 2001 | 4100 | 10 | 2.05 | 20 | Right |
| HDSP-513E | Grey | Common Cathode | 2001 | 4100 | 10 | 2.05 | 20 | Right |
| GaP Green 573 nm  | | | | | | | | |
| HDSP-511G | Grey | Common Anode | 2001 | 4100 | 10 | 2.25 | 20 | Right |
| HDSP-513G | Grey | Common Cathode | 2001 | 4100 | 10 | 2.25 | 20 | Right |
| AlGaAs Red 643 nm  | | | | | | | | |
| HDSP-511A | Grey | Common Anode | 3201 | 6500 | 10 | 1.85 | 20 | Right |
| HDSP-513A | Grey | Common Cathode | 3201 | 6500 | 10 | 1.85 | 20 | Right |
| GaP Yellow 590 nm  | | | | | | | | |
| HDSP-511Y | Grey | Common Anode | 1251 | 2600 | 10 | 2.15 | 20 | Right |
| HDSP-513Y | Grey | Common Cathode | 1251 | 2600 | 10 | 2.15 | 20 | Right |
| 14.2 mm (0.56") Dual Digit Displays | | | | | | | | |
| GaP Yellow 587 nm  | | | | | | | | |
| HDSP-521Y | Grey | Common Anode | 1520 | 2300 | 10 | 2.1 | 20 | Right |
| HDSP-523Y | Grey | Common Cathode | 1520 | 2300 | 10 | 2.1 | 20 | Right |
| GaP Red 626 nm  | | | | | | | | |
| HDSP-521E | Grey | Common Anode | 2280 | 4000 | 10 | 2.1 | 20 | Right |
| HDSP-523E | Grey | Common Cathode | 2280 | 4000 | 10 | 2.1 | 20 | Right |
| GaP Green 571 nm  | | | | | | | | |
| HDSP-521G | Grey | Common Anode | 2280 | 3500 | 10 | 2.1 | 10 | Right |
| HDSP-523G | Grey | Common Cathode | 2280 | 3500 | 10 | 2.1 | 10 | Right |
| AlGaAs Red 643 nm  | | | | | | | | |
| HDSP-521A | Grey | Common Anode | - | 6500 | 10 | 1.85 | 20 | Right |
| HDSP-523A | Grey | Common Cathode | - | 6500 | 10 | 1.85 | 20 | Right |











Through-hole Seven-Segment Displays—PCB Platform

| Part Number | Face Color | Pin Configuration | Intensity (μcd) | | Iv Test Current (mA) | Vf Typ. (V) | Vf Test Current (mA) | Decimal Point |
|--|------------|-------------------|------------------------------|-------|----------------------|-------------|----------------------|---------------|
| | | | Min. | Typ. | | | | |
| 20 mm (0.8") Single Digit Display | | | | | | | | |
| GaP Red 626 nm  | | | | | | | | |
| HDSP-815E | Grey | Common Anode | 2300 | 4800 | 20 | 2.1 | 20 | Right |
| HDSP-816E | Grey | Common Cathode | 2300 | 4800 | 20 | 2.1 | 20 | Right |
| GaP Green 571 nm  | | | | | | | | |
| HDSP-815G | Grey | Common Anode | 1500 | 3300 | 20 | 2.1 | 20 | Right |
| HDSP-816G | Grey | Common Cathode | 1500 | 3300 | 20 | 2.1 | 20 | Right |
| 20mm (0.8") Single Digit Display | | | | | | | | |
| AlGaAs Red 643 nm  | | | | | | | | |
| HDSP-C8A1 | Grey | Common Anode | - | 18200 | 10 | 1.85 | 20 | Right |
| HDSP-C8A3 | Grey | Common Cathode | - | 18200 | 10 | 1.85 | 20 | Right |
| GaAsP Red 626 nm  | | | | | | | | |
| HDSP-C8E1 | Grey | Common Anode | - | 4800 | 10 | 2.0 | 20 | Right |
| HDSP-C8E3 | Grey | Common Cathode | - | 4800 | 10 | 2.0 | 20 | Right |
| GaAsP Orange  | | | | | | | | |
| HDSP-C8L1 | Grey | Common Anode | - | 4500 | 10 | 2.15 | 20 | Right |
| HDSP-C8L3 | Grey | Common Cathode | - | 4500 | 10 | 2.15 | 20 | Right |
| GaP Green  | | | | | | | | |
| HDSP-C8G1 | Grey | Common Anode | - | 5000 | 10 | 2.25 | 20 | Right |
| HDSP-C8G3 | Grey | Common Cathode | - | 5000 | 10 | 2.25 | 20 | Right |
| AllnGaP Deep Red 635 nm  | | | | | | | | |
| HDSP-H8A1 | Grey | Common Anode | - | 29000 | 10 | 2.0 | 20 | Right |
| HDSP-H8A3 | Grey | Common Cathode | - | 29000 | 10 | 2.0 | 20 | Right |
| AllnGaP Red 625 nm  | | | | | | | | |
| HDSP-H8E1 | Grey | Common Anode | - | 30000 | 10 | 2.0 | 20 | Right |
| HDSP-H8E3 | Grey | Common Cathode | - | 30000 | 10 | 2.0 | 20 | Right |
| AllnGaP Orange 605 nm  | | | | | | | | |
| HDSP-H8L1 | Grey | Common Anode | - | 35000 | 10 | 2.0 | 20 | Right |
| HDSP-H8L3 | Grey | Common Cathode | - | 35000 | 10 | 2.0 | 20 | Right |
| AllnGaP Green 571 nm  | | | | | | | | |
| HDSP-H8G1 | Grey | Common Anode | - | 12000 | 10 | 2.0 | 20 | Right |
| HDSP-H8G3 | Grey | Common Cathode | - | 12000 | 10 | 2.0 | 20 | Right |













Through-hole Seven-Segment Displays—PCB

| Part Number | Face Color | Pin Configuration | Intensity (μcd) | | Iv Test Current (mA) | Vf Typ. (V) | Vf Test Current (mA) | Decimal Point |
|---|------------|-------------------|------------------------------|--------|----------------------|-------------|----------------------|---------------|
| | | | Min. | Typ. | | | | |
| 20 mm (0.8") Single Digit Display | | | | | | | | |
| AllnGaP Deep Red 635 nm  | | | | | | | | |
| HDSP-H1A1 | Grey | Common Anode | - | 70000 | 10 | 4.0 | 20 | Right |
| HDSP-H1A3 | Grey | Common Cathode | - | 70000 | 10 | 4.0 | 20 | Right |
| AllnGaP Red 625 nm  | | | | | | | | |
| HDSP-H1E1 | Grey | Common Anode | - | 70000 | 10 | 4.0 | 20 | Right |
| HDSP-H1E3 | Grey | Common Cathode | - | 70000 | 10 | 4.0 | 20 | Right |
| AllnGaP Green 571 nm  | | | | | | | | |
| HDSP-H1G1 | Grey | Common Anode | - | 25000 | 10 | 4.0 | 20 | Right |
| HDSP-H1G3 | Grey | Common Cathode | - | 25000 | 10 | 4.0 | 20 | Right |
| 56.80mm (2.3") Single Digit Display | | | | | | | | |
| AllnGaP Deep Red 635 nm  | | | | | | | | |
| HDSP-H2A1 | Grey | Common Anode | - | 95000 | 10 | 8.0 | 20 | Right |
| HDSP-H2A3 | Grey | Common Cathode | - | 95000 | 10 | 8.0 | 20 | Right |
| AllnGaP Red 625 nm  | | | | | | | | |
| HDSP-H2E1 | Grey | Common Anode | - | 105000 | 10 | 8.0 | 20 | Right |
| HDSP-H2E3 | Grey | Common Cathode | - | 105000 | 10 | 8.0 | 20 | Right |
| AllnGaP Green 571 nm  | | | | | | | | |
| HDSP-H2G1 | Grey | Common Anode | - | 38000 | 10 | 8.0 | 20 | Right |
| HDSP-H2G3 | Grey | Common Cathode | - | 38000 | 10 | 8.0 | 20 | Right |













Surface Mount Seven-Segment Displays—PCB Platform

| Part Number | Face Color | Pin Configuration | Intensity (mcd) | | Iv Test Current (mA) | Vf Typ. (V) | Vf Test Current (mA) | Decimal Point |
|--|------------|-------------------|-----------------|------|----------------------|-------------|----------------------|-----------------|
| | | | Min. | Typ. | | | | |
| 7.0mm (0.28") Single Digit SMT Display | | | | | | | | |
| AllInGaP Red 624 nm  | | | | | | | | |
| HDSM-281C | Grey | Common Anode | 3.4 | 7.5 | 10 | 2 | 20 | Upper and Lower |
| HDSM-283C | Grey | Common Cathode | 3.4 | 7.5 | 10 | 2 | 20 | Upper and Lower |
| AllInGaP Green 571 nm  | | | | | | | | |
| HDSM-281H | Grey | Common Anode | 3.4 | 6 | 10 | 2.1 | 20 | Upper and Lower |
| HDSM-283H | Grey | Common Cathode | 3.4 | 6 | 10 | 2.1 | 20 | Upper and Lower |
| AllInGaP Yellow 589 nm  | | | | | | | | |
| HDSM-281F | Grey | Common Anode | 3.4 | 8 | 10 | 2.1 | 20 | Upper and Lower |
| HDSM-283F | Grey | Common Cathode | 3.4 | 8 | 10 | 2.1 | 20 | Upper and Lower |
| AllInGaP Orange 605 nm  | | | | | | | | |
| HDSM-281L | Grey | Common Anode | 3.4 | 8.5 | 10 | 2.1 | 20 | Upper and Lower |
| HDSM-283L | Grey | Common Cathode | 3.4 | 8.5 | 10 | 2.1 | 20 | Upper and Lower |
| InGaN Blue 470 nm  | | | | | | | | |
| HDSM-281B | Grey | Common Anode | 3.4 | 6 | 10 | 3.3 | 20 | Upper and Lower |
| HDSM-283B | Grey | Common Cathode | 3.4 | 6 | 10 | 3.3 | 20 | Upper and Lower |
| 7.0 mm (0.28") Dual Digit SMT Display | | | | | | | | |
| AllInGaP Red 624 nm  | | | | | | | | |
| HDSM-291C | Grey | Common Anode | 3.4 | 7.5 | 10 | 2 | 20 | Upper and Lower |
| HDSM-293C | Grey | Common Cathode | 3.4 | 7.5 | 10 | 2 | 20 | Upper and Lower |
| AllInGaP Green 571 nm  | | | | | | | | |
| HDSM-291H | Grey | Common Anode | 3.4 | 6 | 10 | 2.1 | 20 | Upper and Lower |
| HDSM-293H | Grey | Common Cathode | 3.4 | 6 | 10 | 2.1 | 20 | Upper and Lower |
| AllInGaP Yellow 589 nm  | | | | | | | | |
| HDSM-291F | Grey | Common Anode | 3.4 | 8 | 10 | 2.1 | 20 | Upper and Lower |
| HDSM-293F | Grey | Common Cathode | 3.4 | 8 | 10 | 2.1 | 20 | Upper and Lower |
| AllInGaP Orange 605 nm  | | | | | | | | |
| HDSM-291L | Grey | Common Anode | 3.4 | 8.5 | 10 | 2.1 | 20 | Upper and Lower |
| HDSM-293L | Grey | Common Cathode | 3.4 | 8.5 | 10 | 2.1 | 20 | Upper and Lower |
| InGaN Blue 470 nm  | | | | | | | | |
| HDSM-291B | Grey | Common Anode | 3.4 | 6 | 10 | 3.3 | 20 | Upper and Lower |
| HDSM-293B | Grey | Common Cathode | 3.4 | 6 | 10 | 3.3 | 20 | Upper and Lower |

Surface Mount Seven-Segment Displays—PCB Platform

| Part Number | Face Color | Pin Configuration | Intensity (mcd) | | Iv Test Current (mA) | Vf Typ. (V) | Vf Test Current (mA) | Decimal Point |
|--|------------|-------------------|-----------------|------|----------------------|-------------|----------------------|---------------|
| | | | Min. | Typ. | | | | |
| 10 mm (0.39") Single Digit SMT Display | | | | | | | | |
| AllInGaP Red 624 nm  | | | | | | | | |
| HDSM-431C | Grey | Common Anode | 8.6 | 14.3 | 10 | 2 | 20 | Right |
| HDSM-433C | Grey | Common Cathode | 8.6 | 14.3 | 10 | 2 | 20 | Right |
| AllInGaP Green 571 nm  | | | | | | | | |
| HDSM-431H | Grey | Common Anode | 5.4 | 9 | 10 | 2.1 | 20 | Right |
| HDSM-433H | Grey | Common Cathode | 5.4 | 9 | 10 | 2.1 | 20 | Right |
| AllInGaP Yellow 589 nm  | | | | | | | | |
| HDSM-431F | Grey | Common Anode | 8.6 | 15 | 10 | 2.1 | 20 | Right |
| HDSM-433F | Grey | Common Cathode | 8.6 | 15 | 10 | 2.1 | 20 | Right |
| AllInGaP Orange 605 nm  | | | | | | | | |
| HDSM-431L | Grey | Common Anode | 8.6 | 16 | 10 | 2.1 | 20 | Right |
| HDSM-433L | Grey | Common Cathode | 8.6 | 16 | 10 | 2.1 | 20 | Right |
| InGaN Blue 470nm  | | | | | | | | |
| HDSM-431B | Grey | Common Anode | 5.4 | 11.2 | 10 | 3.3 | 20 | Right |
| HDSM-433B | Grey | Common Cathode | 5.4 | 11.2 | 10 | 3.3 | 20 | Right |
| InGaN White  | | | | | | | | |
| HDSM-431W | Grey | Common Anode | 24 | 40 | 5 | 2.95 | 5 | Right |
| HDSM-433W | Grey | Common Cathode | 24 | 40 | 5 | 2.95 | 5 | Right |
| 10 mm (0.39") Dual Digit SMT Display | | | | | | | | |
| AllInGaP Red 624 nm  | | | | | | | | |
| HDSM-441C | Grey | Common Anode | 8.6 | 14.3 | 10 | 2 | 20 | Right |
| HDSM-443C | Grey | Common Cathode | 8.6 | 14.3 | 10 | 2 | 20 | Right |
| AllInGaP Green 571 nm  | | | | | | | | |
| HDSM-441H | Grey | Common Anode | 5.4 | 9 | 10 | 2.1 | 20 | Right |
| HDSM-443H | Grey | Common Cathode | 5.4 | 9 | 10 | 2.1 | 20 | Right |
| AllInGaP Yellow 589 nm  | | | | | | | | |
| HDSM-441F | Grey | Common Anode | 8.6 | 15 | 10 | 2.1 | 20 | Right |
| HDSM-443F | Grey | Common Cathode | 8.6 | 15 | 10 | 2.1 | 20 | Right |
| AllInGaP Orange 605 nm  | | | | | | | | |
| HDSM-441L | Grey | Common Anode | 8.6 | 16 | 10 | 2.1 | 20 | Right |
| HDSM-443L | Grey | Common Cathode | 8.6 | 16 | 10 | 2.1 | 20 | Right |
| InGaN Blue 470 nm  | | | | | | | | |
| HDSM-441B | Grey | Common Anode | 5.4 | 11.2 | 10 | 3.3 | 20 | Right |
| HDSM-443B | Grey | Common Cathode | 5.4 | 11.2 | 10 | 3.3 | 20 | Right |
| InGaN White  | | | | | | | | |
| HDSM-441W | Grey | Common Anode | 24 | 40 | 5 | 2.95 | 5 | Right |
| HDSM-443W | Grey | Common Cathode | 24 | 40 | 5 | 2.95 | 5 | Right |

Surface Mount Seven-Segment Displays—PCB Platform

| Part Number | Face Color | Pin Configuration | Intensity (mcd) | | Iv Test Current (mA) | Vf Typ. (V) | Vf Test Current (mA) | Decimal Point |
|--|------------|-------------------|-----------------|------|----------------------|-------------|----------------------|---------------|
| | | | Min. | Typ. | | | | |
| 14.22 mm (0.56") Single Digit SMT Display | | | | | | | | |
| AllInGaP Red 624 nm  | | | | | | | | |
| HDSM-531C | Grey | Common Anode | 8.6 | 16 | 10 | 2 | 20 | Right |
| HDSM-533C | Grey | Common Cathode | 8.6 | 16 | 10 | 2 | 20 | Right |
| AllInGaP Green 571 nm  | | | | | | | | |
| HDSM-531H | Grey | Common Anode | 5.4 | 10.5 | 10 | 2.1 | 20 | Right |
| HDSM-533H | Grey | Common Cathode | 5.4 | 10.5 | 10 | 2.1 | 20 | Right |
| AllInGaP Yellow 589 nm  | | | | | | | | |
| HDSM-531F | Grey | Common Anode | 8.6 | 20 | 10 | 2.1 | 20 | Right |
| HDSM-533F | Grey | Common Cathode | 8.6 | 20 | 10 | 2.1 | 20 | Right |
| AllInGaP Orange 605 nm  | | | | | | | | |
| HDSM-531L | Grey | Common Anode | 8.6 | 19.5 | 10 | 2.1 | 20 | Right |
| HDSM-533L | Grey | Common Cathode | 8.6 | 19.5 | 10 | 2.1 | 20 | Right |
| InGaN Blue 470nm  | | | | | | | | |
| HDSM-531B | Grey | Common Anode | 5.4 | 13.5 | 10 | 3.3 | 20 | Right |
| HDSM-533B | Grey | Common Cathode | 5.4 | 13.5 | 10 | 3.3 | 20 | Right |
| InGaN White  | | | | | | | | |
| HDSM-531W | Grey | Common Anode | 28 | 44 | 5 | 2.95 | 5 | Right |
| HDSM-533W | Grey | Common Cathode | 28 | 44 | 5 | 2.95 | 5 | Right |
| 14.22mm (0.56") Dual Digit SMT Display | | | | | | | | |
| AllInGaP Red 624 nm  | | | | | | | | |
| HDSM-541C | Grey | Common Anode | 8.6 | 16 | 10 | 2 | 20 | Right |
| HDSM-543C | Grey | Common Cathode | 8.6 | 16 | 10 | 2 | 20 | Right |
| AllInGaP Green 571 nm  | | | | | | | | |
| HDSM-541H | Grey | Common Anode | 5.4 | 10.5 | 10 | 2.1 | 20 | Right |
| HDSM-543H | Grey | Common Cathode | 5.4 | 10.5 | 10 | 2.1 | 20 | Right |
| AllInGaP Yellow 589 nm  | | | | | | | | |
| HDSM-541F | Grey | Common Anode | 8.6 | 20 | 10 | 2.1 | 20 | Right |
| HDSM-543F | Grey | Common Cathode | 8.6 | 20 | 10 | 2.1 | 20 | Right |
| AllInGaP Orange 605 nm  | | | | | | | | |
| HDSM-541L | Grey | Common Anode | 8.6 | 19.5 | 10 | 2.1 | 20 | Right |
| HDSM-543L | Grey | Common Cathode | 8.6 | 19.5 | 10 | 2.1 | 20 | Right |
| InGaN Blue 470 nm  | | | | | | | | |
| HDSM-541B | Grey | Common Anode | 5.4 | 13.5 | 10 | 3.3 | 20 | Right |
| HDSM-543B | Grey | Common Cathode | 5.4 | 13.5 | 10 | 3.3 | 20 | Right |
| InGaN White  | | | | | | | | |
| HDSM-541W | Grey | Common Anode | 28 | 44 | 5 | 2.95 | 5 | Right |
| HDSM-543W | Grey | Common Cathode | 28 | 44 | 5 | 2.95 | 5 | Right |

Through-hole Seven-Segment Displays—PCB Platform Luminous Intensity Categories (Typ.)

7.62 mm (0.3") Single Digit

| Bin ID | Iv in mcd | |
|----------------------|-----------|-------|
| | Min. | Max. |
| GaP Red HDSP-33xE | | |
| G | 0.801 | 1.250 |
| H | 1.251 | 2.000 |
| I | 2.001 | 3.200 |
| GaP Green HDSP-33xG | | |
| G | 0.801 | 1.250 |
| H | 1.251 | 2.000 |
| I | 2.001 | 3.200 |
| AlGaAs Red HDSP-33xA | | |
| I | 2.001 | 3.200 |
| J | 3.201 | 5.050 |
| K | 5.051 | 8.000 |

10.16 mm (0.4") Single Digit

| Bin ID | Iv in mcd | |
|----------------------|-----------|--------|
| | Min. | Max. |
| GaP Red HDSP-31xE | | |
| H | 1.251 | 2.000 |
| I | 2.001 | 3.200 |
| J | 3.201 | 5.050 |
| GaP Green HDSP-31xG | | |
| H | 1.251 | 2.000 |
| I | 2.001 | 3.200 |
| J | 3.201 | 5.050 |
| AlGaAs Red HDSP-31xA | | |
| J | 3.201 | 5.050 |
| K | 5.051 | 8.000 |
| L | 8.001 | 12.650 |
| GaP Yellow HDSP-31xY | | |
| G | 0.801 | 1.250 |
| H | 1.251 | 2.000 |
| I | 2.001 | 3.200 |

13 mm (0.56") Slim Font Single Digit

| Bin ID | Iv in mcd | |
|----------------------|-----------|-------|
| | Min. | Max. |
| GaP Red HDSP-56xE | | |
| I | 1.100 | 2.200 |
| K | 1.800 | 3.600 |
| GaP Green HDSP-56xG | | |
| K | 1.800 | 3.600 |
| L | 2.800 | 5.600 |
| AlGaAs Red HDSP-56xA | | |
| F | 0.280 | 0.560 |
| G | 0.450 | 0.900 |
| GaP Yellow HDSP-56xY | | |
| I | 1.100 | 2.200 |
| K | 1.800 | 3.600 |

10 mm (0.4") Slim Font Single Digit





| Bin ID | Iv in mcd | |
|----------------------|-----------|-------|
| | Min. | Max. |
| GaP Red HDSP-30xE | | |
| I | 1.100 | 2.200 |
| K | 1.800 | 3.600 |
| GaP Green HDSP-30xG | | |
| K | 1.800 | 3.600 |
| L | 2.800 | 5.600 |
| AlGaAs Red HDSP-30xA | | |
| F | 0.280 | 0.560 |
| G | 0.450 | 0.900 |
| GaP Yellow HDSP-30xY | | |
| I | 1.100 | 2.200 |
| K | 1.800 | 3.600 |

10.16 mm (0.4") Dual Digit





| Bin ID | Iv in mcd | |
|----------------------|-----------|--------|
| | Min. | Max. |
| GaP Red HDSP-G0xE | | |
| H | 1.251 | 2.000 |
| I | 2.001 | 3.200 |
| J | 3.201 | 5.050 |
| GaP Green HDSP-G0xG | | |
| H | 1.251 | 2.000 |
| I | 2.001 | 3.200 |
| J | 3.201 | 5.050 |
| AlGaAs Red HDSP-G0xA | | |
| J | 3.201 | 5.050 |
| K | 5.051 | 8.000 |
| L | 8.001 | 12.650 |
| GaP Yellow HDSP-G0xY | | |
| G | 0.801 | 1.250 |
| H | 1.251 | 2.000 |
| I | 2.001 | 3.200 |

Through-hole Seven-Segment Displays—PCB Platform



14.22 mm (0.56") Single Digit

| Bin ID | Customer Iv in mcd | |
|--|--------------------|--------|
| | Min. | Max. |
| GaP Red  HDSP-51xE | | |
| I | 2.001 | 3.200 |
| J | 3.201 | 5.050 |
| K | 5.051 | 8.000 |
| GaP Green  HDSP-51xG | | |
| I | 2.001 | 3.200 |
| J | 3.201 | 5.050 |
| K | 5.051 | 8.000 |
| AlGaAs Red  HDSP-51xA | | |
| J | 3.201 | 5.050 |
| K | 5.051 | 8.000 |
| L | 8.001 | 12.650 |
| GaP Yellow  HDSP-51xY | | |
| H | 1.251 | 2.000 |
| I | 2.001 | 3.200 |
| J | 3.201 | 5.050 |

0.56" Dual Digit

| Bin ID | Customer Iv in mcd | |
|--|--------------------|--------|
| | Min. | Max. |
| GaP Red  HDSP-52xE | | |
| G | 2.28 | 3.42 |
| H | 3.42 | 5.13 |
| I | 5.13 | 7.69 |
| GaP Yellow  HDSP-52xY | | |
| F | 1.52 | 2.28 |
| G | 2.28 | 3.42 |
| H | 3.42 | 5.13 |
| GaP Green  HDSP-52xG | | |
| G | 2.28 | 3.42 |
| H | 3.42 | 5.13 |
| AlGaAs Red  HDSP-52xA | | |
| J | 3.201 | 5.050 |
| K | 5.051 | 8.000 |
| L | 8.001 | 12.650 |

0.8" Single Digit

| Bin ID | Customer Iv in mcd | |
|---|--------------------|-------|
| | Min. | Max. |
| GaP Red  HDSP-81xE | | |
| N | 4.78 | 8.34 |
| P | 6.82 | 11.86 |
| Q | 9.7 | 16.61 |
| GaP Green  HDSP-81xG | | |
| P | 6.82 | 11.86 |
| Q | 9.7 | 16.61 |
| R | 13.6 | 23.74 |



Single Digit (HDSP-H3xx, HDSP-H5xx, HDSP-H8xx, HDSP-H1xx, HDSP-H2xx)

| Bin ID | Intensity (mcd) | |
|--------|-----------------|---------|
| | Min. | Max. |
| F | 1.276 | 1.660 |
| G | 1.661 | 2.160 |
| H | 2.161 | 2.800 |
| I | 2.801 | 3.640 |
| J | 3.641 | 4.730 |
| K | 4.731 | 6.150 |
| L | 6.151 | 7.990 |
| M | 7.991 | 10.400 |
| N | 10.401 | 13.500 |
| O | 13.501 | 17.550 |
| P | 17.551 | 22.800 |
| Q | 22.801 | 29.600 |
| R | 29.601 | 38.500 |
| S | 38.501 | 50.100 |
| T | 50.101 | 65.100 |
| U | 65.101 | 84.600 |
| V | 84.601 | 101.500 |
| W | 101.501 | 121.800 |
| X | 121.801 | 146.100 |
| Y | 146.101 | 175.300 |
| Z | 175.301 | 210.300 |



Iv Tolerance = ±15%

Surface Mount Seven-Segment Displays





10mm (0.28") Single Digit SMT Display

| Bin ID | Iv in mcd | |
|--|-----------|--------|
| | Min. | Max. |
| AllInGaP Green  HDSM-281H HDSM-283H | | |
| L | 3.401 | 5.400 |
| M | 5.401 | 8.600 |
| AllInGaP Red/Orange/Yellow  HDSM-281C/281L/281F HDSM-283C/283L/283F | | |
| L | 3.401 | 5.400 |
| M | 5.401 | 8.600 |
| N | 8.601 | 13.700 |
| InGaN Blue  HDSM-281B HDSM-283B | | |
| L | 3.401 | 5.400 |
| M | 5.401 | 8.600 |
| N | 8.601 | 13.700 |

10mm (0.28") Dual Digit SMT Display





| Bin ID | Iv in mcd | |
|---|-----------|--------|
| | Min. | Max. |
| AllInGaP Green  HDSM-291H HDSM-293H | | |
| L | 3.401 | 5.400 |
| M | 5.401 | 8.600 |
| GAInGaP Red/Orange/Yellow  HDSM-291C/291L/291F HDSM-293C/293L/293F | | |
| L | 3.401 | 5.400 |
| M | 5.401 | 8.600 |
| N | 8.601 | 13.700 |
| InGaN Blue  HDSM-291B HDSM-293B | | |
| L | 3.401 | 5.400 |
| M | 5.401 | 8.600 |
| N | 8.601 | 13.700 |

10mm (0.39") Single Digit SMT Display





| Bin ID | Iv in mcd | |
|---|-----------|--------|
| | Min. | Max. |
| AllInGaP Green  HDSM-431H HDSM-433H | | |
| M | 5.401 | 8.600 |
| N | 8.601 | 13.700 |
| P | 13.701 | 21.800 |
| AllInGaP Red/Yellow  HDSM-431C/431F HDSM-433C/433F | | |
| N | 8.601 | 13.700 |
| P | 13.701 | 21.800 |
| Q | 21.801 | 34.700 |
| AllInGaP Orange  HDSM-431L HDSM-433L | | |
| N | 8.601 | 13.700 |
| P | 13.701 | 21.800 |
| Q | 21.801 | 34.700 |
| R | 34.701 | 55.200 |
| InGaN Blue  HDSM-431B HDSM-433B | | |
| M | 5.401 | 8.600 |
| N | 8.601 | 13.700 |
| P | 13.701 | 21.800 |

Surface Mount Seven-Segment Displays
Luminous Intensity Categories (Typ.)





10mm (0.39") Dual Digit

| Bin ID | Customer Iv in mcd | |
|---|--------------------|--------|
| | Min. | Max. |
| AllInGaP Green  | | |
| HDSM-441H HDSM-443H | | |
| M | 5.401 | 8.600 |
| N | 8.601 | 13.700 |
| P | 13.701 | 21.800 |
| AllInGaP Red/Yellow  | | |
| HHDSM-441C/441F HDSM-443C/443F | | |
| N | 8.601 | 13.700 |
| P | 13.701 | 21.800 |
| Q | 21.801 | 34.700 |
| AllInGaP Orange  | | |
| HDSM-441L HDSM-443L | | |
| N | 8.601 | 13.700 |
| P | 13.701 | 21.800 |
| Q | 21.801 | 34.700 |
| R | 34.701 | 55.200 |
| InGaN Blue  | | |
| HDSM-441B HDSM-443B | | |
| M | 5.401 | 8.600 |
| N | 8.601 | 13.700 |
| P | 13.701 | 21.800 |

14.22mm (0.56") Single Digit

| Bin ID | Customer Iv in mcd | |
|--|--------------------|--------|
| | Min. | Max. |
| AllInGaP GreenN  | | |
| HDSM-531H HDSM-533H | | |
| M | 5.401 | 8.600 |
| N | 8.601 | 13.700 |
| AllInGaP Red  | | |
| HDSM-531C HDSM-533C | | |
| N | 8.601 | 13.700 |
| P | 13.701 | 21.800 |
| AllInGaP Orange/Yellow  | | |
| HDSM-531L/531F HDSM-533L/533F | | |
| N | 8.601 | 13.700 |
| P | 13.701 | 21.800 |
| Q | 21.801 | 34.700 |
| InGaN Blue  | | |
| HDSM-531B HDSM-533B | | |
| M | 5.401 | 8.600 |
| N | 8.601 | 13.700 |
| P | 13.701 | 21.800 |
| Q | 21.801 | 34.700 |

14.22mm (0.56") Dual Digit

| Bin ID | Customer Iv in mcd | |
|--|--------------------|--------|
| | Min. | Max. |
| AllInGaP Green  | | |
| HDSM-541H HDSM-543H | | |
| M | 5.401 | 8.600 |
| N | 8.601 | 13.700 |
| AllInGaP Red  | | |
| HDSM-541C HDSM-543C | | |
| N | 8.601 | 13.700 |
| P | 13.701 | 21.800 |
| AllInGaP Orange/Yellow  | | |
| HHDSM-541L/541F HDSM-543L/543F | | |
| N | 8.601 | 13.700 |
| P | 13.701 | 21.800 |
| Q | 21.801 | 34.700 |
| InGaN Blue  | | |
| HDSM-541B HDSM-543B | | |
| M | 5.401 | 8.600 |
| N | 8.601 | 13.700 |
| P | 13.701 | 21.800 |
| Q | 21.801 | 34.700 |

Through-hole Seven-Segment Displays—Leadframe Platform

7.6 mm (0.3") Micro Bright Displays Package Dimension

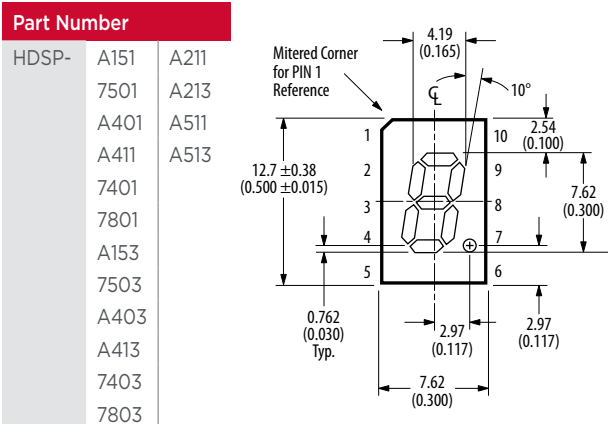

7.6 mm (0.3") Micro Bright Overflow Displays (Right Decimal Point) Package Dimension

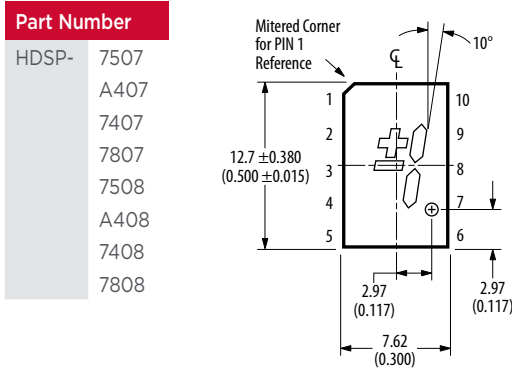

7.6 mm (0.3") Micro Bright Low Current Displays (Right Decimal Point) Package Dimension

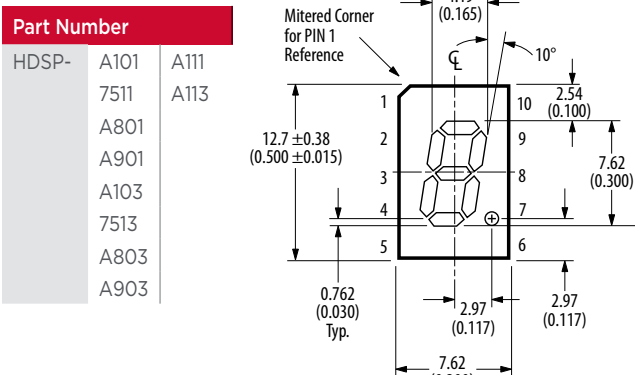

7.6 mm (0.3") Single Digit Displays Package Dimension

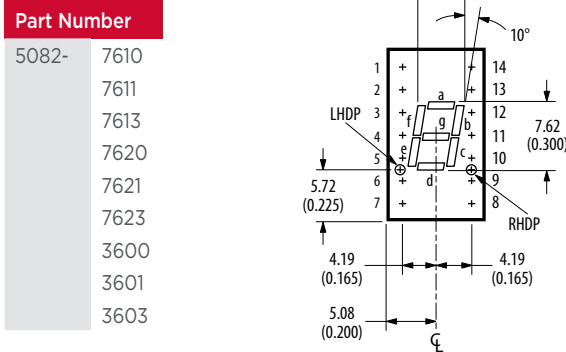

8 mm (0.31") Micro Bright Displays Package Dimension

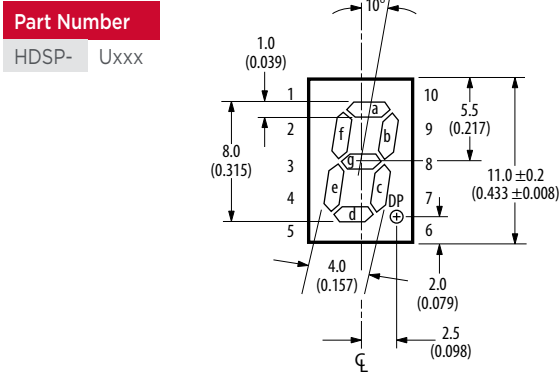

10 mm (0.4") Single Digit Displays (Right Decimal Point) Package Dimension

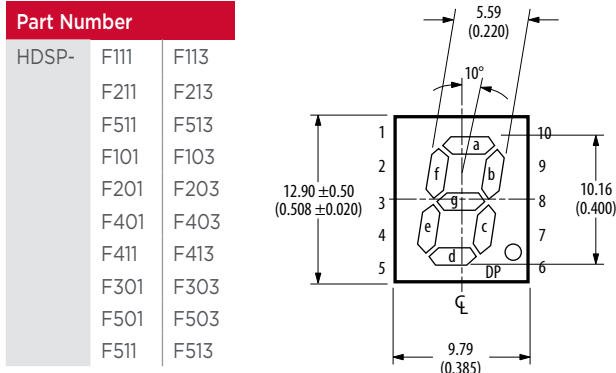

Note:
1. Dimensions in millimeters (inches).

Through-hole Seven-Segment Displays—Leadframe Platform

10 mm (0.4") Overflow Displays (Right Decimal Point) Package Dimension

| Part Number | | |
|-------------|------|------|
| HDSP- | F107 | F108 |
| | F207 | F208 |
| | F407 | F408 |
| | F307 | F308 |
| | F507 | F508 |

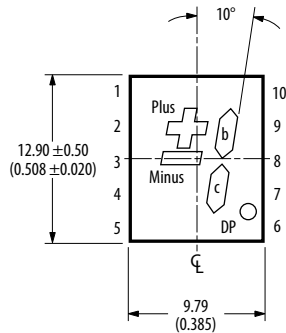

10.9 mm (0.43") Single Digit Displays (Right Decimal Point) Package Dimension

| Part Number | | |
|-------------|------|------|
| HDSP- | E101 | E103 |
| | 3351 | 3353 |
| 5082- | 7651 | 7653 |
| | 7661 | 7663 |
| | 4601 | 4603 |

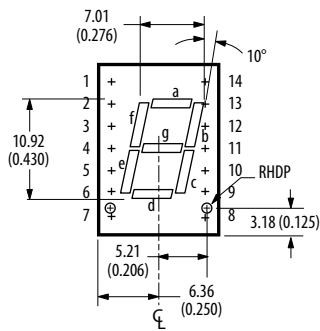

| Part Number | |
|-------------|------|
| 5802- | 7650 |
| | 7660 |
| | 4600 |

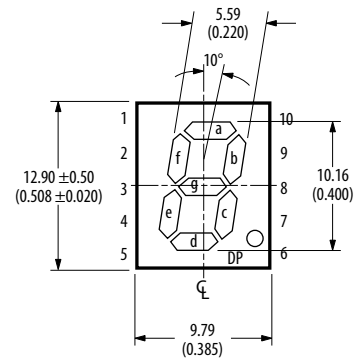

10.9 mm (0.43") Overflow Displays Package Dimension

| Part Number | | |
|-------------|------|------|
| HDSP- | 4606 | |
| 5082- | 7656 | 7666 |

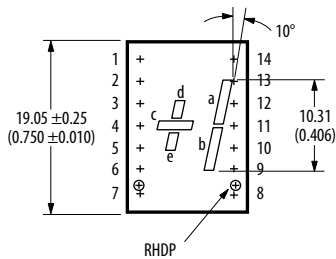

| Part Number | |
|-------------|------|
| HDSP- | 3356 |

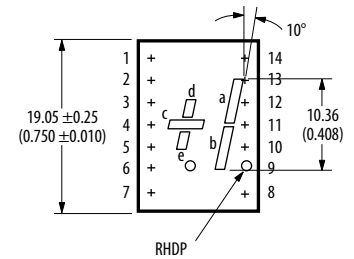

14.2 mm (0.56") Single Digit Displays (Right Decimal Point) Package Dimension

| Part Number | | |
|-------------|------|------|
| HDSP- | H111 | H211 |
| | H411 | H511 |
| | H113 | H213 |
| | H413 | H513 |
| | H101 | H103 |
| | H401 | H403 |
| | 5551 | 5553 |
| | 5501 | 5503 |
| | 5701 | 5703 |
| | 5601 | 5603 |

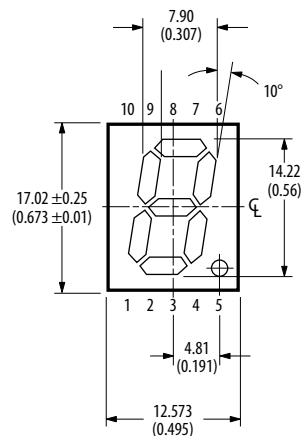

Note:
1. Dimensions in millimeters (inches).

Through-hole Seven-Segment Displays—Leadframe Platform

14.2 mm (0.56") Overflow Displays (Right Decimal Point) Package Dimension

| Part Number | | |
|-------------|------|------|
| HDSP- | H107 | H108 |
| | H407 | H408 |
| | 5557 | 5558 |
| | 5507 | 5508 |
| | 5707 | 5708 |
| | 5607 | 5608 |

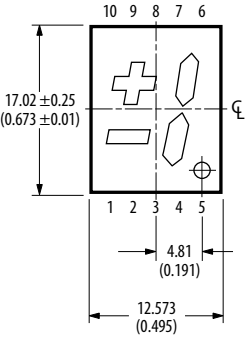

14.22 mm (0.56") Single Digit Displays Package Dimension

| Part Number | | |
|-------------|------|------|
| HDSP- | 51xE | 51xG |
| | 51xA | 51xY |

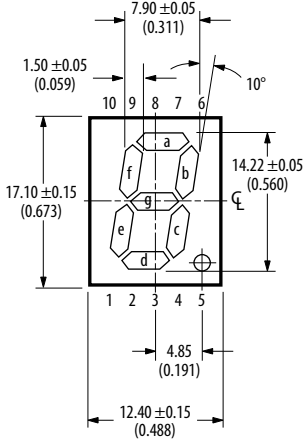

20 mm (0.8") Single Digit Displays Package Dimension

| Part Number | | |
|-------------|------|------|
| HDSP- | 3901 | 3903 |
| | 4201 | 4203 |
| | 8601 | 8603 |
| | N101 | N103 |
| | N401 | N403 |

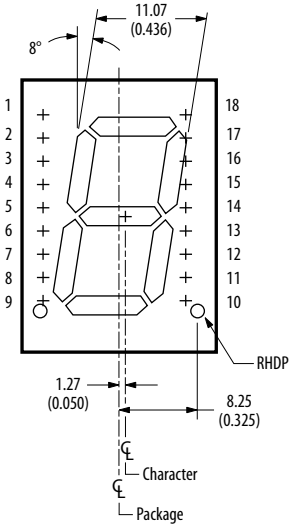

| Part Number | | |
|-------------|------|------|
| HDSP- | N105 | |
| | 3900 | 3905 |
| | 4200 | 4205 |
| | 8600 | 8605 |

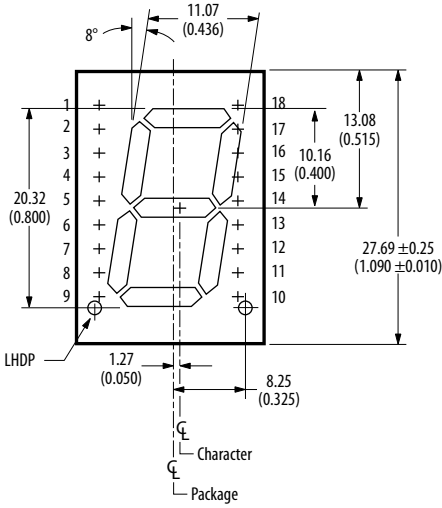

Through-hole Seven Segment Displays—PCB Platform

7.62 mm (0.3") Single Digit Displays Package Dimension

| Part Number | |
|-------------|------|
| HDSP- | 333E |
| | 333G |
| | 333A |

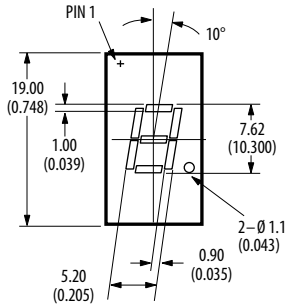

Note:
1. Dimensions in millimeters (inches).

Through-hole Seven-Segment Displays—PCB Platform

10 mm (0.4") Slim Font Single Digit Displays (Right Decimal Point) Package Dimension

| Part Number | | |
|-------------|------|------|
| HDSP- | 30xE | 30xG |
| | 30xA | 30xY |

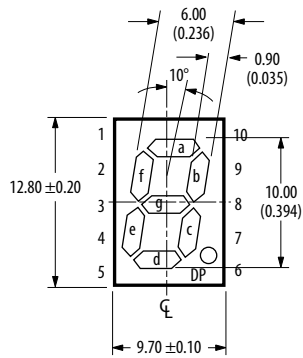

10.16 mm (0.4") Dual Digit Displays Package Dimension

| Part Number | | |
|-------------|------|------|
| HDSP- | G0xE | G0xG |
| | G0xA | G0xY |

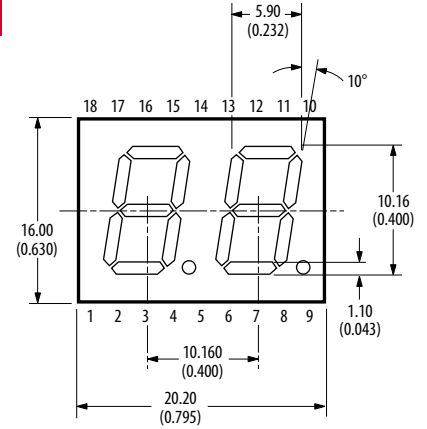

Through-hole Seven Segment Displays—PCB Platform

9.1mm (0.36") Single Digit Displays Package Dimension

| Part Number | | |
|-------------|------|------|
| HDSP- | C3A1 | |
| | C3A3 | |
| | C3E1 | |
| | C3E3 | |
| | H3A1 | |
| | H3A3 | |
| | H3E1 | |
| | H3E3 | |
| | H3L1 | |
| | H3L3 | |
| | H3G1 | H3G3 |

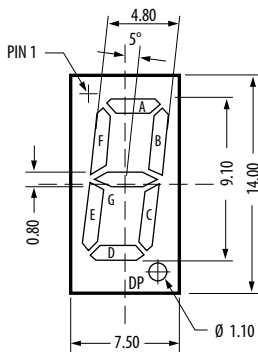

10.16 mm (0.4") Single Digit Displays Package Dimension

| Part Number | |
|-------------|------|
| HDSP- | 311E |
| | 311G |
| | 311A |
| | 311Y |

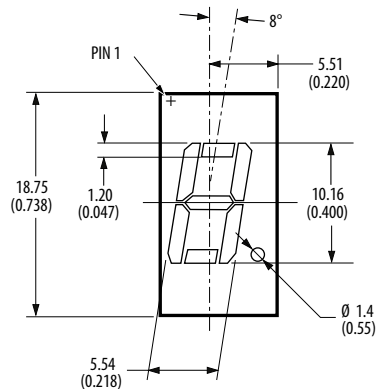

| Part Number | |
|-------------|------|
| HDSP- | 313E |
| | 313G |
| | 313A |
| | 313Y |

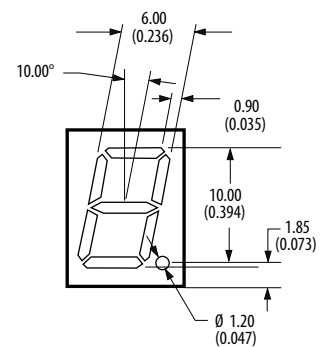

Note:
1. Dimensions in millimeters (inches).

Through-hole Seven Segment Displays—PCB Platform

13.1mm (0.52”) Single Digit Displays Package Dimension

| Part Number | |
|-------------|------|
| HDSP- | C5A1 |
| | C5A3 |
| | H5A1 |
| | H5A3 |
| | H5E1 |
| | H5E3 |
| | H5L1 |
| | H5L3 |
| | H5G1 |
| | H5G3 |

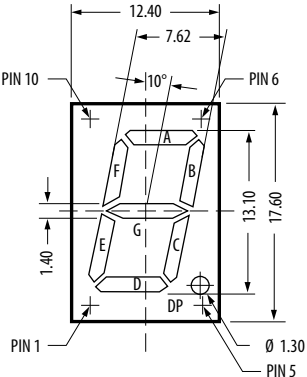

14.2 mm (0.56”) Dual Digit Displays Package Dimension

| Part Number | | |
|-------------|------|------|
| HDSP- | 52xA | 52xE |
| | 52xG | 52xY |

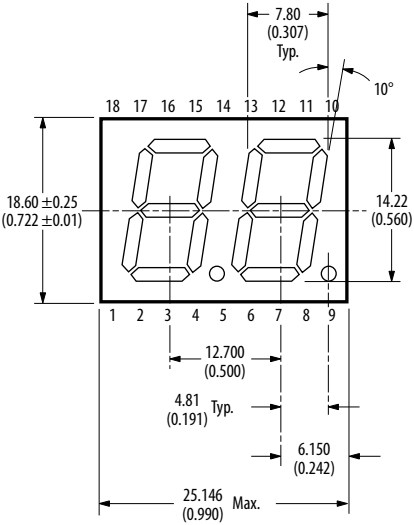

20 mm (0.8”) Single Digit Displays Package Dimension

| Part Number | | |
|-------------|------|------|
| HDSP- | 81xE | 81xG |

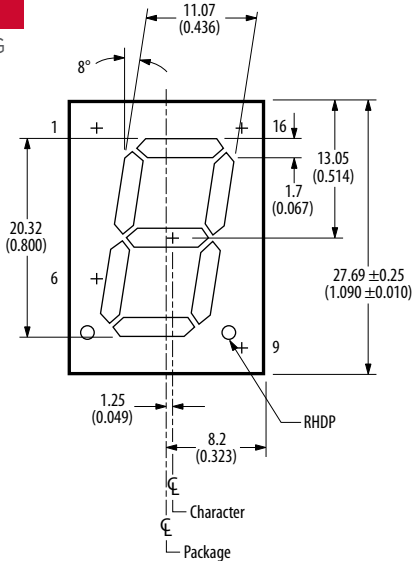

| Part Number | |
|-------------|------|
| HDSP- | C8A1 |
| | C8A3 |
| | C8E1 |
| | C8E3 |
| | C8L1 |
| | C8L3 |
| | C8G1 |
| | C8G3 |
| | H8A1 |
| | H8A3 |
| | H8E1 |
| | H8E3 |
| | H8L1 |
| | H8L3 |
| | H8G1 |
| | H8G3 |

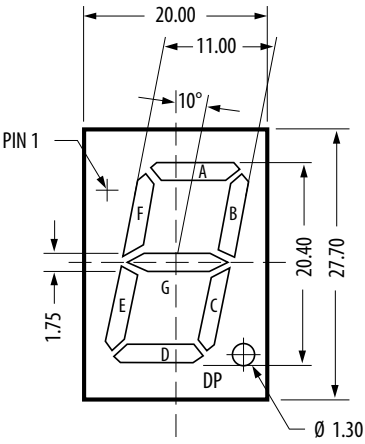

Note:
1. Dimensions in millimeters (inches).

Through-hole Seven Segment Displays—PCB Platform

25.4mm (1.0") Single Digit Displays Package Dimension

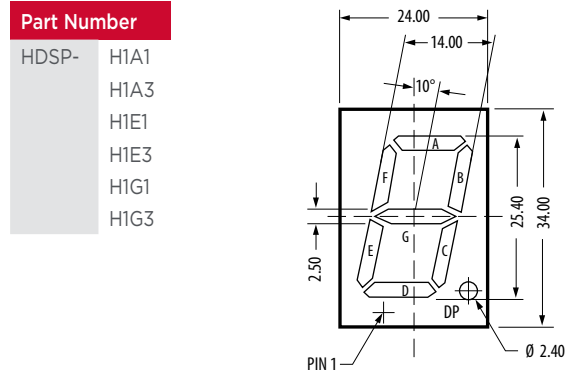

56.80mm (2.3") Single Digit Displays Package Dimension

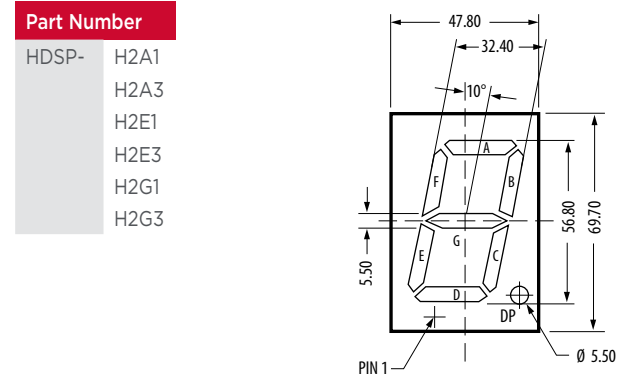

Note:
1. Dimensions in millimeters (inches).

Surface Mount Seven Segment Displays —PCB Platform

7.0mm (0.28”) Single Digit SMT Display Package Dimension

| Part Number | |
|-------------|------|
| HDSM- | 281C |
| | 281B |
| | 283B |
| | 283C |
| | 281H |
| | 283H |
| | 281F |
| | 283F |
| | 281L |
| | 283L |

10.0mm (0.39”) Dual Digit SMT Display Package Dimension

| Part Number | |
|-------------|------|
| HDSM- | 441C |
| | 441B |
| | 443B |
| | 441W |
| | 443W |
| | 443C |
| | 441H |
| | 443H |
| | 441F |
| | 443F |
| | 441L |
| | 443L |

7.0mm (0.28”) Dual Digit SMT Display Package Dimension

| Part Number | |
|-------------|------|
| HDSM- | 291C |
| | 291B |
| | 293B |
| | 293C |
| | 291H |
| | 293H |
| | 291F |
| | 293F |
| | 291L |
| | 293L |

10mm (0.39”) Single Digit SMT Display Package Dimension

| Part Number | |
|-------------|------|
| HDSM- | 431C |
| | 431B |
| | 433B |
| | 431W |
| | 433W |
| | 433C |
| | 431H |
| | 433H |
| | 431F |
| | 433F |
| | 431L |
| | 433L |

14.22mm (0.56”) Single Digit SMT Display Package Dimension

| Part Number | |
|-------------|------|
| HDSM- | 531C |
| | 531B |
| | 533B |
| | 531W |
| | 533W |
| | 533C |
| | 531H |
| | 533H |
| | 531F |
| | 533F |
| | 531L |
| | 533L |

14.22mm (0.56”) Dual Digit SMT Display Package Dimension

| Part Number | |
|-------------|------|
| HDSM- | 541C |
| | 541B |
| | 543B |
| | 541W |
| | 543W |
| | 543C |
| | 541H |
| | 543H |
| | 541F |
| | 543F |
| | 541L |
| | 543L |

Note:
1. Dimensions in millimeters (inches).

Light Bars and Bar Graph Arrays

Description — Light Bars

Light Bars are Broadcom's innovative solution to fixed message annunciator. They are used as annunciators that serve three customer functions: status indication, backlighting fixed messages and analog level indications (arrays). The Light Bars provide exceptional brightness at very low drive current for those applications where portability and battery backup are vital. These rectangular light sources are configured in single-inline and dual-in-line packages that contain either single or segmented light emitting areas. They are also X-Y stackable.

Benefits

- Large, bright, uniform light emitting surface
- Yellow and green categorized for dominant wavelength

Description — 10-Element Bar Graph Arrays

Broadcom's 10-Element Bar Graph Arrays serve a market need for analog level indication. LED reliability, light emitting viewability make them suitable in place of mechanical meters. They are designed to display information in easily recognizable bar graph form. The packages are end stackable and are therefore capable of displaying long strings of information. The bar graph arrays are precision matched for both intensity and wavelength, saving you the time and trouble of matching individual parts. The prealigned bar graph elements locked in a single package eliminates the task of matching and aligning individual LEDs during manufacturing, along with the risk of visually substandard front panels

- Low heat dissipation
- Choices of colors — Red, Green, Yellow
- Various package sizes are X-Y stackable
- Industry standard SIP and DIP packages

Applications

- Business machines
 - Point of sale bar code scanner
 - Electronic typewriters
 - Fax machines
 - Electronic scales
 - Postal meters
- Instrumentation
 - Process control system
 - Medical equipment
 - Machine control systems
 - Meters and status indicators
- Telecommunications
 - PBX systems
 - Modems

resulting from misaligned indicators. Each device offers easy-to-handle packages that are compatible with standard DIP sockets.

Benefits

- Exclusive package interlock
 - Facilitate end stacking alignment
- Large segment size
 - Wide viewing angle
- Available in Red, Green, Yellow and multicolor
- Wide variety of applications
- Categorized and packaged for luminous intensity
 - Greater uniformity of light output
- Matched LEDs for uniform appearance

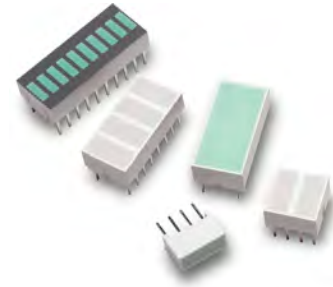

- Central switching systems
- Diagnostic equipment
- Short wave radios
- Transportation
 - Automotive dashboards
 - Truck and bus controls
 - Airport passenger metal detectors
 - Ticket vending machines
- Consumer
 - Appliance front panel
 - Hi-Fi/stereo equipment
 - Alarm system

Applications

- Instrumentation
 - Meters
 - Channel indicators
 - Status indicators
- Process control
 - Level indicators
- Appliances
 - Status of indication
 - Mode of operation
- Transportation
 - Tachometers
 - Fuel gauges
- Consumer products
 - VU meters (stereos)
 - Radio channel scanners
 - Burglar alarms

Light Bars

| Shape | Size/# Light Emitting | Part Number | Color | Chip (nm) Typ. | Vf (V) Typ. | Vf (V) at If = mA | Iv at If = mA | Iv Typ. (mcd) |
|--------|-----------------------|-------------|------------|----------------|-------------|-------------------|---------------|---------------|
| 0.4SIP | 0.35" x 0.15" 1 area | HLCP-A100 | AlGaAs Red | 637 | 1.8 | 20 | 3 | 7.5 |
| 0.4SIP | 0.35" x 0.15" 1 area | HLMP-2300 | GaP Red | 626 | 2 | 20 | 20 | 23 |
| 0.4SIP | 0.35" x 0.15" 1 area | HLMP-2400 | GaP Yellow | 585 | 2.1 | 20 | 20 | 20 |
| 0.4SIP | 0.35" x 0.15" 1 area | HLMP-2500 | GaP Green | 572 | 2.2 | 20 | 20 | 25 |
| 0.8SIP | 0.75" x 0.15" 1 area | HLCP-B100 | AlGaAs Red | 637 | 1.8 | 20 | 3 | 15 |
| 0.8SIP | 0.75" x 0.15" 1 area | HLMP-2350 | GaP Red | 626 | 2 | 20 | 20 | 45 |
| 0.8SIP | 0.75" x 0.15" 1 area | HLMP-2450 | GaP Yellow | 585 | 2.1 | 20 | 20 | 38 |
| 0.8SIP | 0.75" x 0.15" 1 area | HLMP-2550 | GaP Green | 572 | 2.2 | 20 | 20 | 50 |
| 0.4DIP | 0.35" x 0.35" 1 area | HLCP-C100 | AlGaAs Red | 637 | 1.8 | 20 | 3 | 15 |
| 0.4DIP | 0.35" x 0.35" 1 area | HLMP-2655 | GaP Red | 626 | 2 | 20 | 20 | 45 |
| 0.4DIP | 0.35" x 0.35" 1 area | HLMP-2755 | GaP Yellow | 585 | 2.1 | 20 | 20 | 38 |
| 0.4DIP | 0.35" x 0.35" 1 area | HLMP-2855 | GaP Green | 572 | 2.2 | 20 | 20 | 50 |
| 0.4DIP | 0.35" x 0.15" 2 areas | HLCP-D100 | AlGaAs Red | 637 | 1.8 | 20 | 3 | 7.5 |
| 0.4DIP | 0.35" x 0.15" 2 areas | HLMP-2600 | GaP Red | 626 | 2 | 20 | 20 | 23 |
| 0.4DIP | 0.35" x 0.15" 2 areas | HLMP-2700 | GaP Yellow | 585 | 2.1 | 20 | 20 | 20 |
| 0.4DIP | 0.35" x 0.15" 2 areas | HLMP-2800 | GaP Green | 572 | 2.1 | 20 | 20 | 25 |
| 0.8DIP | 0.35" x 0.15" 4 areas | HLCP-E100 | AlGaAs Red | 637 | 1.8 | 20 | 3 | 7.5 |
| 0.8DIP | 0.35" x 0.15" 4 areas | HLMP-2620 | GaP Red | 626 | 2 | 20 | 20 | 23 |
| 0.8DIP | 0.35" x 0.15" 4 areas | HLMP-2720 | GaP Yellow | 585 | 2.1 | 20 | 20 | 20 |
| 0.8DIP | 0.35" x 0.15" 4 areas | HLMP-2820 | GaP Green | 572 | 2.2 | 20 | 20 | 25 |
| 0.8DIP | 0.15" x 0.75" 2 areas | HLCP-F100 | AlGaAs Red | 637 | 1.8 | 20 | 3 | 15 |
| 0.8DIP | 0.15" x 0.75" 2 areas | HLMP-2635 | GaP Red | 626 | 2 | 20 | 20 | 45 |
| 0.8DIP | 0.15" x 0.75" 2 areas | HLMP-2735 | GaP Yellow | 585 | 2.1 | 20 | 20 | 38 |
| 0.8DIP | 0.15" x 0.75" 2 areas | HLMP-2835 | GaP Green | 572 | 2.2 | 20 | 20 | 50 |
| 0.8DIP | 0.35" x 0.35" 2 areas | HLCP-G100 | AlGaAs Red | 637 | 1.8 | 20 | 3 | 15 |
| 0.8DIP | 0.35" x 0.35" 2 areas | HLMP-2670 | GaP Red | 626 | 2 | 20 | 20 | 45 |
| 0.8DIP | 0.35" x 0.35" 2 areas | HLMP-2770 | GaP Yellow | 585 | 2.1 | 20 | 20 | 38 |
| 0.8DIP | 0.35" x 0.35" 2 areas | HLMP-2870 | GaP Green | 572 | 2.2 | 20 | 20 | 50 |
| 0.8DIP | 0.35" x 0.75" 1 areas | HLCP-H100 | AlGaAs Red | 637 | 1.8 | 20 | 3 | 30 |
| 0.8DIP | 0.35" x 0.75" 1 areas | HLMP-2685 | GaP Red | 626 | 2 | 20 | 20 | 80 |
| 0.8DIP | 0.35" x 0.75" 1 areas | HLMP-2785 | GaP Yellow | 585 | 2.1 | 20 | 20 | 70 |
| 0.8DIP | 0.35" x 0.75" 1 areas | HLMP-2885 | GaP Green | 572 | 2.2 | 20 | 20 | 100 |

Bicolor Light Bars







| Shape | Size/# Light Emitting | Part Number | Color | Chip (nm) Typ. | Vf (V) Typ. | Vf (V) at If = mA | Iv at If = mA | Iv Typ. (mcd) |
|--------|-----------------------|-------------|------------|----------------|-------------|-------------------|---------------|---------------|
| 0.4DIP | 0.35" x 0.35" 1 area | HLMP-2950 | GaP Red | 626 | 2 | 20 | 20 | 45 |
| | | | GaP Yellow | 585 | 2.1 | 20 | 20 | 38 |
| 0.4DIP | 0.35" x 0.35" 1 area | HLMP-2965 | GaP Red | 626 | 2 | 20 | 20 | 45 |
| | | | GaP Green | 572 | 2.2 | 20 | 20 | 50 |



Bar Graph Arrays

| | | | | | | | |
|---------------|-----------|------------|-----|-----|----|----|------|
| 10 Element | HLCP-J100 | AlGaAs Red | 637 | 1.6 | 1 | 1 | 1000 |
| | HDSP-4830 | GaP Red | 626 | 2.1 | 20 | 10 | 3500 |
| | HDSP-4840 | GaP Yellow | 585 | 2.2 | 20 | 10 | 1900 |
| | HDSP-4850 | GaP Green | 572 | 2.1 | 10 | 10 | 1900 |
| Multicolor LA | HDSP-4832 | GaP Red | 626 | 2.1 | 20 | 10 | 3500 |
| | | GaP Yellow | 585 | 2.2 | 20 | 10 | 1900 |
| | | GaP Green | 572 | 2.1 | 10 | 10 | 1900 |
| | | GaP Red | 626 | 2.1 | 20 | 10 | 3500 |
| | HDSP-4836 | GaP Yellow | 585 | 2.2 | 20 | 10 | 1900 |
| | | GaP Green | 572 | 2.1 | 10 | 10 | 1900 |
| | | GaP Yellow | 585 | 2.2 | 20 | 10 | 1900 |
| | | GaP Red | 626 | 2.1 | 20 | 10 | 3500 |





Luminous Intensity Categories

LED Light Bars





| Bin ID | Customer Iv in mcd | |
|--|--------------------|-------|
| | Min. | Max. |
| AlGaAs Red  | | |
| HLCP-A100 / D100 / E100 | | |
| GaP Red  | | |
| HLMP-2300 / 2600 / 2620 | | |
| B | 4.5 | 8.2 |
| C | 6.8 | 12.1 |
| D | 10.1 | 18.5 |
| E | 15.3 | 27.8 |
| F | 22.8 | 45.5 |
| AlGaAs Red  | | |
| HLCP-B100 / C100 / F100 / G100 | | |
| GaP Red  | | |
| HLMP-2350 / 2635 / 2655 / 2670 | | |
| B | 9.0 | 16.0 |
| C | 13.1 | 24.0 |
| D | 19.7 | 36.1 |
| E | 29.6 | 54.2 |
| F | 44.9 | 88.8 |
| AlGaAs Red  | | |
| HLCP-H100 | | |
| GaP Red  | | |
| HLMP-2685 | | |
| B | 18.0 | 27.1 |
| C | 22.0 | 40.8 |
| D | 33.3 | 61.1 |
| E | 50.0 | 91.8 |
| F | 75.1 | 150.0 |

| Bin ID | Customer Iv in mcd | |
|--|--------------------|-------|
| | Min. | Max. |
| GaP Yellow  | | |
| HLMP-2400 / 2700 / 2720 | | |
| E | 13.8 | 25.3 |
| F | 20.7 | 41.4 |
| HLMP-2450 / 2735 / 2755 / 2770 | | |
| E | 27.0 | 50.0 |
| F | 40.5 | 81.0 |
| HLMP-2785 | | |
| E | 54.0 | 99.0 |
| F | 81.0 | 162.0 |
| GaP Green  | | |
| HLMP-2500 / 2800 / 2820 | | |
| F | 18.9 | 37.8 |
| G | 30.6 | 61.2 |
| HLMP-2550 / 2835 / 2855 / 2870 | | |
| F | 38.1 | 76.2 |
| G | 61.6 | 123.2 |
| HLMP-2885 | | |
| F | 75.1 | 150.3 |
| G | 121.1 | 242.2 |

Bicolor Light Bars

| Bin ID | Customer Iv in mcd | |
|---|--------------------|--------|
| | Min. | Max. |
| HLMP-2950/GaP Red  | | |
| D | 17.00 | 31.00 |
| E | 25.40 | 46.50 |
| F | 38.10 | 76.20 |
| GaP Yellow  | | |
| D | 18.00 | 33.00 |
| E | 27.00 | 50.00 |
| F | 40.50 | 81.00 |
| HLMP-2965/GaP Red  | | |
| F | 44.90 | 88.80 |
| G | 71.90 | 143.80 |
| GaP Green  | | |
| F | 38.10 | 76.20 |
| G | 61.60 | 123.20 |

Bar Graph Arrays

| Bin ID | Customer Iv in mcd | |
|--|--------------------|------|
| | Min. | Max. |
| AlGaAs Red / HLCP-J100  | | |
| GaP Red / GaP Yellow / GaP Green    | | |
| HDSP-4830 / 4840 / 4850 | | |
| D | 0.61 | 1.11 |
| E | 0.91 | 1.67 |
| F | 1.37 | 2.51 |
| G | 2.05 | 3.76 |
| H | 3.08 | 5.64 |
| I | 4.62 | 8.64 |

Package Drawings

HLCP-A100
HLMP-2300/2400/2500

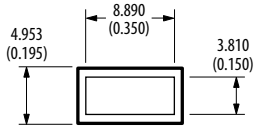

HLCP-B100
HLMP-2x50

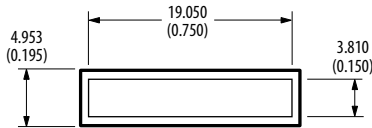

HLCP-C100
HLMP-2x55

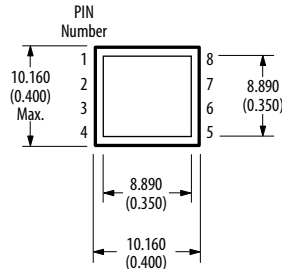

HLCP-D100
HLMP-2600/2700/2800

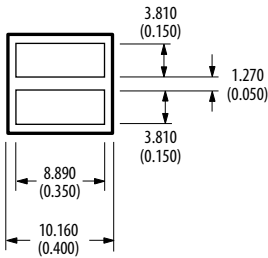

HLCP-E100
HLMP-2x20

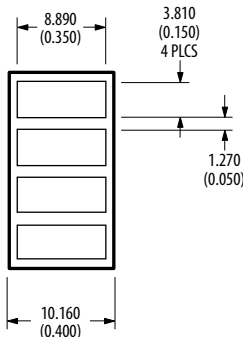

HLCP-F100
HLMP-2x35

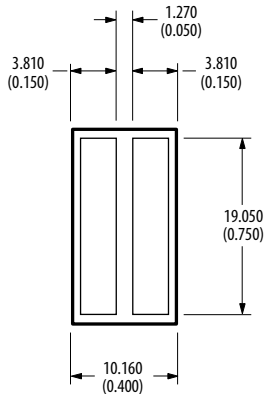

HLCP-G100
HLMP-2x70

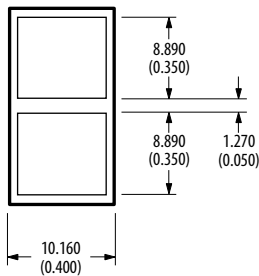

HLCP-H100
HLMP-2x85

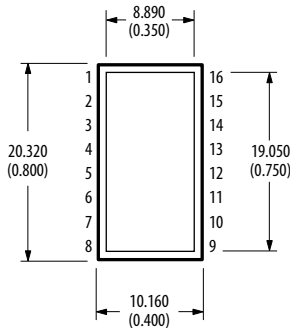

HLCP-J100
HDSP-48x0

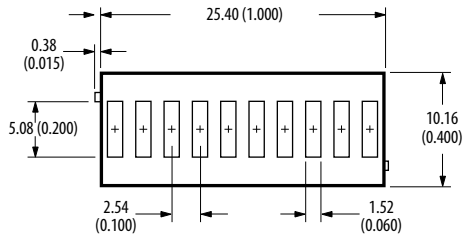

Note:
1. Dimensions in millimeters (inches).

Smart Displays

Description

Broadcom offers high quality Smart Displays to meet a wide range of applications and requirements. The Smart Displays are available in both serial and parallel interface and have an ASIC driver that greatly simplifies design efforts. The Smart Displays are LED technology-based and are extremely reliable with a long life expectancy. They are resistant to extreme weather conditions, and to mechanical vibration and shock, making them suitable for industrial applications where maintenance resources are scarce. They are also suitable for the consumer market where the need for aesthetics and product differentiation provides a competitive advantage to our customers' end products. Broadcom's Smart Display products are positioned to support high volume and cost-effective solutions.

Benefits

- Robust design for high reliability, longer life and hot and cold temperature operating capability
 - Ideally suited for outdoor, industrial and automotive applications
- Alphanumeric characters and custom icons for messaging
 - Useful for conveying operating modes, status, warning and error codes
- Ability to flash or blink
 - Catch user's attention
- ASIC LED driver
 - Simplified design interfacing reduces design cycle time

- Emissive display with brightness control
 - Ability to modify brightness for subdued light environment and total darkness
- Aesthetically pleasing
 - Distinctive display allows product differentiation



Applications

- Industrial Equipment
 - Industrial ovens, reliability test equipment, analytical instruments, process control equipment, test and measuring instruments, temperature controllers, programmable logic controllers, security systems
- Networking
 - Telecommunication equipment, answering machines, telephones, base stations, PBX modems, network cards
- Outdoor Signs
 - Petrol pump meters
- Consumer
 - Audio/video equipment, audio mixers, set top boxes, amplifiers, musical instruments, gaming machines, currency/coin counters, security systems
- Consumer "White Goods"
 - Displays for washing machine digital panels, cookers, freezers and dishwashers
- Medical Equipment
 - Hospital monitoring systems
- Transportation
 - Displays, radar detectors, avionics displays
- Computers and Peripherals
 - CPU speed indicator, printer front panels, fax machines, copy machines, power supply equipment, cash registers

Plastic Package, Serial Interface, 5 x 7 Dot Matrix Display with Custom Font Programmable

| Part Number | Character | Color | Interface | Character Height (mm) | Luminous Intensity Typ. (μcd) | Supply, Typ. (mA) |
|-------------|-----------|----------|-----------|-----------------------|--|-------------------|
| HCMS-2901 | 4 | Yellow | Serial | 3.7 | 180 | 132 |
| HCMS-2902 | 4 | Red | Serial | 3.7 | 270 | 132 |
| HCMS-2903 | 4 | Green | Serial | 3.7 | 270 | 132 |
| HCMS-2904 | 4 | Orange | Serial | 3.7 | 180 | 132 |
| HCMS-2905 | 4 | Deep Red | Serial | 3.7 | 590 | 145 |
| HCMS-2911 | 8 | Yellow | Serial | 3.7 | 180 | 264 |
| HCMS-2912 | 8 | Red | Serial | 3.7 | 270 | 264 |
| HCMS-2913 | 8 | Green | Serial | 3.7 | 270 | 264 |
| HCMS-2914 | 8 | Orange | Serial | 3.7 | 180 | 264 |
| HCMS-2915 | 8 | Deep Red | Serial | 3.7 | 590 | 290 |
| HCMS-2819 | 8 | Blue | Serial | 3.7 | 170 | 264 |
| HCMS-2921 | 16 | Yellow | Serial | 3.7 | 180 | 528 |
| HCMS-2922 | 16 | Red | Serial | 3.7 | 270 | 528 |
| HCMS-2923 | 16 | Green | Serial | 3.7 | 270 | 528 |
| HCMS-2924 | 16 | Orange | Serial | 3.7 | 180 | 528 |
| HCMS-2925 | 16 | Deep Red | Serial | 3.7 | 590 | 580 |
| HCMS-2961 | 4 | Yellow | Serial | 4.6 | 180 | 132 |
| HCMS-2962 | 4 | Red | Serial | 4.6 | 270 | 132 |
| HCMS-2963 | 4 | Green | Serial | 4.6 | 270 | 132 |
| HCMS-2964 | 4 | Orange | Serial | 4.6 | 180 | 132 |
| HCMS-2965 | 4 | Deep Red | Serial | 4.6 | 590 | 145 |
| HCMS-2971 | 8 | Yellow | Serial | 4.6 | 180 | 264 |
| HCMS-2972 | 8 | Red | Serial | 4.6 | 270 | 264 |
| HCMS-2973 | 8 | Green | Serial | 4.6 | 270 | 264 |
| HCMS-2974 | 8 | Orange | Serial | 4.6 | 180 | 264 |
| HCMS-2975 | 8 | Deep Red | Serial | 4.6 | 590 | 290 |
| HCMS-3901 | 4 | Yellow | Serial | 3.7 | 148 | 132 |
| HCMS-3902 | 4 | Red | Serial | 3.7 | 64 | 132 |
| HCMS-3903 | 4 | Green | Serial | 3.7 | 252 | 132 |
| HCMS-3904 | 4 | Orange | Serial | 3.7 | 64 | 132 |
| HCMS-3906 | 4 | Red | Serial | 3.7 | 1150 | 132 |
| HCMS-3907 | 4 | Green | Serial | 3.7 | 500 | 132 |
| HCMS-3911 | 8 | Yellow | Serial | 3.7 | 148 | 264 |
| HCMS-3912 | 8 | Red | Serial | 3.7 | 64 | 264 |
| HCMS-3913 | 8 | Green | Serial | 3.7 | 252 | 264 |
| HCMS-3914 | 8 | Orange | Serial | 3.7 | 64 | 264 |
| HCMS-3916 | 8 | Red | Serial | 3.7 | 1150 | 264 |
| HCMS-3917 | 8 | Green | Serial | 3.7 | 500 | 264 |
| HCMS-3961 | 4 | Yellow | Serial | 4.6 | 148 | 132 |
| HCMS-3962 | 4 | Red | Serial | 4.6 | 64 | 132 |
| HCMS-3963 | 4 | Green | Serial | 4.6 | 252 | 132 |
| HCMS-3964 | 4 | Orange | Serial | 4.6 | 64 | 132 |
| HCMS-3966 | 4 | Red | Serial | 4.6 | 1150 | 132 |
| HCMS-3967 | 4 | Green | Serial | 4.6 | 500 | 132 |
| HCMS-3971 | 8 | Yellow | Serial | 4.6 | 148 | 264 |
| HCMS-3972 | 8 | Red | Serial | 4.6 | 64 | 264 |
| HCMS-3973 | 8 | Green | Serial | 4.6 | 252 | 264 |
| HCMS-3974 | 8 | Orange | Serial | 4.6 | 64 | 264 |
| HCMS-3976 | 8 | Red | Serial | 4.6 | 1150 | 264 |
| HCMS-3977 | 8 | Green | Serial | 4.6 | 500 | 264 |

Notes:Typical values at $T_A = 25^\circ\text{C}$.Luminous intensity for one pixel at $V_{LED} = 5.0\text{ V}$, 50% peak pixel current, 100% pulse width.Supply current at $V_{LED} = 5.0\text{ V}$, 100% peak pixel current, 100% pulse width, 20 pixels per digit at all digit locations.

Plastic Package, Serial Interface, 5 x 7 Dot Matrix Display with Custom Font Programmable

| Part Number | Character | Color | Interface | Character Height (mm) | Luminous Intensity Typ. (μcd) | Supply, Typ. (mA) |
|-------------|-----------|----------|-----------|-----------------------|--|-------------------|
| HDLY-1414 | 4 | Yellow | Parallel | 3.6 | 3.7 | 110 |
| HDLO-1414 | 4 | Red | Parallel | 3.6 | 3.5 | 110 |
| HDLG-1414 | 4 | Green | Parallel | 3.6 | 5.6 | 110 |
| HDLA-1414 | 4 | Orange | Parallel | 3.6 | 3.5 | 110 |
| HDLU-1414 | 4 | Deep Red | Parallel | 3.6 | 3.1 | 34 |
| HDSL-1414 | 4 | Deep Red | Parallel | 3.6 | 12.7 | 125 |
| HDLY-2416 | 4 | Yellow | Parallel | 5.1 | 3.7 | 110 |
| HDLO-2416 | 4 | Red | Parallel | 5.1 | 3.5 | 110 |
| HDLG-2416 | 4 | Green | Parallel | 5.1 | 5.6 | 110 |
| HDLA-2416 | 4 | Orange | Parallel | 5.1 | 3.5 | 110 |
| HDLU-2416 | 4 | Deep Red | Parallel | 5.1 | 3.1 | 34 |
| HDSL-2416 | 4 | Deep Red | Parallel | 5.1 | 12.7 | 125 |
| HDLY-3416 | 4 | Yellow | Parallel | 6.9 | 3.7 | 110 |
| HDLO-3416 | 4 | Red | Parallel | 6.9 | 3.5 | 110 |
| HDLG-3416 | 4 | Green | Parallel | 6.9 | 5.6 | 110 |
| HDLA-3416 | 4 | Orange | Parallel | 6.9 | 3.5 | 110 |

Plastic Package, Parallel Interface, 8 Character, 5 x 7 Dot Matrix Display with 128 Character ASCII Decoder

| Part Number | Character | Color | Interface | Character Height (mm) | Luminous Intensity Typ. (μcd) | Supply, Typ. (mA) |
|-------------|-----------|----------|-----------|-----------------------|--|-------------------|
| HDSP-2530 | 8 | Orange | Parallel | 4.6 | 7.5 | 300 |
| HDSP-2531 | 8 | Yellow | Parallel | 4.6 | 7 | 300 |
| HDSP-2532 | 8 | Red | Parallel | 4.6 | 7.5 | 300 |
| HDSP-2533 | 8 | Green | Parallel | 4.6 | 7.5 | 300 |
| HDSP-2534 | 8 | Deep Red | Parallel | 4.6 | 15 | 330 |
| HDSP-2110 | 8 | Orange | Parallel | 4.8 | 7.5 | 300 |
| HDSP-2111 | 8 | Yellow | Parallel | 4.8 | 7.5 | 300 |
| HDSP-2112 | 8 | Red | Parallel | 4.8 | 7.5 | 300 |
| HDSP-2113 | 8 | Green | Parallel | 4.8 | 7.5 | 300 |
| HDSP-2107 | 8 | Deep Red | Parallel | 4.8 | 15 | 330 |
| HDSP-2500 | 8 | Orange | Parallel | 7.0 | 7.5 | 300 |
| HDSP-2501 | 8 | Yellow | Parallel | 7.0 | 7.5 | 300 |
| HDSP-2502 | 8 | Red | Parallel | 7.0 | 7.5 | 300 |
| HDSP-2503 | 8 | Green | Parallel | 7.0 | 7.5 | 300 |
| HDSP-2504 | 8 | Deep Red | Parallel | 7.0 | 1.5 | 330 |

Notes:

Typical values at $V_{DD} = 5.0V$, $T_A = 25^\circ\text{C}$.
 Luminous intensity at 100% full brightness, character average with “#” (20 pixels) displayed.
 Supply current at 100% brightness, with all character locations displaying “#” (20 pixels).

Glass/Ceramic Package, Parallel Interface, 8 Character, 5 x 7 Dot Matrix with 128 Character ASCII Decoder

| Part Number | Character | Color | Interface | Character Height (mm) | Luminous Intensity Typ. (μcd) | Supply Current Typ. (mA) |
|-------------|-----------|--------|-----------|-----------------------|--|--------------------------|
| HDSP-2131 | 8 | Yellow | Parallel | 4.8 | 7.5 | 300 |
| HDSP-2132 | 8 | Red | Parallel | 4.8 | 7.5 | 300 |
| HDSP-2133 | 8 | Green | Parallel | 4.8 | 7.5 | 300 |
| HDSP-2179 | 8 | Orange | Parallel | 4.8 | 7.5 | 300 |

Notes:

Typical values at $V_{DD} = 5.0\text{V}$, $T_A = 25^\circ\text{C}$.

Luminous intensity at 100% full brightness, character average with “#” (20 pixels) displayed.

Supply current at 100% brightness, with all character locations displaying “#” (20 pixels).

Glass/Ceramic Package, 4 x 7 Hexadecimal Display with Built-in BCD Decoder/Driver

| Part Number | Description/Decimal Point | Color | Operation Temperature ($^\circ\text{C}$) | Character Height (mm) | Luminous Intensity Typ. (μcd) | Supply Current Typ. (mA) |
|-------------|---------------------------|--------|--|-----------------------|--|--------------------------|
| HDSP-0760 | Numeric, RHDP | HER | -55 to 85 | 7.4 | 140 | 78 |
| HDSP-0761 | Numeric, LHDP | HER | -55 to 85 | 7.4 | 140 | 78 |
| HDSP-0762 | Hexadecimal | HER | -55 to 85 | 7.4 | 140 | 78 |
| HDSP-0770 | Numeric, RHDP | HER | -55 to 85 | 7.4 | 620 | 120 |
| HDSP-0771 | Numeric, LHDP | HER | -55 to 85 | 7.4 | 620 | 120 |
| HDSP-0772 | Hexadecimal | HER | -55 to 85 | 7.4 | 620 | 120 |
| HDSP-0781 | Numeric, RHDP | HER | -55 to 100 | 7.4 | 140 | 78 |
| HDSP-0782 | Numeric, LHDPi | HER | -55 to 100 | 7.4 | 140 | 78 |
| HDSP-0784 | Hexadecimal | HER | -55 to 100 | 7.4 | 140 | 78 |
| HDSP-0791 | Numeric, RHDP | HER | -55 to 100 | 7.4 | 620 | 120 |
| HDSP-0792 | Numeric, LHDP | HER | -55 to 100 | 7.4 | 620 | 120 |
| HDSP-0794 | Hexadecimal | HER | -55 to 100 | 7.4 | 620 | 120 |
| HDSP-0860 | Numeric, RHDP | Yellow | -55 to 85 | 7.4 | 490 | 120 |
| HDSP-0861 | Numeric, LHDP | Yellow | -55 to 85 | 7.4 | 490 | 120 |
| HDSP-0862 | Hexadecimal | Yellow | -55 to 85 | 7.4 | 490 | 120 |
| HDSP-0881 | Numeric, RHDP | Yellow | -55 to 100 | 7.4 | 490 | 120 |
| HDSP-0884 | Hexadecimal | Yellow | -55 to 100 | 7.4 | 490 | 120 |
| HDSP-0960 | Numeric, RHDP | Green | -55 to 85 | 7.4 | 1100 | 120 |
| HDSP-0961 | Numeric, LHDP | Green | -55 to 85 | 7.4 | 1100 | 120 |
| HDSP-0962 | Hexadecimal | Green | -55 to 85 | 7.4 | 1100 | 120 |
| HDSP-0981 | Numeric, RHDP | Green | -55 to 100 | 7.4 | 1100 | 120 |
| HDSP-0984 | Hexadecimal | Green | -55 to 100 | 7.4 | 1100 | 120 |

Notes:

Typical values at $V_{DD} = 5.0\text{V}$, $T_A = 25^\circ\text{C}$.

Luminous intensity per LED (Digit Average).

Supply current with “5” or “B” character displayed.

Glass/Ceramic Package Over Range \pm with Built-in BCD Decoder/Driver

| Part Number | Description/Decimal Point | Color | Operation Temperature ($^\circ\text{C}$) | Character Height (mm) | Luminous Intensity Typ. (μcd) | Supply Current Typ. (mA) |
|-------------|---------------------------|--------|--|-----------------------|--|--------------------------|
| HDSP-0763 | Overrange \pm 1 | HER | -55 to 85 | 7.4 | 140 | 11.2 |
| HDSP-0863 | Overrange \pm 1 | Yellow | -55 to 85 | 7.4 | 490 | 32 |
| HDSP-0963 | Overrange \pm 1 | Green | -55 to 85 | 7.4 | 1100 | 32 |
| HDPS-0783 | Overage \pm 1 | HER | -55 to 100 | 7.4 | 140 | 11.2 |
| HDPS-0883 | Overage \pm 1 | Yellow | -55 to 100 | 7.4 | 490 | 32 |
| HPDS-0983 | Overage \pm 1 | Green | -55 to 100 | 7.4 | 1100 | 32 |

Notes:

Typical values at $V_{DD} = 5.0\text{V}$, $T_A = 25^\circ\text{C}$.

Luminous intensity per LED (Digit Average).

Glass/Ceramic Package, Serial Interface, 4 character, 5 x 7 Dot Matrix with 128 Character ASCII Decoder

| Part Number | Character | Color | Interface | Character Height (mm) | Luminous Intensity Typ. (μcd) | Supply Current Typ. (mA) |
|-------------|-----------|--------|-----------|-----------------------|--|--------------------------|
| HCMS-2351 | 4 | Yellow | Serial | 4.9 | 3400 | 6.2 |
| HCMS-2353 | 4 | Green | Serial | 4.9 | 3000 | 6.2 |

Notes:

Typical values at $V_{DD} = 5.0\text{V}$, $T_A = 25^\circ\text{C}$.

Luminous intensity (peak) per LED (Digit Average).

Package Drawings

HCMS-290x/HCMS-390x

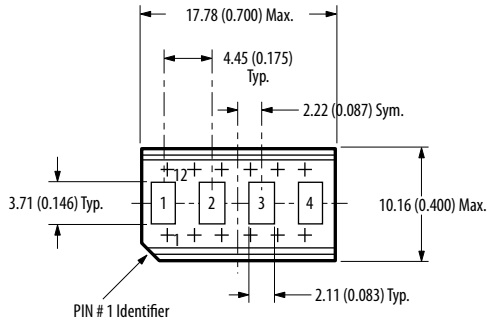

HCMS-291x/HCMS-391x

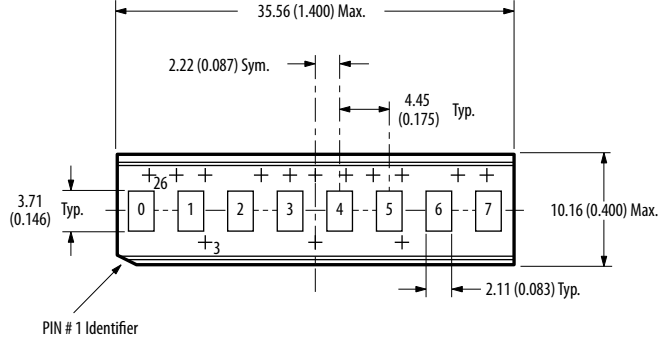

HCMS-296x/HCMS-396x

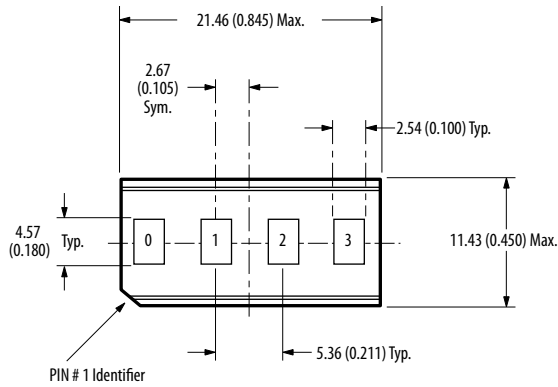

HCMS-297x/HCMS-397x

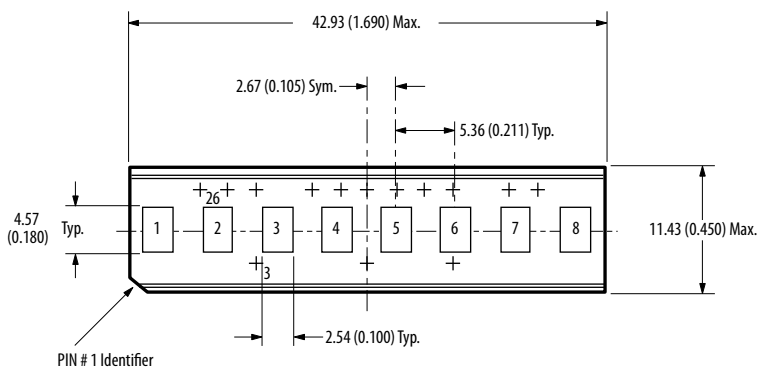

HCMS-292x

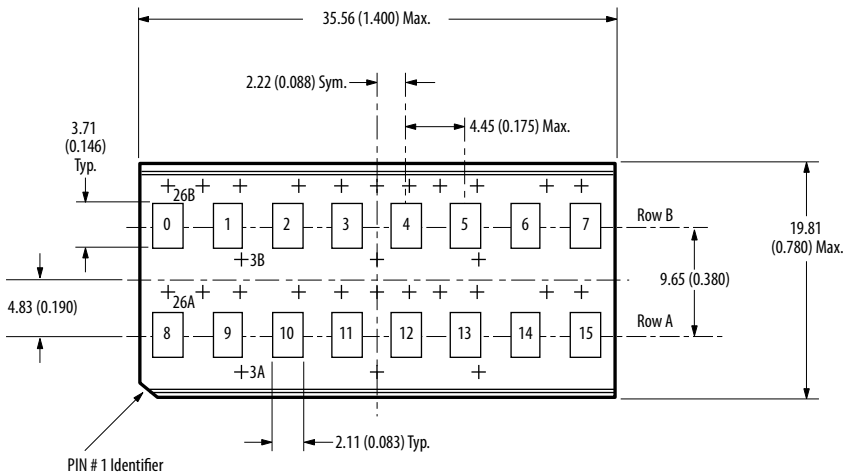

Note:
1. Dimensions in millimeters (inches).

HDSP-253x

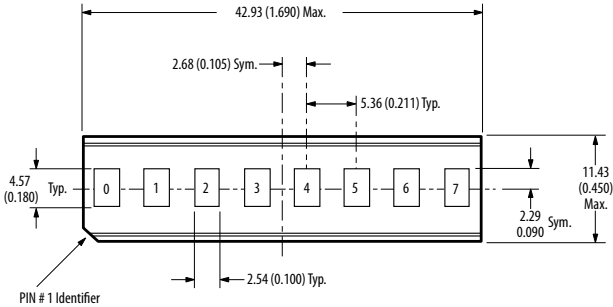

HDSP-2107, -211x

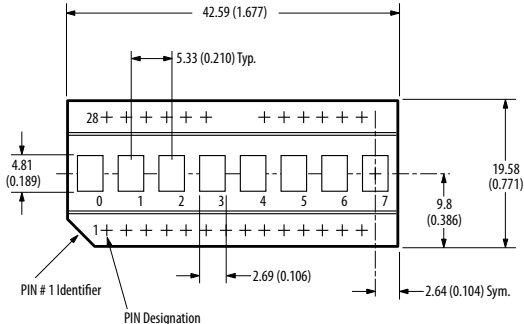

HDSP-250x

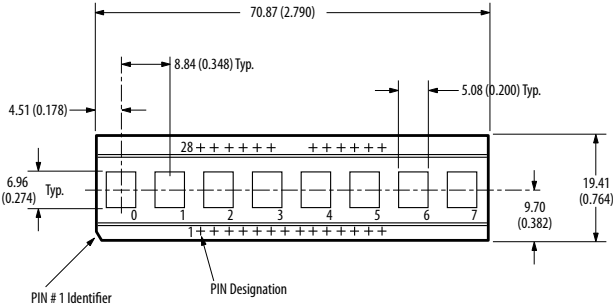

HDLx-2416

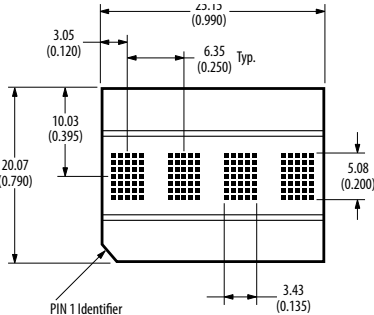

HDSP-213x, -2179

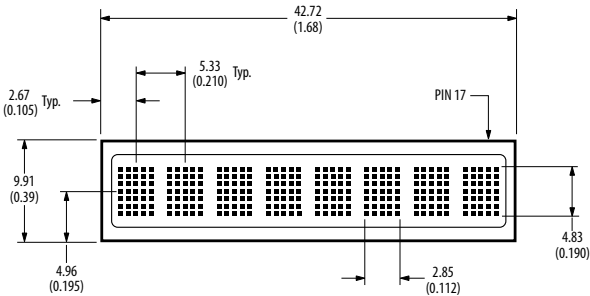

HDLx-1414

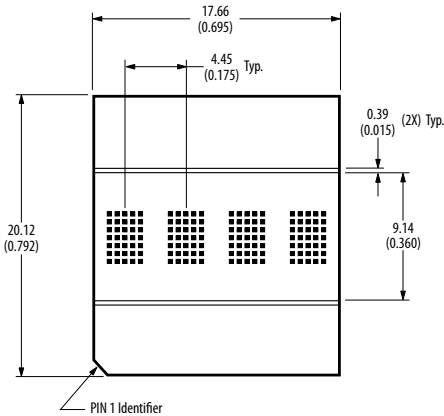

- Notes:
1. Dimensions in millimeters (inches).
 2. Digit center line is $\pm 0.38\text{MM}$ (± 0.015 inch) from package center line.
 3. Unless otherwise specified, the tolerance on all dimensions is $\pm 0.38\text{MM}$ (± 0.015 inch).

Package Drawings

HDLx-3416

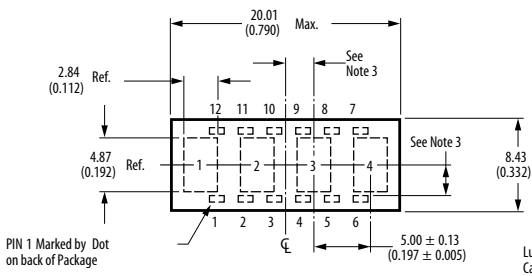
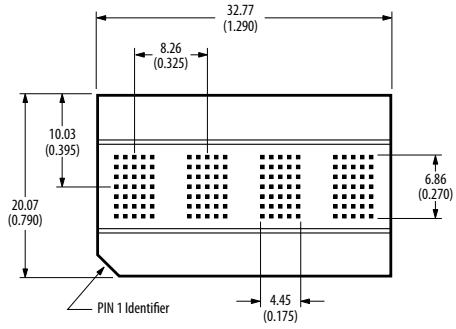

Luminous Intensity Category

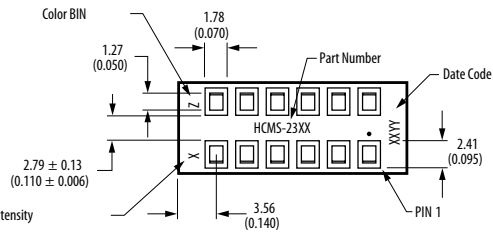

Note:
1. Dimensions in millimeters (inches).

HDSP-Ox81, HDSP-0791, HDSP-Ox60, HDSP-0770

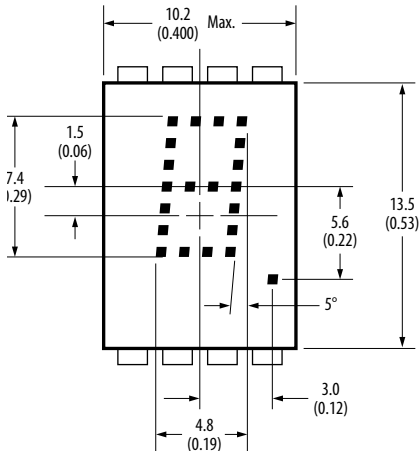

HDSP-Ox82, HDPS-0792, HDSP-Ox61, HDPS-0771

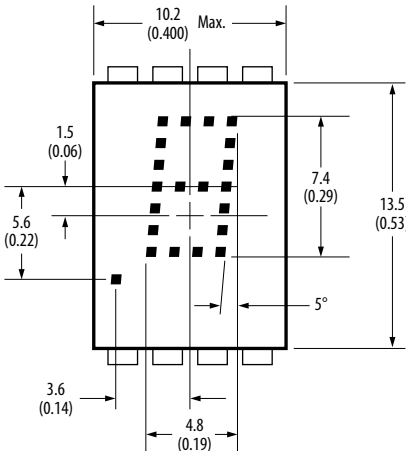

HDSP-Ox84, HDSP-0794, HDSP-Ox63

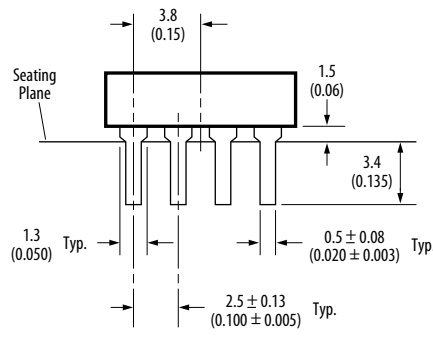
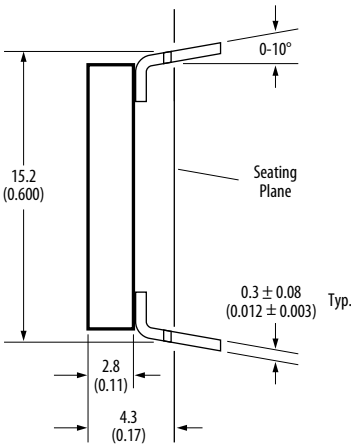
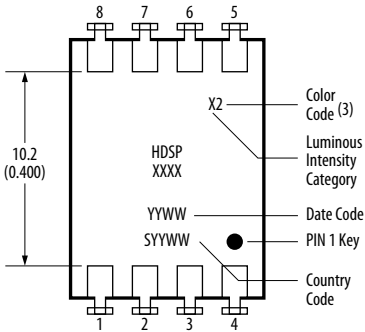
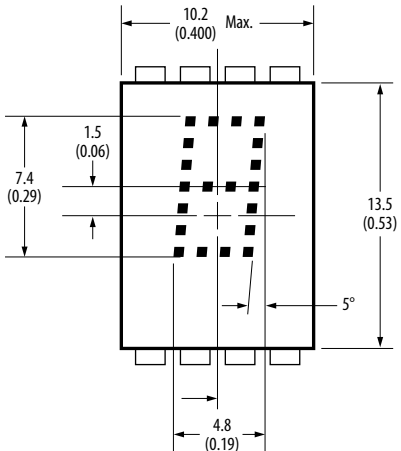

HDSP-Ox83, HDSP-Ox62, 0772

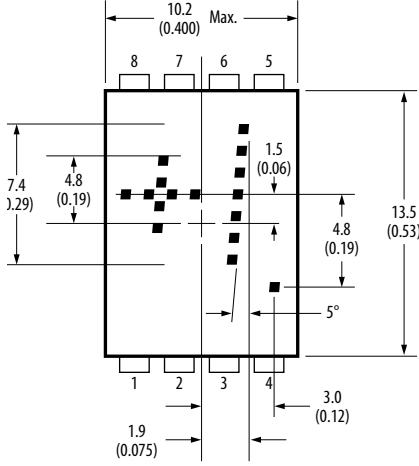

Notes:
 1. Dimensions in millimeters (inches).
 2. Digit center line is ±0.38MM (±0.015 inch) from package center line.
 3. Unless otherwise specified, the tolerance on all dimensions is ±0.38MM (±0.015 inch).

Connecting everything®



Broadcom Inc. is a diversified global semiconductor leader built on 50 years of innovation, collaboration and engineering excellence.

Broadcom's extensive product portfolio serves multiple applications within four primary end markets: wired infrastructure, wireless communications, enterprise storage and industrial & others. Applications for our products in these end markets include: data center networking, home connectivity, broadband access, telecommunications equipment, smartphones and base stations, data center servers and storage, factory automation, power generation and alternative energy systems, and displays.

Broadcom combines global scale, engineering depth, broad product portfolio diversity and superior execution and operational focus to deliver category-leading connectivity products so its customers can build and grow successful businesses today and in the future.

X-ON Electronics

Largest Supplier of Electrical and Electronic Components

Click to view similar products for [Standard LEDs - Through Hole category](#):

Click to view products by [Avago manufacturer](#):

Other Similar products are found below :

[LTL-10254W](#) [LTL-1214A](#) [LTL-1BEDJ](#) [LTL-2231AT](#) [LTL-3251A](#) [LTL-4262N](#) [LTL-5234](#) [LTL87HTBK](#) [LTL-87HD4B](#) [7383/V7C3-BSTA-L/PR3/MS](#) [HLMP-AG64-X10ZZ](#) [HLMP-EG1A-Z10DV](#) [HLMP-EL3B-WXKDD](#) [HLMP-HB74-UVBDD](#) [HLMP-HG65-VY0DD](#) [HLMP-HM74-34CDD](#) [HLMP-HM75-34CDD](#) [1L0532V23G0TD001](#) [NSPW500CS](#) [C4SMA-BGF-CQ34Q3C2](#) [L53GC13](#) [264-7SURTS530-A3](#) [L-C150JRCT](#) [S4SMS-BJF-CQ42QGF2](#) [S4SMS-GJF-CW12QMF2](#) [LD CQDP-1U3U-W5-1-K](#) [LO566UHR3-70G-A3](#) [SLA560WBD2PT3](#) [LP379PPG1C0G0300001](#) [SLR-322MCT32](#) [SLR-342DUT32](#) [SLR-342MC3F](#) [SLR343BC7TT32](#) [SLR343BCTT32](#) [SLX-LX3044GD](#) [SLX-LX3044ID](#) [SLX-LX3044YD](#) [1.90690.3330000](#) [SSL-LX20483ID](#) [SSL-LX3034YD](#) [SSL-LX5093LGT-11](#) [SSL-LX5093PGC](#) [SSL-LX5093SRC/F](#) [SSL-LX5093SYT](#) [SSL-LX509E3SIT](#) [SSL-LX509FT3ID](#) [SSL-LX50FT3GD](#) [SSS-LX4673ID-410B](#) [1L0532Y24I0TD001](#) [264-7SYGD/S530-E2](#)