

# Thin-Film Directional Couplers



## CP0402 High Directivity LGA Termination

### GENERAL DESCRIPTION

#### ITF (Integrated Thin-Film) TECHNOLOGY

The ITF High Directivity LGA Coupler is based on thin-film multilayer technology. The technology provides a miniature part with excellent high frequency performance and rugged construction for reliable automatic assembly.

The ITF Coupler is offered in a variety of frequency bands compatible with various types of high frequency wireless systems.

### APPLICATIONS

- Mobile Communications
- Satellite TV Receivers
- GPS
- Vehicle Location Systems
- Wireless LAN's

### FEATURES

- Inherent Low Profile
- Self Alignment during Reflow
- Excellent Solderability
- Low Parasitics
- Better Heat Dissipation
- Operating/Storage Temp -40°C to +85°C
- Power Rating 3W RF Cont

### DIMENSIONS: (Bottom View)

millimeters (inches)

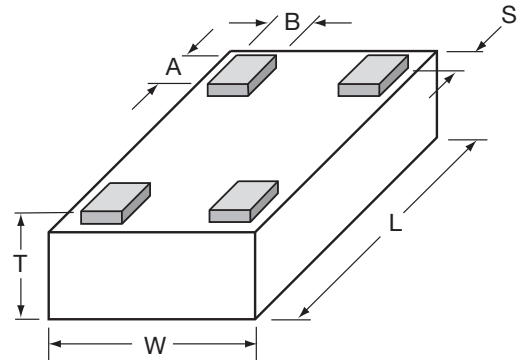

L	1.00±0.05 (0.040±0.002)
W	0.58±0.04 (0.023±0.002)
T	0.35±0.05 (0.014±0.002)

A	0.20±0.05 (0.008±0.002)
B	0.18±0.05 (0.007±0.002)
S	0.05±0.05 (0.002±0.002)

### HOW TO ORDER

<b>CP</b> T <b>Style</b> Directional Coupler	<b>0402</b> T <b>Size</b> 0402	<b>X</b> T <b>Type</b>	<b>****</b> T <b>Frequency</b> (MHz)	<b>X</b> T <b>Sub Type</b>	<b>N</b> T <b>LGA Termination</b> L = LGA Sn90, Pb10 **N = LGA Sn100	<b>TR</b> T <b>Packaging Code</b> TR = Tape and Reel
---	---	------------------------------	---	----------------------------------	--	---

\*\*RoHS compliant

### QUALITY INSPECTION

Finished parts are 100% tested for electrical parameters and visual characteristics. Each production lot is evaluated on a sample basis for:

- Static Humidity: 85°C, 85% RH, 160 hours
- Endurance: 125°C, I<sub>R</sub>, 4 hours

### TERMINATION

Sn90Pb10 or Lead-Free Sn100 Nickel/Solder coating compatible with automatic soldering technologies: reflow, wave soldering, vapor phase and manual.

### ORIENTATION IN TAPE

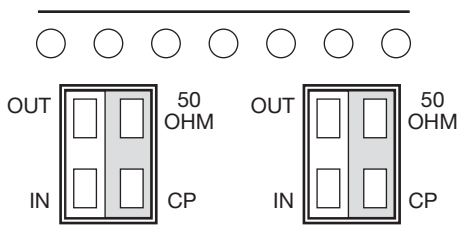

### TERMINALS (Top View)

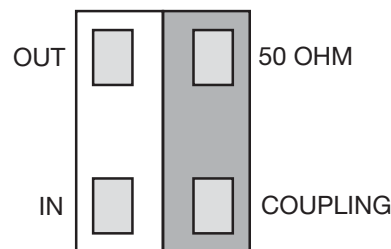

Not RoHS Compliant



*For RoHS compliant products, please select correct termination style.*

### Recommended Pad Layout Dimensions

mm (inches)

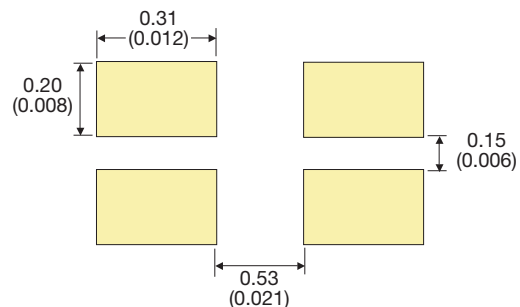

\*The recommended distance to the PCB Ground Plane is 0.254mm (0.010")



# Thin-Film Directional Couplers



## CP0402 High Directivity LGA Termination

### CP0402 - TYPE SELECTION CHART

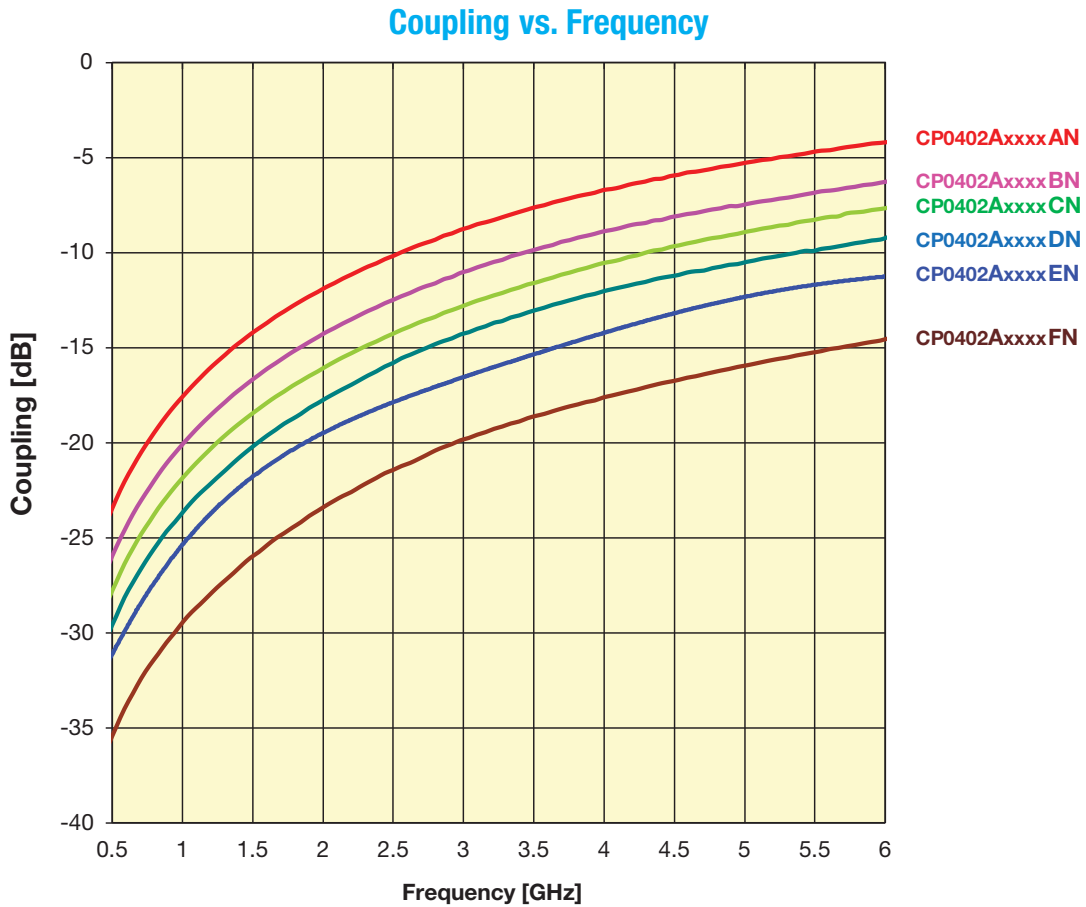

Intermediate coupling factors are readily available.  
Please contact factory.

# Thin-Film Directional Couplers



## CP0402 High Directivity LGA Termination

Coupler P/N CP0402AxxxxAN

Application	P/N Examples*	Frequency Band [MHz]	Coupling [dB]	I. Loss max. [dB]	Return Loss [dB]	Directivity [dB]	
AMPS	CP0402A0836AN	824 - 849	19.10	0.25	32	21	
	CP0402A0881AN	869 - 894	18.60	0.25	31		
GSM	CP0402A0902AN	890 - 915	18.50	0.25	31		
	CP0402A0947AN	935 - 960	18.00	0.25	31		
E-GSM	CP0402A0897AN	880 ÷ 915	18.50	0.25	31		
	CP0402A0942AN	925 ÷ 960	18.00	0.25	31		
PDC	CP0402A1441AN	1429 - 1453	14.50	0.40	28		
PCN	CP0402A1747AN	1710 - 1785	13.00	0.50	26		
	CP0402A1842AN	1805 - 1880	12.50	0.50	26		
PCS	CP0402A1880AN	1850 - 1910	12.30	0.50	25		
	CP0402A1960AN	1930 - 1990	12.00	0.50	25		
PHP	CP0402A1907AN	1895 - 1920	12.30	0.50	25		
DECT	CP0402A1890AN	1880 - 1900	12.30	0.50	25		
Wireless LAN	CP0402A2442AN	2400 - 2484	10.30	0.70	23		
WiFi	CP0402A3500AN	3450 - 3550	7.60	1.30	15		14
	CP0402A5000AN	4950 - 5050	5.00	1.50	15		13
	CP0402A5500AN	5450 - 5550	4.60	1.50	14	13	
	CP0402A6000AN	5950 - 6050	4.00	1.50	14	13	

CP0402AxxxxANTR

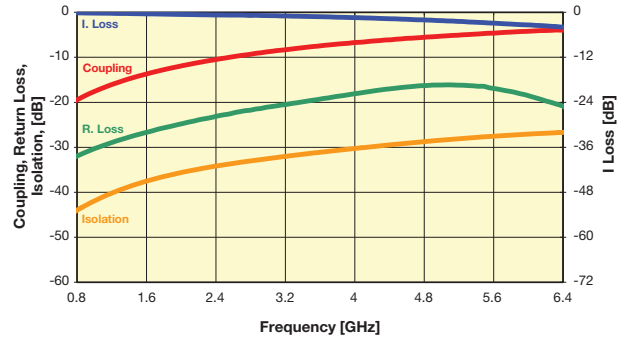

Coupler P/N CP0402AxxxxBN

Application	P/N Examples	Frequency Band [MHz]	Coupling [dB]	I. Loss max. [dB]	Return Loss [dB]	Directivity [dB]	
AMPS	CP0402A0836BN	824 - 849	22.00	0.20	28	27	
	CP0402A0881BN	869 - 894	21.70	0.20	28		
GSM	CP0402A0902BN	890 - 915	21.50	0.20	28		
	CP0402A0947BN	935 - 960	21.00	0.25	27		
E-GSM	CP0402A0897BN	880 ÷ 915	21.50	0.20	28		
	CP0402A0942BN	925 ÷ 960	21.00	0.25	27		
PDC	CP0402A1441BN	1429 - 1453	17.50	0.25	24		
PCN	CP0402A1747BN	1710 - 1785	16.00	0.30	23		
	CP0402A1842BN	1805 - 1880	15.50	0.35	23		
PCS	CP0402A1880BN	1850 - 1910	15.50	0.35	23		
	CP0402A1960BN	1930 - 1990	15.00	0.35	22		
PHP	CP0402A1907BN	1895 - 1920	15.50	0.35	23		
DECT	CP0402A1890BN	1880 - 1900	15.50	0.35	23		
Wireless LAN	CP0402A2442BN	2400 - 2484	13.30	0.40	21		
WiFi	CP0402A3500BN	3450 - 3550	9.40	0.80	18		14
	CP0402A5000BN	4950 - 5050	7.40	1.20	14		13
	CP0402A5500BN	5450 - 5550	6.70	1.60	14	13	
	CP0402A6000BN	5950 - 6050	6.10	2.00	14	13	

CP0402AxxxxBNTR

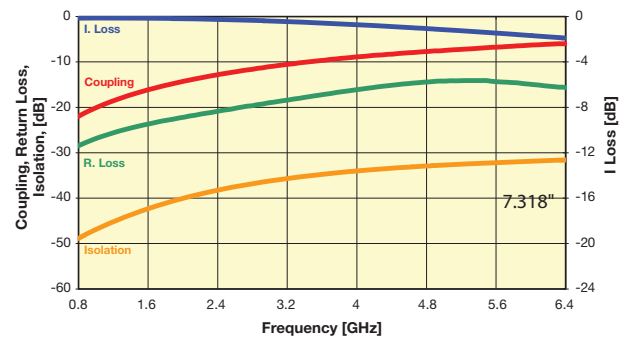

Coupler P/N CP0402AxxxxCN

Application	P/N Examples	Frequency Band [MHz]	Coupling [dB]	I. Loss max. [dB]	Return Loss [dB]	Directivity [dB]	
AMPS	CP0402A0836CN	824 - 849	23.60	0.20	33	22	
	CP0402A0881CN	869 - 894	23.00	0.20	33		
GSM	CP0402A0902CN	890 - 915	23.00	0.20	26		
	CP0402A0947CN	935 - 960	22.50	0.20	33		
E-GSM	CP0402A0897CN	880 ÷ 915	23.00	0.20	25		
	CP0402A0942CN	925 ÷ 960	22.50	0.20	32		
PDC	CP0402A1441CN	1429 - 1453	19.00	0.25	31		
PCN	CP0402A1747CN	1710 - 1785	17.20	0.25	30		
	CP0402A1842CN	1805 - 1880	17.00	0.25	30		
PCS	CP0402A1880CN	1850 - 1910	16.80	0.25	30		
	CP0402A1960CN	1930 - 1990	16.50	0.25	29		
PHP	CP0402A1907CN	1895 - 1920	16.80	0.25	29		
DECT	CP0402A1890CN	1880 - 1900	16.80	0.25	30		
Wireless LAN	CP0402A2442CN	2400 - 2484	14.70	0.45	28		
WiFi	CP0402A3500CN	3450 - 3550	10.97	0.67	23		17
	CP0402A5000CN	4950 - 5050	8.00	1.00	21		16
	CP0402A5500CN	5450 - 5550	7.50	1.10	21	15	
	CP0402A6000CN	5950 - 6050	7.10	1.30	23	15	

CP0402AxxxxCNTR

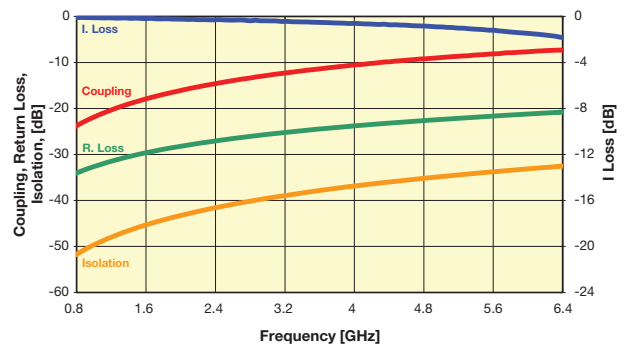

Important: Couplers can be used at any frequency within the indicated range.



# Thin-Film Directional Couplers



## CP0402 High Directivity LGA Termination

Coupler P/N CP0402AxxxxDN

Application	P/N Examples*	Frequency Band [MHz]	Coupling [dB]	I. Loss max. [dB]	Return Loss [dB]	Directivity [dB]	
AMPS	CP0402A0836DN	824 - 849	25.20	0.20	29	20	
	CP0402A0881DN	869 - 894	24.80	0.20	28		
GSM	CP0402A0902DN	890 - 915	24.70	0.20	28		
	CP0402A0947DN	935 - 960	24.10	0.20	28		
E-GSM	CP0402A0897DN	880 ÷ 915	24.70	0.20	28		
	CP0402A0942DN	925 ÷ 960	24.10	0.20	28		
PDC	CP0402A1441DN	1429 - 1453	20.50	0.20	25		18
PCN	CP0402A1747DN	1710 - 1785	19.00	0.20	24		
	CP0402A1842DN	1805 - 1880	18.50	0.25	23		
PCS	CP0402A1880DN	1850 - 1910	18.20	0.25	23		
	CP0402A1960DN	1930 - 1990	18.00	0.25	23		
PHP	CP0402A1907DN	1895 - 1920	18.10	0.25	23		
DECT	CP0402A1890DN	1880 - 1900	18.20	0.25	23		
Wireless LAN	CP0402A2442DN	2400 - 2484	16.00	0.35	22		
WiFi	CP0402A3500DN	3450 - 3550	12.50	0.46	21	17	
	CP0402A5000DN	4950 - 5050	10.00	0.65	21	16	
	CP0402A5500DN	5450 - 5550	9.60	0.76	20	15	
	CP0402A6000DN	5950 - 6050	9.10	0.84	20	15	

CP0402AxxxxDNTR

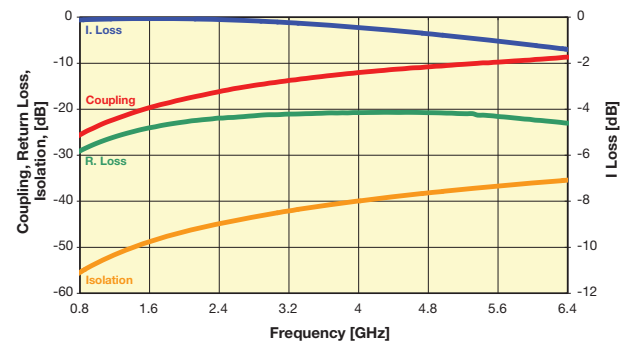

Coupler P/N CP0402AxxxxEN

Application	P/N Examples	Frequency Band [MHz]	Coupling [dB]	I. Loss max. [dB]	Return Loss [dB]	Directivity [dB]	
AMPS	CP0402A0836EN	824 - 849	27.20	0.20	35	25	
	CP0402A0881EN	869 - 894	26.80	0.20	34		
GSM	CP0402A0902EN	890 - 915	26.50	0.20	34		
	CP0402A0947EN	935 - 960	26.00	0.20	34		
E-GSM	CP0402A0897EN	880 ÷ 915	26.50	0.20	34		
	CP0402A0942EN	925 ÷ 960	26.00	0.20	34		
PDC	CP0402A1441EN	1429 - 1453	22.30	0.25	29		23
PCN	CP0402A1747EN	1710 - 1785	20.50	0.25	27		
	CP0402A1842EN	1805 - 1880	20.30	0.25	26		
PCS	CP0402A1880EN	1850 - 1910	20.00	0.25	26		
	CP0402A1960EN	1930 - 1990	20.00	0.25	26		
PHP	CP0402A1907EN	1895 - 1920	20.00	0.25	26		
DECT	CP0402A1890EN	1880 - 1900	20.00	0.25	26		
Wireless LAN	CP0402A2442EN	2400 - 2484	18.00	0.35	23		
WiFi	CP0402A3500EN	3450 - 3550	15.00	0.37	20	16	
	CP0402A5000EN	4950 - 5050	12.50	0.50	18	13	
	CP0402A5500EN	5450 - 5550	11.50	0.65	16	13	
	CP0402A6000EN	5950 - 6050	11.10	0.70	15	13	

CP0402AxxxxENTR

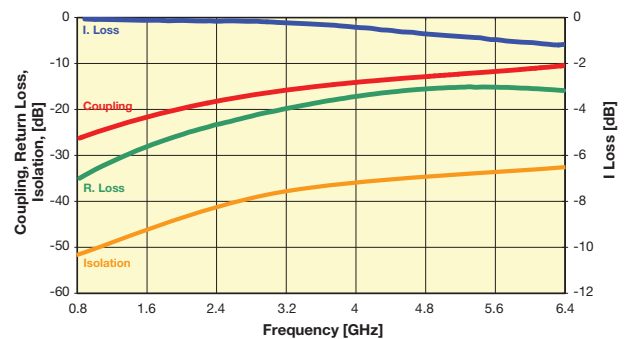

Coupler P/N CP0402AxxxxFN

Application	P/N Examples	Frequency Band [MHz]	Coupling [dB]	I. Loss max. [dB]	Return Loss [dB]	Directivity [dB]	
AMPS	CP0402A0836FN	824 - 849	31.00	0.20	29.10	11	
	CP0402A0881FN	869 - 894	30.70	0.20	28.60		
GSM	CP0402A0902FN	890 - 915	30.60	0.20	28.50		
	CP0402A0947FN	935 - 960	30.00	0.20	28.10		
E-GSM	CP0402A0897FN	880 ÷ 915	30.60	0.20	28.50		
	CP0402A0942FN	925 ÷ 960	30.00	0.20	28.10		
PDC	CP0402A1441FN	1429 - 1453	26.50	0.20	25.00		9
PCN	CP0402A1747FN	1710 - 1785	25.00	0.20	23.80		
	CP0402A1842FN	1805 - 1880	24.50	0.20	23.60		
PCS	CP0402A1880FN	1850 - 1910	24.20	0.20	23.50		
	CP0402A1960FN	1930 - 1990	24.00	0.20	23.30		
PHP	CP0402A1907FN	1895 - 1920	24.20	0.20	23.40		
DECT	CP0402A1890FN	1880 - 1900	24.20	0.20	23.50		
Wireless LAN	CP0402A2442FN	2400 - 2484	22.00	0.25	22.60		
WiFi	CP0402A3500FN	3450 - 3550	18.00	0.27	22.00	9	
	CP0402A5000FN	4950 - 5050	15.70	0.30	23.01	8	
	CP0402A5500FN	5450 - 5550	15.20	0.30	20.36	7.5	
	CP0402A6000FN	5950 - 6050	14.50	0.30	18.94	7.5	

CP0402AxxxxFNTR

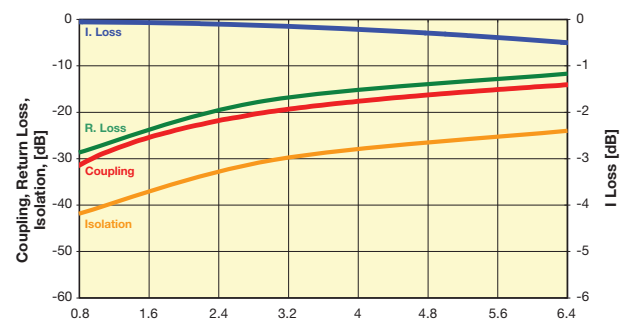

Important: Couplers can be used at any frequency within the indicated range.



# Thin-Film Directional Couplers



## CP0402 / CP0603 High Directivity Couplers Test Jigs

### GENERAL DESCRIPTION

These jigs are designed for testing the CP0402 and CP0603 High Directivity Couplers using a Vector Network Analyzer.

They consist of a dielectric substrate, having 50Ω microstrips as conducting lines and a bottom ground plane located at a distance of 0.254mm (0.010") from the microstrips.

The substrate used is Neltec's NH9338ST0254C1BC.

The connectors are SMA type (female), 'Johnson Components Inc.' Product P/N: 142-0701-841.

Both a measurement jig and a calibration jig are provided.

The calibration jig is designed for a full 2-port calibration, and consists of an open line, short line and through line. LOAD calibration can be done by a 50Ω SMA termination.

### MEASUREMENT PROCEDURE

When measuring a component, it can be either soldered or pressed using a non-metallic stick until all four ports touch the appropriate pads. Set the VNA to the relevant frequency band. Connect the VNA using a 10dB attenuator on the jig

terminal connected to port 2. Follow the VNA's instruction manual and use the [calibration jig](#) to perform a full 2-Port calibration in the required bandwidths.

#### Place the coupler on the [measurement jig](#) as follows:

Input (Coupler) → Connector 1 (Jig)      Termination (Coupler) → Connector 3 (Jig)  
Output (Coupler) → Connector 2 (Jig)      Coupling (Coupler) → Connector 4 (Jig)

#### To measure I. Loss connect:

Connector 1 (Jig) → Port 1 (VNA)      Connector 3 (Jig) → 50Ω  
Connector 2 (Jig) → Port 2 (VNA)      Connector 4 (Jig) → 50Ω

#### To measure R. Loss and Coupling connect:

Connector 1 (Jig) → Port 1 (VNA)      Connector 3 (Jig) → 50Ω  
Connector 2 (Jig) → 50Ω      Connector 4 (Jig) → Port 2 (VNA)

#### To measure Isolation connect:

Connector 1 (Jig) → 50Ω      Connector 3 (Jig) → 50Ω  
Connector 2 (Jig) → Port 1 (VNA)      Connector 4 (Jig) → Port 2 (VNA)

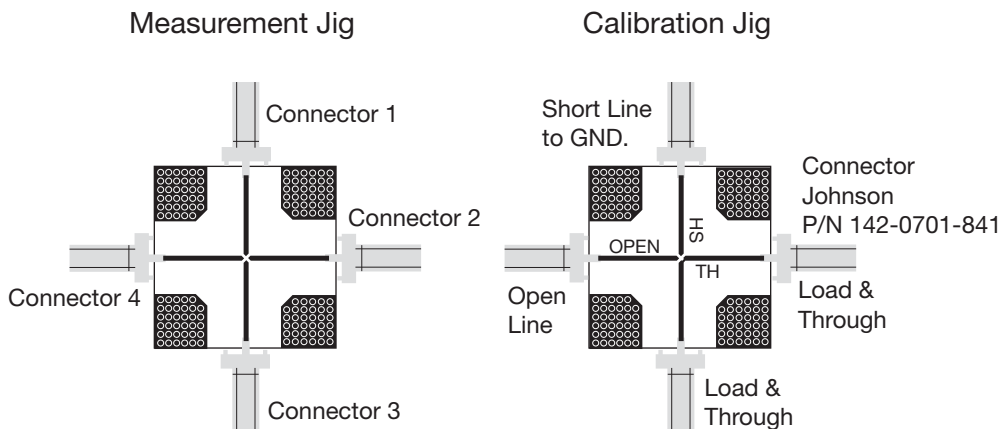

## X-ON Electronics

Largest Supplier of Electrical and Electronic Components

*Click to view similar products for [Signal Conditioning category](#):*

*Click to view products by [AVX manufacturer](#):*

Other Similar products are found below :

[MAPDCC0004](#) [PD0409J5050S2HF](#) [880157](#) [HHS-109-PIN](#) [DC1417J5005AHF](#) [DC4859J5005AHF](#) [AFS14A30-2185.00-T3](#) [AFS14A35-1591.50-T3](#) [DS-323-PIN](#) [DSS-313-PIN](#) [B39321R801H210](#) [B39321R821H210](#) [B39921B4317P810](#) [1A0220-3](#) [2089-6207-00](#) [JP510S](#) [LFB212G45SG8C341](#) [LFB322G45SN1A504](#) [LFL182G45TC3B746](#) [SF2159E](#) [30057](#) [1P510S](#) [CER0813B](#) [3A325](#) [40287](#) [41180](#) [ATB3225-75032NCT](#) [B69842N5807A150](#) [BD0810N50100AHF](#) [BD2326L50200AHF](#) [BD2425J50200AHF](#) [HMC189AMS8TR](#) [C5060J5003AHF](#) [JHS-114-PIN](#) [JP503AS](#) [DC0710J5005AHF](#) [DC2327J5005AHF](#) [DC3338J5005AHF](#) [43020](#) [LFB2H2G60BB1C106](#) [LFL15869MTC1B787](#) [X3C19F1-20S](#) [XC3500P-20S](#) [10013-20](#) [SF2081E](#) [SF2194E](#) [SF2238E](#) [CDBLB455KCAX39-B0](#) [RF1353C](#) [PD0922J5050D2HF](#)