

# SMPS Stacked MLC Capacitors

## (SM Style) Technical Information on SMPS Capacitors

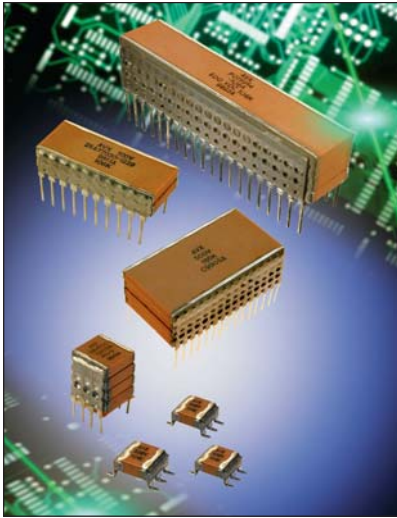

AVX is the original inventor of large capacitance value, stacked MLCC capacitors constructed with DIP leads. The SM-style, Switch Mode Power Supply (SMPS) capacitors were introduced by AVX in 1980s. These capacitors are the closest to the ideal electrical energy storage devices due to high CV product and extremely low ESR and ESL.

In addition to traditionally offered COG (Class I) and X7R (Class II) type dielectrics, AVX introduces another class I, temperature compensated N1500 dielectric characterized with very low dissipation factor. Thanks to considerably higher relative dielectric constant of N1500 dielectric, the CV product is more than doubled in comparison to ultra-stable COG dielectric, resulting in a significant reduction in the size of capacitor and a significant improvement of volumetric efficiency.

The typical applications for different type dielectrics are:

- COG: High frequency resonant capacitors, avionic AC line filters (400Hz to 800Hz), snubbers, timing circuits, high current repetitive discharge
- N1500: Avionic AC line filters (400Hz to 800Hz), snubbers, high current repetitive discharge, capacitive temperature compensation
- X7R: General filtering, input and output filters in DC/DC converters, bulk filters, DC link capacitors, motor drive filters, high current non-repetitive discharge

**Not RoHS Compliant**

### GENERAL SPECIFICATIONS FOR ALL DIELECTRIC TYPES

#### Operating Temperature Range

-55° to +125°C

#### Voltage Ratings

50VDC through 500VDC (+125°C)

#### Dielectric Withstanding Voltage

250% rated voltage for 5 seconds with 30 to 50mA charging current (500 Volt units @ 750VDC)

#### Insulation Resistance (25°C, rated DC voltage)

100KMΩ min. or 1000MΩ-μF min. whichever is less

#### Insulation Resistance (125°C, rated DC voltage)

10KMΩ min. or 100MΩ-μF min. whichever is less

#### Thermal Shock Capabilities

5 cycles (-55°C to +125°C)

#### Life Test Capabilities (1000 hours)

200% rated voltage at +125°C (500 Volt units @ 600VDC)

### GENERAL SPECIFICATIONS FOR ALL DIELECTRIC TYPES

#### COG Dielectric

##### Capacitance Range

0.01μF to 15μF  
(+25°C, 1.0 ± 0.2Vrms at 1kHz)

##### Capacitance Tolerances

±5%, ±10%, ±20%

##### Temperature Characteristic

0 ± 30 ppm/°C

##### Dissipation Factor

0.15% max.  
(+25°C, 1.0 ± 0.2Vrms at 1kHz)

#### N1500

##### Capacitance Range

0.018μF to 33μF  
(+25°C, 1.0 ± 0.2Vrms at 1kHz)

##### Capacitance Tolerances

±5%, ±10%, ±20%

##### Temperature Characteristic

-1500 ± 250 ppm/°C

##### Dissipation Factor

0.15% max.  
(+25°C, 1.0 ± 0.2Vrms at 1kHz)

#### X7R Dielectric

##### Capacitance Range

0.1μF to 390μF  
(+25°C, 1.0 ± 0.2Vrms at 1kHz)

##### Capacitance Tolerances

±10%, ±20%, +80%, -20%

##### Temperature Characteristic

±15%

##### Dissipation Factor

2.5% max.  
(+25°C, 1.0 ± 0.2Vrms at 1kHz)

# SMPS Stacked MLC Capacitors

## (SM Style) Technical Information on SMPS Capacitors

### HOW TO ORDER

AVX Styles: SM-1, SM-2, SM-3, SM-4, SM-5, SM-6

SM0	1	7	C	106	M	A	N	650
<b>AVX Style</b> SM0 = Uncoated SM5 = Epoxy Coated	<b>Size</b> See Dimensions chart	<b>Voltage</b> 50V = 5 100V = 1 200V = 2 500V = 7	<b>Temperature Coefficient</b> COG = A N1500 = 4 X7R = C	<b>Capacitance Code</b> (2 significant digits + number of zeros) 1,000 pF = 102 22,000 pF = 223 220,000 pF = 224 1 μF = 105 10 μF = 106 100 μF = 107	<b>Capacitance Tolerance</b> COG/N1500: J = ±5% K = ±10% M = ±20% X7R: K = ±10% M = ±20% Z = +80%, -20%	<b>Test Level</b> A = Standard B = Hi-Rel* 5 = Standard/MIL** 6 = Hi-Rel/MIL***	<b>Termination</b> N = Straight Lead J = Leads formed in L = Leads formed out P = P Style Leads Z = Z Style Leads	<b>Height</b> Max Dimension "A" 120 = 0.120" 240 = 0.240" 360 = 0.360" 480 = 0.480" 650 = 0.650"  See tables for capacitance available in specific height and dielectric

Note: Capacitors with X7R dielectric are not intended for applications across AC supply mains or AC line filtering with polarity reversal. Contact plant for recommendations.

\* Hi-Rel screening option. Screening consists of 100% Group A (B Level), Subgroup 1 per MIL-PRF-49470.

\*\* Form, fit & function equivalent to MIL-PRF-49470 part. Applies to 50V rated parts only. No screening.

\*\*\* Form, fit & function equivalent to MIL-PRF-49470 part. Applies to 50V rated parts only. Hi-Rel screening the same as option B.

### Typical ESR Performance (mΩ)

	Aluminum Electrolytic 100μF/50V	Low ESR Solid Tantalum 100μF/10V	Solid Aluminum Electrolytic 100μF/16V	MLCC SMPS 100μF/50V	MLCC SMPS 4.7μF/50V
ESR @ 10KHz	300	72	29	3	66
ESR @ 50KHz	285	67	22	2	23
ESR @ 100KHz	280	62	20	2.5	15
ESR @ 500KHz	265	56	18	4	8
ESR @ 1MHz	265	56	17	7	7.5
ESR @ 5MHz	335	72	17	12.5	8
ESR @ 10MHz	560	91	22	20	14



Performance of SMPS capacitors can be simulated by downloading SpiCalci software program - <http://www.avx.com/resources/design-tools/>

# SMPS Stacked MLC Capacitors

## (SM Style) Surface Mount and Thru-Hole Styles (SM0, SM5)

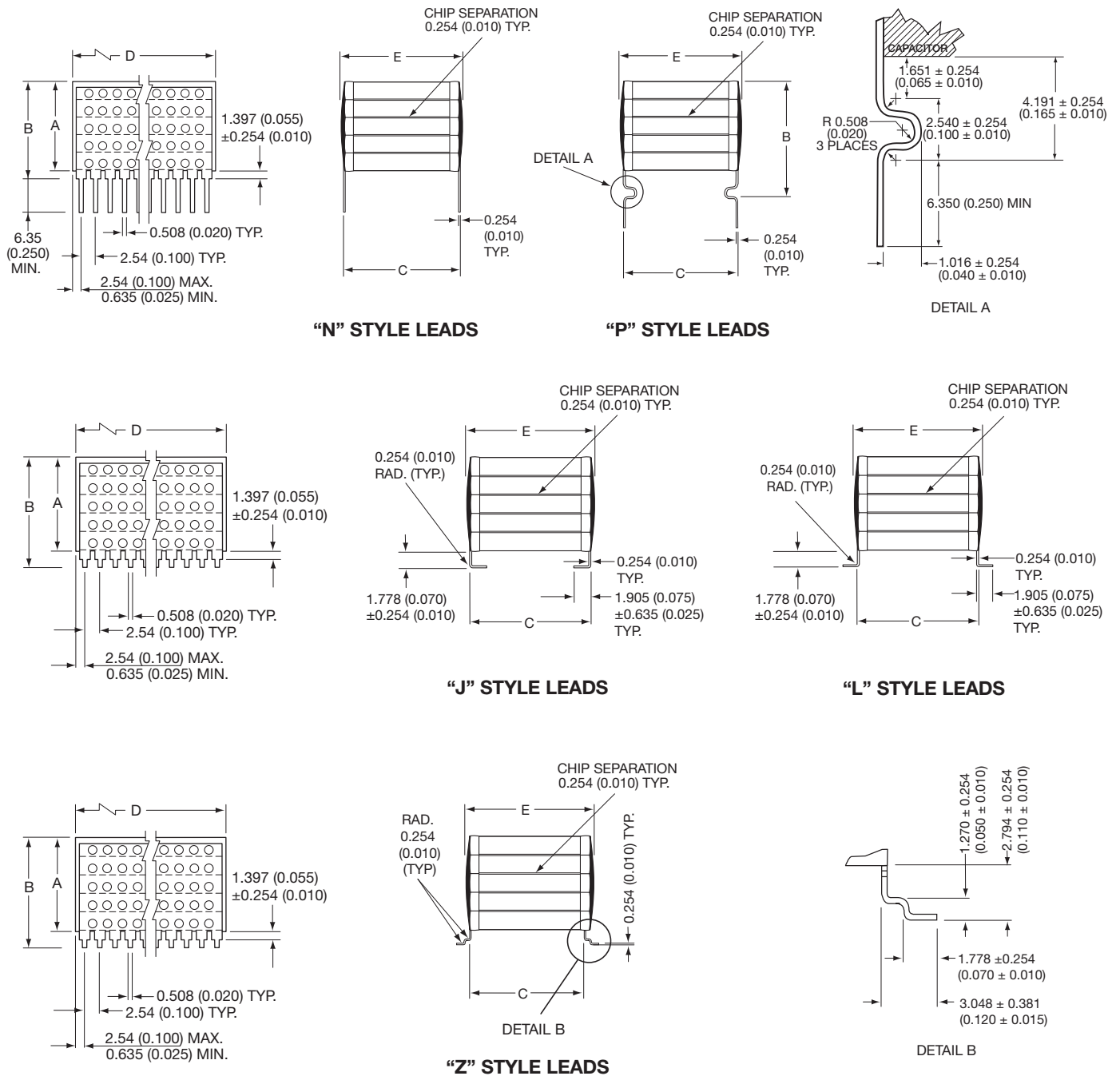

### DIMENSIONS

millimeters (inches)

Style	A (max.)	B (max.)	C ±.635 (±0.025)	D ±.635 (±0.025)	E (max.)	No. of Leads per side
SM-1			11.4 (0.450)	52.1 (2.050)	12.7 (0.500)	20
SM-2	See capacitance range table for maximum "A" dimensions	For "N" Style Leads: "A" Dimension Plus 1.651 (0.065)	20.3 (0.800)	38.4 (1.510)	22.1 (0.870)	15
SM-3		For "J" & "L" Style Leads: "A" Dimension Plus 2.032 (0.080)	11.4 (0.450)	26.7 (1.050)	12.7 (0.500)	10
SM-4		For "P" Style Leads: "A" Dimension Plus 4.445 (0.175)	10.2 (0.400)	10.2 (0.400)	11.2 (0.440)	4
SM-5		For "Z" Style Leads: "A" Dimension Plus 3.048 (0.120)	6.35 (0.250)	6.35 (0.250)	7.62 (0.300)	3
SM-6			31.8 (1.250)	52.1 (2.050)	34.3 (1.350)	20

Note: For SM5 add 0.127 (0.005) to max. and nominal dimensions A, B, D, & E







# SMPS Stacked MLC Capacitors

## (SM Style) SM Military Styles MIL-PRF-49470

### AVX IS QUALIFIED TO MIL-PRF-49470/1 AND MIL-PRF-49470/2

The SMPS capacitors are designed for high current, high-power and high-temperature applications. These capacitors have very low ESR (Equivalent Series Resistance) and ESL (Equivalent Series Inductance). SMPS Series capacitors offer design and component engineers a proven technology specifically designed for programs requiring high reliability performance in harsh environments.

MIL-PRF-49470 SMPS Series capacitors are primarily used in input/output filters of high-power and high-voltage power supplies as well as in bus filters and DC snubbers for high power inverters and other high-current applications. These capacitors are available with through-hole and surface mount leads. The operating temperature is -55°C to +125°C.

The MIL-PRF-49470 capacitors are preferred over the DSCC drawing 87106 capacitors. MIL-PRF-49470 specification was created to produce a robust replacement for DSCC 87106. MIL-PRF-49470 offers two product levels.

Level “B” is the standard reliability. Level “T” is the high reliability suitable for space application.

AVX is qualified to supply MIL-PRF-49470/1 parts. These are unencapsulated ceramic dielectric, switch mode power supply capacitors. AVX is also qualified to supply MIL-PRF-49470/2 parts. These are encapsulated ceramic dielectric, switch mode power supply capacitors.

#### PLEASE CONTACT THE DLA WEBSITE

<http://www.landandmaritime.dla.mil/programs/milspec/DocSearch.aspx> for details on testing, electrical, mechanical and part number options.

#### PLEASE CONTACT THE DLA WEBSITE

<http://www.landandmaritime.dla.mil/Programs/QmlQpl/> for the latest QPL (Qualified Products List).

**Not RoHS Compliant**

### HOW TO ORDER

<b>M49470</b>	<b>R</b>	<b>01</b>	<b>474</b>	<b>K</b>	<b>C</b>	<b>N</b>
<b>Performance specification indicating MIL-PRF-49470</b>	<b>Characteristic</b> P = BP Q = BQ R = BR X = BX	<b>Performance specification sheet number</b> <b>01 – indicating MIL-PRF-49470/1</b> <b>02 – indicating MIL-PRF-49470/2</b>	<b>Capacitance</b>	<b>Capacitance Tolerance</b> BP: J = ±5% K = ±10% BX, BR & BQ: K = ±10% M = ±20%	<b>Rated Voltage</b> Z = 25V A = 50V B = 100V C = 200V E = 500V	<b>Configuration (Lead Style)</b> See chart for Lead configurations

For “T” level parts, replace the “M” in the pin with “T” (for example M49470R01474KCN becomes T49470R01474KCN) MIL-PRF-49470 contains additional capacitors that are not available in 87106, such as additional lead configurations and lower profile parts.

On the pages to follow is the general dimensional outline along with a cross reference from 87106 parts to MIL-PRF-49470 parts.

### LEAD CONFIGURATION

millimeters (inches)

Symbol (Last digit of military PN, 12th digit of AVX PN)	Lead Style	Height Profile (Dimension A)	Formed lead length, L
N	N (straight)	Standard	N/A
L	L (formed)	Standard	1.78 ± 0.25 (0.070 ± 0.010)
M	L (formed)	Standard	1.14 ± 0.25 (0.045 ± 0.010)
J	J (formed)	Standard	1.78 ± 0.25 (0.070 ± 0.010)
K	J (formed)	Standard	1.14 ± 0.25 (0.045 ± 0.010)
A	N (straight)	Low	N/A
B	L (formed)	Low	1.78 ± 0.25 (0.070 ± 0.010)
D	L (formed)	Low	1.14 ± 0.25 (0.045 ± 0.010)
C	J (formed)	Low	1.78 ± 0.25 (0.070 ± 0.010)
F	J (formed)	Low	1.14 ± 0.25 (0.045 ± 0.010)

Note: Lead options available marked with a “-” as a place holder. See lead configuration column for available lead options to replace the “-”.



Performance of SMPS capacitors can be simulated by downloading SpiCalci software program - <http://www.avx.com/SpiApps/default.asp#spicalci>



# SMPS Stacked MLC Capacitors

## (SM Style) SM Military Styles MIL-PRF-49470/1

### MIL-PRF-49470/1

MIL-PRF-49470/1 - capacitor, fixed, ceramic dielectric, switch mode power supply (general purpose and temperature stable), standard reliability and high reliability unencapsulated, Style PS01.

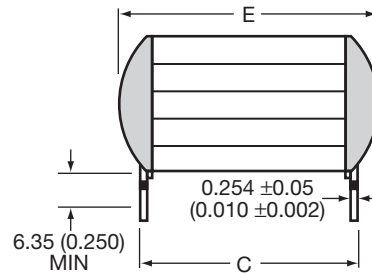
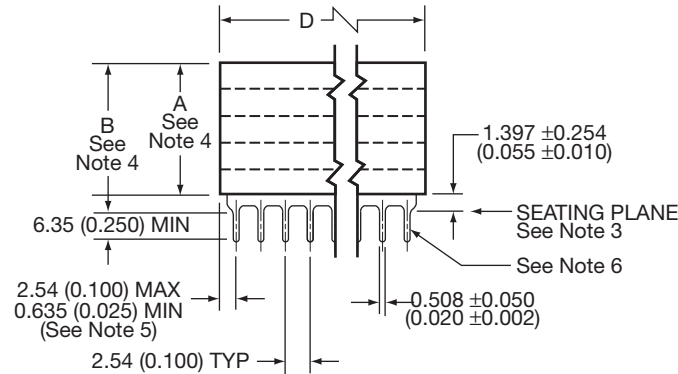

LEAD STYLE N AND A

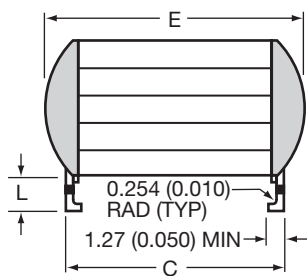

LEAD STYLE J AND C

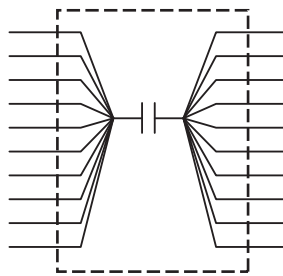

CIRCUIT DIAGRAM

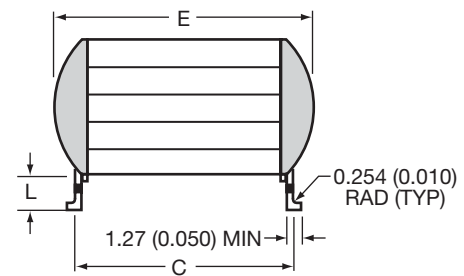

LEAD STYLE L AND B

### DIMENSIONS:

millimeters (inches)

Case Code	C ±0.635 (±0.025)	D		E (max.)	Number of Leads per side
		Min.	Max.		
1	11.4 (0.450)	49.5 (1.950)	52.7 (2.075)	12.7 (0.500)	20
2	20.3 (0.800)	36.8 (1.450)	40.0 (1.535)	22.1 (0.870)	15
3	11.4 (0.450)	24.1 (0.950)	27.3 (1.075)	12.7 (0.500)	10
4	10.2 (0.400)	8.89 (0.350)	10.8 (0.425)	11.2 (0.440)	4
5	6.35 (0.250)	6.20 (0.224)	6.97 (0.275)	7.62 (0.300)	3
6	31.8 (1.250)	49.5 (1.950)	52.7 (2.075)	34.3 (1.350)	20

### NOTES:

- Dimensions are in millimeters (inches)
- Unless otherwise specified, tolerances are 0.254 (±0.010).
- Lead frame configuration is shown as typical above the seating plane.
- See table I of MIL-PRF-49470/1 for specific maximum A dimension. For maximum B dimension, add 1.65 (0.065) to the appropriate A dimension. For all lead styles, the number of chips is determined by the capacitance and voltage rating.
- For case code 5, dimensions shall be 2.54 (0.100) maximum and 0.305 (0.012) minimum.
- Lead alignment within pin rows shall be within ±0.10 (0.005).



# SMPS Stacked MLC Capacitors

## (SM Style) SM Military Styles MIL-PRF-49470/2

### MIL-PRF-49470/2

MIL-PRF-49470/2 - capacitor, fixed, ceramic dielectric, switch mode power supply (general purpose and temperature stable), standard reliability and high reliability encapsulated, Style PS02.

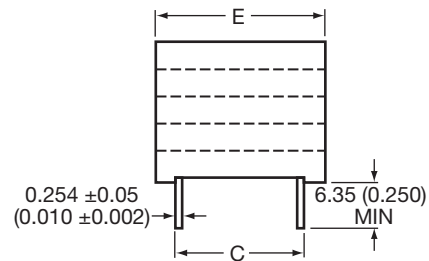
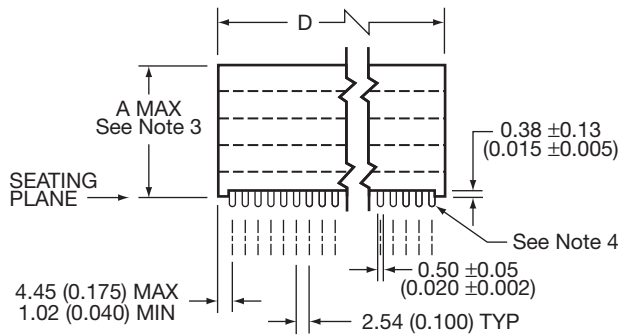

LEAD STYLE N AND A

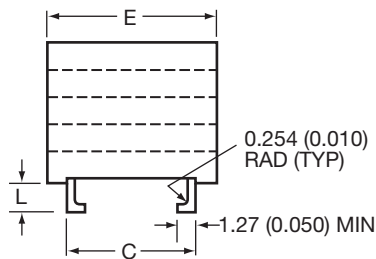

LEAD STYLE J AND C

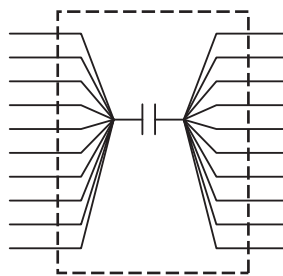

CIRCUIT DIAGRAM

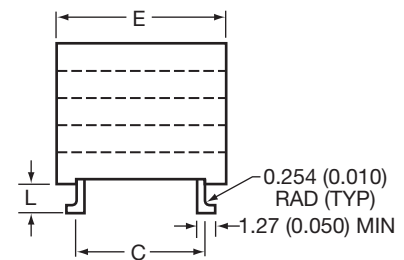

LEAD STYLE L AND B

### DIMENSIONS:

millimeters (inches)

Case Code	C ±0.635 (±0.025)	D ±0.635 (±0.025)	E (max)	Number of Leads per side
1	11.4 (0.450)	54.7 (2.155)	14.7 (0.580)	20
2	20.3 (0.800)	41.0 (1.615)	24.1 (0.950)	15
3	11.4 (0.450)	29.3 (1.155)	14.7 (0.580)	10
4	10.2 (0.400)	12.3 (0.485)	12.3 (0.485)	4
5	6.35 (0.250)	9.02 (0.355)	9.02 (0.355)	3
6	31.8 (1.250)	54.7 (2.155)	36.3 (1.430)	20

### NOTES:

1. Dimensions are in millimeters (inches)
2. Unless otherwise specified, tolerances are 0.254 (±0.001).
3. See table I of MIL-PRF-49470/2 for specific maximum A dimension. For all lead styles, the number of chips is determined by the capacitance and voltage rating.
4. Lead alignment within pin rows shall be within ±0.10 (0.004).

# SMPS Stacked MLC Capacitors

## (SM Style) SM Military Styles MIL-PRF-49470

MIL-PRF-49470 PIN 1/	AVX PART NUMBER (for reference only) 2/	Capacitance µF	Tolerance	Characteristic	Case Code	Lead Configuration
<b>25V</b>						
-49470X0-155-Z-	SM-53C155-H-120	1.5	K, M	BX	5	N, L, M, J, K
-49470X0-185-Z-	SM-53C185-H-120	1.8	K, M	BX	5	N, L, M, J, K
-49470X0-225-Z-	SM-53C225-H-120	2.2	K, M	BX	5	N, L, M, J, K
-49470X0-275-Z-	SM-53C275-H-240	2.7	K, M	BX	5	N, L, M, J, K
-49470X0-335-Z-	SM-53C335-H-240	3.3	K, M	BX	5	N, L, M, J, K
-49470X0-395-Z-	SM-53C395-H-240	3.9	K, M	BX	5	N, L, M, J, K
-49470X0-475-Z-	SM-53C475-H-240	4.7	K, M	BX	5	N, L, M, J, K
-49470X0-565-Z-	SM-53C565-H-360	5.6	K, M	BX	5	N, L, M, J, K
-49470X0-685-Z-	SM-53C685-H-360	6.8	K, M	BX	5	N, L, M, J, K
-49470X0-685-Z-	SM-43C685-H-120	6.8	K, M	BX	4	A, B, D, C, F
-49470X0-825-Z-	SM-53C825-H-480	8.2	K, M	BX	5	N, L, M, J, K
-49470X0-825-Z-	SM-43C825-H-240	8.2	K, M	BX	4	A, B, D, C, F
-49470X0-106-Z-	SM-53C106-H-650	10	K, M	BX	5	N, L, M, J, K
-49470X0-106-Z-	SM-43C106-H-240	10	K, M	BX	4	A, B, D, C, F
-49470X0-126-Z-	SM-43C126-H-240	12	K, M	BX	4	N, L, M, J, K
-49470X0-156-Z-	SM-43C156-H-360	15	K, M	BX	4	N, L, M, J, K
-49470X0-156-Z-	SM-33C156-H-120	15	K, M	BX	3	A, B, D, C, F
-49470X0-186-Z-	SM-43C186-H-360	18	K, M	BX	4	N, L, M, J, K
-49470X0-186-Z-	SM-33C186-H-120	18	K, M	BX	3	A, B, D, C, F
-49470X0-226-Z-	SM-43C226-H-480	22	K, M	BX	4	N, L, M, J, K
-49470X0-226-Z-	SM-33C226-H-240	22	K, M	BX	3	A, B, D, C, F
-49470X0-276-Z-	SM-43C276-H-480	27	K, M	BX	4	N, L, M, J, K
-49470X0-276-Z-	SM-33C276-H-240	27	K, M	BX	3	A, B, D, C, F
-49470X0-336-Z-	SM-43C336-H-650	33	K, M	BX	4	N, L, M, J, K
-49470X0-336-Z-	SM-33C336-H-240	33	K, M	BX	3	A, B, D, C, F
-49470X0-396-Z-	SM-33C396-H-360	39	K, M	BX	3	N, L, M, J, K
-49470X0-396-Z-	SM-13C396-H-240	39	K, M	BX	1	A, B, D, C, F
-49470X0-476-Z-	SM-33C476-H-480	47	K, M	BX	3	N, L, M, J, K
-49470X0-476-Z-	SM-13C476-H-360	47	K, M	BX	1	A, B, D, C, F
-49470X0-566-Z-	SM-33C566-H-480	56	K, M	BX	3	N, L, M, J, K
-49470X0-566-Z-	SM-13C566-H-360	56	K, M	BX	1	A, B, D, C, F
-49470X0-686-Z-	SM-33C686-H-480	68	K, M	BX	3	N, L, M, J, K
-49470X0-686-Z-	SM-13C686-H-360	68	K, M	BX	1	A, B, D, C, F
-49470X0-826-Z-	SM-33C826-H-650	82	K, M	BX	3	N, L, M, J, K
-49470X0-826-Z-	SM-13C826-H-360	82	K, M	BX	1	A, B, D, C, F
-49470X0-107-Z-	SM-13C107-H-480	100	K, M	BX	1	N, L, M, J, K
-49470X0-107-Z-	SM-23C107-H-360	100	K, M	BX	2	A, B, D, C, F
-49470X0-127-Z-	SM-13C127-H-650	120	K, M	BX	1	N, L, M, J, K
-49470X0-127-Z-	SM-23C127-H-360	120	K, M	BX	2	A, B, D, C, F
-49470X0-157-Z-	SM-23C157-H-480	150	K, M	BX	2	N, L, M, J, K
-49470X0-157-Z-	SM-63C157-H-240	150	K, M	BX	6	A, B, D, C, F
-49470X0-187-Z-	SM-23C187-H-650	180	K, M	BX	2	N, L, M, J, K
-49470X0-187-Z-	SM-63C187-H-360	180	K, M	BX	6	A, B, D, C, F
-49470X0-227-Z-	SM-63C227-H-360	220	K, M	BX	6	N, L, M, J, K
-49470X0-277-Z-	SM-63C277-H-480	270	K, M	BX	6	N, L, M, J, K
-49470X0-337-Z-	SM-63C337-H-650	330	K, M	BX	6	N, L, M, J, K
-49470X0-397-Z-	SM-63C397-H-650	390	K, M	BX	6	N, L, M, J, K
<b>50V</b>						
-49470P0-563-A-	SM-55A563-H-120	0.056	J, K	BP	5	N, L, M, J, K
-49470P0-683-A-	SM-55A683-H-240	0.068	J, K	BP	5	N, L, M, J, K
-49470P0-823-A-	SM-55A823-H-240	0.082	J, K	BP	5	N, L, M, J, K
-49470P0-104-A-	SM-55A104-H-240	0.1	J, K	BP	5	N, L, M, J, K
-49470P0-124-A-	SM-55A124-H-360	0.12	J, K	BP	5	N, L, M, J, K
-49470P0-154-A-	SM-55A154-H-360	0.15	J, K	BP	5	N, L, M, J, K
-49470P0-184-A-	SM-55A184-H-480	0.18	J, K	BP	5	N, L, M, J, K
-49470P0-184-A-	SM-45A184-H-240	0.18	J, K	BP	4	A, B, D, C, F

1/ Complete PIN shall include additional symbols replacing dashes (from left to right): product level (M for B level, or T for T level), part style (1 for unencapsulated, 2 for encapsulated), capacitance tolerance, lead configuration

2/ Complete AVX Part Number (provided for reference only) shall include additional symbols replacing dashes (from left to right): part style (0 for unencapsulated and 9 for encapsulated), capacitance tolerance, lead configuration

The last 3 digits of the AVX Part Number represent the chip height of the unencapsulated version. For the encapsulated version, replace the last 3 digits as follows: (120 replace with 270, 240 replace with 390, 360 replace with 530, 480 replace with 660 and 650 replace with 800).



# SMPS Stacked MLC Capacitors

## (SM Style) SM Military Styles MIL-PRF-49470

MIL-PRF-49470 PIN 1/	AVX PART NUMBER (for reference only) 2/	Capacitance µF	Tolerance	Characteristic	Case Code	Lead Configuration
-49470P0-224-A-	SM-55A224-H-480	0.22	J, K	BP	5	N, L, M, J, K
-49470P0-224-A-	SM-45A224-H-240	0.22	J, K	BP	4	A, B, D, C, F
-49470P0-274-A-	SM-55A274-H-650	0.27	J, K	BP	5	N, L, M, J, K
-49470P0-274-A-	SM-45A274-H-240	0.27	J, K	BP	4	A, B, D, C, F
-49470P0-334-A-	SM-45A334-H-360	0.33	J, K	BP	4	N, L, M, J, K
-49470P0-394-A-	SM-45A394-H-480	0.39	J, K	BP	4	N, L, M, J, K
-49470P0-474-A-	SM-45A474-H-480	0.47	J, K	BP	4	N, L, M, J, K
-49470P0-564-A-	SM-45A564-H-650	0.56	J, K	BP	4	N, L, M, J, K
-49470P0-564-A-	SM-35A564-H-240	0.56	J, K	BP	3	A, B, D, C, F
-49470P0-684-A-	SM-35A684-H-240	0.68	J, K	BP	3	N, L, M, J, K
-49470P0-824-A-	SM-35A824-H-240	0.82	J, K	BP	3	N, L, M, J, K
-49470P0-105-A-	SM-35A105-H-360	1	J, K	BP	3	N, L, M, J, K
-49470X0-105-A-	SM-55C105-H-120	1	K, M	BX	5	N, L, M, J, K
-49470P0-125-A-	SM-35A125-H-360	1.2	J, K	BP	3	N, L, M, J, K
-49470X0-125-A-	SM-55C125-H-120	1.2	K, M	BX	5	N, L, M, J, K
-49470P0-155-A-	SM-35A155-H-480	1.5	J, K	BP	3	N, L, M, J, K
-49470X0-155-A-	SM-55C155-H-240	1.5	K, M	BX	5	N, L, M, J, K
-49470P0-185-A-	SM-35A185-H-480	1.8	J, K	BP	3	N, L, M, J, K
-49470X0-185-A-	SM-55C185-H-240	1.8	K, M	BX	5	N, L, M, J, K
-49470P0-225-A-	SM-35A225-H-650	2.2	J, K	BP	3	N, L, M, J, K
-49470X0-225-A-	SM-55C225-H-240	2.2	K, M	BX	5	N, L, M, J, K
-49470X0-275-A-	SM-55C275-H-360	2.7	K, M	BX	5	N, L, M, J, K
-49470X0-335-A-	SM-55C335-H-360	3.3	K, M	BX	5	N, L, M, J, K
-49470X0-395-A-	SM-55C395-H-480	3.9	K, M	BX	5	N, L, M, J, K
-49470X0-475-A-	SM-55C475-H-480	4.7	K, M	BX	5	N, L, M, J, K
-49470X0-475-A-	SM-45C475-H-240	4.7	K, M	BX	4	A, B, D, C, F
-49470X0-565-A-	SM-55C565-H-650	5.6	K, M	BX	5	N, L, M, J, K
-49470X0-565-A-	SM-45C565-H-240	5.6	K, M	BX	4	A, B, D, C, F
-49470X0-685-A-	SM-45C685-H-360	6.8	K, M	BX	4	N, L, M, J, K
-49470X0-825-A-	SM-45C825-H-360	8.2	K, M	BX	4	N, L, M, J, K
-49470X0-106-A-	SM-45C106-H-480	10	K, M	BX	4	N, L, M, J, K
-49470X0-126-A-	SM-45C126-H-480	12	K, M	BX	4	N, L, M, J, K
-49470X0-156-A-	SM-45C156-H-650	15	K, M	BX	4	N, L, M, J, K
-49470X0-156-A-	SM-35C156-H-240	15	K, M	BX	3	A, B, D, C, F
-49470X0-186-A-	SM-35C186-H-240	18	K, M	BX	3	N, L, M, J, K
-49470X0-226-A-	SM-35C226-H-360	22	K, M	BX	3	N, L, M, J, K
-49470X0-276-A-	SM-35C276-H-360	27	K, M	BX	3	N, L, M, J, K
-49470X0-336-A-	SM-35C336-H-360	33	K, M	BX	3	N, L, M, J, K
-49470X0-396-A-	SM-35C396-H-480	39	K, M	BX	3	N, L, M, J, K
-49470X0-476-A-	SM-35C476-H-650	47	K, M	BX	3	N, L, M, J, K
-49470X0-476-A-	SM-25C476-H-240	47	K, M	BX	2	A, B, D, C, F
-49470X0-566-A-	SM-15C566-H-360	56	K, M	BX	1	N, L, M, J, K
-49470X0-566-A-	SM-25C566-H-240	56	K, M	BX	2	A, B, D, C, F
-49470X0-686-A-	SM-15C686-H-480	68	K, M	BX	1	N, L, M, J, K
-49470X0-686-A-	SM-25C686-H-360	68	K, M	BX	2	A, B, D, C, F
-49470X0-826-A-	SM-15C826-H-480	82	K, M	BX	1	N, L, M, J, K
-49470X0-826-A-	SM-25C826-H-360	82	K, M	BX	2	A, B, D, C, F
-49470X0-107-A-	SM-15C107-H-650	100	K, M	BX	1	N, L, M, J, K
-49470X0-107-A-	SM-25C107-H-480	100	K, M	BX	2	A, B, D, C, F
-49470X0-127-A-	SM-25C127-H-480	120	K, M	BX	2	N, L, M, J, K
-49470X0-157-A-	SM-25C157-H-650	150	K, M	BX	2	N, L, M, J, K
-49470X0-187-A-	SM-65C187-H-480	180	K, M	BX	6	N, L, M, J, K
-49470X0-227-A-	SM-65C227-H-480	220	K, M	BX	6	N, L, M, J, K
-49470X0-277-A-	SM-65C277-H-650	270	K, M	BX	6	N, L, M, J, K
<b>100V</b>						
-49470P0-473-B-	SM-51A473-H-240	0.047	J, K	BP	5	N, L, M, J, K
-49470P0-563-B-	SM-51A563-H-240	0.056	J, K	BP	5	N, L, M, J, K

1/ Complete PIN shall include additional symbols replacing dashes (from left to right): product level (M for B level, or T for T level), part style (1 for unencapsulated, 2 for encapsulated), capacitance tolerance, lead configuration

2/ Complete AVX Part Number (provided for reference only) shall include additional symbols replacing dashes (from left to right): part style (0 for unencapsulated and 9 for encapsulated), capacitance tolerance, lead configuration

The last 3 digits of the AVX Part Number represent the chip height of the unencapsulated version. For the encapsulated version, replace the last 3 digits as follows: (120 replace with 270, 240 replace with 390, 360 replace with 530, 480 replace with 660 and 650 replace with 800).

# SMPS Stacked MLC Capacitors

## (SM Style) SM Military Styles MIL-PRF-49470

MIL-PRF-49470 PIN 1/	AVX PART NUMBER (for reference only) 2/	Capacitance µF	Tolerance	Characteristic	Case Code	Lead Configuration
-49470P0-683-B-	SM-51A683-H-240	0.068	J, K	BP	5	N, L, M, J, K
-49470P0-823-B-	SM-51A823-H-240	0.082	J, K	BP	5	N, L, M, J, K
-49470P0-104-B-	SM-51A104-H-360	0.1	J, K	BP	5	N, L, M, J, K
-49470P0-124-B-	SM-51A124-H-360	0.12	J, K	BP	5	N, L, M, J, K
-49470P0-154-B-	SM-51A154-H-480	0.15	J, K	BP	5	N, L, M, J, K
-49470P0-154-B-	SM-41A154-H-240	0.15	J, K	BP	4	A, B, D, C, F
-49470P0-184-B-	SM-51A184-H-650	0.18	J, K	BP	5	N, L, M, J, K
-49470P0-184-B-	SM-41A184-H-240	0.18	J, K	BP	4	A, B, D, C, F
-49470P0-224-B-	SM-51A224-H-650	0.22	J, K	BP	5	N, L, M, J, K
-49470P0-224-B-	SM-41A224-H-240	0.22	J, K	BP	4	A, B, D, C, F
-49470P0-274-B-	SM-41A274-H-360	0.27	J, K	BP	4	N, L, M, J, K
-49470P0-334-B-	SM-41A334-H-480	0.33	J, K	BP	4	N, L, M, J, K
-49470P0-394-B-	SM-41A394-H-480	0.39	J, K	BP	4	N, L, M, J, K
-49470P0-474-B-	SM-41A474-H-650	0.47	J, K	BP	4	N, L, M, J, K
-49470P0-474-B-	SM-31A474-H-240	0.47	J, K	BP	3	A, B, D, C, F
-49470P0-564-B-	SM-41A564-H-650	0.56	J, K	BP	4	N, L, M, J, K
-49470P0-564-B-	SM-31A564-H-240	0.56	J, K	BP	3	A, B, D, C, F
-49470P0-684-B-	SM-31A684-H-240	0.68	J, K	BP	3	N, L, M, J, K
-49470X0-684-B-	SM-51C684-H-120	0.68	K, M	BX	5	N, L, M, J, K
-49470P0-824-B-	SM-31A824-H-360	0.82	J, K	BP	3	N, L, M, J, K
-49470X0-824-B-	SM-51C824-H-240	0.82	K, M	BX	5	N, L, M, J, K
-49470P0-105-B-	SM-31A105-H-360	1	J, K	BP	3	N, L, M, J, K
-49470X0-105-B-	SM-51C105-H-240	1	K, M	BX	5	N, L, M, J, K
-49470P0-125-B-	SM-31A125-H-480	1.2	J, K	BP	3	N, L, M, J, K
-49470X0-125-B-	SM-51C125-H-240	1.2	K, M	BX	5	N, L, M, J, K
-49470P0-155-B-	SM-31A155-H-480	1.5	J, K	BP	3	N, L, M, J, K
-49470X0-155-B-	SM-51C155-H-360	1.5	K, M	BX	5	N, L, M, J, K
-49470P0-185-B-	SM-31A185-H-650	1.8	J, K	BP	3	N, L, M, J, K
-49470X0-185-B-	SM-51C185-H-360	1.8	K, M	BX	5	N, L, M, J, K
-49470X0-225-B-	SM-51C225-H-480	2.2	K, M	BX	5	N, L, M, J, K
-49470X0-225-B-	SM-41C225-H-240	2.2	K, M	BX	4	A, B, D, C, F
-49470X0-275-B-	SM-51C275-H-480	2.7	K, M	BX	5	N, L, M, J, K
-49470X0-335-B-	SM-51C335-H-650	3.3	K, M	BX	5	N, L, M, J, K
-49470X0-335-B-	SM-41C335-H-240	3.3	K, M	BX	4	A, B, D, C, F
-49470X0-395-B-	SM-41C395-H-360	3.9	K, M	BX	4	N, L, M, J, K
-49470X0-475-B-	SM-41C475-H-360	4.7	K, M	BX	4	N, L, M, J, K
-49470X0-565-B-	SM-41C565-H-480	5.6	K, M	BX	4	N, L, M, J, K
-49470X0-685-B-	SM-41C685-H-480	6.8	K, M	BX	4	N, L, M, J, K
-49470X0-825-B-	SM-41C825-H-650	8.2	K, M	BX	4	N, L, M, J, K
-49470X0-825-B-	SM-31C825-H-240	8.2	K, M	BX	3	A, B, D, C, F
-49470X0-106-B-	SM-31C106-H-240	10	K, M	BX	3	N, L, M, J, K
-49470X0-126-B-	SM-31C126-H-240	12	K, M	BX	3	N, L, M, J, K
-49470X0-156-B-	SM-31C156-H-360	15	K, M	BX	3	N, L, M, J, K
-49470X0-186-B-	SM-31C186-H-360	18	K, M	BX	3	N, L, M, J, K
-49470X0-226-B-	SM-31C226-H-480	22	K, M	BX	3	N, L, M, J, K
-49470X0-276-B-	SM-31C276-H-650	27	K, M	BX	3	N, L, M, J, K
-49470X0-276-B-	SM-21C276-H-240	27	K, M	BX	2	A, B, D, C, F
-49470X0-336-B-	SM-11C336-H-360	33	K, M	BX	1	N, L, M, J, K
-49470X0-336-B-	SM-21C336-H-240	33	K, M	BX	2	A, B, D, C, F
-49470X0-396-B-	SM-11C396-H-480	39	K, M	BX	1	N, L, M, J, K
-49470X0-396-B-	SM-21C396-H-360	39	K, M	BX	2	A, B, D, C, F
-49470X0-476-B-	SM-11C476-H-480	47	K, M	BX	1	N, L, M, J, K
-49470X0-476-B-	SM-21C476-H-360	47	K, M	BX	2	A, B, D, C, F
-49470X0-566-B-	SM-11C566-H-650	56	K, M	BX	1	N, L, M, J, K
-49470X0-686-B-	SM-21C686-H-480	68	K, M	BX	2	N, L, M, J, K
-49470X0-826-B-	SM-21C826-H-650	82	K, M	BX	2	N, L, M, J, K
-49470X0-107-B-	SM-61C107-H-360	100	K, M	BX	6	N, L, M, J, K

1/ Complete PIN shall include additional symbols replacing dashes (from left to right): product level (M for B level, or T for T level), part style (1 for unencapsulated, 2 for encapsulated), capacitance tolerance, lead configuration

2/ Complete AVX Part Number (provided for reference only) shall include additional symbols replacing dashes (from left to right): part style (0 for unencapsulated and 9 for encapsulated), capacitance tolerance, lead configuration

The last 3 digits of the AVX Part Number represent the chip height of the unencapsulated version. For the encapsulated version, replace the last 3 digits as follows: (120 replace with 270, 240 replace with 390, 360 replace with 530, 480 replace with 660 and 650 replace with 800).



# SMPS Stacked MLC Capacitors

## (SM Style) SM Military Styles MIL-PRF-49470

MIL-PRF-49470 PIN 1/	AVX PART NUMBER (for reference only) 2/	Capacitance µF	Tolerance	Characteristic	Case Code	Lead Configuration
-49470X0-127-B-	SM-61C127-H-360	120	K, M	BX	6	N, L, M, J, K
-49470X0-157-B-	SM-61C157-H-480	150	K, M	BX	6	N, L, M, J, K
-49470X0-187-B-	SM-61C187-H-540	180	K, M	BX	6	N, L, M, J, K
<b>200V</b>						
-49470P0-223-C-	SM-52A223-H-120	0.022	J, K	BP	5	N, L, M, J, K
-49470P0-273-C-	SM-52A273-H-240	0.027	J, K	BP	5	N, L, M, J, K
-49470P0-333-C-	SM-52A333-H-240	0.033	J, K	BP	5	N, L, M, J, K
-49470P0-393-C-	SM-52A393-H-240	0.039	J, K	BP	5	N, L, M, J, K
-49470P0-473-C-	SM-52A473-H-360	0.047	J, K	BP	5	N, L, M, J, K
-49470P0-563-C-	SM-52A563-H-360	0.056	J, K	BP	5	N, L, M, J, K
-49470P0-683-C-	SM-52A683-H-480	0.068	J, K	BP	5	N, L, M, J, K
-49470P0-683-C-	SM-42A683-H-120	0.068	J, K	BP	4	A, B, D, C, F
-49470P0-823-C-	SM-52A823-H-480	0.082	J, K	BP	5	N, L, M, J, K
-49470P0-823-C-	SM-42A823-H-240	0.082	J, K	BP	4	A, B, D, C, F
-49470P0-104-C-	SM-52A104-H-650	0.1	J, K	BP	5	N, L, M, J, K
-49470P0-104-C-	SM-42A104-H-240	0.1	J, K	BP	4	A, B, D, C, F
-49470P0-124-C-	SM-42A124-H-360	0.12	J, K	BP	4	N, L, M, J, K
-49470P0-154-C-	SM-42A154-H-360	0.15	J, K	BP	4	N, L, M, J, K
-49470P0-184-C-	SM-42A184-H-480	0.18	J, K	BP	4	N, L, M, J, K
-49470P0-224-C-	SM-42A224-H-480	0.22	J, K	BP	4	N, L, M, J, K
-49470P0-274-C-	SM-42A274-H-650	0.27	J, K	BP	4	N, L, M, J, K
-49470P0-274-C-	SM-32A274-H-240	0.27	J, K	BP	3	A, B, D, C, F
-49470P0-334-C-	SM-32A334-H-240	0.33	J, K	BP	3	N, L, M, J, K
-49470P0-394-C-	SM-32A394-H-240	0.39	J, K	BP	3	N, L, M, J, K
-49470P0-474-C-	SM-32A474-H-360	0.47	J, K	BP	3	N, L, M, J, K
-49470R0-474-C-	SM-52C474-H-240	0.47	K, M	BR	5	N, L, M, J, K
-49470P0-564-C-	SM-32A564-H-480	0.56	J, K	BP	3	N, L, M, J, K
-49470P0-564-C-	SM-32A564-H-360	0.56	J, K	BP	3	N, L, M, J, K
-49470R0-564-C-	SM-52C564-H-240	0.56	K, M	BR	5	N, L, M, J, K
-49470P0-684-C-	SM-32A684-H-480	0.68	J, K	BP	3	N, L, M, J, K
-49470R0-684-C-	SM-52C684-H-360	0.68	K, M	BR	5	N, L, M, J, K
-49470P0-824-C-	SM-32A824-H-650	0.82	J, K	BP	3	N, L, M, J, K
-49470R0-824-C-	SM-52C824-H-360	0.82	K, M	BR	5	N, L, M, J, K
-49470P0-105-C-	SM-32A105-H-650	1	J, K	BP	3	N, L, M, J, K
-49470R0-105-C-	SM-52C105-H-480	1	K, M	BR	5	N, L, M, J, K
-49470R0-105-C-	SM-42C105-H-120	1	K, M	BR	4	A, B, D, C, F
-49470R0-125-C-	SM-52C125-H-480	1.2	K, M	BR	5	N, L, M, J, K
-49470R0-125-C-	SM-42C125-H-240	1.2	K, M	BR	4	A, B, D, C, F
-49470R0-155-C-	SM-52C155-H-650	1.5	K, M	BR	5	N, L, M, J, K
-49470R0-155-C-	SM-42C155-H-240	1.5	K, M	BR	4	A, B, D, C, F
-49470R0-185-C-	SM-42C185-H-360	1.8	K, M	BR	4	N, L, M, J, K
-49470R0-225-C-	SM-42C225-H-360	2.2	K, M	BR	4	N, L, M, J, K
-49470R0-275-C-	SM-42C275-H-480	2.7	K, M	BR	4	N, L, M, J, K
-49470R0-335-C-	SM-42C335-H-480	3.3	K, M	BR	4	N, L, M, J, K
-49470R0-395-C-	SM-42C395-H-650	3.9	K, M	BR	4	N, L, M, J, K
-49470R0-395-C-	SM-32C395-H-240	3.9	K, M	BR	3	A, B, D, C, F
-49470R0-475-C-	SM-32C475-H-240	4.7	K, M	BR	3	N, L, M, J, K
-49470R0-565-C-	SM-32C565-H-240	5.6	K, M	BR	3	N, L, M, J, K
-49470R0-685-C-	SM-32C685-H-360	6.8	K, M	BR	3	N, L, M, J, K
-49470R0-825-C-	SM-32C825-H-360	8.2	K, M	BR	3	N, L, M, J, K
-49470R0-106-C-	SM-32C106-H-480	10	K, M	BR	3	N, L, M, J, K
-49470R0-126-C-	SM-32C126-H-650	12	K, M	BR	3	N, L, M, J, K
-49470R0-126-C-	SM-22C126-H-240	12	K, M	BR	2	A, B, D, C, F
-49470R0-156-C-	SM-12C156-H-360	15	K, M	BR	1	N, L, M, J, K
-49470R0-156-C-	SM-22C156-H-240	15	K, M	BR	2	A, B, D, C, F
-49470R0-186-C-	SM-12C186-H-480	18	K, M	BR	1	N, L, M, J, K
-49470R0-186-C-	SM-22C186-H-360	18	K, M	BR	2	A, B, D, C, F

1/ Complete PIN shall include additional symbols replacing dashes (from left to right): product level (M for B level, or T for T level), part style (1 for unencapsulated, 2 for encapsulated), capacitance tolerance, lead configuration

2/ Complete AVX Part Number (provided for reference only) shall include additional symbols replacing dashes (from left to right): part style (0 for unencapsulated and 9 for encapsulated), capacitance tolerance, lead configuration

The last 3 digits of the AVX Part Number represent the chip height of the unencapsulated version. For the encapsulated version, replace the last 3 digits as follows: (120 replace with 270, 240 replace with 390, 360 replace with 530, 480 replace with 660 and 650 replace with 800).

# SMPS Stacked MLC Capacitors

## (SM Style) SM Military Styles MIL-PRF-49470

MIL-PRF-49470 PIN 1/	AVX PART NUMBER (for reference only) 2/	Capacitance µF	Tolerance	Characteristic	Case Code	Lead Configuration
-49470R0-226-C-	SM-12C226-H-650	22	K, M	BR	1	N, L, M, J, K
-49470R0-226-C-	SM-22C226-H-360	22	K, M	BR	2	A, B, D, C, F
-49470R0-276-C-	SM-12C276-H-650	27	K, M	BR	1	N, L, M, J, K
-49470R0-276-C-	SM-22C276-H-480	27	K, M	BR	2	A, B, D, C, F
-49470R0-336-C-	SM-22C336-H-480	33	K, M	BR	2	N, L, M, J, K
-49470R0-396-C-	SM-22C396-H-650	39	K, M	BR	2	N, L, M, J, K
-49470R0-476-C-	SM-62C476-H-240	47	K, M	BR	6	N, L, M, J, K
-49470R0-566-C-	SM-62C566-H-360	56	K, M	BR	6	N, L, M, J, K
-49470R0-686-C-	SM-62C686-H-360	68	K, M	BR	6	N, L, M, J, K
-49470R0-826-C-	SM-62C826-H-480	82	K, M	BR	6	N, L, M, J, K
-49470R0-107-C-	SM-62C107-H-650	100	K, M	BR	6	N, L, M, J, K
-49470R0-127-C-	SM-62C127-H-650	120	K, M	BR	6	N, L, M, J, K
<b>500V</b>						
-49470P0-103-E-	SM-57A103-H-120	0.01	J, K	BP	5	N, L, M, J, K
-49470P0-123-E-	SM-57A123-H-240	0.012	J, K	BP	5	N, L, M, J, K
-49470P0-153-E-	SM-57A153-H-240	0.015	J, K	BP	5	N, L, M, J, K
-49470P0-183-E-	SM-57A183-H-240	0.018	J, K	BP	5	N, L, M, J, K
-49470P0-223-E-	SM-57A223-H-360	0.022	J, K	BP	5	N, L, M, J, K
-49470P0-273-E-	SM-57A273-H-360	0.027	J, K	BP	5	N, L, M, J, K
-49470P0-333-E-	SM-57A333-H-480	0.033	J, K	BP	5	N, L, M, J, K
-49470P0-333-E-	SM-47A333-H-240	0.033	J, K	BP	4	A, B, C, D, F
-49470P0-393-E-	SM-57A393-H-480	0.039	J, K	BP	5	N, L, M, J, K
-49470P0-393-E-	SM-47A393-H-240	0.039	J, K	BP	4	A, B, C, D, F
-49470P0-473-E-	SM-57A473-H-650	0.047	J, K	BP	5	N, L, M, J, K
-49470P0-473-E-	SM-47A473-H-360	0.047	J, K	BP	4	A, B, C, D, F
-49470P0-563-E-	SM-47A563-H-360	0.056	J, K	BP	4	N, L, M, J, K
-49470P0-683-E-	SM-47A683-H-360	0.068	J, K	BP	4	N, L, M, J, K
-49470P0-823-E-	SM-47A823-H-480	0.082	J, K	BP	4	N, L, M, J, K
-49470P0-104-E-	SM-47A104-H-480	0.1	J, K	BP	4	N, L, M, J, K
-49470P0-124-E-	SM-47A124-H-650	0.12	J, K	BP	4	N, L, M, J, K
-49470P0-124-E-	SM-37A124-H-240	0.12	J, K	BP	3	A, B, C, D, F
-49470P0-154-E-	SM-37A154-H-240	0.15	J, K	BP	3	N, L, M, J, K
-49470Q0-154-E-	SM-57C154-H-120	0.15	K, M	BQ	5	N, L, M, J, K
-49470P0-184-E-	SM-37A184-H-240	0.18	J, K	BP	3	N, L, M, J, K
-49470Q0-184-E-	SM-57C184-H-240	0.18	K, M	BQ	5	N, L, M, J, K
-49470P0-224-E-	SM-37A224-H-360	0.22	J, K	BP	3	N, L, M, J, K
-49470Q0-224-E-	SM-57C224-H-240	0.22	K, M	BQ	5	N, L, M, J, K
-49470P0-274-E-	SM-37A274-H-360	0.27	J, K	BP	3	N, L, M, J, K
-49470Q0-274-E-	SM-57C274-H-240	0.27	K, M	BQ	5	N, L, M, J, K
-49470P0-334-E-	SM-37A334-H-480	0.33	J, K	BP	3	N, L, M, J, K
-49470Q0-334-E-	SM-57C334-H-360	0.33	K, M	BQ	5	N, L, M, J, K
-49470P0-394-E-	SM-37A394-H-650	0.39	J, K	BP	3	N, L, M, J, K
-49470Q0-394-E-	SM-57C394-H-360	0.39	K, M	BQ	5	N, L, M, J, K
-49470Q0-474-E-	SM-57C474-H-360	0.47	K, M	BQ	5	N, L, M, J, K
-49470Q0-564-E-	SM-57C564-H-480	0.56	K, M	BQ	5	N, L, M, J, K
-49470Q0-564-E-	SM-47C564-H-240	0.56	K, M	BQ	4	A, B, D, C, F
-49470Q0-684-E-	SM-57C684-H-650	0.68	K, M	BQ	5	N, L, M, J, K
-49470Q0-684-E-	SM-47C684-H-240	0.68	K, M	BQ	4	A, B, D, C, F
-49470Q0-824-E-	SM-47C824-H-360	0.82	K, M	BQ	4	N, L, M, J, K
-49470Q0-105-E-	SM-47C105-H-360	1	K, M	BQ	4	N, L, M, J, K
-49470Q0-125-E-	SM-47C125-H-360	1.2	K, M	BQ	4	N, L, M, J, K
-49470Q0-155-E-	SM-47C155-H-480	1.5	K, M	BQ	4	N, L, M, J, K
-49470Q0-185-E-	SM-47C185-H-650	1.8	K, M	BQ	4	N, L, M, J, K
-49470Q0-185-E-	SM-37C185-H-240	1.8	K, M	BQ	3	A, B, D, C, F
-49470Q0-225-E-	SM-37C225-H-240	2.2	K, M	BQ	3	N, L, M, J, K
-49470Q0-275-E-	SM-37C275-H-360	2.7	K, M	BQ	3	N, L, M, J, K
-49470Q0-335-E-	SM-37C335-H-360	3.3	K, M	BQ	3	N, L, M, J, K

1/ Complete PIN shall include additional symbols replacing dashes (from left to right): product level (M for B level, or T for T level), part style (1 for unencapsulated, 2 for encapsulated), capacitance tolerance, lead configuration

2/ Complete AVX Part Number (provided for reference only) shall include additional symbols replacing dashes (from left to right): part style (0 for unencapsulated and 9 for encapsulated), capacitance tolerance, lead configuration

The last 3 digits of the AVX Part Number represent the chip height of the unencapsulated version. For the encapsulated version, replace the last 3 digits as follows: (120 replace with 270, 240 replace with 390, 360 replace with 530, 480 replace with 660 and 650 replace with 800).



# SMPS Stacked MLC Capacitors

## (SM Style) SM Military Styles MIL-PRF-49470

MIL-PRF-49470 PIN 1/	AVX PART NUMBER (for reference only) 2/	Capacitance µF	Tolerance	Characteristic	Case Code	Lead Configuration
-49470Q0-395-E-	SM-37C395-H-360	3.9	K, M	BQ	3	N, L, M, J, K
-49470Q0-475-E-	SM-37C475-H-480	4.7	K, M	BQ	3	N, L, M, J, K
-49470Q0-565-E-	SM-37C565-H-650	5.6	K, M	BQ	3	N, L, M, J, K
-49470Q0-565-E-	SM-27C565-H-240	5.6	K, M	BQ	2	A, B, D, C, F
-49470Q0-685-E-	SM-17C685-H-480	6.8	K, M	BQ	1	N, L, M, J, K
-49470Q0-685-E-	SM-27C685-H-240	6.8	K, M	BQ	2	A, B, D, C, F
-49470Q0-825-E-	SM-17C825-H-480	8.2	K, M	BQ	1	N, L, M, J, K
-49470Q0-825-E-	SM-27C825-H-360	8.2	K, M	BQ	2	A, B, D, C, F
-49470Q0-106-E-	SM-17C106-H-480	10	K, M	BQ	1	N, L, M, J, K
-49470Q0-106-E-	SM-27C106-H-360	10	K, M	BQ	2	A, B, D, C, F
-49470Q0-126-E-	SM-17C126-H-650	12	K, M	BQ	1	N, L, M, J, K
-49470Q0-126-E-	SM-27C126-H-480	12	K, M	BQ	2	A, B, D, C, F
-49470Q0-156-E-	SM-27C156-H-650	15	K, M	BQ	2	N, L, M, J, K
-49470Q0-186-E-	SM-27C186-H-650	18	K, M	BQ	2	N, L, M, J, K
-49470Q0-226-E-	SM-67C226-H-360	22	K, M	BQ	6	N, L, M, J, K
-49470Q0-276-E-	SM-67C276-H-360	27	K, M	BQ	6	N, L, M, J, K
-49470Q0-336-E-	SM-67C336-H-480	33	K, M	BQ	6	N, L, M, J, K
-49470Q0-396-E-	SM-67C396-H-650	39	K, M	BQ	6	N, L, M, J, K

1/ Complete PIN shall include additional symbols replacing dashes (from left to right): product level (M for B level, or T for T level), part style (1 for unencapsulated, 2 for encapsulated), capacitance tolerance, lead configuration

2/ Complete AVX Part Number (provided for reference only) shall include additional symbols replacing dashes (from left to right): part style (0 for unencapsulated and 9 for encapsulated), capacitance tolerance, lead configuration

The last 3 digits of the AVX Part Number represent the chip height of the unencapsulated version. For the encapsulated version, replace the last 3 digits as follows: (120 replace with 270, 240 replace with 390, 360 replace with 530, 480 replace with 660 and 650 replace with 800).

# SMPS Stacked MLC Capacitors

(SM Style) SM Military Styles DSCC Dwg. #87106 & #88011

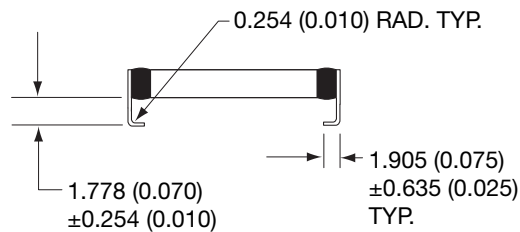
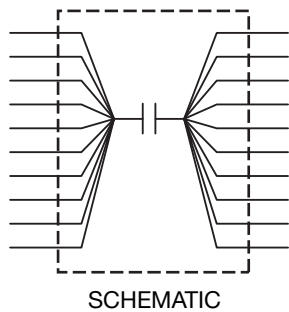
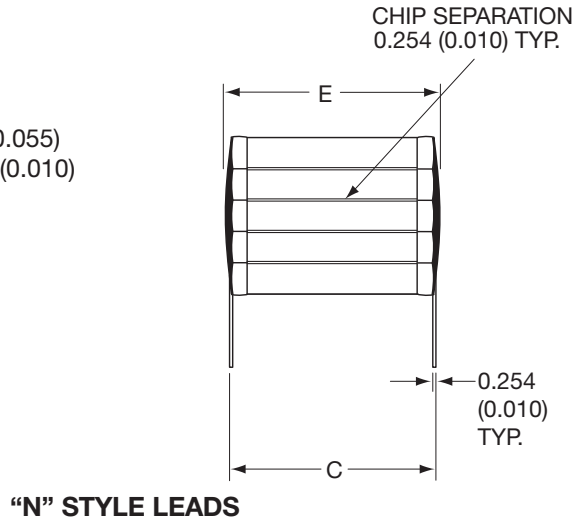
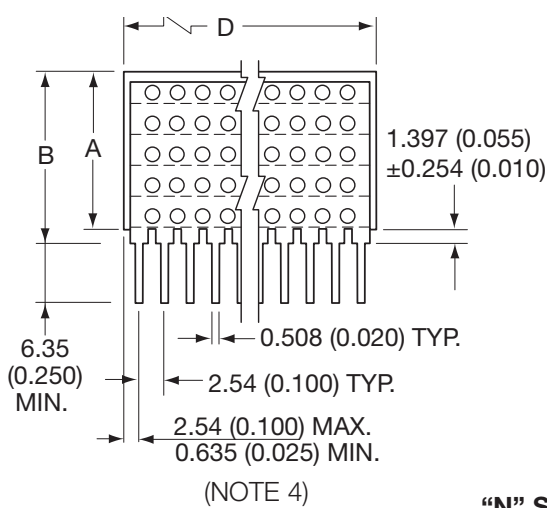

## DIMENSIONS

millimeters (inches)

Case Code	A (max.) (See Note 2)	B (max.) (See Note 2)	C ±.635 (±0.025)	D ±.635 (±0.025)	E (max.)	No. of Leads per side
1	16.5 (0.650)	18.2 (0.715)	11.4 (0.450)	52.1 (2.050)	12.7 (0.500)	20
2	16.5 (0.650)	18.2 (0.715)	20.3 (0.800)	38.4 (1.510)	22.1 (0.870)	15
3	16.5 (0.650)	18.2 (0.715)	11.4 (0.450)	26.7 (1.050)	12.7 (0.500)	10
4	16.5 (0.650)	18.2 (0.715)	10.2 (0.400)	10.2 (0.400)	11.2 (0.440)	4
5	16.5 (0.650)	18.2 (0.715)	6.35 (0.250)	6.35 (0.250)	7.62 (0.300)	3
6	16.5 (0.650)	18.2 (0.715)	31.8 (1.250)	52.1 (2.050)	34.3 (1.350)	20

### NOTES:

1. Unless otherwise specified, tolerances 0.254 (±0.010).
2. “A” dimensions are maximum (see tables on pages 26 thru 29 for specific part number dimensions).
3. “N” straight leads; “J” leads formed in.
4. For case code 5, dimensions shall be 2.54 (0.100) maximum, 0.305 (0.012) minimum.





# SMPS Stacked MLC Capacitors

## (SM Style) DSCC #87106 and #88011

**Table II. Group A inspection.**

Inspection	Requirement paragraph of MIL-PRF-49470	Test method paragraph of MIL-PRF-49470	Sampling procedure
<b>Subgroup 1</b> Thermal shock and voltage conditioning <u>1/</u>	3.9	4.8.5	100% inspection
<b>Subgroup 2</b> Visual and mechanical examination: Material Physical dimensions Interface requirements (other than physical dimensions) Marking <u>2/</u> Workmanship	3.4 3.1 3.5 and 3.5.1 3.28 3.30	4.8.4	13 samples 0 failures

1/ Post checks are required (see paragraph 3.9 of MIL-PRF-49470).

2/ Marking defects are based on visual examination only. Any subsequent electrical defects shall not be used as a basis for determining marking defects.

**Table III. Group B inspection. 1/**

Inspection	Requirement paragraph of MIL-PRF-49470	Test method paragraph of MIL-PRF-49470	Number of sample units to be inspected	Number of defectives permitted <u>2/</u>	
<b>Subgroup 1 <u>3/</u></b> Temperature coefficient Resistance to solvents <u>5/</u> <u>6/</u> Immersion Terminal strength <u>5/</u>	<u>4/</u> 3.23 3.18 3.24	<u>4/</u> 4.8.20 4.8.15 4.8.10	12	1	<u>6/</u> 1
<b>Subgroup 2</b> Resistance to soldering heat Moisture resistance	3.20 3.21	4.8.17 4.8.18	12	1	
<b>Subgroup 3</b> Marking legibility (laser marking only)	3.28.1	4.8.4.1	6	1	
<b>Subgroup 4</b> Solderability	3.15	4.8.12	3	0	
<b>Subgroup 5</b> Life	3.26	4.8.22	5 minimum per case code	0	

1/ Unless otherwise specified herein, when necessary, mounting of group B samples shall be at the discretion of the manufacturer.

2/ A sample unit having one or more defects shall be charged as a single defective.

3/ Order of tests is at discretion of manufacturer.

4/ See 3.2.3 of DSCC 87106.

5/ Sample size shall be 3 pieces with zero defectives permitted.

6/ Total of one defect allowed for combination of subgroup 1, subgroup 2, and subgroup 3 inspections.

# SMPS Stacked MLC Capacitors

(SM Style) SM Military Styles DSCC Dwg. #87106 (X7R)

## Electrical characteristics

DSCC Dwg. 87106-	Cap. Value (µF)	Cap. Tol.	Case Code	Lead Style	Max. A Dimension mm (inches)
<b>50V</b>					
001	1.0	K	5	N	3.05 (0.120)
002	1.0	M	5	N	3.05 (0.120)
241	1.0	K	5	J	3.05 (0.120)
242	1.0	M	5	J	3.05 (0.120)
003	1.2	K	5	N	3.05 (0.120)
004	1.2	M	5	N	3.05 (0.120)
243	1.2	K	5	J	3.05 (0.120)
244	1.2	M	5	J	3.05 (0.120)
005	1.5	K	5	N	6.10 (0.240)
006	1.5	M	5	N	6.10 (0.240)
245	1.5	K	5	J	6.10 (0.240)
246	1.5	M	5	J	6.10 (0.240)
007	1.8	K	5	N	6.10 (0.240)
008	1.8	M	5	N	6.10 (0.240)
247	1.8	K	5	J	6.10 (0.240)
248	1.8	M	5	J	6.10 (0.240)
009	2.2	K	5	N	6.10 (0.240)
010	2.2	M	5	N	6.10 (0.240)
249	2.2	K	5	J	6.10 (0.240)
250	2.2	M	5	J	6.10 (0.240)
011	2.7	K	5	N	9.14 (0.360)
012	2.7	M	5	N	9.14 (0.360)
251	2.7	K	5	J	9.14 (0.360)
252	2.7	M	5	J	9.14 (0.360)
013	3.3	K	5	N	9.14 (0.360)
014	3.3	M	5	N	9.14 (0.360)
253	3.3	K	5	J	9.14 (0.360)
254	3.3	M	5	J	9.14 (0.360)
015	3.9	K	5	N	12.2 (0.480)
016	3.9	M	5	N	12.2 (0.480)
255	3.9	K	5	J	12.2 (0.480)
256	3.9	M	5	J	12.2 (0.480)
017	4.7	K	5	N	12.2 (0.480)
018	4.7	M	5	N	12.2 (0.480)
257	4.7	K	5	J	12.2 (0.480)
258	4.7	M	5	J	12.2 (0.480)
019	5.6	K	5	N	16.5 (0.650)
020	5.6	M	5	N	16.5 (0.650)
259	5.6	K	5	J	16.5 (0.650)
260	5.6	M	5	J	16.5 (0.650)
223	6.8	K	4	N	9.14 (0.360)
224	6.8	M	4	N	9.14 (0.360)
261	6.8	K	4	J	9.14 (0.360)
262	6.8	M	4	J	9.14 (0.360)
021	8.2	K	4	N	9.14 (0.360)
022	8.2	M	4	N	9.14 (0.360)
263	8.2	K	4	J	9.14 (0.360)
264	8.2	M	4	J	9.14 (0.360)
023	10	K	4	N	12.2 (0.480)
024	10	M	4	N	12.2 (0.480)
265	10	K	4	J	12.2 (0.480)
266	10	M	4	J	12.2 (0.480)
025	12	K	4	N	12.2 (0.480)
026	12	M	4	N	12.2 (0.480)
267	12	K	4	J	12.2 (0.480)
268	12	M	4	J	12.2 (0.480)
027	15	K	4	N	16.5 (0.650)
028	15	M	4	N	16.5 (0.650)
269	15	K	4	J	16.5 (0.650)
270	15	M	4	J	16.5 (0.650)
029	18	K	3	N	6.10 (0.240)
030	18	M	3	N	6.10 (0.240)
271	18	K	3	J	6.10 (0.240)

DSCC Dwg. 87106-	Cap. Value (µF)	Cap. Tol.	Case Code	Lead Style	Max. A Dimension mm (inches)
<b>50V</b>					
272	18	M	3	J	6.10 (0.240)
272	18	M	3	J	6.10 (0.240)
031	22	K	3	N	9.14 (0.360)
032	22	M	3	N	9.14 (0.360)
273	22	K	3	J	9.14 (0.360)
274	22	M	3	J	9.14 (0.360)
033	27	K	3	N	9.14 (0.360)
034	27	M	3	N	9.14 (0.360)
275	27	K	3	J	9.14 (0.360)
276	27	M	3	J	9.14 (0.360)
035	33	K	3	N	9.14 (0.360)
036	33	M	3	N	9.14 (0.360)
277	33	K	3	J	9.14 (0.360)
278	33	M	3	J	9.14 (0.360)
037	39	K	3	N	12.2 (0.480)
038	39	M	3	N	12.2 (0.480)
279	39	K	3	J	12.2 (0.480)
280	39	M	3	J	12.2 (0.480)
039	47	K	3	N	16.5 (0.650)
040	47	M	3	N	16.5 (0.650)
281	47	K	3	J	16.5 (0.650)
282	47	M	3	J	16.5 (0.650)
225	56	K	1	N	9.14 (0.360)
226	56	M	1	N	9.14 (0.360)
283	56	K	1	J	9.14 (0.360)
284	56	M	1	J	9.14 (0.360)
041	68	K	1	N	12.2 (0.480)
042	68	M	1	N	12.2 (0.480)
285	68	K	1	J	12.2 (0.480)
286	68	M	1	J	12.2 (0.480)
043	82	K	1	N	12.2 (0.480)
044	82	M	1	N	12.2 (0.480)
287	82	K	1	J	12.2 (0.480)
288	82	M	1	J	12.2 (0.480)
045	100	K	1	N	16.5 (0.650)
046	100	M	1	N	16.5 (0.650)
289	100	K	1	J	16.5 (0.650)
290	100	M	1	J	16.5 (0.650)
227	120	K	2	N	12.2 (0.480)
228	120	M	2	N	12.2 (0.480)
291	120	K	2	J	12.2 (0.480)
292	120	M	2	J	12.2 (0.480)
047	150	K	2	N	16.5 (0.650)
048	150	M	2	N	16.5 (0.650)
293	150	K	2	J	16.5 (0.650)
294	150	M	2	J	16.5 (0.650)
049	180	K	6	N	12.2 (0.480)
050	180	M	6	N	12.2 (0.480)
295	180	K	6	J	12.2 (0.480)
296	180	M	6	J	12.2 (0.480)
051	220	K	6	N	12.2 (0.480)
052	220	M	6	N	12.2 (0.480)
297	220	K	6	J	12.2 (0.480)
298	220	M	6	J	12.2 (0.480)
053	270	K	6	N	16.5 (0.650)
054	270	M	6	N	16.5 (0.650)
299	270	K	6	J	16.5 (0.650)
300	270	M	6	J	16.5 (0.650)

DSCC Dwg. 87106-	Cap. Value (µF)	Cap. Tol.	Case Code	Lead Style	Max. A Dimension mm (inches)
<b>100V</b>					
055	.68	K	5	N	3.05 (0.120)
056	.68	M	5	N	3.05 (0.120)
301	.68	K	5	J	3.05 (0.120)
302	.68	M	5	J	3.05 (0.120)
057	.82	K	5	N	6.10 (0.240)
058	.82	M	5	N	6.10 (0.240)
303	.82	K	5	J	6.10 (0.240)
304	.82	M	5	J	6.10 (0.240)
059	1.0	K	5	N	6.10 (0.240)
060	1.0	M	5	N	6.10 (0.240)
305	1.0	K	5	J	6.10 (0.240)
306	1.0	M	5	J	6.10 (0.240)
061	1.2	K	5	N	6.10 (0.240)
062	1.2	M	5	N	6.10 (0.240)
307	1.2	K	5	J	6.10 (0.240)
308	1.2	M	5	J	6.10 (0.240)
063	1.5	K	5	N	9.14 (0.360)
064	1.5	M	5	N	9.14 (0.360)
309	1.5	K	5	J	9.14 (0.360)
310	1.5	M	5	J	9.14 (0.360)
065	1.8	K	5	N	9.14 (0.360)
066	1.8	M	5	N	9.14 (0.360)
311	1.8	K	5	J	9.14 (0.360)
312	1.8	M	5	J	9.14 (0.360)
067	2.2	K	5	N	12.2 (0.480)
068	2.2	M	5	N	12.2 (0.480)
313	2.2	K	5	J	12.2 (0.480)
314	2.2	M	5	J	12.2 (0.480)
069	2.7	K	5	N	12.2 (0.480)
070	2.7	M	5	N	12.2 (0.480)
315	2.7	K	5	J	12.2 (0.480)
316	2.7	M	5	J	12.2 (0.480)
071	3.3	K	5	N	16.5 (0.650)
072	3.3	M	5	N	16.5 (0.650)
317	3.3	K	5	J	16.5 (0.650)
318	3.3	M	5	J	16.5 (0.650)
073	3.9	K	4	N	9.14 (0.360)
074	3.9	M	4	N	9.14 (0.360)
319	3.9	K	4	J	9.14 (0.360)
320	3.9	M	4	J	9.14 (0.360)
075	4.7	K	4	N	9.14 (0.360)
076	4.7	M	4	N	9.14 (0.360)
321	4.7	K	4	J	9.14 (0.360)
322	4.7	M	4	J	9.14 (0.360)
077	5.6	K	4	N	12.2 (0.480)
078	5.6	M	4	N	12.2 (0.480)
323	5.6	K	4	J	12.2 (0.480)
324	5.6	M	4	J	12.2 (0.480)
079	6.8	K	4	N	12.2 (0.480)
080	6.8	M	4	N	12.2 (0.480)
325	6.8	K	4	J	12.2 (0.480)
326	6.8	M	4	J	12.2 (0.480)
081	8.2	K	4	N	16.5 (0.650)
082	8.2	M	4	N	16.5 (0.650)
327	8.2	K	4	J	16.5 (0.650)
328	8.2	M	4	J	16.5 (0.650)
229	10	K	3	N	6.10 (0.240)
230	10	M	3	N	6.10 (0.240)
329	10	K	3	J	6.10 (0.240)
330	10	M	3	J	6.10 (0.240)
083	12	K	3	N	6.10 (0.240)
084	12	M	3	N	6.10 (0.240)
331	12	K	3	J	6.10 (0.240)
332	12	M	3	J	6.10 (0.240)

# SMPS Stacked MLC Capacitors

(SM Style) SM Military Styles DSCC Dwg. #87106 (X7R)

## Electrical characteristics

DSCC Dwg. 87106-	Cap. Value (µF)	Cap. Tol.	Case Code	Lead Style	Max. A Dimension mm (inches)
<b>100V</b>					
085	15	K	3	N	9.14 (0.360)
086	15	M	3	N	9.14 (0.360)
333	15	K	3	J	9.14 (0.360)
334	15	M	3	J	9.14 (0.360)
087	18	K	3	N	9.14 (0.360)
088	18	M	3	N	9.14 (0.360)
335	18	K	3	J	9.14 (0.360)
336	18	M	3	J	9.14 (0.360)
089	22	K	3	N	12.2 (0.480)
090	22	M	3	N	12.2 (0.480)
337	22	M	3	K	12.2 (0.480)
338	22	M	3	J	12.2 (0.480)
091	27	K	3	N	16.5 (0.650)
092	27	M	3	N	16.5 (0.650)
339	27	K	3	J	16.5 (0.650)
340	27	M	3	J	16.5 (0.650)
093	33	K	1	N	9.14 (0.360)
094	33	M	1	N	9.14 (0.360)
341	33	K	1	J	9.14 (0.360)
342	33	M	1	J	9.14 (0.360)
095	39	K	1	N	12.2 (0.480)
096	39	M	1	N	12.2 (0.480)
343	39	K	1	J	12.2 (0.480)
344	39	M	1	J	12.2 (0.480)
097	47	K	1	N	12.2 (0.480)
098	47	M	1	N	12.2 (0.480)
345	47	K	1	J	12.2 (0.480)
346	47	M	1	J	12.2 (0.480)
099	56	K	1	N	16.5 (0.650)
100	56	M	1	N	16.5 (0.650)
347	56	K	1	J	16.5 (0.650)
348	56	M	1	J	16.5 (0.650)
101	68	K	2	N	12.2 (0.480)
102	68	M	2	N	12.2 (0.480)
349	68	K	2	J	12.2 (0.480)
350	68	M	2	J	12.2 (0.480)
103	82	K	2	N	16.5 (0.650)
104	82	M	2	N	16.5 (0.650)
351	82	K	2	J	16.5 (0.650)
352	82	M	2	J	16.5 (0.650)
105	100	K	6	N	9.14 (0.360)
106	100	M	6	N	9.14 (0.360)
353	100	K	6	J	9.14 (0.360)
354	100	M	6	J	9.14 (0.360)
107	120	K	6	N	9.14 (0.360)
108	120	M	6	N	9.14 (0.360)
355	120	K	6	J	9.14 (0.360)
356	120	M	6	J	9.14 (0.360)
109	150	K	6	N	12.2 (0.480)
110	150	M	6	N	12.2 (0.480)
357	150	K	6	J	12.2 (0.480)
358	150	M	6	J	12.2 (0.480)
111	180	K	6	N	16.5 (0.650)
112	180	M	6	N	16.5 (0.650)
359	180	K	6	J	16.5 (0.650)
360	180	M	6	J	16.5 (0.650)

DSCC Dwg. 87106-	Cap. Value (µF)	Cap. Tol.	Case Code	Lead Style	Max. A Dimension mm (inches)
<b>200V</b>					
113	.47	K	5	N	6.10 (0.240)
114	.47	M	5	N	6.10 (0.240)
361	.47	K	5	J	6.10 (0.240)
362	.47	M	5	J	6.10 (0.240)
115	.56	K	5	N	6.10 (0.240)
116	.56	M	5	N	6.10 (0.240)
363	.56	K	5	J	6.10 (0.240)
364	.56	M	5	J	6.10 (0.240)
117	.68	K	5	N	9.14 (0.360)
118	.68	M	5	N	9.14 (0.360)
365	.68	K	5	J	9.14 (0.360)
366	.68	M	5	J	9.14 (0.360)
119	.82	K	5	N	9.14 (0.360)
120	.82	M	5	N	9.14 (0.360)
367	.82	M	5	J	9.14 (0.360)
368	.82	M	5	J	9.14 (0.360)
121	1.0	K	5	N	12.2 (0.480)
122	1.0	M	5	N	12.2 (0.480)
369	1.0	K	5	J	12.2 (0.480)
370	1.0	M	5	J	12.2 (0.480)
123	1.2	K	5	N	12.2 (0.480)
124	1.2	M	5	N	12.2 (0.480)
371	1.2	K	5	J	12.2 (0.480)
372	1.2	M	5	J	12.2 (0.480)
125	1.5	K	5	N	16.5 (0.650)
126	1.5	M	5	N	16.5 (0.650)
373	1.5	K	5	J	16.5 (0.650)
374	1.5	M	5	J	16.5 (0.650)
127	1.8	K	4	N	9.14 (0.360)
128	1.8	M	4	N	9.14 (0.360)
375	1.8	K	4	J	9.14 (0.360)
376	1.8	M	4	J	9.14 (0.360)
129	2.2	K	4	N	9.14 (0.360)
130	2.2	M	4	N	9.14 (0.360)
377	2.2	K	4	J	9.14 (0.360)
378	2.2	M	4	J	9.14 (0.360)
131	2.7	K	4	N	12.2 (0.480)
132	2.7	M	4	N	12.2 (0.480)
379	2.7	K	4	J	12.2 (0.480)
380	2.7	M	4	J	12.2 (0.480)
133	3.3	K	4	N	12.2 (0.480)
134	3.3	M	4	N	12.2 (0.480)
381	3.3	K	4	J	12.2 (0.480)
382	3.3	M	4	J	12.2 (0.480)
135	3.9	K	4	N	16.5 (0.650)
136	3.9	M	4	N	16.5 (0.650)
383	3.9	K	4	J	16.5 (0.650)
384	3.9	M	4	J	16.5 (0.650)
137	4.7	K	3	N	6.10 (0.240)
138	4.7	M	3	N	6.10 (0.240)
385	4.7	K	3	J	6.10 (0.240)
386	4.7	M	3	J	6.10 (0.240)
139	5.6	K	3	N	6.10 (0.240)
140	5.6	M	3	N	6.10 (0.240)
387	5.6	K	3	J	6.10 (0.240)
388	5.6	M	3	J	6.10 (0.240)
141	6.8	K	3	N	9.14 (0.360)
142	6.8	M	3	N	9.14 (0.360)
389	6.8	K	3	J	9.14 (0.360)
390	6.8	M	3	J	9.14 (0.360)
143	8.2	K	3	N	9.14 (0.360)
144	8.2	M	3	N	9.14 (0.360)
391	8.2	K	3	J	9.14 (0.360)
392	8.2	M	3	J	9.14 (0.360)

DSCC Dwg. 87106-	Cap. Value (µF)	Cap. Tol.	Case Code	Lead Style	Max. A Dimension mm (inches)
<b>200V</b>					
145	10	K	3	N	12.2 (0.480)
146	10	M	3	N	12.2 (0.480)
393	10	K	3	J	12.2 (0.480)
394	10	M	3	J	12.2 (0.480)
147	12	K	3	N	16.5 (0.650)
148	12	M	3	N	16.5 (0.650)
395	12	K	3	J	16.5 (0.650)
396	12	M	3	J	16.5 (0.650)
149	15	K	1	N	9.14 (0.360)
150	15	M	1	N	9.14 (0.360)
397	15	K	1	J	9.14 (0.360)
398	15	M	1	J	9.14 (0.360)
151	18	K	1	N	12.2 (0.480)
152	18	M	1	N	12.2 (0.480)
399	18	K	1	J	12.2 (0.480)
400	18	M	1	J	12.2 (0.480)
153	22	K	1	N	16.5 (0.650)
154	22	M	1	N	16.5 (0.650)
401	22	K	1	J	16.5 (0.650)
402	22	M	1	J	16.5 (0.650)
155	27	K	1	N	16.5 (0.650)
156	27	M	1	N	16.5 (0.650)
403	27	K	1	J	16.5 (0.650)
404	27	M	1	J	16.5 (0.650)
157	33	K	2	N	12.2 (0.480)
158	33	M	2	N	12.2 (0.480)
405	33	K	2	J	12.2 (0.480)
406	33	M	2	J	12.2 (0.480)
159	39	K	2	N	16.5 (0.650)
160	39	M	2	N	16.5 (0.650)
407	39	K	2	J	16.5 (0.650)
408	39	M	2	J	16.5 (0.650)
161	47	K	6	N	6.10 (0.240)
162	47	M	6	N	6.10 (0.240)
409	47	K	6	J	6.10 (0.240)
410	47	M	6	J	6.10 (0.240)
163	56	K	6	N	9.14 (0.360)
164	56	M	6	N	9.14 (0.360)
411	56	K	6	J	9.14 (0.360)
412	56	M	6	J	9.14 (0.360)
165	68	K	6	N	9.14 (0.360)
166	68	M	6	N	9.14 (0.360)
413	68	K	6	J	9.14 (0.360)
414	68	M	6	J	9.14 (0.360)
167	82	K	6	N	12.2 (0.480)
168	82	M	6	N	12.2 (0.480)
415	82	K	6	J	12.2 (0.480)
416	82	M	6	J	12.2 (0.480)
169	100	K	6	N	16.5 (0.650)
170	100	M	6	N	16.5 (0.650)
417	100	K	6	J	16.5 (0.650)
418	100	M	6	J	16.5 (0.650)
171	120	K	6	N	16.5 (0.650)
172	120	M	6	N	16.5 (0.650)
419	120	K	6	J	16.5 (0.650)
420	120	M	6	J	16.5 (0.650)



# SMPS Stacked MLC Capacitors

(SM Style) SM Military Styles DSCC Dwg. #87106 (X7R)

## Electrical characteristics

DSCC Dwg. 87106-	Cap. Value (µF)	Cap. Tol.	Case Code	Lead Style	Max. A Dimension mm (inches)
<b>500V</b>					
173	.15	K	5	N	3.05 (0.120)
174	.15	M	5	N	3.05 (0.120)
421	.15	K	5	J	3.05 (0.120)
422	.15	M	5	J	3.05 (0.120)
175	.18	K	5	N	6.10 (0.240)
176	.18	M	5	N	6.10 (0.240)
423	.18	K	5	J	6.10 (0.240)
424	.18	M	5	J	6.10 (0.240)
177	.22	K	5	N	6.10 (0.240)
178	.22	M	5	N	6.10 (0.240)
425	.22	K	5	J	6.10 (0.240)
426	.22	M	5	J	6.10 (0.240)
179	.27	K	5	N	6.10 (0.240)
180	.27	M	5	N	6.10 (0.240)
427	.27	K	5	J	6.10 (0.240)
428	.27	M	5	J	6.10 (0.240)
181	.33	K	5	N	9.14 (0.360)
182	.33	M	5	N	9.14 (0.360)
429	.33	K	5	J	9.14 (0.360)
430	.33	M	5	J	9.14 (0.360)
183	.39	K	5	N	9.14 (0.360)
184	.39	M	5	N	9.14 (0.360)
431	.39	K	5	J	9.14 (0.360)
432	.39	M	5	J	9.14 (0.360)
185	.47	K	5	N	9.14 (0.360)
186	.47	M	5	N	9.14 (0.360)
433	.47	K	5	J	9.14 (0.360)
434	.47	M	5	J	9.14 (0.360)
187	.56	K	5	N	12.2 (0.480)
188	.56	M	5	N	12.2 (0.480)
435	.56	K	5	J	12.2 (0.480)
436	.56	M	5	J	12.2 (0.480)
189	.68	K	5	N	16.5 (0.650)
190	.68	M	5	N	16.5 (0.650)
437	.68	K	5	J	16.5 (0.650)
438	.68	M	5	J	16.5 (0.650)
231	.82	K	4	N	9.14 (0.360)
232	.82	M	4	N	9.14 (0.360)
439	.82	K	4	J	9.14 (0.360)
440	.82	M	4	J	9.14 (0.360)
191	1.0	K	4	N	9.14 (0.360)
192	1.0	M	4	N	9.14 (0.360)
441	1.0	K	4	J	9.14 (0.360)
442	1.0	M	4	J	9.14 (0.360)
193	1.2	K	4	N	9.14 (0.360)
194	1.2	M	4	N	9.14 (0.360)
443	1.2	K	4	J	9.14 (0.360)
444	1.2	M	4	J	9.14 (0.360)
195	1.5	K	4	N	12.2 (0.480)
196	1.5	M	4	N	12.2 (0.480)
445	1.5	K	4	J	12.2 (0.480)
446	1.5	M	4	J	12.2 (0.480)
197	1.8	K	4	N	16.5 (0.650)
198	1.8	M	4	N	16.5 (0.650)
447	1.8	K	4	J	16.5 (0.650)
448	1.8	M	4	J	16.5 (0.650)
233	2.2	K	3	N	6.10 (0.240)
234	2.2	M	3	N	6.10 (0.240)
449	2.2	K	3	J	6.10 (0.240)
450	2.2	M	3	J	6.10 (0.240)
199	2.7	K	3	N	9.14 (0.360)
200	2.7	M	3	N	9.14 (0.360)
451	2.7	K	3	J	9.14 (0.360)
452	2.7	M	3	J	9.14 (0.360)

DSCC Dwg. 87106-	Cap. Value (µF)	Cap. Tol.	Case Code	Lead Style	Max. A Dimension mm (inches)
<b>500V</b>					
201	3.3	K	3	N	9.14 (0.360)
202	3.3	M	3	N	9.14 (0.360)
453	3.3	K	3	J	9.14 (0.360)
454	3.3	M	3	J	9.14 (0.360)
203	3.9	K	3	N	9.14 (0.360)
204	3.9	M	3	N	9.14 (0.360)
455	3.9	K	3	J	9.14 (0.360)
456	3.9	M	3	J	9.14 (0.360)
205	4.7	K	3	N	12.2 (0.480)
206	4.7	M	3	N	12.2 (0.480)
457	4.7	K	3	J	12.2 (0.480)
458	4.7	M	3	J	12.2 (0.480)
207	5.6	K	3	N	16.5 (0.650)
208	5.6	M	3	N	16.5 (0.650)
459	5.6	K	3	J	16.5 (0.650)
460	5.6	M	3	J	16.5 (0.650)
235	6.8	K	1	N	12.2 (0.480)
236	6.8	M	1	N	12.2 (0.480)
461	6.8	K	1	J	12.2 (0.480)
462	6.8	M	1	J	12.2 (0.480)
209	8.2	K	1	N	12.2 (0.480)
210	8.2	M	1	N	12.2 (0.480)
463	8.2	K	1	J	12.2 (0.480)
464	8.2	M	1	J	12.2 (0.480)
211	10	K	1	N	12.2 (0.480)
212	10	M	1	N	12.2 (0.480)
465	10	K	1	J	12.2 (0.480)
466	10	M	1	J	12.2 (0.480)
213	12	K	1	N	16.5 (0.650)
214	12	M	1	N	16.5 (0.650)
467	12	K	1	J	16.5 (0.650)
468	12	M	1	J	16.5 (0.650)
237	15	K	2	N	16.5 (0.650)
238	15	M	2	N	16.5 (0.650)
469	15	K	2	J	16.5 (0.650)
470	15	M	2	J	16.5 (0.650)
215	18	K	2	N	16.5 (0.650)
216	18	M	2	N	16.5 (0.650)
471	18	K	2	J	16.5 (0.650)
472	18	M	2	J	16.5 (0.650)
239	22	K	6	N	9.14 (0.360)
240	22	M	6	N	9.14 (0.360)
473	22	K	6	J	9.14 (0.360)
474	22	M	6	J	9.14 (0.360)
217	27	K	6	N	9.14 (0.360)
218	27	M	6	N	9.14 (0.360)
475	27	K	6	J	9.14 (0.360)
476	27	M	6	J	9.14 (0.360)
219	33	K	6	N	12.2 (0.480)
220	33	M	6	N	12.2 (0.480)
477	33	K	6	J	12.2 (0.480)
478	33	M	6	J	12.2 (0.480)
221	39	K	6	N	16.5 (0.650)
222	39	M	6	N	16.5 (0.650)
479	39	K	6	J	16.5 (0.650)
480	39	M	6	J	16.5 (0.650)

# SMPS Stacked MLC Capacitors

(SM Style) SM Military Styles DSCC Dwg. #88011 (C0G)

## CG (C0G) Electrical characteristics per MIL-C-20

DSCC Dwg. 88011-	Cap. Value (µF)	Cap. Tol.	Case Code	Lead Style	Max. A Dimension mm (inches)
<b>50V</b>					
001*	.056	J	5	N	3.05 (0.120)
002*	.056	K	5	N	3.05 (0.120)
003*	.068	J	5	N	6.10 (0.240)
004*	.068	K	5	N	6.10 (0.240)
005*	.082	J	5	N	6.10 (0.240)
006*	.082	K	5	N	6.10 (0.240)
007*	.10	J	5	N	6.10 (0.240)
008*	.10	K	5	N	6.10 (0.240)
009*	.12	J	5	N	9.14 (0.360)
010*	.12	K	5	N	9.14 (0.360)
011*	.15	J	5	N	9.14 (0.360)
012*	.15	K	5	N	9.14 (0.360)
013*	.18	J	5	N	12.2 (0.480)
014*	.18	K	5	N	12.2 (0.480)
015*	.22	J	5	N	12.2 (0.480)
016*	.22	K	5	N	12.2 (0.480)
017*	.27	J	5	N	16.5 (0.650)
018*	.27	K	5	N	16.5 (0.650)
019*	.33	J	4	N	9.14 (0.360)
020*	.33	K	4	N	9.14 (0.360)
021*	.39	J	4	N	12.2 (0.480)
022*	.39	K	4	N	12.2 (0.480)
023*	.47	J	4	N	12.2 (0.480)
024*	.47	K	4	N	12.2 (0.480)
025*	.56	J	4	N	16.5 (0.650)
026*	.56	K	4	N	16.5 (0.650)
027*	.68	J	3	N	6.10 (0.240)
028*	.68	K	3	N	6.10 (0.240)
029*	.82	J	3	N	6.10 (0.240)
030*	.82	K	3	N	6.10 (0.240)
031*	1.0	J	3	N	9.14 (0.360)
032*	1.0	K	3	N	9.14 (0.360)
033*	1.2	J	3	N	9.14 (0.360)
034*	1.2	K	3	N	9.14 (0.360)
035*	1.5	J	3	N	12.2 (0.480)
036*	1.5	K	3	N	12.2 (0.480)
037*	1.8	J	3	N	12.2 (0.480)
038*	1.8	K	3	N	12.2 (0.480)
039*	2.2	J	3	N	16.5 (0.650)
040*	2.2	K	3	N	16.5 (0.650)
041*	2.7	J	1	N	9.14 (0.360)
042*	2.7	K	1	N	9.14 (0.360)
043*	3.3	J	1	N	12.2 (0.480)
044*	3.3	K	1	N	12.2 (0.480)
045*	3.9	J	1	N	12.2 (0.480)
046*	3.9	K	1	N	12.2 (0.480)
047*	4.7	J	1	N	16.5 (0.650)
048*	4.7	K	1	N	16.5 (0.650)
049*	5.6	J	2	N	16.5 (0.650)
050*	5.6	K	2	N	16.5 (0.650)
051*	6.8	J	6	N	9.14 (0.360)
052*	6.8	K	6	N	9.14 (0.360)
053*	8.2	J	6	N	9.14 (0.360)
054*	8.2	K	6	N	9.14 (0.360)
055*	10	J	6	N	12.2 (0.480)
056*	10	K	6	N	12.2 (0.480)
057*	12	J	6	N	12.2 (0.480)
058*	12	K	6	N	12.2 (0.480)
059*	15	J	6	N	16.5 (0.650)
060*	15	K	6	N	16.5 (0.650)
<b>100V</b>					
061*	.047	J	5	N	6.10 (0.240)
062*	.047	K	5	N	6.10 (0.240)
063*	.056	J	5	N	6.10 (0.240)
064*	.056	K	5	N	6.10 (0.240)
065*	.068	J	5	N	6.10 (0.240)
066*	.068	K	5	N	6.10 (0.240)
067*	.082	J	5	N	6.10 (0.240)
068*	.082	K	5	N	6.10 (0.240)
069*	.10	J	5	N	9.14 (0.360)
070*	.10	K	5	N	9.14 (0.360)
071*	.12	J	5	N	9.14 (0.360)
072*	.12	K	5	N	9.14 (0.360)
073*	.15	J	5	N	12.2 (0.480)
074*	.15	K	5	N	12.2 (0.480)
075*	.18	J	5	N	12.2 (0.480)
076*	.18	K	5	N	12.2 (0.480)
077*	.22	J	5	N	16.5 (0.650)
078*	.22	K	5	N	16.5 (0.650)
079*	.27	J	4	N	9.14 (0.360)

DSCC Dwg. 88011-	Cap. Value (µF)	Cap. Tol.	Case Code	Lead Style	Max. A Dimension mm (inches)
<b>100V (continued)</b>					
080*	.27	K	4	N	9.14 (0.360)
081*	.33	J	4	N	12.2 (0.480)
082*	.33	K	4	N	12.2 (0.480)
083*	.39	J	4	N	12.2 (0.480)
084*	.39	K	4	N	12.2 (0.480)
085*	.47	J	4	N	16.5 (0.650)
086*	.47	K	4	N	16.5 (0.650)
087*	.56	J	4	N	16.5 (0.650)
088*	.56	K	4	N	16.5 (0.650)
089*	.68	J	3	N	6.10 (0.240)
090*	.68	K	3	N	6.10 (0.240)
091*	.82	J	3	N	9.14 (0.360)
092*	.82	K	3	N	9.14 (0.360)
093*	1.0	J	3	N	9.14 (0.360)
094*	1.0	K	3	N	9.14 (0.360)
095*	1.2	J	3	N	12.2 (0.480)
096*	1.2	K	3	N	12.2 (0.480)
097*	1.5	J	3	N	12.2 (0.480)
098*	1.5	K	3	N	12.2 (0.480)
099*	1.8	J	3	N	16.5 (0.650)
100*	1.8	K	3	N	16.5 (0.650)
101*	2.2	J	1	N	12.2 (0.480)
102*	2.2	K	1	N	12.2 (0.480)
103*	2.7	J	1	N	12.2 (0.480)
104*	2.7	K	1	N	12.2 (0.480)
105*	3.3	J	1	N	16.5 (0.650)
106*	3.3	K	1	N	16.5 (0.650)
107*	3.9	J	2	N	12.2 (0.480)
108*	3.9	K	2	N	12.2 (0.480)
109*	4.7	J	2	N	16.5 (0.650)
110*	4.7	K	2	N	16.5 (0.650)
111*	5.6	J	6	N	9.14 (0.360)
112*	5.6	K	6	N	9.14 (0.360)
113*	6.8	J	6	N	9.14 (0.360)
114*	6.8	K	6	N	9.14 (0.360)
115*	8.2	J	6	N	12.2 (0.480)
116*	8.2	K	6	N	12.2 (0.480)
117*	10	J	6	N	16.5 (0.650)
118*	10	K	6	N	16.5 (0.650)
119*	12	J	6	N	16.5 (0.650)
120*	12	K	6	N	16.5 (0.650)
<b>200V</b>					
121*	.022	J	5	N	3.05 (0.120)
122*	.022	K	5	N	3.05 (0.120)
123*	.027	J	5	N	6.10 (0.240)
124*	.027	K	5	N	6.10 (0.240)
125*	.033	J	5	N	6.10 (0.240)
126*	.033	K	5	N	6.10 (0.240)
127*	.039	J	5	N	6.10 (0.240)
128*	.039	K	5	N	6.10 (0.240)
129*	.047	J	5	N	9.14 (0.360)
130*	.047	K	5	N	9.14 (0.360)
131*	.056	J	5	N	9.14 (0.360)
132*	.056	K	5	N	9.14 (0.360)
133*	.068	J	5	N	12.2 (0.480)
134*	.068	K	5	N	12.2 (0.480)
135*	.082	J	5	N	12.2 (0.480)
136*	.082	K	5	N	12.2 (0.480)
137*	.10	J	5	N	16.5 (0.650)
138*	.10	K	5	N	16.5 (0.650)
139*	.12	J	4	N	9.14 (0.360)
140*	.12	K	4	N	9.14 (0.360)
141*	.15	J	4	N	9.14 (0.360)
142*	.15	K	4	N	9.14 (0.360)
143*	.18	J	4	N	12.2 (0.480)
144*	.18	K	4	N	12.2 (0.480)
145*	.22	J	4	N	12.2 (0.480)
146*	.22	K	4	N	12.2 (0.480)
147*	.27	J	4	N	16.5 (0.650)
148*	.27	K	4	N	16.5 (0.650)
149*	.33	J	3	N	6.10 (0.240)
150*	.33	K	3	N	6.10 (0.240)
151*	.39	J	3	N	6.10 (0.240)
152*	.39	K	3	N	6.10 (0.240)
153*	.47	J	3	N	9.14 (0.360)
154*	.47	K	3	N	9.14 (0.360)
155*	.56	J	3	N	9.14 (0.360)
156*	.56	K	3	N	9.14 (0.360)
157*	.68	J	3	N	12.2 (0.480)
158*	.68	K	3	N	12.2 (0.480)

DSCC Dwg. 88011-	Cap. Value (µF)	Cap. Tol.	Case Code	Lead Style	Max. A Dimension mm (inches)
<b>200V (continued)</b>					
159*	.82	J	3	N	16.5 (0.650)
160*	.82	K	3	N	16.5 (0.650)
161*	1.0	J	3	N	16.5 (0.650)
162*	1.0	K	3	N	16.5 (0.650)
163*	1.2	J	1	N	12.2 (0.480)
164*	1.2	K	1	N	12.2 (0.480)
165*	1.5	J	1	N	12.2 (0.480)
166*	1.5	K	1	N	12.2 (0.480)
167*	1.8	J	1	N	16.5 (0.650)
168*	1.8	K	1	N	16.5 (0.650)
169*	2.2	J	2	N	12.2 (0.480)
170*	2.2	K	2	N	12.2 (0.480)
171*	2.7	J	2	N	16.5 (0.650)
172*	2.7	K	2	N	16.5 (0.650)
173*	3.3	J	6	N	9.14 (0.360)
174*	3.3	K	6	N	9.14 (0.360)
175*	3.9	J	6	N	9.14 (0.360)
176*	3.9	K	6	N	9.14 (0.360)
177*	4.7	J	6	N	12.2 (0.480)
178*	4.7	K	6	N	12.2 (0.480)
179*	5.6	J	6	N	16.5 (0.650)
180*	5.6	K	6	N	16.5 (0.650)
<b>500V</b>					
181*	.010	J	5	N	3.05 (0.120)
182*	.010	K	5	N	3.05 (0.120)
183*	.012	J	5	N	6.10 (0.240)
184*	.012	K	5	N	6.10 (0.240)
185*	.015	J	5	N	6.10 (0.240)
186*	.015	K	5	N	6.10 (0.240)
187*	.018	J	5	N	6.10 (0.240)
188*	.018	K	5	N	6.10 (0.240)
189*	.022	J	5	N	9.14 (0.360)
190*	.022	K	5	N	9.14 (0.360)
191*	.027	J	5	N	9.14 (0.360)
192*	.027	K	5	N	9.14 (0.360)
193*	.033	J	5	N	12.2 (0.480)
194*	.033	K	5	N	12.2 (0.480)
195*	.039	J	5	N	12.2 (0.480)
196*	.039	K	5	N	12.2 (0.480)
197*	.047	J	5	N	16.5 (0.650)
198*	.047	K	5	N	16.5 (0.650)
199*	.056	J	4	N	9.14 (0.360)
200*	.056	K	4	N	9.14 (0.360)
201*	.068	J	4	N	9.14 (0.360)
202*	.068	K	4	N	9.14 (0.360)
203*	.082	J	4	N	12.2 (0.480)
204*	.082	K	4	N	12.2 (0.480)
205*	.10	J	4	N	12.2 (0.480)
206*	.10	K	4	N	12.2 (0.480)
207*	.12	J	4	N	16.5 (0.650)
208*	.12	K	4	N	16.5 (0.650)
209*	.15	J	3	N	6.10 (0.240)
210*	.15	K	3	N	6.10 (0.240)
211*	.18	J	3	N	6.10 (0.240)
212*	.18	K	3	N	6.10 (0.240)
213*	.22	J	3	N	9.14 (0.360)
214*	.22	K	3	N	9.14 (0.360)
215*	.27	J	3	N	9.14 (0.360)
216*	.27	K	3	N	9.14 (0.360)
217*	.33	J	3	N	12.2 (0.480)
218*	.33	K	3	N	12.2 (0.480)
219*	.39	J	3	N	16.5 (0.650)
220*	.39	K	3	N	16.5 (0.650)
221*	.47	J	1	N	9.14 (0.360)
222*	.47	K	1	N	9.14 (0.360)
223*	.56	J	1	N	12.2 (0.480)
224*	.56	K	1	N	12.2 (0.480)
225*	.68	J	1	N	12.2 (0.480)
226*	.68	K	1	N	12.2 (0.480)
227*	.82				

## X-ON Electronics

Largest Supplier of Electrical and Electronic Components

*Click to view similar products for [Multilayer Ceramic Capacitors MLCC - Leaded](#) category:*

*Click to view products by [AVX](#) manufacturer:*

Other Similar products are found below :

[010-007220-002REV A](#) [M39014/01-1210V](#) [M39014/01-1281V](#) [M39014/01-1335V](#) [M39014/01-1571V](#) [M39014/01-1578V](#) [M39014/01-1593](#)  
[M39014/02-1347](#) [M39014/02-1350](#) [M39014/22-0167](#) [M39014/22-0734](#) [87043-49](#) [Q52-DK](#) [C410C221K1G5TATR](#) [C420C102J1G5TATR](#)  
[C430C104M1U5TATR](#) [SL155C222MAB](#) [CCR06CG183GRV](#) [CFB1/2C101J](#) [CFB1/2C102J](#) [CN20C102K](#) [M39014/01-1317](#) [M39014/01-](#)  
[1572V](#) [M39014/01-1594V](#) [M39014/02-1236](#) [M39014/02-1321V](#) [M39014/02-1345V](#) [M39014/22-0351](#) [M39014/22-0695](#) [M39014/220767](#)  
[M39014/220788](#) [M39014/22-1005](#) [MA405E334MAA](#) [MD015A103KAB](#) [SL301E105MAB](#) [KTD101B684M32A0B00](#) [CCR07CG473KR](#)  
[CCR05CG820JP](#) [TKC-TMC1206-05-1501-J??](#) [TKC-TMC1206-05-1801-J](#) [TKC-TMC1206-05-20R0-F](#) [TKC-TMC1206-05-3901-J](#) [TKC-](#)  
[TMC1206-05-44R2-F](#) [TKC-TMC1206-05-4703-J??](#) [TKC-TMC2512-05-1211-F](#) [100B5R1CT500X](#) [100B3R9CT500X](#) [M39014/22-0869](#)  
[M39014/220556](#) [M39014/22-1045](#)