

I²S/TDM Input, 10.25V BOOST Digital Smart K Audio Amplifier with Integrated SKTune Algorithm

FEATURES

- **Integrates SKTune Algorithm**
 - Parametric audio path equalizer
 - Dynamic range control
 - Anti-clip voltage limiter
 - Speaker protection
- **Smart BOOST with total efficiency up to 80%**
- **High RF noise suppression, eliminate the TDD noise completely**
- **Low noise: 12uV**
- **THD+N: 0.02%**
- Supports 6Ω Speaker
- Extensive Pop-Click Suppression
- Volume control(from -96dB to 0dB)
- I²S/TDM interface:
 - I²S, Left-Justified and Right-Justified
 - Supports four slots TDM
 - Input Sample Rates from 8kHz to 96kHz
 - Data Width: 16, 20, 24, 32 Bits
- I²C-bus control interface(400kHz)
- Power Supplies:
 - VDD: 3.0V-5.5V
 - DVDD: 1.65V~1.95V
- Short-Circuit Protection, Over-Temperature Protection, Under-Voltage Protection and Over-Voltage Protection
- WLCSP 2.48X3.17-42B package

APPLICATIONS

- Mobile phones
- Tablets
- Portable Audio Devices

DESCRIPTION

The AW88194A is an I²S/TDM input, high efficiency digital Smart K audio amplifier with an integrated 10.25V smart boost converter and SKTune speaker protection algorithms. Due to its 12uV noise floor and ultra-low distortion, clean listening is guaranteed. It can deliver 5.3W output power into an 8Ω speaker at 1% THD+N.

The AW88194A integrates SKTune algorithm that includes parametric audio path equalizer, dynamic range control, anti-clip voltage limiter and speaker protection. The SKTune algorithm maximizes speaker performance while maintaining safe speaker conditions.

The AW88194A integrates a high-efficiency smart boost converter as the Class-D amplifier supply rail. The output voltage of boost converter can be adjusted smartly according to the input amplitude, which extremely improves the efficiency without clipping distortion.

The AW88194A features high RF suppression and eliminates TDD noise completely benefited from the digital audio input interface. General settings are communicated via an I²C-bus interface, and the device address is configurable.

The AW88194A offers Short Circuit Protection, Over-Temperature Protection, Under-Voltage Protection and Over-Voltage Protection to protect the device.

AW88194A is available in a WLCSP 2.48X3.17-42B package.

PIN CONFIGURATION AND TOP MARK

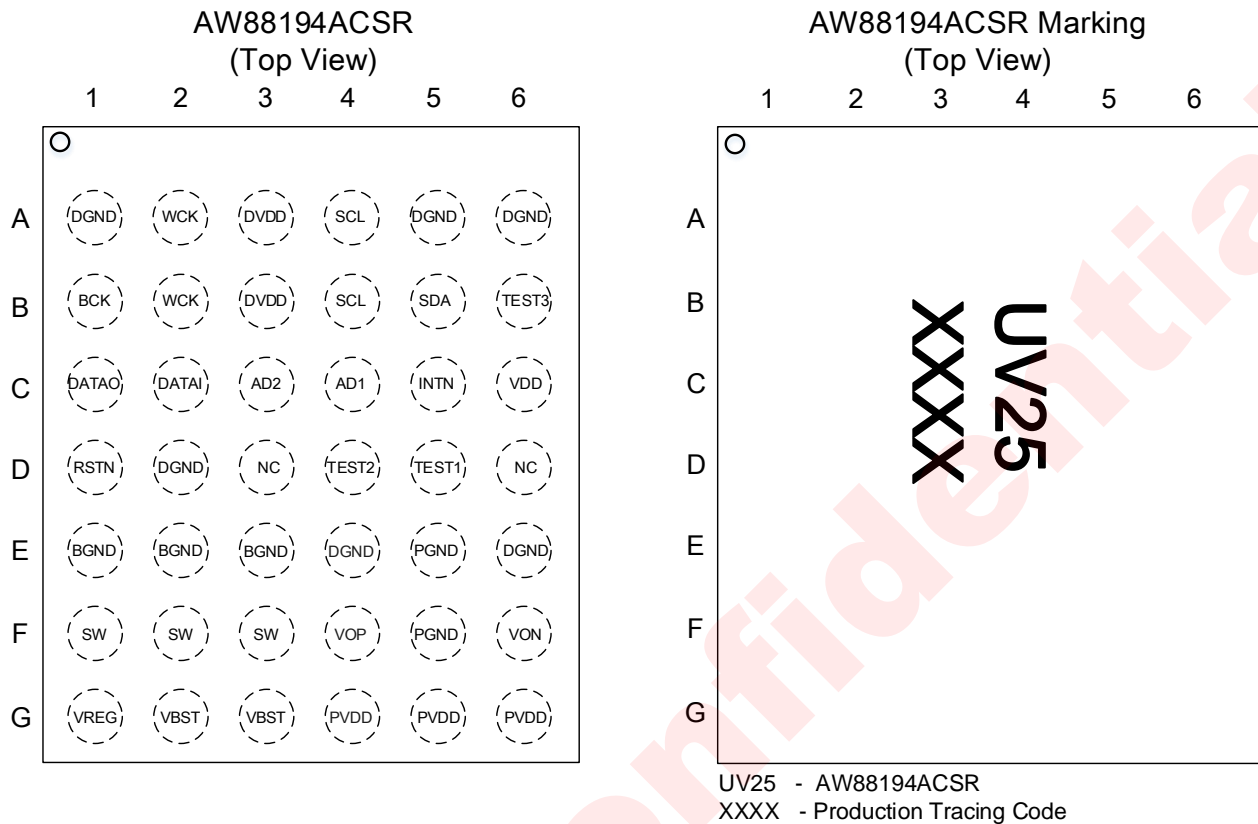

Figure 1 AW88194ACSR pin diagram top view and device marking

PIN DESCRIPTION

Pin No	Pin Name	Description
A1,A5,A6,D2,E4,E6	DGND	Digital GND
A2,B2	WCK	I ² S word select input / TDM frame sync signal
A3,B3	DVDD	Digital power supply
A4,B4	SCL	I ² C clock input
B1	BCK	I ² S/TDM bit clock input
B5	SDA	I ² C data I/O
B6	TEST3	Test signal input 3, connected to ground
C1	DATAO	I ² S/TDM data out
C2	DATAI	I ² S/TDM data input
C3	AD2	I ² C address select input
C4	AD1	I ² C address select input
C5	INTN	Interrupt output

Pin No	Pin Name	Description
C6	VDD	Battery power supply
D1	RSTN	Active low hardware reset
D3,D6	NC	Not connected
D4	TEST2	Test signal input 2, connected to ground
D5	TEST1	Test signal input 1, connected to ground
E1,E2,E3	BGND	Boost GND
E5,F5	PGND	Power GND
F1,F2,F3	SW	Boost switch pin
F4	VOP	Non-inverting Class-D output
F6	VON	Inverting Class-D output
G1	VREG	Voltage output of regulator
G2,G3	VBST	Boost output
G4,G5,G6	PVDD	Class-D power supply

FUNCTIONAL BLOCK DIAGRAM

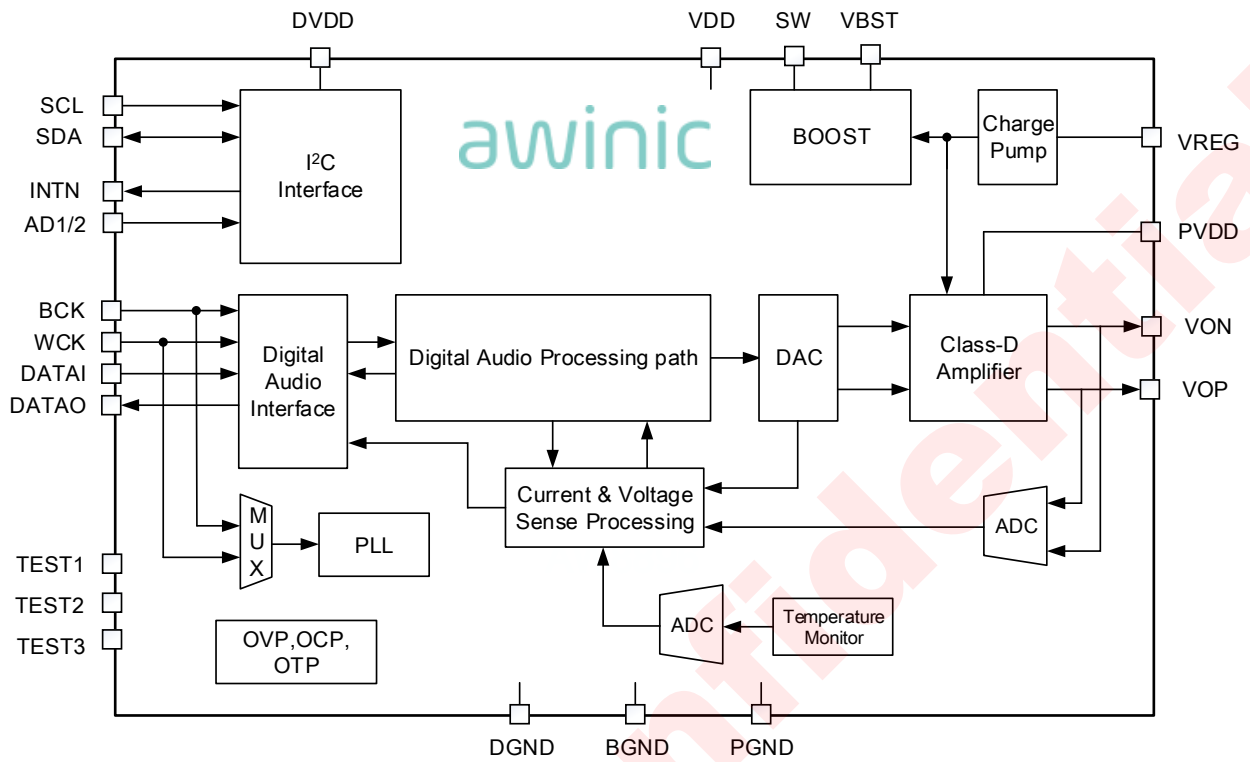

Figure 2 FUNCTIONAL BLOCK DIAGRAM

APPLICATION DIAGRAM

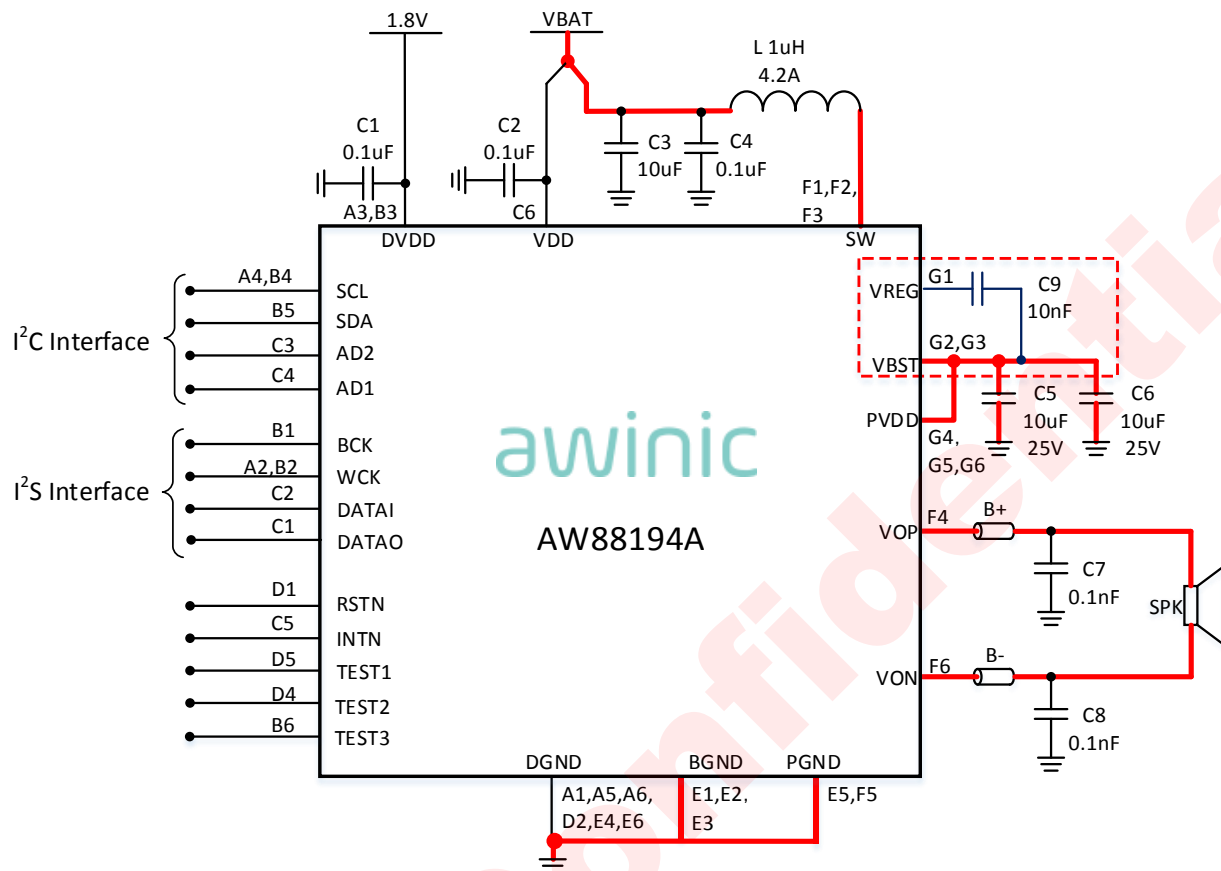

Figure 3 AW88194A Application Circuit

Note: Traces carry high current are marked in red in the above figure

All trademarks are the property of their respective owners.

ORDERING INFORMATION

Product Type	Temperature	Package	Device Marking	Moisture Sensitivity Level	Environmental Information	Delivery Form
AW88194ACSR	-40°C ~ 85°C	WLCSP 2.48X3.17-42B	UV25	MSL1	RoHS+HF	6000 units/ Tape and Reel

ABSOLUTE MAXIMUM RATING^(NOTE1)

Parameter	Range
Battery Supply Voltage V_{DD}	-0.3V to 6V
Digital Supply Voltage V_{DVDD}	-0.3V to 2V
Boost output voltage V_{PVDD}	-0.3 to 13V
Boost SW pin voltage	-0.3 to $V_{PVDD}+2V$
VREG pin voltage	-0.3 to $V_{PVDD}+5V$
Minimum load resistance R_L	5 Ω
Package Thermal Resistance θ_{JA}	60°C/W
Ambient Temperature Range	-40°C to 85°C
Maximum Junction Temperature T_{JMAX}	165°C
Storage Temperature Range T_{STG}	-65°C to 150°C
Lead Temperature (Soldering 10 Seconds)	260°C
ESD Rating ^(Note 2,3)	
HBM (Human Body Model)	±2000V
CDM(Charge Device Model)	±1000V
Latch-up	
Test Condition: JEDEC STANDARD NO.78E SEPTEMBER 2016	+IT: 450mA -IT: -450mA

Note 1: Stresses beyond those listed under "absolute maximum ratings" may cause permanent damage to the device. These are stress ratings only and functional operation of the device at these or any other conditions beyond those indicated under "recommended operating conditions" is not implied. Exposure to absolute-maximum-rated conditions for extended periods may affect device reliability.

Note 2: The human body model is a 100pF capacitor discharged through a 1.5k Ω resistor into each pin. Test method: MIL-STD-883J Method 3015.9

Note 3: Test method: JEDEC EIA/JESD22-C101F

ELECTRICAL CHARACTERISTICS

CHARACTERISTICS

Test condition : $T_A=25^{\circ}\text{C}$, $V_{DD}=3.6\text{V}$, $DV_{DD}=1.8\text{V}$, $PV_{DD}=10.25\text{V}$, $R_L=8\Omega+33\mu\text{H}$, $f=1\text{kHz}$ (unless otherwise noted)

Symbol	Description	Test Conditions	Min	Typ.	Max	Units
V_{DD}	Battery supply voltage	On pin VDD	3		5.5	V
V_{DVDD}	Digital supply voltage	On pin DVDD	1.65	1.8	1.95	V
I_{VDD}	Battery supply current	Operating mode		5.5		mA
		Power down mode		0.3	2	μA
I_{DVDD}	Digital supply current	Operating mode, SKTune Algorithm bypassed		8		mA
		Operating mode, SKTune Algorithm activated		20		mA
		Power down mode		7.5		μA
Boost						
V_{PVDD}	Boost output voltage			10.25 ^(Note1)		V
V_{OVP}	Over-voltage threshold			$V_{PVDD}+0.5$		V
	OVP hysteresis voltage			500		mV
I_{L_PEAK}	Inductor peak current limit			3.5 ^(Note 1)		A
F_{BST}	Operating Frequency	$f_s = 48\text{KHz}$		1.6		MHz
D_{MAX}	The maximum duty cycle			90		%
η_{BST}	Boost converter efficiency	$V_{DD}=4.2\text{V}$, $P_O = 2.5\text{W}$		88		%
Class-D						
R_{dson}	Drain-Source on-state resistance	High side MOS + Low side MOS		350		$\text{m}\Omega$
P_o	Speaker Output Power	THD+N=1%, $R_L=8\Omega+33\mu\text{H}$, $V_{DD}=4.2\text{V}$, $PV_{DD}=10.25\text{V}$		5.3		W
		THD+N=10%, $R_L=8\Omega+33\mu\text{H}$, $V_{DD}=4.2\text{V}$, $PV_{DD}=10.25\text{V}$		6.4		W
		THD+N=1%, $R_L=6\Omega+33\mu\text{H}$, $V_{DD}=4.2\text{V}$, $PV_{DD}=10.25\text{V}$		5.4		W
		THD+N=10%, $R_L=6\Omega+33\mu\text{H}$, $V_{DD}=4.2\text{V}$, $PV_{DD}=10.25\text{V}$		6.5		W
V_{OS}	Output offset voltage	I^2S signal input 0	-30	0	30	mV

Symbol	Description	Test Conditions	Min	Typ.	Max	Units
η	Total efficiency (Class-D)	$V_{DD}=4.2V$, $P_o=0.25W$, $R_L=8\Omega+33\mu H$		88		%
	Total efficiency (Boost+Class-D)	$V_{DD}=4.2V$, $P_o=1.5W$, $R_L=8\Omega+33\mu H$		82		%
THD+N	Total harmonic distortion plus noise	$V_{DD}=4.2V$, $P_o=1W$, $R_L=8\Omega+33\mu H$, $f=1kHz$, $PVDD=10.25V$		0.02		%
E_N	Speaker Mode Output noise	A-weighting		22		μV
	Receiver Mode Output noise	A-weighting		12		μV
SNR	Signal-to-noise ratio	$V_{DD}=4.2V$, $PVDD=10.25V$, $P_o=5.3W$, $R_L=8\Omega+33\mu H$, A-weighting		108		dB
PSRR	Power supply rejection ratio	Receiver Mode , $V_{DD}=4.2V$, $V_{p-p, sin}=200mV$	217Hz	-85		dB
			1kHz	-80		dB
Current Sense						
I_{SNS_FS}	Current sense full scale			4.4		A
SNR	Signal-to-noise ratio	$P_o=1W$, $R_L=8\Omega+33\mu H$, A-weighting		65		dB
THD+N	Total harmonic distortion plus noise	$P_o=1W$, $R_L=8\Omega+33\mu H$		0.1		%
ΔI_{SNS}	Current sense accuracy	$P_o=1W$, $R_L=8\Omega+33\mu H$		2		%
Digital Logical Interface						
V_{IL}	Logic input low level	BCK, WCK, DATAI Pin			$0.3 \times V_{DVDD}$	V
V_{IH}	Logic input high level		$0.7 \times V_{DVDD}$		V_{DVDD}	V
V_{IL}	Logic input low level	RSTN, SCL, SDA, AD1, AD2 Pin			$0.3 \times V_{DVDD}$	V
V_{IH}	Logic input high level		$0.7 \times V_{DVDD}$		3.6	V
V_{OL}	Logic output low level	$I_{OUT}=2mA$			0.45	V
V_{OH}	Logic output high level	$I_{OUT}=-2mA$	$V_{DVDD} - 0.45$		V_{DVDD}	V
Protection						
T_{SD}	Over temperature protection threshold			160		$^{\circ}C$
T_{SDR}	Over temperature protection recovery			130		$^{\circ}C$

Symbol	Description	Test Conditions	Min	Typ.	Max	Units
	threshold					
UVP	Under-voltage protection voltage			2.6		V
	Under-voltage protection hysteresis voltage			100		mV

Note 1: Registers are adjustable; Refer to the list of registers.

I²C INTERFACE TIMING

Parameter			MIN	TYP	MAX	UNIT
No.	Sym	Name				
1	f _{SCL}	SCL Clock frequency			400	kHz
2	t _{LOW}	SCL Low level Duration	1.3			μs
3	t _{HIGH}	SCL High level Duration	0.6			μs
4	t _{RISE}	SCL, SDA rise time			0.3	μs
5	t _{FALL}	SCL, SDA fall time			0.3	μs
6	t _{SU:STA}	Setup time SCL to START state	0.6			μs
7	t _{HD:STA}	(Repeat-start) Start condition hold time	0.6			μs
8	t _{SU:STO}	Stop condition setup time	0.6			μs
9	t _{BUF}	the Bus idle time START state to STOP state	1.3			μs
10	t _{SU:DAT}	SDA setup time	0.1			μs
11	t _{HD:DAT}	SDA hold time	10			ns

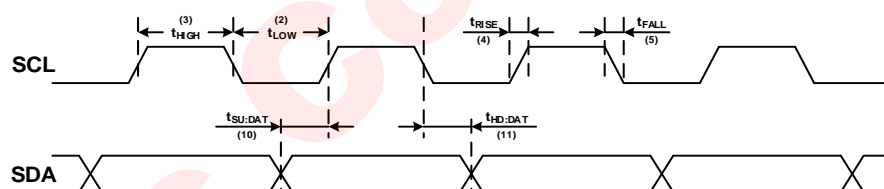

Figure 4 SCL and SDA timing relationships in the data transmission process

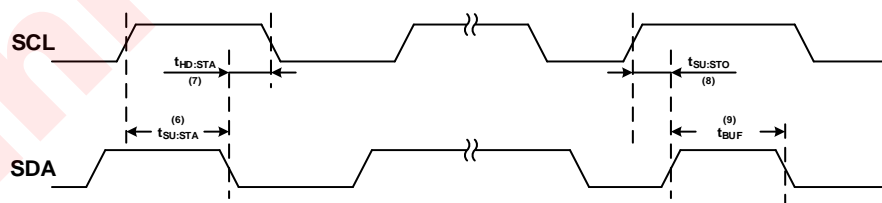

Figure 5 The timing relationship between START and STOP state

DIGITAL AUDIO INTERFACE TIMING

Parameter Name		Min	Typ.	Max	Units
f_s	sampling frequency, on pin WCK	8		96	kHz
f_{bck}	Bit clock frequency, on pin BCK	$32 \cdot f_s$		$64 \cdot f_s$	Hz
t_{su}	WCK, DATAI Setup time to BCK	10			ns
t_h	WCK, DATAI hold time to BCK	10			ns
t_d	DATAO output delay time to BCK			50	ns

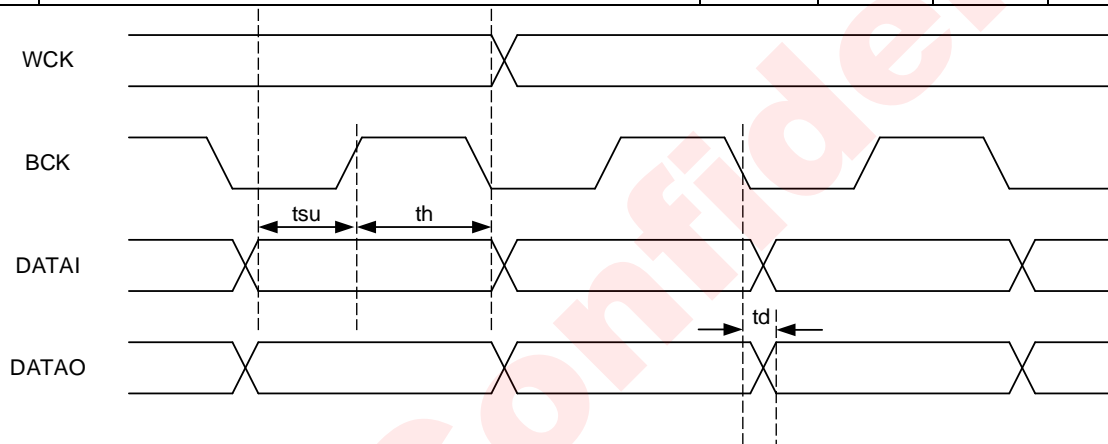
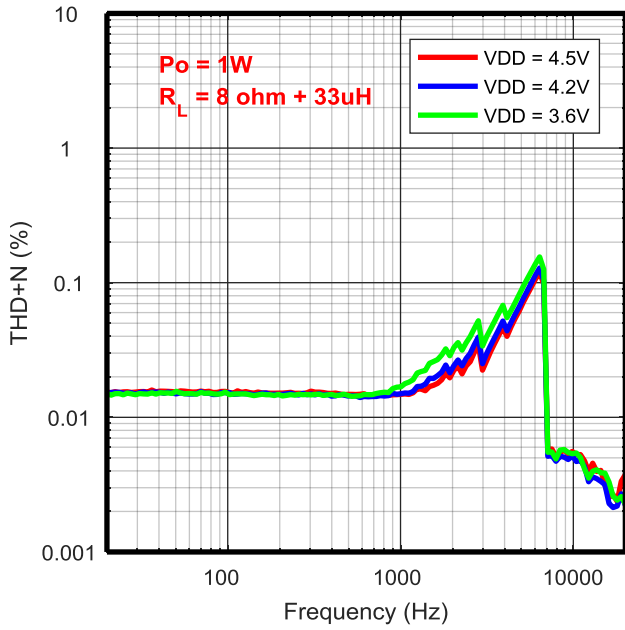

Figure 6 Digital Audio Interface Timing

TYPICAL CHARACTERISTIC CURVES

THD+N VS. FREQUENCY



THD+N VS. FREQUENCY

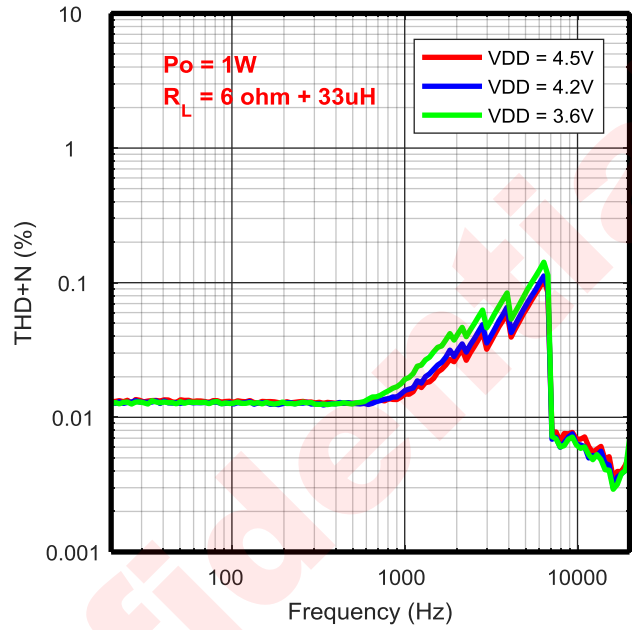

THD+N VS. OUTPUT POWER

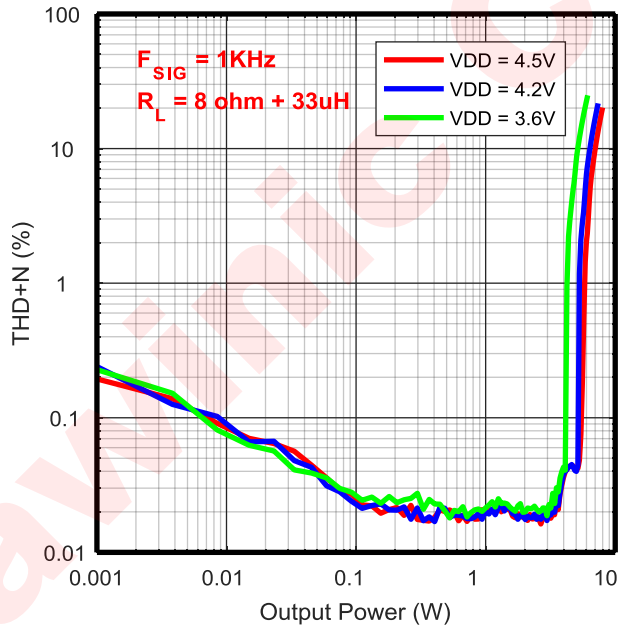

THD+N VS. OUTPUT POWER

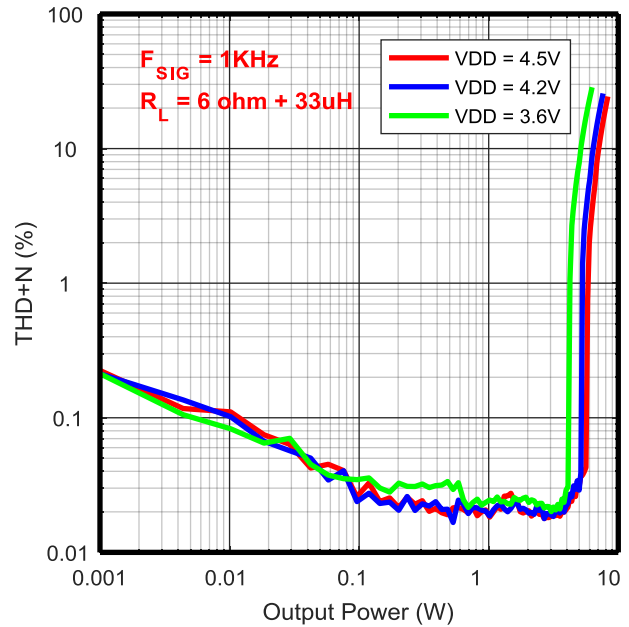

GAIN VS. FREQUENCY

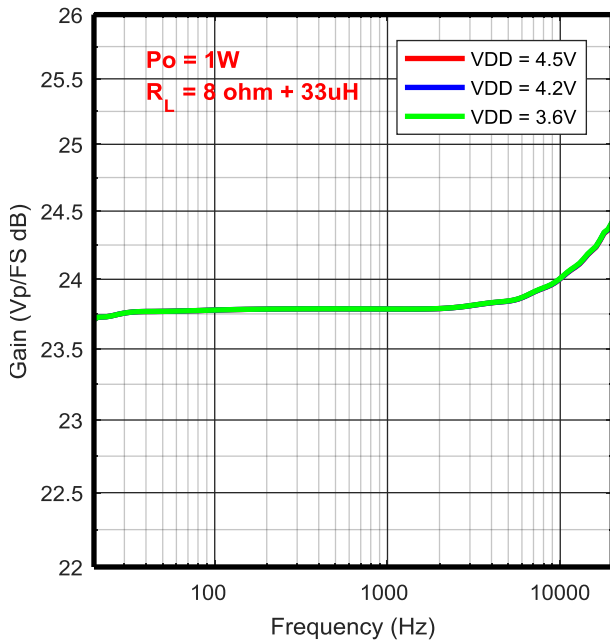

OUTPUT POWER VS. Din

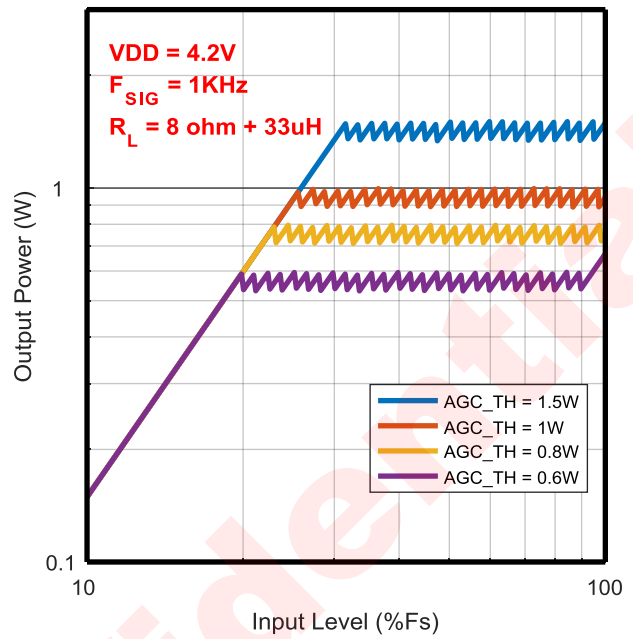

EFFICIENCY VS. OUTPUT POWER

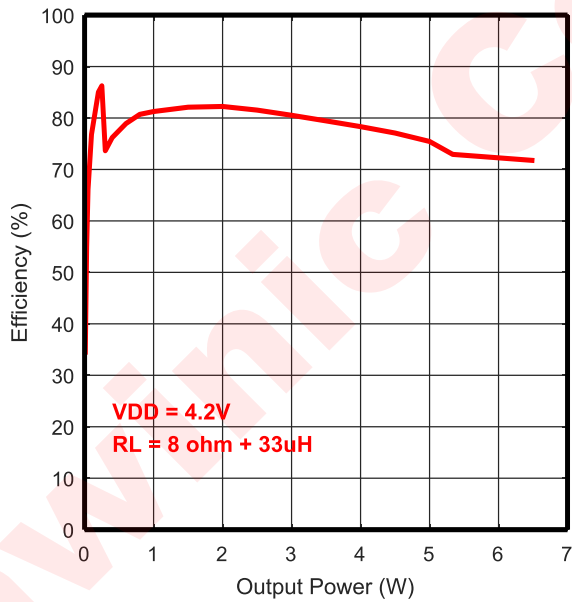

EFFICIENCY VS. OUTPUT POWER

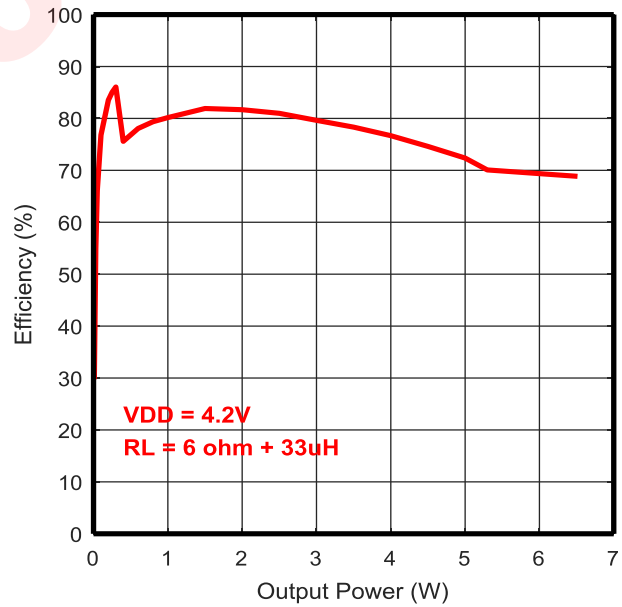

RECEIVER PSRR VS. FREQUENCY

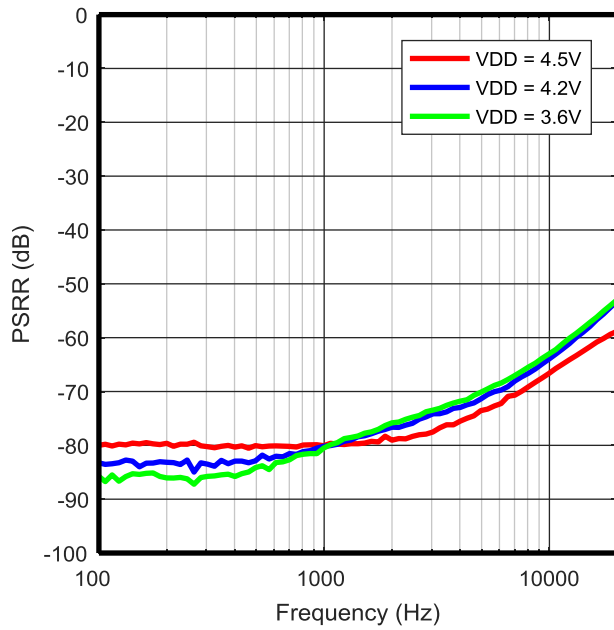

DETAIL FUNCTIONAL DESCRIPTION

POWER ON RESET

The device provides a power-on reset feature that is controlled by VDD and DVDD supply voltage. When the VDD supply voltage raises from 0V to 2.1V, or DVDD supply voltage raises from 0V to 1.1V. The reset signal will be generated to perform a power-on reset operation, which will reset all circuits and configuration registers.

OPERATION MODE

The device supports 4 operation modes.

Table 1 Operating Mode

Mode	Condition	Description
Power-Down	$V_{DD} < 2.1V$ $V_{DVDD} < 1.1V$	Power supply is not ready, chipset is power down.
Stand-By	$V_{DD} > 3V$ $V_{DVDD} > 1.65V$	Power supply is ready, most parts of the device are power down for low power consumption except I ² C interface
Configuring	PWDN = 0	Device is biased while boost and class-D output is floating. System configuration carried out in this mode
Operating	AMPPD = 0	Amplifier is fully operating

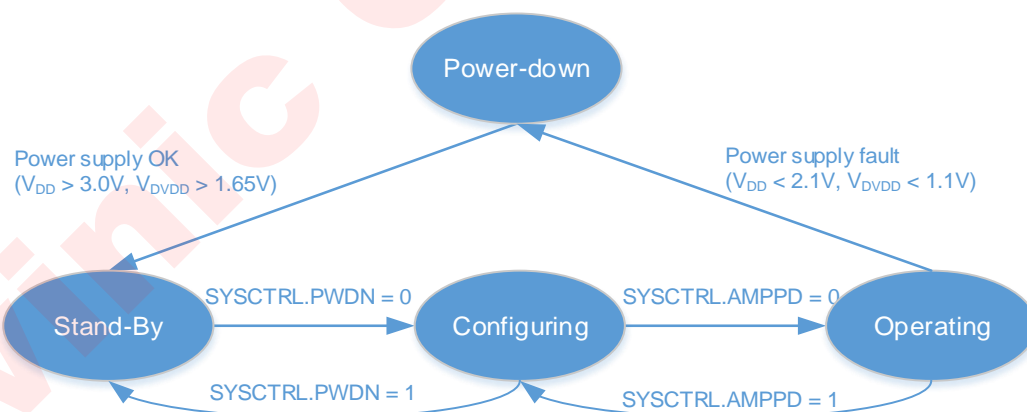

Figure 7 Device operating modes transition

POWER-DOWN MODE

The device switches to power-down mode when any of the following events occurred:

- $V_{DVDD} < 1.1V$
- $V_{DD} < 2.1V$

- RSTN pin goes LOW

In this mode, all circuits inside this device will be shut down except the power-on-reset circuit. I²C interface isn't accessible in this mode, and all of the internal configurable registers are cleared.

The device will jump out of the power-down mode automatically when all of the supply voltages are OK:

$$V_{DVDD} > 1.65 \text{ V and } V_{DD} > 3 \text{ V}$$

And RSTN goes HIGH.

STAND-BY MODE

The device switches stand-by mode when the power supply voltages are OK and RSTN pin is HIGH. In this mode I²C interface is accessible, other modules are still powered down. Customer can set device to mode when the device is no needed to work.

CONFIG MODE

The device switches to OFF mode when:

- SYSCTRL.PWDN = 0;
- SYSCTRL.AMPPD = 1;

In this mode the internal bias, OSC, PLL will start to work.

OPERATING MODE

The device is fully operational in this mode. Boost, amplifier loop and power stage circuits will start to work. Customer can set SYSCTRL.AMPPD = 0 to make device in this mode.

This device power up sequence is illustrated in the following figure:

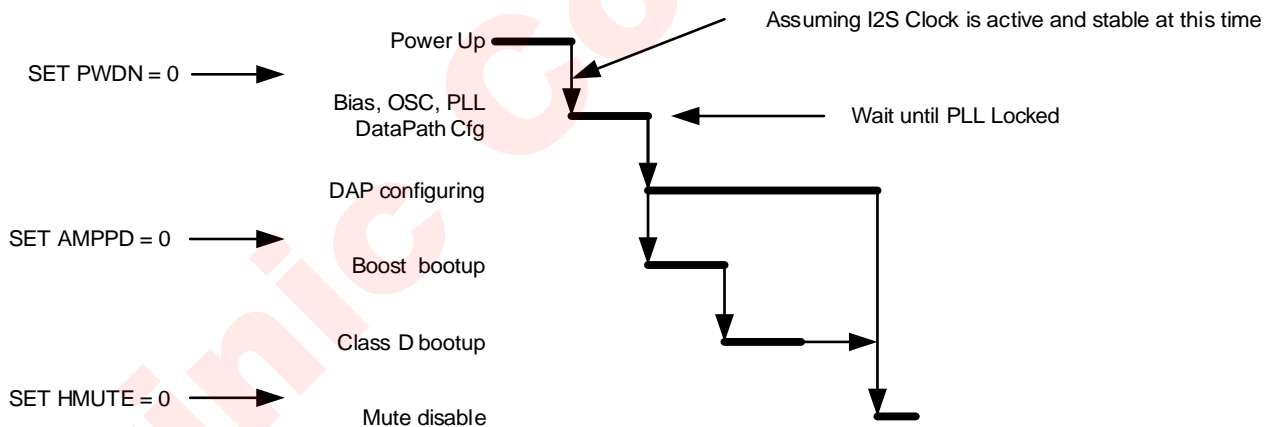

Figure 8 Power up sequence

Detail description for each step is listed in the following table.

Table 2 Detail Description of Power up sequence

Index	description	Mode
1	Wait for VDD、 DVDD supply power up	Power-Down
2	I ² S + Data Path Configuration	Stand-By
3.1	Enable system (SYSCTRL.PWDN = 0)	Configuring
3.2	Bias, OSC, PLL active	
3.3	Waiting for PLL locked	
4.1	Enable Boost and amplifier (SYSCTRL.AMPPD =0) Boost and Amplifier boot up	Operating
4.2	wait SYSST.SWS =1	
5	Release Hard-Mute Data Path active	

Power up sequence considering I2S, I2C timing shows as below:

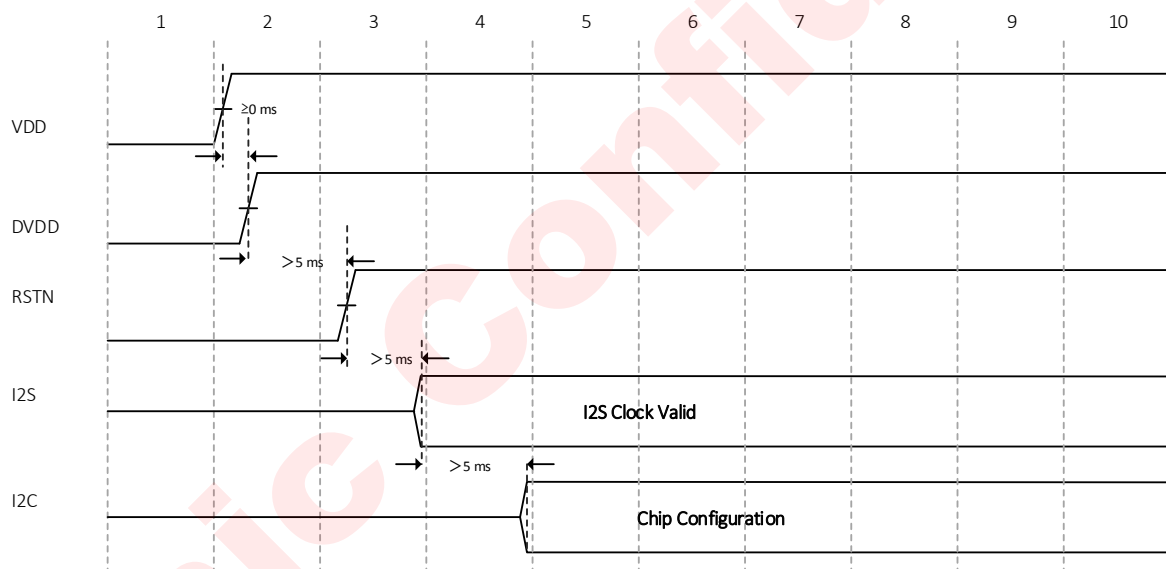

Power down sequence considering I2S, I2C timing shows as below:

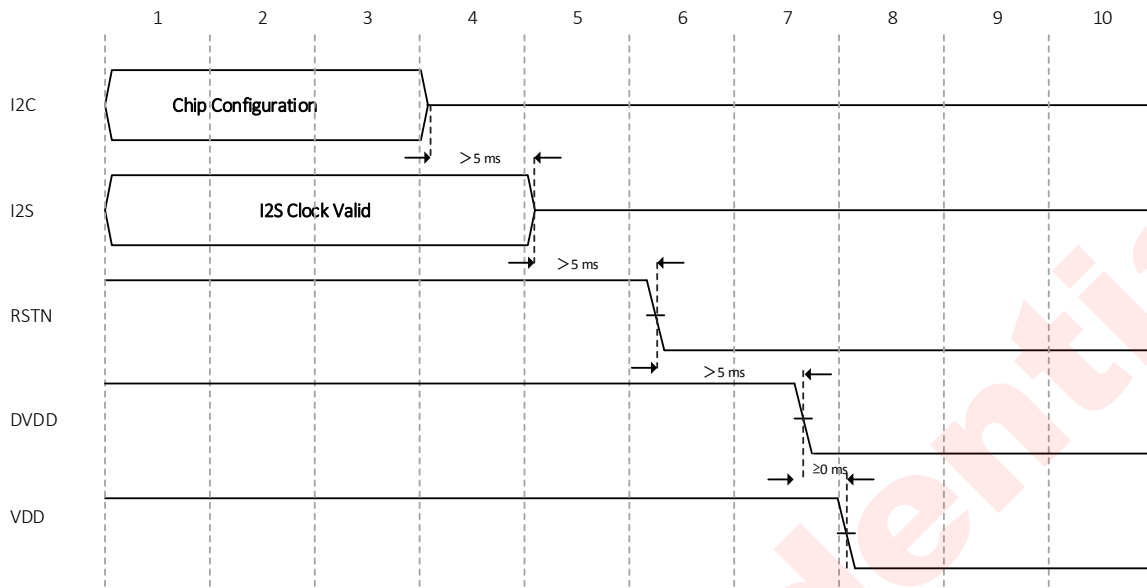

SOFTWARE RESET

Writing 0x55AA to register ID (0x00) via I²C interface will reset the device internal circuits and all configuration registers.

DIGITAL AUDIO INTERFACE

Audio data is transferred between the host processor and the device via the Digital Audio Interface. The digital audio interface is in full-duplex via 4 dedicated pins:

- BCK
- WCK
- DATAI
- DATAO

Two-slot I²S and 4-slot TDM are supported in this device. The digital audio Interface on this device is slave only and flexible with data width options, including 16, 20, 24, or 32 bits by configurable registers.

Three modes of I²S are supported, including standard I²S mode, left-justified mode and right-justified data mode, which can be configured via I2SCTRL.I2SMD. These modes are all MSB-first, with data width programmable via I2SCTRL.I2SFS.

The word clock WCK is used to define the beginning of a frame. The frequency of this clock corresponds to the sampling frequency. The device supports the following sample rates (fs): 8 kHz, 11.025 kHz, 12 kHz, 16 kHz, 22.05 kHz, 24 kHz, 32 kHz, 44.1 kHz, 48 kHz and 96 kHz. It is selected via configurable register I2SCTRL.I2SSR.

The bit clock BCK is used to sample the digital audio data across the digital audio interface. The number of bit-clock pulses in a frame is defined as slot length. Three kind of slot length are supported (16/24/32) via

configurable register I2SCTRL.I2SBCK. The frequency of BCK can be calculated according to the following equation:

$$BCK \text{ frequency} = \text{SampleRate} * \text{SlotLength} * \text{SlotNumber}$$

SampleRate: Sample rate for this digital audio interface;

SlotLength: The length of one audio slot in unit of BCK clock;

SlotNumber: How many slots supported in this audio interface. For example: 2-slot supported in I2S mode, 4-slot supported in TDM mode.

The word select and bit clock signals of the I²S input are the reference signals for the digital audio interface and Phased Locked Loop (PLL).

The input audio data can be attenuated -6dB in this module, by setting bit I2SCTRL.INPLEV. The audio source can be from left channel, right channel or the average of the left and right channel, which is controlled by I2SCTRL.CHSEL.

Table 3 Supported I2S interface parameters

Interface format(MSB first)	Data width	BCK frequency
Standard I ² S	16b	32fs/48fs /64fs
	20b/24b/32b	48fs /64fs
left-justified	16b	32fs/48fs /64fs
	20b/24b/32b	48fs /64fs
right-justified	16b	32fs /48fs /64fs
	20b/24b/32b	48fs /64fs

The output port DATAO, can be enabled or disabled via bit I2SCFG1.I2STXEN. The unused slots can be set to Hi-z or zero, which is controlled by I2SCFG1.DOHZ.

STANDARD I²S MODE

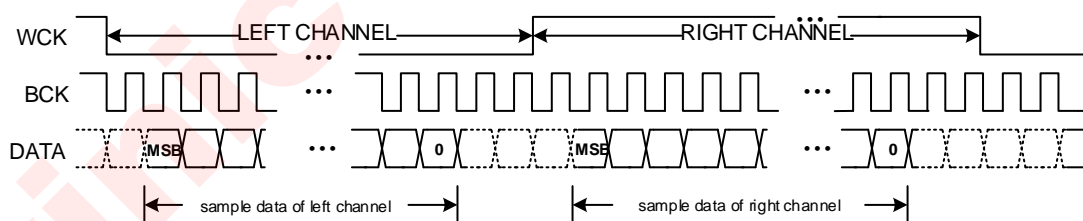
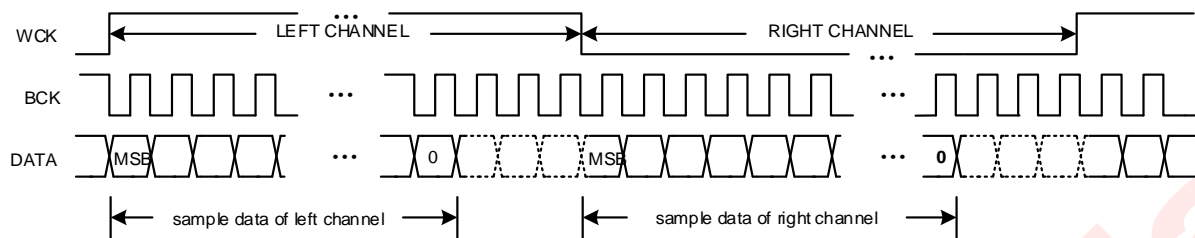
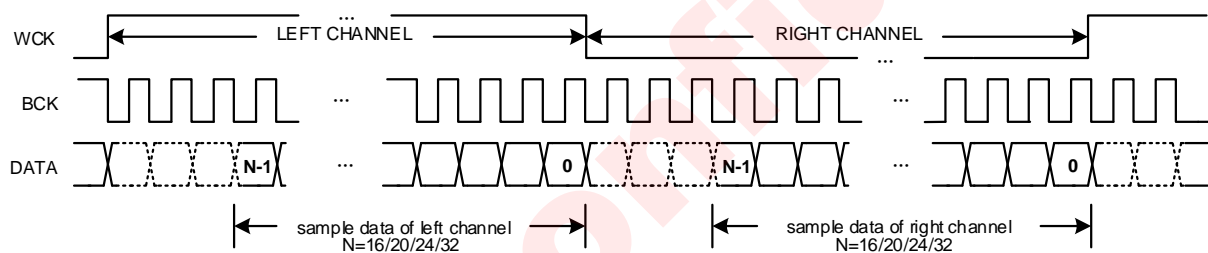

Figure 9 I²S Timing for Standard I²S Mode

- When WCK=0 indicating the left channel data, and WCK=1 indicating the right channel data.
- The MSB of the left channel is valid on the second rising edge of the bit clock after the falling edge of the word clock. Similarly the MSB of the right channel is valid on the second rising edge of the bit clock after the rising edge of the word clock.

LEFT-JUSTIFIED MODE**Figure 10 I²S Timing for Left-Justified Mode**

- When WCK=1 indicating the left channel data, and WCK=0 indicating the right channel data.
- The MSB of the left channel is valid on the first rising edge of the bit clock after the rising edge of the word clock. Similarly the MSB of the right channel is valid on the first rising edge of the bit clock after the falling edge of the word clock.

RIGHT-JUSTIFIED MODE**Figure 11 I²S Timing for Right-Justified Mode**

- When WCK is high indicating the left channel data, and WCK=0 indicating the right channel data.
- The LSB (bit 0) of the left channel is valid on the rising edge of the bit clock preceding the falling edge of the word clock. Similarly, the LSB (bit 0) of the right channel is valid on the rising edge of the bit clock preceding the rising edge of the word clock.

TDM MODE

All of the three kind of bit synchronization modes (standard, left-justified, right-justified) are also supported in TDM mode. The difference between TDM and I²S is the slot number supported. 4-slot is supported in TDM mode, while 2-slot is supported in I²S mode

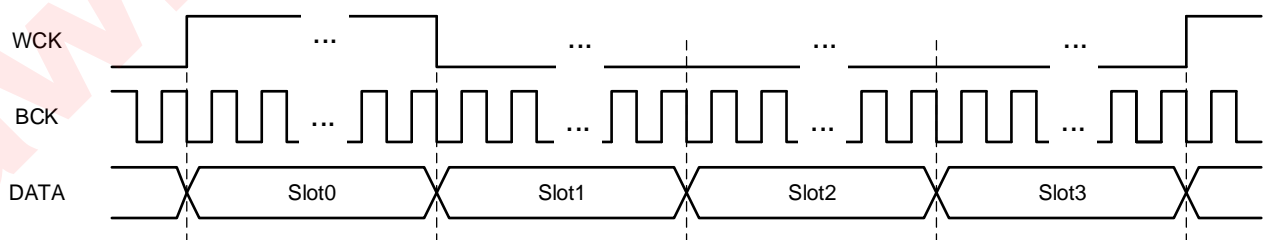
**Figure 12 TDM Timing**

Note: The high level pulse width of WCK signal can be one slot time or one period of BCK.

DIGITAL AUDIO PROCESSING

This device provides algorithm supporting for audio signal processing. The following functions are processed in this module.

- DCC
- Hardware AGC
- Volume control
- Mute

The signal processing flow in the DAP(Digital Audio Processor) is illustrated in the following figure.

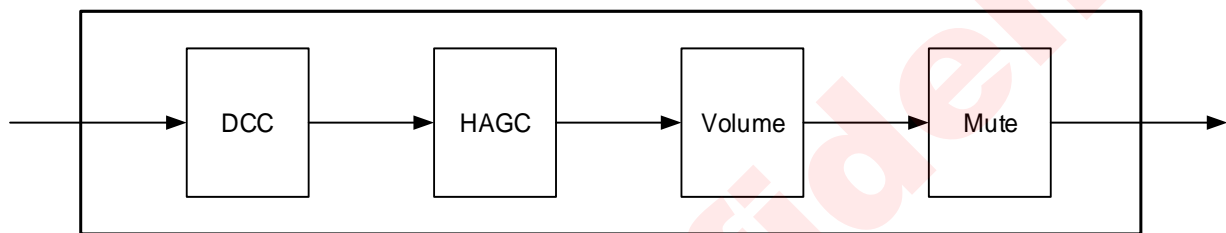

Figure 13 Block Diagram of DAP

DCC

This module performs DC canceling for the input audio stream. It blocks DC components into analog class D loop.

HAGC

In the actual audio application, system output power tends to be more than rated power of speaker, such as in the 10.25V power supply, as for 8ohms speaker, the maximum undistorted power is about 5.3W, but many speakers' rated power is about 1W, if there is no output power control, the overload signal can cause damage to the speaker. The audio power amplifier with HAGC can protect the speaker effectively, When the output power is not exceeds the setting threshold, the HAGC module will not attenuate the internal gain. Once the output power exceeds the setting threshold, the HAGC module will reduce the internal gain of amplifier and restricts the output power under the setting threshold.

VOLUME CONTROL

The volume control function attenuates the audio signal at the end of digital audio processing. The range of volume setting is from 0db to -96db with 0.5db/step

MUTE

This module perform mute control for the audio stream

SKTUNE ALGORITHM

This device provides algorithm supporting for audio signal processing. The following functions are processed in this module.

- Parametric Audio Path Equalizer(EQ)
- Dynamic Range Compressor (DRC)
- Anti-clip Voltage Limiter
- Speaker Protection

The signal processing flow in the DAP(Digital Audio Processor) is illustrated in the following figure:

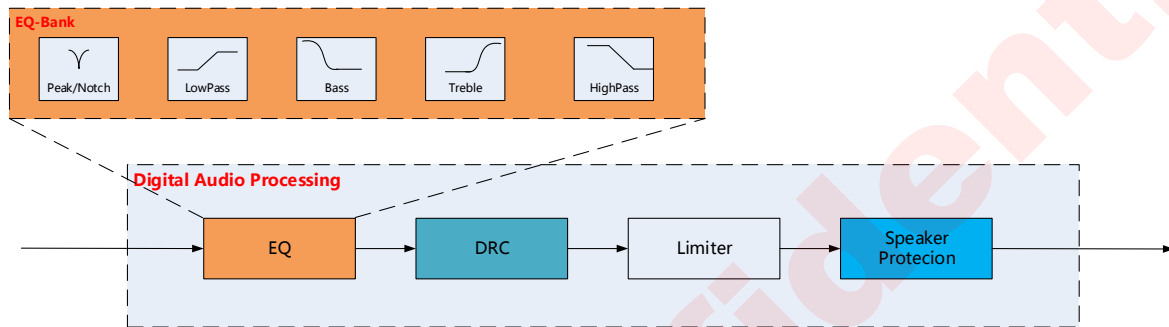

PARAMETRIC AUDIO PATH EQUALIZER

Eight Parametric Audio Path Equalizers(EQ) are available and each of the equalizer can be fully programmable. It's possible to be implemented as any type of filter (high-pass, low-pass, peak, notch, bass, treble etc.) with different design methodologies to achieve the required frequency response.

DYNAMIC RANGE CONTROL

A highly configurable and scalable DRC is available to improve audio performance. DRC is used to compress and limit the power of the input signal. The power of input signal will be attenuated and limited below the programmable threshold in given attack time, when the amplitude of input signal is above the threshold. While the attenuation will be released in given release time when the power of input signal is below the threshold.

ANTI-CLIP VOLTAGE LIMITER

The anti-clip voltage limiter is used to protect the output from exceeding the amplifier clip level. When signal is over the amplifier clip level it will be attenuated automatically and limited below the threshold without clipping.

SPEAKER PROTECTION

This device has integrated two kind of protection scheme for the speaker.

- **Membrane excursion control:** avoiding speaker membrane over-excursion
- **Coil temperature control:** avoiding speaker voice coil over-temperature

Membrane excursion control

The speaker membrane excursion is proportional to the amplitude of input signal. This device controls the

membrane excursion by control the signal amplitude. It predicted the speaker membrane excursion according to the input signal at first. Then it'll attenuate the amplitude of the input signal automatically once the predicted excursion over the threshold.

Coil temperature control

Speaker voice coil temperature is proportional to its input power in general. This device controls the power sending to speaker when the coil temperature is near the threshold. It calculates the coil temperature according to the impedance of speaker voice coil. It monitors the impedance continuously with an integrated ADC.

DC-DC CONVERTER

This device using smart boost converter generates the amplifier supply rail, working in 1.6MHz. The DC-DC converter can work in different mode via BSTCTRL2.BST_MODE:

- **Pass-through mode:** the voltage of VDD is transparently passed to output of converter PVDD
- **Force boost mode:** the output voltage is boosted to the programmed output voltage
- **Smart boost 1 mode:** the output voltage can be switch between VDD and programmed output voltage according to the input audio level.
- **Smart boost 2 mode:** the output voltage can be dynamically adjusted according to the amplifier output's signal swing requirements in order to maximize efficiency.

Pass-through mode

The internal boost circuit is not working; the voltage of VDD is passed to PVDD directly.

Force boost mode

The boost circuit is always working and converts the voltage of VDD to the programmed output voltage. The output voltage is configured via BSTCTRL3.BSTVOUT

Smart boost 1 mode

Smart boost 1 mode can dynamically turn off the boost according to the amplifier output's signal swing requirements in order to maximize efficiency.

Smart boost 2 mode

The boost circuits working dynamically according to the input audio level. When the level of input audio signal is below the setting threshold, the boost circuit will be deactivated. Till the level of input audio signal raised up and above the threshold, the boost circuit starts to work and boost the amplifier supply rail to the voltage fit the requirement of output signal before the audio stream arriving at amplifier power stage.

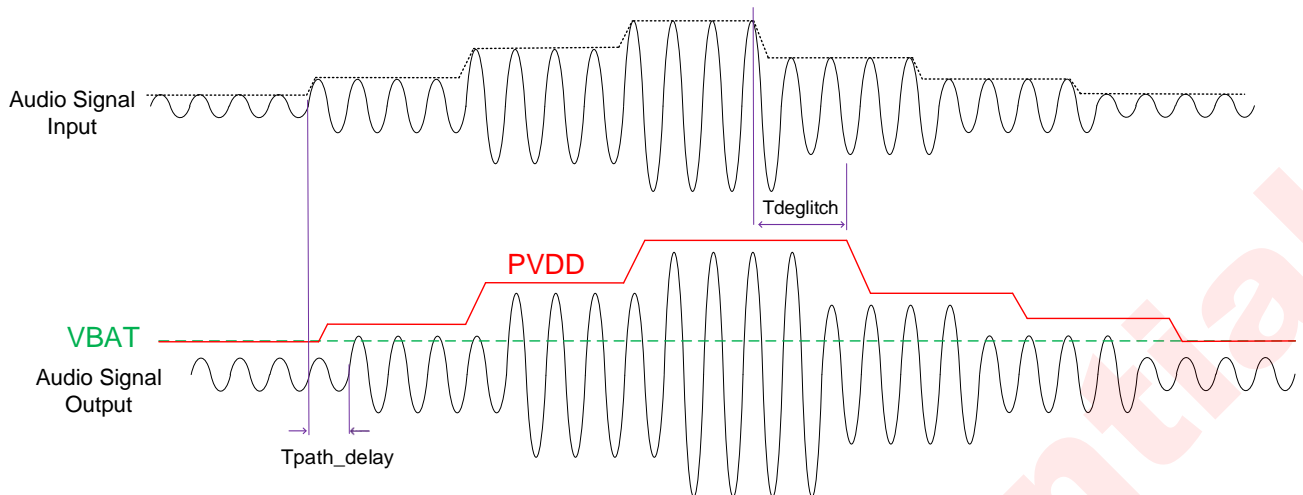

Figure 14 Boost Circuit Behavior in Smart Boost 2 Mode

PROTECTION MECHANISMS

Over Voltage Protection (OVP)

The boost circuit has integrated the over voltage protection control loop. When the output voltage PVDD is above the threshold, the boost circuits will stop working, until the voltage of PVDD going down and under the normal fixed working voltage.

Over Temperature Protection (OTP)

The device has automatic temperature protection mechanism which prevents heat damage to the chip. It is triggered when the junction temperature is larger than the preset temperature high threshold (default = 160°C). When it happens, the output stages will be disabled. When the junction temperature drops below the preset temperature low threshold (less than 130°C), the output stages will start to operate normally again.

Over Current (short) Protection (OCP)

The short circuit protection function is triggered when VOP/VON is short to PVDD/GND or VOP is short to VON, the output stages will be shut down to prevent damage to itself. When the fault condition is disappeared, the output stages of device will restart.

Under Voltage Detection (UVL)

The interrupt bit SYSINT.UVLI will be set to 1 when under voltage occurs, which will be cleared by a read operation of SYSINT register. Usually the SYSINT.UVLI bit can be used to check whether an unexpected under-voltage event has taken place.

BATTERY VOLTAGE MONITORING

The device monitors the voltage on the VDD pin, which is most commonly the battery for the system. The battery voltage level is available via bits VBAT_DET in the Battery Supply Voltage register VBAT. Status bits BAT_DET can be used to calculate the battery voltage. The battery voltage level V_{BAT} is:

$$V_{BAT} = \frac{VBAT_DET}{2^{10} - 1} \times 6.025V$$

For example, if VBAT_DET = 101010011, the battery voltage level V_{BAT} is equal to 3.6V.

DIE TEMPERATURE MONITORING

The device monitors the die temperature and the result is available via bits TEMP_DET in the Temperature register TEMP. The TEMP_DET is a two's complement value. For example, if TEMP_DET = 00011001, the die temperature is 25°C.

CURRENT SENSING

The device provides speaker current sense for real time monitoring of loudspeaker behavior. The current sensing transfer function I_{SNS} is:

$$I_{SNS} = \frac{D_{OUT}}{2^{11} - 1} \times 4.4A$$

D_{OUT} : the current sense I²S output stream

AMPLIFIER TRANSFER FUNCTION

The transfer function from the input to the amplifier PWM output (when no gain and attenuation is applied in digital signal domain) is:

$$V_o = AMP_NORM_V \times D_{in}$$

D_{in} : the level of input signal with a range from -1 to +1

AMP_NORM_V: the equivalent amplifier output voltage when D_{in} is 1. In receiver mode the AMP_NORM_V is 5V, in speaker mode it's 16V.

RECEIVER MODE

The device built-in Receiver mode is easy to realize the Speaker and Receiver combo applications, it saves the system cost and board space. If the receiver magnification is one times, the noise floor will be 12μV. Speaker and Receiver combo applications can be realized without changing any hardware.

When the device is set to receiver mode, the power supply of Class D driver stage is from VDD directly without boost.

I²C INTERFACE

This device supports the I²C serial bus and data transmission protocol in fast mode at 400 kHz. This device operates as a slave on the I²C bus. Connections to the bus are made via the open-drain I/O pins SCL and SDA. The pull-up resistor can be selected in the range of 1k~10kΩ and the typical value is 4.7kΩ. This device can support different high level (1.8V~3.3V) of this I²C interface.

DEVICE ADDRESS

The I²C device address (7-bit) can be set using the AD pin according to the following table: The AD1, AD2 pin configures the two LSB bits of the following 7-bit binary address A6-A0 of 01101xx. The permitted I²C addresses are 0x34(7-bit) through 0x37(7-bit).

Table 4 Address Selection

AD2	AD1	Address(7-bit)
0	0	0x34
0	1	0x35
1	0	0x36
1	1	0x37

DATA VALIDATION

When SCL is high level, SDA level must be constant. SDA can be changed only when SCL is low level.

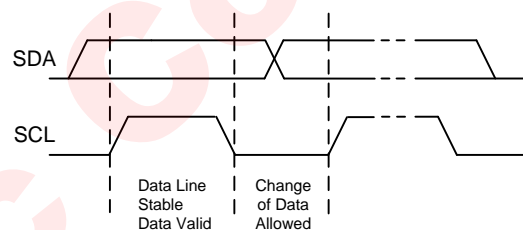

Figure 15 Data Validation Diagram

I²C START/STOP

I²C start: SDA changes from high level to low level when SCL is high level.

I²C stop: SDA changes from low level to high level when SCL is high level.

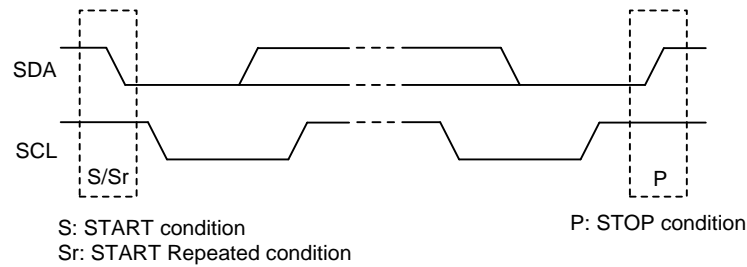

Figure 16 I²C Start/Stop Condition Timing

ACK (ACKNOWLEDGEMENT)

ACK means the successful transfer of I²C bus data. After master sends 8bits data, SDA must be released; SDA is pulled to GND by slave device when slave acknowledges.

When master reads, slave device sends 8bit data, releases the SDA and waits for ACK from master. If ACK is send and I²C stop is not send by master, slave device sends the next data. If ACK is not send by master, slave device stops to send data and waits for I²C stop.

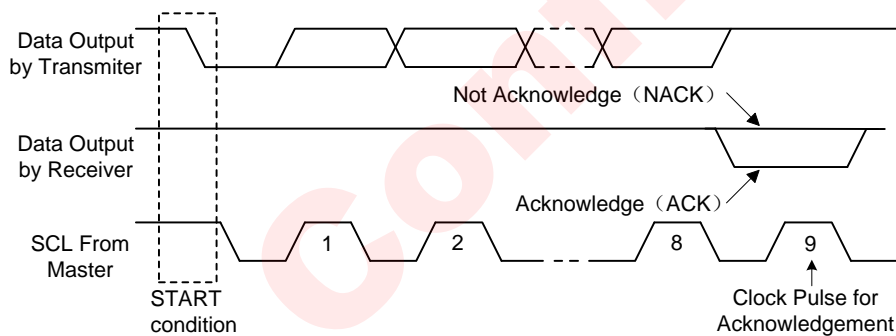

Figure 17 I²C ACK Timing

WRITE CYCLE

One data bit is transferred during each clock pulse. Data is sampled during the high state of the serial clock (SCL). Consequently, throughout the clock's high period, the data should remain stable. Any changes on the SDA line during the high state of the SCL and in the middle of a transaction, aborts the current transaction. New data should be sent during the low SCL state. This protocol allows a single data line to transfer both command/control information and data using the synchronous serial clock.

Each data transaction is composed of a Start Condition, a number of byte transfers (set by the software) and a Stop Condition to terminate the transaction. Every byte written to the SDA bus must be 8 bits long and is transferred with the most significant bit first. After each byte, an Acknowledge signal must follow.

In a write process, the following steps should be followed:

- Master device generates START condition. The "START" signal is generated by lowering the SDA signal while the SCL signal is high.
- Master device sends slave address (7-bit) and the data direction bit (r/w = 0).

- c) Slave device sends acknowledge signal if the slave address is correct.
- d) Master sends control register address (8-bit)
- e) Slave sends acknowledge signal
- f) Master sends high data byte of 16-bit data to be written to the addressed register
- g) Slave sends acknowledge signal
- h) Master sends low data byte of 16-bit data to be written to the addressed register
- i) Slave sends acknowledge signal
- j) If master will send further 16-bit data bytes the control register address will be incremented by one after acknowledge signal of step g (repeat step f to g)
- k) Master generates STOP condition to indicate write cycle end

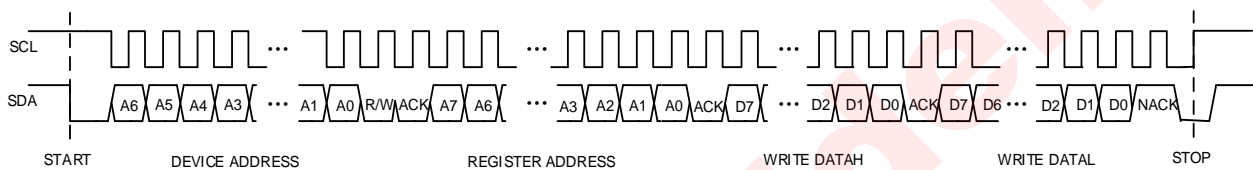

Figure 18 I²C Write Byte Cycle

READ CYCLE

In a read cycle, the following steps should be followed:

- a) Master device generates START condition
- b) Master device sends slave address (7-bit) and the data direction bit ($r/w = 0$).
- c) Slave device sends acknowledge signal if the slave address is correct.
- d) Master sends control register address (8-bit)
- e) Slave sends acknowledge signal
- f) Master generates STOP condition followed with START condition or REPEAT START condition
- g) Master device sends slave address (7-bit) and the data direction bit ($r/w = 1$).
- h) Slave device sends acknowledge signal if the slave address is correct.
- i) Slave sends read high data byte of 16-bit data from addressed register.
- j) Master sends acknowledge signal.
- k) Slave sends read low data byte of 16-bit data from addressed register.
- l) If the master device sends acknowledge signal, the slave device will increase the control register address by one, then send the next 16-bit data from the new addressed register.
- m) If the master device generates STOP condition, the read cycle is ended.

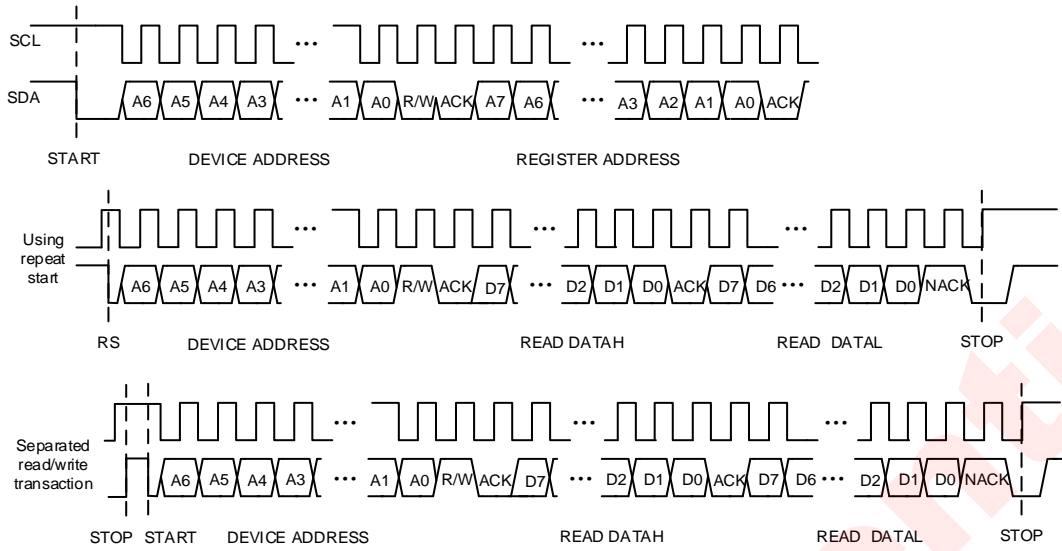

Figure 19 I²C Read Byte Cycle

REGISTER MAP

REGISTER DESCRIPTION

REGISTER LIST

ADDR	NAME	BIT																
		15	14	13	12	11	10	9	8	7	6	5	4	3	2	1	0	
0x00	ID	IDCODE																
0x01	SYSST		UVLS	ADPS	DSPS	BSTOCS	OVPS	BSTS	SWS	CLIPS	WDS	NOCLKS	CLKS	OCDS	CLIP_PRE	OTHS	PLLS	
0x02	SYSINT		UVLI	ADPI	DSPI	BSTOCI	OVPI	BSTI	SWI	CLIP	WDI	NOCLKI	CLKI	OCDI	CLIP_PREI	OTHI	PLLI	
0x03	SYSINTM		UVLM	ADPM	DSPM	BSTOCM	OVPM	BSTM	SWM	CLIPM	WDM	NOCLKM	CLKM	OCDM	CLIP_PREM	OTHM	PLLM	
0x04	SYSCTRL		SPK_GAIN			RCV_GAIN			INTMODE		RCV_MODE	I2SEN	WSINV	BCKINV	IPLL	DSPBY	AMPDP	PWDN
0x05	I2SCTRL			INPLEV		CHSEL		I2SMD		I2SFS		I2SBCK		I2SSR				
0x06	I2SCFG1	SYNC_TYPE	SLOT_NUM	I2S_TX_SLOTVLD		I2S_RX_SLOTVLD				CFSEL		DRVSTREN	DOHZ			I2SCHS	I2STXEN	
0x08	PWMCTRL															HDCCE	HMUTE	
0x09	HAGCCFG1		RVTH						AVTH									
0x0a	HAGCCFG2		ATTH															
0x0b	HAGCCFG3		RTTH															
0x0c	HAGCCFG4		HOLDTH															
0x0d	HAGCCFG5								HAGCE									
0x0f	HAGCCFG6		VOL															
0x10	HAGCCFG7															BSTVOUT_ST		
0x11	SYSCTRL2															BST_IPEAK		
0x21	I2SCFG2																I2SRXEN	
0x60	BSTCTRL1			BST_RTH								BST_ATH						
0x61	BSTCTRL2									BST_MODE				BST_TDEG				
0x62	BSTCTRL3													BST_VOUT				
0x6d	VBAT									VBAT_DET								
0x6e	TEMP									TEMP_DET								

DETAILED REGISTER DESCRIPTION**ID: Chip ID Register (Address 00h)**

Bit	Symbol	R/W	Description	Default
15:0	IDCODE	R	Chip ID (1806h) will be returned after read. All configuration registers will be reset to default value after 0x55aa is written to this address	0x1806

SYSST: System Status Register (Address 01h)

Bit	Symbol	R/W	Description	Default
15	Reserved	-	Reserved	
14	UVLS	R	VDD under voltage indicator 1: VDD < 2.6V, 0: VDD > 2.7V	
13	ADPS	R	Smart Boost status. 0:transparent; 1: boost	
12	DSPS	R	Set when DSP acknowledge request flag is set	
11	BSTOCS	R	Boost over current indicator	
10	OVPS	R	Boost OVP status indicator	
9	BSTS	R	Boost start up finished. 1: finished; 0: not finished	
8	SWS	R	Amplifier switching status. 1: switching; 0: not switching	
7	CLIPS	R	Amplifier clipping status. 1: clipping; 0: not clipping	
6	WDS	R	DSP watchdog is triggered, device will be restarted	
5	NOCLKS	R	The reference clock of PLL is not available	
4	CLKS	R	All internal clocks are stable	
3	OCDS	R	Over current status in amplifier	
2	CLIP_PRES	R	Ampifier clipping pre status.	
1	OTHS	R	Die Temperature is higher than 160°C	
0	PLLS	R	PLL locked status. 1: locked; 0: unlocked	

SYSINT: System Interrupt Register (Address 02h)

Bit	Symbol	R/W	Description	Default
15	Reserved	-	Reserved	
14	UVLI	RC	Interrupt indicator for Power On and UVLS	
13	ADPI	RC	Interrupt indicator for ADPS	
12	DSPI	RC	Interrupt indicator for DSPS.	
11	BSTOCI	RC	Interrupt indicator for BSTOCS.	
10	OVPI	RC	Interrupt indicator for OVPS.	
9	BSTI	RC	Interrupt indicator for BSTS.	
8	SWI	RC	Interrupt indicator for SWS.	
7	CLIP_I	RC	Interrupt indicator for CLIPS.	
6	WDI	RC	Interrupt indicator for WDS	
5	NOCLKI	RC	Interrupt indicator for NOCLKS.	
4	CLKI	RC	Interrupt indicator for CLKS.	
3	OCDI	RC	Interrupt indicator for OCDS	
2	CLIP_PREI	RC	Interrupt indicator for CLIP_PRES	
1	OTHI	RC	Interrupt indicator for OTHS.	
0	PLLI	RC	Interrupt indicator for PLLS.	

Note: It will be set to '1' once corresponding interrupt bit changed

SYSINTM: System Interrupt mask Register (Address 03h)

Bit	Symbol	R/W	Description	Default
15	Reserved	-	Reserved	0x1
14	UVLM	RW	Interrupt mask for UVLI.	0x1
13	ADPM	RW	Interrupt mask for ADPI.	0x1
12	DSPM	RW	Interrupt mask for DSPI.	0x1
11	BSTOCM	RW	Interrupt mask for BSTOCI.	0x1
10	OVPM	RW	Interrupt mask for OVPI.	0x1
9	BSTM	RW	Interrupt mask for BSTI.	0x1
8	SWM	RW	Interrupt mask for SWI.	0x1
7	CLIPM	RW	Interrupt mask for CLIPI.	0x1
6	WDM	RW	Interrupt mask for WDI.	0x1
5	NOCLKM	RW	Interrupt mask for NOCLKI.	0x1
4	CLKM	RW	Interrupt mask for CLKI.	0x1
3	OCDM	RW	Interrupt mask for OCDI.	0x1
2	CLIP_PREM	RW	Interrupt mask for CLIP_PREI.	0x1
1	OTHM	RW	Interrupt mask for OTHI.	0x1
0	PLLM	RW	Interrupt mask for PLLI.	0x1

Note: Corresponding interrupt will be masked when the mask bit is set to '1'

SYSCTRL: System Control Register (Address 04h)

Bit	Symbol	R/W	Description	Default
15	Reserved	-	Reserved	
14:12	SPK_GAIN	RW	Speaker mode AMP_NORM_V configuration 0: AMP_NORM_V=7 1: AMP_NORM_V=8 2: AMP_NORM_V=10 3: AMP_NORM_V=12 4: AMP_NORM_V=14 6: AMP_NORM_V=16 Others: Reserved	0x6
11:10	RCV_GAIN	RW	Receiver mode AMP_NORM_V configuration 0: AMP_NORM_V=4.5 1: AMP_NORM_V=5 2: AMP_NORM_V=5.5 3: AMP_NORM_V=5.5	0x0
9:8	INTMODE	RW	Interrupt mode [0]: INTN pin source selection. 0: SYSINT; 1: SYSST [1]: INTN output mode selection. 0: Open-drain, 1: push&pull	0x0
7	RCV_MODE	RW	Receiver mode 0: Speaker mode 1: Receiver mode	0x0
6	I2SEN	RW	Enable/Disable whole I2S interface module 0: disable 1: enable	0x0
5	WSINV	RW	I2S Left/Right channel switch 0: No switch 1: Left/Right switch	0x0

4	BCKINV	RW	I2S bit clock invert control 0: not invert 1: inverted	0x0
3	IPLL	RW	PLL reference clock selection 0: bit clock 1: word selection signal	0x0
2	Reserved	-	Reserved	0x1
1	AMPPD	RW	Amplifier power down control bit 0: Amplifier active 1: Amplifier power down	0x1
0	PWDN	RW	System power down control bit 0: Active 1: All circuits will enter power down mode	0x1

I2SCTRL: I2S interface Control Register (Address 05h)

Bit	Symbol	R/W	Description	Default
15:14	Reserved	-	Reserved	0x0
13	INPLEV	RW	Input level selection 0: All input signal will not be attenuated at first 1: All input signal will be attenuated by -6dB at first	0x0
12	Reserved	-	Reserved	0x0
11:10	CHSEL	RW	Left/right channel selection for I2S input 0: Reserved 1: Left 2: Right 3: Mono, (L+R)/2	0x1
9:8	I2SMD	RW	I2S interface mode 0: Philip standard I2S (default) 1: MSB justified 2: LSB justified 3: Reserved	0x0
7:6	I2SFS	RW	I2S data width 0: 16 bits 1: 20 bits 2: 24 bits 3: 32 bits	0x3
5:4	I2SBCK	RW	I2S BCK mode 0: 32*fs(16*2) 1: 48*fs(24*2) 2: 64*fs(32*2) 3: Reserved	0x2

3:0	I2SSR	RW	I2S interface sample rate configuration 0: 8 kHz 1: 11.025 kHz 2: 12 kHz 3: 16 kHz 4: 22.05 kHz 5: 24 kHz 6: 32 kHz 7: 44.1 kHz 8: 48 kHz 9: 96 kHz 10~15: Reserved	0x8
-----	-------	----	--	-----

I2SCFG1: I2S Configuration Register 1 (Address 06h)

Bit	Symbol	R/W	Description	Default
15	FSYNC_TYPE	RW	Audio Frame synchronization signal(WCK) pulse width configuration 0: one slot width 1: one BCK clock cycle	0x0
14	SLOT_NUM	RW	0: 2 slots (Compatible with I2S) 1: 4 slots (TDM mode, max 4 slots support)	0x0
13:12	TX_SLOT_VLD	RW	TX slot select 0: Data send on slot 0 1: Data send on slot 1 2: Data send on slot 2 3: Data send on slot 3	0x3
11:8	RX_SLOT_VLD	RW	RX slot select 3: RX slot 0,1 5: RX slot 0,2 6: RX slot 1,2 9: RX slot 0,3 10: RX slot 1,3 12: RX slot 2,3 Others: RX slot 0,1	0x3
7:6	Reserved	-	Reserved	0x0
5	DRVSTREN	RW	DATAO driving strength setting 0: 2 mA 1: 8 mA	0x0
4	DOHZ	RW	Unused channel data mode 0: 0 1: Hi-Z	0x0
3:1	Reserved	-	Reserved	0x0
0	I2STXEN	RW	Enable/Disable I2S transmitter module 0: Disable 1: Enable	0x0

PWMCTRL: PWM Control Register (Address 08h)

Bit	Symbol	R/W	Description	Default
15:2	Reserved	-	Reserved	0x2803
1	HDCCE	RW	Hardware DC Canceling control 0: Hardware DC cancel disable; 1: Hardware DC cancel enable.	0x1
0	HMUTE	RW	Hardware mute control 0: Hardware mute disable; 1: Hardware mute enable.	0x1

HAGCCFG1: Hardware AGC Configuration Register 1 (Address 09h)

Bit	Symbol	R/W	Description	Default
15:8	RVTH	RW	Release Amplitude threshold, in percent of signal full scale	0x39
7:0	AVTH	RW	Attack Amplitude threshold, in percent of signal full scale	0x40

HAGCCFG2: Hardware AGC Configuration Register 2 (Address 0ah)

Bit	Symbol	R/W	Description	Default
15:0	ATTH	RW	Attack time threshold in unit of 20.8 μ s 0: Reserved n: Gain decreased 0.5db per n*20.8 μ s	0x30

HAGCCFG3: Hardware AGC Configuration Register 3 (Address 0bh)

Bit	Symbol	R/W	Description	Default
15:0	RTTH	RW	Release time threshold in unit of 20.8 μ s 0: Reserved n: Gain decreased 0.5db per n*20.8 μ s	0x1E0

HAGCCFG4: Hardware AGC Configuration Register 4 (Address 0ch)

Bit	Symbol	R/W	Description	Default
15:8	Reserved	-	Reserved	0x7A
7:0	HOLDTH	RW	Attack time threshold in unit of about 166 μ s 0: Reserved n: Attack counter holding at least n*166 μ s	0x64

HAGCCFG5: Hardware AGC Configuration Register 5 (Address 0dh)

Bit	Symbol	R/W	Description	Default
15:9	Reserved	-	Reserved	
8	HAGCE	RW	Hardware AGC enable 0: Disable 1: Enable	0x0
7:0	Reserved	-	Reserved	0x1B

HAGCCFG6: Hardware AGC Configuration Register 6 (Address 0fh)

Bit	Symbol	R/W	Description	Default
15:8	VOL	RW	Volume control, from 0 to -96dB [3:0] : in unit of -0.5dB [7:4] : in unit of -6dB	0x0
7:0	Reserved	-	Reserved	

HAGCCFG7: Hardware AGC Configuration Register 7 (Address 10h)

Bit	Symbol	R/W	Description	Default
15:4	Reserved	-	Reserved	
3:0	BSTVOUT_ST	R	Actual setting of boost output voltage 0: 6.5 V 1: 6.75 V 2: 7 V 3: 7.25 V 4: 7.5 V 5: 7.75 V 6: 8 V 7: 8.25 V 8: 8.5 V 9: 8.75 V 10: 9 V 11: 9.25 V 12: 9.5 V 13: 9.75V 14: 10V 15: 10.25V	

SYCTRL2: System Control Register 2 (Address 11h)

Bit	Symbol	R/W	Description	Default
15:3	Reserved	-	Reserved	
2:0	BST_IPEAK	RW	Boost peak current limiter threshold 0: 2.5A 1: 2.75A 2: 3.0A 3: 3.25A 4: 3.5A 5: 3.75A 6: 4.0A 7: Reserved	0x4

I2SCFG2: I2S Configuration Register 2 (Address 21h)

Bit	Symbol	R/W	Description	Default
15:1	Reserved	-	Reserved	0x108
0	I2SRXEN	RW	Enable/Disable I2S receiver module 0: Disable 1: Enable	0x1

BSTCTRL1: Boost Control Register 1 (Address 60h)

Bit	Symbol	R/W	Description	Default
15:14	Reserved	-	Reserved	0x0
13:8	BST_RTH	RW	Smart boost release threshold setting. When signal is below the threshold, the voltage of VBST will not be raised up higher than VDD in smart boost mode Release threshold = BST_RTH * 1/64 FullScale	0x4
7:6	Reserved	-	Reserved	0x0
5:0	BST_ATH	RW	Smart boost attack threshold setting. When signal is above over the threshold, the voltage of VBST will be raised up higher than VDD in smart boost mode Attack threshold = BST_ATH * 1/64 FullScale	0x2

BSTCTRL2: Boost Control Register 2 (Address 61h)

Bit	Symbol	R/W	Description	Default
15:7	Reserved	-	Reserved	0x0
6:4	BST_MODE	RW	BOOST mode selection 0: Transparent Mode 1: Force Boost Mode 5: Smart Boost 1 Mode 6: Smart Boost 2 Mode Others: reserved	0x2
3	Reserved	-	Reserved	
2:0	BST_TDEG	RW	Smart Boost small signal level detection deglitch time 0: 1.33 ms 1: 2.66 ms 2: 5.32 ms 3: 21.30 ms 4: 85.20 ms 5: 340.79 ms 6: 1.363 s 7: 2.73 s	0x6

BSTCTRL3: Boost Control Register 3 (Address 62h)

Bit	Symbol	R/W	Description	Default
15:4	Reserved	-	Reserved	0x0
3:0	BSTVOUT	RW	Boost max output voltage configuration 0: 6.5 V 1: 6.75 V 2: 7 V 3: 7.25 V 4: 7.5 V 5: 7.75 V 6: 8 V 7: 8.25 V 8: 8.5 V 9: 8.75 V 10: 9 V 11: 9.25 V 12: 9.5 V 13: 9.75V 14: 10V 15: 10.25V	0x8

VBAT: Battery Supply Voltage Register (Address 6dh)

Bit	Symbol	R/W	Description	Default
15:10	Reserved	-	Reserved	0x0
9:0	VBAT_DET	R	Detected voltage of battery, and the full range is 6.025V $V_{BAT} = VBAT_DET / 1023 \times 6.025$	0x263

TEMP: Temperature Register (Address 6eh)

Bit	Symbol	R/W	Description	Default
15:10	Reserved	-	Reserved	0x0
9:0	TEMP_DET	R	Detected die temperature (Two's Complement), typical values are as follows 0x3D8 : -40degree ... 0x00 : 0 degree 0x01 : 1 degree ... 0x19 : 25 degree ... 0x37 : 55 degree ...	0x19

APPLICATION INFORMATION

EXTERNAL COMPONENTS

BOOST INDUCTOR SELECTION

Selecting inductor needs to consider Inductance, size, magnetic shielding, saturation current and temperature current.

a) Inductance

Inductance value is limited by the boost converter's internal loop compensation. In order to ensure phase margin sufficient under all operating conditions, recommended 1μH inductor.

b) Size

For a certain value of inductor, the smaller the size, the greater the parasitic series resistance of the inductor DCR, the higher the loss, corresponds to the lower efficiency.

c) Magnetic shielding

Magnetic shielding can effectively prevent the inductance of the electromagnetic radiation interference. It is much better to choose inductance with magnetic shielding in the application of EMI sensitive environment.

d) Saturation current and temperature rise of current

Inductor saturation current and temperature rise current value are important basis for selecting the inductor. As the inductor current increases, on the one hand, since the magnetic core begins to saturate, inductance value will decline; on the other hand, the inductor's parasitic resistance inductance and magnetic core loss can lead to temperature rise. In general, the current value is defined as the saturation current I_{SAT} when the inductance value drops to 70%; the current value is defined as temperature rise current I_{RMS} when inductance temperature rise 40°C.

For particular applications, need to calculate the maximum I_{L_PEAK} and I_{L_RMS} , which is a basis of selecting the inductor. When $V_{DD} = 4.2V$, $P_{VDD} = 9.5V$, $R_L = 8\Omega$, amplifier $R_{DS(ON)} = 350m\Omega$, when THD = 1% (the maximum power without distortion), the output power is calculated as follows:

$$P_{out} = \frac{\left(V_{out} \times \frac{R_L}{R_L + R_{DS(ON)}}\right)^2}{2 \times R_L} = \frac{\left(9.5 \times \frac{8}{8 + 0.35}\right)^2}{2 \times 8} = 5.16W$$

In such a large output power, the overall efficiency of the power amplifier is typically 70%, in order to calculate the maximum average current $I_{MAX_AVG_VDD}$ and maximum peak current $I_{MAX_PEAK_VDD}$ drawn from VDD:

$$I_{MAX_AVG_VDD} = \frac{P_{out}}{V_{in} \times \eta} = \frac{5.16}{4.2 \times 0.7} = 1.75A$$

$$I_{MAX_PEAK_VDD} = 2 \times I_{MAX_AVG_VDD} = 2 \times 1.75A = 3.5A$$

If inductor DCR is 50mΩ, the inductor power loss at this time is:

$$P_{DCR_LOSS} = 1.5 \times I_{MAX_AVG_VDD}^2 \times DCR = 1.5 \times 1.75^2 \times 0.05W = 230mW$$

Wherein the coefficient 1.5 is the square of the ratio of the sine wave current RMS value and average value (there is no consideration of the impact of the inductor ripple, the actual DCR loss will be even greater). If the loss which is resulting from DCR is less than 1% at maximum efficiency ($P_{OUT} = 2.5W$, $\eta = 80\%$), then:

$$I_{AVG_VDD} = \frac{P_{out}}{V_{in} \times \eta} = \frac{2.5}{4.2 \times 0.8} = 0.75A$$

$$DCR = \frac{P_{DCR_LOSS}}{1.5 \times I_{MAX_AVG_VDD}^2} \leq 1\% \times \frac{P_{out}}{1.5 \times I_{AVG_VDD}^2 \times \eta} = \frac{0.01 \times 2.5}{1.5 \times 0.75^2 \times 0.8} \Omega = 37m\Omega$$

According to the working principle of the Boost, we can calculate the size of the inductor current ripple ΔI_L :

$$\Delta I_L = \frac{V_{in} \times (V_{out} - V_{in})}{V_{out} \times f \times L} = \frac{4.2 \times (9.5 - 4.2)}{9.5 \times 1.6 \times 10^6 \times 1 \times 10^{-6}} = 1.46A$$

Thus, the maximum peak inductor current I_{L_PEAK} and maximum effective inductor current I_{L_RMS} is:

$$I_{L_PEAK} = I_{MAX_PEAK_VDD} + \frac{\Delta I_L}{2} = 3.5 + \frac{1.46}{2} A = 4.23A$$

$$I_{L_RMS} = \sqrt{I_{MAX_PEAK_VDD}^2 + \frac{\Delta I_L^2}{12}} = \sqrt{3.5^2 + \frac{1.46^2}{12}} A = 3.52A$$

From the above calculation results:

- 1) For typical DCR about 50m Ω inductance, the efficiency loss caused by around 1.5%;
- 2) In practice, the maximum output power of the amplifier is likely to reach 5.6W in an instant, so the selected inductor saturation current I_{SAT} requires more than the maximum inductor peak current I_{L_PEAK} ;
- 3) In some cases, if the I_{L_PEAK} calculated according to the above method is greater than the set of input inductor current limit value I_{PEAK} , shows the power amplifier is restricted by inductance input current limit, the actual maximum output power is less than the calculated value, the measured value shall prevail, and I_{SAT} need greater than the set current limiting value I_{PEAK} , and cannot be less than 3.5A;
- 4) Take PVDD = 9.5V for example, under different conditions, the typical method of selecting I_{SAT} in the following table:

V _{DD} (V)	PVDD (V)	R _L (Ω)	I _{PEAK} (A)	Efficiency(η) (%)	P _O (W)	I _{L_PEAK} (A)	Inductor saturation current ISAT typical value (A)
4.2	9.5	8	4.25	74	5.2	4.23	5.2
4.2	9.5	6	4.25	69	5.4	4.5	5.2

- 5) As the result of the action of AGC, amplifier will not work long hours at maximum power without distortion, the actual average inductor current is far less than the maximum inductor current effective I_{L_RMS} , so when selecting the inductor, the inductor temperature rise current is not usually a limiting factor;
- 6) Inductor Selection example: the inductor package size is 252010, inductance value is 1 μ H, DCR Typical value is 32m Ω , the typical saturation current I_{SAT} is 5.2A, the typical temperature rise current I_{RMS} is 5.2A, suitable for VDD=3.6V, PVDD=9.5V, speaker impedance R_L=8 Ω , inductor input current limit I_{PEAK} = 4.23A. If you choose I_{SAT} or I_{RMS} of the inductance is too small, it is possible to cause the chip don't work properly, or the temperature of the inductance is too high.

Inductance value	size	DCR (Ω)	I _{SAT} (A)	I _{RMS} (A)
1 μ H	2.5x2.0x1.0mm	0.032	5.2	5.2

BOOST CAPACITOR SELECTION

Boost output capacitor is usually within the range $0.1\mu\text{F}\sim 47\mu\text{F}$. It needs to use Class II type (EIA) multilayer ceramic capacitors (MLCC). Its internal dielectric is ferroelectric material (typically BaTiO_3), a high the dielectric constant in order to achieve smaller size, but at the same Class II type (EIA) multilayer ceramic capacitors has poor temperature stability and voltage stability as compared to the Class I type (EIA) capacitance. Capacitor is selected based on the requirements of temperature stability and voltage stability, considering the capacitance material, capacitor voltage, and capacitor size and capacitance values.

A) temperature stability

Class II capacitance have different temperature stability in different materials, usually choose X5R type in order to ensure enough temperature stability, and X7R type capacitance has better properties, the price is relatively more expensive; X5R capacitance change within $\pm 15\%$ in temperature range of 55°C to 85°C , X7R capacitance change within $\pm 15\%$ in temperature range of $-55^\circ\text{C}\sim 125^\circ\text{C}$. The Boost output capacitance of DEVICE recommends X5R ceramic capacitors.

B) Voltage Stability

Class II type capacitor has poor voltage stability Capacitance values falling fast along with the DC bias voltage applied across the capacitor increasing. The rate of decline is related to capacitance material, capacitors rated voltage, capacitance volume. Take TDK C series X5R for example, its pressure voltage value is 16V or 25V; the package size is 0805, 1206 or 0603, the capacitance value is $10\mu\text{F}$. The capacitor's voltage stability of different types of capacitor is as shown below:

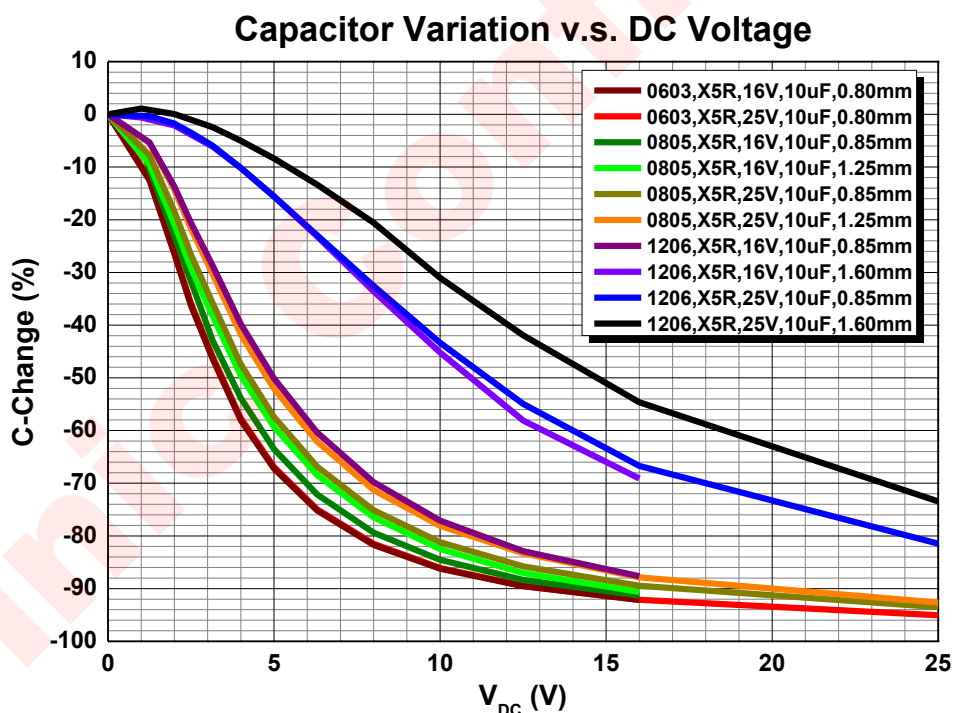

Figure 20 Different types of capacitive voltage stability

It can be found that the rate of capacitance capacity value descent becomes slow along with "large capacitor size, capacitance pressure voltage rise". The larger the package size, the better voltage stability. The higher the height, the better voltage stability with the same length and width of the capacitance. Voltage stability of smaller package size (0603) capacitor change affected by the pressure value is very small.

In typical applications, it is necessary to ensure the residual capacitance should $\geq 4\mu\text{F}$ when $\text{PVDD}=10.25\text{V}$.

Take the following capacitances as the Boost of the output capacitor for example:

value	material	size (mm ³)	rated voltage (V)	quantity	value@10.25V
10 μ F	X5R	1.60x0.80x0.80 (0603)	16	3	4.5 μ F
10 μ F	X5R	2.00x1.25x1.25 (0805)	25	2	4.2 μ F

As for the different manufacturers' capacitors, it's important to determine the type and quantity of the capacitors through the capacitor voltage stability data provided by the manufacturer.

SUPPLY DECOUPLING CAPACITOR

The device is a high-performance audio amplifier that requires adequate power supply decoupling. Place a low equivalent-series-resistance (ESR) ceramic capacitor, typically 0.1 μ F. This choice of capacitor and placement helps with higher frequency transients, spikes, or digital hash on the line. Additionally, placing this decoupling capacitor close to the DEVICE is important, as any parasitic resistance or inductance between the device and the capacitor causes efficiency loss. In addition to the 0.1 μ F ceramic capacitor, place a 10 μ F capacitor on the VBAT supply trace. This larger capacitor acts as a charge reservoir, providing energy faster than the board supply, thus helping to prevent any droop in the supply voltage.

PACKAGE DESCRIPTION

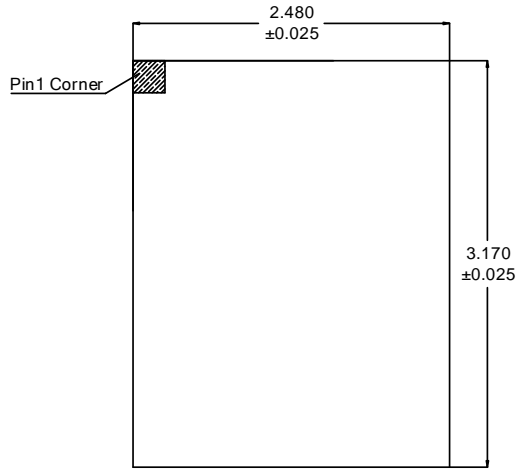

Top View

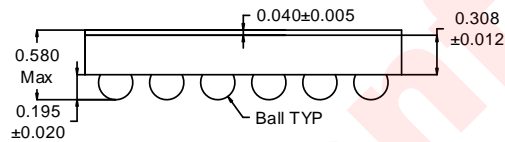

Side View

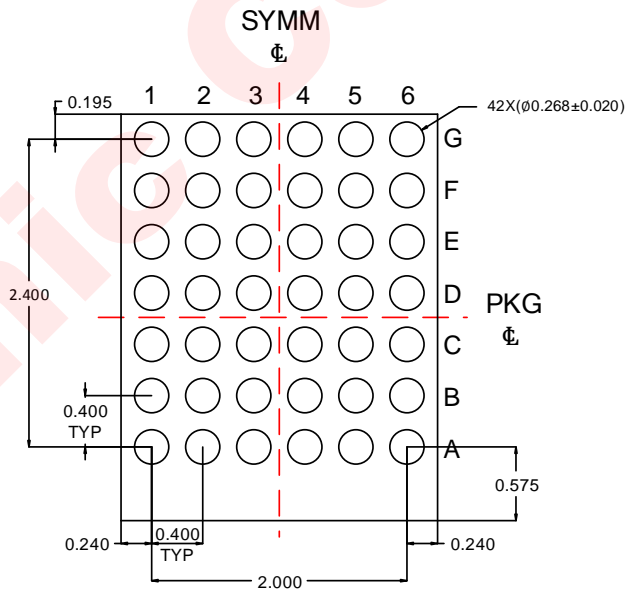

Bottom View

Unit: mm

LAND PATTERN DATA

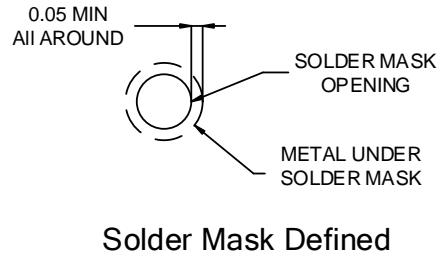
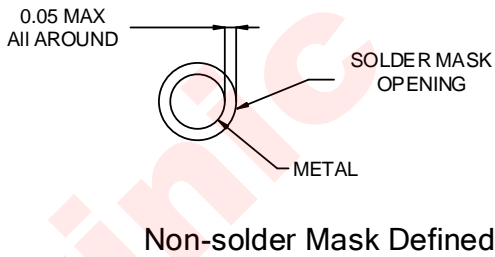
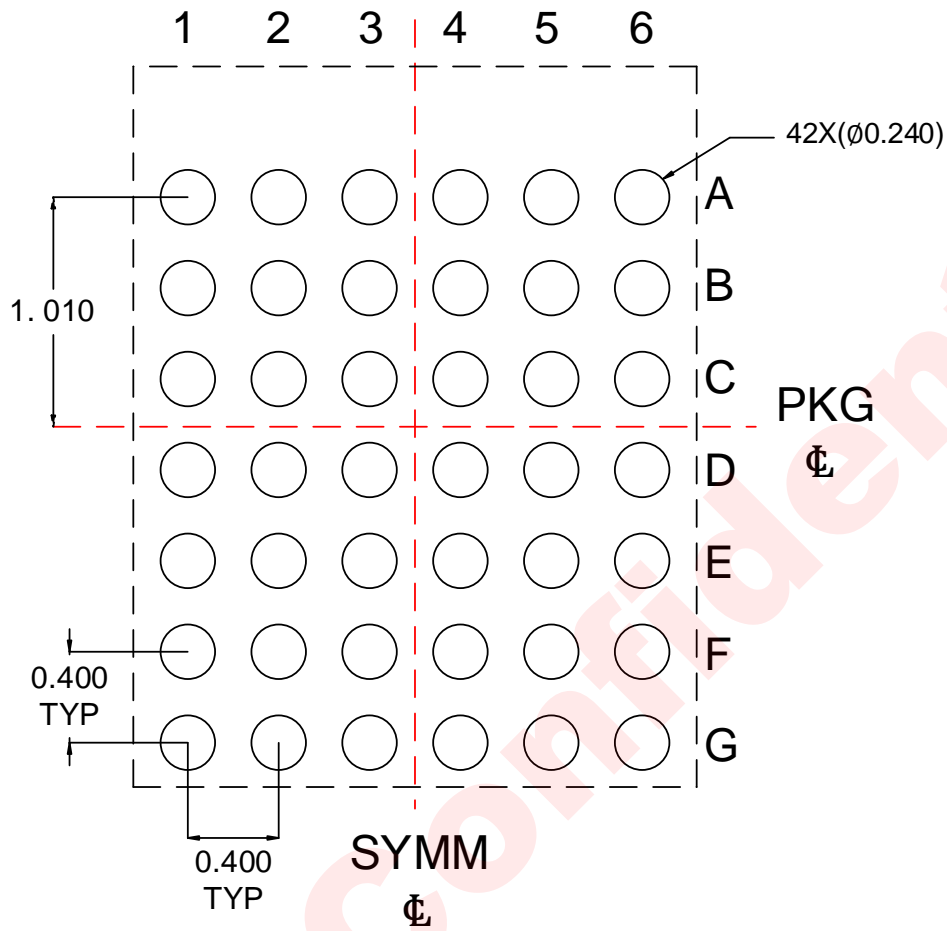

Unit: mm

TAPE AND REEL INFORMATION

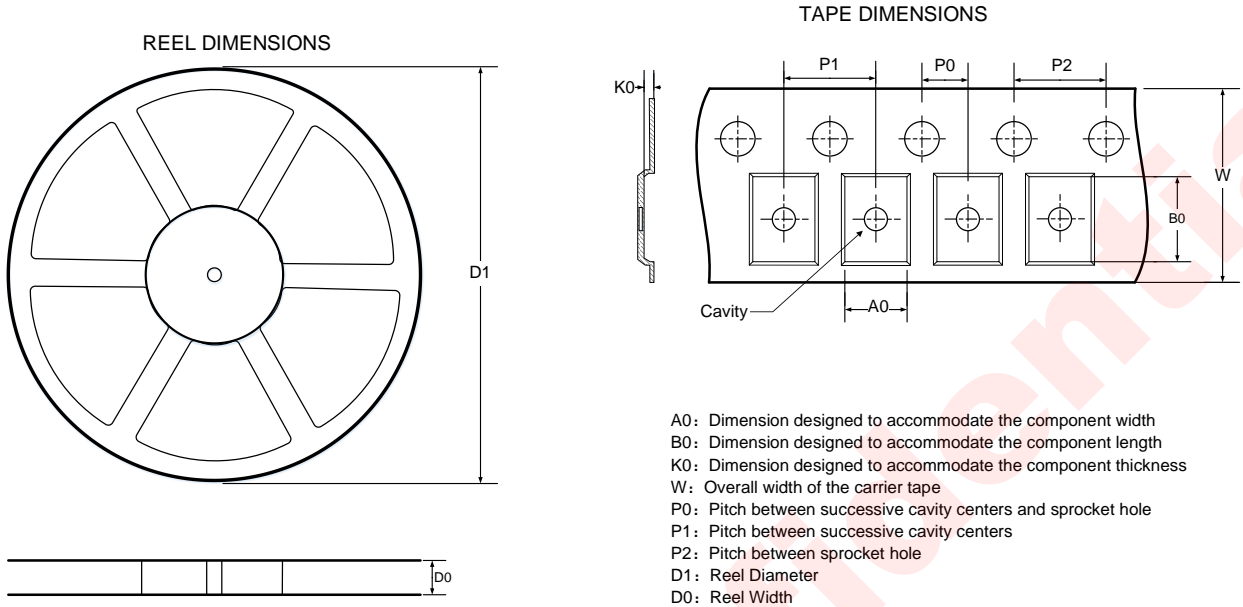

QUADRANT ASSIGNMENTS FOR PIN 1 ORIENTATION IN TAPE

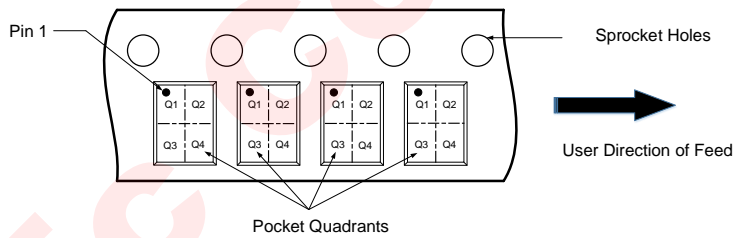

All Dimensions are nominal

D1 (mm)	D0 (mm)	A0 (mm)	B0 (mm)	K0 (mm)	P0 (mm)	P1 (mm)	P2 (mm)	W (mm)	Pin1 Quadrant
330.00	12.40	2.62	3.30	0.81	2.00	8.00	4.00	12.00	Q1

REVISION HISTORY

Version	Date	Change Record
V1.0	Aug. 2019	Officially Released

awinic Confidential

DISCLAIMER

Information in this document is believed to be accurate and reliable. However, Shanghai AWINIC Technology Co., Ltd (AWINIC Technology) does not give any representations or warranties, expressed or implied, as to the accuracy or completeness of such information and shall have no liability for the consequences of use of such information.

AWINIC Technology reserves the right to make changes to information published in this document, including without limitation specifications and product descriptions, at any time and without notice. Customers shall obtain the latest relevant information before placing orders and shall verify that such information is current and complete. This document supersedes and replaces all information supplied prior to the publication hereof.

AWINIC Technology products are not designed, authorized or warranted to be suitable for use in medical, military, aircraft, space or life support equipment, nor in applications where failure or malfunction of an AWINIC Technology product can reasonably be expected to result in personal injury, death or severe property or environmental damage. AWINIC Technology accepts no liability for inclusion and/or use of AWINIC Technology products in such equipment or applications and therefore such inclusion and/or use is at the customer's own risk.

Applications that are described herein for any of these products are for illustrative purposes only. AWINIC Technology makes no representation or warranty that such applications will be suitable for the specified use without further testing or modification.

All products are sold subject to the general terms and conditions of commercial sale supplied at the time of order acknowledgement.

Nothing in this document may be interpreted or construed as an offer to sell products that is open for acceptance or the grant, conveyance or implication of any license under any copyrights, patents or other industrial or intellectual property rights.

Reproduction of AWINIC information in AWINIC data books or data sheets is permissible only if reproduction is without alteration and is accompanied by all associated warranties, conditions, limitations, and notices. AWINIC is not responsible or liable for such altered documentation. Information of third parties may be subject to additional restrictions.

Resale of AWINIC components or services with statements different from or beyond the parameters stated by AWINIC for that component or service voids all express and any implied warranties for the associated AWINIC component or service and is an unfair and deceptive business practice. AWINIC is not responsible or liable for any such statements.

X-ON Electronics

Largest Supplier of Electrical and Electronic Components

Click to view similar products for [Audio Amplifiers](#) category:

Click to view products by [Awinic](#) manufacturer:

Other Similar products are found below :

[LV3313PM-TLM-E](#) [LV47002P-E](#) [LV4924VH-MPB-H](#) [LV4924VH-TLM-H](#) [AZ386MTR-E1](#) [NCP2811AFCT1G](#) [NCP2890AFCT2G](#)
[NCP2993FCT2G](#) [LA4631VC-XE](#) [IS31AP4915A-QFLS2-TR](#) [TDA1591T](#) [AS3561-BWLT-500](#) [TDA7563AH](#) [TDA7850H](#) [TS2012EIJT](#)
[NCP2809BMUTXG](#) [NJW1157BFC2](#) [TPA6201A1ZQVR](#) [IS31AP4996-GRLS2-TR](#) [NCP2823BFCT1G](#) [LA4450L-E](#) [IS31AP2036A-CLS2-TR](#)
[TDA7563ASMTR](#) [STPA001AH](#) [MP1720DH-12-LF-P](#) [SABRE9601K](#) [THAT1646W16-U](#) [PAM8965ZLA40-13](#) [TSDP10XX1NLGXZBX](#)
[TSDP11XX1NBGIZBX](#) [TSDP10XX1NBGIZBX](#) [NJM4580CV-TE1](#) [BD5638NUX-TR](#) [BD37543FS-E2](#) [BD3814FV-E2](#) [TPA3110LD2PWPR](#)
[AS3435-EQFP](#) [VA2218TSG28](#) [AW88194ACSR](#) [NS4150C](#) [NS4158](#) [HT4580ARZ](#) [PAM8403](#) [AD4150B](#) [SL8002A](#) [AD8302](#) [BL6306SO](#)
[VA2221LTSG28](#) [AiP8002SA.TR](#) [8002](#)