

I2S/TDM Input, High Efficiency, 10.25V BOOST Digital Smart K Audio Amplifier with SKTune Algorithm

FEATURES

- **Integrates SKTune Algorithm**
 - Parametric audio path equalizer
 - Multi-band Dynamic range control
 - Anti-clip voltage limiter
 - Speaker Protection
- **Speaker Current and Voltage Sense**
- **Smart BOOST with total efficiency up to 84%**
- **High RF noise suppression, eliminate the TDD noise completely**
- **Low noise: 14uV**
- **THD+N: 0.01%**
- Supports 6Ω Speaker
- Extensive Pop-Click Suppression
- Volume control(from -95.875dB to 0dB)
- I²S/TDM interface:
 - I²S, Left-Justified and Right-Justified
 - Supports 1/2/4/6/8 slots TDM
 - Input Sample Rates from 8kHz to 96kHz
 - Data Width: 16, 20, 24, 32 Bits
- I²C-bus control interface(400kHz)
- Power Supplies:
 - VDD: 3.0V~5.5V
 - DVDD: 1.65V~1.95V
- Short-Circuit Protection, Over-Temperature Protection, Under-Voltage Protection and Over-Voltage Protection
- WLCSP 2.60mmX3.13mmX0.543mm-42B package

APPLICATIONS

- Mobile phones
- Tablets
- Portable Audio Devices

DESCRIPTION

The AW88395 is an I²S/TDM input, high efficiency digital Smart K audio amplifier with an integrated 10.25V smart boost converter and SKTune speaker protection algorithms. Due to its 14uV noise floor and ultra-low distortion, clean listening is guaranteed. It can deliver 5.3W output power into an 8Ω speaker at 1% THD+N.

The AW88395 integrates SKTune algorithm that includes parametric audio path equalizer, multi-band dynamic range control, anti-clip voltage limiter and speaker protection. The SKTune algorithm maximizes speaker performance while maintaining safe speaker conditions.

The AW88395 integrates a high-efficiency smart boost converter as the Class-D amplifier supply rail. The output voltage of boost converter can be adjusted smartly according to the amplitude of input signal, which extremely improves the efficiency without clipping distortion.

The AW88395 features high RF suppression and eliminates TDD noise completely benefited from the digital audio input interface. General settings are communicated via an I²C-bus interface, and the device address is configurable.

The AW88395 offers Short Circuit Protection, Over-Temperature Protection, Under-Voltage Protection and Over-Voltage Protection to protect the device.

AW88395 is available in a WLCSP 2.60mmX3.13mmX0.543mm-42B package.

PIN CONFIGURATION AND TOP MARK

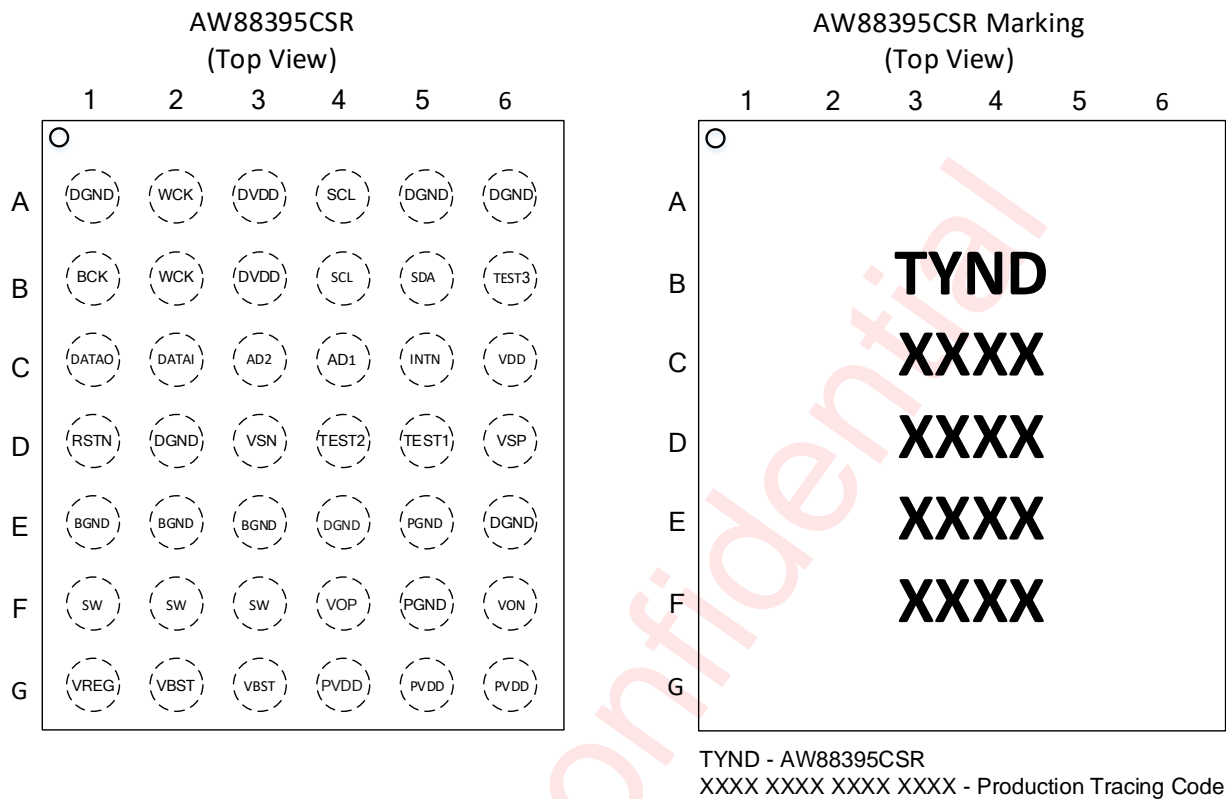

Figure 1 AW88395CSR pin diagram top view and device marking

PIN DESCRIPTION

| Pin No | Pin Name | Description |
|-----------------------|----------|--|
| A1,A5,A6,D2, E4,E6 | DGND | Digital GND |
| A2,B2 | WCK | I ² S word select input / TDM frame sync signal |
| A3,B3 | DVDD | Digital power supply |
| A4,B4 | SCL | I ² C clock input |
| B1 | BCK | I ² S/TDM bit clock input |
| B5 | SDA | I ² C data I/O |
| B6 | TEST3 | Test signal input 3, connected to ground |
| C1 | DATAO | I ² S/TDM data out |
| C2 | DATAI | I ² S/TDM data input |
| C3 | AD2 | I ² C address select input |
| C4 | AD1 | I ² C address select input |

| Pin No | Pin Name | Description |
|----------|----------|--|
| C5 | INTN | Interrupt output |
| C6 | VDD | Battery power supply |
| D1 | RSTN | Active low hardware reset |
| D3 | VSN | Voltage sense inverting |
| D4 | TEST2 | Test signal input 2, connected to ground |
| D5 | TEST1 | Test signal input 1, connected to ground |
| D6 | VSP | Voltage sense non-inverting |
| E1,E2,E3 | BGND | Boost GND |
| E5,F5 | PGND | Power GND |
| F1,F2,F3 | SW | Boost switch pin |
| F4 | VOP | Non-inverting Class-D output |
| F6 | VON | Inverting Class-D output |
| G1 | VREG | Voltage output of regulator |
| G2,G3 | VBST | Boost output |
| G4,G5,G6 | PVDD | Class-D power supply |

FUNCTIONAL BLOCK DIAGRAM

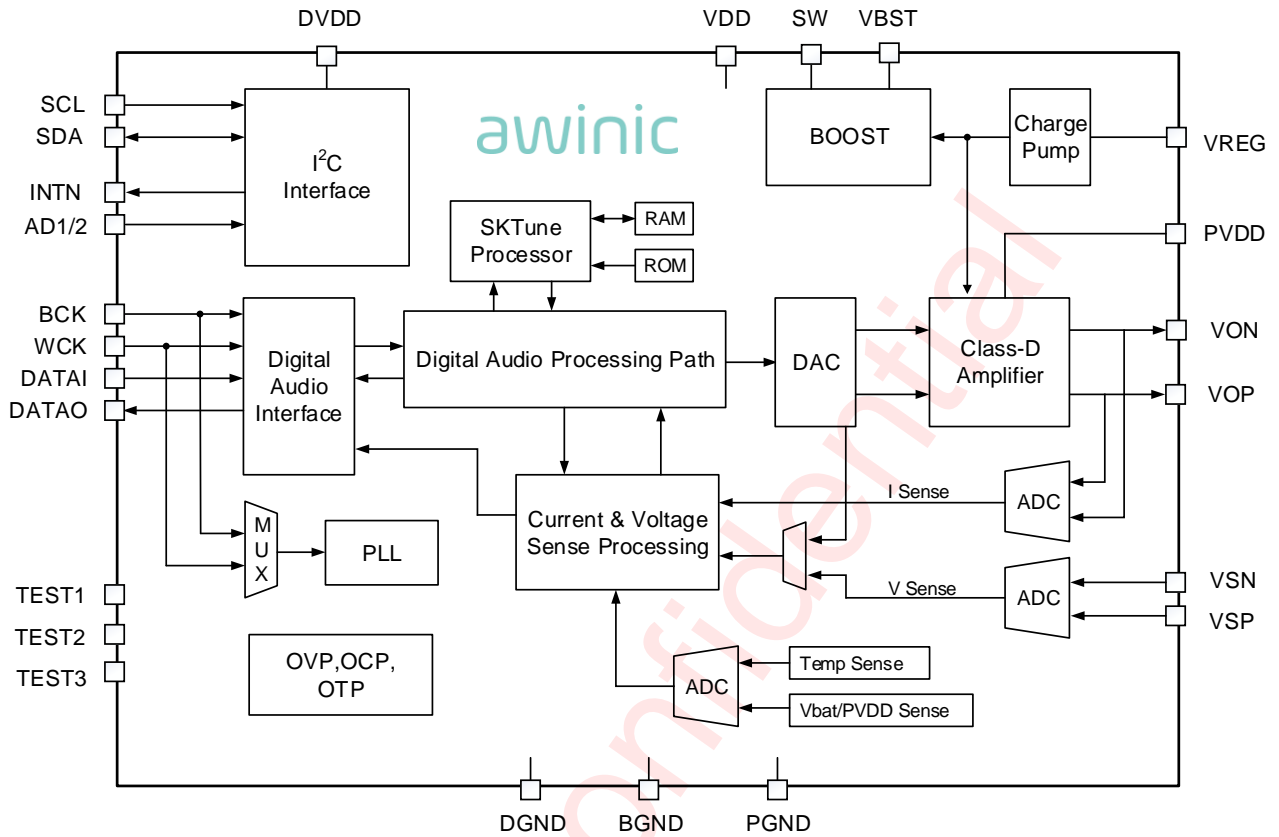

Figure 2 FUNCTIONAL BLOCK DIAGRAM

APPLICATION DIAGRAM

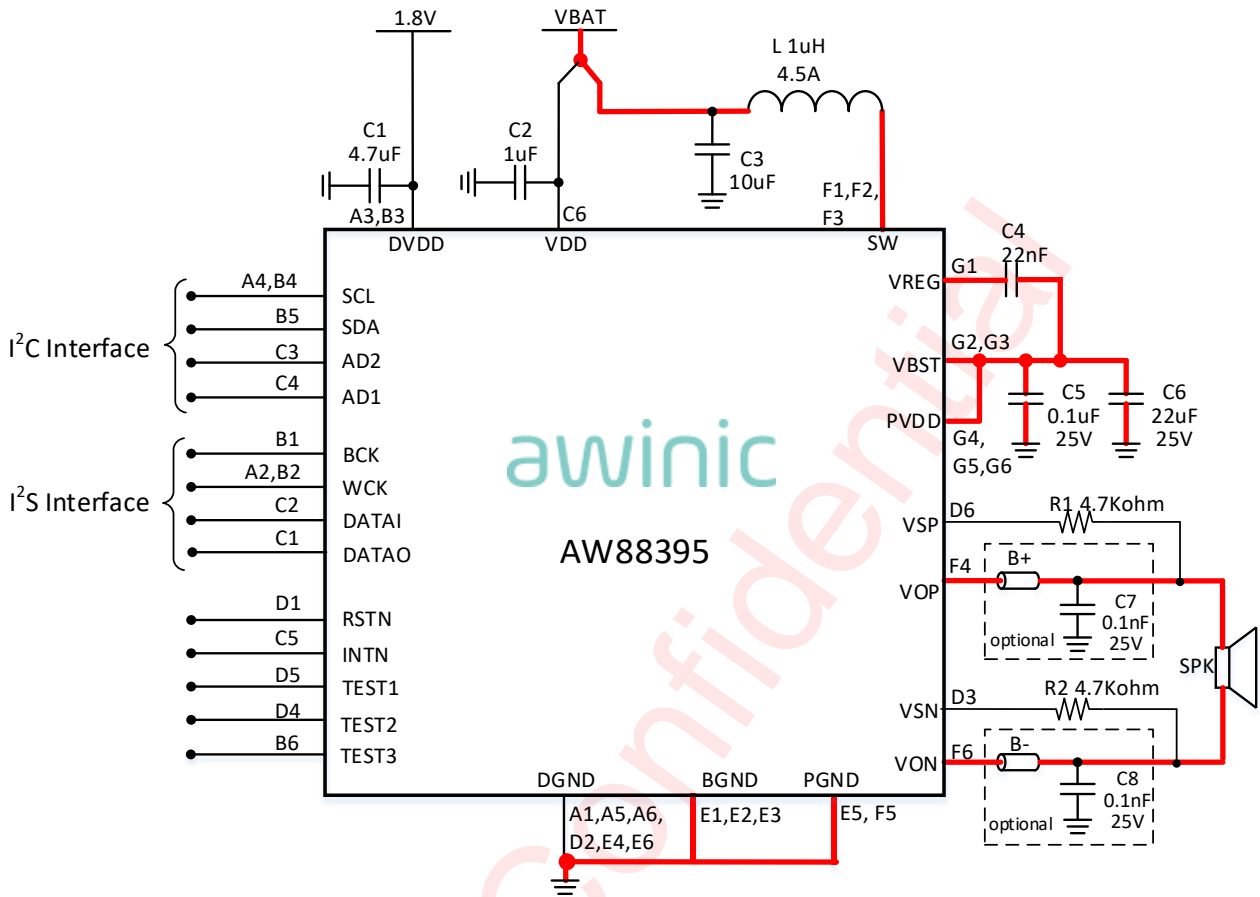

Figure 3 AW88395 Application Circuit

Note: Traces carry high current are marked in red in the above figure

All trademarks are the property of their respective owners.

ORDERING INFORMATION

| Product Type | Temperature | Package | Device Marking | Moisture Sensitivity Level | Environmental Information | Delivery Form |
|--------------|--------------|--|----------------|----------------------------|---------------------------|---------------------------------|
| AW88395CSR | -40°C ~ 85°C | WLCSP 2.60mmX3.13mm X0.543mm-42B | TYND | MSL1 | RoHS+HF | 6000 units/ Tape and Reel |

awinic Confidential

ABSOLUTE MAXIMUM RATING (NOTE1)

| Parameter | Range |
|--|---------------------------|
| Battery Supply Voltage V_{DD} | -0.3V to 6V |
| Digital Supply Voltage V_{DVDD} | -0.3V to 2V |
| Boost output voltage V_{PVDD} | -0.3 to 12V |
| Boost SW pin voltage | -0.3 to 12V (Note 2) |
| VOP/VON pin voltage | -0.3 to 12V (Note 2) |
| VREG pin voltage | -0.3 to $V_{PVDD}+6V$ |
| Minimum load resistance R_L | 5Ω |
| Package Thermal Resistance θ_{JA} | 48°C/W |
| Ambient Temperature Range | -40°C to 85°C |
| Maximum Junction Temperature T_{JMAX} | 165°C |
| Storage Temperature Range T_{STG} | -65°C to 150°C |
| Lead Temperature (Soldering 10 Seconds) | 260°C |
| ESD Rating (Note 3,4) | |
| HBM (Human Body Model) | ±2000V |
| CDM (Charge Device Model) | ±1500V |
| Latch-up | |
| Test Condition: JESD78E | +IT: 200mA -IT: -200mA |

Note 1: Stresses beyond those listed under "absolute maximum ratings" may cause permanent damage to the device. These are stress ratings only and functional operation of the device at these or any other conditions beyond those indicated under "recommended operating conditions" is not implied. Exposure to absolute-maximum-rated conditions for extended periods may affect device reliability.

Note 2: SW/VOP/VON pin can handle 16V transients for less than 5ns

Note 3: The human body model is a 100pF capacitor discharged through a 1.5kΩ resistor into each pin. Test method: ESDA/JEDEC JS-001-2017

Note 4: Test method: ESDA/JEDEC JS-002-2018

ELECTRICAL CHARACTERISTICS

CHARACTERISTICS

Test condition: $T_A=25^{\circ}\text{C}$, $V_{DD}=3.6\text{V}$, $DV_{DD}=1.8\text{V}$, $PV_{DD}=10.25\text{V}$, $R_L=8\Omega+33\mu\text{H}$, $f=1\text{kHz}$ (unless otherwise noted)

| Symbol | Description | Test Conditions | Min | Typ. | Max | Units |
|----------------|----------------------------------|---|------|--------------------------|------|---------------|
| V_{DD} | Battery supply voltage | On pin VDD | 3.0 | | 5.5 | V |
| DV_{DD} | Digital supply voltage | On pin DVDD | 1.65 | 1.8 | 1.95 | V |
| I_{VDD} | Battery supply current | Operating mode | | 6 | | mA |
| | | Standby mode | | 2.5 | | μA |
| | | Power down mode | | 0.5 | 2 | μA |
| I_{DVDD} | Digital supply current | Operating mode, SKTune Algorithm activated | | 18 | | mA |
| | | Operating mode, SKTune Algorithm bypassed | | 5.5 | | mA |
| | | Standby mode | | 9 | | μA |
| | | Power down mode | | 8 | | μA |
| Boost | | | | | | |
| V_{PVDD} | Boost output voltage | | | 10.25 ^(Note1) | | V |
| V_{OVP} | Over-voltage threshold | | | $V_{PVDD}+0.75$ | | V |
| | OVP hysteresis voltage | | | 400 | | mV |
| I_{L_PEAK} | Inductor peak current limit | | | 4.0 ^(Note1) | | A |
| F_{BST} | Operating Frequency | $f_s = 48\text{KHz}$ | | 1.6 | | MHz |
| Class-D | | | | | | |
| R_{dson} | Drain-Source on-state resistance | High side MOS + Low side MOS | | 350 | | m Ω |
| P_o | Speaker Output Power | THD+N=1%, $R_L=8\Omega+33\mu\text{H}$, $V_{DD}=4.2\text{V}$, $PV_{DD}=10.25\text{V}$ | | 5.3 | | W |
| | | THD+N=10%, $R_L=8\Omega+33\mu\text{H}$, $V_{DD}=4.2\text{V}$, $PV_{DD}=10.25\text{V}$ | | 6.3 | | W |
| | | THD+N=1%, $R_L=6\Omega+33\mu\text{H}$, $V_{DD}=4.2\text{V}$, $PV_{DD}=10.25\text{V}$ | | 5.4 | | W |
| | | THD+N=10%, $R_L=6\Omega+33\mu\text{H}$, $V_{DD}=4.2\text{V}$, $PV_{DD}=10.25\text{V}$ | | 6.5 | | W |
| V_{OS} | Output offset voltage | I ² S signal input 0 | -10 | 0 | 10 | mV |

| Symbol | Description | Test Conditions | Min | Typ. | Max | Units |
|----------------------------------|--------------------------------------|--|-----------------------|-------|-----------------------|---------|
| η | Total efficiency (Class-D) | $V_{DD}=4.2V$, $P_o=0.45W$, $R_L=8\Omega+33\mu H$ | | 87 | | % |
| | Total efficiency (Boost+Class-D) | $V_{DD}=4.2V$, $P_o=2W$, $R_L=8\Omega+33\mu H$ | | 84 | | % |
| THD+N | Total harmonic distortion plus noise | $V_{DD}=4.2V$, $P_o=1W$, $R_L=8\Omega+33\mu H$, $f=1kHz$, $PVDD=10.25V$ | | 0.01 | | % |
| E_N | Speaker Mode Output noise | A-weighting | | 18 | | μV |
| | Receiver Mode Output noise | A-weighting | | 14 | | μV |
| SNR | Signal-to-noise ratio | $V_{DD}=4.2V$, $PVDD=10.25V$, $P_o=5.3W$, $R_L=8\Omega+33\mu H$, A-weighting | | 110 | | dB |
| DNR | Dynamic Range | -60dBFS Method, A-weighting | | 109 | | dB |
| PSRR | Power supply rejection ratio | Receiver Mode $V_{DD}=4.2V$, $V_{p-p_sin}=200mV$ | 217Hz | | 85 | dB |
| | | | 1kHz | | 85 | dB |
| Current Sense | | | | | | |
| I_{SNS_FS} | Current sense full scale | | | 3.667 | | A |
| SNR | Signal-to-noise ratio | $P_o=1W$, $R_L=8\Omega+33\mu H$, A-weighting | | 65 | | dB |
| THD+N | Total harmonic distortion plus noise | $P_o=1W$, $R_L=8\Omega+33\mu H$ | | 0.4 | | % |
| ΔI_{SNS} | Current sense accuracy | $P_o=1W$, $R_L=8\Omega+33\mu H$ | | 2 | | % |
| Voltage Sense | | | | | | |
| V_{SNS_FS} | Voltage sense full scale | | | 16.5 | | V |
| SNR | Signal-to-noise ratio | $P_o=1W$, $R_L=8\Omega+33\mu H$, A-weighting | | 65 | | dB |
| THD+N | Total harmonic distortion plus noise | $P_o=1W$, $R_L=8\Omega+33\mu H$ | | 0.1 | | % |
| ΔV_{SNS} | Voltage sense accuracy | $P_o=1W$, $R_L=8\Omega+33\mu H$ | | 2 | | % |
| Digital Logical Interface | | | | | | |
| V_{IL} | Logic input low level | BCK, WCK, DATA1 Pin | | | $0.3 \times V_{DVDD}$ | V |
| V_{IH} | Logic input high level | | $0.7 \times V_{DVDD}$ | | V_{DVDD} | V |

| Symbol | Description | Test Conditions | Min | Typ. | Max | Units |
|-------------------|--|---------------------------------|-----------------------------|------|----------------------------|-------|
| V _{IL} | Logic input low level | RSTN, SCL, SDA, AD1, AD2 Pin | | | 0.3 x V _{DVDD} | V |
| V _{IH} | Logic input high level | | 0.7 x V _{DVDD} | | 3.6 | V |
| V _{OL} | Logic output low level | I _{OUT} =2mA | | | 0.45 | V |
| V _{OH} | Logic output high level | I _{OUT} =-2mA | V _{DVDD} - 0.45 | | V _{DVDD} | V |
| Protection | | | | | | |
| T _{SD} | Over temperature protection threshold | | | 150 | | °C |
| T _{SDR} | Over temperature protection recovery threshold | | | 130 | | °C |
| UVP | Under-voltage protection voltage | | | 2.4 | | V |
| | Under-voltage protection hysteresis voltage | | | 200 | | mV |

Note 1: Registers are adjustable; Refer to the list of registers.

I²C INTERFACE TIMING

| Parameter | | | MIN | TYP | MAX | UNIT |
|-----------|---------------------|---|-----|-----|-----|------|
| No. | Sym | Name | | | | |
| 1 | f _{SCL} | SCL Clock frequency | | | 400 | kHz |
| 2 | t _{LOW} | SCL Low level Duration | 1.3 | | | μs |
| 3 | t _{HIGH} | SCL High level Duration | 0.6 | | | μs |
| 4 | t _{RISE} | SCL, SDA rise time | | | 0.3 | μs |
| 5 | t _{FALL} | SCL, SDA fall time | | | 0.3 | μs |
| 6 | t _{SU:STA} | Setup time SCL to START state | 0.6 | | | μs |
| 7 | t _{HD:STA} | (Repeat-start) Start condition hold time | 0.6 | | | μs |
| 8 | t _{SU:STO} | Stop condition setup time | 0.6 | | | μs |
| 9 | t _{BUF} | the Bus idle time START state to STOP state | 1.3 | | | μs |
| 10 | t _{SU:DAT} | SDA setup time | 0.1 | | | μs |
| 11 | t _{HD:DAT} | SDA hold time | 10 | | | ns |

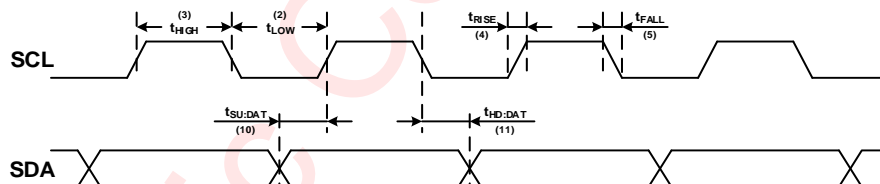
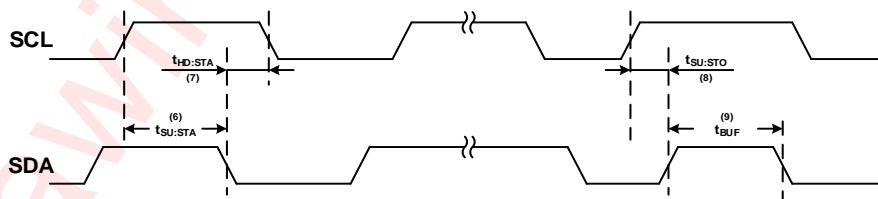
**Figure 4 SCL and SDA timing relationships in the data transmission process****Figure 5 The timing relationship between START and STOP state**

DIGITAL AUDIO INTERFACE TIMING

| Parameter Name | | Min | Typ. | Max | Units |
|----------------|---------------------------------|----------------|------|------------------------|-------|
| f_s | sampling frequency, on pin WCK | 8 | | 96 | kHz |
| f_{bck} | Bit clock frequency, on pin BCK | $32 \cdot f_s$ | | $256 \cdot f_s$ (NOTE) | Hz |
| t_{su} | WCK, DATAI Setup time to BCK | 10 | | | ns |
| t_h | WCK, DATAI hold time to BCK | 10 | | | ns |
| t_d | DATAO output delay time to BCK | | | 40 | ns |

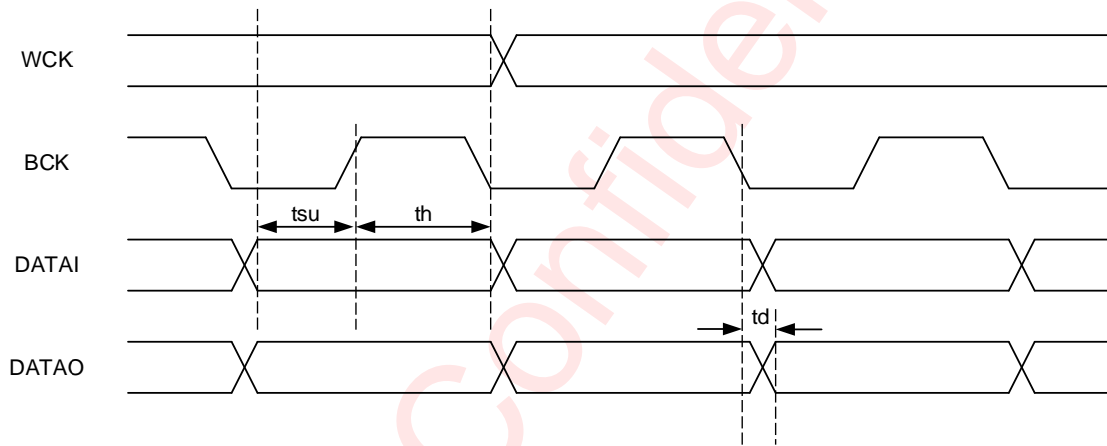
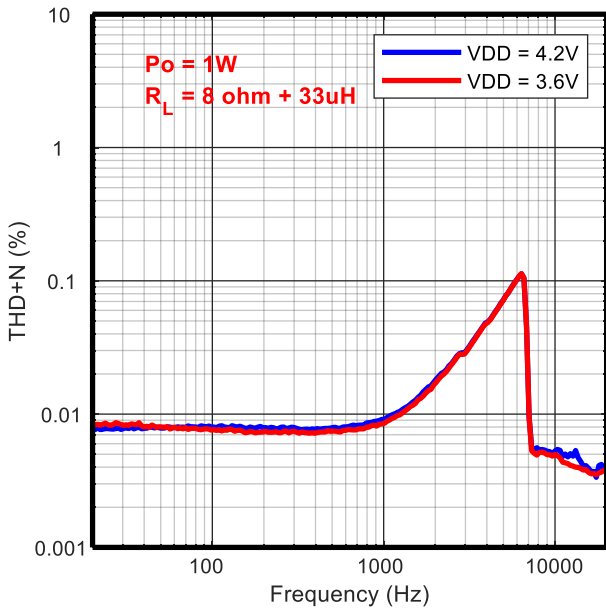

Figure 6 Digital Audio Interface Timing

NOTES: The digital audio interface supports up to 8 slots (32-bit) at a 32/44.1/48 kHz sample rate, and 4 slots (32-bit) at a 96 kHz sample rate.

TYPICAL CHARACTERISTIC CURVES

THD+N VS. FREQUENCY



THD+N VS. FREQUENCY

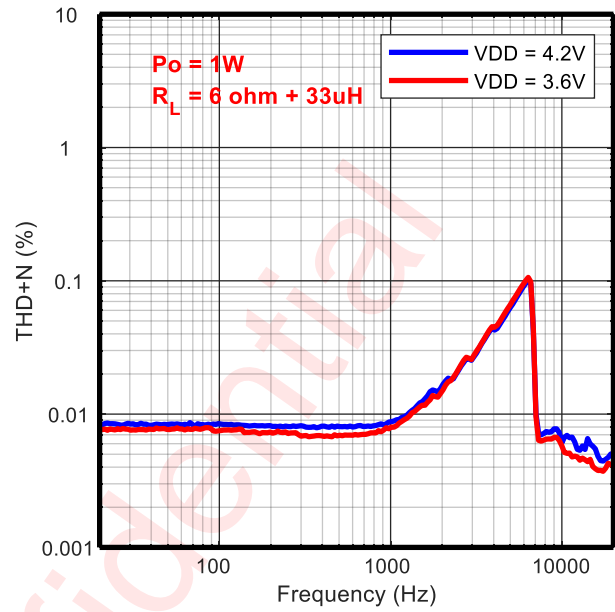

THD+N VS. OUTPUT POWER

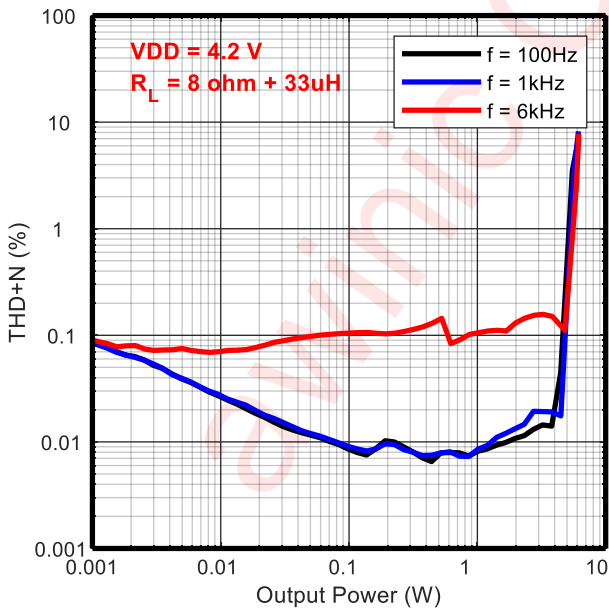

THD+N VS. OUTPUT POWER

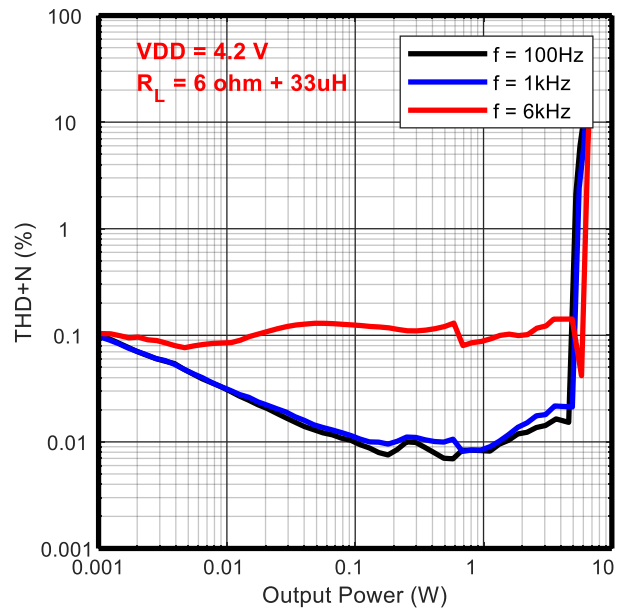

THD+N VS. OUTPUT POWER

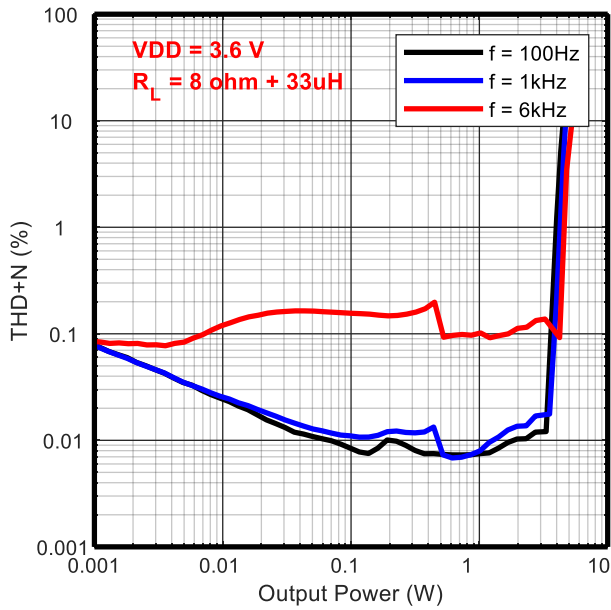

THD+N VS. OUTPUT POWER

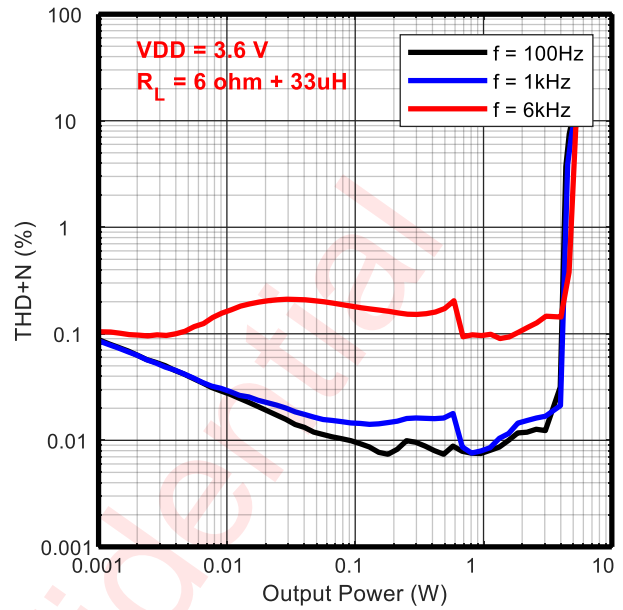

SPEAKER GAIN VS. FREQUENCY

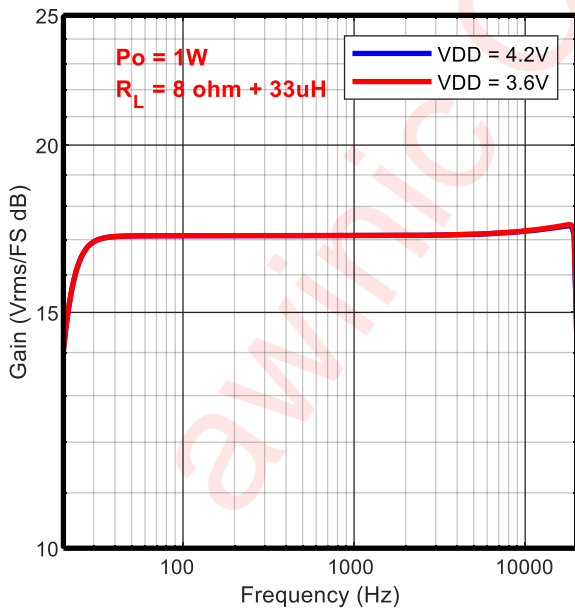

RECEIVER GAIN VS. FREQUENCY

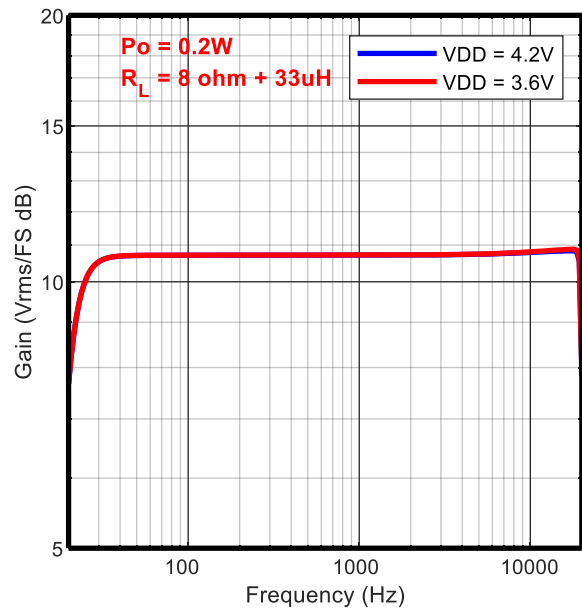

EFFICIENCY VS. OUTPUT POWER

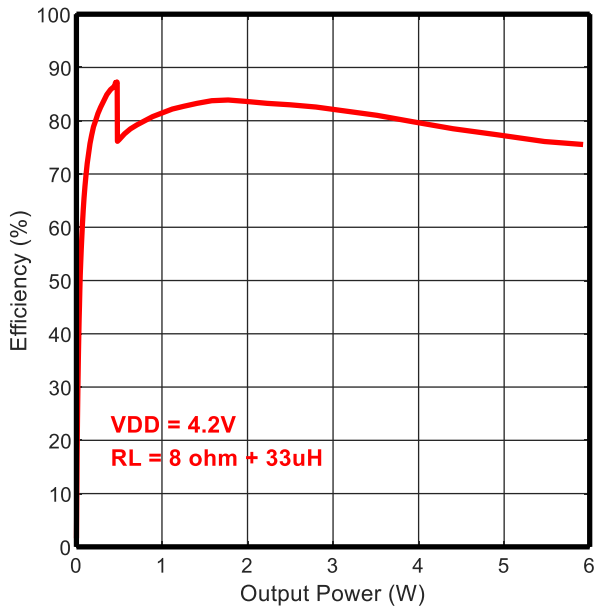

EFFICIENCY VS. OUTPUT POWER

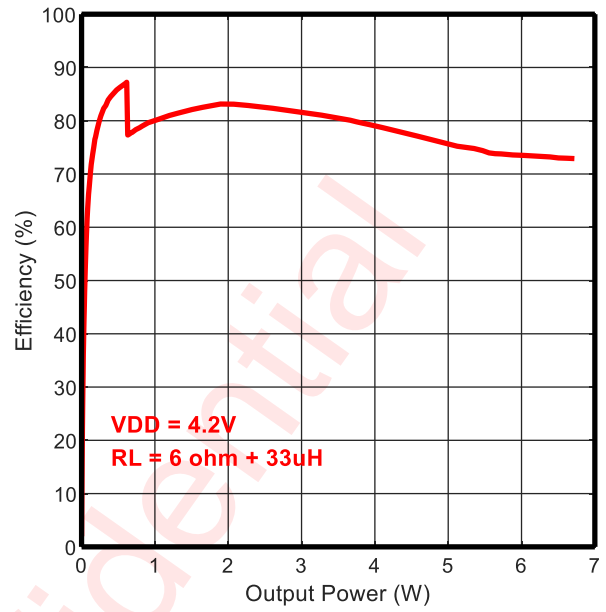

RECEIVER PSRR VS. FREQUENCY

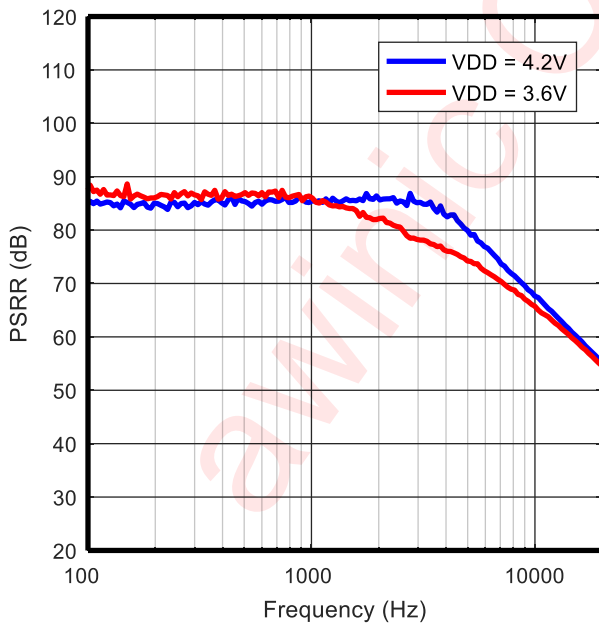

DETAIL FUNCTIONAL DESCRIPTION

POWER ON RESET

The device provides a power-on reset feature that is controlled by VDD and DVDD supply voltage. When the VDD supply voltage raises from 0V to 2.1V, or DVDD supply voltage raises from 0V to 1.1V. The reset signal will be generated to perform a power-on reset operation, which will reset all circuits and configuration registers.

OPERATION MODE

The device supports 4 operation modes.

Table 1 Operating Mode

| Mode | Condition | Description |
|--------------------|---------------------------------------|--|
| Power-Down | $V_{DD} < 2.1V$ $V_{DVDD} < 1.1V$ | Power supply is not ready, chipset is power down. |
| Stand-By | $V_{DD} > 3.0V$ $V_{DVDD} > 1.65V$ | Power supply is ready, most parts of the device are power down for low power consumption except I ² C interface |
| Configuring | PWDN = 0 | Device is biased while boost and class-D output is floating. System configuration carried out in this mode |
| Operating | AMPPD = 0 | Amplifier is fully operating |

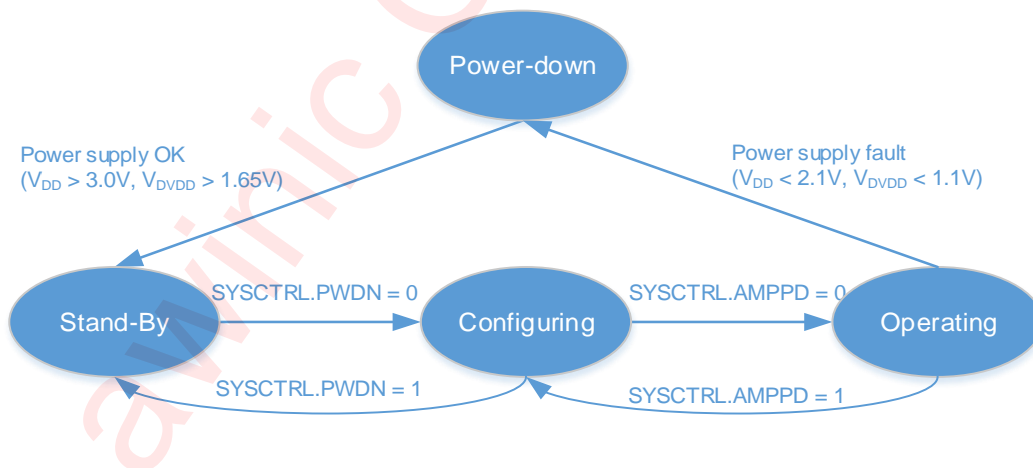

Figure 7 Device operating modes transition

POWER-DOWN MODE

The device switches to power-down mode when any of the following events occurred:

- $V_{DVDD} < 1.1 V$
- $V_{DD} < 2.1 V$
- RSTN pin goes LOW

In this mode, all circuits inside this device will be shut down except the power-on-reset circuit. I²C interface isn't accessible in this mode, and all of the internal configurable registers are cleared.

The device will jump out of the power-down mode automatically when all of the supply voltages are OK ($V_{DVDD} > 1.65\text{ V}$ and $V_{DD} > 3.0\text{ V}$) and RSTN goes HIGH.

STAND-BY MODE

The device switches stand-by mode when the power supply voltages are OK and RSTN pin is HIGH. In this mode I²C interface is accessible, other modules are still powered down. Customer can set device to stand-by mode when the device is no needed to work.

CONFIG MODE

The device switches to OFF mode when:

- SYSCTRL.PWDN = 0;
- SYSCTRL.AMPPD = 1;

In this mode the internal bias, OSC and PLL modules will start to work.

OPERATING MODE

The device is fully operational in this mode. Boost, amplifier loop and power stage circuits will start to work. Customer can set SYSCTRL.AMPPD = 0 to make device in this mode.

This device power up sequence is illustrated in the following figure:

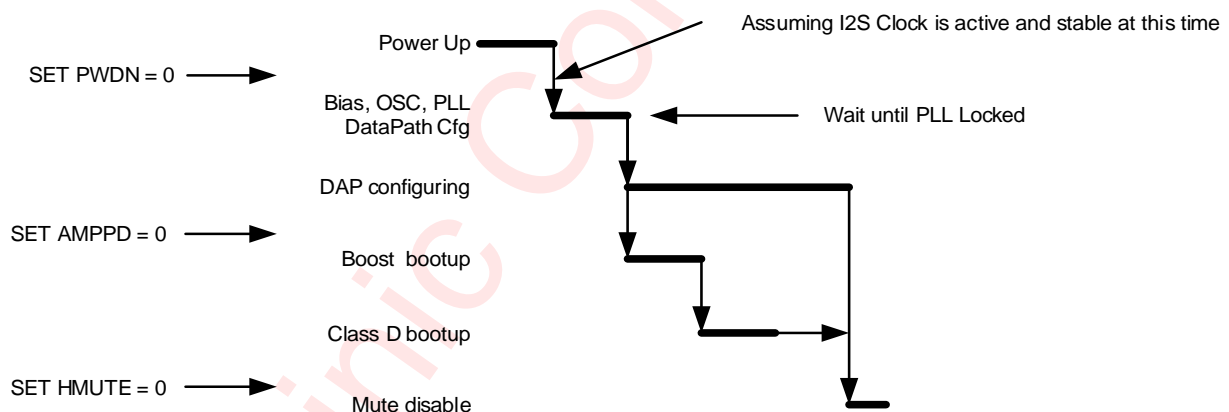

Figure 8 Power up sequence

Detail description for each step is listed in the following table.

Table 2 Detail Description of Power up sequence

| Index | Description | Mode |
|-------|--|-------------|
| 1 | Wait for VDD、 DVDD supply power up | Power-Down |
| 2 | I ² S + Data Path Configuration | Stand-By |
| 3.1 | Enable system (SYSCTRL.PWDN = 0) | Configuring |
| 3.2 | Bias, OSC, PLL active | |
| 3.3 | Waiting for PLL locked | |
| 4.1 | Enable Boost and amplifier (SYSCTRL.AMPPD =0) Boost and Amplifier boot up | Operating |
| 4.2 | Waiting for SYSST.SWS =1 | |
| 5 | Release Hard-Mute Data Path active | |

Power up sequence considering I2S, I2C timing shows as below:

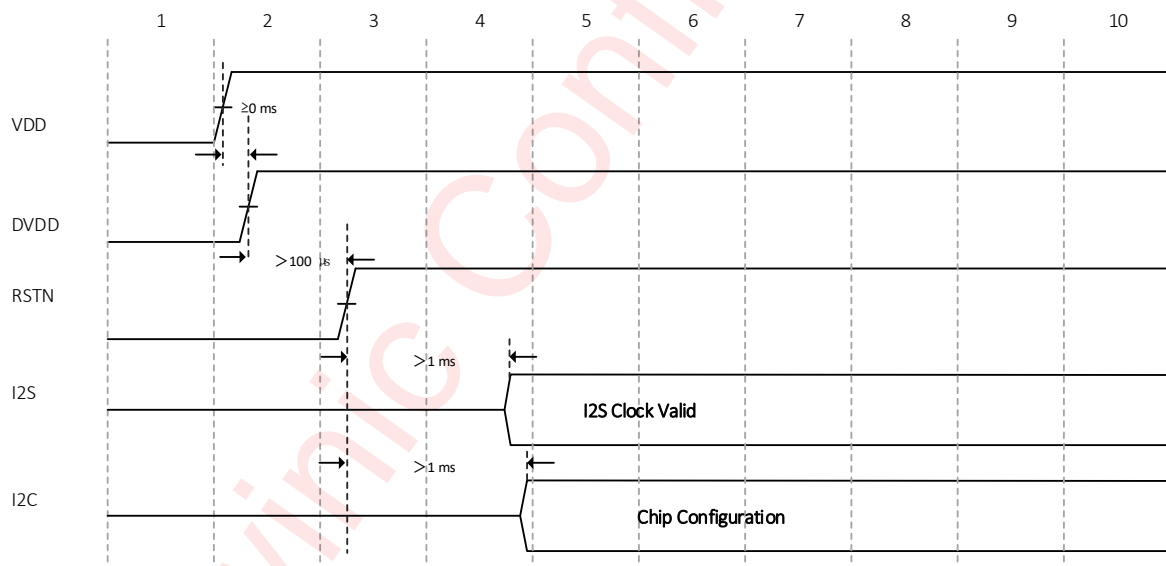

Power down sequence considering I2S, I2C timing shows as below:

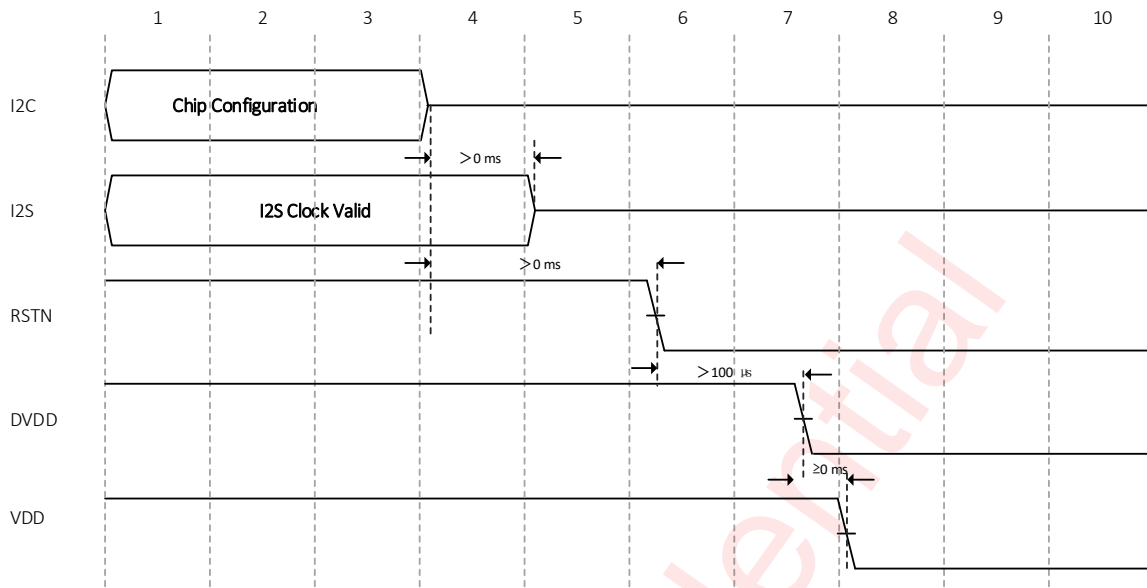

SOFTWARE RESET

Writing 0x55AA to register ID (0x00) via I²C interface will reset the device internal circuits and all configuration registers are cleared.

DIGITAL AUDIO INTERFACE

Audio data is transferred between the host processor and the device via the Digital Audio Interface. The digital audio interface is in full-duplex via 4 dedicated pins:

- BCK
- WCK
- DATAI
- DATAO

Two-slot I²S and 1/2/4/6/8-slot TDM are supported in this device. The digital audio interface supports up to 8 slots (32-bit) at a 32/44.1/48 kHz sample rate, and 4 slots (32-bit) at a 96 kHz sample rate. The digital audio interface on this device is slaver only and flexible with data width options, including 16, 20, 24, or 32 bits by configurable registers.

Three modes of I²S are supported, including standard I²S mode, left-justified mode and right-justified data mode, which can be configured via I2SCTRL.I2SMOD. These modes are all MSB-first, with data width programmable via I2SCTRL.I2SFS.

The word clock WCK is used to define the beginning of a frame. The frequency of this clock corresponds to the sampling frequency. The device supports the following sample rates (fs): 8 kHz, 11.025 kHz, 12 kHz, 16 kHz, 22.05 kHz, 24 kHz, 32 kHz, 44.1 kHz, 48 kHz and 96 kHz. It is selected via configurable register I2SCTRL.I2SSR.

The bit clock BCK is used to sample the digital audio data across the digital audio interface. The number of bit-clock pulses in a frame is defined as slot length. Three kind of slot length are supported (16/24/32) via

configurable register I2SCTRL.I2SBCK. The frequency of BCK can be calculated according to the following equation:

$$BCK \text{ frequency} = \text{SampleRate} * \text{SlotLength} * \text{SlotNumber}$$

SampleRate: Sample rate for this digital audio interface;

SlotLength: The length of one audio slot in unit of BCK clock;

SlotNumber: How many slots supported in this audio interface. For example: 2-slot supported in I2S mode, 1/2/4/6/8-slot supported in TDM mode.

The word select and bit clock signals of the I²S input are the reference signals for the digital audio interface, both WCK and BCK could be used as the reference clock of internal Phased Locked Loop (PLL).

The input audio data can be attenuated -6dB in this module, by setting bit I2SCFG2.INPLEV. The audio source can be from left channel, right channel or the average of the left and right channel, which is controlled by I2SCTRL.CHSEL.

Table 3 Supported I2S interface parameters

| Interface format(MSB first) | Data width | BCK frequency |
|-----------------------------|-------------|------------------|
| Standard I ² S | 16b | 32fs/48fs /64fs |
| | 20b/24b/32b | 48fs /64fs |
| Left-justified | 16b | 32fs/48fs /64fs |
| | 20b/24b/32b | 48fs /64fs |
| Right-justified | 16b | 32fs /48fs /64fs |
| | 20b/24b/32b | 48fs /64fs |

The output port DATAO, can be enabled or disabled via bit I2SCFG1.I2STXEN. The unused slots can be set to Hi-z or active, which is controlled by I2SCFG2.DOHZ. When the unused slots are active, the data could be zeros or same data of used slot, which can be configured via I2SCFG2.I2SDOSEL.

STANDARD I²S MODE

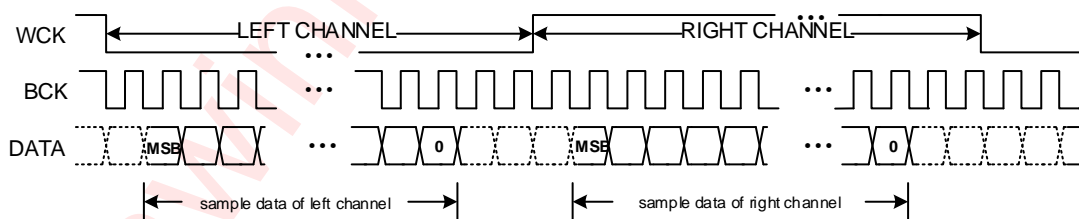
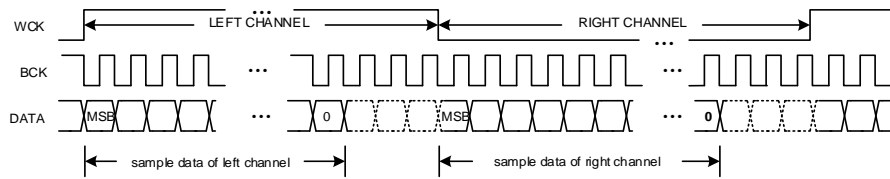
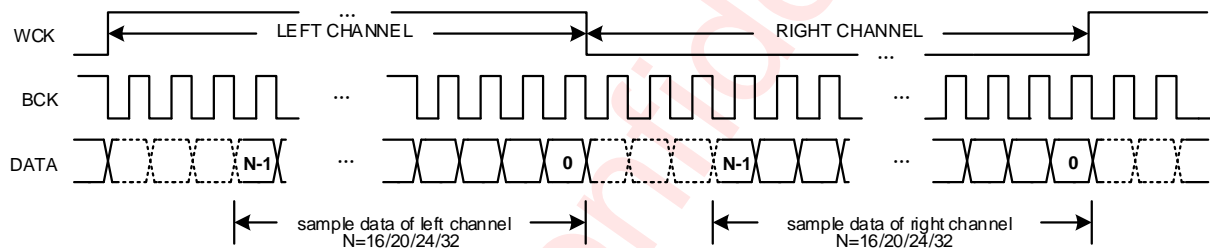

Figure 9 I²S Timing for Standard I²S Mode

- When WCK=0 indicating the left channel data, and WCK=1 indicating the right channel data.
- The MSB of the left channel is valid on the second rising edge of the bit clock after the falling edge of the word clock. Similarly the MSB of the right channel is valid on the second rising edge of the bit clock after the rising edge of the word clock.

LEFT-JUSTIFIED MODE**Figure 10 I²S Timing for Left-Justified Mode**

- When WCK=1 indicating the left channel data, and WCK=0 indicating the right channel data.
- The MSB of the left channel is valid on the first rising edge of the bit clock after the rising edge of the word clock. Similarly the MSB of the right channel is valid on the first rising edge of the bit clock after the falling edge of the word clock.

RIGHT-JUSTIFIED MODE**Figure 11 I²S Timing for Right-Justified Mode**

- When WCK is high indicating the left channel data, and WCK=0 indicating the right channel data.
- The LSB (bit 0) of the left channel is valid on the rising edge of the bit clock preceding the falling edge of the word clock. Similarly, the LSB (bit 0) of the right channel is valid on the rising edge of the bit clock preceding the rising edge of the word clock.

TDM MODE

All of the three kinds of bit synchronization modes (standard, left-justified, right-justified) are also supported in TDM mode. The difference between TDM and I2S is the supported slot-number. 1/2/4/6/8-slot is supported in TDM mode, while 2-slot is supported in I2S mode

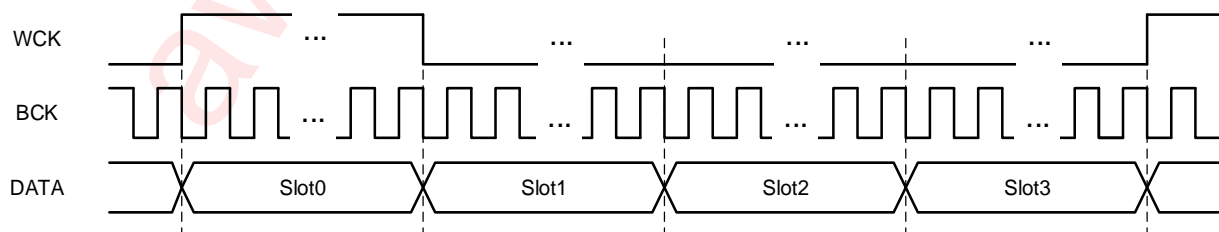
**Figure 12 TDM Timing**

Note: The high level pulse width of WCK signal can be one slot time or one period of BCK.

DIGITAL AUDIO PROCESSING

This device incorporates one programmable Digital Audio Processor (DAP) block. It provides the algorithm for audio signal processing and speaker protection. The following functions are available in this module:

- SKTune
- HDCC
- Hardware AGC
- Volume control
- HMute

The signal processing flow in the DAP is illustrated in the following figure.

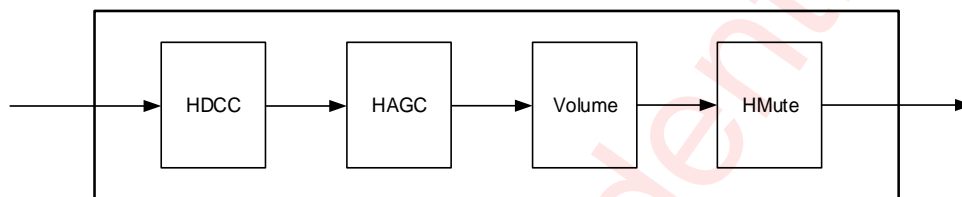

Figure 13 Block Diagram of DAP

HDCC

This module performs hardware DC canceling for the input audio stream. It blocks DC components into analog class D loop.

HAGC

System output power tends to be more than rated power of speaker in the actual audio application, such as the maximum undistorted power is about 5.3W in the 10.25V power supply for 8ohm speaker. However, many speakers' rated power is about 1W, the overload signal can cause damage to the speaker if there is no output power control. The audio power amplifier with HAGC can protect the speaker effectively. When the output power doesn't exceed the setting threshold, the HAGC module will not attenuate the internal gain. Once the output power exceeds the setting threshold, the HAGC module will reduce the internal gain of amplifier and restrict the output power under the setting threshold.

VOLUME CONTROL

The volume controller attenuates the audio signal at the end of digital audio processing. The range of volume setting is from 0dB to -95.875dB with 0.125dB/step.

MUTE

This module performs mute control for the audio stream.

SKTUNE ALGORITHM

This device integrates SKTune algorithm that maximizes the speaker performance while maintaining safe

speaker conditions. The following functions are available in this module.

- Parametric Audio Path Equalizer (EQ)
- Multi-Band Dynamic Range Compressor (MBDRC)
- Anti-clip Voltage Limiter
- Speaker Protection

The signal processing flow in the SKTune algorithm is illustrated in the following figure:

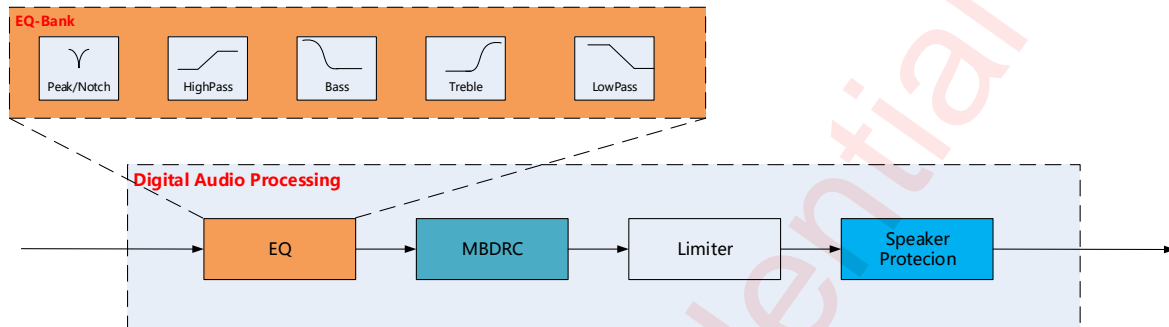

Figure 14 Block Diagram of SKTune algorithm

PARAMETRIC AUDIO PATH EQUALIZER

Ten Parametric Audio Path Equalizers (EQ) are available and each of the equalizer can be fully programmable. It's possible to be implemented as any type of filter (high-pass, low-pass, peak, notch, bass, treble etc.) with different design methodologies to achieve the required frequency response.

MULTI-BAND DYNAMIC RANGE CONTROL

A highly configurable and scalable MBDRC is available to improve audio performance. A block diagram of the MBDRC is illustrated in the following figure:

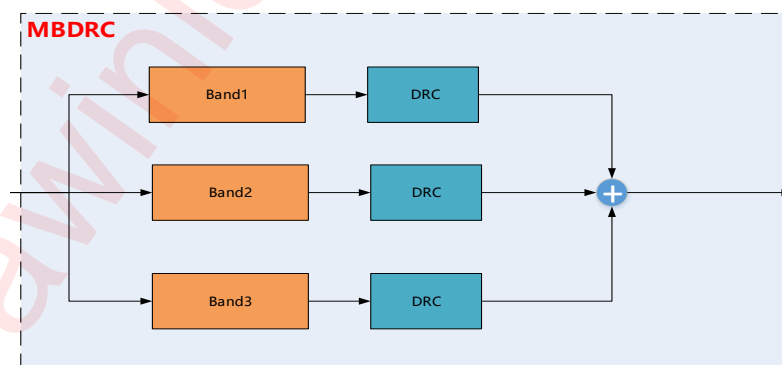

Figure 15 Simplified MBDRC block diagram

Three sub-band DRCs are supported. The audio input can be processed with individually configurable band-limited DRCs.

ANTI-CLIP VOLTAGE LIMITER

The anti-clip voltage limiter is used to protect the output signal from exceeding the amplifier clip level. When signal is over the amplifier clip level it will be attenuated automatically and limited below the threshold without clipping.

SPEAKER PROTECTION

This device has integrated three protection schemes for the speaker.

- **Membrane excursion control:** avoiding speaker membrane over-excursion
- **Programmable Power Control:** avoiding speaker voice coil over-power
- **Coil temperature control:** avoiding speaker voice coil over-temperature

Membrane excursion control

The speaker membrane excursion is proportional to the amplitude of input signal. This device controls the membrane excursion by control the signal amplitude. It predicted the speaker membrane excursion according to the input signal at first. Then it'll attenuate the amplitude of the input signal automatically once the predicted excursion over the threshold.

Programmable Power Control

The power controller limits the maximum output power in amplifier mode when necessary. The power of output signal will be attenuated and limited below the programmable threshold in given attack time when the amplitude of input signal is above the threshold. While the attenuation will be released in given release time when the amplitude of input signal is below the threshold

Coil temperature control

Speaker voice coil temperature is proportional to its impedance in general. This device continuously monitors the impedance of speaker voice coil with integrated ADCs, and the coil temperature could be calculated according to its impedance. When the coil temperature is near the threshold, it controls the amplitude of signal sending to speaker.

DC-DC CONVERTER

This device using smart boost converter generates the amplifier supply rail. The DC-DC converter can work in different mode via BSTCTRL2.BST_MODE:

- **Pass-through mode:** the voltage of VDD is transparently passed to output of converter PVDD
- **Force boost mode:** the output voltage is boosted up to the programmed output voltage
- **Smart boost 1 mode:** the output voltage can be switch between VDD and programmed output voltage according to the amplifier output's signal swing requirements.
- **Smart boost 2 mode:** the output voltage can be dynamically adjusted according to the amplifier output's signal swing requirements in order to maximize efficiency.

PASS-THROUGH MODE

The internal boost circuit is not working; the voltage of VDD is passed to PVDD directly.

FORCE BOOST MODE

The boost circuit is always working and converts the voltage of VDD to the programmed output voltage. The output voltage is configured via BSTCTRL2.BST_VOUT_SET

SMART BOOST 1 MODE

Smart boost 1 mode can dynamically turn on or off the boost according to the amplifier output's signal swing requirements in order to maximize efficiency.

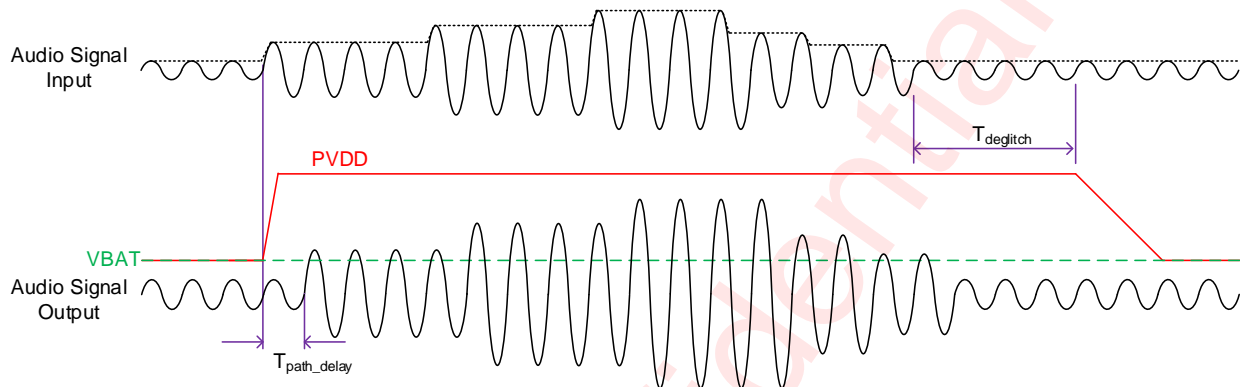

Figure 16 Boost Circuit Behavior in Smart Boost 1 Mode

SMART BOOST 2 MODE

The boost circuit works dynamically according to the output audio level. When the level of output audio signal is below the setting threshold, the boost circuit will not be activated. Till the level of output audio signal is above the threshold, the boost circuit starts to work before the audio stream arriving at amplifier power stage. The output voltage PVDD is dynamically adjusted to meet the requirement of output audio signal.

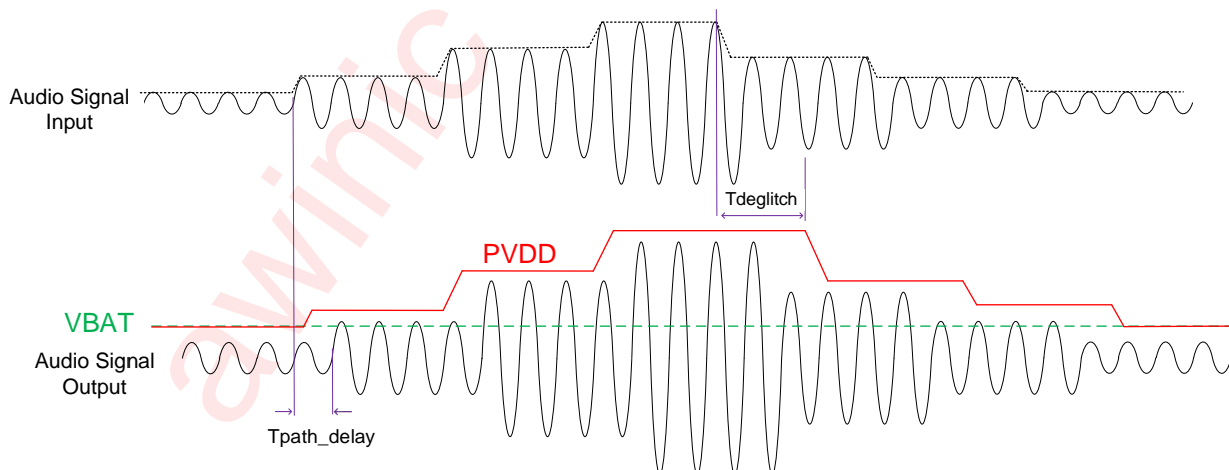

Figure 17 Boost Circuit Behavior in Smart Boost 2 Mode

PROTECTION MECHANISMS

Over Voltage Protection (OVP)

The boost circuit has integrated the over voltage protection control loop. When the output voltage PVDD is above the threshold, the boost circuits will stop working, until the voltage of PVDD going down and under the normal fixed working voltage.

Over Temperature Protection (OTP)

The device has automatic temperature protection mechanism which prevents heat damage to the chip. It is triggered when the junction temperature is larger than the preset temperature high threshold (default = 150°C). When it happens, the output stages will be disabled. When the junction temperature drops below the preset temperature low threshold (less than 130°C), the output stages will start to operate normally again

Over Current (Short) Protection (OCP)

The short circuit protection function is triggered when VOP/VON is short to PVDD/GND or VOP is short to VON, the output stages will be shut down to prevent damage to itself. When the fault condition is disappeared, the output stages of device will restart.

Under Voltage Detection (UVL)

The interrupt bit SYSINT.UVLI will be set to 1 when under voltage occurs, which will be cleared by a read operation of SYSINT register. Usually the SYSINT.UVLI bit can be used to check whether an unexpected under-voltage event has taken place or not.

BATTERY VOLTAGE MONITORING

The device monitors the voltage on the VDD pin, which is most commonly the battery for the system. The battery voltage level is available via bits VBAT_DET in the Battery Supply Voltage register VBAT. Status bits VBAT_DET can be used to calculate the battery voltage. The battery voltage level V_{BAT} is:

$$V_{BAT} = \frac{VBAT_DET}{2^{10} - 1} \times 6.025V$$

For example, if VBAT_DET = 1001100011, the battery voltage level V_{BAT} is equal to 3.6V.

DIE TEMPERATURE MONITORING

The device monitors the die temperature and the result is available via bits TEMP_DET in the Temperature register TEMP. The TEMP_DET is a two's complement value. For example, if TEMP_DET = 00011001, the die temperature is 25°C.

CURRENT SENSING

The device provides speaker current sense for real time monitoring of loudspeaker behavior. Current sensing is not disturbed by capacitance (<1nF) on the output lines or on the long speaker tracks. The current sensing transfer function I_{SNS} is:

$$I_{SNS} = \frac{D_{OUT}}{2^{15} - 1} \times 3.667A$$

D_{OUT} : the current sense I²S output stream

VOLTAGE SENSING

In the device, the speaker voltage sensing is done either internally before signal is being output to speaker or

externally at speaker pads. This function is for real time monitoring of loudspeaker behavior. The voltage sensing transfer function V_{SNS} is:

$$V_{SNS} = \frac{D_{OUT}}{2^{15} - 1} \times V_{fs}$$

The V_{fs} of internally and externally voltage sensor is 11.79V and 16.5V respectively.

AMPLIFIER TRANSFER FUNCTION

The transfer function from the input to the amplifier PWM output (when no gain and attenuation is applied in digital signal domain) is:

$$V_o = AMP_NORM_V \times D_{in}$$

D_{in} : the level of input signal with a range from -1 to +1.

AMP_NORM_V: the equivalent amplifier output voltage when D_{in} is 1. In receiver mode the AMP_NORM_V is 4.5V, in speaker mode it's 12V.

RECEIVER MODE

The device built-in Receiver mode is easy to realize the Speaker and Receiver combo applications, it saves the system cost and board space. If the receiver magnification is one times, the noise floor will be 14uV. Speaker and Receiver combo applications can be realized without changing any hardware.

When the device is set to receiver mode, the power supply of Class D driver stage is from VDD directly without boost.

I²C INTERFACE

This device supports the I²C serial bus and data transmission protocol in fast mode at 400 kHz. This device operates as a slave on the I²C bus. Connections to the bus are made via the open-drain I/O pins SCL and SDA. The pull-up resistor can be selected in the range of 1k~10kΩ and the typical value is 4.7kΩ. This device can support different high level (1.8V~3.3V) of this I²C interface.

DEVICE ADDRESS

The I²C device address (7-bit) can be set using the AD pin according to the following table: The AD1, AD2 pin configures the two LSB bits of the following 7-bit binary address A6-A0 of 01101xx. The permitted I²C addresses are 0x34(7-bit) through 0x37(7-bit).

Table 4 Address Selection

| AD2 | AD1 | Address(7-bit) |
|------|------|----------------|
| GND | GND | 0x34 |
| GND | DVDD | 0x35 |
| DVDD | GND | 0x36 |
| DVDD | DVDD | 0x37 |

DATA VALIDATION

When SCL is high level, SDA level must be constant. SDA can be changed only when SCL is low level.

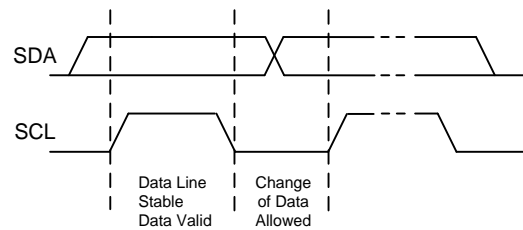

Figure 18 Data Validation Diagram

I²C START/STOP

I²C start: SDA changes from high level to low level when SCL is high level.

I²C stop: SDA changes from low level to high level when SCL is high level.

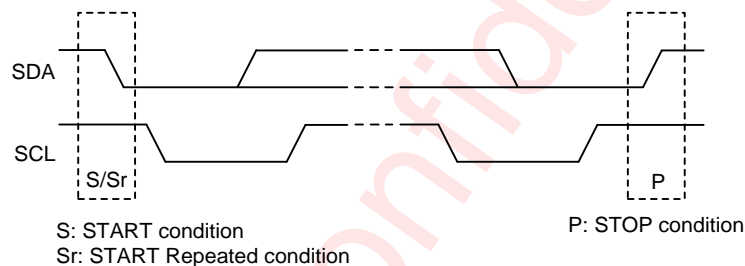

Figure 19 I²C Start/Stop Condition Timing

ACK (ACKNOWLEDGEMENT)

ACK means the successful transfer of I²C bus data. After master sends 8bits data, SDA must be released; SDA is pulled to GND by slave device when slave acknowledges.

When master reads, slave device sends 8bit data, releases the SDA and waits for ACK from master. If ACK is send and I²C stop is not send by master, slave device sends the next data. If ACK is not send by master, slave device stops to send data and waits for I²C stop.

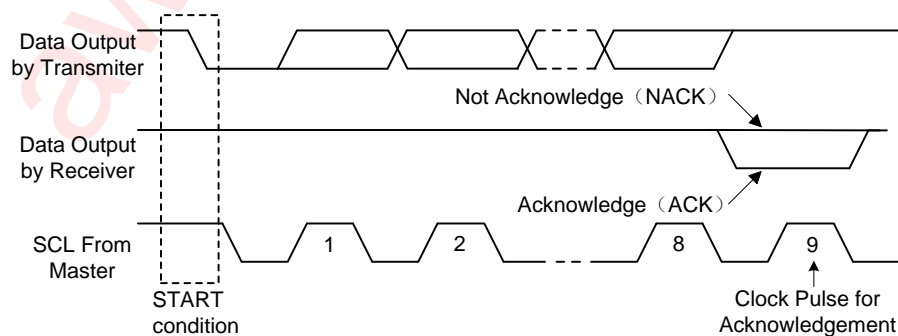

Figure 20 I²C ACK Timing

WRITE CYCLE

One data bit is transferred during each clock pulse. Data is sampled during the high state of the serial clock (SCL). Consequently, throughout the clock's high period, the data should remain stable. Any changes on the SDA line during the high state of the SCL and in the middle of a transaction, aborts the current transaction. New data should be sent during the low SCL state. This protocol allows a single data line to transfer both command/control information and data using the synchronous serial clock.

Each data transaction is composed of a Start Condition, a number of byte transfers (set by the software) and a Stop Condition to terminate the transaction. Every byte written to the SDA bus must be 8 bits long and is transferred with the most significant bit first. After each byte, an Acknowledge signal must follow.

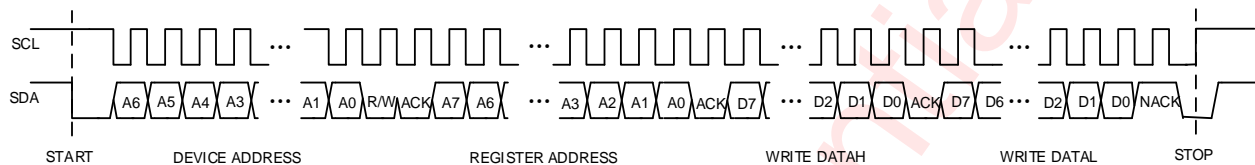

Figure 21 I²C Write Byte Cycle

In a write process, the following steps should be followed:

- Master device generates START condition. The “START” signal is generated by lowering the SDA signal while the SCL signal is high.
- Master device sends slave address (7-bit) and the data direction bit ($r/w = 0$).
- Slave device sends acknowledge signal if the slave address is correct.
- Master sends control register address (8-bit).
- Slave sends acknowledge signal.
- Master sends high data byte of 16-bit data to be written to the addressed register.
- Slave sends acknowledge signal.
- Master sends low data byte of 16-bit data to be written to the addressed register.
- Slave sends acknowledge signal.
- If master will send further 16-bit data bytes the control register address will be incremented by one after acknowledge signal of step g (repeat step f to g).
- Master generates STOP condition to indicate write cycle end.

READ CYCLE

In a read cycle, the following steps should be followed:

- Master device generates START condition.
- Master device sends slave address (7-bit) and the data direction bit ($r/w = 0$).
- Slave device sends acknowledge signal if the slave address is correct.
- Master sends control register address (8-bit).
- Slave sends acknowledge signal.

- f) Master generates STOP condition followed with START condition or REPEAT START condition.
- g) Master device sends slave address (7-bit) and the data direction bit ($r/w = 1$).
- h) Slave device sends acknowledge signal if the slave address is correct.
- i) Slave sends read high data byte of 16-bit data from addressed register.
- j) Master sends acknowledge signal.
- k) Slave sends read low data byte of 16-bit data from addressed register.
- l) If the master device sends acknowledge signal, the slave device will increase the control register address by one, then send the next 16-bit data from the new addressed register.
- m) If the master device generates STOP condition, the read cycle is ended.

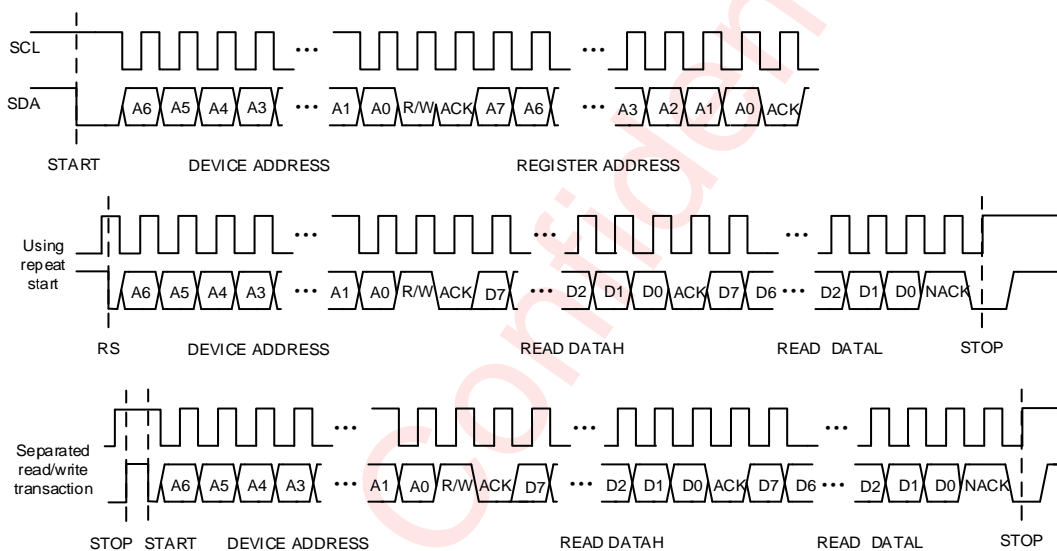

Figure 22 I²C Read Byte Cycle

REGISTER MAP

REGISTER DESCRIPTION

REGISTER LIST

| ADDR | NAME | R/W | Bit15 | Bit14 | Bit13 | Bit12 | Bit11 | Bit10 | Bit9 | Bit8 | Bit7 | Bit6 | Bit5 | Bit4 | Bit3 | Bit2 | Bit1 | Bit0 | Default | |
|------|----------|-----|-----------------|-------|----------|--------|-----------------|-------|-------|------------|----------------|---------|----------|--------|------------|-----------|---------|---------|---------|--------|
| 0x00 | ID | RO | IDCODE | | | | | | | | | | | | | | | | 0x2049 | |
| 0x01 | SYSST | RO | | UVLS | ADPS | | BSTOCS | OVPS | BSTS | SWS | CLIPS | WDS | NOCLKS | CLKS | OCDS | CLIP_PRE | OTHS | PLLS | 0x0000 | |
| 0x02 | SYSINT | RC | | UVLI | ADPI | | BSTOCI | OVPI | BSTI | SWI | CLIP | WDI | NOCLKI | CLKI | OCDI | CLIP_PREI | OTHI | PLLI | 0x0000 | |
| 0x03 | SYSINTM | RW | | UVLM | ADPM | | BSTOCM | OVPM | BSTM | SWM | CLIPM | WDM | NOCLKM | CLKM | OCDM | CLIP_PREM | OTHM | PLLM | 0xFFFF | |
| 0x04 | SYSCTRL | RW | | | | | RMSE | HAGCE | HDCCE | HMUTE | RCV_MODE | I2SEN | WSINV | BCKINV | IPLL | DSPBY | AMPPD | PWDN | 0x5307 | |
| 0x05 | SYSCTRL2 | RW | VOL | | | | | | | | | INTMODE | INTN | | | | | | | 0x0009 |
| 0x06 | I2SCTRL | RW | SLOT_NUM | | | | CHSEL | | I2SMD | | I2SFS | | I2SBCK | | I2SSR | | | | 0x04E8 | |
| 0x07 | I2SCFG1 | RW | I2S_RXL_SLOTVLD | | | | I2S_RXR_SLOTVLD | | | | I2S_TX_SLOTVLD | | | | FSYNC_TYPE | I2SCHS | I2SRXEN | I2STXEN | 0x0102 | |
| 0x08 | I2SCFG2 | RW | | | ULS_MODE | ULS_EN | | | IV2CH | I2S_TXEDGE | I2SDOSEL | DOHZ | DRVSTREN | INPLEV | CFSEL | | | | 0x0060 | |
| 0x09 | HAGCCFG1 | RW | RVTH | | | | | | | | AVTH | | | | | | | | 0x3940 | |
| 0x0a | HAGCCFG2 | RW | ATTH | | | | | | | | | | | | | | | | 0x0030 | |
| 0x0b | HAGCCFG3 | RW | RTTH | | | | | | | | | | | | | | | | 0x01E0 | |
| 0x0c | HAGCCFG4 | RW | HOLDTH | | | | | | | | | | | | | | | | 0x1C64 | |
| 0x21 | VBAT | RO | VBAT_DET | | | | | | | | | | | | | | | | 0x0263 | |
| 0x22 | TEMP | RO | TEMP_DET | | | | | | | | | | | | | | | | 0x0019 | |
| 0x23 | PVDD | RO | PVDD_DET | | | | | | | | | | | | | | | | 0x0263 | |
| 0x60 | BSTCTRL1 | RW | BST_RTH | | | | | | | | BST_ATH | | | | | | | | 0x0402 | |
| 0x61 | BSTCTRL2 | RW | BST_MODE | | | | BST_TDEG | | | | BST_VOUT_SET | | | | | | | | 0x6B33 | |

DETAILED REGISTER DESCRIPTION

| ID: (Address 00h) | | | | |
|-------------------|--------|-----|--|---------|
| Bit | Symbol | R/W | Description | Default |
| 15:0 | IDCODE | RO | Chip ID (2049h) will be returned after read. All configuration registers will be reset to default value after 0x55aa is written | 0x2049 |

| SYSST: (Address 01h) | | | | |
|----------------------|-----------|-----|---|---------|
| Bit | Symbol | R/W | Description | Default |
| 15 | Reserved | RO | Not used | 0 |
| 14 | UVLS | RO | VDD under voltage indicator 0: Normal 1: UVLO | 0 |
| 13 | ADPS | RO | Boost Adaptive status. 0: Transparent 1: Boost | 0 |
| 12 | Reserved | RO | Not used | 0 |
| 11 | BSTOCS | RO | Boost over current indicator 0: Normal 1: Over Current | 0 |
| 10 | OVPS | RO | Boost OVP status indicator 0: Normal 1: OVP | 0 |
| 9 | BSTS | RO | Boost start up finished. 0: Not finished 1: Finished | 0 |
| 8 | SWS | RO | Amplifier switching status. 0: Not switching 1: Switching | 0 |
| 7 | CLIPS | RO | Amplifier clipping status. 0: Not clipping 1: Clipping | 0 |
| 6 | WDS | RO | DAP watch-dog status 0: Normal 1: Abnormal | 0 |
| 5 | NOCLKS | RO | The reference clock of PLL is not available 0: Clock Ok 1: No Clock | 0 |
| 4 | CLKS | RO | Internal clocks' status flag 0: More than one clocks are not stable 1: Stable | 0 |
| 3 | OCDS | RO | Over current status in amplifier 0: Normal 1: OC | 0 |
| 2 | CLIP_PRES | RO | Amplifier almost clipping status. 0: Not clipping 1: Clipping | 0 |

| | | | | |
|---|------|----|---|---|
| 1 | OTHS | RO | Die Temperature is higher than 150degrees 0: Normal 1: OT | 0 |
| 0 | PLLS | RO | PLL locked status. 0: Unlocked 1: Locked | 0 |

| SYSINT: (Address 02h) | | | | |
|-----------------------|-----------|-----|---|---------|
| Bit | Symbol | R/W | Description | Default |
| 15 | Reserved | RC | Not used | 0 |
| 14 | UVLI | RC | Interrupt indicator for Power On and UVLS | 0 |
| 13 | ADPI | RC | Interrupt indicator for ADPS | 0 |
| 12 | Reserved | RC | Not used | 0 |
| 11 | BSTOCI | RC | Interrupt indicator for BSTOCS. | 0 |
| 10 | OVPI | RC | Interrupt indicator for OVPS. | 0 |
| 9 | BSTI | RC | Interrupt indicator for BSTS. | 0 |
| 8 | SWI | RC | Interrupt indicator for SWS. | 0 |
| 7 | CLIP_I | RC | Interrupt indicator for CLIPS. | 0 |
| 6 | WDI | RC | Interrupt indicator for WDS | 0 |
| 5 | NOCLKI | RC | Interrupt indicator for NOCLKS. | 0 |
| 4 | CLKI | RC | Interrupt indicator for CLKS. | 0 |
| 3 | OCDI | RC | Interrupt indicator for OCDS | 0 |
| 2 | CLIP_PREI | RC | Interrupt indicator for CLIP_PRES | 0 |
| 1 | OTHI | RC | Interrupt indicator for OTHS. | 0 |
| 0 | PLLI | RC | Interrupt indicator for PLLS. | 0 |

Note: It will be set to '1' once corresponding status bit changed, and all the interrupt bits will be cleared after reading 0x02 via IIC bus.

| SYSINTM: (Address 03h) | | | | |
|------------------------|-----------|-----|---------------------------------|---------|
| Bit | Symbol | R/W | Description | Default |
| 15 | Reserved | RW | Not used | 1 |
| 14 | UVLM | RW | Interrupt mask for UVLI. | 1 |
| 13 | ADPM | RW | Interrupt mask for ADPI | 1 |
| 12 | Reserved | RW | Not used | 1 |
| 11 | BSTOCM | RW | Interrupt mask for BSTOCI. | 1 |
| 10 | OVPM | RW | Interrupt mask for OVPI | 1 |
| 9 | BSTM | RW | Interrupt mask for BSTI. | 1 |
| 8 | SWM | RW | Interrupt indicator for SWI. | 1 |
| 7 | CLIPM | RW | Interrupt indicator for CLIP_I. | 1 |
| 6 | WDM | RW | Interrupt mask for WDI. | 1 |
| 5 | NOCLKM | RW | Interrupt mask for NOCLKI. | 1 |
| 4 | CLKM | RW | Interrupt mask for CLKI. | 1 |
| 3 | OCDM | RW | Interrupt mask for OCDI. | 1 |
| 2 | CLIP_PREM | RW | Interrupt mask for CLIP_PREI. | 1 |
| 1 | OTHM | RW | Interrupt mask for OTHI. | 1 |
| 0 | PLLM | RW | Interrupt mask for PLLI. | 1 |

Note: All the mask bits are high-active. The interrupt will be masked when its corresponding mask bit is set to "1", then this interrupt will not be sent to INTN pin.

| SYSCTRL: (Address 04h) | | | | |
|------------------------|----------|-----|---|---------|
| Bit | Symbol | R/W | Description | Default |
| 15:12 | Reserved | RW | Not used | 0x5 |
| 11 | RMSE | RW | Hardware HAGC mode selection 0: Peak AGC 1: RMS AGC | 0 |
| 10 | HAGCE | RW | Disable/Enable Hardware AGC 0: Disable 1: Enable | 0 |
| 9 | HDCCE | RW | Disable/Enable Hardware DC Canceling module 0: Disable 1: Enable | 1 |
| 8 | HMUTE | RW | Disable/Enable Hardware mute module 0: Disable 1: Enable | 1 |
| 7 | RCV_MODE | RW | Receiver mode enable, active "1". 0: Speaker 1: Receiver | 0 |
| 6 | I2SEN | RW | Disable/Enable whole I2S interface module 0: Disable 1: Enable | 0 |
| 5 | WSINV | RW | I2S Left/Right channel switch control 0: Not switch 1: Switch | 0 |
| 4 | BCKINV | RW | I2S bit clock invert control 0: Not invert 1: Inverted | 0 |
| 3 | IPLL | RW | PLL reference clock selection 0: BCK 1: WCK | 0 |
| 2 | DSPBY | RW | DSP bypass control bit 0: Working 1: Bypass | 1 |
| 1 | AMPPD | RW | Amplifier power down control bit, Power-Down until system configuration finished 0: Working 1: Power Down | 1 |
| 0 | PWDN | RW | System power down control bit 0: Working 1: Power Down | 1 |

| SYSCTRL2: (Address 05h) | | | | |
|-------------------------|---------|-----|---|---------|
| Bit | Symbol | R/W | Description | Default |
| 15:6 | VOL | RW | Volume control, from 0 to -95.875dB [5:0] : in unit of -0.125dB [9:6] : in unit of -6dB | 0 |
| 5 | INTMODE | RW | Interrupt pad INTN output mode selection 0: Open-drain 1: Push & Pull | 0 |

| | | | | |
|-----|----------|----|--|---|
| 4 | INTN | RW | Interrupt pad INTN pin-source selection 0: SYSINT 1: SYSST | 0 |
| 3:0 | Reserved | RW | Not used | 9 |

| I2SCTRL: (Address 06h) | | | | |
|------------------------|----------|-----|--|---------|
| Bit | Symbol | R/W | Description | Default |
| 15 | Reserved | RW | Not used | 0 |
| 14:12 | SLOT_NUM | RW | I2S interface mode control (Max 8 slots support). 000: I2S mode 001: TDM1s 010: TDM2s 011: TDM4s 100: TDM6s 101: TDM8s Others: Reserved | 0 |
| 11:10 | CHSEL | RW | Left/right channel selection for I2S input 00: Reserved 01: Left 10: Right 11: Mono | 1 |
| 9:8 | I2SMD | RW | I2S data format mode selection 00: Philip Standard 01: MSB justified 10: LSB justified 11: Reserved | 0 |
| 7:6 | I2SFS | RW | I2S data resolution selection 00: 16 bits 01: 20 bits 10: 24 bits 11: 32 bits | 3 |
| 5:4 | I2SBCK | RW | I2S BCK mode selection 00: 32*fs 01: 48*fs 10: 64*fs 11: Reserved | 2 |
| 3:0 | I2SSR | RW | I2S interface sample rate configuration 0000: 8 kHz 0001: 11 kHz 0010: 12 kHz 0011: 16 kHz 0100: 22 kHz 0101: 24 kHz 0110: 32 kHz 0111: 44 kHz 1000: 48 kHz 1001: 96 kHz Others: Reserved | 8 |

| I2SCFG1: (Address 07h) | | | | |
|------------------------|-----------------|-----|--|---------|
| Bit | Symbol | R/W | Description | Default |
| 15:12 | I2S_RXL_SLOTVLD | RW | RX left channel slot selection 0000: Slot 0 0001: Slot 1 0010: Slot 2 0011: Slot 3 0111: Slot 7 Others: Reserved | 0 |
| 11:8 | I2S_RXR_SLOTVLD | RW | RX right channel slot selection 0000: Slot 0 0001: Slot 1 0010: Slot 2 0011: Slot 3 0111: Slot 7 Others: Reserved | 1 |
| 7:4 | I2S_TX_SLOTVLD | RW | TX slot selection, data will be sent to one of the 8 slots. 0000: Slot 0 0001: Slot 1 0010: Slot 2 0011: Slot 3 0111: Slot 7 Others: Reserved | 0 |
| 3 | FSYNC_TYPE | RW | Audio Frame synchronization signal (WCK) pulse width configuration 0: One-slot 1: One-bck | 0 |
| 2 | I2SCHS | RW | I2S Tx Channel selection 0: Left 1: Right | 0 |
| 1 | I2SRXEN | RW | Disable/Enable I2S receiver module 0: Disable 1: Enable | 1 |
| 0 | I2STXEN | RW | Disable/Enable I2S transmitter module 0: Disable 1: Enable | 0 |

| I2SCFG2: (Address 08h) | | | | |
|------------------------|----------|-----|---|---------|
| Bit | Symbol | R/W | Description | Default |
| 15:14 | Reserved | RW | Not used | 0 |
| 13 | ULS_MODE | RW | Ultrasonic mode control bit Ultrasonic signal could be mixed with audio signal in one slot, or be sent into another slot separately. 0: Mixed 1: TDM | 0 |
| 12 | ULS_EN | RW | Ultrasonic mode enable 0: Disable 1: Enable | 0 |
| 11:10 | Reserved | RW | Not used | 0 |

| | | | | |
|-----|------------|----|--|---|
| 9 | IV2CH | RW | I2S TX channel data packing mode control. When I2SBCK is set to 32*fs mode, Current & Voltage data could be separately transmitted to I2S Left & Right channels by using Special mode. 0: Legacy 1: Special | 0 |
| 8 | I2S_TXEDGE | RW | I2S TX clock edge selection 0: Negedge 1: Posedge | 0 |
| 7 | I2SDOSEL | RW | I2S unused channel data selection 0: Zeros 1: TXData | 0 |
| 6 | DOHZ | RW | Unused channel control When it is set to 0, all channels are available. Otherwise unused channel is set to be HiZ. 0: All 1: HiZ | 1 |
| 5 | DRVSTREN | RW | I2S_DATAO PAD driving strength setting 0: 4mA 1: 12mA | 1 |
| 4 | INPLEV | RW | Input level selection bit I2S input signal will be attenuated by -6dB at first when this register is set to 1. 0: Not attenuated 1: Attenuated | 0 |
| 3 | Reserved | RW | Not used | 0 |
| 2:0 | CFSEL | RW | I2S legacy path output data selection 000: HAGC 001: DFIFO 010: Ultrasonic data 011: IV 100: IVBT | 0 |

| HAGCCFG1: (Address 09h) | | | | |
|-------------------------|--------|-----|---|---------|
| Bit | Symbol | R/W | Description | Default |
| 15:8 | RVTH | RW | Release Amplitude threshold, in percent of signal full scale | 0x39 |
| 7:0 | AVTH | RW | Attack Amplitude threshold, in percent of signal full scale RMSE = 0 (Peak AGC) : $P0 = ((i/256 * Gain)^2) / R_{Load} / 2$ RMSE = 1 (RMS AGC) : $P0 = (i/256) * (Gain^2) / R_{Load}$ i is the register value, default 0x40 Gain is the Speaker Gain, default 12 R_{Load} is 8ohm/6ohm for different application, default 8 ohm | 0x40 |

| HAGCCFG2: (Address 0ah) | | | | |
|-------------------------|--------|-----|---|---------|
| Bit | Symbol | R/W | Description | Default |
| 15:0 | ATTH | RW | Attack time threshold in unit of 20.8μs 0: Reserved n: n*20.8us | 0x0030 |

| HAGCCFG3: (Address 0bh) | | | | |
|-------------------------|--------|-----|--|---------|
| Bit | Symbol | R/W | Description | Default |
| 15:0 | RTTH | RW | Release time threshold in unit of 20.8μs 0: Reserved n: n*20.8μs | 0x01E0 |

| VBAT: (Address 21h) | | | | |
|---------------------|----------|-----|---|---------|
| Bit | Symbol | R/W | Description | Default |
| 15:10 | Reserved | RO | Not used | 0 |
| 9:0 | VBAT_DET | RO | Detected Voltage of battery, and the full scale is 6.025V $VBAT=(VBAT_DET)/1023 \times 6.025$ | 0x263 |

| TEMP: (Address 22h) | | | | |
|---------------------|----------|-----|---|---------|
| Bit | Symbol | R/W | Description | Default |
| 15:10 | Reserved | RO | Not used | 0 |
| 9:0 | TEMP_DET | RO | Detected Die Temperature (Two's Complement), typical values are as follows. 0x3D8 : -40 degree 0x00 : 0 degree 0x01 : 1 degree 0x19 : 25 degree 0x37 : 55 degree | 0x019 |

| PVDD: (Address 23h) | | | | |
|---------------------|----------|-----|--|---------|
| Bit | Symbol | R/W | Description | Default |
| 15:10 | Reserved | RO | Not used | 0 |
| 9:0 | PVDD_DET | RO | Detected Voltage of PVDD, and the full scale is 12.05V $PVDD=(PVDD_DET)/1023 \times 12.05$ | 0x263 |

| BSTCTRL1: (Address 60h) | | | | |
|-------------------------|----------|-----|--|---------|
| Bit | Symbol | R/W | Description | Default |
| 15:14 | Reserved | RW | Not used | 0 |
| 13:8 | BST_RTH | RW | Smart boost small signal mode release threshold setting. When the input signal is above the threshold, the voltage of PVDD will be raised up and higher than VDD in smart boost mode Threshold = BST_RTH * 1/64 FS | 4 |
| 7:6 | Reserved | RW | Not used | 0 |
| 5:0 | BST_ATH | RW | Smart boost small signal mode attack threshold setting, When the input signal is below the threshold, the VDD is directly output to PVDD in smart boost mode Threshold = BST_ATH * 1/64 FS | 2 |

| BSTCTRL2: (Address 61h) | | | | |
|-------------------------|----------|-----|--|---------|
| Bit | Symbol | R/W | Description | Default |
| 15 | Reserved | RW | Not used | 0 |
| 14:12 | BST_MODE | RW | BOOST mode selection 000: Transparent 001: Force Boost 101: Smart Boost 1 110: Smart Boost 2 Others: Reserved | 0x6 |

| | | | | |
|------|--------------|----|--|------|
| 11:8 | BST_TDEG | RW | Smart Boost small signal level detection deglitch time 0000: 0.50 ms 0001: 1.00 ms 0010: 2.00 ms 0011: 4.00 ms 0100: 8.00 ms 0101: 10.7 ms 0110: 13.3 ms 0111: 16.0 ms 1000: 18.6 ms 1001: 21.3 ms 1010: 24.0 ms 1011: 32.0 ms 1100: 64.0 ms 1101: 128 ms 1110: 256 ms 1111: 1200 ms | 11 |
| 7:6 | Reserved | RW | Not used | 0 |
| 5:0 | BST_VOUT_SET | RW | BOOST max output voltage control bits (125mV/Step) 000000: 3.125V 000001: 3.250V 000010: 3.375V 000011: 3.500V 000100: 3.625V 000101: 3.750V 111001: 10.250V Others: Reserved | 0x33 |

APPLICATION INFORMATION

EXTERNAL COMPONENTS

BOOST INDUCTOR SELECTION

Inductance value is limited by the boost converter's internal loop compensation, a large L_{SW} will reduce the phase margin of the DC-to-DC converter. Also, the inductor should have low core loss at 1MHz (Min.) and low DCR for better efficiency under all operating conditions, the recommended value of inductor is 1 μ H.

Inductor saturation current and temperature rise current value are important basis for selecting the inductor. As the inductor current increases, inductance value will decline since the magnetic core begins to saturate; on the other hand, the inductor's parasitic resistance inductance and magnetic core loss can lead to temperature rise. The inductor saturation current rating could to be considered with the following equation:

$$I_{L_PEAK} = \frac{2 * P_{OUT}}{\eta * VDD} + \frac{VDD * (PVDD - VDD)}{2 * L_{SW} * F_{BST} * PVDD}$$

Following is the inductor selection reference for typical speaker impedances.

| V _{DD} (V) | PVDD (V) | R _L (Ω) | Efficiency (%) | P _{OUT} (W) | I _{L_PEAK} (A) | I _{SAT_min} (A) |
|------------------------|-------------|--------------------------------|-------------------|-------------------------|-----------------------------|------------------------------|
| 4.2 | 10 | 8 | 76 | 5.3 | 4.08 | 4.5 |
| 4.2 | 10 | 6 | 74 | 5.4 | 4.23 | 4.5 |

BOOST CAPACITOR SELECTION

Boost output capacitor is usually within the range 0.1 μ F~47 μ F. The ceramic capacitors with low ESR are recommended for low ripple voltage which is determined as following equation:

$$\Delta PVDD = \frac{(PVDD - VDD) * I_{OUT}}{\eta * PVDD * F_{BST} * C_{OUT}} + \left(\frac{I_{OUT} * PVDD}{VDD} + \frac{VDD * (PVDD - VDD)}{2 * L_{SW} * F_{BST} * PVDD} \right) * R_{C_ESR}$$

Capacitor is selected based on the requirements of temperature stability and voltage stability, considering the material, size, capacitor voltage, and capacitance values. It is suggested to use Class II type (EIA) multilayer ceramic capacitors (MLCC). Its internal dielectric is ferroelectric material (typically BaTiO₃), a high the dielectric constant in order to achieve smaller size, but at the same Class II type (EIA) multilayer ceramic capacitors has poor temperature stability and voltage stability as compared to the Class I type (EIA) capacitance.

Please notice the DC bias characteristics when selecting capacitors. For typical applications, it is necessary to ensure that the residual capacitance is higher than **3.6 μ F**. Take the following capacitances as the output capacitor of boost for example:

| Value | Material | Size (mm ³) | Rated Voltage | Quantity | Value@10.25V |
|------------|----------|-------------------------|---------------|----------|--------------|
| 10 μ F | X5R | 1.00x0.50x0.50 (0603) | 25V | 2 | 3.8 μ F |
| 22 μ F | X5R | 2.00x0.80x0.85 (0805) | 25V | 1 | 4.2 μ F |

SUPPLY DECOUPLING CAPACITOR

The device is a high-performance audio amplifier that requires adequate power supply decoupling. A $1\mu\text{F}$ low equivalent-series-resistance (ESR) ceramic capacitor is recommended. This choice of capacitor and placement helps with higher frequency transients, spikes, or digital hash on the line. Additionally, placing this decoupling capacitor close to the device is important, as any parasitic resistance or inductance between the device and the capacitor causes efficiency loss. In addition to the $1\mu\text{F}$ ceramic capacitor, place a $10\mu\text{F}$ capacitor on the VBAT supply trace. This larger capacitor acts as a charge reservoir, providing energy faster than the board supply, thus helping to prevent any drop in the supply voltage.

FILTER FREE OPERATION AND FERRITE BEAD FILTERS

If the PA is close to the EMI sensitive circuits and/or there are long leads from amplifier to speaker, a ferrite bead filter could be used, and placed as close as possible to the output pins of the PA. When choosing a ferrite bead, select a ferrite bead with adequate current rating to prevent distortion of the output signal. In addition, a 0.1nF ceramic capacitor is typically recommended, and its rated voltage should be above 25V.

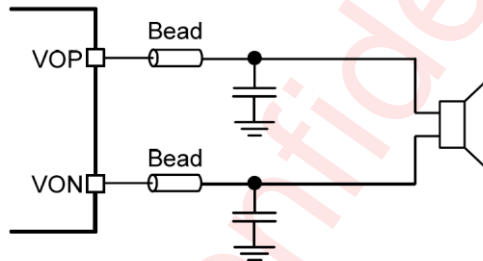

LAYOUT CONSIDERATION

In order to obtain excellent performance of the PA, the below PCB layout guidelines should be followed:

1. All the filter capacitors should be placed close to the corresponding pins of the PA, including VBST, VDD, DVDD.
2. The traces of SW pin should support currents up to the device over-current limit (peak current 4A), and the input line from the battery to the SW pin should be traced above 4A current drive.
3. For the case of speaker impedance equal to 8ohm, try to provide a separate, short and thick power line to the PA, the copper width is recommended to be larger than 4mm.
4. The beads and capacitor should be placed close to the VON and VOP pin. The output line from PA to speaker should be as short and thick as possible. The width is recommended to be larger than 1.2mm.
5. The via numbers determine the current capability. Typically, the boost converter trace need four via to handle the current requirement around 4A.

PACKAGE DESCRIPTION

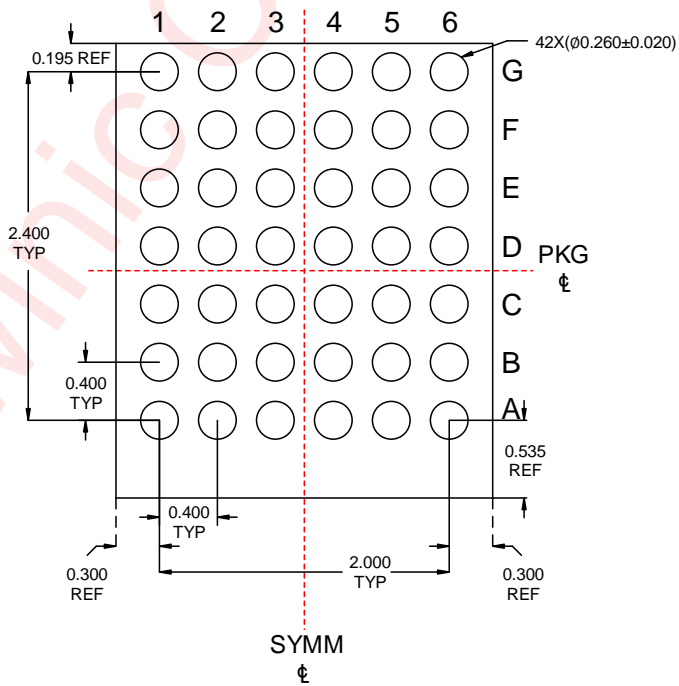
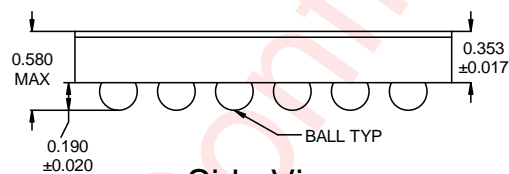
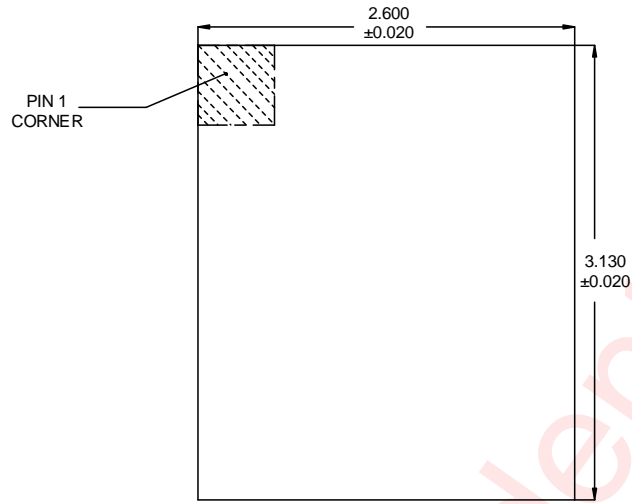

Unit: mm

LAND PATTERN DATA

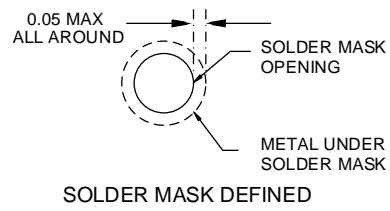
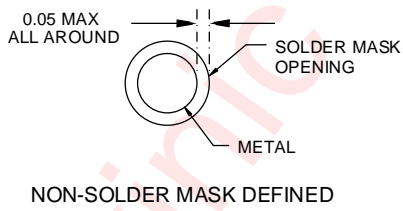
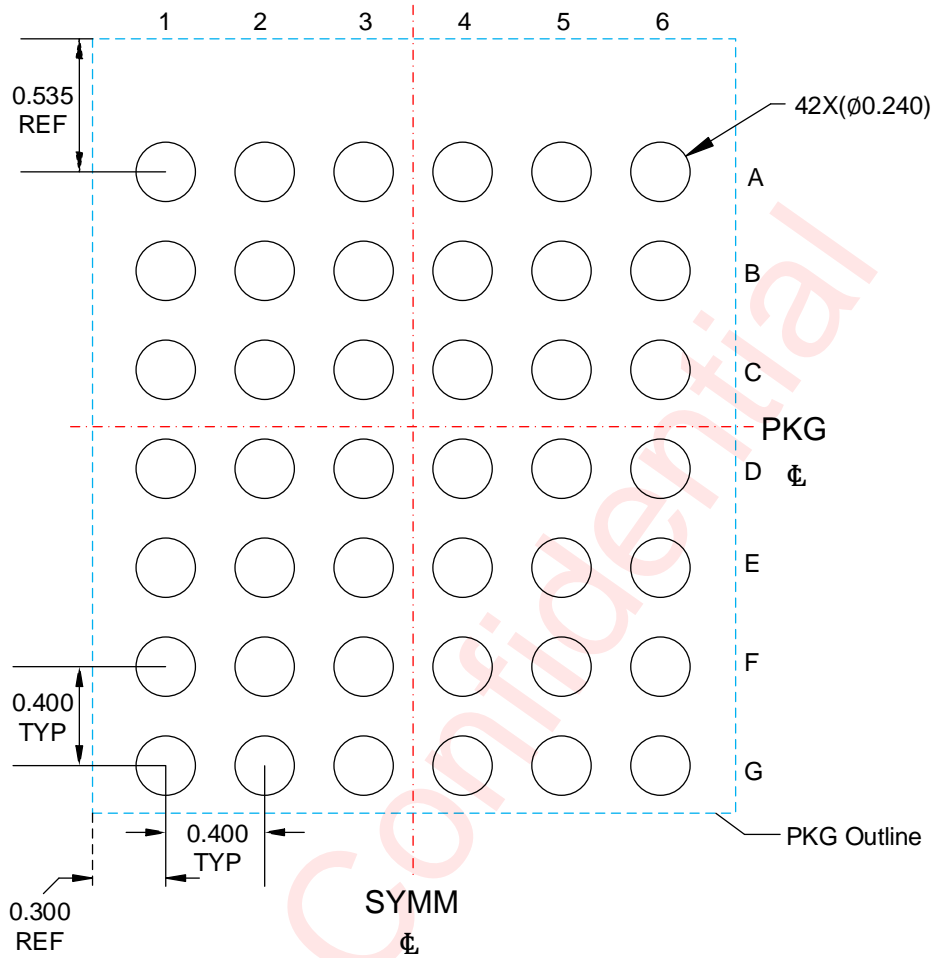

UNIT: mm

TAPE AND REEL INFORMATION

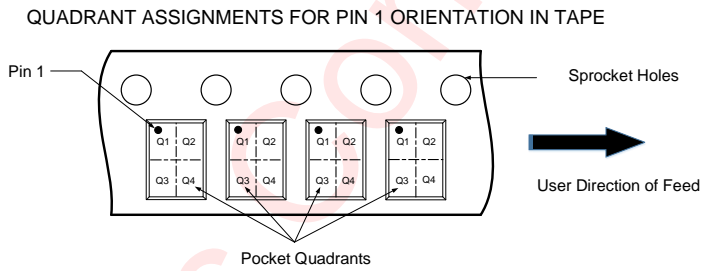
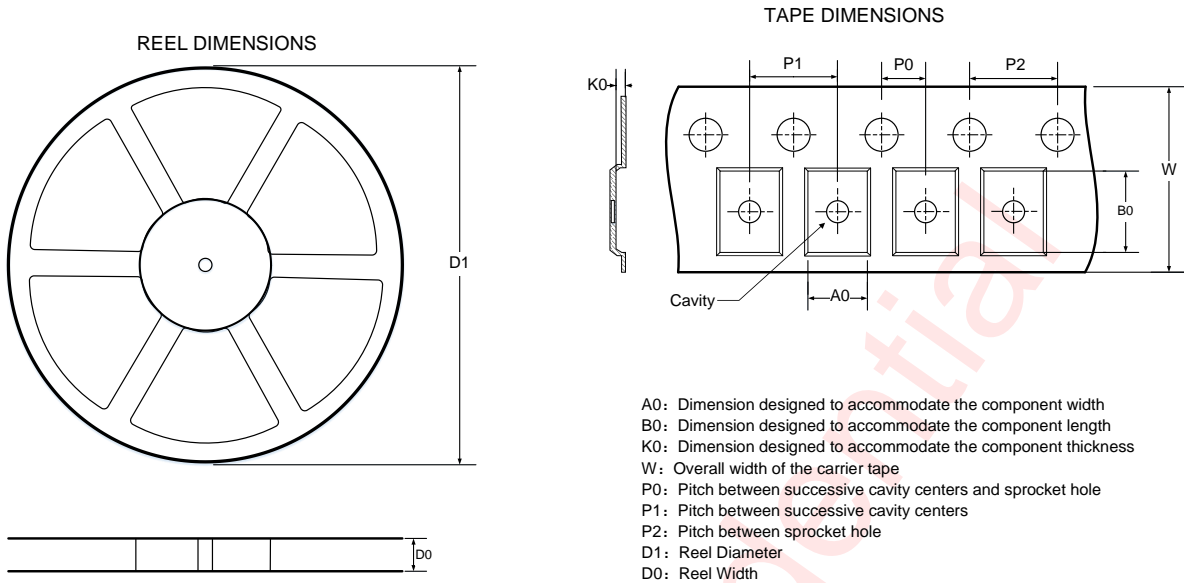

All Dimensions are nominal

| D1 (mm) | D0 (mm) | A0 (mm) | B0 (mm) | K0 (mm) | P0 (mm) | P1 (mm) | P2 (mm) | W (mm) | Pin1 Quadrant |
|---------|---------|---------|---------|---------|---------|---------|---------|--------|---------------|
| 330.00 | 12.40 | 2.77 | 3.30 | 0.73 | 2.00 | 8.00 | 4.00 | 12.00 | Q1 |

REVISION HISTORY

| Version | Date | Change Record |
|---------|-----------|--------------------------------------|
| V1.0 | Sep. 2020 | Officially Released |
| V1.1 | May. 2021 | Update typical characteristic curves |
| | | |

awinic Confidential

DISCLAIMER

Information in this document is believed to be accurate and reliable. However, Shanghai AWINIC Technology Co., Ltd (AWINIC Technology) does not give any representations or warranties, expressed or implied, as to the accuracy or completeness of such information and shall have no liability for the consequences of use of such information.

AWINIC Technology reserves the right to make changes to information published in this document, including without limitation specifications and product descriptions, at any time and without notice. Customers shall obtain the latest relevant information before placing orders and shall verify that such information is current and complete. This document supersedes and replaces all information supplied prior to the publication hereof.

AWINIC Technology products are not designed, authorized or warranted to be suitable for use in medical, military, aircraft, space or life support equipment, nor in applications where failure or malfunction of an AWINIC Technology product can reasonably be expected to result in personal injury, death or severe property or environmental damage. AWINIC Technology accepts no liability for inclusion and/or use of AWINIC Technology products in such equipment or applications and therefore such inclusion and/or use is at the customer's own risk.

Applications that are described herein for any of these products are for illustrative purposes only. AWINIC Technology makes no representation or warranty that such applications will be suitable for the specified use without further testing or modification.

All products are sold subject to the general terms and conditions of commercial sale supplied at the time of order acknowledgement.

Nothing in this document may be interpreted or construed as an offer to sell products that is open for acceptance or the grant, conveyance or implication of any license under any copyrights, patents or other industrial or intellectual property rights.

Reproduction of AWINIC information in AWINIC data books or data sheets is permissible only if reproduction is without alteration and is accompanied by all associated warranties, conditions, limitations, and notices. AWINIC is not responsible or liable for such altered documentation. Information of third parties may be subject to additional restrictions.

Resale of AWINIC components or services with statements different from or beyond the parameters stated by AWINIC for that component or service voids all express and any implied warranties for the associated AWINIC component or service and is an unfair and deceptive business practice. AWINIC is not responsible or liable for any such statements.

X-ON Electronics

Largest Supplier of Electrical and Electronic Components

Click to view similar products for [Audio Amplifiers](#) category:

Click to view products by [Awinic](#) manufacturer:

Other Similar products are found below :

[LV47002P-E](#) [NCP2890AFCT2G](#) [NTE1192](#) [LC706200CM](#) [IS31AP4915A-QFLS2-TR](#) [TDA1591T](#) [TS2012EIJT](#) [NCP2809BMUTXG](#)
[NJW1157BFC2](#) [IS31AP4996-GRLS2-TR](#) [NCP2823BFCT1G](#) [BD88420GUL-E2](#) [LA4450L-E](#) [IS31AP2036A-CLS2-TR](#) [NTE1110](#) [NTE7100](#)
[NTE7114](#) [NTE7163](#) [NTE7168](#) [NTE7177](#) [NTE7178](#) [NTE7186](#) [NTE7198](#) [NTE7202](#) [NTE7217](#) [BD88400GUL-E2](#) [BD88200GUL-E2](#)
[SABRE9601K](#) [THAT1646W16-U](#) [PAM8965ZLA40-13](#) [TSDP10XX1NLGXZBX](#) [TSDP11XX1NKGIZBX](#) [TSDP11XX1NLGXZBX](#)
[TSDP10XX1NKGIZBX](#) [NJM4580CV-TE1](#) [NJU7084R-TE1](#) [OPA1655DR](#) [LV4910T-MPB-E](#) [NCP2890AFCT2](#) [NCV2211DR2G](#)
[SCY99091FCT2G](#) [TAS5720MRSMR](#) [AW87389FCR](#) [AW8737AFCR](#) [TDA2005R](#) [TDA2030](#) [TDA7265L-J11-A-T](#) [CD2050CZ](#)
[AW88261FCR](#) [TDA7377-JSM](#)