

150KHz, 3A PWM Buck DC/DC Converter

❖ GENERAL DESCRIPTION

The AX3005 series are monolithic IC designed for a step-down DC/DC converter, and own the ability of driving a 3A load without additional transistor. It saves board space. The external shutdown function can be controlled by logic level and then come into standby mode. The internal compensation makes feedback control having good line and load regulation without external design. Regarding protected function, thermal shutdown is to prevent over temperature operating from damage, and current limit is against over current operating of the output switch. If current limit function occurs and V_{FB} is down below 0.5V, the switching frequency will be reduced. The AX3005 series operates at a switching frequency of 150KHz thus allow smaller sized filter components than what would be needed with lower frequency switching regulators. The output version included fixed 3.3V, 5V, 12V, and an adjustable type. The chip is available in a 5-Lead TO263 package.

❖ FEATURES

- Output voltage: 3.3V, 5V, 12V and adjustable output version.
- Adjustable version output voltage range, 1.23V to 38.5V.
- 150KHz fixed switching frequency.
- Voltage mode non-synchronous PWM control.
- Thermal-shutdown and current-limit protection.
- ON/OFF shutdown control input.
- Short Circuit Protect (SCP).
- Operating voltage can be up to 40V.
- Output load current: 3A.
- 5-Lead TO263 Pb-Free packages.
- Low power standby mode.
- Built-in switching transistor on chip.

❖ **BLOCK DIAGRAM**

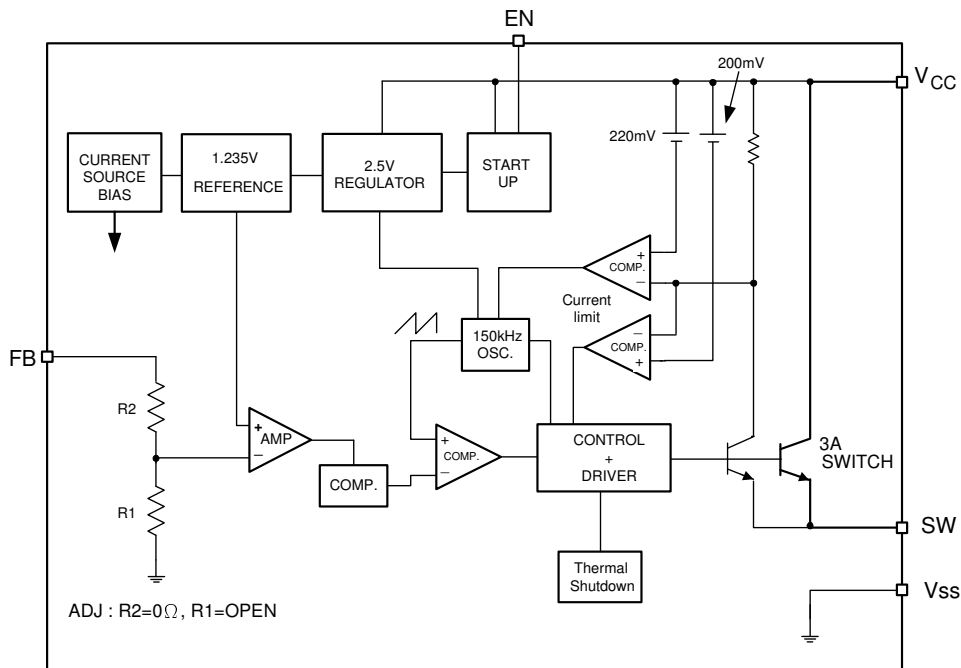

❖ **PIN ASSIGNMENT**

The package of AX3005 is TO263-5L; the pin assignment is given by:

TO263-5L (Side View)

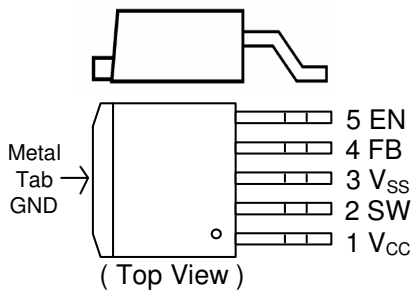

Name	Description
V_{CC}	Operating voltage input
SW	Switching output
V_{SS}	GND pin
FB	Output voltage feedback control
EN	ON/OFF Shutdown

❖ ORDER/MARKING INFORMATION

Order Information	
AX3005 - XX XXX X Output Voltage Package Type Packing 33:3.3V M5: TO263-5L Blank : Tube 50:5.0V 12: 12V A : Taping Blank:ADJ	
Top Marking	
ADJ Logo ← AX 3 0 0 5 → Part number YY WWX → ID code:internal → WW:01~52 → Year: 10=2010 11=2011 ⋮ 19=2019	FIX Logo ← AX 3 0 0 5 → Part number - XX → Output voltage YY WWX → ID code:internal → WW:01~52 → Year: 10=2010 11=2011 ⋮ 19=2019

❖ ABSOLUTE MAXIMUM RATINGS

Characteristics	Symbol	Rating	Unit
Maximum Supply Voltage	V _{CC}	+45	V
ON/OFF Pin Input Voltage	V _{EN}	-0.3 to 40	V
Feedback Pin Voltage	V _{FB}	-0.3 to 12	V
Output Voltage to Ground	V _{OUT}	-0.8	V
Power Dissipation Internally limited	PD	(T _J -T _A) / θ _{JA}	W
Storage Temperature Range	T _{ST}	-65 to +150	°C
Operating Junction Temperature Range	T _J	-40 to +125	°C
Operating Supply Voltage	V _{OP}	+4.5 to +40	V
Thermal Resistance from Junction to case	θ _{JC}	3.5	°C/W
Thermal Resistance from Junction to ambient	θ _{JA}	25	°C/W

Note: θ_{JA} is measured with the PCB copper area(need connect to V_{SS} pins) of approximately 3 in² (Multi-layer).

❖ ELECTRICAL CHARACTERISTICS

(Unless otherwise specified, $T_A=25^{\circ}\text{C}$, $V_{CC}=12\text{V}$ for 3.3V, 5V, adjustable version and $V_{CC}=18\text{V}$ for the 12V version. $I_{LOAD} = 0.2\text{A}$)

Characteristics		Symbol	Conditions	Min	Typ	Max	Units
Quiescent Current		I_{CCQ}	$V_{FB}=12\text{V}$ force driver off	-	4	8	mA
Feedback bias current		I_{FB}	$V_{FB}=1.3\text{V}$ (Adjustable version only)	-	-10	-500	nA
Shutdown supply Current		I_{SD}	EN pin=5V $V_{CC}=40\text{V}$	-	100	200	uA
Oscillator frequency		F_{OSC}		127	150	173	KHz
Oscillator frequency of short circuit protect		F_{SCP}	(Adjustable) When $V_{FB}<0.5\text{V}$	-	50	-	KHz
			(Fixed)When $< V_{OUT} * 40\%$	-	50	-	KHz
Max. Duty Cycle (ON)		DC	$V_{FB}=0\text{V}$ force driver on	-	100	-	%
Min. Duty Cycle (OFF)			$V_{FB}=12\text{V}$ force driver off	-	0	-	
Current limit		I_{CL}	Pear current, No outside circuit $V_{FB}=0\text{V}$ force driver on	3.3	-	-	A
Load Regulation($\Delta V_{OUT}/V_{OUT}$)		ΔV_{OUT}	$I_{OUT} = 0.2$ to 3A	-	0.6	1.2	%
Saturation voltage		V_{SAT}	$I_{OUT}=3\text{A}$, No outside circuit $V_{FB}=0\text{V}$ force driver on	-	1.3	1.5	V
SW pin=0V	SW pin leakage current	I_{SWL}	No outside circuit $V_{FB}=12\text{V}$ force driver off	-	-	-200	uA
SW pin=-0.8V			$V_{CC}=40\text{V}$ force driver off	-	-5	-	mA
EN pin logic input threshold voltage		V_{IL}	Low (regulator ON)	-	1.3	0.6	V
		V_{IH}	High (regulator OFF)	2.0		-	
EN pin logic input current		I_H	$V_{EN}=2.5\text{V}$ (OFF)	-	-0.1	-5	uA
EN pin input current		I_L	$V_{EN}=0.5\text{V}$ (ON)	-	-0.01	-1.5	
Thermal shutdown Temp		T_{SD}		-	135	-	$^{\circ}\text{C}$

❖ ELECTRICAL CHARACTERISTICS (CONTINUED)

Version	Characteristics	Symbol	Conditions	Min	Typ	Max	Units
AX3005-ADJ	Output Feedback voltage	V_{FB}	$I_{LOAD} = 0.2A$ V_{OUT} programmed for 3.3V	1.193	1.23	1.267	V
	Efficiency	η	$V_{CC} = 12V, I_{LOAD} = 3A$		74		%
AX3005-3.3V	Output voltage	V_{OUT}	$I_{LOAD} = 0.2A$	3.20	3.30	3.40	V
	Efficiency	η	$V_{CC} = 12V, I_{LOAD} = 3A$	-	75	-	%
AX3005-5.0V	Output voltage	V_{OUT}	$I_{LOAD} = 0.2A$	4.85	5.00	5.15	V
	Efficiency	η	$V_{CC} = 12V, I_{LOAD} = 3A$	-	80	-	%
AX3005-12V	Output voltage	V_{OUT}	$I_{LOAD} = 0.2A$	11.64	12.0	12.36	V
	Efficiency	η	$V_{CC} = 15V, I_{LOAD} = 3A$	-	89	-	%

❖ APPLICATION CIRCUIT

(1) $V_{IN} = 12V$

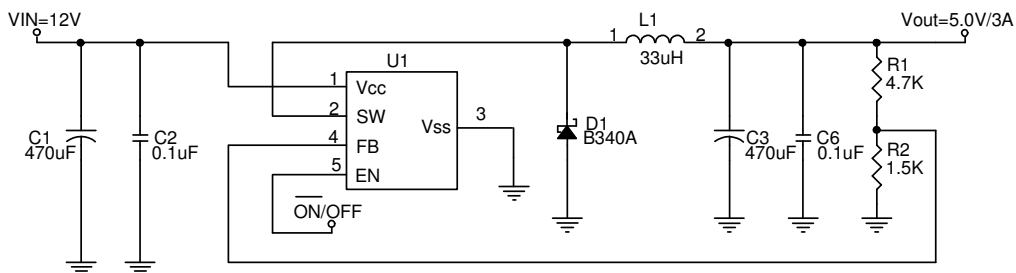

(2) $V_{IN} = 24V$

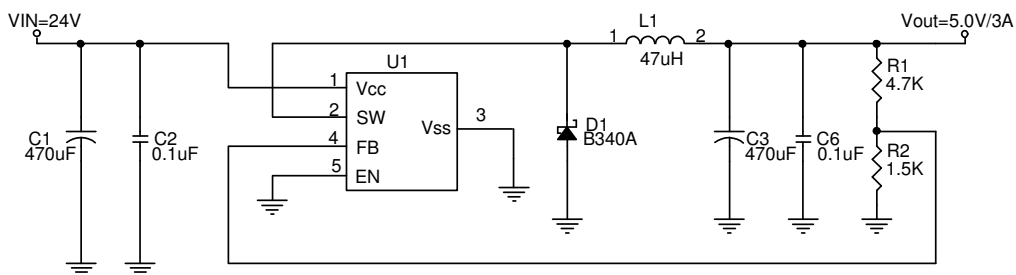

$$V_{OUT} = V_{FB} \times \left(1 + \frac{R1}{R2}\right), V_{FB} = 1.23V, R2 = 0.7K \sim 3K$$

V_{OUT}	R2	R1
5.0V	1.5K	4.7K
3.3V	1.5K	2.5K
2.5V	1.5K	1.5K

(3) Fixed Output Voltage Version

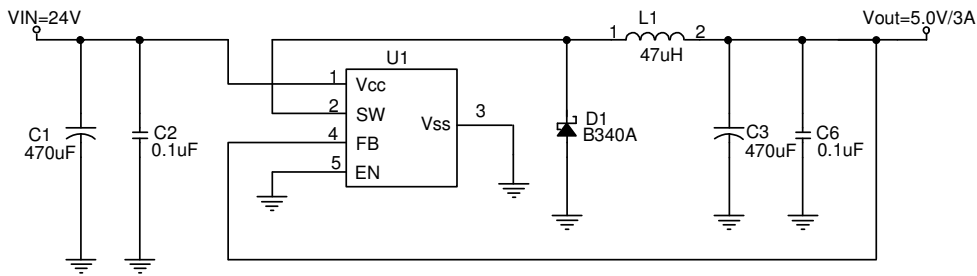

L1 recommend value (I _{OUT} =3A _i)				
V _{OUT}	2.5V	3.3V	5V	12V
V _{IN} =12V	33uH	33uH	33~47uH	NA
V _{IN} =24V	33uH	33uH	47uH	68uH

❖ FUNCTION DESCRIPTIONS

Pin Functions

V_{CC}

This is the positive input supply for the IC switching regulator. A suitable input bypass capacitor must be presented at this pin to minimize voltage transients and to supply the switching currents needed by the regulator.

V_{SS}

Circuit ground.

SW

Internal switch. The voltage at this pin switches between (+V_{CC} - V_{SAT}) and approximately - 0.5V, with a duty cycle of approximately V_{OUT} / V_{CC}. To minimize coupling to sensitive circuitry, the PC board copper area connected to this pin should be minimized.

Feedback

Senses the regulated output voltage to complete the feedback loop.

EN

Allows the switching regulator circuit to be shutdown using logic level signals thus dropping the total input supply current to approximately 100uA. Pulling this pin below a threshold voltage of approximately 1.3V turns the regulator on, and pulling this pin above 1.3V (up to a maximum of V_{CC}) shuts the regulator down. If this shutdown feature is not needed, the EN pin can be wired to the ground pin.

Thermal Considerations

The TO263-5L package needs a heat sink under most conditions. The size of the heat sink depends on the input voltage, the output voltage, the load current and the ambient temperature. The AX3005 junction temperature rises above ambient temperature for a 3A load and different input and output voltages.

The data for these curves was taken with the AX3005 (TO263-5L package) operating as a buck-switching regulator in an ambient temperature of 25°C (still air). These temperature increments are all approximate and are affected by many factors. Higher ambient temperatures require more heat sinker.

For the best thermal performance, wide copper traces and generous amounts of printed circuit board copper (need connect to the V_{SS} pins) should be used in the board layout, (One exception is the SW(switch) pin, which should not have large areas of copper.) Large areas of copper provide the best transfer of heat (lower thermal resistance) to the surrounding air, and moving air lowers the thermal resistance even further.

Package thermal resistance and junction temperature increments are all approximate. The increments are affected by a lot of factors. Some of these factors include board size, shape, thickness, position, location, and even board temperature. Other factors are, trace width, total printed circuit copper area, copper thickness, single or double-sided, multi-layer board and the amount of solder on the board.

The effectiveness of the PC board to dissipate heat also depends on the size, quantity and spacing of other components on the board, as well as whether the surrounding air is still or moving. Furthermore, some of these components such as the catch diode will add heat to the PC board and the heat can vary as the input voltage changes. For the inductor, depending on the physical size, type of core material and the DC resistance, it could either act as a heat sink taking heat away from the board, or it could add heat to the board.

❖ TYPICAL CHARACTERISTICS

Output Ripple
($V_{IN}=12V, V_{OUT}=5V, I_{OUT}=3A$)

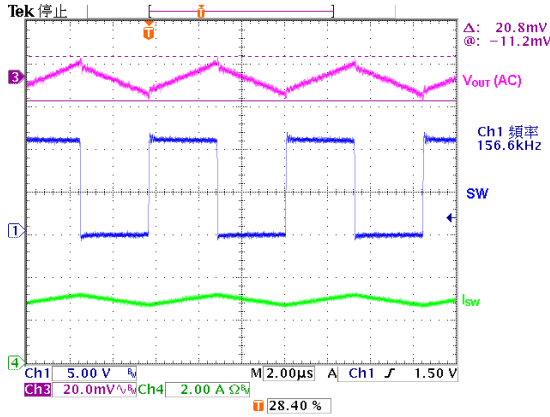

Power on test wave
($V_{IN}=12V, V_{OUT}=5V, I_{OUT}=3A$)

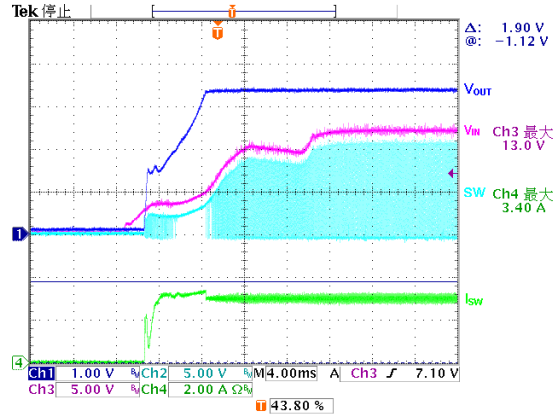

Load Transient Response
($V_{IN}=12V, V_{OUT}=5V, I_{OUT}=0.2\sim 3A$)

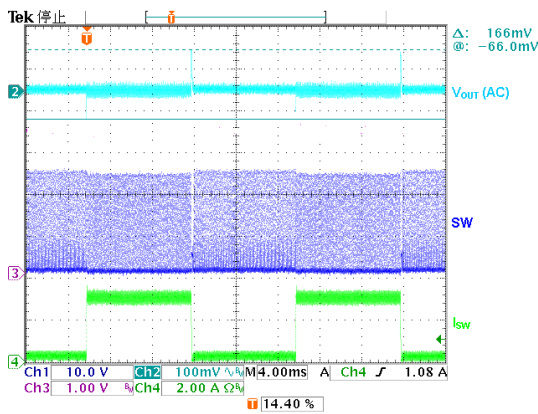

EN on test wave
($V_{IN}=12V, V_{OUT}=5V, I_{OUT}=3A$)

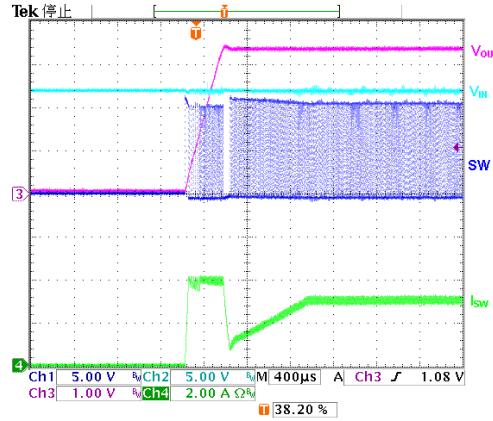

Efficiency
($V_{IN}=12V, V_{OUT}=5.0V$)

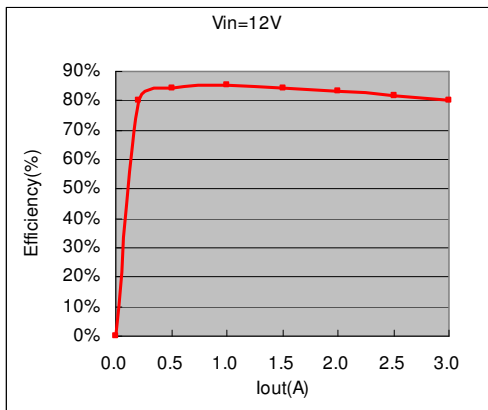

Efficiency
($V_{IN}=24V, V_{OUT}=5.0V$)

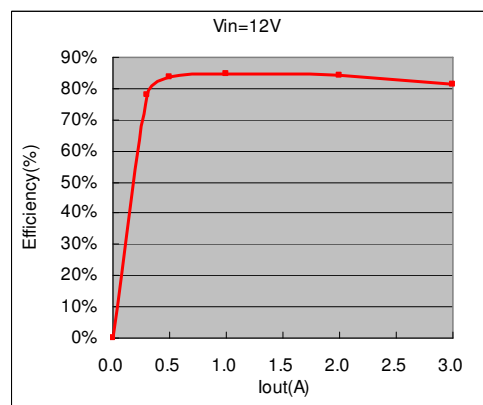

❖ **PACKAGE OUTLINES**

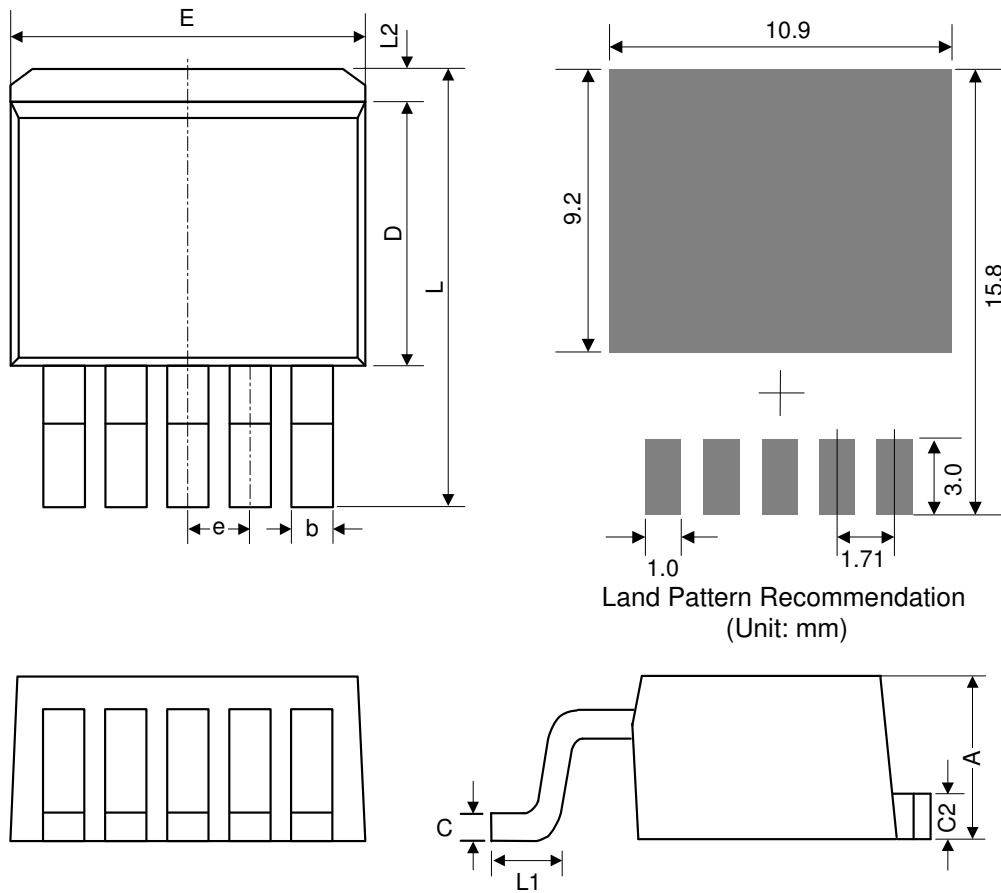

Symbol	Dimensions in Millimeters			Dimensions in Inches		
	Min.	Nom.	Max.	Min.	Nom.	Max.
A	4.06	4.45	4.83	0.16	0.175	0.19
b	0.51	0.76	0.99	0.02	0.03	0.039
C	0.38	0.56	0.74	0.015	0.022	0.029
C2	1.14	1.4	1.65	0.045	0.055	0.065
D	8.38	9.02	9.65	0.33	0.355	0.38
E	9.65	10.2	10.7	0.38	0.4	0.42
e	1.70 BSC			0.067 BSC		
L	14.6	15.2	15.9	0.575	0.6	0.625
L1	1.78	2.29	2.79	0.07	0.09	0.11
L2	-	-	1.68	-	-	0.066

Mold flash shall not exceed 0.005inch per side

JEDEC outline: TO-263 BA

X-ON Electronics

Largest Supplier of Electrical and Electronic Components

Click to view similar products for [Isolated DC/DC Converters](#) category:

Click to view products by [Axelite](#) manufacturer:

Other Similar products are found below :

[FMD15.24G](#) [PSL486-7LR](#) [Q48T30020-NBB0](#) [18362](#) [JAHW100Y1](#) [SPB05C-12](#) [SQ24S15033-PS0S](#) [18952](#) [19-130041](#) [CE-1003](#) [CE-1004](#)
[RDS180245](#) [MAU228](#) [J80-0041NL](#) [DFC15U48D15](#) [XGS-1205](#) [NCT1000N040R050B](#) [SPB05B-15](#) [SPB05C-15](#) [L-DA20](#) [DCG40-5G](#)
[QME48T40033-PGB0](#) [AK1601-9RT](#) [DPA423R](#) [VI-R5022-EXWW](#) [PSC128-7iR](#) [RPS8-350ATX-XE](#) [DAS1004812](#) [PQA30-D24-S24-DH](#) [vi-](#)
[m13-cw-03](#) [VI-LN2-EW](#) [VI-PJW01-CZY](#) [CK2540-9ERT](#) [AK-1615-7R](#) [700DNC40-CON-KIT-8G](#) [350DNC40-CON-KIT-9G](#) [088-101348-G](#)
[VI-L52-EW](#) [VI-L53-CV](#) [PQA30-D48-S12-TH](#) [VI-L50-IY](#) [VI-LC63-EV](#) [AM2D-051212DZ](#) [24IBX15-50-0ZG](#) [HZZ01204-G](#) [SPU02L-09](#)
[SPU02M-09](#) [SPU02N-09](#) [UNO-PS/350-900DC/24DC/60W](#) [QUINT4-BUFFER/24DC/20](#)