



---

# IQS316 Evaluation Kit User Guide

## IQ Switch<sup>®</sup> - ProxSense<sup>®</sup> Series

IQS316 EV-Kit and software GUI

---

### 1 Introduction

This user guide describes the operation of the IQS316 Evaluation Kit. The EV-Kit is manufactured in three parts, consisting of a controller board, and two separate plug-in keypad boards. The controller board is interfaced to any personal computer with the Azoteq Configuration Tool (CT210) or DS100 Data Streamer, and the IQS316 Graphical User Interface (GUI). The keypad module boards consist of a 16-key touch panel and an 8-key touch panel. The purpose of the IQS316 EV-Kit is to facilitate application and development engineers in evaluating the IQS316 proximity and touch sensor.

A digital copy of this [user guide](#) is available for download at the website.

### 2 IQS316 EV-Kit Controller Board

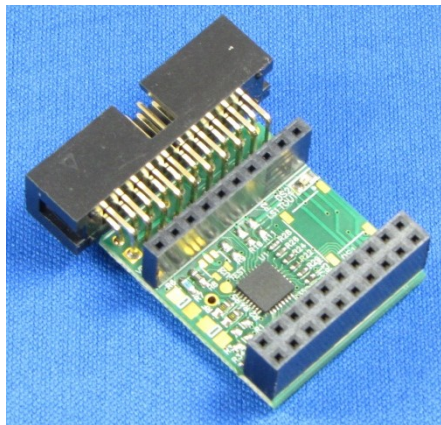

Figure 2.1 Top view of IQS316 EV-Kit controller board

### 3 16-Key Touch panel

This demo utilises the 16-Key touch panel interfaced to the IQS316 controller board. The 16-Key touch panel plugs into the controller board port. The controller board is in turn interfaced to a personal computer running the IQS316 GUI software, by means of a CT210. The touch panel is illustrated in the figure below.

The 16 touch keys have a 1mm Perspex overlay and are arranged in a 4 x 4 matrix, labelled from 1 to 16. A green LED is used to indicate proximity, and a red LED to indicate when a key is touched.

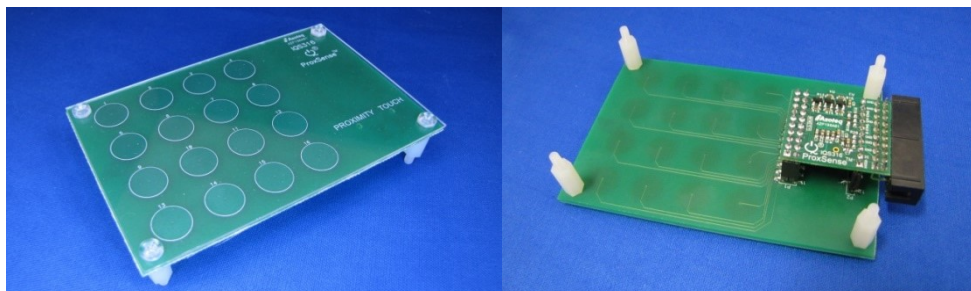

Figure 3.1 16-Key Touch panel (left), 16-Key Touch panel with controller board attached (right)

The 16-Key touch panel with attached controller board is depicted in the figure above.



## 4 8-Key Touch panel

The 8-Key touch panel is interfaced to the IQS316 Controller board in the same way as the 16-Key touch panel, by simply plugging it into the controller board port.

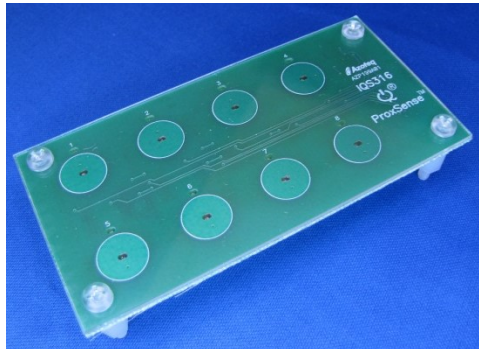

Figure 4.1 8-Key Touch panel

The 8-Key touch panel is illustrated in the figure above. The 8 touch keys are arranged in a 2 x 4 matrix and covered by a 1 mm Perspex overlay.

Each touch key has a green LED in the center of the key, and all 8 LEDs illuminate simultaneously upon the detection of a proximity condition. Each touch key has a red LED located above the key, which indicates individual key presses.

## 5 Using the Software GUI

- Download and install the [IQS316 software GUI](#).
- Plug the ribbon cable provided into the CT210 or DS100, and into the controller board.
- Plug the desired keypad into the controller board.
- After opening the GUI, the following screen is displayed as illustrated below.

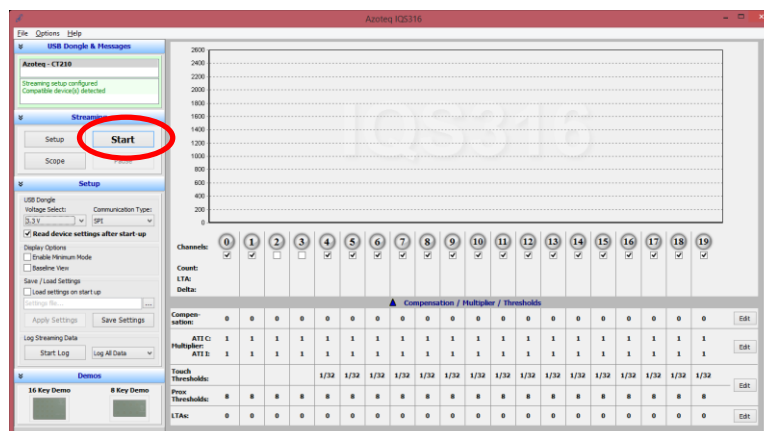

Figure 5.1 Start-up Screen for the IQS316 GUI

- Click on “Start” as illustrated above.



### 5.1 16-Key Demo

- To enter the 16-Key Demo mode, click on “16 Key Demo” in the lower left-hand corner of the IQS316 GUI start-up screen, as indicated below.

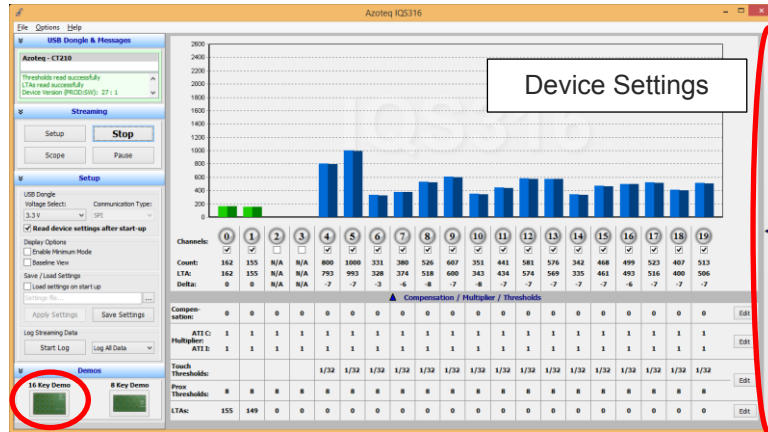

Figure 5.2 Start-up Screen for the IQS316 GUI

- The device settings can be viewed and adjusted by clicking on the bar on the right-hand side of the GUI, as depicted above.
- Click on “Load optimal settings” as depicted below

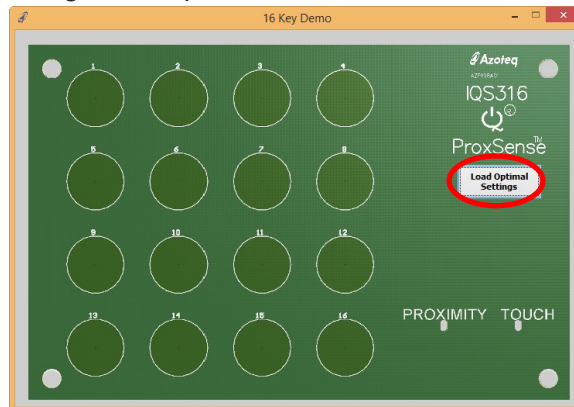

Figure 5.3 Setting up the GUI for 16-Key Demo operation

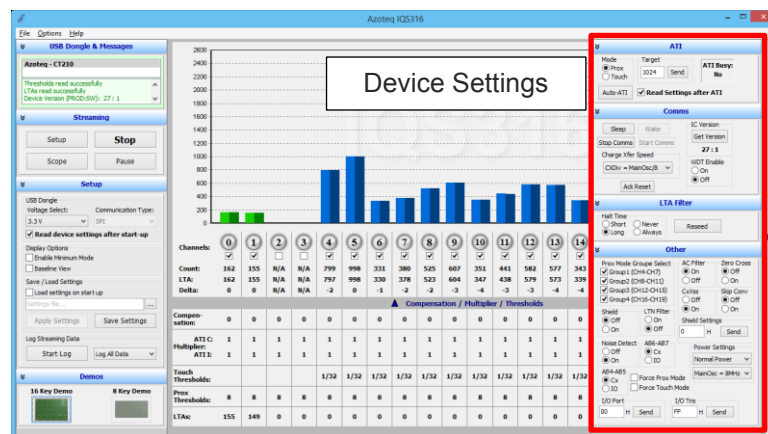

Figure 5.4 Device settings menu



## 5.2 8-Key Demo

- To enter the 8-Key Demo mode, click on “8 Key Demo” in the lower left-hand corner of the IQS316 GUI start-up screen, as indicated below.

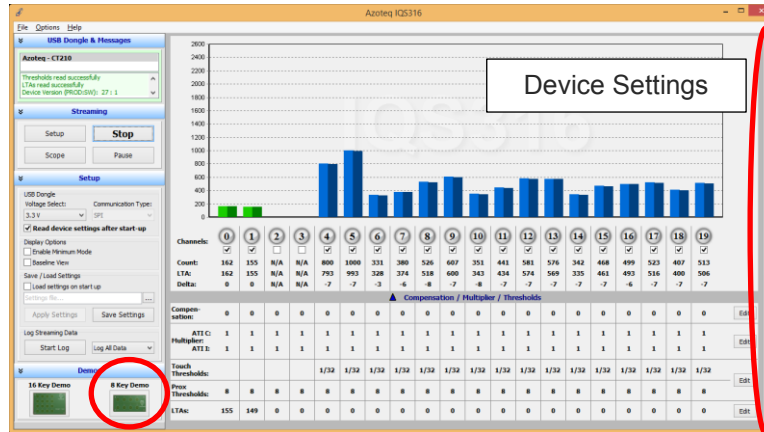

Figure 5.5 Start-up Screen for the IQS316 GUI

- The device settings can be viewed and adjusted by clicking on the bar on the right-hand side of the GUI, as depicted above.
- Click on “Load optimal settings” as depicted below.



Figure 5.6 Setting up the GUI for 8-Key Demo operation

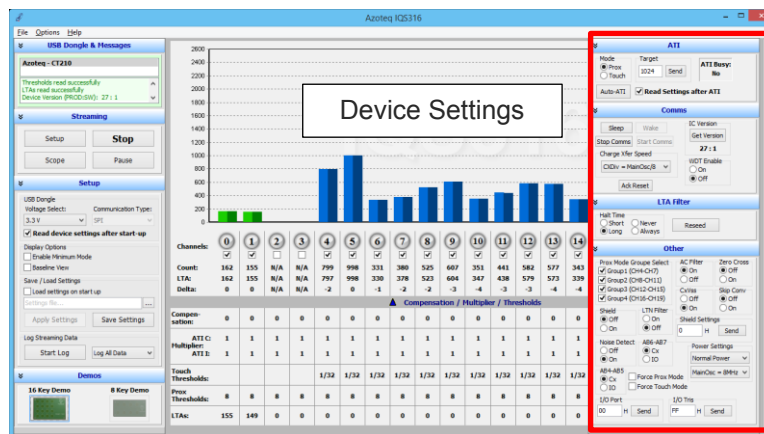

Figure 5.7 Device settings menu



## 6 Reference design

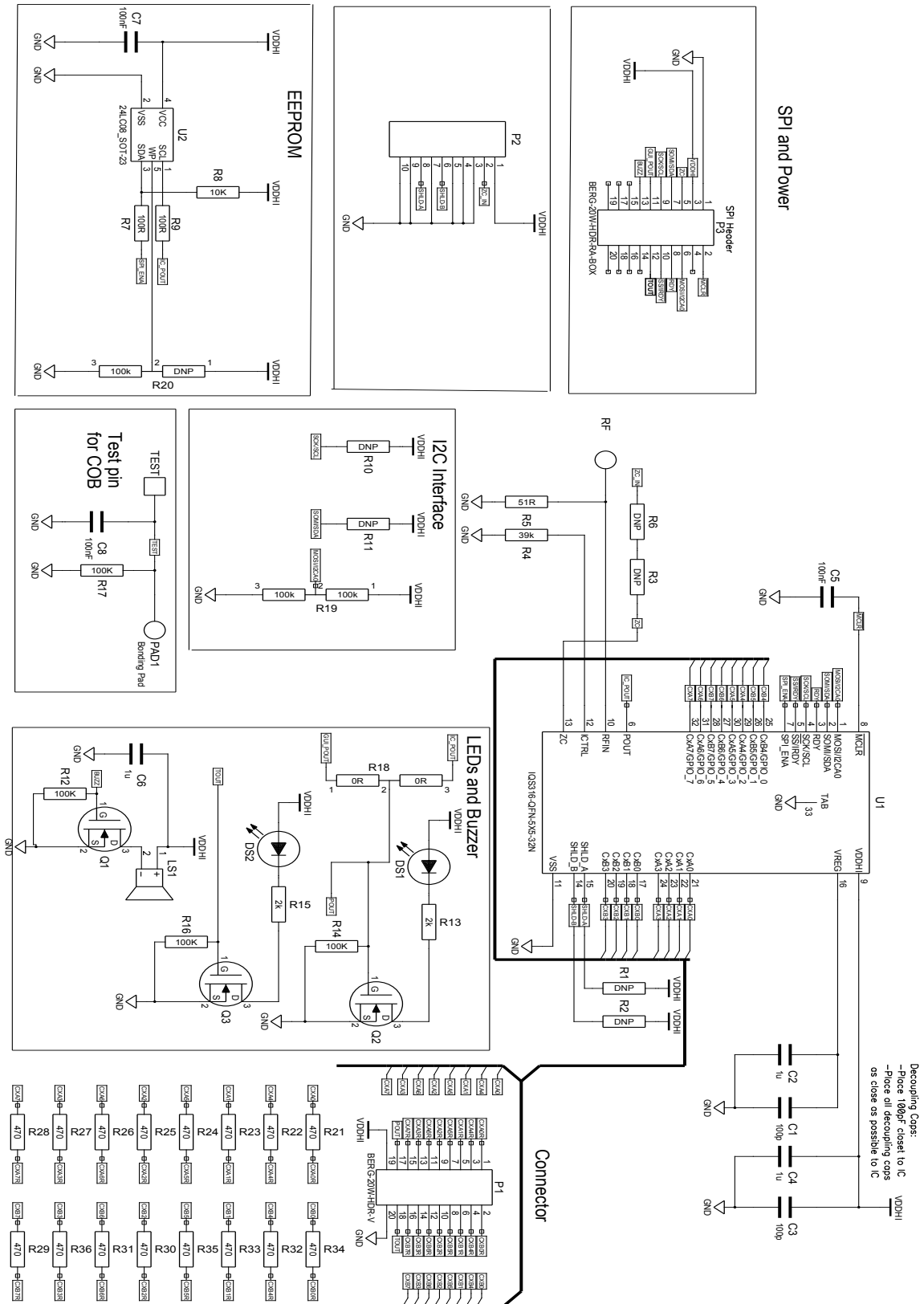
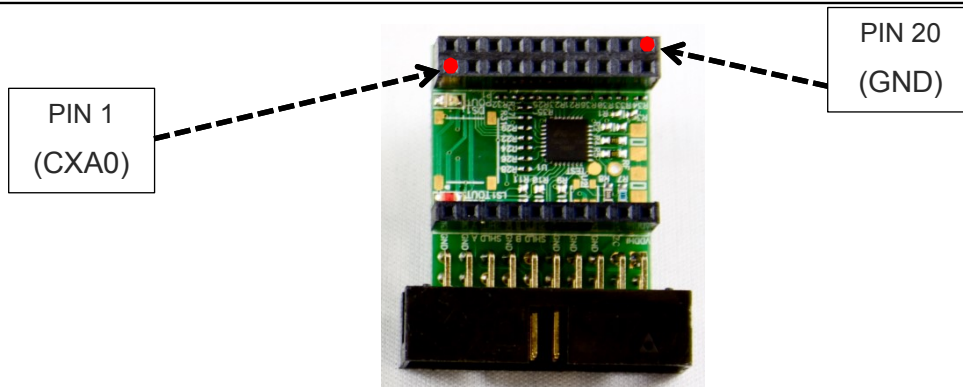
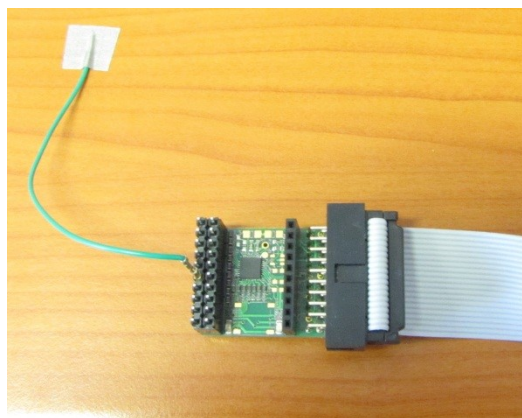

Figure 6.1 IQS316 reference design



**Figure 6.2 IQS316 Controller Module**

The IQS316 Controller Module is illustrated above, indicating PIN 1, and PIN20 of the connector.



**Figure 6.3 Simple touch key connected to IQS316 Controller**

A simple touchpad created out of a wire and conductive tape is illustrated above. This illustrates the ease with which external electrodes can be connected to the IQS316 Controller module.

Please note: If the IQS316 Controller Module is connected to a power supply derived from the mains supply, FTB (Fast Transient Burst) spikes could possibly cause interference and undesired operation. For information on how to solve this problem please refer to application note "[AZD051 - Electrical Fast Transient Burst Guidelines](#)".

For touch button design guidelines, please refer to application note [AZD008](#) – “Design Guidelines for Touch Pads”, on the Azoteq website:



	<b>USA</b>	<b>Asia</b>	<b>South Africa</b>
<b>Physical Address</b>	6507 Jester Blvd Bldg 5, suite 510G Austin TX 78750 USA	Rm2125, Glittery City Shennan Rd Futian District Shenzhen, 518033 China	109 Main Street Paarl 7646 South Africa
<b>Postal Address</b>	6507 Jester Blvd Bldg 5, suite 510G Austin TX 78750 USA	Rm2125, Glittery City Shennan Rd Futian District Shenzhen, 518033 China	PO Box 3534 Paarl 7620 South Africa
<b>Tel</b>	+1 512 538 1995	+86 755 8303 5294 ext 808	+27 21 863 0033
<b>Fax</b>	+1 512 672 8442		+27 21 863 1512
<b>Email</b>	kobusm@azoteq.com	linayu@azoteq.com.cn	info@azoteq.com

Please visit [www.azoteq.com](http://www.azoteq.com) for a list of distributors and worldwide representation.

The following patents relate to the device or usage of the device: US 6,249,089 B1; US 6,621,225 B2; US 6,650,066 B2; US 6,952,084 B2; US 6,984,900 B1; US 7,084,526 B2; US 7,084,531 B2; US 7,265,494 B2; US 7,291,940 B2; US 7,329,970 B2; US 7,336,037 B2; US 7,443,101 B2; US 7,466,040 B2 ; US 7,498,749 B2; US 7,528,508 B2; US 7,755,219 B2; US 7,772,781 B2; US 7,781,980 B2; US 7,915,765 B2; US 7,994,726 B2; US 8,035,623 B2; US RE43,606 E; US 8,288,952 B2; US 8,395,395 B2; US 8,531,120 B2; US 8,659,306 B2; US 8,823,273 B2; EP 1 120 018 B2; EP 1 206 168 B1; EP 1 308 913 B1; EP 1 530 178 A1; EP 2 351 220 B1; EP 2 559 164 B1; CN 1330853; CN 1783573; AUS 761094; HK 104 1401

IQ Switch®, SwipeSwitch™, ProxSense®, LightSense™, AirButton™ and the  logo are trademarks of Azoteq.

The information in this Datasheet is believed to be accurate at the time of publication. Azoteq uses reasonable effort to maintain the information up-to-date and accurate, but does not warrant the accuracy, completeness or reliability of the information contained herein. All content and information are provided on an "as is" basis only, without any representations or warranties, express or implied, of any kind, including representations about the suitability of these products or information for any purpose. Azoteq disclaims all warranties and conditions with regard to these products and information, including but not limited to all implied warranties and conditions of merchantability, fitness for a particular purpose, title and non-infringement of any third party intellectual property rights. Azoteq assumes no liability for any damages or injury arising from any use of the information or the product or caused by, without limitation, failure of performance, error, omission, interruption, defect, delay in operation or transmission, even if Azoteq has been advised of the possibility of such damages. The applications mentioned herein are used solely for the purpose of illustration and Azoteq makes no warranty or representation that such applications will be suitable without further modification, nor recommends the use of its products for application that may present a risk to human life due to malfunction or otherwise. Azoteq products are not authorized for use as critical components in life support devices or systems. No licenses to patents are granted, implicitly, express or implied, by estoppel or otherwise, under any intellectual property rights. In the event that any of the abovementioned limitations or exclusions does not apply, it is agreed that Azoteq's total liability for all losses, damages and causes of action (in contract, tort (including without limitation, negligence) or otherwise) will not exceed the amount already paid by the customer for the products. Azoteq reserves the right to alter its products, to make corrections, deletions, modifications, enhancements, improvements and other changes to the content and information, its products, programs and services at any time or to move or discontinue any contents, products, programs or services without prior notification. For the most up-to-date information and binding Terms and Conditions please refer to [www.azoteq.com](http://www.azoteq.com).

[WWW.AZOTEQ.COM](http://WWW.AZOTEQ.COM)

[info@azoteq.com](mailto:info@azoteq.com)

## X-ON Electronics

Largest Supplier of Electrical and Electronic Components

*Click to view similar products for [Touch Sensor Development Tools](#) category:*

*Click to view products by [Azoteq](#) manufacturer:*

Other Similar products are found below :

[TSC2100EVM](#) [TSC2003EVM-PDK](#) [ATMXT1066T2-DEV-PCB](#) [ATMXT336UDEVPCB](#) [LC717A00ARGEVK](#) [ATMXT641TDAT-I2C-PCB](#)  
[MAX20353EVSYS#\\_1374](#) [MIKROE-1906\\_1602](#) [SEN0164\\_1982](#) [STEVAL-PCC009V3](#) [ATSAMD20-QTRDEMO](#) [ATQT2-XPRO](#) [ATQT6-XPRO\\_2340](#) [DM160221](#) [DM160229](#) [DM160222](#) [ATQT5-XPRO](#) [DFR0129](#) [SEN0170](#) [SLEXP8019A](#) [SLEXP8018A\\_1375](#) [DFR0386](#)  
[SEN0186](#) [SEN0148](#) [DK-000013-03](#) [ROB0103](#) [cs-useful-01](#) [DFR0385](#) [SEN0184](#) [SX8651EVKA\\_1362](#) [1580](#) [2024](#) [3575](#) [4830](#) [AS8579-TS\\_EK\\_DB](#) [ATQT600](#) [IQS227/228ASEV01](#) [SKU-6515](#) [CY3280-MBR2](#) [CY3280-MBR3](#) [DFR0030](#) [DM160219](#) [AC160219](#) [AC320007](#)