

INDEX



	BAHCO.....	V
	Machine actuated saws.....	2
	Files & rotary burrs.....	60
	Wrenches.....	134
	Sockets & accessories.....	196
	Torque tools.....	308
	Impact tools & bits.....	332
	Screwdrivers.....	422
	Pliers.....	528
	Pipe wrenches & pipe tools.....	602
	Air tools.....	622
	Automotive speciality tools & equipment.....	656
	Hydraulic & lifting equipment.....	710
	Lighting.....	724
	Inspection tools.....	732
	Extractors & pullers.....	740
	Tool storage.....	764
	Personal protective equipment.....	848
	Insulated tools.....	854
	Tweezers & electronics speciality tools.....	898
	Measuring tools.....	930
	Decorating tools.....	948
	Hand actuated saws.....	972
	Wood chisels & accesories.....	1016
	Scissors & knives.....	1028
	Drills.....	1050
	Clamping tools.....	1064
	Striking tools.....	1078
	Digging tools.....	1110
	Pruning tools.....	1120
	Lindström precision tools.....	1178
	Alphabetical, alphanumerical index.....	1226

Welcome to Bahco

“... [offering] exceptional products to professionals in industry, building & construction, the automotive and green sectors...”

SNA Europe is the premier pan-European hand-tool manufacturer. We design and manufacture tools to meet the needs of the most demanding professionals. We have been innovators for over 150 years. In that time we have introduced some of the most advanced tools in the world, selling through distributors with whom we build long-term partnerships.

Many anthropologists think that tools appeared because humans were intelligent, and that humans became measurably more intelligent the more they used them. This is one of the many reasons SNA Europe is proud to develop, manufacture and market tools.

We started to manufacture tools some two centuries ago. Many of the tools that we produce today look very similar to their distant ancestors, yet most are very different. Similar because the human hand has hardly changed at all, but different because the manufacturing processes have changed a great deal. Our design has changed too - because it has been, and continues to be, highly focused on innovation, performance and ergonomics.

Our partner distributors offer exceptional products to the professionals of industry, building & construction, automotive and green sectors, as well as to the most discerning private users. Bahco products are overwhelmingly manufactured in our own factories located across Europe, from Scandinavia to Iberia, from the British Isles to the Russian East European plain.

Our ambition is to become, and to be recognised as, an unflinching company, professional above all, a company that contributes to peoples' health, wealth and safety by offering the most valued productivity solutions in the world. This is our ambition for today and for the future.

Jean-Pierre Levrey
President, SNA Europe Group

SNAEurope

Fish & Hook story

“So why do Bahco products carry a fish and a hook?”

This is a question that has been asked many times, and we are always pleased to tell the story. After Göran Fredrik Göransson established his steel mill in 1862, the European steel industry suffered a long, deep depression with low prices for general and crude steel products in particular. Prices for processed steel were much better.

In 1876 the existing steel-rolling mill was adapted to produce so-called ‘milled steel’. Sales developed quickly and a number of applications for this kind of steel wire were identified. In particular, it proved excellent for producing fishhooks. A fishhook needs to be hard and strong, but absolutely not brittle. At that time, achieving this combination was something of a thorny metallurgical task, but the ‘Bessemer steel’ from Göransson’s steel mill delivered optimal quality on all counts.

With the start of the production of saw blades in 1886 there emerged a need for a graphic image that would communicate the blade’s special properties and quality. The choice was - quite naturally - the fish and hook.

Everybody understood that if this steel was the ideal quality for fishhooks, it would be perfect for saws and other cutting tools as well.

The image was a great advantage. Because the logo did not include letters, language or sophisticated figures, it was easy for everyone to recognise.

Even today you can still hear workers asking for a saw ‘with the little fish’. The brand is amongst the oldest registered trademarks, and the ‘fish and hook’ icon is still embedded in all Bahco tools as a guarantee that they are of the highest quality, performance and productivity – and developed for professionals.



Segments

In 1886 the first saws, which would later become Bahco branded, were manufactured in Sweden, with the exceptional toughness and durability that would satisfy the needs of professional users.

Today Bahco is a global, market-leading brand with a wide range of professional hand-tools, including handsaws, combination spanners, socket spanners, screwdrivers, adjustable wrenches, cutters, files, bandsaws, pruning tools, hacksaw frames and blades, holesaws...

The spirit of innovation and unrelenting quality, which first set Bahco tools apart, continues to define the brand to this day. It is not sufficient for Bahco tools to be just good - we set out to make them the very best - for efficiency, user-friendliness, quality, design and ergonomics.

Over decades, we have developed specific offers for professional users in numerous applications, based on our commitment to offer the best possible solution for every different task that needs to be performed. That's why professional tool users across the globe still look for our 'fish and hook' brand.

It represents our contribution to their pride in a job well done.

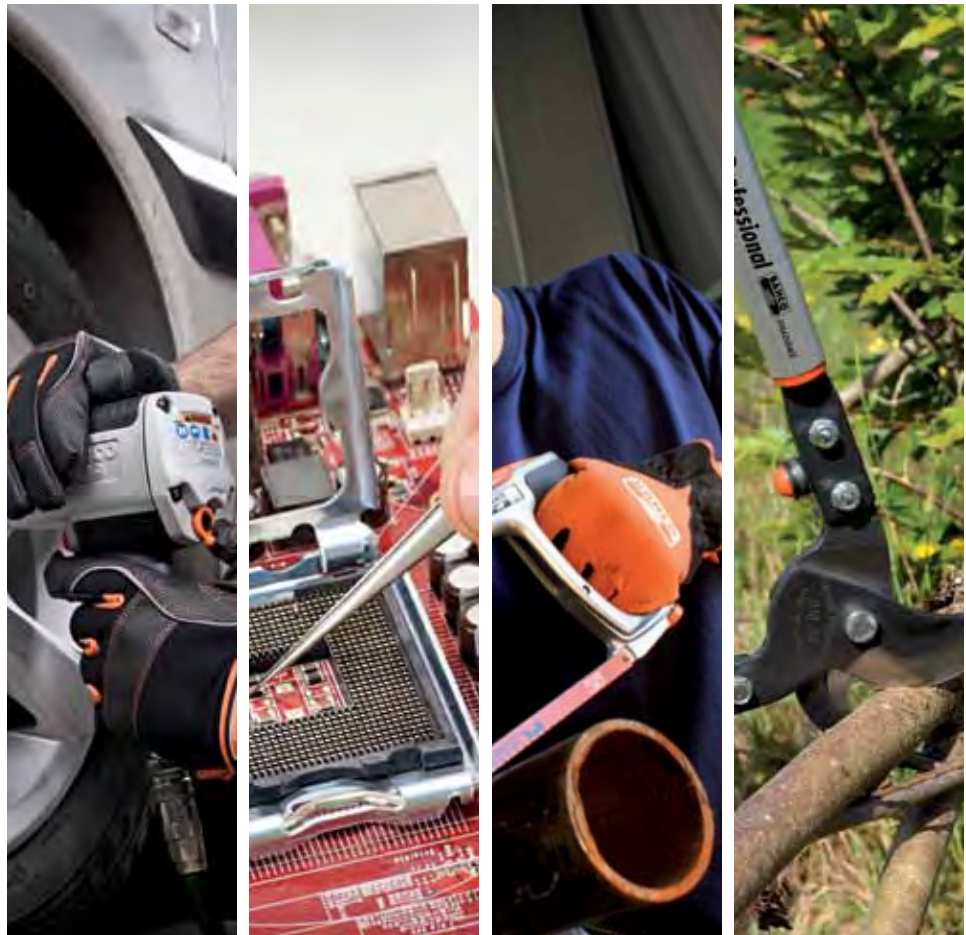

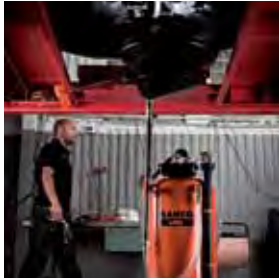

Auto

Professionals in automotive and transportation applications, including the maintenance and repair of cars, motorcycles, small boats, trucks and heavy vehicles, all benefit from a dedicated product offer that helps them achieve better results in every major task related to their work.

In environments where speed, durability, strength or vehicle-specific requirements play a major role, Bahco provides specific solutions, from cutting to tightening, from tool solutions to diagnostics and from light workshop equipment to powerful air tools.



Industry

Bahco supplies premium tools to professionals in some of the world's most technically demanding industries, including manufacturing and assembly, maintenance repair and overhaul (MRO), natural resources, utilities, rail, ships, aviation and aerospace. When machine downtime, performance, cost per operation or critical tasks are at stake, Bahco is the brand of choice and time after time, year after year. Bahco delivers permanent quantitative results even in most challenging environments.



Building & Construction

Professionals in building and construction, from general tradesmen and plumbers to electricians and specialist contractors, appreciate Bahco tools because they help them complete their job faster, with better results and their safety in mind. Whether outside or inside, heavy-duty or precision, Bahco offers the right support for many construction-related applications, constantly developing new tools to help increase jobsite productivity, to do more in less time - and to do it better.



Green

The same movement, over and over, with the same clean result. Professionals in land cultivation, viticulture, landscaping, pomology and floriculture are passionate about nature and play an important role in preserving the ecosystem and diversity. Bahco pruning tools are the best choice for repetitive work, combining ergonomics with performance, while ensuring a clean, perfect cut. Decades of experience with the most demanding professionals in diverse geographies have contributed to the expertise that goes into our pruning tools. This insight drives our continued dedication to a unique combination of state-of-the-art technology and a deep understanding of nature.

AUTOGREENINDUSTRY BUILDING&CONSTRUCTION



If hand tools are to be ergonomic, they must be perfectly suited to the task, the user and the environment. That is why all three of these factors are crucial when creating an ERGO™ product.

Ergonomic tools are designed to fit the human hand, minimising grip-strength demands and allowing muscles to relax periodically, reducing the risk of static muscle fatigue. Locking or adjusting mechanisms must be safe and easy-to-use, mitigating the risk of injury or any awkward hand positioning. Contact stress and slipping should be managed through the right choice of materials and handle design. The handle is fundamental as it also provides the right sensory feedback for accuracy, precision and optimum control of the tool, and is designed to reduce vibrations to the hand and arm.

Whenever an ERGO™ tool is being developed, sustainable efficiency and effectiveness are considered, as well as reliability and durability in challenging environments. Safety is paramount and we work to prevent risks of both immediate and long-term injuries and pain.

We also take pride and the experience into account - our ergonomic tools are made to be attractive and give the user control, comfort and precision. We innovate continuously, in terms of function, material and design.

We believe it is important to adapt tools to the potential and limitations of human anatomy, instead of expecting people to adapt to our tools.

We believe in putting the right tools in the hands of professional users, mitigating injury and making their work more efficient, effective, less tiring and more fun!

Bahco ERGO™ Development Program

Our scientific Bahco ERGO™ Development Program (the 11-point program) has resulted in many successful and scientifically evaluated ergonomic tools. We work hard to deliver the best possible tools to every customer, and over the years we have continuously developed, improved and fine-tuned the way we do this.

The Bahco ERGO™ Process

So far there are some 500 Bahco ERGO™ tools, and the demand is ever-increasing. In order to sharpen our competitive edge in ergonomics and industrial design we have refined the way we design into the Bahco ERGO™ Process. This is a comprehensive three-phase process, with each phase consisting of several steps.

The Bahco ERGO™ Process is unique to Bahco and scientifically formulated with the help of Industrial Designers and Ergonomists.

The Bahco ERGO™ Process complies with ISO 9241.

The first phase of the Bahco ERGO™ Process is Observe. Its purpose is to provide the foundation for ergonomic product development. It consists of pre-studies for each product idea, with emphasis on the ergonomic survey - a series of interviews to obtain insights into the tasks performed with the tool, looking at how it is handled, who uses it, and in what kind of environment.

The second phase is Experiment. It starts with a prototype design that is then tested by users and those test results analysed. This leads to a new series of prototypes that are put through user tests and analysis again. The number of design and test rounds varies, depending on a number of factors.

At the end of this phase, conclusions are made and a successful product prototype can move to the last phase, themed as Define. At this point the final design proposal is made based on all the studies and tests made in previous two phases, and the product specifications and other necessary documents are prepared for the product to be ready for introduction.

The Registered Trademark ERGO™

Each ergonomic Bahco tool is developed by following the Bahco ERGO™ Process thoroughly. The Design Manager of SNA Europe certifies that this process has been correctly followed and that the research for the tool has been performed accordingly. An ERGO™ Diploma is issued for all approved tools, and they are marked with the logo.

Bahco ERGO™ products are continually awarded with the most prestigious Design Awards



Combination Plier



Adjustable Wrench



File Handle



RX Precision Plier



Ratchet 8155-1/2



Pipe Wrench



Superior Handsaw



Scrapers



Side Cutter



Screwdrivers



Ratchet 7755-3/8





Hacksaw Frame 325





Interchangeable Handsaw System

 **Reddot Award:** With a history spanning more than 50 years, the "red dot award: product design" is one of the most important international product competitions.

 **iF Award:** Established in 1953, the iF product design award is today among the most important awards for innovative product design.

 **Japanese Good Design Award:** Since 1957, the Good Design Award has been given to outstanding designs for more than 50 years.

 **Goed Industrieel Ontwerp:** The Good Industrial Design Award, better known under the name of "GIO" is a Dutch award where functionality, originality, respect, innovation and ease of use are of equal importance.

 **Swedish Design Award:** Design S is Sweden's leading design award. Design S singles out creative and innovative solutions in every imaginable area of products, services and environments, regardless of the design field.

 **IDSA:** The Industrial Designers Society of America (IDSA) is the world's oldest, largest, member-driven society for product design, industrial design, interaction design, human factors, ergonomics, design research, design management, universal design and related design fields.

 **Excellent Swedish Design awards:** The Svensk Form/Swedish Society of Crafts and Design verifies and spreads knowledge about good, self-assured Swedish design.

Shop-In-Shop

We have created ideal Bahco shop-in-shop concepts at different locations in our company. This best-in-class show features our wide range of tools, providing inspiration to all our retail distributors and showing how our products ought to be displayed.



www.bahco.com

Check our website to get the most updated information about our products and about us. You can download the pdf version of this catalogue as well as the most updated information of our current ranges.

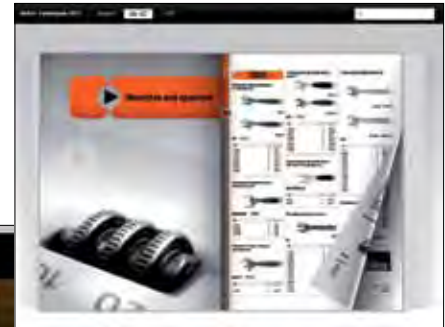

www.bahcoworld.com



Bahco is also present on Social Media, and have created our own discussion platform, Bahco World, with an array of interesting and exciting news and videos.

Follow us on:

Twitter
You Tube
Facebook

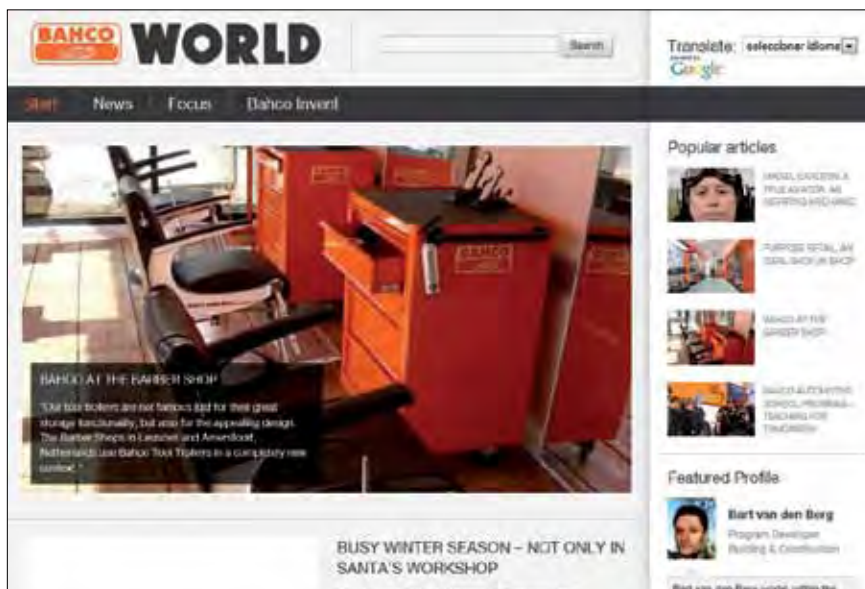



ALPHABETICAL INDEX



ADJUSTABLE WRENCHES	142-148
Insulated adjustable wrenches	885
AIR CUT OFF TOOLS	641
AIR DRILLS	642
AIR GRINDERS	
Die Grinders	637-638
Abrasive wheels	638-640
AIR GUNS	655
AIR HAMMER CHISELS	644-645
AIR HAMMERS	643
AIR RATCHETS	
1/4"	635
3/8"	635-636
1/2"	636
AIR RIVETERS	643
AIR SANDERS	647-649
AIR TOOLS	630-655
AUTO ELECTRIC TOOLS AND EQUIPMENT	
Battery boosters	696-698
Battery testers	699
Socket/plug testers	700-701
AUTOMOTIVE TOOLS & EQUIPMENT	662-709
AXES	1091-1095
BANDSAW BLADES	
Blades	22-30
Bandsaw sawing aids	30-31
BENCH VICES	1073-1076
BEVELS	943
BITS	
Diamond torsion bits 1/4"	369-372
Tin torsion bits 1/4"	373-374
Torsion bits 1/4"	375-377
Extra hard torsion bits 1/4"	377-380
Acr bits 1/4"	380-381
Stainless steel torsion bits 1/4"	382-384
Standard bits 1/4"	385-406
Bits for magazine screwdrivers	407
Bit sets 1/4"	408-418
Bits 5/32"	418
Bits 5/16"	419-420
Bit sets 5/16"	421
Bits 11.2 mm (7/16")	421
BODY SHOP TOOLS AND EQUIPMENT	707-708
BOLT CUTTERS	585
BOWSAWS	
Frames	1012-1014
Blades	1015
BRAKE SYSTEM TOOLS AND EQUIPMENT	
Brake piston tools	687-688
Brake fluid equipment	688



CABINETS	831-832
CABLE CUTTERS	582-584
Insulated cable cutters	881
CALIPERS	947
CAPE CHISELS	1098
CENTRE PUNCHES	1102, 1105
CHALK LINE AND CHALK	942
CHISELS	1098-1099
CIRCULAR SAW BLADES	58-59
CLAMPS	
Quick clamps	1068-1069
Clamps	1069-1072
COLD CHISELS	1098-1101
COPING SAWS	1009
CRANES & ACCESSORIES	714
DRIFT PUNCHES	1103, 1105-1107
DRILLS	
Drills for wood	1052-1055
Masonry drills	1056-1058
HSS drills	1058-1061
Step drills	1061-1062
ELECTRICIANS CHISELS	1101
ELECTRONICS AND PRECISION PLIERS	573-576
ELECTRONICS SPECIALITY TOOLS	
Hooks and picking tools	920
Tuning and trimming tools	921
Other fine mechanical tools	912-922
Mirrors	923-924
Sets for electronics service and electricians	925-927
ENDOSCOPES & ACCESSORIES	736-737
ENGINE TOOLS AND EQUIPMENT	
Spark and glow plug tools	662-665
Piston and piston ring tools	665-666
Exhaust system tools	666
Engine setting tools (timing)	667-677
Clutch tools	677
Cooling system tools	678-679
10 mm bits	679-682
EXTRACTORS	742-761
EYEWEAR/GLASSES	852
FEELER GAUGES	947
FENCING PLIERS	592-593
FILES	
Engineering files	72-84
Needle files	85-91
Diamond files	91-92
Milled tooth files	93-94
Sharpening files	94-103
Chain saw files	103-105



Rasps	106-108
Handles	109-111
Accessories	108-109
FLAT CHISELS	1098
FRET SAWS	1010-1011
GARAGE EQUIPMENT	
Light garage equipment	703-704
Grease/lubrication tools & equipment	705-706
GLOVES	852-853
GOUGES	1026
GRASS SHEARS	1165-1166
GRAVITY CLAMP	1072
GRINDING STONES	1027,1173
GRIP AND WELDING PLIERS	586-591
HAMMERS	
Woodworking and construction	1082-1084
Metal working and industrial	1084-1086
Instrument and workshop	1086-1090
HAND HACKSAWS	
Frames	982-985
Blades	986-988
Insulated frames	892
HANSAWS	
Handsaw with interchangeable blades	989-993
Superior™ handsaws	993-995
Profcut™ handsaws	996-1003
Prizecut™ handsaws	1004-1005
Other handsaws	1006-1007
HEDGE SHEARS	1161-1164
HEXAGONAL KEYS	509-519
HOES	1113
HOLESAWS AND ACCESSORIES	
Holesaws	36-38
Holesaw accessories	39-41
Holesaw sets	42-48
HYDRAULIC & LIFTING EQUIPMENT	714-723
IMPACT TOOLS	
Impact tools for square drives 1/4"	340-341
Impact tools for square drives 3/8"	341-343
Impact tools for square drives 1/2"	344-352
Impact tools for square drives 3/4"	353-358
Impact tools for square drives 1"	358-362
Impact tools for square drives 1.1/2"	363-368
IMPACT WRENCHES	
3/8"	630
1/2"	631-632
3/4"	633
1"	633-634
Impact wrench accessories	634
INSPECTION TOOLS	736-738



INSULATED TOOLS	
ERGO™ screwdrivers	858-862
TEKNO+ screwdrivers	863-866
800 series screwdrivers	867-869
Premium screwdrivers	870-873
600 series screwdrivers	874
Pliers	875-884
Wrenches	885-888
Sockets & accessories	889-890
Other insulated tools	891-893
Protective equipment	894-895
Insulated tool sets	896-897
JACKS & ACCESSORIES	715-723
JIGSAW BLADES	56-57
KNIVES	1044-1048
Insulated knives	892
LAMPS	
Cordless	728-730
Corded	730-731
LEVELS	940-941
LONG TAPES	937-938
LOPPERS	1151-1157
MASON'S CHISELS	1099
MASONRY TROWELS	965-968
MASON'S PIN	1109
MAULS	1095
MEASURING TAPES	936-938
MEASURING WHEELS	939
METAL SHEARS	1032-1041
MITRE BOX	1008
OIL SERVICE TOOLS AND EQUIPMENT	
Draining & refilling equipment	683-685
Filter tools	685-687
PAINT GUNS	651
PENCILS	945
PICK AXES	1097
PIN PUNCHES	1107-1108
PIPE TOOLS	
Tube reamers	614-615
Special pipe wrenches	615
Plumbing wrenches	615-616
Chain pipe wrench	616
Flaring tools	617
PIPE WRENCHES	606-609
PLASTERBOARD TOOLS	
Plasterboard lifter	963-964
Setting tools	970
Trim cutters	970
Punching tools	971
PLASTERER'S RAILS	969



ALPHABETICAL INDEX



PLASTIC CUTTERS	613
PLIERS	
Side cutters	540-546
End cutters	546
Combination pliers	547-551
Snipe nose pliers	552-555
Snipe nose pliers, bent tip	556-559
Machinists pliers	559
Flat nose pliers	560-564
Round nose pliers	564-566
Fine mechanical cutters and pliers	569-572
Circlip pliers	577-582
Plier sets	598-599
Wire twisting pliers	600
Insulated pliers	875-880
PLUMB BOB	942
PNEUMATIC ACCESSORIES	652-654
PNEUMATIC MARKERS	646
POINTED CHISELS	1100
POLES	1160
POWER HACKSAW BLADES	32-35
PRUNING KNIVES	1166
PRUNING SAWS	1168-1172
PRUNING SCISSORS	1167
PRY BARS	762-763
PULLERS	742-761
RAKES	1113
RECIPROCATING SAWBLADES	49-55
RECIPROCATING SAWS	641
RIVETING TOOLS	600-601
ROOFING CLAMP	1072
ROTARY BURRS	
Tungsten carbide rotary burrs	112-123
HSS rotary burrs	124-131
Brushes	132
RULES	939
SCISSORS	1042-1043
Insulated scissors	891
SCRAPERS	952
SCRAPERS, DRY WALL	
Paint scrapers	956-958
Cabinet scrapers	955-956
Filling scrapers	958-959
Glue comb scrapers	959-960
SCREWDRIVERS	
ERGO™ series	434-449
TEKNO+ series	450-465
800-series	466-474
Premium series	475-487
600-series	488-493



9000-series	494-495
8000/9000 series	495
Ratcheting screwdrivers	496-498
Precision screwdrivers	499-502
Electronic screwdrivers	502
T-handle screwdrivers	503-505
Special screwdrivers	506-508
Offset screwdrivers	509-526
Insulated screwdrivers	858-874
SCRIBERS	945-946
SECATEURS	1134-1147
SHOVELS	1112
SLIP JOINT PLIERS	594-598
Insulated slip joint pliers	884
SLITTING CHISELS	1099
SMALL GARDEN TOOLS	1114-1118
SNIPS	1145-1146
SOCKETS AND ACCESSORIES	
Sockets 1/4"	202-207
Socket drivers 1/4"	207-210
Accessories 1/4"	210-217
Socket sets 1/4"	218-226
Sockets 3/8"	227-232
Socket drivers 3/8"	232-235
Accessories 3/8"	235-244
Socket sets 3/8"	244-248
Sockets 1/2"	249-253
Socket drivers 1/2"	254-257
Accessories 1/2"	258-269
Socket sets 1/2"	269-277
Insulated sockets and accessories 1/2"	889
Sockets 3/4"	277-278
Accessories 3/4"	279-284
Socket sets 3/4"	284-285
Sockets 1"	286
Accessories 1"	287-289
Socket sets 1"	289-291
Socket sets	291-307
SOLDERING TOOLS	915-919
SQUARES	944-945
STETHOSCOPE	738
SUSPENSION TOOLS AND EQUIPMENT	
Strut spring compressors	694-695
Miscellaneous	695
TOOL BOXES	833-843
TOOL HOLDERS	770-781
TOOL KITS	844-846
TOOL MODULES	791-825
TOOL TROLLEYS	782-790



TOP PRUNERS	1158-1160
TORQUE TOOLS	
Torque wrenches	312-321
Torque screwdrivers	322-328
Angle meters	329
Torque multipliers	329-330
TORX® KEYS	519-526
TRANSMISSION AND WHEEL TOOLS	
Auto specific sockets	689-691
Torsion bars	691-692
4-way wheel wrenches	692
Wheel bearing tools	693
Axle joint tools	693
Tyre levers	694
TROWELS	960-963
TUBE CUTTERS	611-612
TUBER BENDERS	610
TWEEZERS	900-914



WAD PUNCHES	618-620
WEDGES	1096-1097
WIRE STRIPPERS	566-569
WOOD CHISELS	1020-1026
WORKBENCHES	826-830
WRECKING BARS	1109
WRECKING KNIFE	1026
WRENCHES	
Adjustable wrenches	142-148
Combination wrenches	149-157
Ratcheting wrenches	158-165
Open end wrenches	166-174
Ring end wrenches	175-179
Flare nut wrenches	180-181
Heavy duty wrenches	182-186
Tubular wrenches	187-193
Hook wrenches	194
Insulated wrenches	885-887



ELECTRONICS AND FINE MECHANICAL PLIERS	
Rx series	1188-1195
Heavy duty cutter	1196
Plastic cutter	1196
80-series	1197-1201
Supreme-series	1201-1206
Multipurpose shear	1206
ELECTRONICS AND FINE MECHANICAL TWEEZERS	
Soft touch tweezers, ESD-safe	1207
High precision tweezers	1207-1213



General purpose tweezers	1213
Strong precision tip tweezers	1214
Precision component handling tweezers	1215
Boley style tweezers	1215-1216
Tweezers with fibre tips	1216-1217
Tweezers with replaceable carbon fibre tips	1217-1219
Replacement tips	1219-1220
SMD tweezers	1220-1222
Tweezer sets	1223-1224
TORQUE SCREWDRIVERS	1225

MACHINE ACTUATED SAWS

PRECISION TOOLS YOU CAN RELY ON

In 1969 Bahco pioneered a new technique that combined the best characteristics of tough spring-steel and wear-resistant high-speed steel. The two materials are welded together in a high-vacuum environment. The teeth are milled from the high-speed steel, with the spring-steel providing excellent flexibility.

Bahco machine-actuated saws offer optimum cutting characteristics, long life and fast-cutting operation. Our flagship product, Sandflex® 'the unbreakable blade', is the clear choice where productivity, cost-per-cut, safety and environmental aspects are considered.

In this chapter you will find our full Bahco machine-actuated saw range, including bandsaws, power hacksaws, holesaws, reciprocating saws, jigsaws and circular saws.

Chapter Index

BANDSAW BLADES	22-30
BANDSAW SAWING AIDS	30-31
POWER HACKSAW BLADES	32-35
HOLESAWS	36-38
HOLESAW ACCESSORIES	39-41
HOLESAW SETS	42-48
RECIPROCATING SAWBLADES	49-55
JIGSAW BLADES	56-57
CIRCULAR SAW BLADES	58-59

BANDSAW

Continuous improvement and investment in research and development has led to innovative, high-performance products for general-purpose and production cutting applications. We offer many patented products and features, from our unique Easy Cut design which simplifies complex blade selection, to the latest 'set' and 'unset' high performance carbide blades for the most demanding and complex cutting applications - such as commercial and military aerospace, power generation and other high-technology industries.

In this chapter, we have included terminology, tooth-pitch selection tables, speed selection data, tooth-shape guides, for both bi-metal and carbide blades.

We have also provided some tips on troubleshooting, and assorted cutting aids

used by our users involved in production cutting applications. This includes our patented BandCalc™ programme which is designed to give you advice on blade selection by providing data on machine type, material shapes and sizes.

Quality is our number one priority - and product consistency is part of that priority. This is achieved through Bahco's quality forward system, which is frameworked under ISO 9001- 2000.

We strive to continuously improve our quality management system, focussing on customer needs and satisfaction. Continuous improvement is fundamental to our production processes. We believe that making improvements every day helps us to continuously develop our products.

BI-METAL BANDSAW BLADE

High-speed steel tooth tips, combined with flexible alloy-steel backing material results in the most cost effective bandsaw blades for most metal sawing applications.

Bi-metal bandsaw blades cover most market requirements, including multi-purpose blades and contour cutting, cutting tubes and profiles, foundry cutting and production cutting.

The Sandflex® bandsaw blades cut different types of steel (structural, machining, quenched, tempered, high speed, nitriding) as well as brass, copper, nickel, cast iron, titanium and many other materials.



CARBIDE BANDSAW BLADE

High-performance backing steel and optimized carbide grades yield premium band sawing performance. These products cut faster and last longer than any other bandsaw blade in a wide variety of sawing applications.

Specially designed for the high-efficiency cutting of difficult and abrasive materials, and the high-performance cutting of large and difficult to cut work pieces.



EASY CUT

EASY TO USE

Our patented anti-tooth-stripping design creates a blade that lasts longer, and will not strip teeth like other blades, allowing the operator to spend more

time cutting and less time changing saw blades. Choose Easy Cut for all general purpose bandsaw applications - the choice is easy.

EASY CUT BLADES CUT ALMOST ANYTHING WITHOUT CHANGING BLADES

- Tool steel
- Mid Steel
- Stainless steel
- Aluminium
- Copper
- Brass
- Wood
- Plastic
- Sheet metal
- Tubing
- Solids
- Bundles
- Pipe
- Channel
- Angle Iron
- I Beams
- H Beams
- Drill Rods

EASY TO ORDER

Simply specify blade width and length. The unique patented tooth design cuts any shape or size in virtually any material, while eliminating the need to specify pitch or tooth form.

Choose S (Small), M (Medium) or L (Large), depending on the cutting range you need.



EASY CUT – Cutting data

Order Code	Blade Size Width x Thickness	Material Size (mm)										
		1	2	3	5	10	20	30	40	50	75	100
3857-13-0.6-EZ-S	13 x 0.6	[Color-coded bar chart showing cutting range for 13x0.6mm blade]										
3857-13-0.6-EZ-M	13 x 0.6	[Color-coded bar chart showing cutting range for 13x0.6mm blade]										
3857-13-0.6-EZ-L	13 x 0.6	[Color-coded bar chart showing cutting range for 13x0.6mm blade]										
3857-20-0.9-EZ-S	20 x 0.9	[Color-coded bar chart showing cutting range for 20x0.9mm blade]										
3857-20-0.9-EZ-M	20 x 0.9	[Color-coded bar chart showing cutting range for 20x0.9mm blade]										
3857-20-0.9-EZ-L	20 x 0.9	[Color-coded bar chart showing cutting range for 20x0.9mm blade]										
3857-27-0.9-EZ-S	27 x 0.9	[Color-coded bar chart showing cutting range for 27x0.9mm blade]										
3857-27-0.9-EZ-M	27 x 0.9	[Color-coded bar chart showing cutting range for 27x0.9mm blade]										
3857-27-0.9-EZ-L	27 x 0.9	[Color-coded bar chart showing cutting range for 27x0.9mm blade]										
3857-34-1.1-EZ-S	34 x 1.1	[Color-coded bar chart showing cutting range for 34x1.1mm blade]										
3857-34-1.1-EZ-M	34 x 1.1	[Color-coded bar chart showing cutting range for 34x1.1mm blade]										
3857-34-1.1-EZ-L	34 x 1.1	[Color-coded bar chart showing cutting range for 34x1.1mm blade]										

Within any size range
Small = Good surface finish
Medium = Good band life
Large = Speed of cut

TERMINOLOGY

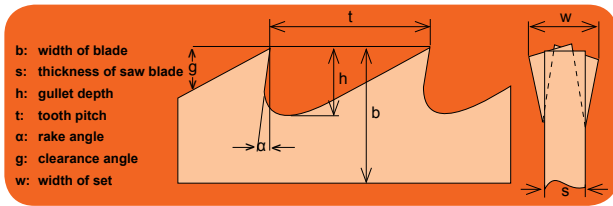

Types of Set

The set is the tilt, or angle, given to the teeth of the saw blade to provide clearance for the blade body and the tooth edges. Below are different types of set:



Raker Set

This is where one tooth is set to the left, one tooth is set to the right, and one tooth (raker) is unset. This is used on most evenly-pitched blades, such as regular and hook.

It is also used for contour and friction cutting blades on vertical bandsaw machines.



Combo Set

In the combo set, used on combo toothed blades, a raker (unset) tooth is followed by teeth in a left, right, left, right sequence. This pattern is repeated with each series of teeth starting and ending with the largest tooth in the pattern.

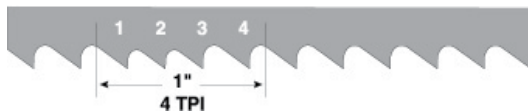

Teeth Per Inch (TPI)

The number of teeth per inch (TPI) defines the pitch of the blade and can vary from less than 1 up to 24.

Thin-walled workpieces like tubes, pipes, sheet etc., require fine teeth, otherwise there can be the risk of tooth damage or breakage. Large cross-sections should be cut with a coarse-pitched saw, i.e. one with fewer teeth per inch. The fewer teeth engaged in the workpiece, the higher the cutting capacity. This is because the penetration of each individual tooth is greater if the saw's feed pressure is distributed over a fewer number of teeth.

A coarse pitch (low TPI) therefore increases productivity and provides a desirable, large chip space.

Soft materials, such as aluminium and bronze, require a large chip space. A coarse pitch prevents the chips from building up and packing together in the gullets, which can impair sawing and damage the blade.

Bandsawing facts

Machine

Check frequently:

- The operation of the chip brush
- The wear and alignment of the guides
- The band tension with a tensionmeter
- The band speed with a tachometer
- The coolant concentration with a refractometer

Coolant / Cutting fluid

The coolant lubricates, cools and carries the chips from the cut.

It is important to:

- Use appropriate cutting fluid
- Use recommended concentration of cutting fluid
- Make sure that the cutting fluid reaches the cut with low pressure and large flow

Workpiece

- Make sure that the workpiece is firmly clamped so that it cannot vibrate or rotate
- Do not use bent or damaged workpieces

Running in

To obtain the maximum blade life always use the recommended band speed but lower the feed rate to 1/3-1/2 during the first 10 minutes of cutting.

During the next 10 minutes increase the feed rate in stages, until you have reached the recommended feed rate.

Tooth protector

Keep the tooth protector on the blade until it is mounted on the machine to avoid premature chipping of the tooth tips.

Feed Rate/Chips

It is important that each tooth of the bandsaw blade cuts a chip with the right thickness. This is determined by the selection of tooth-pitch, band-speed and feed-rate. Start by selecting the right tooth-pitch from the diagrams 'Tooth-pitch for solid workpieces' then set your band speed according to the diagram 'Speed selection'. You can now set the correct feed rate by studying the chips produced by the bandsaw blade when cutting. Use the pictures (below) and adjust your feed rate or band speed accordingly.

For more information on cutting data contact your local Bahco representative who can help you find the correct cutting data for your specific application.

1. Thin or pulverised chips - increase feed rate or lower band speed
2. Loosely rolled chips - correct cutting data
3. Thick, heavy or blue chips - too high feed, lower feed rate or increase band speed

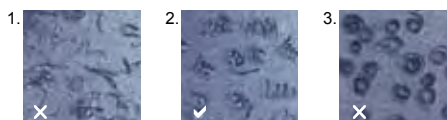

TOOTH PITCH FOR SOLID WORKPIECES

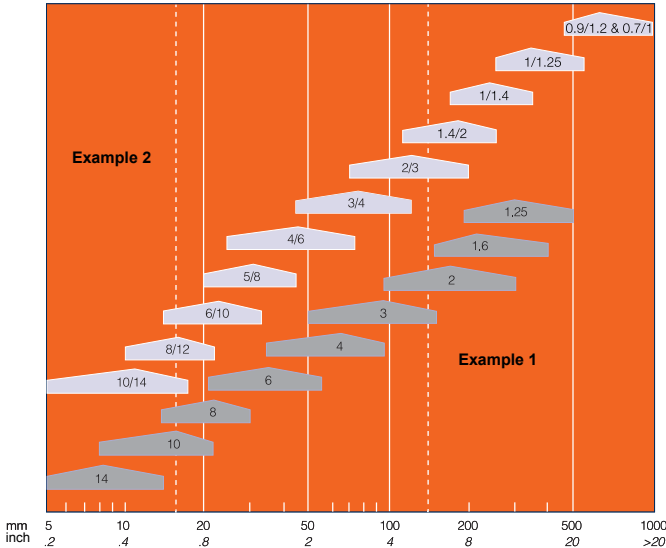

This diagram will help you select the right pitch for cutting solids.

The ideal choice is at the widest point of each field.

Example 1:

When cutting a \varnothing 150 mm (6 inch) bar, use a 2/3 TPI or a 1.4/2 TPI if you choose a variably pitched blade. Use 2 TPI, if an evenly pitched blade is your choice.

Example 2:

If you are sawing in soft materials like plastics, aluminium or wood, choose a pitch two steps coarser than recommended.

When cutting 13-20 mm (1/2-3/4 inch) thick pieces of aluminium, use a 5/8 TPI or a 6 TPI blade.

CUTTING PIPES AND PROFILES

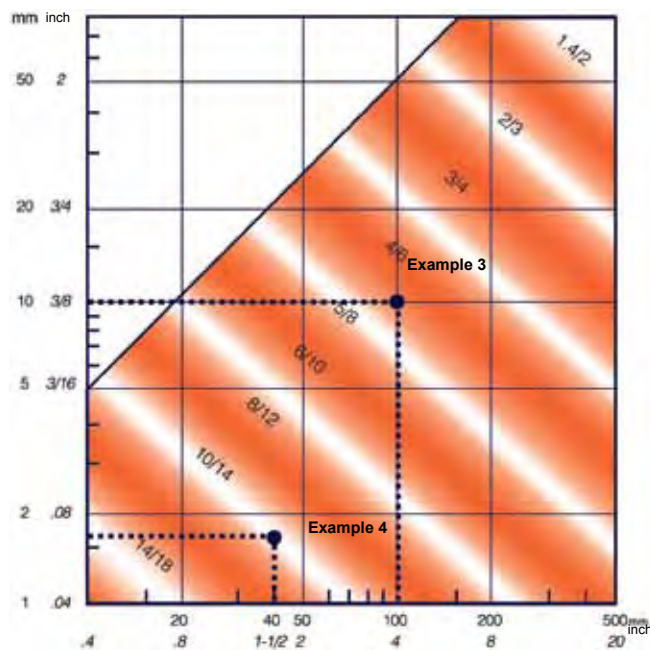

The diagram will help you find the right tooth pitch for cutting pipes and profiles.

The recommended tooth pitch for cutting profiles is found in the field where the width meets the wall thickness of the profile.

Example 3:

When cutting a 100 x 10 mm (4 inch x 0.4 inch) U-beam, select a 5/8 TPI or a 4/6 TPI blade.

The recommended tooth pitch is found in the field where the outer diameter meets the wall thickness of the pipe to be cut.

Example 4:

When cutting a 40 x 1.6 mm (1.5 inch x 0.06 inch) pipe, select a 10/14 TPI blade.

SPEED SELECTION

Material	Meters per minute at Ø mm					Blade Selection					
	10-65	100-300	400-800	>1000	Coolant	3857	3853	3851	3851 PSG	3854 PHG	3854 PQ
1 Structural steels, machining steel	100	85-95	60-75	40-60	6%	+	+	++	+++		
2 Structural steels, quenched and tempered steels	80	70-80	60-68	40-50	6%	+	+	++	+++		
3 Case hardened-, spring steels, quenched and tempered steels	75-100	60-80	45-65	30-40	8%	+	+	++	+++		
4 Unalloyed tool steel, ball and roller bearing steel	60-65	55-60	35-45	25-35	8%			+++	+	++	+++
5 High speed steel	45-50	40-45	30-35	20-25	8%			+++	+	++	+++
6 Cold work tool steel	30-35	25-30	20-25	15-20	DRY			++	+	++	+++
7 Tool steels, alloyed	45-65	45-60	40-60	20-40	8%			++	+	++	+++
8 Nitriding steels, high alloyed hot working steels	40-45	35-40	25-30	20-25	8%			+	+	++	+++
9 Cast iron	50-60	45-50	30-40	25-30	DRY			+	+	++	+++
10 Rust and acid-resistant steels (light)	40-45	40-45	35-40	30-40	10%			+	++	+++	+++
11 Rust and acid-resistant steels (heavy)	35-40	30-35	20-30	19-22	10%			+	++	+++	+++
12 Duplex and heat resistant steels	25-30	20-25	15-20	14-16	10%			+	++	+++	+++
13 Nickel and nickel-cobalt alloys	15-20	13-15	10-12	10	10%			+	+	++	+++
14 Titanium, titanium alloys; aluminium bronze	30-35	25-30	20-25	16-18	10%			+	+	++	+++
15 Horizontal machines, aluminium, aluminium alloys	120	120	120	120	25%			+++	+	+	+
16 Vertical machines, aluminium, aluminium alloys	3000	2100-2500	1250-2000	500-1200	25%			+++	+	+	+
17 Brass	120	120	90-120	80-100	4%			+++	+	++	
18 Copper	120	110	80-100	60-80	15%			+++	+	++	

The bigger the size, the lower the speed

Good + Better ++ Best +++

Material	Meters per minute at Ø mm					Blade Selection					
	10-65	100-300	400-800	>1000	Coolant	3868 TSX	3868 TSS	3881 THQ	3881 THS	3860 TMC	3869 TS
1 Structural steels, machining steel	200	160-190	110-150	60-90	12%	+					
2 Structural steels, quenched and tempered steels	140	120-140	85-115	50-70	12%	+					
3 Case hardened-, spring steels, quenched and tempered steels	120-130	110-120	75-110	40-60	10%	+					
4 Unalloyed tool steel, ball and roller bearing steel	100-120	90-100	60-90	40-50	10%	+					
5 High speed steel	100-110	80-90	60-75	50-60	10%	+	+	+	+	+	
6 Cold work tool steel	80-100	60-90	60-75	45-65	DRY	++		++	+	+	
7 Tool steels, alloyed	85-95	80-90	60-70	50-60	8%	++	++	+	+	+	
8 Nitriding steels, high alloyed hot working steels	75-85	70-80	60-70	45-60	8%	++	+				
9 Cast iron	90-105	90-95	60-75	40-55	12%	++	+				
10 Rust and acid-resistant steels (light)	80-110	80-100	70-95	65-80	12%	++	+++	+++	+++	+++	++
11 Rust and acid-resistant steels (heavy)	80-90	70-80	60-70	40-50	13%	++	+++	+++	+++	+++	++
12 Duplex and heat resistant steels	100-115	80-100	65-80	50-60	12%	++	+++	+++	+++	+++	++
13 Nickel and nickel-cobalt alloys	30-40	25-30	20-28	15-20	12%	++	+++	+++	+++	+++	++
14 Titanium, titanium alloys; aluminium bronze	50-60	40-50	35-45	16-18	12%	++		+++		+++	++
15 Horizontal machines, aluminium, aluminium alloys	250	250	250	250	25%	+	+	+	+	+++	++
16 Vertical machines, aluminium, aluminium alloys	5000	4000-5000	3000-4000	2000-3000	25%					+++	++
17 Brass	250	250	180-240	140-160	4%		++		+++		
18 Copper	240	220	130-190	100-120	15%		++		+++		

The bigger the size, the lower the speed

Good + Better ++ Best +++

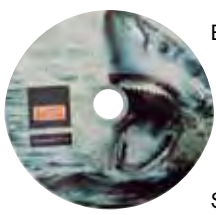

BandCalc™ is an interactive computer software program, available on CD, that quickly determines the best blade for a specific application, based on the user's requirements, the material to be cut, the machine, workpiece etc.

Simply select the blade, and information on blade-speed and feed-rate will be supplied. It is an excellent tool for anyone looking to improve efficiency. It also calculates the cost per cut for you, taking into consideration all factors, including the machine cost. BandCalc™ is available in 10 languages.



The new Bandsaw Speed & Feed Selector is a good guide to select the correct speed and feed. There is one for Bi-metal- and one for cutting with carbide blades. Please contact your local Bahco representative.

TROUBLE SHOOTING CHART

	Important Facts	Band breakage	Crooked sawing	Tooth breakage	Rough surface	Rapid tooth wear	Vibration	Band slips on wheel
MACHINE	Guides and Guidearms You should check and adjust guides regularly. Check if worn out and replace if necessary. Position guidearms as close to work piece as possible.	Guides worn out or guide setting too wide	Guides too far apart, worn out, or poorly adjusted guidearm loose				Guides poorly adjusted	
	Band Wheels The band wheels have to be kept in good condition and properly aligned.	Band wheels worn or too small - try thinner bands						Driving wheel is worn out
	Chip Brush Check that the chip brush is properly adjusted and change it regularly.			Chip brush does not work; gullets filled		Chip brush does not work		
	Band Tension The correct band tension is needed to get a straight cut. Measure with Bahco tensionmeter.	Band tension too high	Band tension too low				Band tension too low	Band tension too low
	Coolant / Cutting Fluid Needed to lubricate and to cool. Check concentration with a Bahco refractometer. Use good coolant. It should reach the cut with low pressure and generous flow.					Too little coolant or incorrect concentration		
CUTTING DATA	Band Speed The band speed has to be chosen correctly. Check the band speed by using a Bahco tachometer.		Band speed too low		Band speed too low	Band speed too high	Natural vibration-band speed slightly high or slightly low	
	Feed Rate The feed rate has to be chosen so that the teeth of the bandsaw blade can work properly.	Feed rate too high	Feed rate too high	Feed rate too high	Feed rate too high	Feed rate too high or too low	Feed rate too high or too low	Feed rate too high
BANDSAW BLADE	Tooth Pitch The selection of the right tooth pitch is just as important as choosing the right feed and speed.		Tooth pitch too fine	Tooth pitch too fine gullets filled	Tooth pitch too coarse	Tooth pitch too fine		
	Tooth Shape Every tooth shape has its ideal application.			Tooth shape too weak		Wrong tooth shape selection	Use combo	
	Running In A new bandsaw blade should be run in to obtain maximum bandsaw lifetime. Never saw in old kerf.					Band not properly run in	Band not properly run in	Band not properly run in
	Blade Life All blades wear out eventually. Look for signs of wear.		Blade worn out			Blade worn out		Blade worn out
WORKPIECE	Surface A bad surface (scale) of the work piece will shorten the life of the blade. Lower the band speed.					Surface defects, i.e. scale, rust, sand		
	Clamping Securely clamp work pieces, especially when bundle cutting. Do not use bent or damaged workpieces.			Workpiece moves			Workpiece not properly clamped	

TOOTH SHAPE GUIDE

BI-METAL



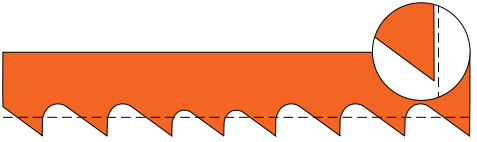
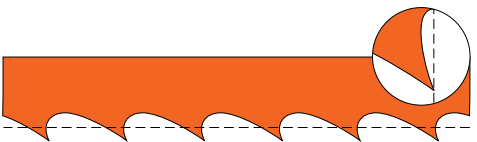
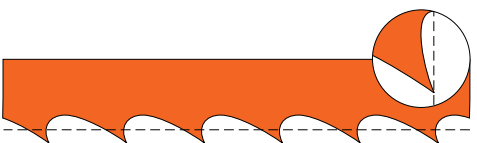
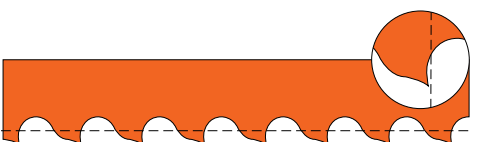
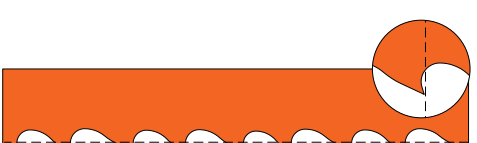
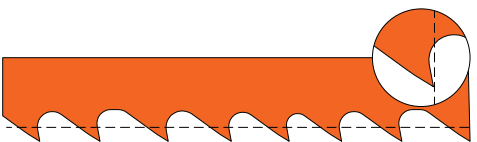
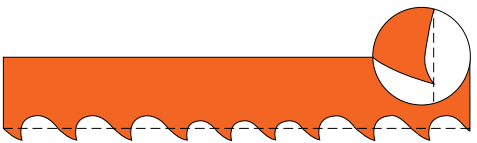
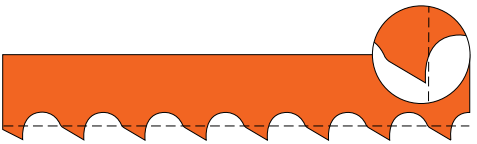
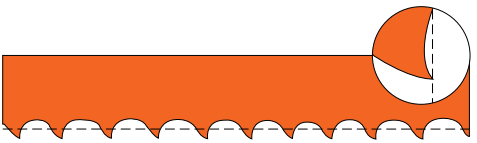
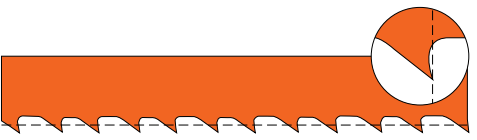

Bahco continuously strives to produce innovative new tooth designs to give maximum band life and efficient cutting.

Combo	Traditional shape tooth with 0° rake angle. Suitable for multi purpose cutting of thin-walled tubes and profiles in most materials.	
Hook	Traditional tooth design with 10° rake angle, used for non-ferrous metals, wood and plastics.	
HA	Development of the traditional Hook design for cutting aluminium in foundry applications.	
PF	Specifically designed for cutting bundles of tubes and profiles with excellent capacity and tool life. Very strong tooth with 6° positive rake angle.	
PQ	Very aggressive 17° positive tooth design intended to give good penetration on difficult to cut material such as stainless steel bearing tube, tool steels and special alloys with work hardening properties. The different set levels produce a multi-chip cutting profile that reduces cutting forces and improves blade life.	
PR	Innovative 'stepped' rake angle giving 10° on 2/3 & 3/4 TPI and 8° on 4/6 and 5/8 TPI. This makes PR a good light production blade cutting small to medium sized workpieces.	
PS	High productivity design with a 10-15° rake angle. A high wedge angle and a large gullet space make it ideal for cutting large workpieces.	
EZ	This tooth shape is used in the Easy Cut blades. The patented design gives a very versatile blade, able to cut all common materials, while being very resistant to tooth stripping. Ideal for small workshops cutting different sizes in a wide range of materials.	
PSG	Combo PSG is a ground tooth shape with positive rake angle. It is the ideal toothshape for production cutting medium and large sections of a wide range of materials and especially on alloyed and stainless steels.	
PHG	Combo PHG is a patented ground tooth shape with positive rake angle for good penetration of large sections of tough-to-cut alloys and work-hardening materials.	

TOOTH SHAPE GUIDE

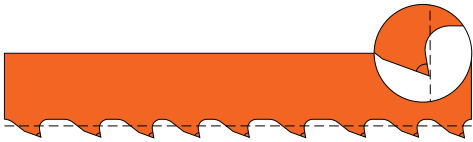
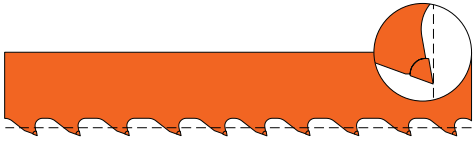
CARBIDE

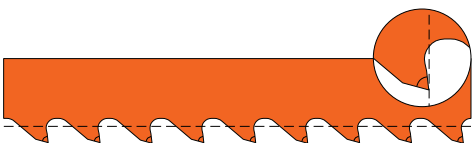
Bahco bandsaw blades offer a comprehensive range of set and unset carbide bandsaw blades to ensure we can meet the demands of our production cutting customers.

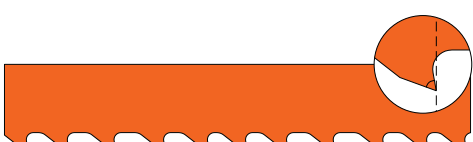
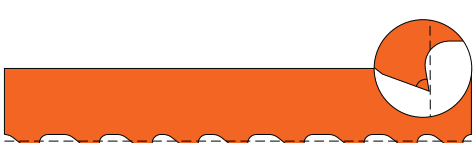
THQ	<p>This multi-chip tooth is designed for cutting Inconel, Waspaloy and titanium. It is wide set as standard, where pinching is a problem and produces seven chips to reduce cutting forces and increase life. Applications in medium to large size materials.</p>	
TMC	<p>This tooth design is used for our unset carbide blade. It has a seven-chip design and excels in difficult to cut alloys on stable machines.</p>	
TMC-W	<p>The same as TMC but with a wider set to avoid pinching particularly Inconels with case hardened surfaces.</p>	
TS	<p>This triple-chip tooth design has a rake angle of 7° and is designed for foundry use but works very well in narrow band applications cutting stainless and high alloy steels.</p>	
TSX	<p>This triple-chip tooth design has a rake angle of 10° and is ideal for cutting large difficult and abrasive materials. The advantage of a set blade is that it is much more forgiving in less stable machines compared with unset blades. This is a unique and patented tooth design.</p>	
TSS	<p>Same design as TSX, but pre "run in" at the factory. Designed to remove the need for running in on the machine allowing full speed / feed operation from the first cut in stainless steel. This is a unique and patented tooth design.</p>	
THS	<p>Same design as THQ, but with an extremely low noise level. Not suitable in titanium applications.</p>	

HOLESAWS DESIGNED FOR PROFESSIONAL USE

Bahco holesaws set the standard in precision, quality, durability and versatility. So no matter what you are cutting through, we have the holesaws and arbors to tackle the job, time after time.

Every aspect of the holesaws are engineered to improve productivity and craftsmanship from the design of the cutting edges to the technologies used to produce the holesaws. The holesaws fit standard portable drills and drill presses.

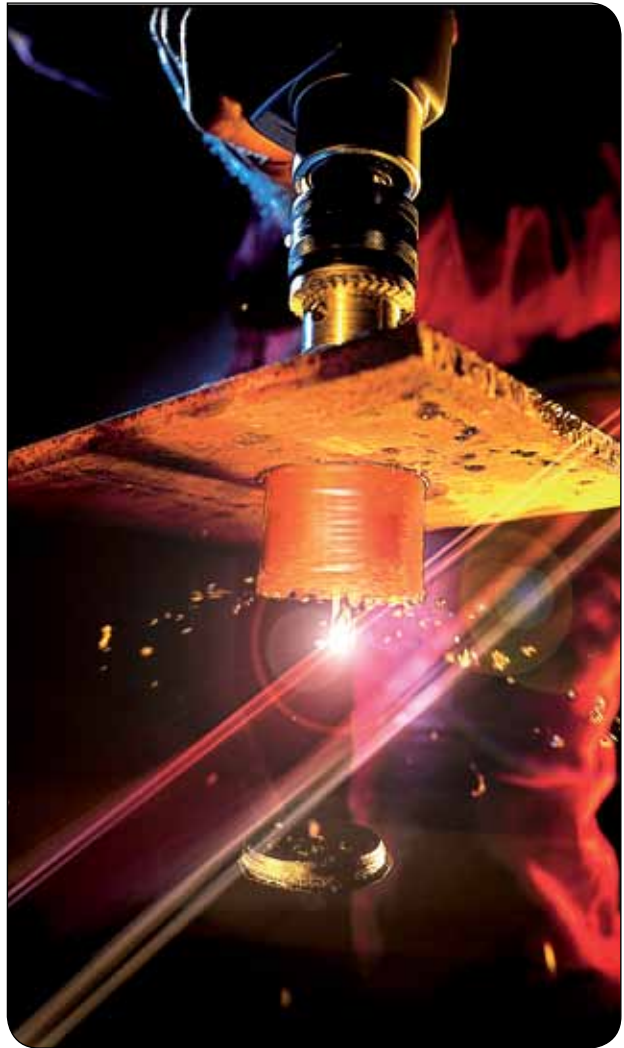

Power Driver™ arbors stabilise the sawing operation and distribute efficiently the cutting forces on the saw.

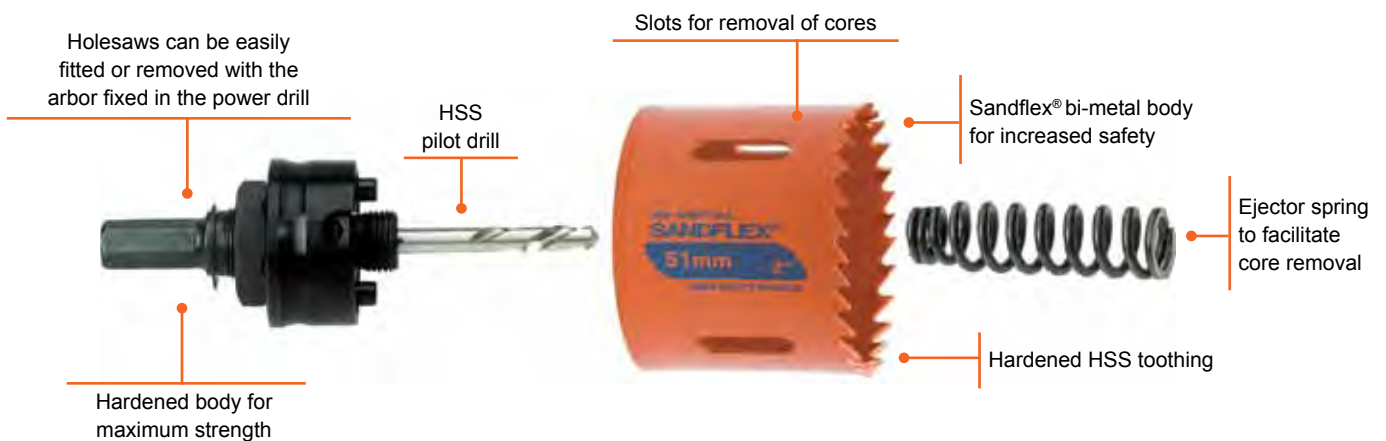

LONG LIFE, FAST CUTS AND REDUCED EFFORT

The true quality of a holesaw is not found in its colour or its packaging, but in the choice of material, the design, the tooth profile and last but not least, the construction of the arbor. On the surface many holesaws may look identical but put them to the test and you will quickly realise that the differences are considerable.

In Bahco's saw laboratory we test every holesaw in the market place. We know where the differences and similarities lie. There is a clear performance limit between professional quality tools and other alternatives that are more suitable for hobby.



SANDFLEX® HOLESAWS

Bahco Sandflex® holesaws have a 4/6 tooth shape. By varying the distance between the teeth (vari-pitch) a smoother cut is achieved with less vibration, even in difficult-to-cut materials.

The aggressive tooth shape cuts fast, whilst the large tooth gullets and large tooth set make removal more efficient.

All VIP holesaws are manufactured from Sandflex® bi-metal steel with hardened teeth of high-alloyed, high-speed steel (HSS). Bi-metal gives increased

safety as it will not shatter even if overloaded. It enables the optimum cutting performance in all machinable materials from wood to stainless steel, and it gives increased resistance to wear.

- Create clean, accurate holes in most machinable materials
- High-speed cutting edge is laser welded to tough steel alloy back
- Knockout holes allow easy core removal
- Diameters from 9/16" to 8.1/4" (14 mm to 210 mm)
- Cutting depth for all diameters is 1 1/2" (38 mm)

CARBIDE HOLESAWS

On carbide-tipped holesaws tooth tips consist of a carbide "round rod" which is fusion welded to the back material. The tip is then ground to its final shape with 5° positive cutting angle.

CT holesaws offer the new capability to cut holes in materials such as light concrete, brick, tile, reinforced plastics and other abrasive, non-ferrous materials.

- Carbide saws cut clean holes in ceramics, brick, slate, laminate, fibreglass, hardwood...
- Knockout holes allow easy core removal
- Diameters from 9/16" to 8.1/4" (14 mm to 210 mm)
- Cutting depth for all diameters is 1 1/2" (38 mm)

HOLESAWS SYSTEM

A complete line of saws, arbors, drive plates and accessories – everything you need to make perfect holes from 9/16" to 8.1/4" (14 mm to 210 mm).

Designed as a fully interchangeable system, this full line of arbors, arbor extensions, pilot drills, drive plates, ejector springs and adapters maximizes the performance and flexibility of Bahco holesaws.

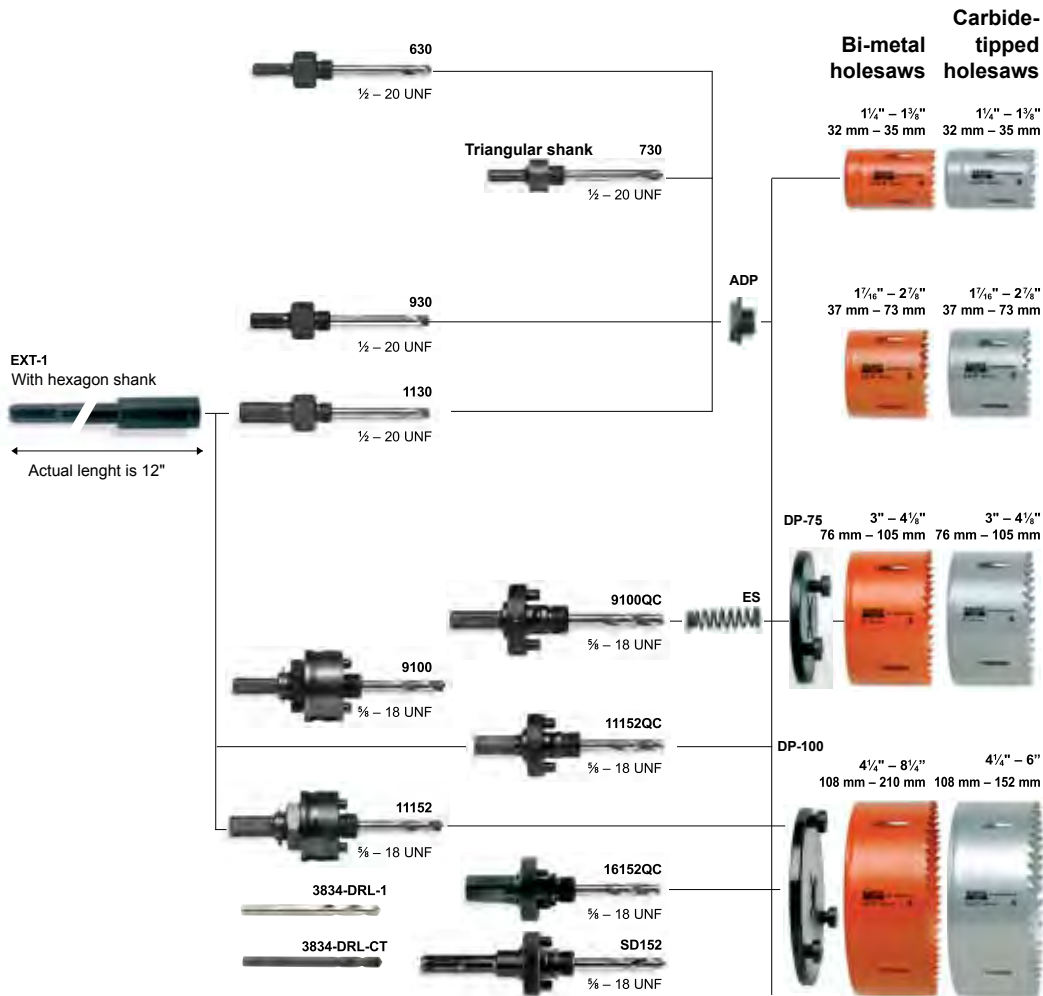

Select an appropriate arbor according to holesaw size and chuck size of drilling equipment.

3834-ARBR-730, for holesaws 14-30 mm, is an arbor with triangular shank and round arbor body. For sturdier design and easier removal of 14-30 mm holesaws select arbors with hexagonal shank and hexagonal body, i.e. 3834-ARBR-630, -930, -1130.

The design of arbors for 32-210 mm holesaws, 3834-ARBR-9100, -11152 and -16152 Power Driver™, eliminates play and increases the strength of the holesaw by redistributing the load from the thread to the solid cap. The Power Driver™ arbors

must be used with hand held machines and when operating with high workload in static machines. QC arbors have a quick-change mechanism so that tools are not required to change holesaws.

All arbors are hardened for maximum strength. Large arbors, for holesaws 32-210 mm, have drive pins to transfer larger cutting force from power unit to the holesaw. We recommend not using arbors with 9 mm (11/32") shank for holesaws above size 100 mm (4"). An HSS Pilot drill (3834-DRL) is included with all arbors. When cutting abrasive materials we recommend the use of carbide-tipped pilot drill, 3834-DRL-CT.

RECIPROCATING SAWBLADES

FAST, ACCURATE AND SAFE CUTTING THROUGH A WIDE RANGE OF MATERIALS

Bahco offers a range of reciprocating sawblades appropriate for every cutting task.

Built using the most advanced alloys and tooth designs, Bahco reciprocating sawblades combine high strength and shatter resistance, with greater cutting power and control. That's why they help you produce faster, cleaner and more accurate cuts, time after time.

Bahco range of reciprocating sawblades is exceptional: with three separate types, each is available in a wide range of designs, lengths and toothings. There is a blade for every application.

PERFECT PERFORMANCE

A professional reciprocating sawblade should not only be strong and easy to use. It should also have ground teeth that deliver a powerful bite for coping with even the most difficult application. Bahco's new generation of reciprocating sawblades easily meets all of these requirements.

Our range offers a wide choice of lengths, designs and toothings, including Sandflex® DSL for building and demolition jobs. The range also includes carbon-steel blades specially designed for wood-cutting and carbide blades for hard, abrasive materials.



Excellent teeth! Reciprocating sawblades in the Bahco range have aggressive, precision-ground teeth. The 3840 Sandflex® DSL, ST, SL and SC Bi-metal blades also feature variable tooth spacing. Every aspect is purpose-designed to achieve unbeatable sawing performance and versatility.

FOR EVERY KIND OF JOB

Whatever the task, you will find the right reciprocating sawblade in our new range - the comprehensive assortment / range professional tools with features that make them the natural choice in virtually any situation.



RECIPROCATING SAWBLADES

A RANGE TO COVER ALL NEEDS

Whatever the task, you'll find the correct reciprocating sawblade in the Bahco range.

	3840 Series	3842 Series	3844 Series	3845 Series	3846 Series
Metal Cutting	●			●	
Nail Embedded Wood	●				
Meat			●		
Pallet	●				
Wood		●			
Tiles					●
Ceramics					●
Glass					●
Regular plastic	●				
Reinforced plastic					●



CHOOSING THE RIGHT RECIPROCATING BLADE

STEP 1: DETERMINE THE RIGHT TOOTHING

Bahco reciprocating sawblades feature aggressive, precision-ground teeth. In addition, many bi-metal blades feature variable teeth spacing. It all adds up to unbeatable sawing performance and versatility. Material type and thickness determine which tooth- ing pattern and TPI will work best.

1. Select material and dimension with the help of the material guide
2. Choose group of toothings (TPIs) which can be used for the application

Material thickness mm	Metal/ Steel	Plastic	Laminates/ Chipboard	Wood	Plaster boards
>50		4/6	4/6	7* 4/6	
20-50	5/8	5/8 6 8 10	5/8 6 8 10	7* 5/8 8 10	5/8 6 8 10
10-20	8/12 14	8/12 14	8/12 14	8/12 14	8/12 14
3-10	18	18	18	18	18
0-3	24	24	24	24	
6		30-35	25-30	20-25	15-20
7		45-65	45-60	40-60	20-40

STEP 2: IDENTIFY AND CHOOSE THE RIGHT BAHCO RECIPROCATING SAWBLADE

Here is how to read product codes for Bahco reciprocating sawblades.

Example: 3840- 150- 14- ST- 5P

- 3840-: Blade material
- 150-: Blade length in mm
- 14-: Teeth Per Inch (TPI)
- ST-: Blade shape
- 5P: Packaging Quantity

Blade shape: ST = Standard; UST = U-shank
SL = Slope; SC = Scroll
DSL = Demolition Slope

Packaging Quantity: 1, 2, 5, 10, 100 depending on product

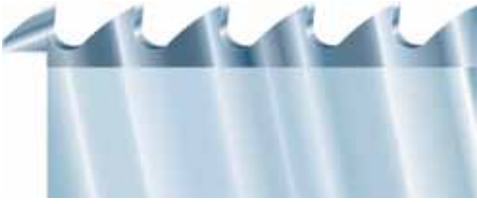

POWER HACKSAWS

HINTS FOR POWER HACKSAWING WITH SANDFLEX® HACKSAW BLADES

- Tension the blade somewhat more than conventional HSS blades. Re-tensioning may be necessary
- Run in a new blade for a few minutes at reduced feed
- Set the right feed by checking the chips. They should be round, fine and spiral shaped. Burned or blued chips mean that the feed is too high
- Thin chips mean that the feed is too low
- Use the recommended coolant
- Make sure that the workpiece is securely clamped
- Choose a wider and thicker blade for steel grades with poor machinability. The material wastage will be somewhat higher, but the risk of crooked kerfs will be reduced
- Never use a new blade to saw in an existing kerf
- Avoid sawing into sharp edges and corners
- Always start the saw with the blade clear of the workpiece. The teeth should not be touching the workpiece when the machine is started
- Keep the machine in good condition

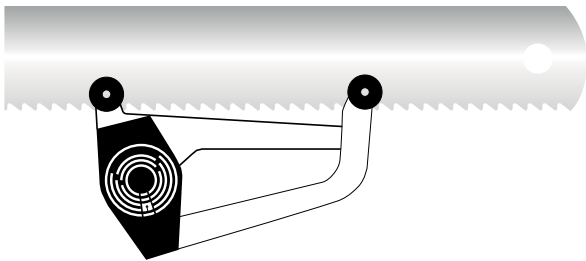

BLADE TENSIONING

Correct blade tension is essential for ensuring a straight kerf and a long useful life of the blade. If the tension is too low, the blade will bend upwards or twist, giving rise to high stresses, heavy wear of the blade and uneven, crooked kerfs. Excessive tension causes high stresses in the blade and saw frame. In such cases, the blade will generally break, but the frame may also be damaged, particularly if a heavy blade is used.

The only reliable way of tensioning the blade is to use the Bahco blade tensionmeter. This is an instrument mounted on the saw blade that measures its elongation when tension is applied.

STROKE RATE

The correct stroke rate for a given job depends on the machinability of the material. For maximum blade life the stroke rate should be low and the

There is a recommended value for every blade.

- Fix the blade in the saw frame with the tooth points facing in the direction of sawing but do not tension the blade
- Check that the blade lies absolutely flat against the blade holder
- Secure the blade-tension gauge to the saw blade
- Turn the tensioning nut until the scale on the blade-tension gauge shows the recommended tension
- If you do not have a blade-tension gauge, follow the blade tensioning recommendations of the manufacturer

feed pressure moderate. As a general rule, harder materials call for a lower stroke rate and higher feed pressure.

FEED

The cutting capacity of a hacksaw depends – among other things – on a combination of feed pressure and stroke rate. Maximizing feed pressure and stroke rate certainly increases capacity, but it also increases the danger of a crooked cut and leads to faster blade wear. Our recommendation is to use a high feed pressure but to reduce the stroke rate.

It is not possible to provide exact feed pressures since conditions vary on different machines. Excessive feed pressure may give rise to tooth stripping, skew cutting and even blade breakage. Insufficient feed pressure may cause the saw teeth to slide on the workpiece without cutting properly, resulting in overheating, softening and abnormally rapid wear.

By studying the workpiece, the blade and the chips, you can often tell whether you have chosen a suitable pressure. Here are some clues: If machine vibration is abnormal, feed pressure is too high.

If the chips are burnt, feed pressure is too high. If tooth cracks appear, feed pressure is too high. Fine, powdery chips indicate that feed pressure is too low.

The teeth may also show signs of overheating and dulling.

Fine curled chips indicate the optimal feed pressure.

A new blade should always be “run in” by sawing with reduced feed pressure for a few minutes to ensure a longer blade life.

MATERIALS AND TOOTHING

Standard Bahco power hacksaw blades are supplied with 4, 6, 8, 10 and 14 teeth per inch (blades for Kasto® machines are also available with 2 and 3 teeth per inch). For power sawing it is particularly important to select the right number of teeth per inch. A useful rule of thumb is that at least three teeth should be engaged at any one time.

Tooth choice will depend on the properties and dimensions of the material to be sawn. Thin stock requires more teeth per inch to prevent them from digging in and being broken off. Soft materials such as aluminium call for large chip spaces, i.e. a large pitch, to prevent the chips from clogging the teeth of the blade and interfering with sawing.



TOOTHING CONVERSION TABLE

Teeth per inch	2	3	4	5	6	8	10	14
Teeth per cm	0,8	1,2	1,5	2	2,5	3	4	6

CHOOSE THE NUMBER OF TEETH ACCORDING TO THE MATERIAL TO BE MACHINED

NUMBER OF TEETH PER INCH AND PER APPLICATION INCH AND CM

Wall thickness, mm**	3802 High Speed 3809 Sandflex®								Cutting speed*
	10 mm	10-40 mm	40-80 mm	> 80 mm					
Easy-to-cut mild steel	14	4	10-6	4-2,5	6-4	2,5-1,5	4-2	1,5-0,8	25-35
Easy-to-cut steel	14	4	10-6	4-2,5	6-4	2,5-1,5	4-2	1,5-0,8	25-35
Tool steel									
Non-alloyed	14	4	10-6	4-2,5	6-4	2,5-1,5	4-3	1,5-1,2	20-30
Alloyed	14	4	10-6	4-2,5	6-4	2,5-1,5	4-3	1,5-1,2	20-30
Alloyed steel	14	4	10-6	4-2,5	6-4	2,5-1,5	4-3	1,5-1,2	20-30
High-speed steel	14	4	10-6	4-2,5	6-4	2,5-1,5	4-3	1,5-1,2	15-25
Stainless steel	14	4	10-6	4-2,5	6-4	2,5-1,5	4-3	1,5-1,2	10-25
Special alloys									
(Ni and Ti)	14	4	10-6	4-2,5	6-4	2,5-1,5	4-3	1,5-1,2	10-20
Cast iron	14	4	10-6	4-2,5	6-4	2,5-1,5	4-3	1,5-1,2	30-40
Copper and bronze	14	4	10-6	4-2,5	6-4	2,5-1,5	4-3	1,5-1,2	40-60
Aluminium	14-10	4-6	10-6	4-2,5	6-4	2,5-1,5	4-3	1,5-1,2	40-60

* Average cutting speed in m/min = stroke rate in strokes/min x 2 x stroke in metres.

** For tubes: wall thickness x 2.

JIGSAWS

WORLD CLASS JIGSAW BLADES FOR PROFESSIONALS

Superb materials

Jigsaw blades are manufactured from carbon steel, high-speed steel or bi-metal. Bi-metal blades provide the toughness of high speed steel with the flexibility of spring steel. The result is a blade that maintains its sharpness longer and withstands immense strain.

Progressive toothing

Progressive toothing is optimal when cutting thin materials. The teeth then become coarser and more effective the further out from the shank allowing thicker material to be processed. The design gives a blade that works extremely well in most work situations.



Orange with black text is a bi-metal/high-speed steel blade for steel and metal.



Black with orange text is a bi-metal/carbon steel blade for wood.



Orange with grey text is a bi-metal blade for wood and metal.



Light grey with black text is a tungsten carbide blade for abrasive materials.

Bahco has jigsaw blades for all saw brands with T-shanks. The colour coding makes it easy to quickly find the right main group.









BANDSAW BLADES

3857 Easy-Cut

MULTI PURPOSE AND CONTOUR CUTTING



- The Easy-Cut is a new generation of General Purpose Bandsaw Blade
- Specially design for cutting ferrous, non-ferrous materials, solids, pipes, profiles or bundles
- New and unique, innovative tooth design, which allows a much wider operating range than a conventional tooth type
- The same blade will cut a much wider range of materials and shapes
- Choose the blade according to your work piece size

	 731151		 mm	 mm	 T _{1/2} "	
3857-13-0.6-EZ-S	8264765	1	13	0.6	S	EZ
3857-13-0.6-EZ-M	8264772	1	13	0.6	M	EZ
3857-13-0.6-EZ-L	8264789	1	13	0.6	L	EZ
3857-20-0.9-EZ-S	8264796	1	20	0.9	S	EZ
3857-20-0.9-EZ-M	8264802	1	20	0.9	M	EZ
3857-20-0.9-EZ-L	8264819	1	20	0.9	L	EZ
3857-27-0.9-EZ-S	8264826	1	27	0.9	S	EZ
3857-27-0.9-EZ-M	8264833	1	27	0.9	M	EZ
3857-27-0.9-EZ-L	8264840	1	27	0.9	L	EZ
3857-34-1.1-EZ-S	8264857	1	34	1.1	S	EZ
3857-34-1.1-EZ-M	8264864	1	34	1.1	M	EZ
3857-34-1.1-EZ-L	8264871	1	34	1.1	L	EZ









3851 Contour

MULTI PURPOSE AND CONTOUR CUTTING



- For cutting various types of materials from aluminium to stainless steels
- Specially designed tooth shapes for maximum cutting performance
- M42 tooth tips provide heat and wear resistance for long blade life
- New stronger tooth design gives maximum cutting performance
- Wide range of tooth styles available to suit many different applications

	 731151		 mm	 mm	 T/P	
3851-6-0.6-H-6	8282707	1	6	0.6	6	Hook
3851-6-0.6-10/14	8180652	1	6	0.6	10/14	Combo
3851-6-0.9-H-6	8282714	1	6	0.9	6	Hook
3851-6-0.9-10/14	8180768	1	6	0.9	10/14	Combo
3851-10-0.6-H-4	8282776	1	10	0.6	4	Hook
3851-10-0.6-H-6	8282806	1	10	0.6	6	Hook
3851-10-0.6-10/14	8182717	1	10	0.6	10/14	Combo
3851-10-0.9-H-4	8282851	1	10	0.9	4	Hook
3851-10-0.9-H-6	8282868	1	10	0.9	6	Hook
3851-10-0.9-10/14	8182823	1	10	0.9	10/14	Combo
3851-13-0.5-10/14	8282813	1	13	0.5	10/14	Combo
3851-13-0.5-14/18	8282790	1	13	0.5	14/18	Combo
3851-13-0.5-R-24	8282820	1	13	0.5	24	Regular
3851-13-0.6-5/8	8183233	1	13	0.6	5/8	PR
3851-13-0.6-6/10	8183240	1	13	0.6	6/10	Combo
3851-13-0.6-8/12	8185572	1	13	0.6	8/12	Combo
3851-13-0.6-10/14	8183271	1	13	0.6	10/14	Combo
3851-13-0.6-H-4	8282745	1	13	0.6	4	Hook
3851-13-0.6-H-6	8282738	1	13	0.6	6	Hook
3851-13-0.9-6/10	8183585	1	13	0.9	6/10	Combo
3851-13-0.9-10/14	8183868	1	13	0.9	10/14	Combo
3851-13-0.9-H-3	8282936	1	13	0.9	3	Hook
3851-13-0.9-H-4	8282943	1	13	0.9	4	Hook
3851-20-0.9-4/6	8183905	1	20	0.9	4/6	PR
3851-20-0.9-5/8	8183929	1	20	0.9	5/8	PR
3851-20-0.9-6/10	8183936	1	20	0.9	6/10	Combo
3851-20-0.9-8/12	8282578	1	20	0.9	8/12	Combo
3851-20-0.9-10/14	8282585	1	20	0.9	10/14	Combo
3851-27-0.9-P-3	8157135	1	27	0.9	3	PS
3851-27-0.9-P-4	8157661	1	27	0.9	4	PS
3851-27-0.9-2/3	8126377	1	27	0.9	2/3	PR
3851-27-0.9-3/4	8126384	1	27	0.9	3/4	PR
3851-27-0.9-4/6	8126391	1	27	0.9	4/6	PR
3851-27-0.9-5/8	8126407	1	27	0.9	5/8	PR
3851-27-0.9-6/10	8126414	1	27	0.9	6/10	Combo
3851-27-0.9-8/12	8160692	1	27	0.9	8/12	Combo
3851-27-0.9-10/14	8165475	1	27	0.9	10/14	Combo









BANDSAW BLADES

3851 Sandflex® Cobra™

BI-METAL PRODUCTION CUTTING



- Specially designed tooth shapes for maximum cutting performance
- New stronger tooth design gives maximum cutting performance
- Tooth styles are related to the different applications

	 731151		 mm	 mm	 T/1"	
3851-34-1.1-P-2	8157715	1	34	1.1	2	PS
3851-34-1.1-P-3	8157753	1	34	1.1	3	PS
3851-34-1.1-2/3	8126476	1	34	1.1	2/3	PR
3851-34-1.1-3/4	8126483	1	34	1.1	3/4	PR
3851-34-1.1-4/6	8126490	1	34	1.1	4/6	PR
3851-34-1.1-5/8	8126506	1	34	1.1	5/8	PR
3851-34-1.1-6/10	8165505	1	34	1.1	6/10	Combo
3851-41-1.3-P-2	8157876	1	41	1.3	2	PS
3851-41-1.3-1.4/2	8211837	1	41	1.3	1.4/2	PR
3851-41-1.3-2/3	8126568	1	41	1.3	2/3	PR
3851-41-1.3-3/4	8126575	1	41	1.3	3/4	PR
3851-41-1.3-4/6	8126582	1	41	1.3	4/6	PR
3851-41-1.3-5/8	8262488	1	41	1.3	5/8	PR
3851-54-1.3-2/3	8163716	1	54	1.3	2/3	PR
3851-54-1.3-3/4	8163723	1	54	1.3	3/4	PR
3851-54-1.3-4/6	8168025	1	54	1.3	4/6	PR
3851-54-1.6-1/1.4	8188542	1	54	1.6	1/1.4	PR
3851-54-1.6-1.4/2	8211431	1	54	1.6	1.4/2	PR
3851-54-1.6-2/3	8126636	1	54	1.6	2/3	PR
3851-54-1.6-3/4	8126643	1	54	1.6	3/4	PR
3851-67-1.6-.7/1	8200909	1	67	1.6	0.7/1	PR
3851-67-1.6-1/1.4	8178840	1	67	1.6	1/1.4	PR
3851-80-1.6-.7/1	8255367	1	80	1.6	.7/1	PR
3851-80-1.6-1/1.4	8197377	1	80	1.6	1/1.4	PR



3851-Sandflex® Cobra™ PSG



BI-METAL PRODUCTION CUTTING

- For production cutting of medium to large sections of various materials, especially alloy and stainless steels
- Specially designed combination of sharp cutting edges for easy penetration
- HSS tooth edge withstands high temperatures
- Precise set for smooth finish
- Ground tooth for precise and consistent tooth height
- Fatigue resistant backing material and M42 tooth tips offer good performance and long life

	 731151		 mm	 mm	 T/P"	
3851-27-0.9-PSG-2/3	8234379	1	27	0.9	2/3	PSG
3851-27-0.9-PSG-3/4	8234386	1	27	0.9	3/4	PSG
3851-27-0.9-PSG-4/6	8236618	1	27	0.9	4/6	PSG
3851-34-1.1-PSG-2/3	8227173	1	34	1.1	2/3	PSG
3851-34-1.1-PSG-3/4	8227180	1	34	1.1	3/4	PSG
3851-34-1.1-PSG-4/6	8232368	1	34	1.1	4/6	PSG
3851-41-1.3-PSG-1.4/2	8236625	1	41	1.3	1.4/2	PSG
3851-41-1.3-PSG-2/3	8227197	1	41	1.3	2/3	PSG
3851-41-1.3-PSG-3/4	8227203	1	41	1.3	3/4	PSG
3851-41-1.3-PSG-4/6	8234577	1	54	1.3	4/6	PSG
3851-54-1.6-PSG-1.4/2	8236632	1	54	1.6	1.4/2	PSG
3851-54-1.6-PSG-2/3	8227210	1	54	1.6	2/3	PSG
3851-54-1.6-PSG-3/4	8227227	1	54	1.6	3/4	PSG

3854-Sandflex® King Cobra™ PHG



BI-METAL PRODUCTION CUTTING

- For high productivity cutting of difficult-to-cut materials. Special design combination of sharp cutting edges for easy penetration in difficult to cut materials
- Harder teeth for longer wear
- Precise set for smooth surface finish
- Ground tooth gives precise and consistent tooth height for consistent chipload
- Fatigue resistant backing material and M42 tooth tips offer the best performance and long life in difficult to cut materials

	 731151		 mm	 mm	 T/P"	
3854-27-0.9-PHG-3/4	8243036	1	27	0.9	3/4	PHG
3854-27-0.9-PHG-4/6	8222673	1	27	0.9	4/6	PHG
3854-34-1.1-PHG-2/3	8243043	1	34	1.1	2/3	PHG
3854-34-1.1-PHG-3/4	8243050	1	34	1.1	3/4	PHG
3854-34-1.1-PHG-4/6	8222598	1	34	1.1	4/6	PHG
3854-41-1.3-PHG-1.4/2	8243067	1	41	1.3	1.4/2	PHG
3854-41-1.3-PHG-2/3	8243074	1	41	1.3	2/3	PHG
3854-41-1.3-PHG-3/4	8243081	1	41	1.3	3/4	PHG
3854-54-1.6-PHG-.7/1	8243654	1	54	1.6	.7/1	PHG
3854-54-1.6-PHG-1.4/2	8243098	1	54	1.6	1.4/2	PHG
3854-54-1.6-PHG-2/3	8243104	1	54	1.6	2/3	PHG
3854-67-1.6-PHG-.7/1	8243678	1	67	1.6	.7/1	PHG
3854-67-1.6-PHG-1/1.4	8249045	1	67	1.6	1/1.4	PHG
3854-67-1.6-PHG-1.4/2	8249052	1	67	1.6	1.4/2	PHG



BANDSAW BLADES

3854-Sandflex® King Cobra™ PQ



BI-METAL PRODUCTION CUTTING

- PQ is a high precision milled bandsaw blade with extreme rake angle for difficult to cut materials
- 17 degree rake angle with patented floating set
- Multi chip performance
- PQ has fatigue resistant backing material and M42 tooth tips offer the best performance and long-life in difficult to cut materials

	 731151		 mm	 mm	 T/P"	
3854-27-0.9-PQ-3/4	0137480	1	27	0.9	3/4	PQ
3854-34-1.1-PQ-2/3	8287276	1	34	1.1	2/3	PQ
3854-34-1.1-PQ-3/4	0135813	1	34	1.1	3/4	PQ
3854-41-1.3-PQ-1.4/2	0129355	1	41	1.3	1.4/2	PQ
3854-41-1.3-PQ-2/3	8280604	1	41	1.3	2/3	PQ
3854-41-1.3-PQ-3/4	8282950	1	41	1.3	3/4	PQ
3854-54-1.6-PQ-.9/1.2	0133857	1	54	1.6	.9/1.2	PQ
3854-54-1.6-PQ-1.4/2	0127092	1	54	1.6	1.4/2	PQ
3854-54-1.6-PQ-2/3	8265137	1	54	1.6	2/3	PQ
3854-54-1.6-PQ-3/4	8282929	1	54	1.6	3/4	PQ
3854-67-1.6-PQ-.9/1.2	0133888	1	67	1.6	.9/1.2	PQ
3854-67-1.6-PQ-1.4/2	0133901	1	67	1.6	1.4/2	PQ
3854-67-1.6-PQ-2/3	8290160	1	67	1.6	2/3	PQ
3854-80-1.6-PQ-.9/1.2	0133895	1	80	1.6	.9/1.2	PQ

3868 Carbide Triple Set® TSX



CARBIDE PRODUCTION CUTTING

- For production cutting of small to large and difficult abrasive materials
- Triple set tooth design with good kerf clearance which will eliminate tooth loss
- Selected carbide tip for wear resistance and durability
- Strong set pattern for good swarf clearance and longer tool life
- Standard widths and thicknesses which fit all types of bandsaw machine without modification

	 731151		 mm	 mm	 T/P"	
3868-34-1.1-TSX-2	8203016	1	34	1.1	2	TSX
3868-34-1.1-TSX-2/3	8255343	1	34	1.1	2/3	TSX
3868-34-1.1-TSX-3/4	8232375	1	34	1.1	3/4	TSX
3868-41-1.3-TSX-1.4/2	8214210	1	41	1.3	1.4/2	TSX
3868-41-1.3-TSX-1.6	8203092	1	41	1.3	1.6	TSX
3868-41-1.3-TSX-2	8203085	1	41	1.3	2	TSX
3868-41-1.3-TSX-2/3	8232382	1	41	1.3	2/3	TSX
3868-41-1.3-TSX-3/4	8232399	1	41	1.3	3/4	TSX
3868-54-1.3-TSX-1.4/2	8214876	1	54	1.3	1.4/2	TSX
3868-54-1.6-TSX-1/1.25	8213114	1	54	1.6	1/1.25	TSX
3868-54-1.6-TSX-1.4/2	8214869	1	54	1.6	1.4/2	TSX
3868-54-1.6-TSX-1.6	8203108	1	54	1.6	1.6	TSX
3868-54-1.6-TSX-2	8207359	1	54	1.6	2	TSX
3868-54-1.6-TSX-2/3	8232405	1	54	1.6	2/3	TSX
3868-54-1.6-TSX-3/4	8270360	1	54	1.6	3/4	TSX
3868-67-1.6-TSX-.7/1	8212865	1	67	1.6	.7/1	TSX
3868-67-1.6-TSX-1/1.25	8213084	1	67	1.6	1/1.25	TSX
3868-67-1.6-TSX-1.4/2	8265496	1	67	1.6	1.4/2	TSX
3868-80-1.6-TSX-.7/1	8212872	1	80	1.6	.7/1	TSX





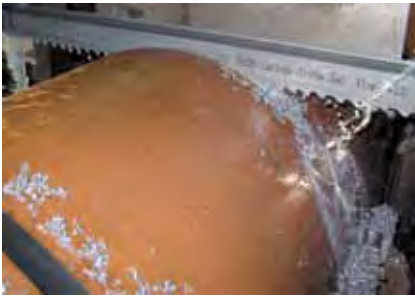



3868 Carbide Triple Set® TSS



CARBIDE PRODUCTION CUTTING

- For production cutting of small to large and difficult abrasive materials
- Triple set tooth design with good kerf clearance which will eliminate tooth loss
- Selected carbide tip for wear, resistant and durability
- Strong set pattern for good swarf clearance and longer tool life
- Standard widths and thicknesses which fit all types of bandsaw machine without modification
- For high efficiency cutting of abrasive materials when vibration is a problem
- TSS is a pre "run in" blade using a patented method eliminating vibration in the first cut
- Suitable for stainless steel applications
- Extremely low noise level







	 731151		 mm	 mm	 T/P"	
3868-41-1.3-TSS-1.4/2	8243142	1	41	1.3	1.4/2	TSS
3868-41-1.3-TSS-2/3	8270643	1	41	1.3	2/3	TSS
3868-54-1.6-TSS-1/1.25	8243173	1	54	1.6	1/1.25	TSS
3868-54-1.6-TSS-1.4/2	8243166	1	54	1.6	1.4/2	TSS

3881 Carbide Multi Set THQ



CARBIDE PRODUCTION CUTTING

- A new Multi Chip design Carbide bandsaw blade for small to medium work pieces in difficult to cut materials
- THQ is specifically for titanium and nickel alloys
- Multi Chip design with 6 tooth pattern and 2 set levels
- High low toothing
- Wide set as standard

	 731151		 mm	 mm	 T/P"	
3881-34-1.1-THQ-2/3	8265793	1	34	1.1	2/3	THQ
3881-41-1.3-THQ-1.4/2	0129447	1	41	1.3	1.4/2	THQ
3881-41-1.3-THQ-2/3	0129454	1	41	1.3	2/3	THQ
3881-54-1.6-THQ-1.4/2	0128860	1	54	1.6	1.4/2	THQ
3881-54-1.6-THQ-2/3	0138739	1	54	1.6	2/3	THQ
3881-67-1.6-THQ-1.4/2	0120369	1	67	1.6	1.4/2	THQ
3881-80-1.6-THQ-1/1.25	0133918	1	80	1.6	1/1.25	THQ



BANDSAW BLADES

3881 Carbide Multi Set THS

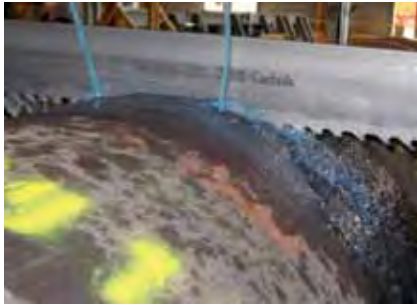

CARBIDE PRODUCTION CUTTING

- A new Multi chip design Carbide bandsaw blade for small to medium work pieces in difficult to cut materials
- THS is primarily for stainless steel
- Multi chip design with 6 tooth pattern and 2 set levels
- High low toothing
- Wide set as standard on “run in” on THS

	 731151		 mm	 mm	 T/P	
3881-41-1.3-THS-1.4/2	8273712	1	41	1.3	1.4/2	THS
3881-54-1.6-THS-1/1.25	8269050	1	54	1.6	1/1.25	THS
3881-67-1.6-THS-1/1.25	8269043	1	67	1.6	1/1.25	THS
3881-67-1.6-THS-1.4/2	0138791	1	67	1.6	1.4/2	THS
3881-80-1.6-THS-.7/1	8279202	1	80	1.6	.7/1	THS

3860 Unset Carbide TMC



CARBIDE PRODUCTION CUTTING

- The intended application areas for the 3860 unset Carbide are:
- Large solids of Inconel with severe scale and internal restraint
- Various grades of titanium in solid form
- Plate sawing of titanium blocks
- Large solids of stainless steel and aluminium

	 731151		 mm	 mm	 T/P	
3860-41-1.3-TMC-1.4/2	0129379	1	41	1.3	1.4/2	TMC
3860-54-1.6-TMC-1/1.25	0154340	1	54	1.6	1/1.25	TMC
3860-54-1.6-TMC-1.4/2-W	0139613	1	54	1.6	1.4/2	TMC-W
3860-54-1.6-TMC-1.4/2	0137978	1	54	1.6	1.4/2	TMC
3860-54-1.6-TMC-2/3	0189366	1	54	1.6	2/3	TMC
3860-67-1.6-TMC-1/1.25	0154364	1	67	1.6	1/1.25	TMC
3860-67-1.6-TMC-1.4/2	0137985	1	67	1.6	1.4/2	TMC
3860-67-1.6-TMC-1.4/2-W	0139620	1	67	1.6	1.4/2	TMC-W
3860-67-1.6-TMC-2/3	0189359	1	67	1.6	2/3	TMC
3860-80-1.6-TMC-.7/1	0154371	1	80	1.6	0.7/1	TMC
3860-80-1.6-TMC-1/1.25	0182336	1	80	1.6	1/1.25	TMC
3860-80-1.6-TMC-1.4/2	0182992	1	80	1.6	1.4/2	TMC









3853 Sandflex® Top Fabricator



CUTTING OF TUBES AND PROFILES

- For cutting of structural steel, tubes and profiles
- M42 HSS tooth material for long tool life
- Special PF tooth shape
- Particularly well suited for mitre (angle) cutting
- 5/8 TPI available for thin walled and single work pieces, as well as bundles







	 731151		 mm	 mm	 TPI	
3853-27-0.9-3/4	8285395	1	27	0.9	3/4	PF
3853-27-0.9-4/6	8183998	1	27	0.9	4/6	PF
3853-27-0.9-5/8	8202118	1	27	0.9	5/8	PF
3853-34-1.1-2/3	8282875	1	34	1.1	2/3	PF
3853-34-1.1-3/4	8184094	1	34	1.1	3/4	PF
3853-34-1.1-4/6	8184087	1	34	1.1	4/6	PF
3853-34-1.1-5/8	8202149	1	34	1.1	5/8	PF
3853-41-1.3-2/3	8282882	1	41	1.3	2/3	PF
3853-41-1.3-3/4	8185770	1	41	1.3	3/4	PF
3853-41-1.3-4/6	8184100	1	41	1.3	4/6	PF
3853-41-1.3-5/8	8202286	1	41	1.3	5/8	PF
3853-54-1.6-2/3	8282899	1	54	1.6	2/3	PF
3853-54-1.6-3/4	8216757	1	54	1.6	3/4	PF
3853-54-1.6-4/6	8222055	1	54	1.6	4/6	PF
3853-67-1.6-2/3	8282905	1	67	1.6	2/3	PF
3853-67-1.6-3/4	8282912	1	67	1.6	3/4	PF

3851 Sandflex® Cobra™ Foundry



FOUNDRY CUTTING

- For cutting non-ferrous and abrasive materials
- Specially designed tooth shapes for maximum cutting performance
- New stronger tooth design gives maximum cutting performance
- Special tooth design for foundry use

	 731151		 mm	 mm	 TPI	
3851-13-0.6-HA-4	8282752	1	13	0.6	4	HA
3851-13-0.6-HA-6	8282561	1	13	0.6	6	HA
3851-13-0.9-HA-4	8281052	1	13	0.9	4	HA
3851-20-0.9-HA-3	8282646	1	20	0.9	3	HA
3851-27-0.9-HA-2	8282677	1	27	0.9	2	HA
3851-27-0.9-HA-3	8282684	1	27	0.9	3	HA









BANDSAW BLADES

3869 Carbide Triple Set®

FOUNDRY CUTTING



- Foundry bandsaw blade for non-ferrous and abrasive materials
- Carbide tipped teeth with triple set configuration
- Fast cutting
- Easy feeding
- Straight and radius cutting
- Special design for foundry use
- For use on smaller machines for difficult to cut materials

	 731151		 mm	 mm	 T/1"	
3869-13-0.9-TS-3	8200589	1	13	0.9	3	TS
3869-20-0.9-TS-3	8177300	1	20	0.9	3	TS
3869-20-0.9-TS-4	8197742	1	20	0.9	4	TS
3869-27-0.9-TS-3	8177348	1	27	0.9	3	TS
3869-27-0.9-TS-4	8182595	1	27	0.9	4	TS
3869-29-1,1-TS-2	8207366	1	29	1.1	2	TS
3869-34-1.1-TS-3	8177355	1	34	1.1	3	TS







BANDSAW SAWING AIDS

3870

BRUSH



- Chip brushes are used to clean the gullet of the bandsaw blade and are vital for optimal performance of the blade
- Manufactured from strong nylon that won't damage the blade
- Code gives the outer & bore diameter in mm

	 731151		 g
3870-BRUSH-60-6	8279523	4	50
3870-BRUSH-80-6	8269906	4	50
3870-BRUSH-80-8	8269890	4	50
3870-BRUSH-80-10	8278311	4	50
3870-BRUSH-100-10	8269876	4	130
3870-BRUSH-100-12	8269883	4	130







3870

TACHOMETER



- Tachometer instantly presents the actual band speed on an LED display
- Measures in m/min & ft/min

	 731151		 g
3870-TACHO METER	8145620	1	400

3870

TENSIONMETER



- The correct tension is critical to provide straight cuts & long blade life, thereby reducing the cost per cut
- Designed for quick, easy, accurate measurement of the blade tension by the user



	 731151		 g
3870-TENSION METER	8145637	1	680

3870

REFRACTOMETER



- Proper coolant concentration is as important as band speed or feed
- Put a drop of coolant on the lens & check the scale
- Always refer to the coolant manufacturers specification to confirm the ratio of coolant

	 731151		 g
3870-REFRACTOMETER	8192129	1	260

3870

BANDCALC™



- BandCalc™ is an interactive software program available on CD
- Determines quickly the best bandsaw blade for a specific application based on the user requirements - material to be cut, machine, work piece etc

	 731151		 g
3870-BANDCALC	8238926	1	45



POWER HACKSAW BLADES

3809

SANDFLEX® BI-METAL

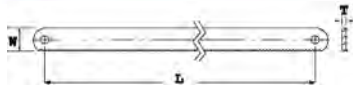

- Suitable for use on any material
- Sandflex® is a virtually unbreakable bi-metal hacksaw blade
- Shatterproof blade that can withstand high feed pressures yet giving accurate, fast cutting rates
- Sandflex® blades are safer to use in all circumstances, especially on old machines or with unskilled operators

	 731151		 T/''	L x W x T mm	 g
3809-300-25-1.25-10	8113711	10	10	300x25x1.25	73
3809-300-25-1.25-14	8113728	10	14	300x25x1.25	73
3809-300-32-1.60-6	8113742	10	6	300x32x1.60	120
3809-300-32-1.60-10	8113735	10	10	300x32x1.60	120
3809-350-25-1.25-6	8113773	10	6	350x25x1.25	88
3809-350-25-1.25-10	8113759	10	10	350x25x1.25	88
3809-350-25-1.25-14	8113766	10	14	350x25x1.25	88
3809-350-32-1.60-4	8113803	10	4	350x32x1.60	145
3809-350-32-1.60-6	8113810	10	6	350x32x1.60	145
3809-350-32-1.60-8	8113827	10	8	350x32x1.60	145
3809-350-32-1.60-10	8113780	10	10	350x32x1.60	145
3809-350-32-1.60-14	8113797	10	14	350x32x1.60	145
3809-350-32-2.00-4	8113841	10	4	350x32x2.00	159
3809-350-32-2.00-6	8113858	10	6	350x32x2.00	159
3809-350-32-2.00-10	8113834	10	10	350x32x2.00	159
3809-350-38-2.00-6	8113889	10	6	350x38x2.00	204
3809-350-38-2.00-10	8113865	10	10	350x38x2.00	204
3809-400-25-1.25-10	8178666	10	10	400x25x1.25	108
3809-400-32-1.60-4	8113919	10	4	400x32x1.60	160
3809-400-32-1.60-6	8113933	10	6	400x32x1.60	160
3809-400-32-1.60-8	8113940	10	8	400x32x1.60	160
3809-400-32-1.60-10	8113896	10	10	400x32x1.60	160
3809-400-32-1.60-14	8113902	10	14	400x32x1.60	160
3809-400-32-2.00-4	8113964	10	4	400x32x2.00	184
3809-400-32-2.00-6	8113971	10	6	400x32x2.00	184
3809-400-32-2.00-8	8114152	10	8	400x32x2.00	184
3809-400-32-2.00-10	8113957	10	10	400x32x2.00	184
3809-400-38-2.00-4	8113995	10	4	400x38x2.00	219
3809-400-38-2.00-6	8114008	10	6	400x38x2.00	219
3809-400-38-2.00-10	8113988	10	10	400x38x2.00	219
3809-425-32-1.60-6	8197759	10	6	425x32x1.60	170
3809-425-32-1.60-10	8114015	10	10	425x32x1.60	170
3809-450-32-1.60-4	8114046	10	4	450x32x1.60	177
3809-450-32-1.60-6	8114053	10	6	450x32x1.60	177
3809-450-32-1.60-10	8114022	10	10	450x32x1.60	177
3809-450-32-1.60-14	8114039	10	14	450x32x1.60	177
3809-450-32-2.00-4	8114077	10	4	450x32x2.00	209
3809-450-32-2.00-6	8114084	10	6	450x32x2.00	209
3809-450-32-2.00-10	8114060	10	10	450x32x2.00	209
3809-450-38-2.00-4	8114114	10	4	450x38x2.00	249
3809-450-38-2.00-6	8114138	10	6	450x38x2.00	249
3809-450-38-2.00-8	8114176	10	8	450x38x2.00	249
3809-450-38-2.00-10	8114091	10	10	450x38x2.00	249
3809-450-45-2.25-4	8114206	10	4	450x45x2.25	358
3809-450-45-2.25-6	8114213	10	6	450x45x2.25	358
3809-475-45-2.25-6	8114237	10	6	475x45x2.25	378
3809-500-38-2.00-4	8114251	10	4	500x38x2.00	304
3809-500-38-2.00-6	8114268	10	6	500x38x2.00	304
3809-500-38-2.00-10	8114244	10	10	500x38x2.00	304
3809-500-45-2.25-4	8114275	10	4	500x45x2.25	398
3809-500-45-2.25-6	8114299	10	6	500x45x2.25	398
3809-500-50-2.50-4	8114312	10	4	500x50x2.50	513
3809-500-50-2.50-6	8114336	10	6	500x50x2.50	513
3809-500-50-2.50-8	8114350	10	8	500x50x2.50	513
3809-525-38-2.00-6	8114374	10	6	525x38x2.00	314
3809-525-38-2.00-10	8114367	10	10	525x38x2.00	314
3809-525-45-2.25-4	8114381	10	4	525x45x2.25	423
3809-525-45-2.25-6	8114398	10	6	525x45x2.25	423
3809-550-45-2.25-4	8114411	10	4	550x45x2.25	433
3809-550-45-2.25-6	8114428	10	6	550x45x2.25	433
3809-550-50-2.50-4	8114435	10	4	550x50x2.50	553
3809-550-50-2.50-6	8114459	10	6	550x50x2.50	553
3809-575-45-2.25-4	8114473	10	4	575x45x2.25	453
3809-575-50-2.50-3	8114602	10	3	575x50x2.50	568
3809-575-50-2.50-4	8114510	10	4	575x50x2.50	568
3809-575-50-2.50-6	8114534	10	6	575x50x2.50	568
3809-600-38-2.00-6	8227579	10	6	600x38x2.00	356
3809-600-45-2.25-4	8172275	10	4	600x45x2.25	478
3809-600-45-2.25-6	8114558	10	6	600x45x2.25	478
3809-600-50-2.50-3	8114565	10	3	600x50x2.50	588
3809-600-50-2.50-4	8114572	10	4	600x50x2.50	588
3809-600-50-2.50-6	8114596	10	6	600x50x2.50	588
3809-650-50-2.50-4	8114657	5	4	650x50x2.50	634
3809-650-50-2.50-6	8114671	5	6	650x50x2.50	634
3809-700-50-2.50-4	8114701	5	4	700x50x2.50	679
3809-700-50-2.50-6	8114725	5	6	700x50x2.50	679
3809-750-50-2.50-4	8114749	5	4	750x50x2.50	690
3809-750-50-2.50-6	8234409	5	6	750x50x2.50	690





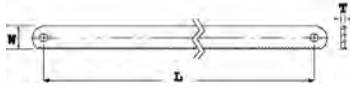

3809 KA

SANDFLEX® BI-METAL FOR KASTO MACHINES



- Designed with holes for KASTO machines
- Suitable for use on any material
- Sandflex® is a virtually unbreakable bi-metal hacksaw blade
- Shatterproof blade that can withstand high feed pressures yet giving accurate, fast cutting rates
- Sandflex® blades are safer to use in all circumstances, especially on old machines or with unskilled operators

	 731151		 T/P	L x W x T mm	 g
3809-400-32-2.00-6-KA	8158248	10	6	400x32x2.00	184
3809-450-38-2.00-4-KA	8114121	10	4	450x38x2.00	249
3809-450-38-2.00-6-KA	8114145	10	6	450x38x2.00	249
3809-450-38-2.00-10-KA	8114107	10	10	450x38x2.00	249
3809-500-45-2.25-6-KA	8114305	10	6	500x45x2.25	398
3809-500-50-2.50-4-KA	8114329	10	4	500x50x2.50	513
3809-500-50-2.50-6-KA	8114343	10	6	500x50x2.50	513
3809-550-50-2.50-4-KA	8114442	10	4	550x50x2.50	553
3809-550-50-2.50-6-KA	8114466	10	6	550x50x2.50	553
3809-575-50-2.50-3-KA	8114503	10	3	575x50x2.50	568
3809-575-50-2.50-4-KA	8114527	10	4	575x50x2.50	568
3809-575-50-2.50-6-KA	8114541	10	6	575x50x2.50	568
3809-575-50-2.50-10-KA	8114497	10	10	575x50x2.50	568
3809-600-50-2.50-4-KA	8114589	10	4	600x50x2.50	588
3809-600-50-2.50-6-KA	8114626	10	6	600x50x2.50	588
3809-650-50-2.50-3-KA	8114640	5	3	650x50x2.50	634
3809-650-50-2.50-4-KA	8114664	5	4	650x50x2.50	634
3809-650-50-2.50-6-KA	8114688	5	6	650x50x2.50	634
3809-700-50-2.50-3-KA	8114695	5	3	700x50x2.50	679
3809-700-50-2.50-4-KA	8114718	5	4	700x50x2.50	679
3809-700-50-2.50-6-KA	8114732	5	6	700x50x2.50	679



POWER HACKSAW BLADES

3802

HIGH SPEED



- Designed for cutting almost any material
- High speed steel hacksaw blade
- Suitable for use on modern machines with skilled operators and a high degree of control

	 731151		 T _{mm}	L x W x T mm	 g
3802-300-25-1.25-6	8143299	10	6	300x25x1.25	73
3802-300-25-1.25-10	8111229	10	10	300x25x1.25	73
3802-300-25-1.25-14	8111236	10	14	300x25x1.25	73
3802-300-32-1.60-6	8111298	10	6	300x32x1.60	120
3802-300-32-1.60-10	8111274	10	10	300x32x1.60	120
3802-350-25-1.25-6	8111359	10	6	350x25x1.25	88
3802-350-25-1.25-10	8111335	10	10	350x25x1.25	88
3802-350-25-1.25-14	8111342	10	14	350x25x1.25	88
3802-350-32-1.60-4	8111410	10	4	350x32x1.60	145
3802-350-32-1.60-6	8111427	10	6	350x32x1.60	145
3802-350-32-1.60-8	8140908	10	8	350x32x1.60	145
3802-350-32-1.60-10	8111397	10	10	350x32x1.60	145
3802-350-32-1.60-14	8111403	10	14	350x32x1.60	145
3802-400-25-1.25-6	8111519	10	6	400x25x1.25	98
3802-400-25-1.25-10	8111496	10	10	400x25x1.25	98
3802-400-25-1.25-14	8111502	10	14	400x25x1.25	98
3802-400-32-1.60-4	8111571	10	4	400x32x1.60	160
3802-400-32-1.60-6	8111588	10	6	400x32x1.60	160
3802-400-32-1.60-8	8111595	10	8	400x32x1.60	160
3802-400-32-1.60-10	8111557	10	10	400x32x1.60	160
3802-400-32-1.60-14	8111564	10	14	400x32x1.60	160
3802-400-38-2.00-4	8111656	10	4	400x38x2.00	219
3802-400-38-2.00-6	8111663	10	6	400x38x2.00	219
3802-400-38-2.00-10	8111649	10	10	400x38x2.00	219
3802-425-32-1.60-6	8111700	10	6	425x32x1.60	170
3802-425-32-1.60-10	8111694	10	10	425x32x1.60	170
3802-450-32-1.60-4	8111755	10	4	450x32x1.60	177
3802-450-32-1.60-6	8111762	10	6	450x32x1.60	177
3802-450-32-1.60-10	8111731	10	10	450x32x1.60	177
3802-450-32-1.60-14	8111748	10	14	450x32x1.60	177
3802-450-38-2.00-4	8111830	10	4	450x38x2.00	249
3802-450-38-2.00-6	8111854	10	6	450x38x2.00	249
3802-450-38-2.00-8	8111878	10	8	450x38x2.00	249
3802-450-38-2.00-10	8111816	10	10	450x38x2.00	249
3802-475-38-2.00-8	8113117	10	8	475x38x2.00	279
3802-500-38-2.00-4	8111960	10	4	500x38x2.00	304
3802-500-38-2.00-6	8111977	10	6	500x38x2.00	304
3802-500-38-2.00-8	8113070	10	8	500x38x2.00	304
3802-500-38-2.00-10	8111953	10	10	500x38x2.00	304
3802-500-50-2.50-4	8112028	10	4	500x50x2.50	513
3802-500-50-2.50-6	8112042	10	6	500x50x2.50	513
3802-525-38-2.00-6	8112097	10	6	525x38x2.00	314
3802-525-38-2.00-8	8112103	10	8	525x38x2.00	314
3802-525-38-2.00-10	8112073	10	10	525x38x2.00	314
3802-550-38-2.00-6	8112158	10	6	550x38x2.00	329
3802-550-50-2.50-4	8112202	10	4	550x50x2.50	553
3802-550-50-2.50-6	8112226	10	6	550x50x2.50	553
3802-550-50-2.50-8	8112240	10	8	550x50x2.50	553
3802-550-50-2.50-10	8112196	10	10	550x50x2.50	553
3802-575-50-2.50-4	8112318	10	4	575x50x2.50	568
3802-575-50-2.50-6	8112332	10	6	575x50x2.50	568
3802-600-50-2.50-4	8112417	10	4	600x50x2.50	588
3802-600-50-2.50-6	8112431	10	6	600x50x2.50	588
3802-600-50-2.50-8	8112455	10	8	600x50x2.50	588
3802-650-50-2.50-4	8112509	5	4	650x50x2.50	634
3802-650-50-2.50-6	8112530	5	6	650x50x2.50	634
3802-700-50-2.50-3	8112585	5	3	700x50x2.50	679
3802-700-50-2.50-4	8112608	5	4	700x50x2.50	679
3802-700-50-2.50-6	8112622	5	6	700x50x2.50	679
3802-700-63-3.00-4	8112646	5	4	700x63x3.00	960
3802-750-50-2.50-4	8112660	5	4	750x50x2.50	730
3802-750-50-2.50-6	8112677	5	6	750x50x2.50	730
3802-750-63-3.00-4	8112684	5	4	750x63x3.00	1030
3802-800-70-3.00-4	8112707	5	4	800x70x3.00	1305
3802-850-70-3.00-4	8112721	5	4	850x70x3.00	1390
3802-950-70-3.00-4	8112745	5	4	950x70x3.00	1590







3802 KA

HIGH SPEED FOR KASTO MACHINES



- Designed with holes for KASTO machines
- Designed for cutting almost any material
- High speed steel hacksaw blade
- Suitable for use on modern machines with skilled operators and a high degree of control

	 731151			L x W x T mm	 g
3802-450-38-2.00-4-KA	8111847	10	4	450x38x2.00	249
3802-450-38-2.00-6-KA	8111861	10	6	450x38x2.00	249
3802-450-38-2.00-8-KA	8111885	10	8	450x38x2.00	249
3802-450-38-2.00-10-KA	8111823	10	10	450x38x2.00	249
3802-500-50-2.50-4-KA	8112035	10	4	500x50x2.50	513
3802-500-50-2.50-6-KA	8112059	10	6	500x50x2.50	513
3802-550-50-2.50-4-KA	8112219	10	4	550x50x2.50	553
3802-550-50-2.50-8-KA	8113315	10	8	550x50x2.50	553
3802-575-50-2.50-3-KA	8112301	10	3	575x50x2.50	568
3802-575-50-2.50-4-KA	8112325	10	4	575x50x2.50	568
3802-575-50-2.50-6-KA	8112349	10	6	575x50x2.50	568
3802-650-50-2.50-4-KA	8112523	5	4	650x50x2.50	634
3802-650-50-2.50-6-KA	8112554	5	6	650x50x2.50	634
3802-700-50-2.50-2-KA	8112578	5	2	700x50x2.50	679
3802-700-50-2.50-4-KA	8112615	5	4	700x50x2.50	679
3802-700-50-2.50-6-KA	8112639	5	6	700x50x2.50	679



3830-VIP

SANDFLEX® BI-METAL



- Sandflex® bi-metal holesaws work excellently in most materials such as wood, plastics, non ferrous and ferrous steel including stainless steel
- Fit all power drills, both stationary and portable
- Knockout holes allow easy removal of cores
- Cutting depth max 38 mm (1 1/2")
- 4/6 teeth per inch
- All -VIP holesaws are packed in a cardboard box with an instruction leaflet enclosed
- Max. holesize = nominal holesaw size +1.5 mm./- 0.0 mm
- Extra large sizes
 - 168 and 210 mm with 6TPI and normal cutting depth
 - 177 mm with 4/6TPI with cutting depth max 50 mm
- All large holesaws cut with 0 degree cutting angle to be less aggressive

	 731151		 mm	 g
3830-14-VIP	8041618	6	14	20
3830-16-VIP	8041625	6	16	20
3830-17-VIP	8041632	6	17	30
3830-19-VIP	8041649	6	19	30
3830-20-VIP	8041656	6	20	30
3830-21-VIP	8041663	6	21	40
3830-22-VIP	8041670	6	22	40
3830-24-VIP	8041687	6	24	55
3830-25-VIP	8041694	6	25	55
3830-27-VIP	8041700	6	27	70
3830-29-VIP	8041717	6	29	70
3830-30-VIP	8041724	6	30	70
3830-32-VIP	8041731	6	32	70
3830-33-VIP	8041748	6	33	70
3830-35-VIP	8041755	6	35	70
3830-37-VIP	8041762	6	37	80
3830-38-VIP	8041779	6	38	80
3830-40-VIP	8041786	6	40	80
3830-41-VIP	8041793	6	41	80
3830-43-VIP	8041809	6	43	90
3830-44-VIP	8041816	6	44	100
3830-46-VIP	8041823	6	46	100
3830-48-VIP	8041830	6	48	100
3830-50-VIP	8260866	6	50	120
3830-51-VIP	8041847	6	51	120
3830-52-VIP	8041854	4	52	120
3830-54-VIP	8041861	4	54	140
3830-55-VIP	8270902	4	55	160
3830-56-VIP	8152703	4	56	140
3830-57-VIP	8041878	4	57	140
3830-59-VIP	8041885	4	59	140
3830-60-VIP	8041892	4	60	160
3830-62-VIP	8234645	4	62	160
3830-64-VIP	8041908	4	64	180
3830-65-VIP	8041915	4	65	180
3830-67-VIP	8041922	4	67	200
3830-68-VIP	8196530	4	68	220
3830-70-VIP	8041939	4	70	220
3830-73-VIP	8041946	4	73	220
3830-76-VIP	8041953	4	76	240
3830-79-VIP	8041960	4	79	260
3830-83-VIP	8041977	4	83	260
3830-86-VIP	8041984	4	86	260
3830-89-VIP	8041991	4	89	270
3830-92-VIP	8042004	4	92	270
3830-95-VIP	8042011	4	95	270
3830-98-VIP	8042028	4	98	300
3830-102-VIP	8042035	4	102	320
3830-105-VIP	8042042	4	105	320
3830-108-VIP	8042059	4	108	350
3830-111-VIP	8042066	4	111	350
3830-114-VIP	8042073	4	114	360
3830-121-VIP	8042080	1	121	410
3830-127-VIP	8042097	1	127	520
3830-133-VIP	8042103	1	133	560
3830-140-VIP	8042110	1	140	560
3830-146-VIP	8042127	1	146	570
3830-152-VIP	8042134	1	152	610
3830-168	8040659	1	168	650
3830-177-HIGH	8101329	1	177	1340
3830-210	8040666	1	210	750







3830-C

SANDFLEX® BI-METAL



- Sandflex® bi-metal holesaws work excellently in most materials such as wood, plastics, non ferrous and ferrous steel including stainless steel
- Fit all power drills, both stationary and portable
- Knockout holes allow easy removal of cores
- Cutting depth max 38 mm (1 1/2")
- 4/6 teeth per inch
- All -C holesaws are packed in a self-service packing with an instruction leaflet that also works as a tooth protector
- Max. holesize = nominal holesaw size +1.5 mm./- 0.0
- All large holesaws cut with 0 degree cutting angle to be less aggressive

	 731151		 mm	 g
3830-14-C	8228347	1	14	22
3830-16-C	8225353	1	16	22
3830-17-C	8228354	1	17	22
3830-19-C	8225360	1	19	30
3830-20-C	8225377	1	20	35
3830-21-C	8228361	1	21	45
3830-22-C	8225384	1	22	55
3830-24-C	8228378	1	24	60
3830-25-C	8225391	1	25	60
3830-27-C	8225407	1	27	60
3830-29-C	8225414	1	29	70
3830-30-C	8225421	1	30	75
3830-32-C	8225438	1	32	75
3830-33-C	8228385	1	33	75
3830-35-C	8225445	1	35	75
3830-37-C	8228392	1	37	75
3830-38-C	8225452	1	38	80
3830-40-C	8228408	1	40	90
3830-41-C	8225469	1	41	95
3830-43-C	8228415	1	43	105
3830-44-C	8225476	1	44	110
3830-46-C	8228422	1	46	115
3830-48-C	8225483	1	48	115
3830-50-C	8260873	1	50	120
3830-51-C	8225490	1	51	120
3830-52-C	8228439	1	52	120
3830-54-C	8225506	1	54	160
3830-55-C	8270919	1	55	160
3830-56-C	8228446	1	56	160
3830-57-C	8225513	1	57	170
3830-59-C	8228453	1	59	170
3830-60-C	8225520	1	60	180
3830-64-C	8225537	1	64	190
3830-65-C	8228460	1	65	190
3830-67-C	8225544	1	67	230
3830-68-C	8228477	1	68	230
3830-70-C	8225551	1	70	250
3830-73-C	8228484	1	73	250
3830-76-C	8225568	1	76	250
3830-79-C	8228491	1	79	250
3830-83-C	8225575	1	83	310
3830-86-C	8228507	1	86	310
3830-89-C	8225582	1	89	350
3830-92-C	8225599	1	92	380
3830-95-C	8225605	1	95	390
3830-98-C	8228514	1	98	420
3830-102-C	8225612	1	102	410
3830-105-C	8225629	1	105	460
3830-108-C	8228521	1	108	460
3830-111-C	8228538	1	111	460
3830-114-C	8225636	1	114	530
3830-121-C	8225643	1	121	600
3830-127-C	8225650	1	127	650
3830-133-C	8228545	1	133	650
3830-140-C	8228552	1	140	650
3830-146-C	8228569	1	146	650
3830-152-C	8225667	1	152	900



3832

HOLESAWS CARBIDE TIPPED



- Carbide tipped holesaws work excellently in everything from bricks, ceramic tiles, laminate, fibreglass and hardwood as well as difficult to cut steel applications
- Fit all power drills, both stationary and portable
- Knockout holes allow easy removal of cores
- Cutting depth max 38 mm (1 1/2")
- 4 teeth per inch
- Max. holesize = nominal holesaw size +1.5 mm./- 0.0 mm

	 731151		 mm	 g
3832-14	8557744	6	14	20
3832-16	8557768	6	16	20
3832-17	8557782	6	17	30
3832-19	8557805	6	19	30
3832-20	8557812	6	20	30
3832-21	8557829	6	21	40
3832-22	8557843	6	22	40
3832-24	8557867	6	24	55
3832-25	8557881	6	25	55
3832-27	8557904	6	27	70
3832-29	8557928	6	29	70
3832-30	8557942	6	30	70
3832-32	8557966	6	32	70
3832-33	8557980	6	33	70
3832-35	8558000	6	35	70
3832-37	8558024	6	37	80
3832-38	8558048	6	38	80
3832-40	8558062	6	40	80
3832-41	8558086	6	41	80
3832-43	8558109	6	43	90
3832-44	8558123	6	44	100
3832-46	8558147	6	46	100
3832-48	8558161	6	48	100
3832-51	8558185	6	51	120
3832-52	8558208	4	52	120
3832-54	8558222	4	54	140
3832-56	8558239	4	56	140
3832-57	8558246	4	57	140
3832-59	8558260	4	59	140
3832-60	8558284	4	60	160
3832-64	8558307	4	64	180
3832-65	8558321	4	65	180
3832-67	8558345	4	67	200
3832-68	8558352	4	68	220
3832-70	8558369	4	70	220
3832-73	8558383	4	73	220
3832-76	8558406	4	76	240
3832-79	8558420	4	79	260
3832-83	8558444	4	83	260
3832-86	8558468	4	86	260
3832-89	8558482	4	89	270
3832-92	8558505	4	92	270
3832-95	8558529	4	95	270
3832-98	8558543	4	98	300
3832-102	8558567	4	102	320
3832-105	8558581	4	105	320
3832-108	8558604	4	108	350
3832-111	8558611	4	111	350
3832-114	8558628	4	114	360
3832-121	8558642	1	121	410
3832-127	8558666	1	127	520
3832-133	8558673	1	133	560
3832-140	8558680	1	140	560
3832-146	8558697	1	146	570
3832-152	8558703	1	152	610



3834-ARBR

ARBORS



3834-ARBR-730



3834-ARBR-930



3834-ARBR-11152 (PD)



3834-ARBR-11152QC

- Arbors for holesaws Ø14-210mm. 3834-ARBR-730, for holesaws Ø14-30mm, with triangular shank and round arbor body
- 3834-ARBR-630, -930, -1130, for holesaws Ø14-30mm, with hexagonal shank and body giving a sturdier design with easier removal of the holesaw
- 3834-ARBR-9100, -11152 and -16152, for holesaws Ø32-210mm, equipped with Power Driver™ that increases the strength and eliminates play of the holesaw by redistributing the load from the thread to the solid cap
- Arbors ending with QC are arbors with quick change mechanism where no tools are needed to change the holesaw
- Large arbors, for holesaws >Ø32 mm, have drive pins to transfer large cutting forces from the holesaw to the power unit
- For retail self-service packaging select the articles ending with -C
- HSS Pilot drill is included with all arbors
- We recommend not to use arbors with 9 mm (11/32") shank for holesaws above size 100 mm (4")
- When cutting in abrasive materials we recommend to select the carbide tipped pilot drill, 3834-DRL-CT

	 731151		 mm	 mm	 mm	
3834-ARBR-630	8015558	1	14-30	6.4	8	70
3834-ARBR-630-C	8228576	1	14-30	6.4	8	70
3834-ARBR-730	8167974	1	14-30	6.4 TRI	8	60
3834-ARBR-730-C	8225674	1	14-30	6.4 TRI	8	60
3834-ARBR-930	8015565	1	14-30	8.5	10	80
3834-ARBR-930-C	8225681	1	14-30	8.5	10	80
3834-ARBR-1130	8015572	1	14-30	11.1	13	90
3834-ARBR-1130-C	8228583	1	14-30	11.1	13	90
3834-ARBR-9100	8015589	1	32-100	8.5	10	250
3834-ARBR-9100-C	8228590	1	32-100	8.5	10	250
3834-ARBR-9100QC	8249830	1	32-100	8.5	10	160
3834-ARBR-9100QC-C	8225704	1	32-100	8.5	10	160
3834-ARBR-11152	8015596	1	32-210	11.1	13	260
3834-ARBR-11152-C	8225698	1	32-210	11.1	13	260
3834-ARBR-11152QC	8167967	1	32-210	11.1	13	250
3834-ARBR-11152QC-C	8225711	1	32-210	11.1	13	250
3834-ARBR-16152	8015602	1	32-210	15.4	20	310
3834-ARBR-16152QC	8453152	1	32-210	15.4	20	300



3834-DRL

PILOT DRILLS

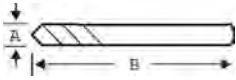

- HSS pilot drill makes a hole in the work piece before the teeth of the holesaw become engaged, guiding and keeping the holesaw in correct position during the sawing operation
- 3834-DRL fits all arbors and is the standard drill in all arbors

	 731151		A mm	B mm	 g
3834-DRL	8234638	1	6.35	81	20

3834-DRL-CT

PILOT DRILLS



- Carbide tipped pilot drill makes a hole in the work piece before the teeth of the holesaw become engaged, guiding and keeping the holesaw in correct position during the sawing operation
- High grade carbide tip with special properties, hardness and geometry
- Specially designed to provide one tool to cover many different materials
- Enables high cutting performance in all machinable material from wood and plastic to brick and concrete
- 3834-DRL-CT fits all arbors

	 731151		A mm	B mm	 g
3834-DRL-CT	8953201	1	6.35	84	35

3834-EXT

ARBOR EXTENSIONS



- For reach in difficult-to-cut surroundings
- EXT-1 fits arbor -1130, -11152, -11152QC
- EXT-2 fits arbor -930, -9100

	 731151		 mm	 mm	 g
3834-EXT-1	8040673	1	11.1	330	340
3834-EXT-2	8168070	1	8.5	330	340



3834-MRS

MORSE TAPER ADAPTORS



- Convert the arbor hexagonal shank to suit Morse taper system on stationary machines
- MRS-3-11 fits arbor -1130, -11152, -11152QC
- MRS-3 fits arbor -16152

	 731151		 g
3834-MRS-3-11	8165130	1	220
3834-MRS-3	8015633	1	220

3834-DP

DRIVE PLATE



- Designed for heavy operation and prevents holesaw drive-pin holes becoming elongated
- DP-75 fits holesaw \varnothing 76-105 mm
- DP-100 fits holesaw \varnothing 108-152 mm

	 731151		 g
3834-DP-75	8018061	1	200
3834-DP-100	8018054	1	400

3834-ES

EJECTOR SPRING



- For pilot drills, to facilitate core removal

	 731151		 g
3834-ES	8454418	1	10

3834-ADP

ARBOR ADAPTOR



- Adapts small arbor thread (1/2"-20 UNF) to accommodate large holesaw thread (5/8"-18 UNF)
- Not recommended for holesaws larger than \varnothing 44 mm
- Fits arbor -630, -730, -930, -1130

	 731151		 g
3834-ADP	8454425	1	20



HOLESAW SETS

3834-42

HOLESAW SETS

- Sandflex® bi-metal holesaw set consisting of popular sizes within the engineering industry, water and sanitation industry and the electrical installation industry



	 731151		 g
3834-SET-42	8241988	1	2025

3830-VIP
51, 76, 86, 111 mm



3834-ARBR-9100 (32-100 mm)
PD type



3834-ES



3834-53

HOLESAW SETS

- Sandflex® bi-metal holesaw set consisting of popular sizes within the engineering industry, water and sanitation industry and the electrical installation industry



	 731151		 g
3834-SET-53	0127153	1	2370

3830-VIP
19, 22, 25, 29, 30, 35, 37, 41, 52, 60, 79 mm



3834-ARBR-930 (14-30 mm)



3834-ARBR-9100 (32-100 mm)
PD type



3834-61

HOLESAW SETS

- Sandflex® bi-metal holesaw set consisting of popular sizes within the engineering industry, water and sanitation industry and the electrical installation industry



	 731151		 g
3834-SET-61	8266431	1	3145

3830-VIP
44, 51, 57, 73, 86, 114 mm



3834-ARBR-9100 (32-100 mm)
PD type





3834-62

HOLESAW SETS



- Sandflex® bi-metal hole saw set consisting of popular sizes within the engineering industry, water and sanitation industry and the electrical installation industry
- Space also prepared for:
3830-16-VIP 16 mm 5/8"
3830-56-VIP 56 mm 2 3/16"

	 731151		 g
3834-SET-62	8228040	1	1050
3830-VIP 19, 21, 22, 29, 38, 48 mm			
3834-ARBR-930 (14-30 mm)			
3834-ARBR-9100 (32-100 mm) PD type			
1 pc.			

3834-62-16/50

HOLESAW SETS



- Sandflex® bi-metal hole saws set consisting EU standard sizes within the electrical installation industry

	 731151		 g
3834-SET-62-16/50	8258887	1	1065
3830-VIP 16, 20, 25, 32, 40, 50 mm			
3834-ARBR-930 (14-30 mm)			
3834-ARBR-9100 (32-100 mm) PD type			
1 pc.			



HOLESAW SETS

3834-65-16/51

HOLESAW SETS

- Sandflex® bi-metal holesaw set consisting of popular sizes within the engineering industry, water and sanitation industry and the electrical installation industry



	 731151		 g
3834-SET-65-16/51	8159900	1	1465

3830-VIP
16, 20, 25, 32, 40, 51 mm



3834-ARBR-930 (14-30 mm)



3834-ARBR-11152 (32-210 mm)
PD type



3834-DRL



1 pc.



3834-65-22/64

HOLESAW SETS

- Sandflex® bi-metal holesaw set consisting of popular sizes within the engineering industry, water and sanitation industry and the electrical installation industry



	 731151		 g
3834-SET-65-22/64	8159917	1	1625

3830-VIP
22, 29, 35, 44, 51, 64 mm



3834-ARBR-930 (14-30 mm)



3834-ARBR-11152 (32-210 mm)
PD type



3834-DRL





3834-72

HOLESAW SETS

- Sandflex® bi-metal holesaw set consisting of popular sizes within the engineering industry, water and sanitation industry and the electrical installation industry



	 731151		 g
3834-SET-72	8044992	1	1080
3830-VIP 19, 22, 29, 35, 44, 51, 64 mm			
3834-ARBR-930 (14-30 mm)			
3834-ARBR-9100 (32-100 mm) PD type			

3834-73

HOLESAW SETS

- Sandflex® bi-metal holesaw set consisting of popular sizes within the the electrical installation industry



	 731151		 g
3834-SET-73	8254339	1	2080
3830-VIP 16, 22, 51, 57, 73, 76, 92 mm			
3834-ARBR-930 (14-30 mm)			
3834-ARBR-9100 (32-100 mm) PD type			

3834-73-22/68

HOLESAW SETS

- Sandflex® bi-metal holesaw set consisting of popular sizes within the the electrical installation industry



	 731151		 g
3834-SET-73-22/68	0134809	1	2170
3830-VIP 22, 29, 35, 44, 51, 64, 68 mm			
3834-ARBR-1130 (14-30 mm)			
3834-ARBR-11152 (32-210 mm) PD type			
3834-DRL			



HOLESAW SETS

3834-86

HOLESAW SETS

- Sandflex® bi-metal holesaw set consisting of popular sizes within the engineering industry, water and sanitation industry and the electrical installation industry



	 731151		 g
3834-SET-86	8224295	1	2540
3830-VIP 25, 32, 35, 51, 54, 76, 92, 114 mm			
3834-ARBR-1130 (14-30 mm)			
3834-ARBR-11152 (32-210 mm) PD type			
3834-DRL			
3834-ADP			

3834-87

HOLESAW SETS

- Sandflex® bi-metal holesaw set consisting of popular sizes within the engineering industry, water and sanitation industry and the electrical installation industry



	 731151		 g
3834-SET-87	8181772	1	1925
3830-VIP 19, 22, 29, 38, 43, 48, 52, 65 mm			
3834-ARBR-930 (14-30 mm)			
3834-ARBR-9100 (32-100 mm) PD type			
3834-DRL			
3834-ES			



3834-92

HOLESAW SETS

- Sandflex® bi-metal holesaw set consisting of popular sizes within the engineering industry, water and sanitation industry and the electrical installation industry



	 731151		 g
3834-SET-92	8044985	1	1440

3830-VIP
16, 22, 25, 29, 32, 41, 51, 73, 83 mm



3834-ARBR-930 (14-30 mm)



3834-ARBR-9100 (32-100 mm)
PD type



3834-94

HOLESAW SETS

- Sandflex® bi-metal holesaw set consisting of popular sizes within the engineering industry, water and sanitation industry and the electrical installation industry



	 731151		 g
3834-SET-94	8166458	1	1815

3830-VIP
16, 19, 22, 25, 30, 35, 41, 51, 67 mm



3834-ARBR-1130 (14-30 mm)



3834-ARBR-11152 (32-210 mm)
PD type





HOLESAW SETS

3834-95

HOLESAW SETS

- Sandflex® bi-metal holesaw set consisting of popular sizes within the engineering industry, water and sanitation industry and the electrical installation industry



	 731151		 g
3834-SET-95	8159894	1	1350

3830-VIP
16, 19, 22, 29, 35, 44, 52, 57, 64 mm



3834-ARBR-1130 (14-30 mm)



3834-ARBR-11152 (32-210 mm)
PD type



3834-DRL



3834-103

HOLESAW SETS

- Sandflex® bi-metal holesaw set consisting of popular sizes within the engineering industry, water and sanitation industry and the electrical installation industry



	 731151		 g
3834-SET-103	0134908	1	2015

3830-VIP
16, 19, 24, 29, 38, 44, 57, 67 mm



3834-ARBR-930 (14-30 mm)



3834-ARBR-9100 (32-100 mm)
PD type



3834-DRL





3840 ST

SANDFLEX® BI-METAL BLADES



- The Sandflex® standard shaped with improved performance and precision-ground teeth
- Virtually unbreakable Sandflex® bi-metal blade for all materials and type of cut
- Specially developed for cutting metal
- Standard (ST) shape for fast and aggressive straight cuts
- Available in two different packaging alternatives:
 1. An innovative self-service pack, -5P = 5 blades per cassette
 2. Industrial pack, -10P = 10 blades per box. Most popular items also available bulk packed, -100P = 100 blades per box

	 731151		 mm	 mm	 T/P		 g
3840-100-6-ST-5P	8235642	5	100	1.27	6	ST	95
3840-100-10-ST-5P	8235840	5	100	0.89	10	ST	58
3840-100-14-ST-5P	8235932	5	100	0.89	14	ST	75
3840-100-18-ST-5P	8236052	5	100	0.89	18	ST	75
3840-100-24-ST-5P	8236168	5	100	0.89	24	ST	75
3840-150-6-ST-5P	8235680	5	150	1.27	6	ST	145
3840-150-8/12-ST-5P	8235758	5	150	0.89	8/12	ST	120
3840-150-10-ST-5P	8235871	5	150	0.89	10	ST	120
3840-150-14-ST-5P	8235956	5	150	0.89	14	ST	120
3840-150-18-ST-5P	8236076	5	150	0.89	18	ST	120
3840-150-24-ST-5P	8236182	5	150	0.89	24	ST	120
3840-228-8/12-ST-5P	8235789	5	228	1.27	8/12	ST	170
3840-228-10-ST-5P	8235901	5	228	0.89	10	ST	170
3840-228-14-ST-5P	8235987	5	228	0.89	14	ST	170
3840-228-18-ST-5P	8236106	5	228	0.89	18	ST	175
3840-300-14-ST-5P	8236014	5	300	0.89	14	ST	230
3840-300-18-ST-5P	8236137	5	300	0.89	18	ST	230
3840-100-6-ST-10P	8238681	1	100	1.27	6	ST	155
3840-100-10-ST-10P	8238643	1	100	0.89	10	ST	115
3840-100-14-ST-10P	8238650	1	100	0.89	14	ST	115
3840-100-18-ST-10P	8238667	1	100	0.89	18	ST	115
3840-100-24-ST-10P	8238674	1	100	0.89	24	ST	115
3840-150-6-ST-10P	8238766	1	150	1.27	6	ST	250
3840-150-8/12-ST-10P	8238773	1	150	0.89	8/12	ST	170
3840-150-10-ST-10P	8238698	1	150	0.89	10	ST	185
3840-150-14-ST-10P	8238704	1	150	0.89	14	ST	185
3840-150-18-ST-10P	8238711	1	150	0.89	18	ST	170
3840-150-24-ST-10P	8238728	1	150	0.89	24	ST	185
3840-228-8/12-ST-10P	8238834	1	228	1.27	8/12	ST	290
3840-228-10-ST-10P	8238780	1	228	0.89	10	ST	290
3840-228-14-ST-10P	8238797	1	228	0.89	14	ST	290
3840-228-18-ST-10P	8238803	1	228	0.89	18	ST	295
3840-300-14-ST-10P	8238841	1	300	0.89	14	ST	395
3840-300-18-ST-10P	8238858	1	300	0.89	18	ST	390
3840-150-8/12-ST-100P	8235772	1	150	0.89	8/12	ST	1700
3840-150-10-ST-100P	8235895	1	150	0.89	10	ST	1200
3840-150-14-ST-100P	8235970	1	150	0.89	14	ST	1850
3840-150-18-ST-100P	8236090	1	150	0.89	18	ST	1700
3840-150-24-ST-100P	8236205	1	150	0.89	24	ST	1850
3840-228-8/12-ST-100P	8235802	1	228	1.27	8/12	ST	2800
3840-228-10-ST-100P	8235925	1	228	0.89	10	ST	2800
3840-228-14-ST-100P	8236007	1	228	0.89	14	ST	2800
3840-228-18-ST-100P	8236120	1	228	0.89	18	ST	2950
3840-300-14-ST-100P	8236045	1	300	0.89	14	ST	3950
3840-300-18-ST-100P	8236151	1	300	0.89	18	ST	3900



RECIPROCATING SAWBLADES

3840 SL

SANDFLEX® BI-METAL BLADES



- The Sandflex® Slope shaped with improved performance and precision-ground teeth
- Virtually unbreakable Sandflex® bi-metal blade for all materials and type of cut, specially developed for cutting metal
- Slope (SL) shape for various types of cuts
- Available in two different packaging alternatives:
 1. An innovative self-service pack, -5P = 5 blades per cassette
 2. Industrial pack, -10P = 10 blades per box. Most popular items also available bulk packed, -100P = 100 blades per box

	 731151		 mm	 mm	 T/P"		 g
3840-150-5/8-SL-5P	8235611	5	150	1.27	5/8	SL	110
3840-228-6-SL-5P	8235710	5	228	1.27	6	SL	190
3840-300-6-SL-5P	8235734	5	300	1.27	6	SL	260
3840-300-8/12-SL-5P	8235826	5	300	1.27	8/12	SL	270
3840-150-5/8-SL-10P	8238759	1	150	1.27	5/8	SL	175
3840-228-6-SL-10P	8238827	1	228	1.27	6	SL	325
3840-300-6-SL-10P	8238872	1	300	1.27	6	SL	455
3840-300-8/12-SL-10P	8238889	1	300	1.27	8/12	SL	480
3840-150-5/8-SL-100P	8235628	1	150	1.27	5/8	SL	1750

3840 SC

SANDFLEX® BI-METAL BLADES



- The Sandflex® Scroll shaped with improved performance and precision-ground teeth
- Virtually unbreakable Sandflex® bi-metal blade for all materials and type of cut. Specially developed for cutting metal
- Scroll (SC) shape for contour sawing and in difficult-to-reach places
- Available in two different packaging alternatives:
 1. A new innovative self-service pack, -5P = 5 blades per cassette
 2. Industrial pack, -10P = 10 blades per box

	 731151		 mm	 mm	 T/P"		 g
3840-100-10-SC-5P	8235567	5	100	0.89	10	SC	45
3840-100-14-SC-5P	8235574	5	100	0.89	14	SC	45
3840-100-18-SC-5P	8235581	5	100	0.89	18	SC	45
3840-150-4/6-SC-5P	8235598	5	150	1.27	4/6	SC	110
3840-150-4/6-SC-10P	8238735	1	150	1.27	4/6	SC	180



3840 DSL

SANDFLEX® BI-METAL BLADES



- The Sandflex® Demolition slope (DSL) Bi-Metal blades are a series of extra thick and wide saw blades for demolition and heavy-duty work
- Perfect for nail-embedded wood
- Slope shaped for various types of cuts
- Available in two different packaging alternatives:
 1. An innovative self-service pack, -5P = 5 blades per cassette
 2. Industrial pack, -10P = 10 blades per box

	 731151		 mm	 mm	 T/P"		 g
3840-150-5/8-DSL-5P	8236212	5	150	1.6	5/8	DSL	170
3840-228-5/8-DSL-5P	8236250	5	228	1.6	5/8	DSL	290
3840-300-5/8-DSL-5P	8236274	5	300	1.6	5/8	DSL	410
3840-150-5/8-DSL-10P	8238742	1	150	1.6	5/8	DSL	300
3840-228-5/8-DSL-10P	8238810	1	228	1.6	5/8	DSL	520
3840-300-5/8-DSL-10P	8238865	1	300	1.6	5/8	DSL	770

3840 UST

SANDFLEX® BI-METAL BLADES



- The Sandflex® U-shank standard (UST) bi-metal blades are a series of saw blades with extra wide u-shank (3/4") for example Rems, Roller, Hitachi, and Flex machines
- Suitable for steel and metal applications
- These extra wide blades are normally used for cutting in pipes
- Available in industrial pack, -5P = 5 blades per box

	 731151		 mm	 mm	 T/P"		 g
3840-150-8-UST-5P	8237578	1	150	1.6	8	UST	230
3840-200-8-UST-5P	8237585	1	200	1.6	8	UST	320
3840-300-8-UST-5P	8237592	1	300	1.6	8	UST	470
3840-150-10/14-UST-5P	8278038	1	150	1.6	10/14	UST	230
3840-200-10/14-UST-5P	8278045	1	200	1.6	10/14	UST	320
3840-300-10/14-UST-5P	8278052	1	300	1.6	10/14	UST	470



RECIPROCATING SAWBLADES

3840 HST



SANDFLEX® BI-METAL BLADES

- The Sandflex® Heavy standard (HST) Bi-Metal blades with precision ground teeth are a series of extra thick blades with a wider body that makes it more rigid & has a higher resistance to fracturing and bending, allowing straighter cuts
- Designed for extreme metal cutting
- Slope shaped for various types of cuts
- Available in two different packaging alternatives:
 1. An innovative self-service pack, -5P = 5 blades per cassette
 2. Industrial pack, -10P = 10 blades per box

	 731151		 mm	 mm	 T/P		 g
150-10-HST-5P	0194773	5	150	1.07	10	HST	140
3840-150-14-HST-5P	0194766	5	150	1.07	14	HST	140
3840-150-18-HST-5P	0194759	5	150	1.07	18	HST	140
3840-228-10-HST-5P	0194834	5	228	1.07	10	HST	211
3840-228-14-HST-5P	0194841	5	228	1.07	14	HST	211
3840-228-18-HST-5P	0194858	5	228	1.07	18	HST	211
3840-300-10-HST-5P	0194940	5	300	1.07	10	HST	280
3840-300-14-HST-5P	0194933	5	300	1.07	14	HST	280
3840-300-18-HST-5P	0194926	5	300	1.07	18	HST	280
3840-150-10-HST-10P	0194827	1	150	1.07	10	HST	280
3840-150-14-HST-10P	0194810	1	150	1.07	14	HST	280
3840-150-18-HST-10P	0194803	1	150	1.07	18	HST	280
3840-228-10-HST-10P	0194889	1	228	1.07	10	HST	422
3840-228-14-HST-10P	0194872	1	228	1.07	14	HST	422
3840-228-18-HST-10P	0194865	1	228	1.07	18	HST	422
3840-300-10-HST-10P	0194896	1	300	1.07	10	HST	560
3840-300-14-HST-10P	0194902	1	300	1.07	14	HST	560
3840-300-18-HST-10P	0194919	1	300	1.07	18	HST	560

3840 F&R



SANDFLEX® BI-METAL BLADES

- The Sandflex® Fire & Rescue bi-metal blades with precision ground teeth is an extra heavy duty blade for metal/demolition applications, used in extreme conditions
- Designed for use by the emergency services
- Slope shaped for various cuts
- Available in two different packaging alternatives:
 1. An innovative self-service pack, -5P = 5 blades per cassette
 2. Industrial pack, -10P = 10 blades per box

	 731151		 mm	 mm	 T/P		 g
3840-228-10-DSL-5P	0194957	5	228	1.6	10	DSL	233
3840-228-10-DSL-10P	0194964	1	228	1.6	10	DSL	466



3840-5/10



SANDFLEX® BI-METAL BLADES, KITS

- Virtually unbreakable Sandflex® bi-metal blade for all materials and type of cut
- Standard for fast and aggressive straight cuts
- Slope for various types of cuts
- Scroll for contour sawing and in difficult-to-reach places
- 3842 wood blades for pure wood cutting
- Packaging: In a plastic tube with hanger

	 731151		 g
RECIP-SET-5	8236434	1	75
RECIP-SET-10	8236441	1	155

RECIP-SET-5

3840-100-14-SC, 3840-150-5/8-SL, 3840-150-14-ST, 3840-150-24-ST, 3842-150-7-SL



RECIP-SET-10

3840-100-6-ST, 3840-100-10-SC, 3840-100-18-SC, 3840-100-24-ST, 3840-150-5/8-SL, 3840-150-10-ST, 3840-150-14-ST, 3840-150-18-ST, 3840-150-24-ST, 3842-150-7-SL



3840



PALLET BLADE

- The pallet repair blade is developed in close co-operation with pallet repair shops
- The unique front design prevents the blade front getting stuck in close by wood beams, when cutting nails in damaged parts of the pallet
- By increasing the shank radius we have improved the fatigue strength
- 10/14 TPI has proved to be the most popular toothing amongst users in pallet repair shops. This toothing has good material removal rate in wood with nails and high strength to tooth breakage
- The packing quantities are 10 or 100 pcs in plastic tubes

	 731151		 mm	 mm	 T _{1/4"}		 g
3840-228-10/14-PR09-10P	8255190	10	228	0.9	10/14	PR	300
3840-228-10/14-PR13-10P	8255206	1	228	1.3	10/14	PR	410
3840-228-10/14-PR09-100P	8255213	1	228	0.9	10/14	PR	2850
3840-228-10/14-PR13-100P	8255220	1	228	1.3	10/14	PR	4000



RECIPROCATING SAWBLADES

3840-P

PALLET BLADE



- Especially developed sawblade for transport pallet repairs
- Blades produced in Sandflex® bi-metal, 24 TPI
- Used in pneumatic hand held saw machines, type Cengar, Ingersoll-Rand or similar to cut nails in order to replace damaged parts on a transport pallet
- 100 blades are packed in a hard plastic box

3840-220-24	731151	100	220 mm	0.75 mm	24	-	16 g

3842

WOOD CUTTING CARBON BLADES



- New blades with special tothing for all-round wood-cutting
- Slope (SL) shape for various types of cuts
- The tothing allows considerably faster cutting compared to traditional blades
- The blade is coated for minimum friction

3842-150-7-SL-5P	8236298	5	150 mm	1.07 mm	7	SL	110 g
3842-228-7-SL-5P	8236311	5	228 mm	1.07 mm	7	SL	180 g
3842-300-7-SL-5P	8236335	5	300 mm	1.07 mm	7	SL	245 g
3842-150-7-SL-10P	8238902	1	150 mm	1.07 mm	7	SL	180 g
3842-228-7-SL-10P	8238896	1	228 mm	1.07 mm	7	SL	315 g
3842-300-7-SL-10P	8238919	1	300 mm	1.07 mm	7	SL	435 g

3845

SANDFLEX® CAR BODY SAWBLADES



- Car body sawblades for pneumatic and electrical machines, type Shinano, Chicago-Pneumatic or similar
- Designed to cut in thin sheet metal. Mostly used in car body workshops or in HVAC applications
- Sandflex® bi-metal blade material for effective performance and long lasting blade life
- Packed in easy-to-use hard plastic cassette of 10 blades (-10P)

3845-18-10P	8101602	1	18 mm	90 mm	>5 mm	48 g
3845-24-10P	8101619	1	24 mm	90 mm	2-5 mm	48 g
3845-32-10P	8101626	1	32 mm	90 mm	0-2 mm	48 g



3846

CARBIDE BLADES



G-ST

ST

SL

- A new wide range of 3 and 6 TPI carbide tipped blades for cutting of non-ferrous materials such as lightweight concrete, bricks, fibreglass
- Carbide Grit for cutting hard materials such as tiles, ceramics and glass
- Comes in two shapes, Slope (SL) shape for various types of cuts and Standard (ST) shape for fast and aggressive straight cuts

	 731151		 mm	 mm	 T/P		 g
	8236359	5	150	1.25	6	SL	45
	8236397	5	228	1.25	3	ST	70
	8236403	5	300	1.5	3	ST	110
	8236410	5	100	0.89	Grit	ST	45
	8236427	5	150	0.89	Grit	ST	65

3844

MEAT CUTTING BLADE



- Reciprocating blade made for cutting in meat/bone and frozen materials
- 3 TPI blade made in stainless steel

	 731151		 mm	 mm	 T/P		 g
	8267605	10	300	1.25	3	-	60



JIGSAW BLADES

91

JIG SAWS FOR WOOD

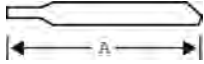

- These blades fit AEG, Atlas Copco, Bosch, DeWalt, Hitachi, Makita, Metabo, Milwaukee and similar machines
- Standardized T-Shank (also referred to as Euro shank)
- Type of blades:
 - HCS: Carbon steel, is suitable for cutting through wood, plastic and other soft materials
 - BiM: Bi-metal combines the cutting performance of HSS with the flexibility of carbon steel, the saw blades are shatterproof and suitable for cutting through all types of material. A new progressive toothing has been introduced on our universal progressive blade
- The progressivity gives many fine teeth close to the shank, good when cutting in thin material, the teeth then become coarser and more effective further out from the shank allowing thicker material to be processed
- Packaging:
 - 5P = 5 blades packed on informative card

* reversed teeth

	 731151		 T/mm	A mm		 mm	 g
91-434-5P	8260026	1	8	116	1	BiM	45
91-444-5P	8260033	1	6	152	3	BiM	45
91-023-5P	8032593	1	8	100	2	HCS	45
91-027-5P	8032616	1	12	75	2	HCS	45
91-143-5P	8032630	1	6	100	3	HCS	45
91-148-5P	8032654	1	6	100	3	HCS	45
91-223-5P	8032661	1	10	100	1	HCS	45
91-226-5P	8032685	1	10	100	*1	HCS	45
91-243-5P	8032692	1	6	100	1	HCS	45
91-412-5P	8260040	1	20	76	1	BiM	45
91-443-5P	8032722	1	6	100	1	BiM	45
91-233-5P	8260057	1	8	116	1	HCS	45

91

JIG SAWS FOR WOOD AND METAL



91-623



91-2PW

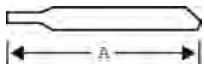

- These blades fit AEG, Atlas Copco, Bosch, DeWalt, Hitachi, Makita, Metabo, Milwaukee and similar machines
- Standardized T-Shank (also referred to as Euro shank)
- Type of blades:
 - HCS: Carbon steel, is suitable for cutting through wood, plastic and other soft materials
 - BiM: Bi-metal combines the cutting performance of HSS with the flexibility of carbon steel, the saw blades are shatterproof and suitable for cutting through all types of material
- A new progressive toothing has been introduced on our universal progressive blade
- The progressivity gives many fine teeth close to the shank, good when cutting in thin material, the teeth then become coarser and more effective further out from the shank allowing thicker material to be processed
- Packaging:
 - 5P = 5 blades packed on informative card

	 731151		 T/mm	A mm		 mm	 g
91-2PW-5P	8260163	1	Prog	116	2	HCS	45
91-4PWM-5P	8260170	1	Prog	132	2	BiM	45
91-623-5P	8260641	1	10	116	2	BiM	45





91

JIG SAWS FOR METAL

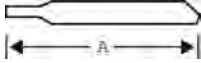

- These blades fit AEG, Atlas Copco, Bosch, DeWalt, Hitachi, Makita, Metabo, Milwaukee and similar machines
- Standardized T-Shank(also referred to as Euro shank)
- Type of blades:
 - HSS: High Speed Steel is long lasting and will cut through most materials
 - BiM: Bi-metal combines the cutting performance of HSS with the flexibility of carbon steel, the saw blades are shatterproof and suitable for cutting through all types of material
 - CT: Carbide Tipped, for abrasive materials, ceramics, reinforced plastic, marble, glass
 - HM: Hard Metal
- A new progressive toothing has been introduced on our universal progressive blade
- The progressivity gives many fine teeth close to the shank, good when cutting in thin material, the teeth then become coarser and more effective further out from the shank allowing thicker material to be processed
- Packaging:
 - 5P = 5 blades packed on informative card
 - 1P = 1 blade packed on informative card

	 731151		 T/1"	A mm		 mm	 g
91-3PM-5P	8260156	1	Prog	100	2	HSS	45
91-433-5P	8260101	1	8	100	2	BiM	45
91-502-5P	8032746	1	36	75	1	HSS	45
91-512-5P	8032753	1	24	75	2	HSS	45
91-517-5P	8032777	1	24	75	2	HSS	45
91-522-5P	8032784	1	14	75	2	HSS	45
91-611-5P	8260071	1	24	132	1	BiM	45
91-612-5P	8032814	1	24	75	2	BiM	45
91-622-5P	8060088	1	14	75	1	BiM	45
91-7V1-5P	8260118	1	10/14	132	2	BiM	45
91-919-1P	8260149	1	24	75	1	HM/CT	45

91

JIG SAWS OTHERS

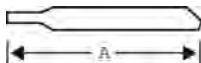

- These blades fit AEG, Atlas Copco, Bosch, DeWalt, Hitachi, Makita, Metabo, Milwaukee and similar machines
- Standardized T-Shank (also referred to as Euro shank)
- Type of blades:
 - CT: Carbide Tipped, for abrasive materials. Ceramics, reinforced plastic, marble, glass
 - HM: Hard metal
- A new progressive toothing has been introduced on our universal progressive blade
- The progressivity gives many fine teeth close to the shank, good when cutting in thin material, the teeth then become coarser and more effective further out from the shank allowing thicker material to be processed
- Packaging:
 - 1P & -1 = 1 blade packed on informative card

	 731151		 T/1"	A mm		 mm	 g
91-840-1P	8260125	1	6	100	3	HM/CT	45
91-C13-1	8142162	1	RIFF	75	3	CT	11



CIRCULAR SAW BLADES

8501

ELECTRICAL HAND SAWS

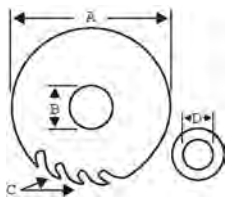

- Cemented-carbide tipped circular saw blades for electrical hand saws for fast cuts in wooden materials
- Medium tooting blades made of hardened cold rolled steel
- Expansion slots to take up the expansion of the steel when in use
- Size range 125 mm to 400 mm diameter blades

	 731151		A mm	B mm	C	D mm	 g
8501-2	8004743	1	125	20	16	16 13 12.7	120
8501-3	8004750	1	130	20	16	16 13	130
8501-4	8008079	1	140	20	16	16 13	155
8501-5	8004774	1	150	20	18	16 13	180
8501-7	8004798	1	160	20	18	16	200
8501-10	8004828	1	170	30	18	20 16	215
8501-12	8004842	1	180	30	20	20 16	250
8501-13	8004859	1	184	30	24	28.6 20	275
8501-15	8004873	1	190	30	20	20	290
8501-16	8004880	1	200	30	20	25 20 18 16	320
8501-17	8004897	1	210	30	20	25 20 16	350
8501-22	8178888	1	230	30	20	25 16	500
8501-23	8004958	1	235	30	30	25 16	560
8501-28	8018894	1	250	30	24	25 20 16	650
8501-30	8237479	1	300	30	30	20	1445
8501-31	8237455	1	315	30	30	25	1570
8501-40	8282042	1	400	30	40	25	2760

8501-F / -XF

ELECTRICAL HAND SAWS

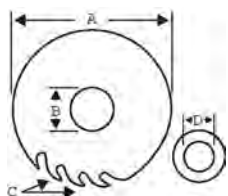

- Cemented-carbide tipped circular saw blades for electrical hand saws for fast cuts in wooden materials
- Fine tooting blades made of hardened cold rolled steel
- Expansion slots to take up the expansion of the steel when in use
- XF = Extra fine tooting preferred for laminates and hard woods
- Size range 140 mm to 315 mm diameter

	 731151		A mm	B mm	C	D mm	 g
8501-4F	8220914	1	140	20	24	16 13	165
8501-4XF	8281786	1	140	20	30	16 13	235
8501-5F	8220921	1	150	20	30	16 13	190
8501-7F	8220938	1	160	20	30	16	210
8501-10F	8220945	1	170	30	30	20 16	250
8501-12F	8220952	1	180	30	40	20 16	370
8501-13F	8220969	1	184	30	40	28.6 20	285
8501-15F	8220976	1	190	30	40	20	310
8501-16F	8220983	1	200	30	40	25 20 18 16	335
8501-17F	8220990	1	210	30	40	25 20 16	385
8501-22F	8221003	1	230	30	40	25 16	530
8501-23F	8018887	1	235	30	40	25 16	560
8501-28F	8221010	1	250	30	40	25 20 16	650
8501-28XF	8281946	1	250	30	60	25 20 16	795
8501-30F	8237462	1	300	30	40	20	1100
8501-30XF	8281984	1	300	30	60	20	1470
8501-31F	8237448	1	315	30	40	20	1300





8501-S

OTHER ELECTRICAL SAWS



- Cemented-carbide tipped circular saw blades for chop saws, mitre saws & radial arm saws
- Trapezoidal toothing for cutting aluminium & plastics
- Blades made of hardened cold rolled steel
- Expansion slots to take up the expansion of the steel when in use
- Size range 210 mm to 300 mm diameter

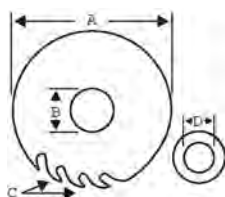

	 731151		A mm	B mm	C	D mm	 g
8501-17S	8221027	1	210	30	48	25	580
8501-18S	8221034	1	216	30	48	25	595
8501-28S	8221041	1	250	30	80	25 20 16	770
8501-30S	8282240	1	300	30	96	20	1370

8501-SW

OTHER ELECTRICAL SAWS



- Cemented-carbide tipped circular saw blades for chop saws, mitre saws and radial arm saws
- Fine 0 degree toothing blades made of hardened cold rolled steel
- Expansion slots to take up the expansion of the steel when in use
- Size range 216 mm to 300 mm diameter

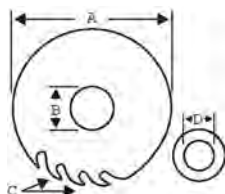

	 731151		A mm	B mm	C	D mm	 g
8501-18SW	8221058	1	216	30	48	25	635
8501-28SW	8221065	1	250	30	60	25 20 16	795
8501-30SW	8282196	1	300	30	60	20	1400

FILES & ROTARY BURRS

Bahco's file range represents the accumulated knowledge of more than 160 years of file production.

Drawing on this experience, Bahco has continuously developed and improved the design of this most critical of products, applying state-of-the-art manufacturing methods to its production.

Rigorous quality control is built into the product, from the incoming raw material of the highest grade to the finished products, which delivers consistent performance.

Of course, all Bahco files fulfil the requirements issued by the following standards: ISO 234/1 & 2, DIN File Standards, BS 498:1990, US Fed.spec. GGG-F-325b/GGG-F-331b.

Chapter Index

ENGINEERING FILES	72-84
NEEDLE FILES	85-91
DIAMOND FILES	91-92
MILLED TOOTH FILES	93-94
SHARPENING FILES	94-103
CHAIN SAW FILES	103-105
RASPS	106-108
ACCESSORIES	108-111
TUNGSTEN CARBIDE ROTARY BURRS	112-123
HSS ROTARY BURRS	124-131
AUTOMOTIVE	132

ERGONOMIC HANDLES



Our file handles are ergonomically designed, following the Bahco ERGO™ Process, to reduce muscle tension and the risk of injury. The hard polypropylene core, covered with a thermoplastic elastomer, provides a comfortable non-slip grip, and the handle's smooth contours fit into the hand naturally.

As a safety feature, the handle covers the tang and shoulder completely. This prevents the hand from slipping off the handle onto the file blade. Bahco supplies most popular files complete with a symmetric handle to allow the user to grip it comfortably regardless of which side of the file is used.

THREE DIFFERENT SHAPES & SIZES WITH 12 DIFFERENT INSERTS: small - medium - large



PATENTED DESIGN IMPROVES SAFETY AND COMFORT



WHICH FILE TO USE DEPENDS ON THE WORK MATERIAL AND THE DESIRED FINISH

Hand files are divided into four main categories: engineering files, needle files, sharpening files and milled files (including PANSAR® blades).

The Bahco range includes all types, easily meeting national and international standards.

TYPE AND SHAPE

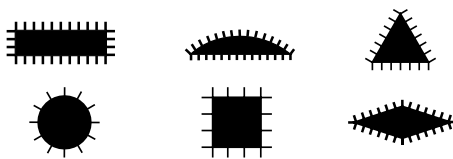

Files vary in shape and use and are named thereafter. The most common types are: hand, flat, half-round, three-square, round, square, and double-edge.

LENGTH

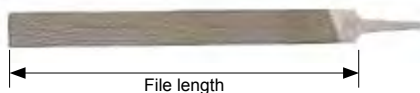

The Bahco range includes sizes from 4" (100 mm) in length to 12" (300 mm), depending on type. The most suitable file length depends entirely on the work to be done. The length of the file is always stated excluding the tang, with exception of needle files where this is included.

TOOTH TYPE AND CUT

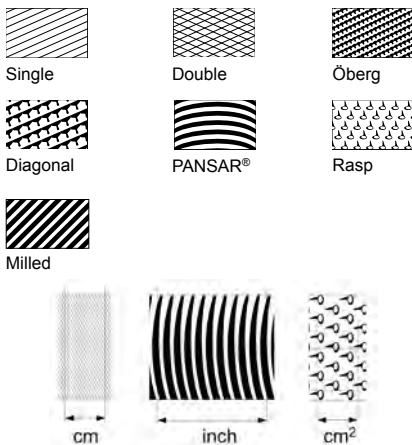

The tothing of a file can vary in a number of ways. The type of cut chosen depends on the work material, the desired rate of material removal and the desired finish. The most common cuts are: single cut, double cut, Öberg cut, diagonal cut, milled cut, PANSAR® and rasp cut.

For all engineering, needle and sharpening files, the coarseness of the cut is given in number of whole teeth per cm along the length of the file. The most common degrees of coarseness are bastard, second and smooth.

Rule of thumb is the coarser the cut, the more material is removed.

For diagonal files, milled files and PANSAR® blades, the degree of coarseness is given in number of whole teeth per inch. The coarseness of the rasps is expressed in number of tooth tips per cm².

CHOOSE A FILE ACCORDING TO THE WORK OPERATION

	SINGLE CUT	DOUBLE CUT			ÖBERG CUT	DIAGONAL	MILLED PANSAR®	RASP
		BASTARD	SECOND	SMOOTH				
Fine filing Sharpening	●		◐	●	◐		●	
Deburring Edging	●	◐	●	●	◐	◐	◐	
Rough filing Material removal		●			●	●		●

CHOOSE A FILE ACCORDING TO THE WORK MATERIAL

- best choice, recommended
◐ good choice, adequate

	SINGLE CUT	DOUBLE CUT			ÖBERG CUT	DIAGONAL	MILLED PANSAR®	RASP
		BASTARD	SECOND	SMOOTH				
High alloy steel	●	◐	●	●	◐		●	
Unhardened steel	●	●	●	●	●	●	●	
Cast iron		●	●	◐	●	●		
Brass, bronze		●	●	◐	●	●	●	
Aluminium		◐				●	●	
Wood and hard plastics					◐	◐	●	●

CHOOSING TRIANGULAR TAPER FILES FOR DIFFERENT TYPES OF SAW

A hardpoint saw cannot be filed. Therefore, when sharpening a fileable saw, use the longest file possible for smooth and efficient filing.

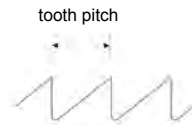

When choosing a file for sharpening a saw, it is important to know the pitch of the saw, which is usually expressed in number of whole teeth per inch.

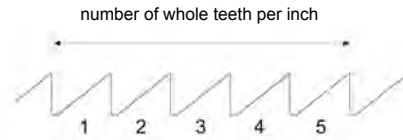

The following rule applies to choosing triangular taper files for universal and rip-toothed saws, especially for bandsaws: $A > a + b$

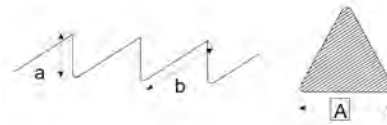

SAW FILE TABLE

UNIVERSAL AND CROSS-TOOTHED HAND SAWS					
Teeth / inch	File type No. / length				
	183	186	187	188	190
2 1/2	10"				
3	8"				
3 1/2	7"				
4	6"	8"			
4 1/2	5"	8"			
5	5"	7"			
6	4"	6"	7"		
7		5"	6"		8"
8		5"	5"	6"	7"
9		4"	5"	6"	6"
10			4"	5"	
11				5"	
12, 13				4"	
14, 15				4"	



BANDSAW BLADES					
Teeth / inch	Edge radius	File type No. / length			
		192	202	203	204
2 1/2	1,4	8"			8 1/2"
3	1,3	7"	8 1/2"		
3 1/2	1,2	6"			
4	1,1	5"			
4 1/2	1,0			8 1/2"	
5	0,7				

STRAIGHT SAW BLADES	
Teeth / inch	File type No. / length
3 1/2-4	8" double edge saw file 270
4 1/2-5	5" double edge saw file 270 or 6" double edge saw file Wasa® 272
5 1/2-8	5" or 6" double edge saw file Wasa® 272

TABLE OF FLAT SHARPENING FILES

Flat sharpening files are intended primarily for sharpening steel saw blades. They are also very useful as engineering files and sharpening files for

different types of edge tools. As engineering files, they are ideal for all types of work where a high surface finish is required.

CROSS SECTION OF FILE	FILE NO.	USE
Flat files with 1 round edge and 1 straight edge 	138 144	These files are primarily intended for sharpening various types of saw blades. The files are also suitable for polishing, deburring work, material removal and draw filing.
Flat files with 2 round edges 	140	A file developed especially for circular and bandsaw blades as well as for felling and gang saws with fine toothing. This file can also be used for rounding the gullets.
Flat files with 2 straight edges 	142	A universal sharpening file for agricultural tools such as axes and hoes. The file can also be used for polishing and deburring work on lathes.

CIRCULAR AND FELLING SAWS

Tooth shapes A and D

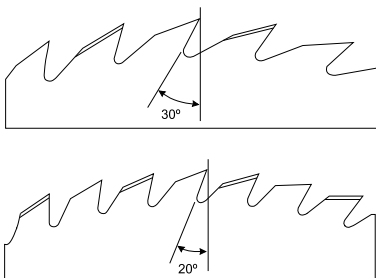

TOOTH PITCH mm	FILE LENGTH	
	inch	mm
39-44	14	350
32-38	12	300
26-31	10	250
21-25	8	200
17-20	6	150

Tooth shapes F and C

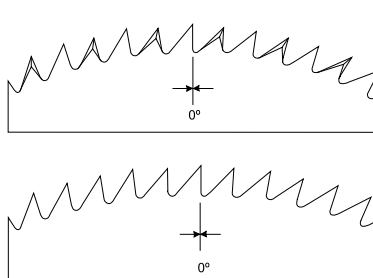

TOOTH PITCH mm	FILE LENGTH	
	inch	mm
26-31	14	350
21-25	12	300
17-20	10	250
13-16	8	200
10-12	6	150



FILE HANDLE SELECTION. ENGINEERING FILES AND RASPS

The table below is to support the handle selection for the engineering files and rasps, you can find a quick and reliable link between the different files

and the handle that goes with it. For example: if you want a handle for the 1-100-04-1-0 file, the ones that fits are both, 9-484-5.2-10 or 9-484-5.2-1P.

SHAPE	CODE	4''	6''	7''	8''	10''	12''	14''
	1-100	5,2	05		09	09	13	13
	1-104					09	13	13
	1-106				09	09	13	
	1-110	5,2	05		09	09	13	13
	1-111	5,2	04					
	1-143		04		06	09	13	13
	1-160	3,2	04		05	05	08	
	1-170	3,2	04		07	05	08	
	1-210	5,2	05		09	09	13	13
	1-230	3,2	04		05	05	08	13
	1-320				09	09	13	
	6-342		06		09	09		
	6-343				06	09		
	6-344				09	09		
	6-345				05	05		

ARTICLE CODE STRUCTURE

The product codes of Bahco files have been chosen logically with each digit carrying an identifying piece of information. Most codes follow the code structure explained below.

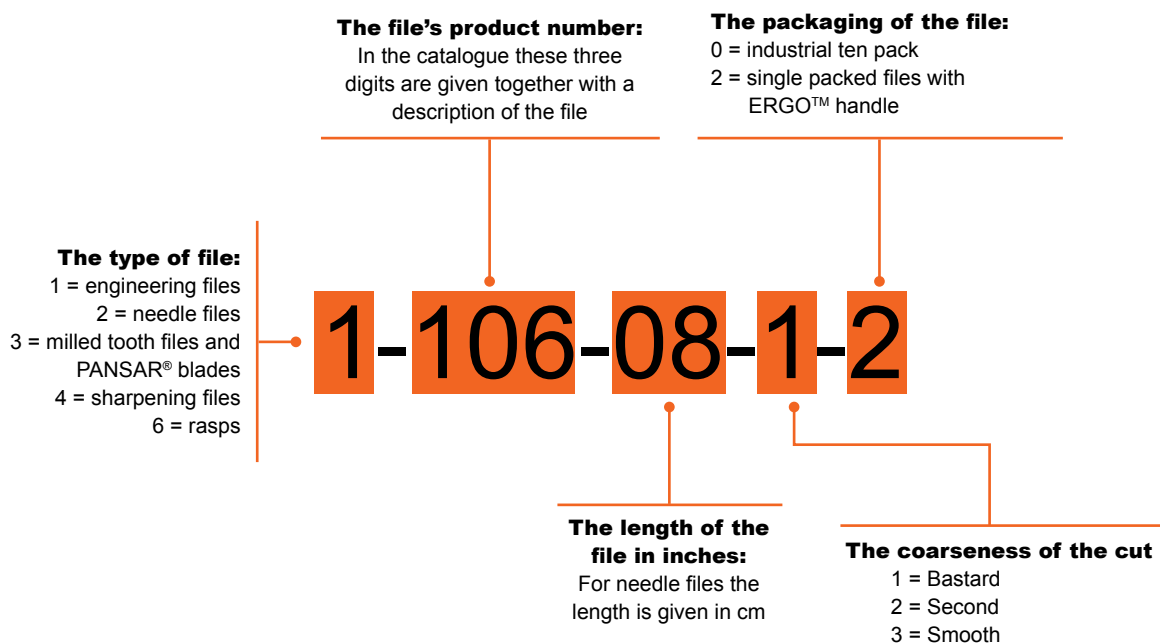

ROTARY BURRS

Bahco Rotary Burrs are used to deburr irregular objects or to complete finishing work inside a confined space.

The burrs are manufactured in two different materials, tungsten carbide or high-speed steel. The choice of material depends on the application. The carbide rotary burr is an indispensable tool, used

in a large number of industrial sectors including aviation, shipping, automotive and the chemical industry, to mention just a few. Its application areas encompass machining cast iron, cast steel, carbon steel, alloy steel, stainless steel, hardened steel, copper and aluminium.

IDENTIFICATION SYSTEM

High Speed Steel rotary burrs

HSSG - A 12 25 M HSS = High Speed Steel. G = Ground.

Tungsten carbide rotary burrs

A 12 25 M 06 X E

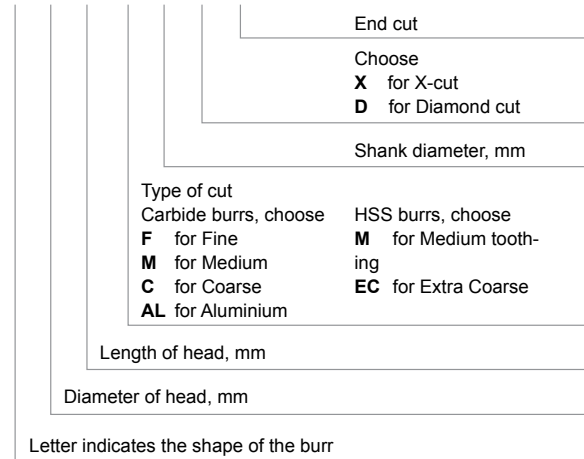

CHOOSE THE RIGHT ROTARY BURRS

TOOTHING		TUNGSTEN CARBIDE BURRS	HIGH-SPEED STEEL (HSS) BURRS
Fine		For hard and/or tough materials where a smooth surface finish is required and removal demands are modest.	
Medium		For machining hard and/or tough materials under normal conditions.	For machining unhardened steel and other moderately hard materials under normal conditions.
Coarse		Particularly suitable for machining stainless steel, soft materials or light alloys.	
AL-cut		For machining aluminium. Wax should be used to avoid chip build-up.	
Extra Coarse		Blunt.	For soft materials when good stock removal is required. Prevents chip build-up between teeth.
X-cut		For hard and soft materials. Produces short and blunt chips. Runs smoothly even at low cutting speeds.	
Diamond-cut		For heat treated and tough alloy steels and epoxy. Excellent finish. Minimal axial forces.	
Chip-breakers			Produces short chips. Runs smoothly even at low cutting speeds.
End cut		Cylindrical burrs (A) and inverted cone burrs (N) can be supplied with end cut.	

Rotary burrs can be classified by cut into four major groups: fine, medium, coarse and extra coarse (which AL-cut belongs to). As a general rule, a fine cut is selected for hard materials and when a good surface finish is required. Note the exception is stainless steel, which needs a coarse cut. A coarse cut is selected for soft materials and for high stock removal demands.

It should be pointed out, however, that a smaller diameter burr will have a finer cut than a larger diameter burr belonging to the same cut category, for example, medium-cut. Therefore, the number of teeth is also indicated in addition to the type of cut for each rotary burr.

RECOMMENDED OPERATING SPEEDS R.P.M.

TUNGSTEN CARBIDE			
Head Ø mm	Hardened steels, high-strength materials	Unhardened steels, softer materials and cast iron	Soft materials, aluminium, thermoplastics, brass
	R.P.M x 1000	R.P.M x 1000	R.P.M x 1000
3	40 - 80	50 - 90	50 - 100
6	25 - 60	30 - 60	30 - 70
8	20 - 45	25 - 50	25 - 50
10	17 - 40	20 - 40	20 - 40
12	15 - 30	17 - 30	17 - 35
16	12 - 25	15 - 25	15 - 30

HIGH SPEED STEEL		
Head Ø mm	Unhardened steels, softer materials and cast iron	Soft materials, aluminium, thermoplastics, brass
	R.P.M x 1000	R.P.M x 1000
6	5 - 20	20 - 40
10	3 - 10	10 - 30
12	1 - 10	10 - 30
16	1 - 8	10 - 25

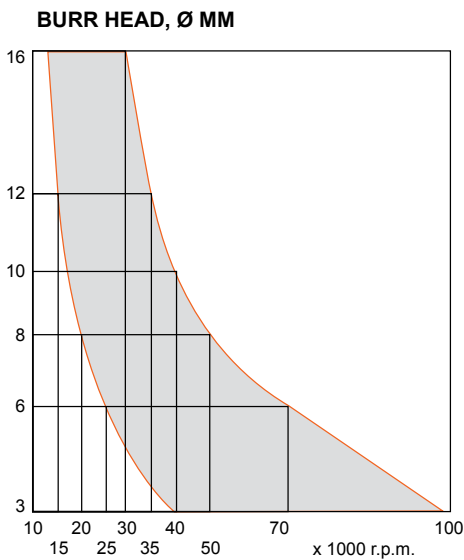

For machining in harder materials use lower speed and finer cut.

Note that the cutting performance depends on the machine's bearing condition and the characteristics of the machine (the cutting speed must not slow down when deburring).

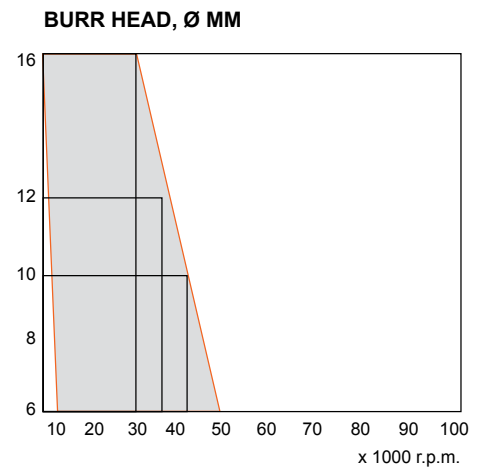

A = Cylindrical

3 mm	6 mm	8 mm	10 mm	12 mm	16 mm
A0313C03	A0610F06D	A0810F06D	A1020C06	A1225AL06E	A1625C06
A0313F03	A0613M03X	A0820C06	A1020F06	A1225AL08E	A1625C08
A0313F03E	A0616AL06E	A0820F06	A1020M06	A1225C06	A1625F06
A0313M03	A0616C06	A0820F06E	A1020M06E	A1225C08	A1625F08
A0313M03E	A0616F06	A0820M06	A1020M06X	A1225F06	A1625M06
A0313M03X	A0616M06	A0820M06E	A1020M06XE	A1225F06E	A1625M06X
A0313M03XE	A0616M06DE	A0820M06X	A1040M06X	A1225F08	A1625M06XE
A0313M03XE-60	A0616M06E	A0820M06XE	A1050M06X	A1225M06	A1625M08
A0313M03XE-80	A0616M06X			A1225M06DE	A1625M08E
A0320M03X	A0616M06XE			A1225M06E	A1625M08X
	A0625M06X			A1225M06X	A1625M08XE
				A1225M06XE	
				A1225M08	
				A1225M08E	
				A1225M08X	
				A1225M08XE	

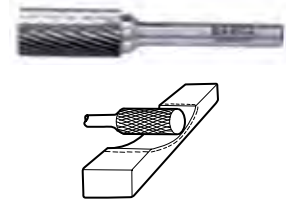

C = Cylindrical round nose

3 mm	6 mm	8 mm	10 mm	12 mm	16 mm
C0313C03	C0613M03X	C0820C06	C1020C06	C1225AL06	C1625C06
C0313F03	C0616AL06	C0820F06	C1020F06	C1225AL08	C1625C08
C0313M03	C0616C06	C0820M06	C1020M06	C1225C06	C1625F06
C0313M03X	C0616F06	C0820M06X	C1020M06X	C1225C08	C1625F08
	C0616M03X			C1225F06	C1625M06
	C0616M06			C1225F08	C1625M06X
	C0616M06D			C1225M06	C1625M08
	C0616M06X			C1225M06X	C1625M08X
				C1225M08	
				C1225M08X	



D = Spherical

3 mm	6 mm	8 mm	10 mm	12 mm	16 mm
D0303C03	D0605M03X	D0807C06	D1009C06	D1211AL06	D1614C06
D0303F03	D0606C06	D0807F06	D1009F06	D1211AL08	D1614C08
D0303M03	D0606F06	D0807M06	D1009M06	D1211C06	D1614F06
D0303M03X	D0606M06	D0807M06X	D1009M06X	D1211F06	D1614F08
	D0606M06X			D1211F06D	D1614M06
				D1211M06	D1614M06X
				D1211M06X	D1614M08
					D1614M08X

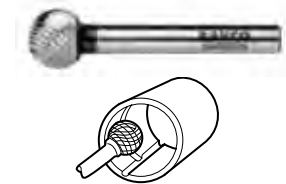

E = Oval

3 mm	6 mm	8 mm	10 mm	12 mm	16 mm
E0308C03	E0614C06	E0816C06	E1018C06	E1222C06	E1625C06
E0308F03	E0614F06	E0816F06	E1018F06	E1222C08	E1625C08
E0308M03	E0614M06	E0816M06	E1018M06	E1222F06	E1625F06
E0308M03X	E0614M06X	E0816M06X	E1018M06X	E1222F08	E1625F08
				E1222M06	E1625M06
				E1222M06X	E1625M06X
				E1222M08	E1625M08
				E1222M08X	E1625M08X



F = Arch round nose

3 mm	6 mm	8 mm	10 mm	12 mm	16 mm
F0313C03	F0612C04	F0820C06	F1020C06	F1225AL06	F1625C06
F0313F03	F0612F04	F0820F06	F1020F06	F1225AL08	F1625C08
F0313M03	F0612M04	F0820M06	F1020M06	F1225C06	F1625F06
F0313M03X	F0612M04X	F0820M06X	F1020M06X	F1225C08	F1625F08
	F0613M03X			F1225F06	F1625M06
	F0618AL06			F1225F08	F1625M06X
	F0618C06			F1225M06	F1625M08
	F0618F06			F1225M06X	F1625M08X
	F0618M06			F1225M08	
	F0618M06X			F1225M08X	

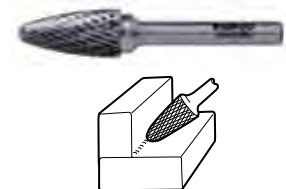

G = Arch pointed nose

3 mm	6 mm	8 mm	10 mm	12 mm	16 mm
G0313C03	G0613M03X	G0820C06	G1020C06	G1225C06	G1625C06
G0313F03	G0618C06	G0820F06	G1020F06	G1225C08	G1625C08
G0313M03	G0618F06	G0820M06	G1020M06	G1225F06	G1625F06
G0313M03X	G0618M06	G0820M06X	G1020M06X	G1225F08	G1625F08
	G0618M06X	G0845M6.6X	G1050M8.3X	G1225M06	G1625M06
	G0645M4.9X			G1225M06X	G1625M06X
				G1225M08	G1625M08
				G1225M08X	G1625M08X

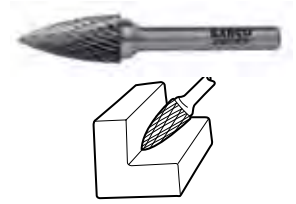

H = Flame

3 mm	6 mm	8 mm	10 mm	12 mm	16 mm
	H0613M03X		H1025C06	H1232M06	H1635C06
			H1025F06	H1232M06X	H1635C08
			H1025M06		H1635F06
			H1025M06X		H1635F08
			H1025M08		H1635M06
					H1635M06X
					H1635M08
					H1635M08X



J = 60° cone

3 mm	6 mm	8 mm	10 mm	12 mm	16 mm
	J0604C06		J1010C06	J1212M06	J1616C06
	J0604F06		J1010F06		J1616C08
	J0604M06		J1010M06		J1616F06
					J1616F08
					J1616M06
					J1616M08

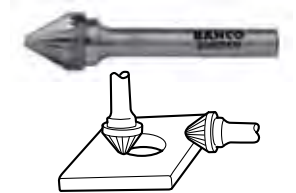

K = 90° cone

3 mm	6 mm	8 mm	10 mm	12 mm	16 mm
	K0602C06		K1008C06	K1210C06	K1612C06
	K0602F06		K1008F06	K1210F06	K1612C08
	K0602M06		K1008M06	K1210M06	K1612F06
					K1612F08
					K1612M06
					K1612M08

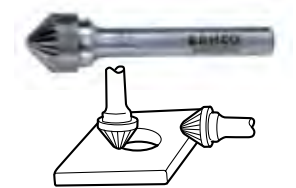

L = Conical round nose

3 mm	6 mm	8 mm	10 mm	12 mm	16 mm
			L1020C06	L1225F06	L1630C06
			L1020F06	L1225M06	L1630C08
			L1020M06	L1225M06X	L1630F06
			L1020M06X	L1230AL06	L1630F08
				L1230AL08	L1630M06
				L1230C06	L1630M06X
				L1230F06	L1630M08
				L1230M06	L1630M08X
				L1230M06X	

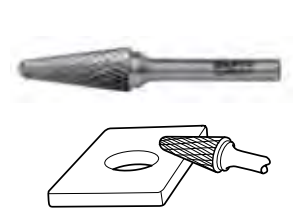

M = Conical pointed nose

3 mm	6 mm	8 mm	10 mm	12 mm	16 mm
M0310C03	M0613M03X		M1022C06	M1227C06	M1630C06
M0310F03	M0618C06		M1022F06	M1227C08	M1630C08
M0310M03	M0618F06		M1022M06	M1227F06	M1630F06
M0310M03X	M0618M06		M1022M06D	M1227F08	M1630F08
	M0618M06X		M1022M06X	M1227M06	M1630M06
				M1227M06X	M1630M06X
				M1227M08	M1630M08
				M1227M08X	M1630M08X

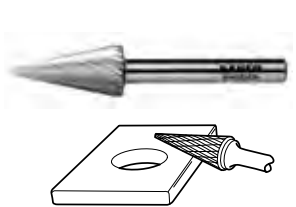

N = Inverted cone

3 mm	6 mm	8 mm	10 mm	12 mm	16 mm
N0306C03	N0607C06			N1213C06	N1613C06
N0306F03	N0607F06			N1213F06	N1613C08
N0306M03	N0607M06			N1213M06	N1613F06
N0306M03E	N0607M06E			N1213M06E	N1613F08
					N1613M06
					N1613M06E
					N1613M06X
					N1613M08

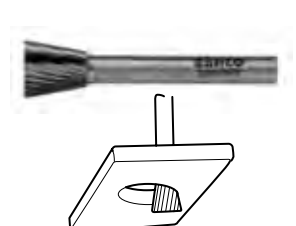



1-100...-0

HAND FILE INDUSTRY PACK, UNHANDLED

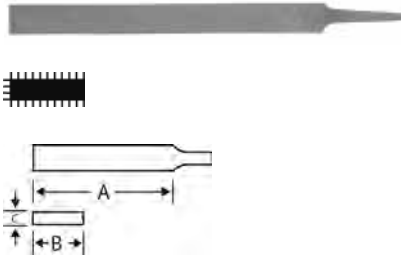

- For filing flat surfaces, sharp corners and shoulders as well as for deburring
- To work in high-alloy tool steels, for the sharpening of heavy implements
- High removal rate
- Shape: Edges and surfaces parallel
- Surfaces double cut, one edge uncut, one edge single cut
- Type of cut: 1 = Bastard, 2 = Second, 3 = Smooth

	 731151		A mm	B mm	C mm	 T/cm		 g
1-100-04-1-0	8019006	10	100	12	3.0	17	1	30
1-100-04-2-0	8019013	10	100	12	3.0	22	2	30
1-100-04-3-0	8019020	10	100	12	3.0	28	3	30
1-100-06-1-0	8019037	10	150	16	4.0	13	1	73
1-100-06-2-0	8019044	10	150	16	4.0	18	2	73
1-100-06-3-0	8019051	10	150	16	4.0	22	3	73
1-100-08-1-0	8019068	10	200	20	5.0	10	1	145
1-100-08-2-0	8019075	10	200	20	5.0	14	2	145
1-100-08-3-0	8019082	10	200	20	5.0	18	3	145
1-100-10-1-0	8019099	10	250	25	5.5	9	1	250
1-100-10-2-0	8019105	10	250	25	5.5	12	2	250
1-100-10-3-0	8019112	10	250	25	5.5	16	3	250
1-100-12-1-0	8019129	5	300	30	6.0	8	1	392
1-100-12-2-0	8019136	5	300	30	6.0	11	2	392
1-100-12-3-0	8019143	5	300	30	6.0	14	3	392
1-100-14-1-0	8019150	5	350	35	6.5	7	1	605
1-100-14-2-0	8019167	5	350	35	6.5	10	2	605

1-100...-2

HAND FILE SINGLE PACK CARDED

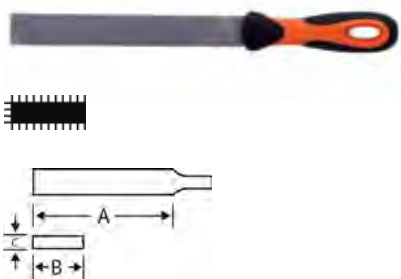

- File handle developed according to the scientific ERGO™ process
- For filing flat surfaces, sharp corners and shoulders as well as for deburring
- To work in high-alloy tool steels, for the sharpening of heavy implements
- High removal rate
- Shape: Edges and surfaces parallel
- Surfaces double cut, one edge uncut, one edge single cut
- Type of cut: 1 = Bastard, 2 = Second, 3=Smooth

	 731151		A mm	B mm	C mm	 T/cm		 g
1-100-04-1-2	8244125	5	100	12	3.0	17	1	67
1-100-04-2-2	8244132	5	100	12	3.0	22	2	67
1-100-06-1-2	8000233	5	150	16	4.0	13	1	110
1-100-06-2-2	8003593	5	150	16	4.0	18	2	110
1-100-08-1-2	8000264	5	200	20	5.0	10	1	200
1-100-08-2-2	8003609	5	200	20	5.0	14	2	200
1-100-08-3-2	8295585	5	200	20	5.0	18	3	200
1-100-10-1-2	8000295	5	250	25	5.5	9	1	310
1-100-10-2-2	8003616	5	250	25	5.5	12	2	310
1-100-10-3-2	8295592	5	250	25	5.5	16	3	310
1-100-12-1-2	8028053	5	300	30	6.0	8	1	431
1-100-12-2-2	8244118	5	300	30	6.0	11	2	431
1-100-12-3-2	8295608	5	300	30	6.0	14	3	431



1-102

PILLAR FILE

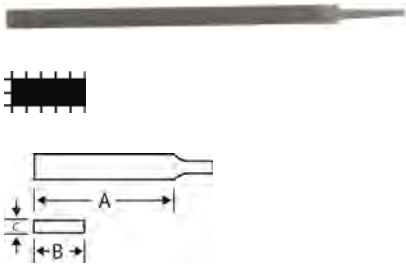

- For jobs where a standard hand file, ref 1-100, is too wide or too thick, e.g. for filing of narrow grooves
- For the manufacture of dies and punches, etc
- Shape: Edges and surfaces parallel
- Surfaces double cut. One edge uncut, one edge single cut
- Pillar file is a hand file of a slimmer design
- Type of cut: 1 = Bastard, 2 = Second, 3 = Smooth

	 731151		A mm	B mm	C mm	 T/cm		 g
1-102-06-2-0	8019198	10	150	9	2.0	18	2	20
1-102-06-3-0	8019204	10	150	9	2.0	22	3	20
1-102-08-1-0	8019211	10	200	12	3.0	12	1	50
1-102-08-2-0	8019228	10	200	12	3.0	14	2	50
1-102-08-3-0	8019235	10	200	12	3.0	18	3	50

1-104

LATHE FILE

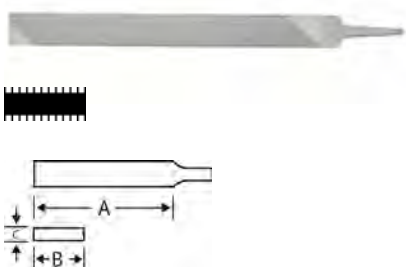

- For polishing and deburring work on lathes
- Releases chips easily and produces smooth surfaces
- Shape: Edges and surfaces parallel
- Surfaces single cut with large cutting angle, edges uncut
- Type of cut: 2 = Second, 3 = Smooth

	 731151		A mm	B mm	C mm	 T/cm		 g
1-104-10-2-0	8019242	10	250	25	5.5	12	2	260
1-104-10-3-0	8019259	10	250	25	5.5	16	3	260
1-104-12-2-0	8019266	5	300	30	6.0	11	2	418
1-104-12-3-0	8019273	5	300	30	6.0	14	3	418
1-104-14-3-0	8019297	5	350	35	6.5	13	3	600

1-106...-0

HAND FILE "OBERG CUT" INDUSTRY PACK, UNHANDLED

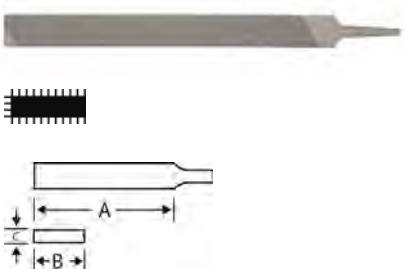

- Useful for all flat filing
- Oberg cut gives a high removal rate and smooth surface finish on most materials
- Shape: Edges and surfaces parallel
- Surfaces single cut, bastard, with chipbreaking teeth, one edge single cut
- Type of cut: 1 = Bastard

	 731151		A mm	B mm	C mm	 T/cm		 g
1-106-08-1-0	8019303	10	200	20	5.0	10	1	145
1-106-10-1-0	8019310	10	250	25	5.5	9	1	240
1-106-12-1-0	8019327	5	300	30	6.0	8	1	372



1-106...-2

HAND FILE "OBERG CUT" SINGLE PACK CARDED

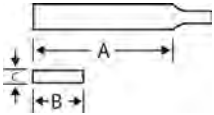

- File handle developed according to the scientific ERGO™ process
- Useful for all flat filing
- Oberg cut gives a high removal rate and smooth surface finish on most materials
- Shape: Edges and surfaces parallel
- Surfaces single cut, bastard, with chipbreaking teeth, one edge single cut
- Type of cut: 1 = Bastard

	 731151		A mm	B mm	C mm	 T/cm		 g
1-106-08-1-2	8000301	5	200	20	5.0	10	1	200
1-106-10-1-2	8000325	5	250	25	5.5	9	1	310
1-106-12-1-2	8295615	5	300	30	6.0	8	1	431

1-110...-0

FLAT FILE INDUSTRY PACK, UNHANDLED

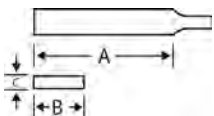

- For the same jobs as the hand file 100
- Sometimes preferred because its pointed shape enables the user to reach more easily into angles and corners
- Shape: Edges tapered towards the tip, surfaces parallel
- Surfaces double cut, edges single cut
- Type of cut: 1 = Bastard, 2 = Second, 3 = Smooth

	 731151		A mm	B mm	C mm	 T/cm		 g
1-110-04-1-0	8019334	10	100	12	3.0	17	1	27
1-110-04-2-0	8019341	10	100	12	3.0	22	2	27
1-110-04-3-0	8044046	10	100	12	3.0	28	2	27
1-110-06-1-0	8019358	10	150	16	4.0	13	1	60
1-110-06-2-0	8019365	10	150	16	4.0	18	2	60
1-110-06-3-0	8019372	10	150	16	4.0	22	3	60
1-110-08-1-0	8019389	10	200	20	5.0	10	1	130
1-110-08-2-0	8019396	10	200	20	5.0	14	2	130
1-110-08-3-0	8019402	10	200	20	5.0	18	2	130
1-110-10-1-0	8019419	10	250	25	5.5	9	1	245
1-110-10-2-0	8019426	10	250	25	5.5	12	2	245
1-110-10-3-0	8019433	10	250	25	5.5	16	3	245
1-110-12-1-0	8019440	5	300	30	6.0	8	1	368
1-110-12-2-0	8019457	5	300	30	6.0	11	2	368
1-110-12-3-0	8019464	5	300	30	6.0	14	3	368
1-110-14-1-0	8019488	5	350	35	6.5	7	1	570



1-110...-2

FLAT FILE SINGLE PACK CARDED

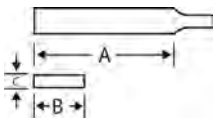

- File handle developed according to the scientific ERGO™ process
- Pointed shape enables the user to reach more easily into angles and corners
- Shape: Edges tapered towards the tip, surfaces parallel
- Surfaces double cut, edges single cut
- Type of cut: 1 = Bastard, 2 = Second, 3=Smooth

	731151		A mm	B mm	C mm	T/cm		g
1-110-06-1-2	8295622	5	150	16	4.0	13	1	110
1-110-06-2-2	8003623	5	150	16	4.0	18	2	110
1-110-06-3-2	8295639	5	150	16	4.0	22	3	110
1-110-08-1-2	8000332	5	200	20	5.0	10	1	180
1-110-08-2-2	8003630	5	200	20	5.0	14	2	180
1-110-08-3-2	8295646	5	200	20	5.0	18	3	180
1-110-10-1-2	8000349	5	250	25	5.5	9	1	270
1-110-10-2-2	8003647	5	250	25	5.5	12	2	270
1-110-10-3-2	8295653	5	250	25	5.5	16	3	270
1-110-12-1-2	8295660	5	300	30	6.0	8	1	431
1-110-12-2-2	8295677	5	300	30	6.0	11	2	431
1-110-12-3-2	8295684	5	300	30	6.0	14	3	431

1-111...-0

WARDING FILE INDUSTRY PACK, UNHANDLED

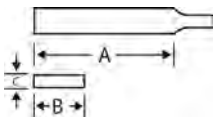

- For filing narrow grooves and passages, etc
- Particularly well suited for filing cuts on keys
- Shape: Edges tapered to a point, surfaces parallel
- Surfaces double cut, edges single cut
- Type of cut: 1 = Bastard, 2 = Second, 3 = Smooth

	731151		A mm	B mm	C mm	T/cm		g
1-111-04-1-0	8044053	10	100	10.0	1.2	17	1	8
1-111-04-2-0	8019518	10	100	10.0	1.2	22	2	8
1-111-04-3-0	8019525	10	100	10.0	1.2	28	3	8
1-111-06-1-0	8019549	10	150	15.0	1.9	14	1	22
1-111-06-2-0	8019556	10	150	15.0	1.9	18	2	22
1-111-06-3-0	8019563	10	150	15.0	1.9	22	3	22
1-111-08-1-0	8019570	10	200	20.0	2.5	10	1	71
1-111-08-2-0	8019587	10	200	20.0	2.5	14	2	71



1-111...-2

WARDING FILE SINGLE PACK CARDED

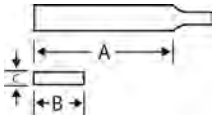

- File handle developed according to the scientific ERGO™ process
- For filing narrow grooves and passages, etc
- Particularly well suited for filing cuts on keys
- Shape: Edges tapered to a point, surfaces parallel
- Surfaces double cut, edges single cut
- Type of cut: 2 = Second

			A mm	B mm	C mm			
1-111-06-2-2	8000363	5	150	15	1.9	18	2	65

1-115

CONTACT FILE

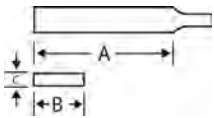

- For cleaning, polishing and adjustment of electrical contacts
- Most commonly used in automotive electrical systems
- Shape: Parallel uncut edges. Surfaces parallel to within 1 mm of the end, then ground to knife edge
- Surface single cut over end 45 mm
- Two files in a plastic sleeve
- Type of cut: 3 = Smooth

			A mm	B mm	C mm			
1-115-11-3-1	8003791	10	110	8	1	28	3	39

1-143...-0

MILL FILE, 2 FLAT EDGES (TYPE USA) INDUSTRY PACK, UNHANDLED

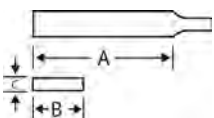

- Suitable both as an engineering file and a sharpening file
- Useful for filing where a smooth finish is important
- Good for polishing and deburring work on lathes
- Widely applicable for sharpening tools and implements such as spades, shovels, hoes, scrapers, etc
- Shape: Surfaces parallel, edges tapered towards the tip
- Surfaces and edges single cut
- Bastard cut commonly referred to as Mill bastard
- Type of cut: 1 = Bastard

			A mm	B mm	C mm			
1-143-06-1-0	8019631	10	150	16	2.7	20	1	45
1-143-08-1-0	8019662	10	200	20	3.3	18	1	92
1-143-10-1-0	8019693	10	250	25	4.0	16	1	173
1-143-12-1-0	8019723	5	300	30	5.0	14	1	332



1-143...-2

MILL FILE, 2 FLAT EDGES (TYPE USA)
SINGLE PACK CARDED

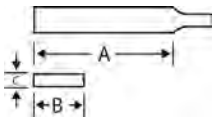

- File handle developed according to the scientific ERGO™ process
- Suitable both as an engineering file and a sharpening file
- Useful for filing where a smooth finish is important
- Good for polishing and deburring work on lathes
- Widely applicable for sharpening tools and implements such as spades, shovels, hoes, scrapers, etc
- Shape: Surfaces parallel, edges tapered towards the tip
- Surfaces and edges single cut
- Bastard cut commonly referred to as Mill bastard
- Type of cut: 1 = Bastard

	 731151		A mm	B mm	C mm	 T/cm		 g
1-143-06-1-2	8022341	5	150	16	2.7	20	1	90
1-143-08-1-2	8028077	5	200	20	3.3	18	1	140
1-143-10-1-2	8022358	5	250	25	4.0	16	1	222
1-143-12-1-2	8295691	5	300	30	5.0	14	1	431

1-160...-0

SQUARE FILE INDUSTRY PACK, UNHANDLED

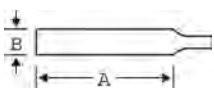

- For filing grooves, rectangular holes, inside corners and for fine-adjustment of cutting tools
- Shape: Surfaces tapered towards the tip
- Double cut
- Type of cut: 1 = Bastard, 2 = Second, 3 = Smooth

	 731151		A mm	B mm	 T/cm		 g
1-160-04-1-0	8019785	10	100	4.5	17	1	15
1-160-04-2-0	8019792	10	100	4.5	22	2	15
1-160-04-3-0	8019808	10	100	4.5	28	3	15
1-160-06-1-0	8019815	10	150	6.0	13	1	36
1-160-06-2-0	8019822	10	150	6.0	18	2	36
1-160-06-3-0	8019839	10	150	6.0	22	3	36
1-160-08-1-0	8019846	10	200	8.0	10	1	89
1-160-08-2-0	8019853	10	200	8.0	14	2	89
1-160-08-3-0	8019860	10	200	8.0	18	3	89
1-160-10-1-0	8019877	10	250	10.0	9	1	182
1-160-10-2-0	8019884	10	250	10.0	12	2	182
1-160-10-3-0	8019891	10	250	10.0	16	3	182
1-160-12-1-0	8019907	5	300	12.0	8	1	300
1-160-12-2-0	8019914	5	300	12.0	11	2	300



1-160...-2

SQUARE FILE SINGLE PACK CARDED

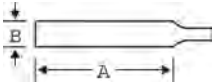

- File handle developed according to the scientific ERGO™ process
- For filing grooves, rectangular holes, inside corners and for fine-adjustment of cutting tools
- Shape: Surfaces tapered towards the tip
- Double cut
- Type of cut: 1 = Bastard, 2 = Second, 3 = Smooth

	 731151		A mm	B mm	 T/cm		
1-160-04-1-2	8244057	5	100	4.5	17	1	42
1-160-04-2-2	8244095	5	100	4.5	22	2	42
1-160-06-1-2	8000370	5	150	6.0	13	1	79
1-160-06-2-2	8003685	5	150	6.0	18	2	79
1-160-06-3-2	8295707	5	150	6.0	22	3	79
1-160-08-1-2	8000394	5	200	8.0	10	1	132
1-160-08-2-2	8003692	5	200	8.0	14	2	132
1-160-08-3-2	8295714	5	200	8.0	18	3	132
1-160-10-1-2	8000400	5	250	10.0	9	1	212
1-160-10-2-2	8295721	5	250	10.0	12	2	212
1-160-10-3-2	8295738	5	250	10.0	16	3	212
1-160-12-1-2	8295745	5	300	12	8	1	347
1-160-12-2-2	8295752	5	300	12	11	2	347

1-170...-0

THREE SQUARE FILE INDUSTRY PACK, UNHANDLED

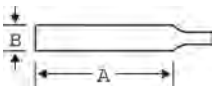

- For deburring and filing angles and inner corners
- Its tapered surfaces make it well suited for flat filing
- Shape: Equilateral triangle, tapered towards the tip
- Double cut surfaces
- Type of cut: 1 = Bastard, 2 = Second, 3 = Smooth

	 731151		A mm	B mm	 T/cm		
1-170-04-1-0	8044060	10	100	6.2	16	1	19
1-170-04-2-0	8019945	10	100	6.2	22	2	19
1-170-04-3-0	8019952	10	100	6.2	28	3	19
1-170-06-1-0	8019969	10	150	11.0	13	1	57
1-170-06-2-0	8019976	10	150	11.0	18	2	57
1-170-06-3-0	8019983	10	150	11.0	22	3	57
1-170-08-1-0	8019990	10	200	15.5	10	1	160
1-170-08-2-0	8020002	10	200	15.5	14	2	160
1-170-08-3-0	8020019	10	200	15.5	18	3	160
1-170-10-1-0	8020026	10	250	17.5	9	1	245
1-170-10-2-0	8020033	10	250	17.5	12	2	245
1-170-10-3-0	8020040	10	250	17.5	16	3	245
1-170-12-1-0	8020057	5	300	19.5	8	1	370
1-170-12-2-0	8020064	5	300	19.5	11	2	370



1-170...-2

THREE SQUARE FILE SINGLE PACK CARDED

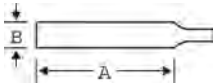

- File handle developed according to the scientific ERGO™ process
- For deburring and filing angles and inner corners
- Its tapered surfaces make it well suited for flat filing
- Shape: Equilateral triangle, tapered towards the tip
- Double cut surfaces
- Type of cut: 1 = Bastard, 2 = Second, 3 = Smooth

	 731151		A mm	B mm	 T/cm		 g
1-170-04-2-2	8244088	5	100	6.2	22	2	56
1-170-06-1-2	8244071	5	150	11.0	13	1	94
1-170-06-2-2	8003715	5	150	11.0	18	2	103
1-170-06-3-2	8295769	5	150	11.0	22	3	103
1-170-08-1-2	8000417	5	200	15.5	10	1	203
1-170-08-2-2	8003722	5	200	15.5	14	2	203
1-170-08-3-2	8295783	5	200	15.5	18	3	203
1-170-10-1-2	8028107	5	250	17.5	9	1	282
1-170-10-2-2	8244064	5	250	17.5	12	2	282
1-170-10-3-2	8295806	5	250	17.5	16	3	282

1-210...-0

HALF-ROUND FILE INDUSTRY PACK, UNHANDLED

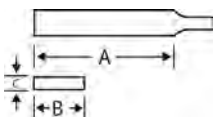

- For filing concave and flat surfaces and large holes
- Suitable for deburring work
- Shape: Edges and surfaces tapered towards the tip
- 4" and 6" fully pointed, 8" and longer semi-pointed
- Double cut
- Type of cut: 1 = Bastard, 2 = Second, 3 = Smooth

	 731151		A mm	B mm	C mm	 T/cm		 g
1-210-04-1-0	8020071	10	100	10.0	3.0	17	1	15
1-210-04-2-0	8020088	10	100	10.0	3.0	22	2	15
1-210-04-3-0	8020095	10	100	10.0	3.0	28	3	15
1-210-06-1-0	8020101	10	150	16.0	4.7	13	1	52
1-210-06-2-0	8020118	10	150	16.0	4.7	18	2	52
1-210-06-3-0	8020125	10	150	16.0	4.7	22	3	52
1-210-08-1-0	8020132	10	200	20.5	6.0	10	1	127
1-210-08-2-0	8020149	10	200	20.5	6.0	14	2	127
1-210-08-3-0	8020156	10	200	20.5	6.0	18	3	127
1-210-10-1-0	8020163	10	250	26.5	7.5	9	1	243
1-210-10-2-0	8020170	10	250	26.5	7.5	12	2	243
1-210-10-3-0	8020187	10	250	26.5	7.5	16	3	243
1-210-12-1-0	8020194	5	300	31.0	9.0	8	1	435
1-210-12-2-0	8020200	5	300	31.0	9.0	11	2	435
1-210-12-3-0	8020217	5	300	31.0	9.0	14	3	435
1-210-14-1-0	8020224	5	350	35.0	10.0	7	1	630



1-210...-2

HALF-ROUND FILE SINGLE PACK CARDED

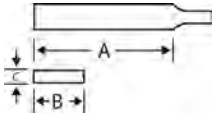

- File handle developed according to the scientific ERGO™ process
- For filing concave and flat surfaces and large holes. Suitable for deburring work
- Shape: Edges and surfaces tapered towards the tip
- 4" and 6" fully pointed, 8" and longer semi-pointed
- Double cut
- Type of cut: 1 = Bastard, 2 = Second, 3 = Smooth

	 731151		A mm	B mm	C mm	 T/cm		 g
1-210-04-1-2	8243944	5	100	10.0	3.0	17	1	52
1-210-04-2-2	8244040	5	100	10.0	3.0	22	2	52
1-210-06-1-2	8000424	5	150	16.0	4.7	13	1	100
1-210-06-2-2	8003654	5	150	16.0	4.7	18	2	100
1-210-06-3-2	8293574	5	150	16.0	4.7	22	3	100
1-210-08-1-2	8000455	5	200	20.5	6.0	10	1	170
1-210-08-2-2	8000479	5	200	20.5	6.0	14	2	170
1-210-08-3-2	8295837	5	200	20.5	6.0	18	3	170
1-210-10-1-2	8000493	5	250	26.5	7.5	9	1	344
1-210-10-2-2	8003661	5	250	26.5	7.5	12	2	344
1-210-10-3-2	8295844	5	250	26.5	7.5	16	3	344
1-210-12-1-2	8028121	5	300	31.0	9.0	8	1	480
1-210-12-2-2	8244149	5	300	31.0	9.0	11	2	480
1-210-12-3-2	8295851	5	300	31.0	9.0	14	3	480

1-230...-0

ROUND FILE INDUSTRY PACK, UNHANDLED

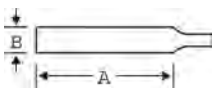

- For filing holes, large fillets and concave surfaces
- Shape: Tapered towards the point
- 4" and 6" fully pointed, 8" and longer semi-pointed
- Double cut
- Type of cut: 1 = Bastard, 2 = Second, 3 = Smooth

	 731151		A mm	B mm	 T/cm		 g
1-230-04-1-0	8020248	10	100	3.6	17	1	9
1-230-04-2-0	8020255	10	100	3.6	22	2	9
1-230-04-3-0	8020262	10	100	3.6	28	3	9
1-230-06-1-0	8020279	10	150	6.0	13	1	29
1-230-06-2-0	8020286	10	150	6.0	18	2	29
1-230-06-3-0	8020293	10	150	6.0	22	3	29
1-230-08-1-0	8020309	10	200	8.0	10	1	72
1-230-08-2-0	8020316	10	200	8.0	14	2	72
1-230-08-3-0	8020323	10	200	8.0	18	3	72
1-230-10-1-0	8020330	10	250	10.0	9	1	144
1-230-10-2-0	8020347	10	250	10.0	12	2	144
1-230-10-3-0	8020354	10	250	10.0	16	3	144
1-230-12-1-0	8020361	5	300	12.0	8	1	247
1-230-12-2-0	8020378	5	300	12.0	11	2	247
1-230-12-3-0	8020385	5	300	12.0	14	3	247



1-230...-2

ROUND FILE SINGLE PACK CARDED

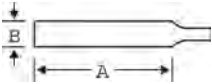

- File handle developed according to the scientific ERGO™ process
- For filing holes, large fillets and concave surfaces
- Shape: Tapered towards the tip
- 4" and 6" fully pointed, 8" and longer semi-pointed
- Double cut
- Type of cut: 1 = Bastard, 2 = Second, 3 = Smooth

	 731151		A mm	B mm	 T/cm		 g
1-230-04-1-2	8244163	5	100	3.6	17	1	39
1-230-04-2-2	8244156	5	100	3.6	22	2	39
1-230-06-1-2	8000509	5	150	6.0	13	1	74
1-230-06-2-2	8000523	5	150	6.0	18	2	74
1-230-08-1-2	8000547	5	200	8.0	10	1	112
1-230-08-2-2	8000554	5	200	8.0	14	2	112
1-230-10-1-2	8000578	5	250	10.0	9	1	183
1-230-10-2-2	8003678	5	250	10.0	12	2	183
1-230-10-3-2	8295899	5	250	10.0	16	3	183
1-230-12-1-2	8295912	5	300	12.0	8	1	297
1-230-12-2-2	8295929	5	300	12.0	11	2	297

1-320...-0

DIAGONAL FILE INDUSTRY PACK, UNHANDLED

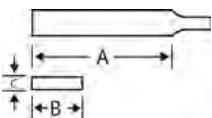

- Material removal is much higher in some materials than with double or single cut files
- The shape of the teeth makes the diagonal file especially suitable for soft steel, stainless steel, light metal alloys and hard plastic
- Shape: Edges and surfaces parallel
- Surfaces diagonally milled with s-pattern chipbreaker, one edge single cut
- Type of cut: 2 = Second

	 731151		A mm	B mm	C mm	 T/cm		 g
1-320-08-2-0	8191276	10	200	20	4.5	14	2	110
1-320-10-2-0	8020477	10	250	25	5.0	14	2	180
1-320-12-2-0	8020484	5	300	30	5.5	12	2	305



1-476

FILE SETS



- File handle developed according to the scientific ERGO™ process
- A set for fine filing and polishing jobs
- Each set contains one handled file each of: hand, warding, square, three square, half round and round
- Supplied in a snap-shut plastic wallet with hanging hole
- Type of cut: 3 = Smooth

	 731151		 mm		 g
1-476-04-3-2	8010928	1	100	3	200

1-476-04-3-2

1-160-04-3-2; 1-111-04-3-2; 1-230-04-3-2; 1-170-04-3-2; 1-210-04-3-2; 1-100-04-3-2;

1-473

FILE SETS



- File handle developed according to the scientific ERGO™ process
- For filing flat surfaces, sharp corners and shoulders as well as for deburring
- For filing holes, large fillets and concave surfaces
- High removal rate
- Sets of three files with handle
- Cardboard outer display packaging containing plastic roll up wallet
- Contains one each of: hand, half round and round engineering files
- Type of cut: 2 = Second

	 731151		 mm		 g
1-473-06-2-2	8201098	5	150	2	395
1-473-08-2-2	8201104	5	200	2	635
1-473-10-2-2	8201111	5	250	2	925

1-473-06-2-2

1-230-06-2-2; 1-210-06-2-2; 1-100-06-2-2;

1-473-08-2-2

1-230-08-2-2; 1-210-08-2-2; 1-100-08-2-2;

1-473-10-2-2

1-230-10-2-2; 1-210-10-2-2; 1-100-10-2-2;









1-477

FILE SETS

ergo®



- File handle developed according to the scientific ERGO™ process
- For filing flat surfaces, sharp corners and shoulders as well as for deburring
- For filing holes, large fillets and concave surfaces
- For wood applications
- High removal rate
- Sets of five files with handle
- Cardboard outer display packaging containing plastic roll up wallet
- Contains one each of: hand, half round, round, three square engineering files and a half round rasp
- Type of cut: 2 = Second

	 731151		 mm		 g
1-477-08-2-2	8037994	5	200	2	960
1-477-10-2-2	8201074	5	250	2	1490

1-477-08-2-2

1-100-08-2-2; 1-210-08-2-2; 6-343-08-2-2; 1-230-08-2-2; 1-170-08-2-2, 

1-477-10-2-2

1-100-10-2-2; 1-210-10-2-2; 6-343-10-2-2; 1-230-10-2-2; 1-170-10-2-2, 







1-478

FILE SETS

ergo®



- File handle developed according to the scientific ERGO™ process
- For filing flat surfaces, sharp corners and shoulders as well as for deburring
- For filing holes, large fillets and concave surfaces
- High removal rate
- Set of five files with handle
- Cardboard outer display packaging containing plastic roll up wallet
- Contains one each of: hand bastard, hand second, square bastard, half round bastard, round bastard
- Type of cut: 1 = Bastard

	 731151		 mm		 g
1-478-08-1-2	8141127	5	200	1&2	900
1-478-10-1-2	8241995	5	250	1&2	1100

1-478-08-1-2

1-210-08-1-2; 1-230-08-1-2; 1-100-08-1-2; 1-100-08-2-2; 1-160-08-1-2, 

1-478-10-1-2

1-210-10-1-2; 1-230-10-1-2; 1-100-10-1-2; 1-100-10-2-2; 1-160-10-1-2, 



1-479

FILE SETS



- File handle developed according to the scientific ERGO™ process
- For carpentry and repair jobs
- High removal rate
- Sets of five files with handle
- Cardboard outer display packaging containing plastic roll up wallet
- Contains one each of: hand, half round and round engineering files, a flat sharpening file and a cabinet rasp
- Type of cut: 1 = Bastard, 2 = Second

	 731151		 mm		 g
1-479-08-1-2	8176747	5	200	1	935
1-479-08-2-2	8180607	5	200	2	935

1-479-08-1-2	
4-138-08-1-2; 1-210-08-1-2; 6-343-08-2-2; 1-230-08-1-2; 1-100-08-1-2 ,	
1-479-08-2-2	
4-138-08-1-2; 1-210-08-2-2; 6-343-08-2-2; 1-230-08-2-2; 1-100-08-2-2 ,	

6-470

FILE SETS



- File handle developed according to the scientific ERGO™ process
- For carpentry jobs
- High removal rate
- Sets of three files with handle
- Cardboard outer display packaging containing plastic roll up wallet
- Contains one each of: half round rasp, round rasp, homeowner's file for wood
- Type of cut: 2 = Second

	 731151		 mm		 g
6-470-08-2-2	8242008	5	200	2	635

6-470-08-2-2	
6-345-08-2-2; 6-342-08-2-2; 4-152-08-2-2 ,	



2-300

HAND

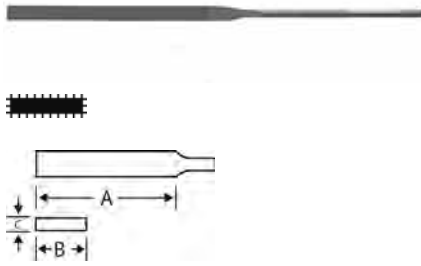

- For fine filing and polishing jobs
- Used by engravers, precision engineers, instrument makers, watchmakers and goldsmiths
- Shape: Edges and surfaces parallel
- Surfaces double cut, edges single cut
- Type of cut: 0 = Bastard, 1 = Second, 2 = Smooth, 4 = Dead smooth

	 731151		A mm	B mm	C mm	 T/cm		 g	
	2-300-14-0-0	8044138	10	140	5.0	1.3	22	0	6
	2-300-14-2-0	8044145	10	140	5.0	1.3	34	2	6
	2-300-14-4-0	8108786	10	140	5.0	1.3	48	4	6
	2-300-16-0-0	8020491	10	160	5.6	1.4	22	0	9
	2-300-16-1-0	8020507	10	160	5.6	1.4	26	1	9
	2-300-16-2-0	8020514	10	160	5.6	1.4	34	2	9
	2-300-16-4-0	8020521	10	160	5.6	1.4	48	4	9
	2-300-18-0-0	8190545	10	180	6.2	1.6	22	0	13
	2-300-18-2-0	8190552	10	180	6.2	1.6	34	2	13

2-301

FLAT

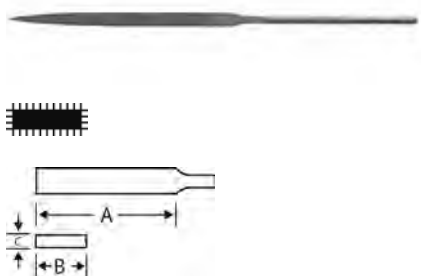

- For fine filing and polishing jobs
- Used by engravers, precision engineers, instrument makers, watchmakers and goldsmiths
- Shape: Surfaces parallel, edges taper to a point
- Surfaces double cut, edges single cut
- Type of cut: 0 = Bastard, 1 = Second, 2 = Smooth

	 731151		A mm	B mm	C mm	 T/cm		 g	
	2-301-14-0-0	8190569	10	140	5.0	1.3	22	0	6
	2-301-14-2-0	8108748	10	140	5.0	1.3	34	2	6
	2-301-16-0-0	8108755	10	160	5.6	1.4	22	0	8
	2-301-16-1-0	8020538	10	160	5.6	1.4	26	1	8
	2-301-16-2-0	8020545	10	160	5.6	1.4	34	2	8



NEEDLE FILES

2-302

THREE SQUARE

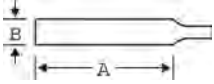

- For fine filing and polishing jobs
- Used by engravers, precision engineers, instrument makers, watchmakers and goldsmiths
- Shape: Triangular, surfaces taper to a point
- Surfaces double cut
- Type of cut: 0 = Bastard, 1 = Second, 2 = Smooth, 4 = Dead smooth

	 731151		A mm	B mm	 T/cm		 9
2-302-14-0-0	8044152	10	140	3.3	22	0	6
2-302-14-2-0	8044169	10	140	3.3	34	2	6
2-302-14-4-0	8108793	10	140	3.3	48	4	6
2-302-16-0-0	8108762	10	160	3.8	22	0	9
2-302-16-1-0	8020552	10	160	3.8	26	1	9
2-302-16-2-0	8020569	10	160	3.8	34	2	9
2-302-16-4-0	8108809	10	160	3.8	48	4	9
2-302-18-0-0	8190613	10	180	4.3	22	0	13
2-302-18-2-0	8190620	10	180	4.3	34	2	13

2-303

SQUARE

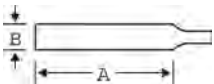

- For fine filing and polishing jobs
- Used by engravers, precision engineers, instrument makers, watchmakers and goldsmiths
- Shape: Square, surfaces taper to a point
- Surfaces double cut
- Type of cut: 0 = Bastard, 1 = Second, 2 = Smooth, 4 = Dead smooth

	 731151		A mm	B mm	 T/cm		 9
2-303-14-2-0	8044176	10	140	2.4	34	2	6
2-303-16-0-0	8108779	10	160	2.4	22	0	7
2-303-16-1-0	8020576	10	160	2.4	26	1	7
2-303-16-2-0	8020583	10	160	2.4	34	2	7
2-303-16-4-0	8108830	10	160	2.4	48	4	7
2-303-18-0-0	8190644	10	180	2.8	22	0	9
2-303-18-2-0	8190668	10	180	2.8	34	2	9



2-304

HALF ROUND

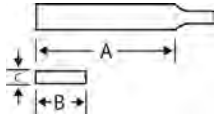

- For fine filing and polishing jobs
- Used by engravers, precision engineers, instrument makers, watchmakers and goldsmiths
- Shape: Surfaces taper to a point, flat and convex surfaces double cut
- Type of cut: 0 = Bastard, 1 = Second, 2 = Smooth, 4 = Dead smooth

	 731151		A mm	B mm	C mm	 T/cm		 g
2-304-14-0-0	8044183	10	140	5.0	1.8	22	0	8
2-304-14-2-0	8044190	10	140	5.0	1.8	34	2	8
2-304-14-4-0	8108878	10	140	5.0	1.8	48	4	8
2-304-16-0-0	8020590	10	160	5.8	1.8	22	0	9
2-304-16-1-0	8020606	10	160	5.8	1.8	26	1	9
2-304-16-2-0	8020613	10	160	5.8	1.8	34	2	9
2-304-16-4-0	8020620	10	160	5.8	1.8	48	4	9
2-304-18-0-0	8190712	10	180	6.2	2.1	22	0	13
2-304-18-2-0	8190736	10	180	6.2	2.1	34	2	13

2-305

OVAL

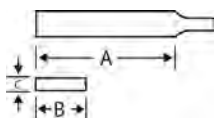

- For fine filing and polishing jobs
- Used by engravers, precision engineers, instrument makers, watchmakers and goldsmiths
- Shape: Oval, surfaces taper to a point
- Double cut
- Type of cut: 1 = Second, 2 = Smooth

	 731151		A mm	B mm	C mm	 T/cm		 g
2-305-16-1-0	8020637	10	160	3.9	2.7	26	1	9
2-305-16-2-0	8108908	10	160	3.9	2.7	34	2	9

2-306

CROSSING

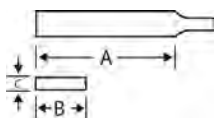

- For fine filing and polishing jobs
- Used by engravers, precision engineers, instrument makers, watchmakers and goldsmiths
- Shape: Two convex surfaces of different radii, tapering to a point
- Surfaces double cut
- Type of cut: 1 = Second, 2 = Smooth

	 731151		A mm	B mm	C mm	 T/cm		 g
2-306-16-1-0	8020644	10	160	4.9	2.2	26	1	7
2-306-16-2-0	8108854	10	160	4.9	2.2	34	2	7



NEEDLE FILES

2-307

ROUND

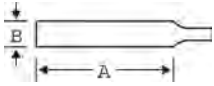

- For fine filing and polishing jobs
- Used by engravers, precision engineers, instrument makers, watchmakers and goldsmiths
- Shape: Round
- Surfaces taper to a point, double cut
- Type of cut: 0 = Bastard, 1 = Second, 2 = Smooth, 4 = Dead smooth

	 731151		A mm	B mm	 T/cm		 g
2-307-14-0-0	8044206	10	140	2.8	22	0	5
2-307-14-2-0	8044213	10	140	2.8	34	2	5
2-307-14-4-0	8108885	10	140	2.8	48	4	5
2-307-16-0-0	8020651	10	160	3.0	22	0	7
2-307-16-1-0	8020668	10	160	3.0	26	1	7
2-307-16-2-0	8020675	10	160	3.0	34	2	7
2-307-16-4-0	8020682	10	160	3.0	48	4	7
2-307-18-0-0	8190965	10	180	3.3	22	0	13
2-307-18-2-0	8190972	10	180	3.3	34	2	13

2-308

KNIFE

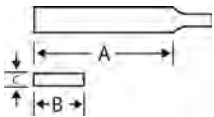

- For fine filing and polishing jobs
- Used by engravers, precision engineers, instrument makers, watchmakers and goldsmiths
- Shape: Conical, edges and surfaces taper to a point
- Flat, uncut back
- Surfaces double cut, thin edge single cut
- Type of cut: 0 = Bastard, 1 = Second, 2 = Smooth

	 731151		A mm	B mm	C mm	 T/cm		 g
2-308-14-2-0	8044220	10	140	5.3	1.6	34	2	6
2-308-16-0-0	8108861	10	160	5.3	1.7	22	0	8
2-308-16-1-0	8020699	10	160	5.3	1.7	26	1	8
2-308-16-2-0	8020705	10	160	5.3	1.7	34	2	8

2-309

BARRETTE

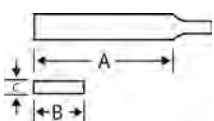

- For fine filing and polishing jobs
- Used by engravers, precision engineers, instrument makers, watchmakers and goldsmiths
- Shape: Triangular, one surface extra wide
- Surfaces and edges taper to a point
- Wider surface double cut, edges and narrower surfaces uncut
- Type of cut: 2 = Smooth, 4 = Dead smooth

	 731151		A mm	B mm	C mm	 T/cm		 g
2-309-16-2-0	8108946	10	160	5.0	1.9	34	2	10
2-309-16-4-0	8191054	10	160	5.0	1.9	48	4	10



2-313

MARKING

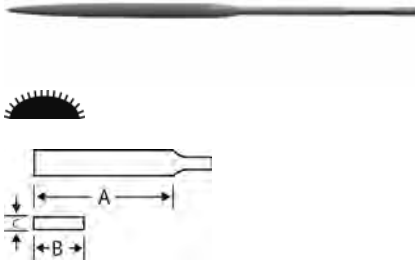

- For fine filing and polishing jobs
- Used by engravers, precision engineers, instrument makers, watchmakers and goldsmiths
- Shape: Conventional half round needle file
- Surface tapers to a point
- Double cut on radius with uncut flat side
- Type of cut: 0 = Bastard

			A mm	B mm	C mm			
2-313-16-0-0	8191177	10	160	5.8	1.8	22	0	10

2-470

NEEDLE FILE SETS



- For fine filing and polishing jobs
- Used by engravers, precision engineers, instrument makers, watchmakers and goldsmiths
- Set of 6 files in snap-shut plastic wallet with hanging hole
- Contains one file each of: hand, flat, half round, round, three square and square
- Includes one handle 9-488-02-10
- Type of cut: 0 = Bastard, 1 = Second, 2 = Smooth, 4 = Dead smooth

2-470-14-0-0	8191191	1	140	22	0	60
2-470-14-2-0	8109080	1	140	34	2	60
2-470-14-4-0	8191207	1	140	48	4	60
2-470-16-1-0	8010942	10	160	26	1	70
2-470-16-2-0	8109097	10	160	34	2	70

2-470-14-0-0 9-488-02-10; 2-304-14-0-0; 2-300-14-0-0; 2-303-14-0-0; 2-302-14-0-0; 2-301-14-0-0; 2-307-14-0-0	
2-470-14-2-0 9-488-02-10; 2-304-14-2-0; 2-300-14-2-0; 2-303-14-2-0; 2-302-14-2-0; 2-301-14-2-0; 2-307-14-2-0	
2-470-14-4-0 9-488-04-10; 2-304-14-4-0; 2-300-14-4-0; 2-303-14-4-0; 2-302-14-4-0; 2-301-14-4-0; 2-307-14-4-0	
2-470-16-1-0 9-488-04-10; 2-304-16-1-0; 2-300-16-1-0; 2-303-16-1-0; 2-302-16-1-0; 2-301-16-1-0; 2-307-16-1-0	
2-470-16-2-0 9-488-04-10; 2-304-16-2-0; 2-300-16-2-0; 2-303-16-2-0; 2-302-16-2-0; 2-301-16-2-0; 2-307-16-2-0	



NEEDLE FILES

2-471

NEEDLE FILE SETS



- For fine filing and polishing jobs
- Used by engravers, precision engineers, instrument makers, watchmakers and goldsmiths
- Set of 9 files in snap-shut plastic wallet with hanging hole
- Contains one file each of: hand, flat, half round, round, three square, square, oval, crossing and knife
- Includes one handle 9-488-02-10
- Type of cut: 1 = Second

	 731151		 mm	 T/cm		 g
2-471-16-1-0	8010959	5	160	26	1	95

2-471-16-1-0

9-488-02-10; 2-303-16-1-0; 2-304-16-1-0; 2-302-16-1-0; 2-300-16-1-0; 2-308-16-1-0; 2-301-16-1-0; 2-306-16-1-0; 2-305-16-1-0; 2-307-16-1-0



2-472

NEEDLE FILE SETS



- For fine filing and polishing jobs
- Used by engravers, precision engineers, instrument makers, watchmakers and goldsmiths
- Set of 12 files in snap-shut plastic wallet with hanging hole
- Contains one file each of: hand, flat, three square, square, half round, crossing, round, knife, barrette, slitting, round-edge joint and marking
- Includes one handle 9-488-02-10
- Type of cut: 0 = Bastard, 1 = Second, 2 = Smooth

	 731151		 mm	 T/cm		 g
2-472-14-0-0	8191214	5	140	22	0	90
2-472-14-2-0	8109103	5	140	34	2	90
2-472-16-0-0	8191238	5	160	22	0	120
2-472-16-1-0	8010966	5	160	26	1	120
2-472-16-2-0	8108922	5	160	34	2	120

2-472-14-0-0

2-312-14-0-0, 2-303, 2-300, 2-301, 2-311, 2-304, 2-302, 2-313, 2-307, 2-309, 2-306, 2-308

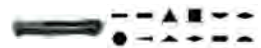

2-472-14-2-0

2-312-14-2-0, 2-303, 2-300, 2-301, 2-311, 2-304, 2-302, 2-313, 2-307, 2-309, 2-306, 2-308

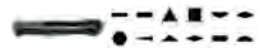

2-472-16-0-0

2-312-16-0-0, 2-303, 2-300, 2-301, 2-311, 2-304, 2-302, 2-313, 2-307, 2-309, 2-306, 2-308

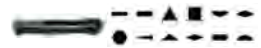

2-472-16-1-0

2-312-16-1-0, 2-303, 2-300, 2-301, 2-311, 2-304, 2-302, 2-313, 2-307, 2-309, 2-306, 2-308

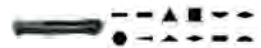

2-472-16-2-0

2-312-16-2-0, 2-303, 2-300, 2-301, 2-311, 2-304, 2-302, 2-313, 2-307, 2-309, 2-306, 2-308

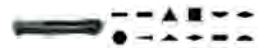



9-488-02

NEEDLE FILE HANDLES



- Simple handle for all needle files
- One handle is included in each needle file set

	 731151		
9-488-02-10	8194772	10	5

DIAMOND FILES



2-300-D - 2-304-D

DIAMOND NEEDLE FILES



- Used for finishing on material where the hardness makes conventional files ineffective
- Used by die and mould makers and special manufacturing applications on materials such as hardened steel, ceramics, glass, graphite, etc.
- Shape: The shapes are the same as for the corresponding conventional needle files
- The files are covered with diamond grit (D 126) and are supplied in individual plastic pouches
- Single pack

	 731151		 mm	
2-300-14-D-1P	8189105	1	140	6
2-300-16-D-1P	8189129	1	160	10
2-301-14-D-1P	8189136	1	140	6
2-301-16-D-1P	8189143	1	160	10
2-302-14-D-1P	8189150	1	140	6
2-302-16-D-1P	8189167	1	160	10
2-303-14-D-1P	8189174	1	140	6
2-303-16-D-1P	8189198	1	160	10
2-304-14-D-1P	8189204	1	140	6
2-304-16-D-1P	8189211	1	160	10

2-300-; 2-301-; 2-302-; 2-303-; 2-304-



DIAMOND FILES

2-306-D - 2-308-D



DIAMOND NEEDLE FILES

- Used for finishing on material where the hardness makes conventional files ineffective
- Used by die and mould makers and special manufacturing applications on materials such as hardened steel, ceramics, glass, graphite, etc.
- Shape: The shapes are the same as for the corresponding conventional needle files
- The files are covered with diamond grit (D 126) and are supplied in individual plastic pouches
- Single pack

	 731151		 mm	 g
2-306-14-D-1P	8189228	1	140	6
2-307-14-D-1P	8189235	1	140	6
2-307-16-D-1P	8189242	1	160	10
2-308-14-D-1P	8189259	1	140	6

2-306-; 2-307-; 2-308-

5-600-D - 5-670-D



DIAMOND PRECISION FILES

- Used for heavy duty purposes where conventional files are ineffective
- Suitable for materials such as hard metals, hard plastics, graphite, epoxy, etc.
- Shape: Four different shapes, similar to conventional precision files
- Integrated handle for easy use
- The shaped section of the file (approx. 110 mm) is covered with diamond grit (D 126)
- The files are supplied in individual plastic pouches
- Single pack

	 731151		 mm	 g
5-600-21-D-1P	8189341	1	215	52
5-610-21-D-1P	8189358	1	215	54
5-630-21-D-1P	8189365	1	215	50
5-670-21-D-1P	8189389	1	215	63

5-600-21-D-1P ; 5-610-21-D-1P ; 5-630-21-D-1P ; 5-670-21-D-1P



3-330

FLAT PANSAR® BLADE

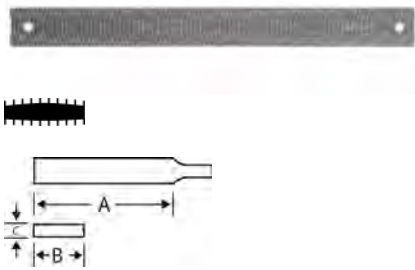

- For work in sheet metal, such as car bodies and refrigerators
- Also in soft materials, where a high material removal rate and a smooth finish is required
- Shape: Flat edges and parallel surfaces
- Convex surfaces milled with curved teeth
- Provided with holes for holder screws
- Fits holders 9-458 and 9-462
- Type of cut: 1 = Bastard, 2 = Second

			A mm	B mm	C mm			
3-330-12-1-0	8020712	5	300	30	4.5	9	1	200
3-330-12-2-0	8020729	5	300	30	4.5	12	2	200
3-330-14-1-0	8020736	5	350	35	4.5	9	1	270
3-330-14-2-0	8020743	5	350	35	4.5	12	2	270

3-331

HALF ROUND PANSAR® BLADE

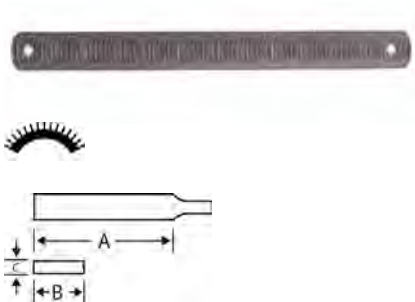

- For work in sheet metal, such as car bodies and refrigerators
- For filing concave surfaces. Also in soft materials, where a high material removal rate and a smooth finish is required
- Shape: Half round, parallel edges
- The convex side is milled with curved teeth
- Provided with holes for holder screws
- Fits holder 9-457
- Type of cut: 1 = Bastard

			A mm	B mm	C mm			
3-331-14-1-0	8020750	5	350	36	4.5	9	1	235

FM10

FILEMASTER

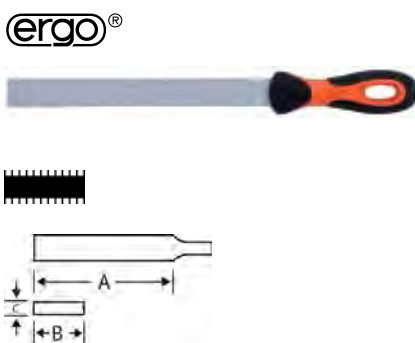

- File handle developed according to the scientific ERGO™ process
- Shear cut: For use on steel, plastics, laminates and hard woods
- Good for finishing in most materials
- Curved teeth: For fast removal of soft metals, lead, aluminium, soft wood and fillers
- Shape: Edges parallel and uncut. Surfaces have milled teeth
- One side shear cut, one side curved teeth
- The file is coated with a protective layer of paint

			A mm	B mm	C mm		
FM10	8010881	5	250	23	5.5	4 & 5	270



MILLED TOOTH FILES

HRFM10

HALF ROUND FILEMASTER

ergo®

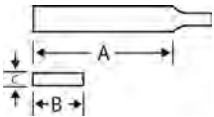

- File handle developed according to the scientific ERGO™ process
- For filing concave and flat surfaces and large holes
- Curved teeth give fast removal of soft metals, lead, aluminium, soft wood and fillers
- Shape: Edges taper towards the tip and are uncut
- Half round surface has milled, curved teeth, concave back is uncut
- The file is coated with a protective layer of paint

	 731151		A mm	B mm	C mm	 T/cm	 g
HRFM10	8010898	5	250	23	4.5	5	182



SHARPENING FILES

4-138...-0

MILL SAW FILE INDUSTRY PACK, UNHANDLED

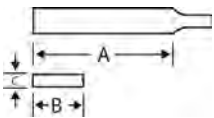

- For sharpening circular, felling and gang saws with fine toothing and bandsaws
- Excellent for draw and fine filing, polishing and deburring work
- Often used in the engineering industry as lathe and deburring files and for draw filing
- Shape: Parallel, thin
- Surfaces and edges single cut, one round edge
- Type of cut: 1 = Bastard

	 731151		A mm	B mm	C mm	 T/cm		 g
4-138-06-1-0	8020927	10	150	16	2.7	20	1	47
4-138-08-1-0	8020934	10	200	20	3.3	18	1	98
4-138-10-1-0	8020958	10	250	25	4.0	16	1	187
4-138-12-1-0	8020965	5	300	30	5.0	14	1	345



4-138...-2

MILL SAW FILE SINGLE PACK CARDED

ergo®

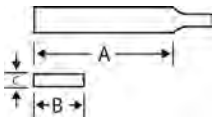

- File handle developed according to the scientific ERGO™ process
- For sharpening circular, felling and gang saws with fine toothing and bandsaws
- Excellent for draw and fine filing, polishing and deburring work
- Often used in the engineering industry as lathe and deburring files and for draw filing
- Shape: Parallel, thin
- Surfaces and edges single cut, one round edge
- Type of cut: 1 = Bastard

	 731151		A mm	B mm	C mm	 T/cm		 g
4-138-06-1-2	8000592	5	150	16	2.7	20	1	110
4-138-08-1-2	8000615	5	200	20	3.3	18	1	160
4-138-10-1-2	8000646	5	250	25	4.0	16	1	225
4-138-12-1-2	8194734	5	300	30	5.0	14	1	380

4-140...-0

MILL SAW FILE INDUSTRY PACK, UNHANDLED

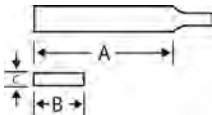

- For sharpening circular, felling and gang saws with fine toothing and bandsaws
- Excellent for draw and fine filing, polishing and deburring work
- Often used in the engineering industry as lathe and deburring files and for draw filing
- Shape: Parallel, thin
- Surfaces and edges single cut, two round edges
- Type of cut: 1 = Bastard

	 731151		A mm	B mm	C mm	 T/cm		 g
4-140-06-1-0	8020989	10	150	16	2.7	20	1	50
4-140-08-1-0	8020996	10	200	20	3.3	18	1	100
4-140-10-1-0	8022488	10	250	25	4.0	16	1	180

4-140...-2

MILL SAW FILE SINGLE PACK CARDED

ergo®

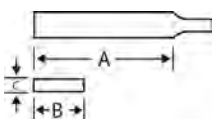

- File handle developed according to the scientific ERGO™ process
- For sharpening circular, felling and gang saws with fine toothing and bandsaws
- Excellent for draw and fine filing, polishing and deburring work
- Often used in the engineering industry as lathe and deburring files and for draw filing
- Shape: Parallel, thin
- Surfaces and edges single cut, two round edges
- Type of cut: 1 = Bastard

	 731151		A mm	B mm	C mm	 T/cm		 g
4-140-08-1-2	8028169	5	200	20	3.3	18	1	160
4-140-10-1-2	8194741	5	250	25	4.0	16	1	225



SHARPENING FILES

4-144...-0

MILL SAW FILE INDUSTRY PACK, UNHANDLED

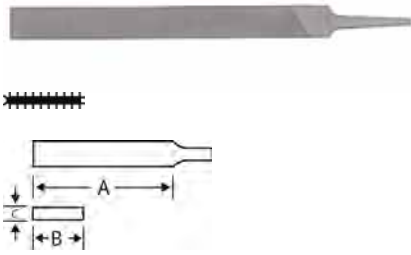

- For sharpening circular and felling saws with fine toothing and for deburring work
- Shape: Parallel, extra thin
- Surfaces and edges single cut, one round edge
- Type of cut: 2 = Second

	 731151		A mm	B mm	C mm	 T/cm		 g
4-144-08-2-0	8021054	10	200	20	2.5	20	2	75

4-144...-2

MILL SAW FILE SINGLE PACK CARDED



- File handle developed according to the scientific ERGO™ process
- For sharpening circular and felling saws with fine toothing and for deburring work
- Shape: Parallel, extra thin
- Surfaces and edges single cut, one round edge
- Type of cut: 2 = Second

	 731151		A mm	B mm	C mm	 T/cm		 g
4-144-08-2-2	8201319	5	200	20	2.5	20	2	139

4-142

MILL SAW FILE



- For sharpening circular, felling and gang saws with fine toothing and bandsaws
- Excellent for draw and fine filing, polishing and deburring work
- Often used in the engineering industry as lathe and deburring files and for draw filing
- Shape: Parallel, thin
- Surfaces and edges single cut, two flat edges
- Type of cut: 1 = Bastard

	 731151		A mm	B mm	C mm	 T/cm		 g
4-142-06-1-0	8021016	10	150	16	2.7	20	1	50
4-142-08-1-0	8021023	10	200	20	3.3	18	1	95
4-142-10-1-0	8021030	10	250	25	4.0	16	1	175



4-152

HOMEOWNER'S FILE, FOR WOOD

ergo®

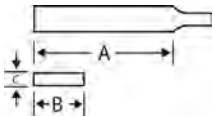

- File handle developed according to the scientific ERGO™ process
- Rasp cut: Rough filing of wood, plywood, soft plastics, etc.
- Double cut: Fine filing of metals, iron and plastics, etc.
- Shape: Flat, parallel, with two flat, uncut edges
- One side bastard rasp cut, the other side double second cut

	 731151		A mm	B mm	C mm		 g
4-152-08-2-2	8000691	5	200	25	4.0	1 & 2	180

4-153

HOMEOWNER'S FILE, FOR METAL

ergo®

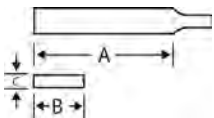

- File handle developed according to the scientific ERGO™ process
- Double cut: Rough sharpening of edges on spades, hoes, mower blades, axes, etc.
- Single cut: Fine sharpening of edges on above implements and on knives and scissors
- Shape: Flat, parallel, with two flat, uncut edges
- One side bastard double cut, the other side single second cut

	 731151		A mm	B mm	C mm		 g
4-153-08-1-2	8000707	5	200	25	4.0	1 & 2	195

4-154

HOMEOWNER'S SET

ergo®

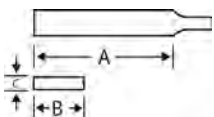

- File handle developed according to the scientific ERGO™ process
- Two files on a display card
- Contains one homeowner's file for wood 4-152 and one homeowner's file for metal 4-153
- Type of cut: 1 = Bastard, 2 = Second

	 731151		A mm	B mm	C mm		 g
4-154-08-2-2	8000714	10	200	25	4.0	1 & 2	350



SHARPENING FILES

4-155

FARMER'S OWN/ DOUBLE DUTY FILE

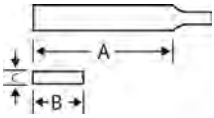

- Double cut: For filing flat surfaces and for rough sharpening of edges on spades, hoes, mower blades, etc.
- Single cut: For fine filing of flat surfaces and for fine sharpening of tools and implements
- Shape: Parallel edges, one edge uncut
- One side double cut bastard, the other side single cut bastard
- Integral handle with hanging hole
- Type of cut: 1 = Bastard

	 731151		A mm	B mm	C mm	 T/cm		 g
4-155-08-2-0	8116194	10	200	25	4.0	9 & 15	1	190
4-155-10-2-0	8116200	10	250	30	5.5	7 & 14	1	390

4-183...-0

TAPER SAW FILE, REGULAR INDUSTRY PACK, UNHANDLED

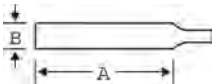

- For sharpening saws with universal toothing and teeth at 60° angle
- Shape: Triangular, with edges tapering towards the tip
- Surfaces and edges single cut
- Type of cut: 2 = Second

	 731151		A mm	B mm	 T/cm		 g
4-183-04-2-0	8021108	10	100	8.2	20	2	30
4-183-45-2-0	8021115	10	112	9.6	19	2	40
4-183-05-2-0	8021122	10	125	10.5	19	2	50
4-183-06-2-0	8021139	10	150	12.0	17	2	80
4-183-07-2-0	8021146	10	175	13.0	16	2	105
4-183-08-2-0	8021153	10	200	15.0	15	2	160
4-183-10-2-0	8021160	10	250	17.0	14	2	245

4-183...-2

TAPER SAW FILE, REGULAR SINGLE PACK CARDED

ergo®

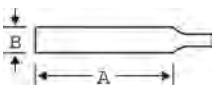

- File handle developed according to the scientific ERGO™ process
- For sharpening saws with universal toothing and teeth at 60° angle
- Shape: Triangular, with edges tapering towards the tip
- Surfaces and edges single cut
- Type of cut: 2 = Second

	 731151		A mm	B mm	 T/cm		 g
4-183-04-2-2	8201401	5	100	8.2	20	2	80
4-183-05-2-2	8201418	5	125	10.5	19	2	115
4-183-06-2-2	8000769	5	150	12.0	17	2	135
4-183-07-2-2	8194710	5	175	13.0	16	2	155
4-183-08-2-2	8194727	5	200	15.0	15	2	210



4-186...-0

SLIM TAPER INDUSTRY PACK, UNHANDLED

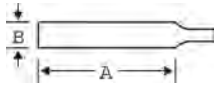

- For sharpening all types of saw with fine universal toothing
- Shape: Triangular, with edges tapering towards the tip
- Surfaces and edges single cut
- Type of cut: 2 = Second

	 731151		A mm	B mm	 T/cm		
4-186-04-2-0	8021191	10	100	6.0	23	2	15
4-186-45-2-0	8021207	10	112	7.0	22	2	20
4-186-05-2-0	8021214	10	125	7.0	22	2	25
4-186-06-2-0	8021221	10	150	8.4	20	2	40
4-186-07-2-0	8021238	10	175	9.8	19	2	65
4-186-08-2-0	8021245	10	200	12.2	17	2	105

4-186...-2

SLIM TAPER SINGLE PACK CARDED

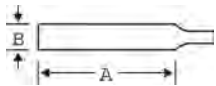

- File handle developed according to the scientific ERGO™ process
- For sharpening all types of saw with fine universal toothing
- Shape: Triangular, with edges tapering towards the tip
- Surfaces and edges single cut
- Type of cut: 2 = Second

	 731151		A mm	B mm	 T/cm		
4-186-04-2-2	8201425	5	100	6.0	23	2	65
4-186-05-2-2	8028213	5	125	7.0	22	2	70
4-186-06-2-2	8000837	5	150	8.4	20	2	85

4-187...-0

EXTRA SLIM TAPER INDUSTRY PACK, UNHANDLED

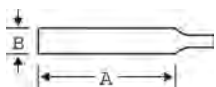

- For sharpening all types of saw with fine universal toothing
- Shape: Triangular, with edges tapering towards the tip
- Surfaces and edges single cut
- Type of cut: 2 = Second

	 731151		A mm	B mm	 T/cm		
4-187-04-2-0	8021269	10	100	5.0	26	2	12
4-187-45-2-0	8021276	10	112	6.0	24	2	20
4-187-05-2-0	8021283	10	125	6.0	24	2	23
4-187-06-2-0	8021290	10	150	7.0	22	2	27
4-187-07-2-0	8021306	10	175	8.5	21	2	47



SHARPENING FILES

4-187...-2

EXTRA SLIM TAPER SINGLE PACK CARDED

ergo®

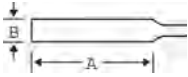

- File handle developed according to the scientific ERGO™ process
- For sharpening all types of saw with fine universal toothing
- Shape: Triangular, with edges tapering towards the tip
- Surfaces and edges single cut
- Type of cut: 2 = Second

	 731151		A mm	B mm	 T/cm		 g
4-187-05-2-2	8201449	5	125	6.0	24	2	75
4-187-06-2-2	8022464	5	150	7.0	22	2	95

4-188...-0

DOUBLE EXTRA SLIM TAPER INDUSTRY PACK, UNHANDLED

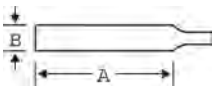

- For sharpening all types of saw with fine universal toothing
- Shape: Triangular, with edges tapering towards the tip
- Surfaces and edges single cut
- Type of cut: 2 = Second

	 731151		A mm	B mm	 T/cm		 g
4-188-05-2-0	8021337	10	125	5.0	26	2	15
4-188-06-2-0	8021344	10	150	6.0	24	2	20

4-188...-2

DOUBLE EXTRA SLIM TAPER SINGLE PACK CARDED

ergo®

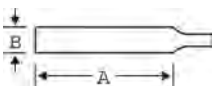

- File handle developed according to the scientific ERGO™ process
- For sharpening all types of saw with fine universal toothing
- Shape: Triangular, with edges tapering towards the tip
- Surfaces and edges single cut
- Type of cut: 2 = Second

	 731151		A mm	B mm	 T/cm		 g
4-188-05-2-2	8201456	5	125	5.0	26	2	75



4-190...-0

DOUBLE-ENDED SAW FILE INDUSTRY PACK

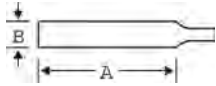

- For sharpening saws with fine cross tothing
- Shape: Triangular, untanged, edges tapering towards both ends
- Surfaces and edges single cut from both ends towards the centre
- Wood handle included
- Type of cut: 2 = Second

	 731151		A mm	B mm	 T/cm		 g	
	4-190-06-2-0	8021368	10	150	6.0	24	2	35
	4-190-07-2-0	8021375	10	175	6.0	24	2	40
	4-190-08-2-0	8021382	10	200	7.0	22	2	45

4-190...-2

DOUBLE-ENDED SAW FILE SINGLE PACK, CARDED

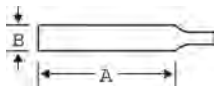

- File handle developed according to the scientific ERGO™ process
- For sharpening saws with fine cross tothing
- Shape: Triangular, untanged, edges tapering towards both ends
- Surfaces and edges single cut from both ends towards the centre
- Type of cut: 2 = Second

	 731151		A mm	B mm	 T/cm		 g	
	4-190-06-2-2	8000899	5	150	6.0	24	2	85
	4-190-07-2-2	8000905	5	175	6.0	24	2	45
	4-190-08-2-2	8000912	5	200	7.0	22	2	65

4-192...-0

TAPER BANDSAW FILE, REGULAR INDUSTRY PACK, UNHANDLED

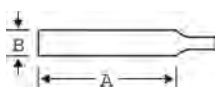

- For sharpening bandsaw blades
- Shape: Triangular, with round edges tapering towards the tip
- Surfaces and edges single cut
- Type of cut: 2 = Second

	 731151		A mm	B mm	 T/cm		 g	
	4-192-06-2-0	8021412	10	150	11.7	17	2	75
	4-192-07-2-0	8021429	10	175	12.6	16	2	135
	4-192-08-2-0	8021436	10	200	14.4	15	2	160



SHARPENING FILES

4-192...-2

TAPER BANDSAW FILE, REGULAR SINGLE PACK, CARDED

ergo®

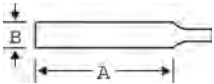

- File handle developed according to the scientific ERGO™ process
- For sharpening bandsaw blades
- Shape: Triangular, with round edges tapering towards the tip
- Surfaces and edges single cut
- Type of cut: 2 = Second

	 731151		A mm	B mm	 T/cm		 g
4-192-06-2-2	8201463	5	150	11.7	17	2	140
4-192-08-2-2	8201487	5	200	14.4	15	2	180

4-202 - 4-204

MACHINE BANDSAW FILES

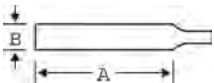

- For sharpening bandsaw blades
- Shape: Triangular, untanged, parallel
- Surfaces and round edges single cut
- Type of cut: 2 = Second

	 731151		A mm	B mm	 T/cm		 g
4-202-85-2-0	8021474	10	212	14.4	15	2	175
4-203-85-2-0	8021481	10	212	9.5	18	2	70
4-204-85-2-0	8021498	10	212	16.0	15	2	210

4-272...-0

DOUBLE EDGE SAW FILE "WASA"® INDUSTRY PACK, UNHANDLED

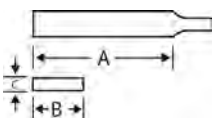

- For sharpening saws with straight, fine toothing
- Shape: Parallel, double conical
- Surfaces and edges single cut
- Type of cut: 3 = Smooth

	 731151		A mm	B mm	C mm	 T/cm		 g
4-272-06-3-0	8021597	10	150	16.0	4.0	23	3	50



4-272...-2

DOUBLE EDGE SAW FILE "WASA"® SINGLE PACK, CARDED

ergo®



- File handle developed according to the scientific ERGO™ process
- For sharpening saws with straight, fine toothing
- Shape: Parallel, double conical
- Surfaces and edges single cut
- Type of cut: 3 = Smooth

	 731151		A mm	B mm	C mm	 T/cm		 g
4-272-05-3-2	8201500	5	125	16.0	4.0	23	3	100
4-272-06-3-2	8001025	5	150	16.0	4.0	23	3	105

CHAIN SAW FILES



168 - 1P

ROUND CHAIN SAW FILES



- Round chain saw file for sharpening of the cutting tooth on the saw chain
- Each file is packed in a skin pack which can be reused as a protective sleeve

	 731151		 mm	Ø mm		 g
168-6-3.2-1P	8152338	12	150	3.2	1/4"	13
168-6-3.5-1P	8152345	12	150	3.5	1/4"	15
168-8-4.0-1P	8152352	12	200	4.0	3/8" RG	23
168-8-4.5-1P	8152369	12	200	4.5	.325	27
168-8-4.8-1P	8152376	12	200	4.8	.325	31
168-8-5.2-1P	8152383	12	200	5.2	3/8"	36
168-8-5.5-1P	8152390	12	200	5.5	3/8"	39
168-8-6.3-1P	8152406	12	200	6.3	1/2"	51



CHAIN SAW FILES

168 - 3P

ROUND CHAIN SAW FILES



- Round chain saw file for sharpening of the cutting tooth on the saw chain
- The files are packed in a three pce protective skin pack with perforations for easy separation
- 12 three packs (36 files) are packed in a combined display/storage box

	 731151		 mm	 mm		 g
168-6-3.2-3P	8152413	12	150	3.2	1/4"	39
168-6-3.5-3P	8152420	12	150	3.5	1/4"	45
168-8-4.0-3P	8152437	12	200	4.0	3/8" RG	69
168-8-4.5-3P	8152444	12	200	4.5	.325	81
168-8-4.8-3P	8152451	12	200	4.8	.325	93
168-8-5.2-3P	8152468	12	200	5.2	3/8"	108
168-8-5.5-3P	8152475	12	200	5.5	3/8"	117
168-8-6.3-3P	8152482	12	200	6.3	1/2"	153

168-6

ROUND CHAIN SAW FILES



- Round chain saw file for sharpening of the cutting tooth on the chain saw blade
- 6 pack
- For professional users
- The outer box can also be used as a counter display
- 10 six packs (60 files) are packed in a combined display/storage box

	 731151		 mm	 mm		 g
168-8-4.0-6	8217419	6	200	4.0	3/8" RG	23
168-8-4.5-6	8217426	6	200	4.5	.325	27
168-8-4.8-6	8217433	6	200	4.8	.325	31
168-8-5.2-6	8217440	6	200	5.2	3/8"	36
168-8-5.5-6	8217457	6	200	5.5	3/8"	39

166-2

FLAT CHAIN SAW FILES SINGLE PACK, CARDED

ergo®



- File handle developed according to the scientific ERGO™ process
- Parallel flat file with round uncut edges for filing of depth gauges on saw chains and for sharpening of brushcutter blade

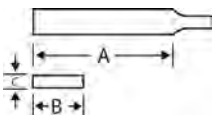

	 731151		A mm	B mm	C mm	 g
166-6-16-2.5-2	8209698	5	150	16.0	2.5	105



166/167-12

FLAT CHAIN SAW FILES INDUSTRY PACK, UNHANDLED

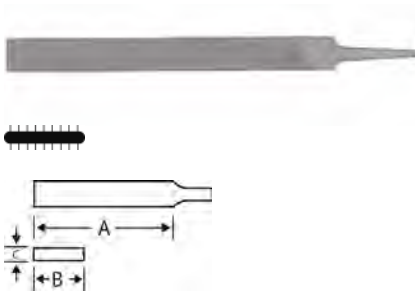

- Parallel flat file with round uncut edges
- For filing of depth gauges on saw chains and for sharpening of brush cutter blades

	 731151		A mm	B mm	C mm	 g
167-8-21-3.2-12	8021986	12	200	21.0	3.2	94
166-6-16-2.5-12	8021979	12	150	16.0	2.5	48

168-C

CHAIN SAW FILES, SET



- File handle developed according to the scientific ERGO™ process
- Combination pack with two round chain saws files and one 6" flat chain saw file

	 731151		 mm	 mm		 g
168-COMBI-4.0	8209667	1	200	4.0	3/8" RG	150
168-COMBI-4.8	8209674	1	200	4.8	.325	160
168-COMBI-5.5	8209681	1	200	5.5	3/8"	175



168-C-G

CHAIN SAW FILES, SET INCLUDING FILING GUIDE



- File handle developed according to the scientific ERGO™ process
- Combination pack of two round chain saws files, one 6" flat chain saw file and a filing guide

	 731151		 mm	 mm		 g
168-COMBI-4.0-6922	8209612	1	200	4.0	3/8" RG	185
168-COMBI-4.8-6920	8209643	1	200	4.8	.325	195
168-COMBI-5.5-6924	8209650	1	200	5.5	3/8"	210





RASPS

6-342...-0

HALF ROUND RASP INDUSTRY PACK, UNHANDLED

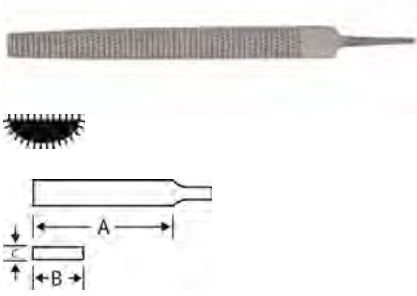

- For work in wood, plywood, wallboard, plastics and other soft materials
- Shape: Edges and surfaces tapered towards the tip
- Surfaces rasp cut, edges single cut
- Type of cut: 1 = Coarse, 2 = Medium

	 731151		A mm	B mm	C mm	 /cm ²		 g	
	6-342-06-2-0	8021719	10	150	15.0	5.0	20	2	65
	6-342-08-1-0	8021726	10	200	20.0	6.5	10	1	158
	6-342-08-2-0	8021733	10	200	20.0	6.5	16	2	158
	6-342-10-1-0	8021757	10	250	24.0	8.0	8	1	270
	6-342-10-2-0	8021764	10	250	24.0	8.0	12	2	270
	6-342-12-1-0	8021788	5	300	30.0	10.0	6	1	400

6-342...-2

HALF ROUND RASP SINGLE PACK, CARDED



- File handle developed according to the scientific ERGO™ process
- For work in wood, plywood, wallboard, plastics and other soft materials
- Shape: Edges and surfaces tapered towards the tip
- Surfaces rasp cut, edges single cut
- Type of cut: 1 = Coarse, 2 = Medium

	 731151		A mm	B mm	C mm	 /cm ²		 g	
	6-342-06-2-2	8244170	5	150	15.0	5.0	20	2	102
	6-342-08-1-2	8028282	5	200	20.0	6.5	10	1	205
	6-342-08-2-2	8005375	5	200	20.0	6.5	16	2	205
	6-342-10-1-2	8005382	5	250	24.0	8.0	8	1	330
	6-342-10-2-2	8005399	5	250	24.0	8.0	12	2	330

6-343...-0

CABINET RASP INDUSTRY PACK, UNHANDLED

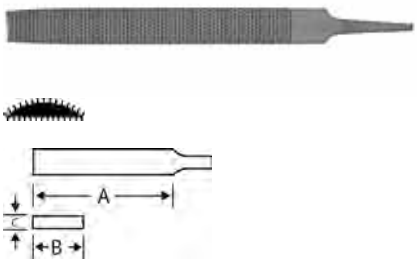

- For work in wood, plywood, wallboard, plastics and other soft materials
- Shape: Thin, half round. Edges and surfaces tapered towards the tip
- Surfaces rasp cut, edges single cut
- Type of cut: 2 = Medium, 3 = Fine

	 731151		A mm	B mm	C mm	 /cm ²		 g	
	6-343-08-2-0	8021801	10	200	22.5	5.5	22	2	84
	6-343-08-3-0	8021818	10	200	22.5	5.5	22	3	84
	6-343-10-2-0	8021825	10	250	27.0	6.0	12	2	205
	6-343-10-3-0	8021832	10	250	27.0	6.0	18	3	205
	6-343-12-2-0	8021849	5	300	34.0	7.0	10	2	355





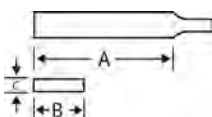

6-343...-2

CABINET RASP SINGLE PACK, CARDED

ergo®



- File handle developed according to the scientific ERGO™ process
- For work in wood, plywood, wallboard, plastics and other soft materials
- Shape: Thin, half round, edges and surfaces tapered towards the tip
- Surfaces rasp cut, edges single cut
- Type of cut: 2 = Medium





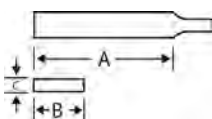

	 731151		A mm	B mm	C mm	 /cm ²		 g
6-343-08-2-2	8001070	5	200	22.5	5.5	16	2	170
6-343-10-2-2	8001094	5	250	27.0	6.0	12	2	285

6-344...-0

HAND RASP



- For work in wood, plywood, wallboard, plastics and other soft materials
- Shape: Edges and surfaces parallel
- Surfaces rasp cut, one edge single cut
- Type of cut: 2 = Medium

	 731151		A mm	B mm	C mm	 /cm ²		 g
6-344-08-2-0	8021887	12	200	20.2	6.5	16	2	200
6-344-10-2-0	8021900	10	250	25.0	7.5	12	2	250





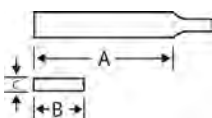

6-344...-2

HAND RASP

ergo®



- File handle developed according to the scientific ERGO™ process
- For work in wood, plywood, wallboard, plastics and other soft materials
- Shape: Edges and surfaces parallel
- Surfaces rasp cut, one edge single cut
- Single pack, carded
- Type of cut: 2 = Medium

	 731151		A mm	B mm	C mm	 /cm ²		 g
6-344-08-2-2	8005344	5	200	20.0	6.5	16	2	200
6-344-10-2-2	8005351	5	250	25.0	7.5	12	2	250



RASPS

6-345...-0

ROUND RASP INDUSTRY PACK, UNHANDLED

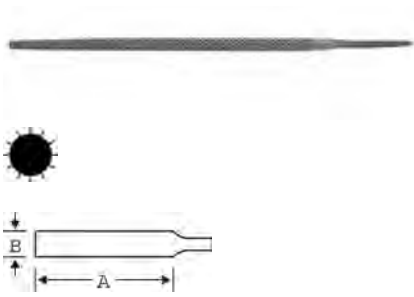

- For work in wood, plywood, wallboard, plastics and other soft materials
- Shape: Round, tapered towards the tip
- Type of cut: 2 = Medium

	 731151		A mm	B mm	 /cm ²		 g
6-345-08-2-0	8021948	10	200	9.0	16	2	85
6-345-10-2-0	8021955	10	250	11.0	12	2	110

6-345...-2

ROUND RASP SINGLE PACK, CARDED

ergo®



- File handle developed according to the scientific ERGO™ process
- For work in wood, plywood, wallboard, plastics and other soft materials
- Shape: Round, tapered towards the tip
- Type of cut: 1= Coarse, 2 = Medium

	 731151		A mm	B mm	 /cm ²		 g
6-345-08-1-2	8028312	5	200	9.0	10	1	120
6-345-08-2-2	8005412	5	200	9.0	16	2	120
6-345-10-1-2	8005429	5	250	11.0	8	1	190



ACCESSORIES

9-462

PANSAR® BLADE HOLDERS



- Aluminium holder for 14" (350 mm) flat Pansar® blades 3-330

	 731151		 L mm	 g
9-462-14-0-0	8020873	1	360	590



9-467

FILE CLEANER



- To ensure a good filing result, files should periodically be cleaned during use
- Use the brush (or card for stubborn filings) to clear clogged teeth
- Doing this regularly will improve the stock removal efficiency of the file, and extend its useful life
- Shape: A wooden holder with bristles on one side, and a card of steel wire on the other

	 731151		 g
9-467-00-0-0	8020897	1	130

9-469

FILE CARD



- For clearing filings from clogged file teeth
- Regular use improves the stock removal efficiency of the file, and extends its useful life
- Shape: A wooden holder with a card of steel wire on one side

	 731151		 g
9-469-00-0-0	8020903	1	90

9-484...10

PLASTIC FILE HANDLE PACK OF 10 LOOSE HANDLES



- File handle developed according to the scientific ERGO™ process
- Plastic file handle for smaller sized files

	 731151			 mm	 g
9-484-3.2-10	8193348	10	3, 2	3.2	12
9-484-5.2-10	8193355	10	5, 2	5.2	12

9-484...1P

PLASTIC FILE HANDLE SINGLE PACK CARDED



- File handle developed according to the scientific ERGO™ process
- Plastic file handle for smaller sized files

	 731151			 mm	 g
9-484-3.2-1P	8193522	10	3, 2	3.2	12
9-484-5.2-1P	8193331	10	5, 2	5.2	12



9-485...10

HANDLE FOR FLAT FILES PACK OF 10 LOOSE HANDLES

ergo®



- File handle developed according to the scientific ERGO™ process
- The shaped end on the ERGO™ handle 9-485 has been designed for files of rectangular shape (flat, hand, etc.) and for half round files
- The end covers the tang and shoulder completely for a safe and comfortable grip

	 731151			 mm	 g
9-485-06-10	8193508	10	06	6	45
9-485-09-10	8193386	10	09	9	45
9-485-13-10	8193393	10	13	13	45

9-485...1P

HANDLE FOR FLAT FILES SINGLE PACK CARDED

ergo®



- File handle developed according to the scientific ERGO™ process
- The shaped end on the ERGO™ handle 9-485 has been designed for files of rectangular shape (flat, hand, etc.) and for half round files
- The end covers the tang and shoulder completely for a safe and comfortable grip

	 731151			 mm	 g
9-485-06-1P	8193492	10	06	6	50
9-485-09-1P	8193362	10	09	9	50
9-485-13-1P	8193379	10	13	13	50

9-486...10

HANDLE FOR SHAPED FILES PACK OF 10 LOOSE HANDLES

ergo®



- File handle developed according to the scientific ERGO™ process
- The shaped end on the ERGO™ handle 9-486 has been designed for files of rectangular shape (round, square, three square, etc.)
- The end covers the tang and shoulder completely for a safe and comfortable grip

	 731151			 mm	 g
9-486-04-10	8193430	10	04	4	45
9-486-05-10	8193461	10	05	5	45



9-486...1P

HANDLE FOR SHAPED FILES SINGLE PACK CARDED



- File handle developed according to the scientific ERGO™ process
- The shaped end on the ERGO™ handle 9-486 has been designed for files of rectangular shape (round, square, three square, etc.)
- The end covers the tang and shoulder completely for a safe and comfortable grip

	 731151			 mm	 g
9-486-04-1P	8193409	10	04	4	50
9-486-05-1P	8193447	10	05	5	50
9-486-07-1P	8249359	10	07	7	50

9-486-C-10

HANDLE FOR ROUND AND FLAT CHAIN SAW FILES PACK OF 10 LOOSE HANDLES



- File handle developed according to the scientific ERGO™ process
- This handle can hold both round chain saw files (type 168) and the flat chain saw file (type 166)

	 731151		 g
9-486-C-10	8209599	10	45

9-486-C-1P

HANDLE FOR ROUND AND FLAT CHAIN SAW FILES SINGLE PACK CARDED



- File handle developed according to the scientific ERGO™ process
- This handle can hold both round chain saw files (type 168) and the flat chain saw file (type 166)

	 731151		 g
9-486-C-1P	8209605	10	50

PH-6604

HANDLE FOR ROUND CHAIN SAW FILES



- Handle for 8" round chain saw files with three integrated angle guides

	 731151		 g
PH-6604-1P	8152819	15	55
PH-6604-25	8141134	25	50



TUNGSTEN CARBIDE ROTARY BURRS

A

CYLINDRICAL

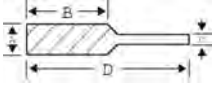

- DIN: ZYA
- Deburring of edges and plane surfaces
- Type of cut: F = Fine, M = Medium, C = Coarse
- Stock standard: X = yes

	 731151		A mm	B mm	C mm	D mm				
A0313F03	8023690	1	3	13	3	40	F	18	X	10
A0313F03E	8212780	1	3	13	3	40	F	18		10
A0313M03	8023706	1	3	13	3	40	M	14	X	10
A0313M03E	8192150	1	3	13	3	40	M	14		10
A0313M03X	8182038	1	3	13	3	40	M	14/7	X	10
A0313M03XE	8181475	1	3	13	3	40	M	14/7	X	10
A0313M03XE-60	8184513	1	3	13	3	60	M	14/7		15
A0313M03XE-80	8201357	1	3	13	3	80	M	14/7	X	15
A0313C03	8023713	1	3	13	3	40	C	14	X	10
A0613M03X	8197872	1	6	13	3	48	M	16/8	X	15
A0616F06	8023720	1	6	16	6	50	F	24	X	20
A0616M06	8023737	1	6	16	6	50	M	16	X	20
A0616M06DE	8212629	1	6	16	6	50	M	16/16		20
A0616M06E	8023751	1	6	16	6	50	M	18	X	20
A0616M06X	8023768	1	6	16	6	50	M	16/8	X	20
A0616M06XE	8181468	1	6	16	6	50	M	16/8	X	20
A0616C06	8023782	1	6	16	6	50	C	10	X	20
A0820F06	8023799	1	8	20	6	60	F	28		30
A0820F06E	8212803	1	8	20	6	60	F	28		30
A0820M06	8023805	1	8	20	6	60	M	18	X	30
A0820M06E	8023829	1	8	20	6	60	M	18		30
A0820M06X	8023836	1	8	20	6	60	M	18/9	X	30
A0820M06XE	8181994	1	8	20	6	60	M	18/9	X	30
A0820C06	8023850	1	8	20	6	60	C	12		30
A1020F06	8023867	1	10	20	6	60	F	32		30
A1020M06	8023874	1	10	20	6	60	M	20	X	30
A1020M06E	8023898	1	10	20	6	60	M	20		30
A1020M06X	8023904	1	10	20	6	60	M	20/10	X	30
A1020M06XE	8182007	1	10	20	6	60	M	20/10	X	30
A1020C06	8023928	1	10	20	6	60	C	14		30
A1040M06X	8233129	1	10	40	6	60	X	20/10		55
A1050M06X	8233136	1	10	50	6	60	X	20/10		65
A1225F06	8023935	1	12	25	6	65	F	36		50
A1225F06E	8212810	1	12	25	6	65	F	36		50
A1225M06	8023942	1	12	25	6	65	M	24	X	50
A1225M06DE	8212636	1	12	25	6	65	M	24/24		50
A1225M06E	8023966	1	12	25	6	65	M	24		50
A1225M06X	8023973	1	12	25	6	65	M	24/12	X	50
A1225M06XE	8182014	1	12	25	6	65	M	24/12	X	50
A1225C06	8023997	1	12	25	6	65	C	16	X	50
A1225F08	8024000	1	12	25	8	65	F	36		55
A1225M08	8100506	1	12	25	8	65	M	24	X	55
A1225M08E	8100520	1	12	25	8	65	M	24		55
A1225M08X	8187989	1	12	25	8	65	M	24		55
A1225M08XE	8192174	1	12	25	8	65	M	24/12		55
A1225C08	8100544	1	12	25	8	65	C	16		55
A1625F06	8192198	1	16	25	6	65	F	40		70
A1625M06	8192181	1	16	25	6	65	M	28		70
A1625M06X	8187361	1	16	25	6	65	M	28	X	70
A1625M06XE	8187354	1	16	25	6	65	M	28/14		70
A1625C06	8192204	1	16	25	6	65	C	18		70
A1625F08	8100551	1	16	25	8	65	F	40		70
A1625M08	8100568	1	16	25	8	65	M	28	X	70
A1625M08E	8100582	1	16	25	8	65	M	28		70
A1625M08X	8100599	1	16	25	8	65	M	28/14	X	70
A1625M08XE	8182021	1	16	25	8	65	M	28/14	X	70
A1625C08	8100612	1	16	25	8	65	C	18		70



C

CYLINDRICAL ROUND NOSE

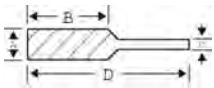

- DIN: WRC
- Deburring of surfaces with round edges and surfaces
- Type of cut: F = Fine, M = Medium, C = Coarse
- Stock standard: X = yes

	 731151		A mm	B mm	C mm	D mm				
C0313F03	8100629	1	3	13	3	40	F	18	X	10
C0313M03	8100636	1	3	13	3	40	M	14	X	10
C0313M03X	8182045	1	3	13	3	40	M	14/7	X	10
C0313C03	8100643	1	3	13	3	40	C	10	X	10
C0613M03X	8197889	1	6	13	3	48	M	16/8	X	15
C0616M03X	8204679	1	6	16	3	53	M	16/8	X	20
C0616F06	8100650	1	6	16	6	50	F	24	X	20
C0616M06	8100667	1	6	16	6	50	M	16	X	20
C0616M06D	8215262	1	6	16	6	50	M	16/16		20
C0616M06X	8100681	1	6	16	6	50	M	16/8	X	20
C0616C06	8100698	1	6	16	6	50	C	10	X	20
C0820F06	8100704	1	8	20	6	60	F	32	X	30
C0820M06	8100711	1	8	20	6	60	M	18	X	30
C0820M06X	8100735	1	8	20	6	60	M	18/9	X	30
C0820C06	8100742	1	8	20	6	60	C	12		30
C1020F06	8100759	1	10	20	6	60	F	32		30
C1020M06	8100766	1	10	20	6	60	M	20	X	30
C1020M06X	8100780	1	10	20	6	60	M	20/10	X	30
C1020C06	8100797	1	10	20	6	60	C	14	X	30
C1225F06	8100803	1	12	25	6	65	F	32	X	50
C1225M06	8100810	1	12	25	6	65	M	24	X	50
C1225M06X	8100834	1	12	25	6	65	M	24/12	X	50
C1225C06	8100841	1	12	25	6	65	C	16	X	50
C1225F08	8100858	1	12	25	8	65	F	36		55
C1225M08	8100865	1	12	25	8	65	M	24	X	55
C1225M08X	8187996	1	12	25	8	65	M	24/12	X	55
C1225C08	8100889	1	12	25	8	65	C	16		55
C1625F06	8192259	1	16	25	6	65	F	40		70
C1625M06	8192266	1	16	25	6	65	M	28	X	70
C1625M06X	8187378	1	16	25	6	65	M	28/14	X	70
C1625C06	8192273	1	16	25	6	65	C	18		70
C1625F08	8100896	1	16	25	8	65	F	40		70
C1625M08	8100902	1	16	25	8	65	M	28	X	70
C1625M08X	8100926	1	16	25	8	65	M	28/14	X	70
C1625C08	8100933	1	16	25	8	65	C	18		70



TUNGSTEN CARBIDE ROTARY BURRS

D

SPHERICAL

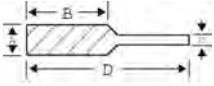

- DIN: KUD
- Deburring of welds and holes. To make oil canals in narrow places
- Type of cut: F = Fine, M = Medium, C = Coarse
- Stock standard: X = yes

	 731151		A mm	B mm	C mm	D mm				
D0303F03	8100940	1	3	3	3	40	F	18	X	10
D0303M03	8100957	1	3	3	3	40	M	14	X	10
D0303M03X	8182052	1	3	3	3	40	M	14/7	X	10
D0303C03	8100964	1	3	3	3	40	C	10		10
D0605M03X	8197896	1	6	5	3	40	M	16/8	X	15
D0606F06	8100971	1	6	6	6	50	F	24		20
D0606M06	8100988	1	6	6	6	50	M	16	X	20
D0606M06X	8101008	1	6	6	6	50	M	16/8	X	20
D0606C06	8043872	1	6	6	6	50	C	12	X	20
D0807F06	8043889	1	8	7	6	47	F	28		20
D0807M06	8043896	1	8	7	6	47	M	18	X	20
D0807M06X	8043919	1	8	7	6	47	M	18/9	X	20
D0807C06	8043933	1	8	7	6	47	C	14		20
D1009F06	8043926	1	10	9	6	49	F	32		20
D1009M06	8035280	1	10	9	6	49	M	20	X	20
D1009M06X	8035297	1	10	9	6	49	M	20/10	X	20
D1009C06	8035310	1	10	9	6	49	C	14	X	20
D1211F06	8035327	1	12	11	6	51	F	36	X	30
D1211F06D	8266424	1	12	11	6	51	D	36		30
D1211M06	8035334	1	12	11	6	51	M	24	X	30
D1211M06X	8035358	1	12	11	6	51	M	24/12	X	30
D1211C06	8035365	1	12	11	6	51	C	16	X	30
D1614F06	8192334	1	16	14	6	54	F	40		50
D1614M06	8192327	1	16	14	6	54	M	28	X	50
D1614M06X	8187385	1	16	14	6	54	M	28/14	X	50
D1614C06	8192341	1	16	14	6	54	C	18		50
D1614F08	8035372	1	16	14	8	54	F	40		50
D1614M08	8035389	1	16	14	8	54	M	28		50
D1614M08X	8035402	1	16	14	8	54	M	28/14		50
D1614C08	8035419	1	16	14	8	65	C	18		50



E

OVAL

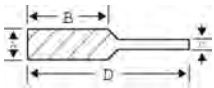

- DIN: TRE
- Shaping and deburring in, for example, cylinder blocks and tools with complicated forms
- Type of cut: F = Fine, M = Medium, C = Coarse
- Stock standard: X = yes

	 731151		A mm	B mm	C mm	D mm				 g
E0308F03	8035426	1	3	8	3	40	F	18		10
E0308M03	8035433	1	3	8	3	40	M	14	X	10
E0308M03X	8192372	1	3	8	3	40	M	14/7		10
E0308C03	8035440	1	3	8	3	40	C	10		10
E0614F06	8035457	1	6	14	6	50	F	24		20
E0614M06	8035464	1	6	14	6	50	M	16	X	20
E0614M06X	8035488	1	6	14	6	50	M	16/8	X	20
E0614C06	8035495	1	6	14	6	50	C	12		20
E0816F06	8035501	1	8	16	6	60	F	24		30
E0816M06	8035518	1	8	16	6	60	M	18	X	30
E0816M06X	8035532	1	8	16	6	60	M	18/9	X	30
E0816C06	8035549	1	8	16	6	60	C	12		30
E1018F06	8035556	1	10	18	6	60	F	32		30
E1018M06	8035563	1	10	18	6	60	M	20	X	30
E1018M06X	8035587	1	10	18	6	60	M	20/10	X	30
E1018C06	8035594	1	10	18	6	60	C	14		30
E1222F06	8035600	1	12	22	6	60	F	36		40
E1222M06	8035617	1	12	25	6	65	M	24	X	40
E1222M06X	8035631	1	12	22	6	65	M	24/12	X	40
E1222C06	8035648	1	12	22	6	60	C	16		40
E1222F08	8035655	1	12	22	8	65	F	36		40
E1222M08	8172558	1	12	22	8	65	M	24		40
E1222M08X	8199302	1	12	22	8	65	M	24/12		40
E1222C08	8035686	1	12	22	8	65	C	16		40
E1625F06	8192457	1	16	25	6	65	F	40		70
E1625M06	8192440	1	16	25	6	65	M	28	X	70
E1625M06X	8187392	1	16	25	6	65	M	28/14	X	70
E1625C06	8192464	1	16	25	6	65	C	18		70
E1625F08	8035693	1	16	25	8	65	F	40		70
E1625M08	8035709	1	16	25	8	65	M	28		70
E1625M08X	8035723	1	16	25	8	65	M	28/14	X	70
E1625C08	8035730	1	16	25	8	65	C	16		70



TUNGSTEN CARBIDE ROTARY BURRS

F

ARCH ROUND NOSE

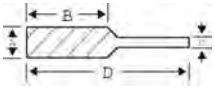

- DIN: RBF
- Deburring and form machining for all applications due to the universal form
- Type of cut: F = Fine, M = Medium, C = Coarse
- Stock standard: X = yes

			A mm	B mm	C mm	D mm			
F0313F03	8035747	1	3	13	3	40	F	24	X 15
F0313M03	8035754	1	3	13	3	40	M	14	X 15
F0313M03X	8192495	1	3	13	3	40	M	14/7	X 15
F0313C03	8035761	1	3	13	3	40	C	10	15
F0612F04	8192518	1	6	12	4	45	F	24	10
F0612M04	8035778	1	6	12	4	45	M	16	10
F0612M04X	8188474	1	6	12	4	45	M	16/8	10
F0612C04	8192525	1	6	12	4	45	C	10	10
F0613M03X	8196608	1	6	13	3	48	M	16/8	X 10
F0618F06	8035785	1	6	18	6	50	F	24	20
F0618M06	8035792	1	6	18	6	50	M	16	X 20
F0618M06X	8035815	1	6	18	6	50	M	16/8	X 20
F0618C06	8035822	1	6	18	6	50	C	10	X 20
F0820F06	8035846	1	8	20	6	60	F	28	30
F0820M06	8035839	1	8	20	6	60	M	18	X 30
F0820M06X	8035860	1	8	20	6	60	M	18/9	X 30
F0820C06	8035877	1	8	20	6	60	C	12	30
F1020F06	8035884	1	10	20	6	60	F	32	30
F1020M06	8035891	1	10	20	6	60	M	20	X 30
F1020M06X	8035914	1	10	20	6	60	M	20/10	X 30
F1020C06	8035921	1	10	20	6	60	C	14	30
F1225F06	8035938	1	12	25	6	65	F	36	X 40
F1225M06	8035945	1	12	25	6	65	M	24	X 40
F1225M06X	8036003	1	12	25	6	65	M	24/12	X 40
F1225C06	8035969	1	12	25	6	65	C	16	X 40
F1225F08	8035976	1	12	25	8	65	F	36	45
F1225M08	8035983	1	12	25	8	65	M	24	X 45
F1225M08X	8192563	1	12	25	8	65	M	24/12	X 45
F1225C08	8036010	1	12	25	8	65	C	16	45
F1625F06	8192587	1	16	25	6	65	F	40	70
F1625M06	8192570	1	16	25	6	65	M	28	X 70
F1625M06X	8187408	1	16	25	6	65	M	28/14	X 70
F1625C06	8192594	1	16	25	6	65	C	18	70
F1625F08	8036027	1	16	25	8	65	F	40	70
F1625M08	8036034	1	16	25	8	65	M	28	70
F1625M08X	8036058	1	16	25	8	65	M	28/14	70
F1625C08	8036065	1	16	25	8	65	C	18	70



G

ARCH POINTED NOSE

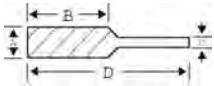

- DIN: SPG
- Useful in confined spaces due to the pointed nose
- Type of cut: F = Fine, M = Medium, C = Coarse
- Stock standard: X = yes

	 731151		A mm	B mm	C mm	D mm				
G0313F03	8036072	1	3	13	3	40	F	18	X	10
G0313M03	8036089	1	3	13	3	40	M	14	X	10
G0313M03X	8182069	1	3	13	3	40	M	14/7	X	10
G0313C03	8036096	1	3	13	3	40	C	12	X	10
G0613M03X	8196592	1	6	13	3	48	M	16/8	X	15
G0618F06	8036102	1	6	18	6	50	F	24	X	20
G0618M06	8036119	1	6	18	6	50	M	16	X	20
G0618M06X	8036133	1	6	18	6	50	M	16/8	X	20
G0618C06	8036140	1	6	18	6	50	C	10	X	20
G0820F06	8036157	1	8	20	6	60	F	28		30
G0820M06	8036164	1	8	20	6	60	M	18	X	30
G0820M06X	8036188	1	8	20	6	60	M	18/9	X	30
G0820C06	8172572	1	8	20	6	60	C	12		30
G1020F06	8036201	1	10	20	6	60	F	32		30
G1020M06	8036218	1	10	20	6	60	M	20	X	30
G1020M06X	8036232	1	10	20	6	60	M	20/10	X	30
G1020C06	8036249	1	10	20	6	60	C	14		30
G1225F06	8036300	1	12	25	6	65	F	36	X	40
G1225M06	8036317	1	12	25	6	65	M	24	X	40
G1225M06X	8036331	1	12	25	6	65	M	24/12	X	40
G1225C06	8036348	1	12	25	6	65	C	16	X	40
G1225F08	8036355	1	12	25	8	65	F	36		40
G1225M08	8036362	1	12	25	8	65	M	24	X	40
G1225M08X	8188009	1	12	25	8	65	M	24/12	X	40
G1225C08	8036386	1	12	25	8	65	C	16		40
G1625F06	8192655	1	16	25	6	65	F	40		70
G1625M06	8192648	1	16	25	6	65	M	28	X	70
G1625M06X	8187415	1	16	25	6	65	M	28/14	X	70
G1625C06	8192662	1	16	25	6	65	C	18		70
G1625F08	8036393	1	16	25	8	65	F	40		70
G1625M08	8036409	1	16	25	8	65	M	28		70
G1625M08X	8036423	1	16	25	8	65	M	28/14	X	70
G1625C08	8036430	1	16	25	8	65	C	18		70



TUNGSTEN CARBIDE ROTARY BURRS

H

FLAME

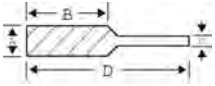

- DIN: FLH
- Deburring of large curved surfaces and inside tubes
- Type of cut: F = Fine, M = Medium, C = Coarse
- Stock standard: X = yes

	 731151		A mm	B mm	C mm	D mm				
H0613M03X	8196615	1	6	13	3	48	M	16/8	X	20
H1025F06	8182335	1	10	25	6	65	F	32		30
H1025M06	8182304	1	10	25	6	65	M	20	X	30
H1025M08	8273439	1	10	25	8	65	M	20		42
H1025M06X	8182311	1	10	25	6	65	M	20/10	X	30
H1025C06	8182328	1	10	25	6	65	C	14		30
H1232M06	8182076	1	12	32	6	72	M	24	X	40
H1232M06X	8181758	1	12	32	6	72	M	24/12	X	40
H1635F06	8192747	1	16	35	6	75	F	40		70
H1635M06X	8187422	1	16	35	6	75	M	28/14	X	70
H1635M06	8192730	1	16	35	6	75	M	28		70
H1635C06	8192754	1	16	35	6	75	C	18		70
H1635F08	8192778	1	16	35	8	75	F	40		70
H1635M08	8182083	1	16	35	8	75	M	28		70
H1635M08X	8182090	1	16	35	8	75	M	28/14		70
H1635C08	8192785	1	16	35	8	75	C	18		70

J

60° CONE

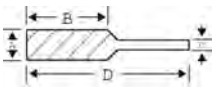

- DIN: KSJ
- Smoothing edges in 30°
- Type of cut: F = Fine, M = Medium, C = Coarse
- Stock standard: X = yes

	 731151		A mm	B mm	C mm	D mm				
J0604F06	8036492	1	6	4	6	55	F	24		20
J0604M06	8036508	1	6	4	6	55	M	16	X	20
J0604C06	8036515	1	6	4	6	55	C	10		20
J1010F06	8036522	1	10	10	6	50	F	30		25
J1010M06	8172473	1	10	10	6	50	M	21	X	25
J1010C06	8036553	1	10	10	6	50	C	15		25
J1212M06	8036577	1	12	12	6	52	M	24	X	30
J1616F06	8192815	1	16	16	6	56	F	39		40
J1616M06	8187439	1	16	16	6	56	M	27	X	40
J1616C06	8192822	1	16	16	6	56	C	21		40
J1616F08	8036607	1	16	16	8	56	F	39		40
J1616M08	8036614	1	16	16	8	56	M	27		40
J1616C08	8036638	1	16	16	8	56	C	21		40



K

90° CONE

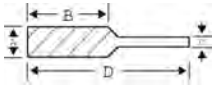

- DIN: KSK
- Smoothing edges in 45°
- Type of cut: F = Fine, M = Medium, C = Coarse
- Stock standard: X = yes

	 731151		A mm	B mm	C mm	D mm				
K0602F06	8036645	1	6	2	6	55	F	24		20
K0602M06	8036652	1	6	2	6	55	M	16	X	20
K0602C06	8036669	1	6	2	6	55	C	10		20
K1008F06	8036676	1	10	8	6	48	F	30		30
K1008M06	8036683	1	10	8	6	48	M	21	X	30
K1008C06	8036706	1	10	8	6	48	C	15		30
K1210F06	8036713	1	12	10	6	50	F	36		30
K1210M06	8036720	1	12	10	6	50	M	24	X	30
K1210C06	8036744	1	12	10	6	50	C	18		30
K1612F06	8193966	1	16	12	6	52	F	39		40
K1612M06	8193959	1	16	12	6	52	M	27		40
K1612C06	8193973	1	16	12	6	52	C	21		40
K1612M08	8036768	1	16	12	8	52	M	27	X	40
K1612F08	8036751	1	16	12	8	52	F	39		40
K1612C08	8036782	1	16	12	8	52	C	21		40

L

CONICAL ROUND NOSE

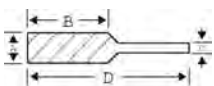

- DIN: KEL
- Long burr head for work in confined spaces with round corners
- Type of cut: F = Fine, M = Medium, C = Coarse
- Stock standard: X = yes

	 731151		A mm	B mm	C mm	D mm				
L1020F06	8182106	1	10	20	6	60	F	32		30
L1020M06	8133665	1	10	20	6	60	M	20	X	30
L1020M06X	8136369	1	10	20	6	60	M	20/10	X	30
L1020C06	8182113	1	10	20	6	60	C	14		30
L1225F06	8192860	1	12	25	6	65	F	36		30
L1225M06	8132774	1	12	25	6	65	M	24	X	30
L1225M06X	8136857	1	12	25	6	65	M	24/12	X	30
L1230F06	8182137	1	12	30	6	70	F	36		50
L1230M06	8182168	1	12	30	6	70	M	24	X	50
L1230M06X	8182175	1	12	30	6	70	M	24	X	50
L1230C06	8182120	1	12	30	6	70	C	16		50
L1630F06	8192921	1	16	30	6	70	F	40		70
L1630M06	8192914	1	16	30	6	70	M	28		70
L1630M06X	8187446	1	16	30	6	70	M	28/14	X	70
L1630C06	8192938	1	16	30	6	70	C	18		70
L1630M08	8182205	1	16	30	8	70	M	28	X	70
L1630M08X	8136833	1	16	30	8	70	M	28/14	X	70
L1630F08	8182151	1	16	30	8	70	F	40		70
L1630C08	8182144	1	16	30	8	70	C	18		70



TUNGSTEN CARBIDE ROTARY BURRS

M

CONICAL POINTED NOSE

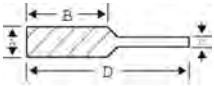

- DIN: SKM
- Deburring holes and in confined spaces
- Type of cut: F = Fine, M = Medium, C = Coarse
- Stock standard: X = yes

	 731151		A mm	B mm	C mm	D mm				 g
M0310F03	8036799	1	3	10	3	40	F	18	X	10
M0310M03	8036805	1	3	10	3	40	M	14	X	10
M0310M03X	8197063	1	3	10	3	40	M	14/7	X	10
M0310C03	8036812	1	3	10	3	40	C	10		10
M0613M03X	8196622	1	6	13	3	48	M	16/8	X	15
M0618F06	8036829	1	6	18	6	50	F	30	X	20
M0618M06	8036836	1	6	18	6	50	M	16	X	20
M0618M06X	8036850	1	6	18	6	50	M	16/8	X	20
M0618C06	8036867	1	6	18	6	50	C	10	X	20
M1022F06	8036874	1	10	20	6	60	F	36		30
M1022M06	8036881	1	10	20	6	60	M	21	X	30
M1022M06D	8210762	1	10	20	6	60	M	21/21		30
M1022M06X	8036904	1	10	20	6	60	M	21/11	X	30
M1022C06	8036911	1	10	20	6	60	C	18		30
M1227F06	8036935	1	12	25	6	65	F	36		40
M1227M06	8036928	1	12	25	6	65	M	24	X	40
M1227M06X	8036959	1	12	25	6	65	M	24/12	X	40
M1227C06	8036966	1	12	25	6	65	C	18		40
M1227F08	8036973	1	12	25	8	65	F	36		40
M1227M08	8036980	1	12	25	8	65	M	24		40
M1227M08X	8192990	1	12	25	8	65	M	24/12		40
M1227C08	8192983	1	12	25	8	65	C	18		40
M1630F06	8193027	1	16	30	6	70	F	39		70
M1630M06	8193010	1	16	30	6	70	M	27	X	70
M1630M06X	8187453	1	16	30	6	70	M	27/14	X	70
M1630C06	8193034	1	16	30	6	70	C	21		70
M1630F08	8037055	1	16	30	8	70	F	39		70
M1630M08	8037062	1	16	30	8	70	M	27	X	70
M1630M08X	8037086	1	16	30	8	70	M	27/14	X	70
M1630C08	8037093	1	16	30	8	70	C	21		70



N

INVERTED CONE

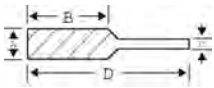

- DIN: WKN
- Deburring holes and in confined spaces
- Type of cut: F = Fine, M = Medium, C = Coarse
- Stock standard: X = yes

	 731151		A mm	B mm	C mm	D mm				
N0306F03	8193058	1	3	6	3	40	F	18		10
N0306M03	8182212	1	3	6	3	40	M	14	X	10
N0306M03E	8182229	1	3	6	3	40	M	14		10
N0306C03	8193065	1	3	6	3	40	C	10		10
N0607F06	8193072	1	6	7	6	50	F	24		20
N0607M06	8182236	1	6	7	6	50	M	16		20
N0607M06E	8182243	1	6	7	6	50	M	24		20
N0607C06	8193089	1	6	7	6	50	C	10		20
N1213F06	8193096	1	12	13	6	53	F	36		30
N1213M06	8134570	1	12	13	6	53	M	24	X	30
N1213M06E	8182250	1	12	13	6	53	M	24		30
N1213M06X	8237172	1	12	13	6	53	X	24	X	30
N1213C06	8193102	1	12	13	6	53	C	16		30
N1613F06	8193126	1	16	13	6	53	F	40		50
N1613M06	8136000	1	16	13	6	53	M	28		50
N1613M06E	8193119	1	16	13	6	53	M	28		50
N1613M06X	8204525	1	16	13	6	53	M	28/14		50
N1613C06	8193133	1	16	13	6	53	C	18		50
N1613F08	8193140	1	16	13	8	53	F	40		50
N1613M08	8182267	1	16	13	8	53	M	28	X	50
N1613M08E	8182274	1	16	13	8	53	M	28		50
N1613C08	8193157	1	16	13	8	53	C	18		50

A-AL

BURRS FOR ALUMINIUM CYLINDRICAL

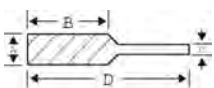

- Deburring aluminium and other soft materials
- Use wax to avoid chip build-up
- Special cutting edge suitable for soft materials
- Type of cut: AL = AL-cut
- Stock standard: X = yes

	 731151		A mm	B mm	C mm	D mm				
A0616AL06E	8181802	1	6	16	6	51	AL	5	X	20
A1225AL06E	8187620	1	12	25	6	70	AL	6	X	50
A1225AL08E	8181819	1	12	25	8	76	AL	6	X	50



TUNGSTEN CARBIDE ROTARY BURRS

C-AL

BURRS FOR ALUMINIUM CYLINDRICAL ROUND NOSE

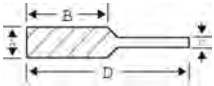

- Deburring aluminium and other soft materials
- Use wax to avoid chip build-up
- Special cutting edge suitable for soft materials
- Type of cut: AL = AL-cut
- Stock standard: X = yes

	 731151		A mm	B mm	C mm	D mm				
C0616AL06	8181826	1	6	16	6	51	AL	5	X	20
C1225AL06	8187637	1	12	25	6	70	AL	6	X	50
C1225AL08	8181833	1	12	25	8	76	AL	6	X	50

D-AL

BURRS FOR ALUMINIUM SPHERICAL

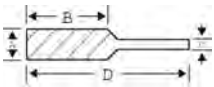

- Deburring aluminium and other soft materials
- Use wax to avoid chip build-up
- Special cutting edge suitable for soft materials
- Type of cut: AL = AL-cut
- Stock standard: X = yes

	 731151		A mm	B mm	C mm	D mm				
D1211AL06	8187644	1	12	11	6	56	AL	6	X	50
D1211AL08	8181840	1	12	11	8	62	AL	6		60

F-AL

BURRS FOR ALUMINIUM ARCH ROUND NOSE

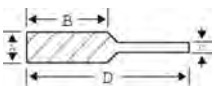

- Deburring aluminium and other soft materials
- Use wax to avoid chip build-up
- Special cutting edge suitable for soft materials
- Type of cut: AL = AL-cut
- Stock standard: X = yes

	 731151		A mm	B mm	C mm	D mm				
F0618AL06	8181857	1	6	18	6	51	AL	5	X	20
F1225AL06	8187651	1	12	25	6	70	AL	6	X	50
F1225AL08	8181864	1	12	25	8	70	AL	6	X	50



L-AL

BURRS FOR ALUMINIUM CONICAL, ROUND NOSE

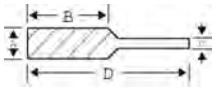

- Deburring aluminium and other soft materials
- Use wax to avoid chip build-up
- Special cutting edge suitable for soft materials
- Type of cut: AL = AL-cut
- Stock standard: X = yes

	 731151		A mm	B mm	C mm	D mm				
L1230AL06	8187668	1	12	30	6	76	AL	6	X	50
L1230AL08	8181871	1	12	30	8	82	AL	6		50

A-int

SPECIAL BURRS FOR INTERNAL GRINDING

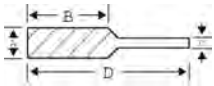

- Internal toolpost grinding for centre lathe
- Special cutting edge for high finish
- Type of cut: D = Diamond
- Stock standard: X = yes

	 731151		A mm	B mm	C mm	D mm				
A0408F03D	8197926	1	4	8	3	50	D	20/20		6
A0610F06D	8197933	1	6	10	6	65	D	24/24		15
A0810F06D	8197957	1	8	10	6	65	D	28/28	X	20

A/G

SPECIAL BURRS FOR TYRE REPAIRS

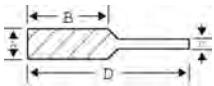

- Cleaning and reaming for repairs of tyres
- Maximum speed 1500 r.p.m. Speeds exceeding 1500 r.p.m. generates heat which destroys the bond between the rubber and the steel reinforcement
- Burrs marked with "T" in column "Shank mm" have triangular shank
- Type of cut: X = X-cut
- Stock standard: X = yes

	 731151		A mm	B mm	C mm	D mm				
A0320M03X	8197773	1	3	20	3	40	X	14/7	X	10
A0625M06X	8197780	1	6	25	6	65	X	16/8	X	20
G0645M4.9X	8195380	1	6	45	T 4.9	75	X	12/6		50
G0845M6.6X	8195403	1	8	45	T 6.6	90	X	16/8		60
G1050M8.3X	8195397	1	10	50	T 8.3	110	X	20/10		70
HSSG-G0645MX	8195496	1	6	45	6	75	X	12/6		50



HSS ROTARY BURRS

HSSG-A

CYLINDRICAL

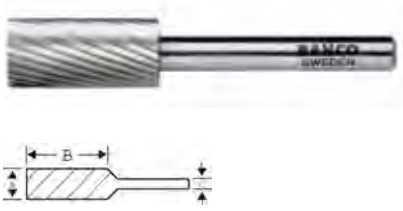

- Rotary burrs, HSS
- High speed steel burrs are used primarily for machining soft steel, aluminium, bronze, brass, etc
- High speed steel burrs are a better choice when optimal machining conditions cannot be maintained or, when the risk of vibration and impact shock are high
- Also usable with low cutting speeds
- Type of cut:
 - M: Medium, for machining unhardened steel and other moderately hard materials under normal conditions
 - EC: Extra coarse, for soft materials when good stock removal is required, counteracts chip build-up between teeth
- Packaging: Plastic box - Individually packed in boxes of 5

	 731151		A mm	B mm	C mm		 g
HSSG-A0616M	8023379	1	6	16	6	M	20
HSSG-A1020M	8023386	1	10	20	6	M	30
HSSG-A1225EC	8023409	1	12	25	6	EC	40
HSSG-A1225M	8023393	1	12	25	6	M	40
HSSG-A1625M	8023416	1	16	25	6	M	50

HSSG-A-S

CYLINDRICAL SINGLE PACK

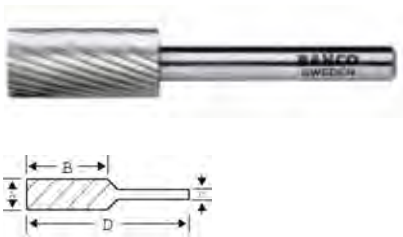

- Rotary burr, HSS
- Retail packed
- High speed steel burrs are used primarily for machining soft steel, aluminium, bronze, brass, etc
- High speed steel burrs are a better choice when optimal machining conditions cannot be maintained or, when the risk of vibration and impact shock are high
- Also usable with low cut speeds
- Type of cut:
 - M: Medium, for machining unhardened steel and other moderately hard materials under normal conditions
 - EC: Extra coarse, for soft materials when good stock removal is required, counteracts chip build-up between teeth
- Packaging: Plastic box - Individually packed

	 731151		A mm	B mm	C mm	D mm		 TC	 g
HSSG-A0616M-S	8022501	1	6	16	6	50	M	16	20
HSSG-A1020M-S	8022518	1	10	20	6	60	M	20	30
HSSG-A1225M-S	8022525	1	12	25	6	65	M	24	40
HSSG-A1225EC-S	8022532	1	12	25	6	65	EC	7	40
HSSG-A1625M-S	8022549	1	16	25	6	65	M	28	50



HSSG-C

CYLINDRICAL ROUND NOSE

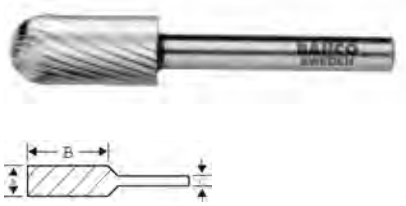

- Rotary burrs, HSS
- High speed steel burrs are used primarily for machining soft steel, aluminium, bronze, brass, etc
- High speed steel burrs are a better choice when optimal machining conditions cannot be maintained or, when the risk of vibration and impact shock are high
- Also usable with low cutting speeds
- Type of cut:
 - M: Medium, for machining unhardened steel and other moderately hard materials under normal conditions
 - EC: Extra coarse, for soft materials when good stock removal is required, counteracts chip build-up between teeth
- Packaging: Plastic box - Individually packed in boxes of 5

	 731151		A mm	B mm	C mm		
HSSG-C0616M	8023423	1	6	16	6	M	20
HSSG-C1020M	8023430	1	10	20	6	M	20
HSSG-C1225EC	8023454	1	12	25	6	EC	40
HSSG-C1225M	8023447	1	12	25	6	M	40

HSSG-C-S

CYLINDRICAL ROUND NOSE SINGLE PACK

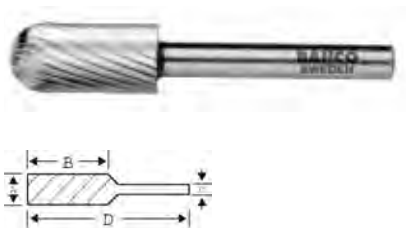

- Rotary burr, HSS
- Retail packed
- High speed steel burrs are used primarily for machining soft steel, aluminium, bronze, brass, etc
- High speed steel burrs are a better choice when optimal machining conditions cannot be maintained or, when the risk of vibration and impact shock are high
- Also usable with low cut speeds
- Type of cut:
 - M: Medium, for machining unhardened steel and other moderately hard materials under normal conditions
 - EC: Extra coarse, for soft materials when good stock removal is required, counteracts chip build-up between teeth
- Packaging: Plastic box - Individually packed

	 731151		A mm	B mm	C mm	D mm			
HSSG-C0616M-S	8022556	1	6	16	6	50	M	16	20
HSSG-C1020M-S	8022563	1	10	20	6	60	M	20	30
HSSG-C1225M-S	8022570	1	12	25	6	65	M	24	40
HSSG-C1225EC-S	8022587	1	12	25	6	65	EC	7	40



HSS ROTARY BURRS

HSSG-D

SPHERICAL

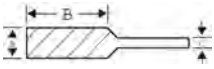

- Rotary burrs, HSS
- High speed steel burrs are used primarily for machining soft steel, aluminium, bronze, brass, etc
- High speed steel burrs are a better choice when optimal machining conditions cannot be maintained or, when the risk of vibration and impact shock are high
- Also usable with low cutting speeds
- Type of cut:
 - M: Medium, for machining unhardened steel and other moderately hard materials under normal conditions
 - EC: Extra coarse, for soft materials when good stock removal is required. Counteracts chip build-up between teeth
- Packaging: Plastic box - Individually packed in boxes of 5

	 731151		A mm	B mm	C mm		 g
HSSG-D0606M	8023461	1	6	6	6	M	20
HSSG-D0807M	8023478	1	8	7	6	M	20
HSSG-D1009M	8023485	1	10	9	6	M	20
HSSG-D1211EC	8023508	1	12	11	6	EC	20
HSSG-D1211M	8023492	1	12	11	6	M	20
HSSG-D1614M	8023515	1	16	14	6	M	30

HSSG-D-S

SPHERICAL SINGLE PACK

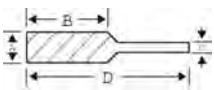

- Rotary burr, HSS
- Retail packed
- High speed steel burrs are used primarily for machining soft steel, aluminium, bronze, brass, etc
- High speed steel burrs are a better choice when optimal machining conditions cannot be maintained or, when the risk of vibration and impact shock are high
- Also usable with low cut speeds
- Type of cut:
 - M: Medium, for machining unhardened steel and other moderately hard materials under normal conditions
 - EC: Extra coarse, for soft materials when good stock removal is required, counteracts chip build-up between teeth
- Packaging: Plastic box - Individually packed

	 731151		A mm	B mm	C mm	D mm			 g
HSSG-D0606M-S	8022594	1	6	6	6	50	M	16	20
HSSG-D0807M-S	8022600	1	8	7	6	47	M	18	20
HSSG-D1009M-S	8022617	1	10	9	6	49	M	20	20
HSSG-D1211M-S	8022624	1	12	11	6	51	M	24	20
HSSG-D1211EC-S	8022631	1	12	11	6	51	EC	7	20



HSSG-E

OVAL

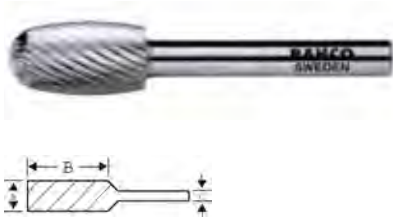

- Rotary burrs, HSS
- High speed steel burrs are used primarily for machining soft steel, aluminium, bronze, brass, etc
- High speed steel burrs are a better choice when optimal machining conditions cannot be maintained or, when the risk of vibration and impact shock are high
- Also usable with low cutting speeds
- Type of cut:
 - M: Medium, for machining unhardened steel and other moderately hard materials under normal conditions
 - EC: Extra coarse, for soft materials when good stock removal is required. Counteracts chip build-up between teeth
- Packaging: Plastic box - Individually packed in boxes of 5

	 731151		A mm	B mm	C mm		
HSSG-E0614M	8023522	1	6	14	6	M	20
HSSG-E1222EC	8023546	1	12	22	6	EC	30
HSSG-E1222M	8023539	1	12	22	6	M	30
HSSG-E1625M	8023553	1	16	25	6	M	50

HSSG-E-S

OVAL SINGLE PACK



- Rotary Burr, HSS
- Retail packed
- High speed steel burrs are used primarily for machining soft steel, aluminium, bronze, brass, etc
- High speed steel burrs are a better choice when optimal machining conditions cannot be maintained or, when the risk of vibration and impact shock are high
- Also usable with low cut speeds
- Type of cut:
 - M: Medium, for machining unhardened steel and other moderately hard materials under normal conditions
 - EC: Extra coarse, for soft materials when good stock removal is required, counteracts chip build-up between teeth
- Packaging: Plastic box - Individually packed

	 731151		A mm	B mm	C mm	D mm			
HSSG-E1222M-S	8022662	1	12	22	6	62	M	24	30
HSSG-E1222EC-S	8022679	1	12	22	6	62	EC	7	30
HSSG-E1625M-S	8022686	1	16	25	6	65	M	28	50



HSS ROTARY BURRS

HSSG-F

ARCH ROUND NOSE



- Rotary burrs, HSS
- High speed steel burrs are used primarily for machining soft steel, aluminium, bronze, brass, etc
- High speed steel burrs are a better choice when optimal machining conditions cannot be maintained or, when the risk of vibration and impact shock are high
- Also usable with low cutting speeds
- Type of cut: M = Medium, for machining unhardened steel and other moderately hard materials under normal conditions
- Packaging: Plastic box - Individually packed in boxes of 5

	 731151		A mm	B mm	C mm		
HSSG-F0618M	8023560	1	6	18	6	M	20
HSSG-F1225M	8023577	1	12	25	6	M	30
HSSG-F1625M	8023584	1	16	25	6	M	40

HSSG-F-S

ARCH ROUND NOSE SINGLE PACK



- Rotary burr, HSS
- Retail packed
- High speed steel burrs are used primarily for machining soft steel, aluminium, bronze, brass, etc
- High speed steel burrs are a better choice when optimal machining conditions cannot be maintained or, when the risk of vibration and impact shock are high
- Also usable with low cut speeds
- Type of cut: M: Medium, for machining unhardened steel and other moderately hard materials under normal conditions
- Packaging: Plastic box - Individually packed

	 731151		A mm	B mm	C mm	D mm			
HSSG-F0618M-S	8022693	1	6	18	6	50	M	16	20
HSSG-F1225M-S	8022709	1	12	25	6	65	M	24	30



HSSG-G

ARCH POINTED NOSE

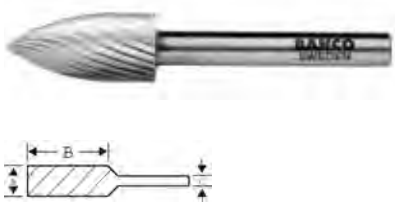

- Rotary burrs, HSS
- High speed steel burrs are used primarily for machining soft steel, aluminium, bronze, brass, etc
- High speed steel burrs are a better choice when optimal machining conditions cannot be maintained or, when the risk of vibration and impact shock are high
- Also usable with low cutting speeds
- Type of cut:
M: Medium, for machining unhardened steel and other moderately hard materials under normal conditions
EC: Extra Coarse, for soft materials when good stock removal is required, counteracts chip build-up between teeth
- Packaging: Plastic box - Individually packed in boxes of 5

	 731151		A mm	B mm	C mm		 g
HSSG-G0618M	8023591	1	6	18	6	M	20
HSSG-G1220M	8023607	1	12	20	6	M	30
HSSG-G1225EC	8023621	1	12	25	6	EC	30
HSSG-G1225M	8023614	1	12	25	6	M	30

HSSG-G-S

ARCH POINTED NOSE SINGLE PACK

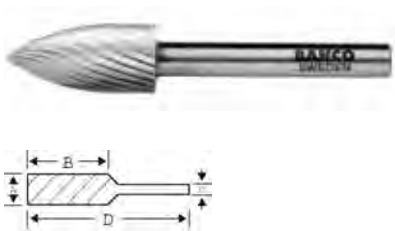

- Rotary burr, HSS
- High speed steel burrs are used primarily for machining soft steel, aluminium, bronze, brass, etc
- High speed steel burrs are a better choice when optimal machining conditions cannot be maintained or, when the risk of vibration and impact shock are high
- Also usable with low cut speeds
- Type of cut: M: Medium, for machining unhardened steel and other moderately hard materials under normal conditions
- Packaging: Plastic box. Individually packed

	 731151		A mm	B mm	C mm	D mm			 g
HSSG-G0618M-S	8022716	1	6	18	6	50	M	16	20
HSSG-G1220M-S	8022723	1	12	20	6	60	M	24	30
HSSG-G1225M-S	8022730	1	12	25	6	65	M	24	30



HSS ROTARY BURRS

HSSG-M

CONICAL POINTED NOSE

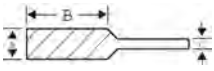

- Rotary burrs, HSS
- High speed steel burrs are used primarily for machining soft steel, aluminium, bronze, brass, etc
- High speed steel burrs are a better choice when optimal machining conditions cannot be maintained or, when the risk of vibration and impact shock are high
- Also usable with low cutting speeds
- Type of cut: M: Medium, for machining unhardened steel and other moderately hard materials under normal conditions
- Packaging: Plastic box - Individually packed in boxes of 5

	 731151		A mm	B mm	C mm		 g
HSSG-M0618M	8023638	1	6	18	6	M	20
HSSG-M1227M	8023645	1	12	27	6	M	30

HSSG-M-S

CONICAL POINTED NOSE SINGLE PACK

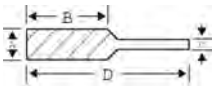

- Rotary burr, HSS
- Retail packed
- High speed steel burrs are used primarily for machining soft steel, aluminium, bronze, brass, etc
- High speed steel burrs are a better choice when optimal machining conditions cannot be maintained or, when the risk of vibration and impact shock are high
- Also usable with low cut speeds
- Type of cut: M: Medium, for machining unhardened steel and other moderately hard materials under normal conditions
- Packaging: Plastic box - Individually packed

	 731151		A mm	B mm	C mm	D mm			 g
HSSG-M0618M-S	8022754	1	6	18	6	50	M	16	20
HSSG-M1227M-S	8022761	1	12	27	6	67	M	24	30



HSSG-N

INVERTED CONE

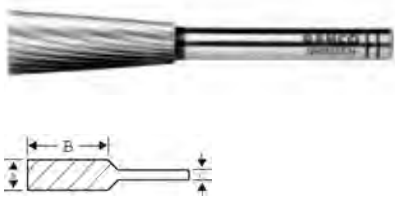

- Rotary burr, HSS
- High speed steel burrs are used primarily for machining soft steel, aluminium, bronze, brass, etc
- High speed steel burrs are a better choice when optimal machining conditions cannot be maintained or, when the risk of vibration and impact shock are high
- Also usable with low cutting speeds
- Type of cut: M: Medium, for machining unhardened steel and other moderately hard materials under normal conditions
- Packaging: Plastic box - Individually packed in boxes of 5

	 731151		A mm	B mm	C mm		 g
HSSG-N1230M	8188016	1	12	30	6	M	30

HSSG-O

OVAL POINTED NOSE



- Rotary burr, HSS
- High speed steel burrs are used primarily for machining soft steel, aluminium, bronze, brass, etc
- High speed steel burrs are a better choice when optimal machining conditions cannot be maintained or, when the risk of vibration and impact shock are high
- Also usable with low cutting speeds
- Type of cut: M: Medium, for machining unhardened steel and other moderately hard materials under normal conditions
- Packaging: Plastic box - Individually packed in boxes of 5

	 731151		A mm	B mm	C mm		 g
HSSG-O1218M	8188030	1	12	18	6	M	30

HSSG-P

PEAR



- Rotary burrs, HSS
- High speed steel burrs are used primarily for machining soft steel, aluminium, bronze, brass, etc.
- High speed steel burrs are a better choice when optimal machining conditions cannot be maintained or, when the risk of vibration and impact shock are high
- Also usable with low cutting speeds
- Type of cut: M: Medium, for machining unhardened steel and other moderately hard materials under normal conditions
- Packaging: Plastic box - Individually packed in boxes of 5

	 731151		A mm	B mm	C mm		 g
HSSG-P0622M	8188054	1	6	22	6	M	20
HSSG-P1230M	8188078	1	12	30	6	M	30



52

BRUSHES



- Spark plug wire brush for easy cleaning of spark plug gauges
- With wooden handle and fine brass wire bristles

	 731151		 L mm	 g
52	8276027	1	150	16

782-U

BRUSHES



- General purpose utility wire brush for cleaning of dirt, rust, paint etc
- With wooden handle and 4 rows of steel bristles

	 731151		 L mm	 g
782-U	8276447	1	290	120

783

BRUSHES



- Brake steel brush for cleaning of disc brakes and drums
- With plastic handle and 2 rows of steel bristles

	 731151		 L mm	 g
783	8276034	1	230	90

2555

BRUSHES



- Terminal brush that removes corrosion and dirt from battery terminals and cable clamps
- The external brush cleans cable clamps and the internal brush cleans terminal posts
- With metal housing and steel bristles



	 731151		 L mm	 g
2555	8276041	12	85	67



WRENCHES

Bahco wrenches are designed and manufactured with the optimal dimensions to suit the workplace and meet the requirements of the end-user in terms of power and handling. More than 800 different wrenches in the range cover an extremely wide variety of applications, making Bahco the specialist in wrenches.

Bahco wrenches improve accessibility in confined spaces with a patented shape and design at the handle for a wider and more comfortable grip.

The Dynamic Drive™ Profile on the wrench's ring end increases the contact with the nut's flank surfaces, rather than its corners. This flat surface contact reduces wear and gives excellent performance.

With Dynamic Drive™ Profile, a substantially higher torque can be applied without wear to the screw or wrench. Even worn and imprecise nuts can be turned with this profile.

Traditionally, Bahco has combined a quality compound of high-alloyed steel with the right heat treatment – hardening and annealing to guarantee a high-quality tool. As a result, our wrench family withstands more torque without deformation, delivering more power and a longer life.

We are also proud to present the Bahco ERGO™ adjustable wrench, the result of extensive development work where professional users and specialists in ergonomics have worked alongside each other to create exceptional user-friendly tools. The various models and sizes are available in phosphate and chrome-plated versions, with or without the comfortable ergonomic handle.

Chapter Index

ADJUSTABLE WRENCHES	142-148
COMBINATION WRENCHES	149-157
RATCHETING WRENCHES	158-165
OPEN END WRENCHES	166-174
RING END WRENCHES	175-179
FLARE NUT WRENCHES	180-181
HEAVY DUTY WRENCHES	182-186
TUBULAR WRENCHES	187-193
SPECIAL WRENCHES	194

ADJUSTABLE WRENCHES

90 SERIES

“Over 120 years producing adjustable wrenches”

The ERGO™ 90 series has more functions than any other adjustable wrench.
The ergonomic design of the handle, jaws and grip:

- Makes it possible to use hand strength in the best and most efficient way
- Gives the best, safest grip in different work positions
- Protects against unnecessary work injuries

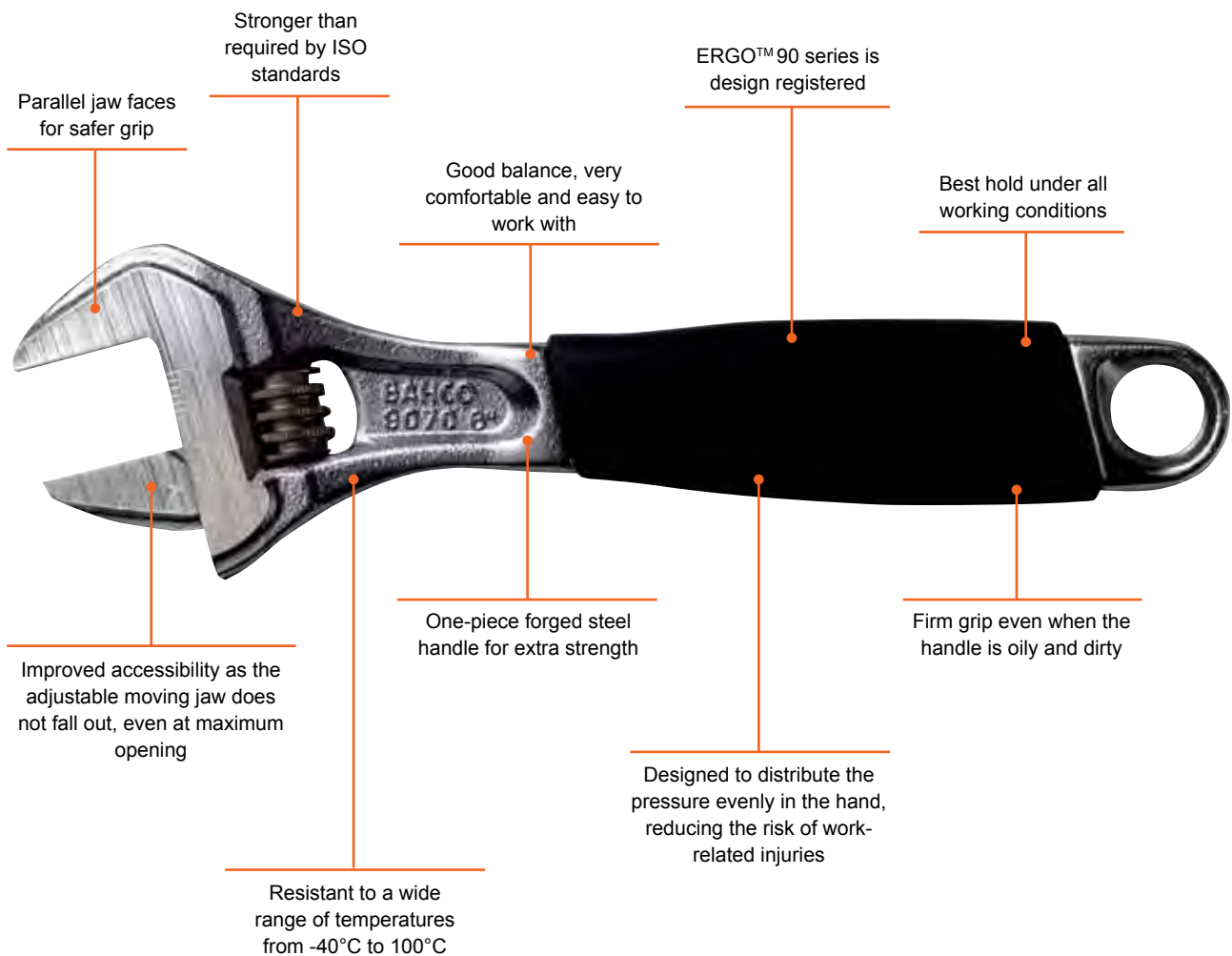

COMBINATION ADJUSTABLE WRENCHES

This wrench is not only ideal for use with ordinary nuts, but also pipes, rounded nuts and bolts.

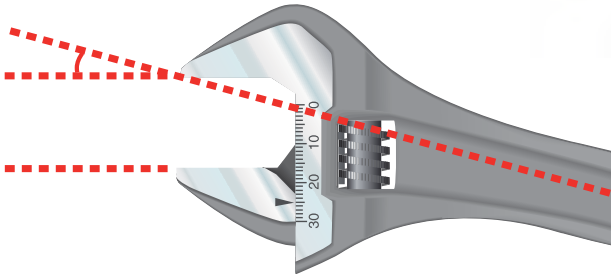

Jaws angled at 15° to give good access even in confined spaces.

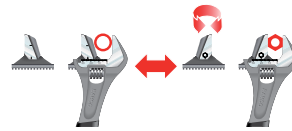

By reversing the movable jaw you can use the tool as a standard adjustable wrench for nuts and bolts.

9029-9035 & 9031T **ergo**®

The ERGO™ type 9029-9035 and 9031T series - big Bahco inventions, yet small enough to fit in your back pocket...

Thinner jaws improve access in confined spaces

Extra width to grip large nuts
9029: 1 1/4 inches / 32 mm
9031: 1 1/2 inches / 38 mm

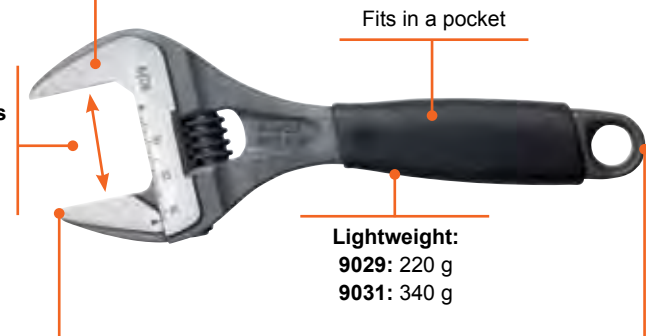

9029: 6 inches/170 mm
9031: 8 inches/218 mm

9031T

Extra thin jaws for accessibility

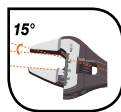

Extra wide opening

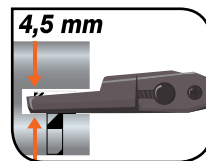

Extra slim jaws

SIDE NUT ADJUSTABLE

FEATURES & BENEFITS

- Side-nut operating system
- Chrome-plated finishing
- Precision tuning



BETTER TORQUE CAPACITY



THE BEST ADJUSTABLE WRENCH FOR HEXAGONAL NUTS



MEASURING SCALE IN MM



FORGED IN ONE PIECE



also with thermoplastic handle

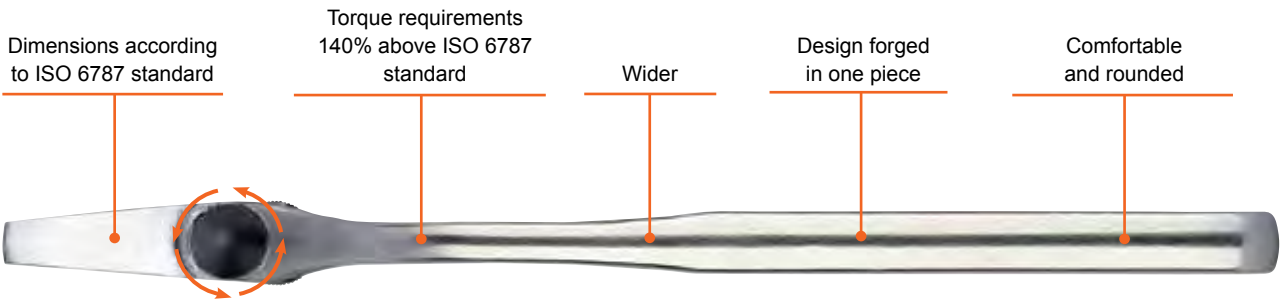

Dimensions according to ISO 6787 standard

Torque requirements 140% above ISO 6787 standard

Wider

Design forged in one piece

Comfortable and rounded

BAHCO RATCHETING WRENCHES

TIME SAVING: WORK FASTER WITH GREAT PERFORMANCE

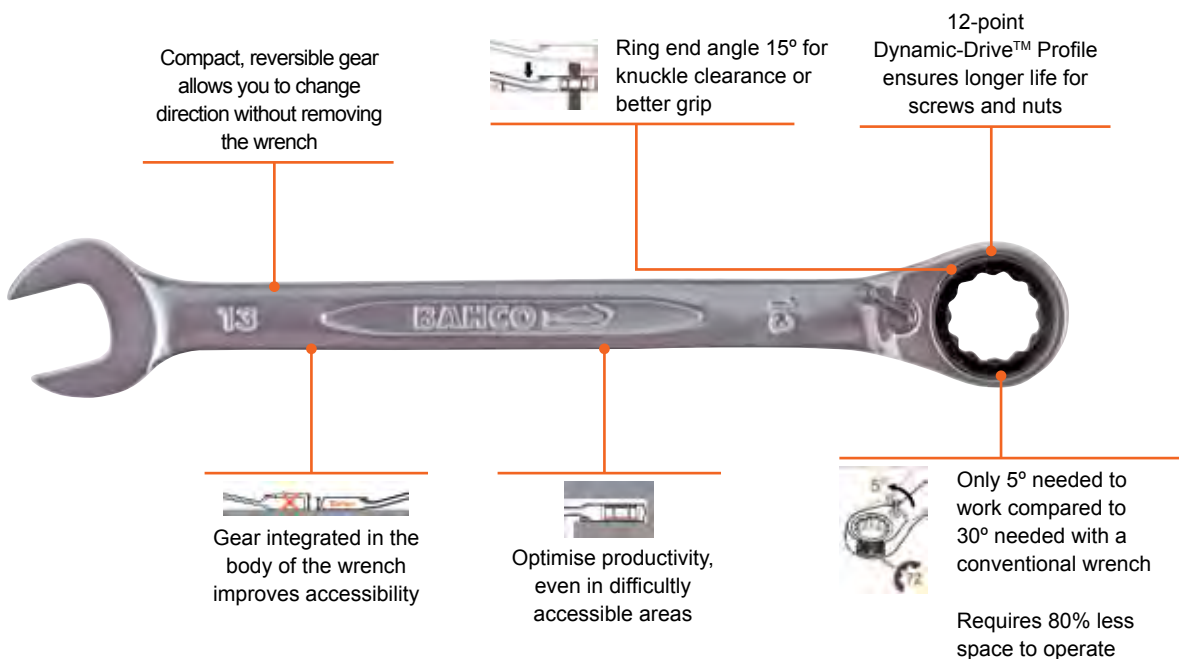

Compact, reversible gear allows you to change direction without removing the wrench



Ring end angle 15° for knuckle clearance or better grip

12-point Dynamic-Drive™ Profile ensures longer life for screws and nuts



Gear integrated in the body of the wrench improves accessibility



Optimise productivity, even in difficultly accessible areas



Only 5° needed to work compared to 30° needed with a conventional wrench

Requires 80% less space to operate

DOUBLE OPEN END AND COMBINATION WRENCHES



Easy to work with

- The U-Design at the handle section provides a comfortable surface for gripping the tool

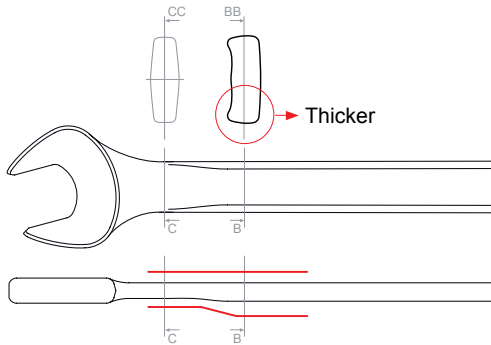

- Wide surface in corners, to better position the thumb while safely fastening or unfastening the screw



- The **asymmetrical shape** allows the user to know the orientation of the open end (15 ° left or right)

15° RIGHT

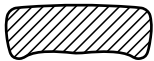

15° LEFT

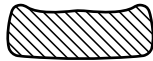

- **Dynamic Drive™ Profile:** It maximises the life of the tool and nut. The tool does not touch the corners of the nut, so it avoids rounding them, and the torque is applied directly to the sides which improves performance
- **Ring end:** Conical shape on both sides of the ring to introduce the nut or screw heads more easily



- Highly visible and uni-directional size marking



Better accessibility and longer life:

- The position of the connecting point of the centre axle of the open end and the shank gives high accessibility to the open end



- Long-life duration on the nut or screw due to the large surface area in contact with the nut

- Excellent accessibility to restricted working areas

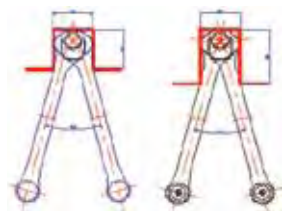

LEAD-IN CHAMFER

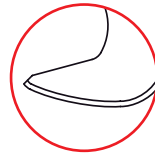



ADJUSTABLE WRENCHES

90

90 SERIES

ergo®



9072



9072P

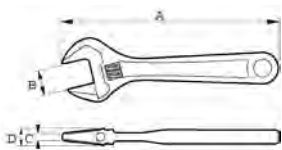

- Adjustable wrenches developed according to the scientific ERGO™ process
- Standards: ISO 6787, DIN 3117, ASME B107.8M - 1996 and BS 6333
- High performance alloy steel
- Comfortable non slip thermoplastic grip handle
- Scale in mm for pre adjusting and accurate measurement
- The jaw does not fall out even at maximum opening of the wrench
- Head angle 15° provides better accessibility
- Left going screw
- P series: Reversible jaw for pipe use
- Black finish. Precision hardened and anti-corrosion treated

	 731415		A mm	B mm	C mm	D mm	 g
9070	0100170	5	158	20	4.9	11.3	139
9070 P	0103416	5	158	21	4.9	11.3	139
9071	0100194	5	208	27	6.0	12.9	272
9071 P	0103430	5	208	28	6.0	12.9	272
9072	0055609	5	257	31	8.7	15.2	425
9072 P	0056354	5	257	33	8.7	15.2	430
9073	0101702	5	308	34	11.9	17.6	730
9073 P	0101726	5	308	35	11.9	17.6	745

90C

90 SERIES

ergo®



9072 C



9072 PC

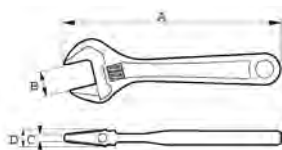

- Adjustable wrenches developed according to the scientific ERGO™ process
- Standards: ISO 6787, DIN 3117, ASME B107.8M - 1996 and BS 6333
- High performance alloy steel
- Comfortable non slip thermoplastic grip handle
- Scale in mm for pre adjusting and accurate measurement
- The jaw does not fall out even at maximum opening of the wrench
- Head angle 15° provides better accessibility
- Left going screw
- P series: Reversible jaw for pipe use
- Chrome plated, precision hardened and anti-corrosion treated

	 731415		A mm	B mm	C mm	D mm	 g
9070C	0100187	5	158	20	4.9	11.3	139
9070 PC	0103423	5	158	21	4.9	11.3	139
9071C	0100200	5	208	27	6.0	12.9	272
9071 PC	0103447	5	208	28	6.0	12.9	272
9072 C	0055616	5	257	31	8.7	15.2	425
9072 PC	0056361	5	257	33	8.7	15.2	430
9073 C	0101719	3	308	34	11.9	17.6	730
9073 PC	0101733	3	308	35	11.9	17.6	745



9029-9035

90 SERIES

ergo®

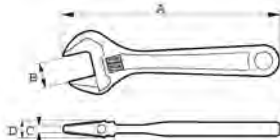

- Adjustable wrenches developed according to the scientific ERGO™ process
- Special adjustable wrenches with extra wide jaw opening
- Standards: ISO 6787, DIN 3117, ASME B107.8M - 2003 and BS 6333
- High performance alloy steel
- Comfortable non slip thermoplastic grip handle
- Scale in mm for pre adjusting and accurate measurement
- The jaw does not fall out even at maximum opening of the wrench
- Wider opening jaw and shorter handle than a standard wrench
- Head combines slimness for accessibility with strength for performance
- Left going screw
- Black finish, precision-hardened and anti-corrosion treated

	 731415		A mm	B mm	C mm	D mm	 g
9029	3010612	5	170	32	5	12	220
9031	0110988	5	218	38	6	13	340
9033	0181414	5	270	46.5	8	18	525
9035	0181421	5	324	55.6	9.5	21.5	825

9029C/9031C

90 SERIES

ergo®

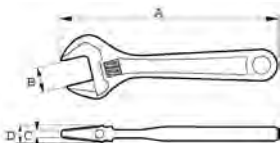

- Adjustable wrenches developed according to the scientific ERGO™ process
- Special adjustable wrenches with extra wide jaw opening
- Standards: ISO 6787, DIN 3117, ASME B107.8M - 2003 and BS 6333
- High performance alloy steel
- Comfortable non slip thermoplastic grip handle
- Scale in mm for pre adjusting and accurate measurement
- The jaw does not fall out even at maximum opening of the wrench
- 40% wider opening compared to a standard adjustable wrench and lower weight with a shorter handle than a standard wrench
- Head combines slimness for accessibility with strength for performance
- Left going screw
- Chrome plated, precision-hardened and anti-corrosion treated

	 731415		A mm	B mm	C mm	D mm	 g
9029 C	3010629	5	170	32	5	12	220
9031 C	0113507	5	218	38	6	13	340



ADJUSTABLE WRENCHES

9031-T

90 SERIES

ergo®

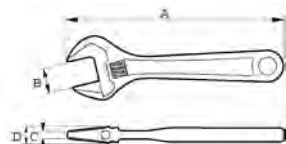

- Adjustable wrenches developed according to the scientific ERGO™ process
- Special adjustable wrenches 6" and 8" with extra wide opening
- Standards: ISO 6787, DIN 3117, ASME B107.8M - 2003 and BS 6333
- High performance alloy steel
- Comfortable and non slip thermoplastic grip handle
- Scale in mm for pre adjusting and accurate measurement
- The jaw does not fall out even at maximum opening of the wrench
- 40% wider opening compared to a standard adjustable wrench
- 45% thinner jaws, compared to a standard adjustable wrench
- Lower weight with a convenient length of the handle
- Head combines slimness for accessibility with strength for performance
- Left going screw
- Black finish, precision-hardened and anti-corrosion treated

	 731415		A mm	B mm	C mm	D mm	 g
9029-T	0189076	5	170	32	4,5	12	196
9031-T	0131648	5	218	38	4,5	13	325

9031P

90 SERIES

ergo®



- Adjustable wrenches developed according to the scientific ERGO™ process
- Special adjustable wrench with extra wide opening
- Reversible jaw for pipe use
- Standards: ISO 6787, DIN 3117, ASME B107.8M - 2003 and BS 6333
- High performance alloy steel
- Comfortable and non slip thermoplastic grip handle
- Scale in mm for pre adjusting and accurate measurement
- 40% wider opening compared to a standard adjustable wrench
- Lower weight with a convenient length of the handle
- Head combines slimness for accessibility with strength for performance
- Left going screw
- Black finish, precision-hardened and anti-corrosion treated

	 731415		A mm	B mm	C mm	D mm	 g
9031P	0187539	5	218	39	6	13	340



80

80 SERIES

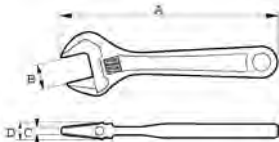

- Standards: ISO 6787, DIN 3117 form, ASME B107.8M - 1996 and BS 6333
- High performance alloy steel
- Scale in mm for pre adjusting and accurate measurement
- Head combines slimness for accessibility with strength for performance
- Left going screw
- Black finish. Precision-hardened and anti-corrosion treated
- IP: Industrial pack

	 731415		A mm	B mm	C mm	D mm	 g
8069	0007028	5	110	13	4.0	9.0	60
8070	0007110	5	155	20	4.9	11.3	135
8071	0007202	5	205	27	6.0	12.9	255
8072	0007288	5	255	30	8.6	15.5	400
8073	0007363	5	305	34	11.9	18.0	665
8074	0007448	3	380	44	14.0	20.0	1035
8075	0007523	3	455	53	17.7	22.5	1665
8069 IP	0007042	50	110	13	4.0	9.0	60
8070 IP	0007134	40	155	20	4.9	11.3	135
8071 IP	0007226	50	205	27	6.0	12.9	255
8072 IP	0007301	30	255	30	8.6	15.5	400
8073 IP	0007387	20	305	34	11.9	18.0	665
8074 IP	0007462	20	380	44	14.0	20.0	1035
8075 IP	0007547	10	455	53	11.7	22.5	1665

80C

80 SERIES

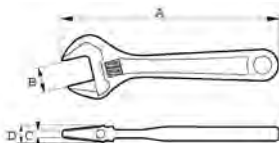

- Standards: ISO 6787, DIN 3117 form, ASME B107.8M - 1996 and BS 6333
- High performance alloy steel
- Scale in mm for pre adjusting and accurate measurement
- Head combines slimness for accessibility with strength for performance
- Left going screw
- Chrome plated. Precision-hardened and anti-corrosion treated
- IP: Industrial pack

	 731415		A mm	B mm	C mm	D mm	 g
8069 C	0007035	5	110	13	4.0	9.0	60
8070 C	0007127	5	155	20	4.9	11.5	132
8071 C	0007219	5	205	27	6.0	13.0	255
8072 C	0007295	5	255	30	8.6	15.5	400
8073 C	0007370	3	305	34	11.9	18.0	665
8074 C	0007455	3	380	44	14.0	20.0	1035
8075 C	0007530	3	455	53	17.7	22.5	1665
8069 C IP	0101634	5	110	13	4.0	9.0	60
8070 C IP	0101641	5	155	20	4.9	11.5	132
8071 C IP	0101658	5	205	27	6.0	13.0	255
8072 C IP	0101665	5	255	30	8.6	15.5	400
8073 C IP	0101672	3	305	34	11.9	18.0	665
8074 C IP	0101689	3	380	44	14.0	20.0	1035
8075 C IP	0101696	3	455	53	17.7	22.5	1665



ADJUSTABLE WRENCHES

31/86/87

80 SERIES



31



86 - 87

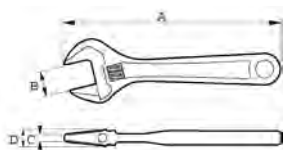

- Standards: ISO 6787, DIN 3117, BS 6333, ASME B107.8M – 1996
- High performance alloy steel
- Head angle 15° for the 31 model provides better accessibility
- Head angle 22.5° for the 86 and 87 models provides better accessibility
- 31 models includes left and right going screw
- P series: Reversible jaw for pipe use
- Phosphated. Precision-hardened and anti-corrosion treated
- IP: Industrial pack

	 731415		A mm	B mm	C mm	D mm	 g
31	0004942	5	205	32	5.5	13.5	270
31 IP	0004959	50	205	32	5.5	13.5	270
86	0005376	6	614	63	27.5	29.0	3165
87	0005406	3	770	85	31.0	33.0	5700

RPS

SPARE PARTS



- Spare parts kits for the adjustable wrench 80 and 90 series
- Complete with jaw, roll, pin and spring
- Finish: Phosphated
- Left going

	 731415			 g
8069-95	0007073	1	8069, 8069C	5
8070-95	0007165	1	8070, 8070C, 9070, 9070C	10
8071-95	0007257	1	8071, 8071C, 9071, 9071C	12
8072-95	0007332	1	8072, 8072C, 8072P, 8072PC, 9072, 9072C	18
8073-95	0007417	1	8073, 8073C, 8073P, 8073PC, 9073, 9073C	26
8074-95	0007493	1	8074, 8074C	40
8075-95	0007578	1	8075, 8075C	57
9029-95	0117222	1	9029, 9029C	80
9031-95	0114511	1	9031, 9031C	100
31-95	0004973	1	31	10



RPS-P



SPARE PARTS

- Spare parts kits for the adjustable wrench 80 and 90 series
- Complete with jaw, roll, pin and spring
- Finish: Phosphated
- Left going

	 731151			 g
9070 P-95	8289263	1	9070P, 9070PC	28
9071 P-95	8289270	1	9071P, 9071PC	60
9072 P-95	8289287	1	8072P, 8072PC, 9072P, 9072PC	76
9073 P-95	8289294	1	8073P, 8073PC, 9073P, 9073PC	91

RPS-R



SPARE PARTS

- Spare parts kits for the adjustable wrench 80 and 90 series
- Complete with jaw, roll, pin and spring
- Finish: Phosphated
- Right going

	 731415			 g
8069 R-95	0007660	1	3004N	5
8070 R-95	0007783	1	3006N	10
8071 R-95	0007905	1	3008N	12
8072 R-95	0008025	1	3010N	18
8073 R-95	0008148	1	3012N	26

95

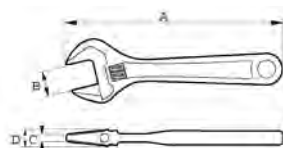

SIDE NUT

- Adjustable wrenches with side nut operating system
- Standards: ISO 6787, DIN 3117, BS 6333, ASME B107.8M – 2003 and UNE 16532
- Heavy duty. 2, 25 times ISO Standard requirements
- Smooth movement and precision adjustment
- High performance alloy steel
- Head angle 15° provides better accessibility
- Comfortable non slip thermoplastic grip handle
- Left reading, measurement scale in mm
- Black finish, precision hardened and anti-corrosion treated

	 731415		A mm	B mm	C mm	D mm	 g
9570	0178575	5	158	20	6.5	12	175
9571	0178582	5	208	27	7.5	14	300
9572	0178599	5	257	35	9.5	16	500
9573	0178605	3	308	39.5	13	18	750



ADJUSTABLE WRENCHES

95C

SIDE NUT



- Adjustable wrenches with side nut operating system
- Standards: ISO 6787, DIN 3117, BS 6333, ASME B107.8M – 2003 and UNE 16532
- Heavy duty. 2, 25 times ISO Standard requirements
- Smooth movement and precision adjustment
- High performance alloy steel
- Head angle 15° provides better accessibility
- Comfortable non slip thermoplastic grip handle
- Left reading, measurement scale in mm
- Chrome plated, precision hardened and anti-corrosion treated

	 731415		A mm	B mm	C mm	D mm	 g
9570C	0191215	1	158	20	6.5	12	175
9571C	0191222	1	208	27	7.5	14	300
9572C	0191239	5	257	35	9.5	16	500
9573C	0191246	3	308	39.5	13	18	750

91C/97C

SIDE NUT

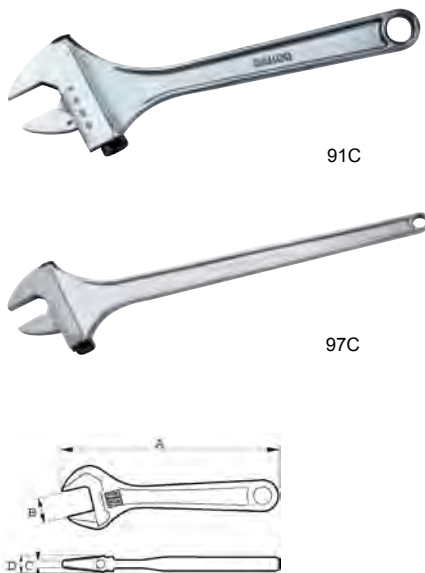

- Side nut adjustable wrenches for heavy duty applications
- Standards: ISO 6787, DIN 3117, BS 6333, ASME B107.8M – 2003 and UNE 16532
- Forged in one piece for better performance
- High performance alloy steel
- Head angle 15° provides better accessibility
- Measurement scale in mm
- Bigger and rounded handles for a comfortable grip
- Chrome plated

	 731415		A mm	B mm	C mm	D mm	 g
91C	0182381	1	155	21	6,5	12	140
92C	0182398	1	205	29	8	14	290
93C	0182404	1	255	34	9	17	510
94C	0182411	1	305	39	10	20	795
95C	0182428	1	405	49	14	26	1620
96C	0134120	1	500	62	17	30	2860
97C	0128211	1	750	77	23	37	5500



111M

COMBINATION WRENCHES

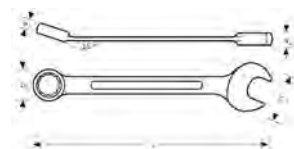

- Combination wrench in metric sizes
- Standards: ISO 691, ISO 7738, ISO 3318, ISO 1711-1 and DIN 3113
- Material: High performance alloy steel
- U shape shank provides better comfort
- Open end angle 15° with a slimmer head for better accessibility
- 12 points Dynamic-Drive Profile provides longer life for screws and nuts
- Ring end angle 15° for knuckle clearance or better grip
- Bigger and bi-directional size marking for easy identification
- Chrome plated micro matt finishing provides high quality surface
- Patented U shape design
- SB = Retail pack on a plastic info card

	 731415		 mm	L mm	a1xa2 mm	b1xb2 mm	 g
111M-5.5	1828608	10	5.5	112	5.0x3.7	10.0x14.3	17
111M-6	1828615	10	6	112	5.0x3.7	10.0x14.3	17
111M-7	1828622	10	7	120	5.3x3.8	11.7x17.1	21
111M-8	1828639	10	8	130	5.8x4.2	12.8x19.0	28
111M-9	1828646	10	9	136	6.1x4.4	14.0x21.0	31
111M-10	1828653	10	10	144	6.5x5.1	15.7x22.9	42
111M-11	1828660	10	11	153	6.9x5.4	17.2x25.2	50
111M-12	1828677	10	12	160	7.1x5.6	18.4x27.0	60
111M-13	1828684	10	13	169	7.6x5.8	19.7x29.2	70
111M-14	1828691	10	14	177	8.2x6.3	21.7x31.0	85
111M-15	1828707	10	15	185	8.4x6.7	22.7x33.5	95
111M-16	1828714	10	16	195	9.0x7.1	24.0x35.5	114
111M-17	1828721	10	17	200	9.6x7.2	25.6x37.5	128
111M-18	1828738	10	18	208	10.0x7.5	26.8x39.1	140
111M-19	1828745	10	19	218	10.9x7.8	28.3x41.3	166
111M-20	1828752	10	20	240	11.4x7.7	29.8x42.0	185
111M-21	1828769	10	21	250	12.2x7.9	32.9x45.0	210
111M-22	1828776	5	22	250	12.2x7.9	32.9x45.0	210
111M-23	1828783	5	23	280	13.2x8.4	36.1x49.0	280
111M-24	1828790	5	24	270	13.2x8.4	36.1x49.0	280
111M-25	1828806	5	25	290	14.2x8.9	40.0x53.0	345
111M-26	1828813	5	26	290	14.2x8.9	40.0x53.0	345
111M-27	1828820	5	27	310	14.7x8.9	42.0x58.0	392
111M-28	1828837	5	28	310	14.7x8.9	42.0x58.0	392
111M-29	1828844	5	29	330	15.2x9.5	46.1x60.0	465
111M-30	1828851	5	30	330	15.2x9.5	46.1x60.0	465
111M-32	1828868	5	32	350	16.2x9.5	49.2x67.0	550
111M-34	1828875	5	34	350	16.2x9.5	49.2x67.0	550
111M-36	0135516	1	36	410	19.4x13.5	53.0x74.0	800
111M-41	0135523	1	41	460	21.6x16.0	61.0x84.0	1160
111M-46	0135530	1	46	500	23.0x17.0	66.0x92.0	1700
111M-50	0135547	1	50	540	24.6x18.0	73.0x102	2000
111M-55	0135554	1	55	560	21.5x28.0	86.0x118	2800
111M-60	0135561	1	60	600	23.5x30.0	94.0x126	3900
111M-65	0135578	1	65	680	25.0x32.0	108x148	5800
111M-70	0135585	1	70	680	25.0x32.0	108x148	5800
111M-75	0135592	1	75	730	25.0x35.0	115x155	6500
111M-80	0135608	1	80	730	25.0x35.0	115x155	6500
SB111M-6	1839826	1	6	112	5.0x3.7	10.0x14.3	27
SB111M-7	1839833	1	7	120	5.3x3.8	11.7x17.1	31
SB111M-8	1839840	1	8	130	5.8x4.2	12.8x19.0	38
SB111M-9	1839857	1	9	136	6.1x4.4	14.0x21.0	41
SB111M-10	1839864	1	10	144	6.5x5.1	15.7x22.9	52
SB111M-11	1839871	1	11	153	6.9x5.4	17.2x25.2	60
SB111M-12	1839888	1	12	160	7.1x5.6	18.4x27.0	70
SB111M-13	1839895	1	13	169	7.6x5.8	19.7x29.2	80
SB111M-14	1839901	1	14	177	8.2x6.3	21.7x31.0	95
SB111M-15	1839918	1	15	185	8.4x6.7	22.7x33.5	105
SB111M-16	1839925	1	16	195	9.0x7.1	24.0x35.5	124
SB111M-17	1839932	1	17	200	9.6x7.2	25.6x37.5	138
SB111M-18	1839949	1	18	208	10.0x7.5	26.8x39.1	150
SB111M-19	1839956	1	19	218	10.9x7.8	28.3x41.3	176
SB111M-20	1839963	1	20	240	11.4x7.7	29.8x42.0	195
SB111M-21	1839970	1	21	250	12.2x7.9	32.9x45.0	220
SB111M-22	1839987	1	22	250	12.2x7.9	32.9x45.0	220
SB111M-23	1839994	1	23	270	13.2x8.4	36.1x49.0	290
SB111M-24	1840006	1	24	270	13.2x8.4	36.1x49.0	290
SB111M-25	1840013	1	25	290	14.2x8.9	40.0x53.0	355
SB111M-26	1840020	1	26	290	14.2x8.9	40.0x53.0	355
SB111M-27	1840037	1	27	310	14.7x8.9	42.0x58.0	402
SB111M-30	1840068	1	30	330	15.2x9.5	46.1x60.0	475



COMBINATION WRENCHES

111M/SH

COMBINATION WRENCHES

- Set of combination wrenches
- Packaging: Plastic holder

	 731415			 g
111M/SH8	0197873	1	8	850
111M/SH12	3013347	1	12	1050
111M/SH8	8, 10, 12, 13, 14, 17, 19, 22 mm			
111M/SH12	8, 9, 10, 11, 12, 13, 14, 15, 16, 17, 18, 19 mm			



111M/T

COMBINATION WRENCHES

- Set of combination wrenches
- Packaging: Sets in black plastic pouch

	 731415			 g
111M/7T	1828882	1	7	575
111M/11T	1828899	1	11	740
111M/14T	1828905	1	14	2270
111M/17T	1828912	1	17	1615
111M/17TL	0197859	1	17	3430
111M/24T	0197866	1	24	5230
111M/26T	1828929	1	26	4355
111M/7T	8, 10, 13, 14, 17, 19, 22 mm			
111M/11T	8, 9, 10, 11, 12, 13, 14, 15, 17, 19, 22 mm			
111M/14T	6, 8, 9, 10, 13, 14, 15, 17, 19, 22, 24, 27, 30, 32 mm			
111M/17T	6, 7, 8, 9, 10, 11, 12, 13, 14, 15, 16, 17, 18, 19, 20, 21, 22 mm			
111M/17TL	8, 9, 10, 11, 12, 13, 14, 15, 16, 18, 19, 22, 24, 26, 27, 30, 32 mm			
111M/24T	6, 7, 8, 9, 10, 11, 12, 13, 14, 15, 16, 17, 18, 19, 20, 21, 22, 24, 26, 27, 28, 30, 32, 36 mm			
111M/26T	6, 7, 8, 9, 10, 11, 12, 13, 14, 15, 16, 17, 18, 19, 20, 21, 22, 23, 24, 25, 26, 27, 28, 29, 30, 32 mm			



111M/

COMBINATION WRENCHES

- Set of combination wrenches
- Packaging: In cardboard box

	 731415			 g
111M/S10	0212965	1	10	960
111M/S10	8, 9, 10, 11, 12, 13, 14, 17, 19, 22, mm			





111Z

COMBINATION WRENCHES

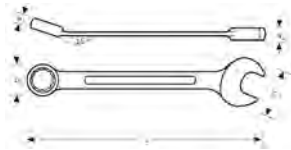

- Combination wrench in inch sizes
- Standards: ISO 691, ISO 7738, ISO 3318, ISO 1711-1 and DIN 3113
- Material: High performance alloy steel
- U shape shank provides better comfort
- Open end angle 15° with a slimmer head to get more accessibility
- 12 points Dynamic-Drive Profile provides longer life for screws and nuts
- Ring end angle 15° for knuckle clearance or better grip
- Bigger and bi-directional size marking for easy identification
- Chrome plated micro matt finishing provides high quality surface
- Patented U shape design

	 731415			L mm	a1xa2 mm	b1xb2 mm	 g
111Z-1/4	1828943	5	1/4	112	5.0x3.7	10.0x14.3	17
111Z-5/16	1828950	5	5/16	130	5.8x4.2	12.8x19.0	28
111Z-3/8	1828967	5	3/8	144	6.5x5.1	15.7x22.9	42
111Z-7/16	1828974	5	7/16	153	6.9x5.4	17.2x25.2	50
111Z-1/2	1828981	5	1/2	169	7.6x5.8	19.7x29.2	70
111Z-9/16	1828998	5	9/16	177	8.2x6.3	21.7x31.0	85
111Z-5/8	1829001	5	5/8	195	9.0x7.1	24.0x35.5	114
111Z-11/16	1829018	5	11/16	200	9.6x7.2	25.6x37.5	128
111Z-3/4	1829025	5	3/4	218	10.9x7.8	28.3x41.3	166
111Z-13/16	1829032	5	13/16	250	12.2x7.9	32.9x45.0	210
111Z-7/8	1829049	5	7/8	250	12.2x7.9	32.9x45.0	210
111Z-15/16	1829056	3	15/16	270	13.2x8.4	36.1x49.0	280
111Z-1	1829063	3	1	290	14.2x8.9	40.0x53.0	345
111Z-1.1/16	1829070	5	1 1/16	310	14.7x8.9	42.0x58.0	392
111Z-1.1/8	1829087	5	1 1/8	310	14.7x8.9	42.0x58.0	392
111Z-1.1/4	1829094	5	1 1/4	350	16.2x9.5	49.2x67.0	550
111Z-1.5/16	1829100	5	1 5/16	350	16.2x9.5	49.2x67.0	550
111Z-1.3/8	0135738	1	1 3/8	410	19.4x13.5	53x74	787
111Z-1.7/16	0135745	1	1 7/16	410	19.4x13.5	53x74	787
111Z-1.1/2	0135752	1	1 1/2	410	19.4x13.5	53.0x74.0	787
111Z-1.5/8	0135769	1	1 5/8	460	21.6x16	61x84	1160
111Z-1.11/16	0135615	1	1 11/16	460	21.6x16	61x84	1160
111Z-1.3/4	0135622	1	1 3/4	500	23x17	66x92	1700
111Z-1.13/16	0135639	1	1 13/16	500	23x17	66x92	1700
111Z-1.7/8	0135646	1	1 7/8	540	24.6x18	73x102	2000
111Z-2	0135653	1	2	540	24.6x18	73x102	2000
111Z-2.1/8	0135677	1	2 1/8	560	21.5x28	86x118	2800
111Z-2.1/4	0135691	1	2 1/4	600	23.5x30	94x126	3900
111Z-2.3/8	0135707	1	2 3/8	600	23.5x30	94x126	3900
111Z-2.1/2	0135721	1	2 1/2	680	25x32	108x148	5800
111Z-2.5/8	0135776	1	2 5/8	680	25x32	108x148	5800
111Z-2.3/4	0135783	1	2 3/4	680	25x32	108x148	5800
111Z-2.7/8	0135790	1	2 7/8	730	25x35	115x155	6500
111Z-3	0135806	1	3	730	25x35	115x155	6500



COMBINATION WRENCHES

111Z/

COMBINATION WRENCHES



- Set of combination wrenches
- Packaging: Sets in black plastic pouch

	 731415			 g
111Z/8T	1829117	1	8	660
111Z/11T	1829124	1	11	1660
111Z/8T	3/8, 7/16, 1/2, 9/16, 5/8, 11/16, 3/4, 7/8			
111Z/11T	3/8, 7/16, 1/2, 9/16, 5/8, 11/16, 3/4, 13/16, 7/8, 15/16, 1			

S20

COMBINATION WRENCHES



- Combination wrench in metric sizes
- Standards: DIN 3113/ISO 3318/ISO 7738
- Finish: Matt
- Material: Vanadium extra
- Open-end angle 15°, Ring end 15° offset, equal openings at both ends, short type
- Dynamic-Drive Profile
- Retail packed on a plastic info card

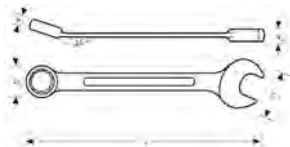

	 731415			L mm	a1xa2 mm	b1xb2 mm	 g
SBS20-6	3009104	1	6	105	5.0x3.9	10.0x14.5	13
SBS20-7	3009111	1	7	110	5.6x4.1	11.0x17.0	18
SBS20-8	3009128	1	8	110	5.6x4.2	12.5x18.0	18
SBS20-9	3009135	1	9	120	6.0x4.5	14.0x21.0	22
SBS20-10	3009142	1	10	135	6.6x5.0	15.5x22.5	30
SBS20-11	3009159	1	11	135	6.6x5.0	17.0x23.5	30
SBS20-12	3009166	1	12	150	7.5x5.5	18.5x26.5	45
SBS20-13	3009173	1	13	160	7.5x5.7	20.0x28.5	45
SBS20-14	3009180	1	14	168	8.2x6.4	21.5x31.5	65
SBS20-15	3009197	1	15	170	8.2x6.4	22.5x33.0	65
SBS20-16	3009203	1	16	178	8.8x6.7	24.0x34.5	80
SBS20-17	3009210	1	17	190	9.5x7.1	25.5x37.5	110
SBS20-18	3009227	1	18	210	10.0x7.5	27.0x39.0	115
SBS20-19	3009234	1	19	220	10.0x7.5	28.0x41.0	120
SBS20-20	3009241	1	20	232	11.0x8.1	29.5x43.0	150
SBS20-21	3009258	1	21	250	11.0x8.1	31.5x44.5	150
SBS20-22	3009265	1	22	255	12.0x8.9	34.8x49.0	200
SBS20-24	3009272	1	24	280	13.0x9.2	36.0x50.5	265
SBS20-27	3009289	1	27	310	14.0x9.8	40.0x57.0	350
SBS20-30	3009296	1	30	355	15.0x10.8	43.5x62.5	480
SBS20-32	3009302	1	32	360	15.0x10.8	48.5x65.5	500



S20/



COMBINATION WRENCHES

- Set of combination wrench in metric sizes
- Packaging: Plastic holder

	 731415			 g
S20/SH6	3013316	1	6	338
S20/SH12	3013378	1	12	1050
S20/SH6	8, 10, 12, 13, 14, 17 mm			
S20/SH12	8, 9, 10, 11, 12, 13, 14, 15, 16, 17, 18, 19 mm			

BS20/



COMBINATION WRENCHES

- Set of combination wrench in metric sizes
- Packaging: Cardboard box

	 731415			 g
BS20/S10	3009319	1	10	1205
BS20/S10	8, 10, 11, 13, 14, 16, 17, 18, 19, 22 mm			

11M

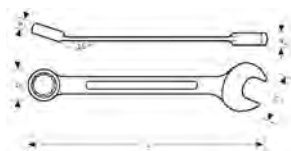

COMBINATION WRENCHES, LONG TYPE

- Combination wrench, long type in metric sizes
- Standards: ISO 691, ISO 7738, ISO 3318, ISO 1711-1 and DIN 3113
- Material: High performance alloy steel
- Open end angle 15° with a slimmer head to get more accessibility
- Ring end angle 15° for knuckle clearance or better grip
- 12 points Dynamic-Drive Profile provides longer life for screws and nuts
- Chrome plated micro matt finishing provides high quality surface
- For sizes 41 mm to 60 mm please see 1952M

	 731415		 mm	L mm	a1xa2 mm	b1xb2 mm	 g
11M-8	1829131	5	8	180	7.5x4.0	13.0x22.0	45
11M-9	1829148	5	9	180	7.5x4.0	14.5x22.0	45
11M-10	1829155	5	10	200	8.5x5.0	16.0x26.0	65
11M-11	1829162	5	11	200	8.5x5.0	17.5x26.0	65
11M-12	1829179	5	12	225	9.8x6.0	19.0x29.0	100
11M-13	1829186	5	13	225	9.8x6.0	20.0x29.0	100
11M-14	1829193	5	14	250	11.4x7.0	22.0x33.0	150
11M-15	1829209	5	15	250	11.4x7.0	23.0x33.0	150
11M-16	1829216	5	16	280	12.8x8.0	24.5x36.0	210
11M-17	1829223	5	17	280	12.8x8.2	26.0x39.0	210
11M-18	1829230	5	18	280	13.0x8.2	27.0x40.0	210
11M-19	1829247	5	19	310	14.5x8.2	29.0x43.0	290
11M-21	1829254	5	21	310	14.5x9.5	31.0x44.5	290
11M-22	1829261	5	22	350	16.4x10.8	33.0x49.0	410
11M-24	1829278	5	24	400	18.4x11.8	36.0x53.0	560
11M-27	1829285	1	27	450	20.5x13.0	40.0x59.0	750
11M-30	1829292	1	30	500	22.5x14.0	44.5x67.0	1000
11M-32	1829308	1	32	500	22.5x14.0	47.0x67.0	1000
11M-36	1829315	1	36	550	24.5x15.0	52.0x77.0	1380
11M-38	1829322	1	38	550	24.5x15.0	55.0x79.0	1380



COMBINATION WRENCHES

11M/

COMBINATION WRENCHES, LONG TYPE



- Set of combination wrenches, long type in metric sizes
- Packaging: In cardboard box

	 731415			 g
11M/S8	1829384	1	8	1050
11M/S8	8, 9, 10, 11, 13, 14, 17, 19 mm			

4020L-M

LILIPUT COMBINATION WRENCH

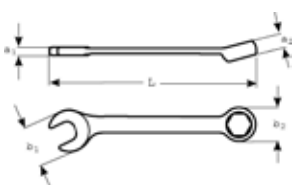

- Liliput combination wrenches in metric sizes
- Material: High performance alloy steel
- Open end angle 22.5° with a slimmer head to get more accessibility
- Ring end with hex profile and 15° offset angle
- Two openings, one wrench, one size
- Applications for radio, telecommunications, electrical and precision engineering, carburetors, etc
- Chrome plated micro matt finishing provides high quality surface

	 731415		 mm	L mm	a1xa2 mm	b1xb2 mm	 g
4020L-M-3	1077693	5	3	70	2.3x2.5	9.0x7.5	6
4020L-M-3.2	1405038	5	3.2	70	2.3x2.5	9.0x7.5	6
4020L-M-3.5	1077709	5	3.5	70	2.3x2.5	9.0x7.5	6
4020L-M-4.5	1077723	5	4.5	80	2.5x4.0	11.5x9.0	9
4020L-M-5	1077730	5	5	80	2.5x4.0	11.5x9.0	9
4020L-M-5.5	1077747	5	5.5	80	2.5x4.0	11.5x9.0	9



1952M

1952 OFFSET COMBINATION WRENCHES

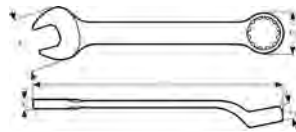

- Combination wrench, offset in metric sizes
- Standards: ISO 691, ISO 7738, ISO 3318, ISO 1711-1 and DIN 3113
- Material: High performance alloy steel
- Open end angle 15° with a slimmer head to get more accessibility
- 12 points Dynamic-Drive Profile provides longer life for screws and nuts
- Ring end angle 15° for knuckle clearance or better grip
- Chrome plated micro matt finishing provides high quality surface
- SB = Retail pack on a plastic info card

	 731415		 mm	L mm	a1xa2 mm	b1xb2 mm	 g
1952M-6	1057176	10	6	95	3.7x4.5	14.0x9.5	15
1952M-7	1057183	10	7	105	3.8x5.0	16.0x11.0	19
1952M-8	1057190	10	8	115	4.2x5.5	18.0x12.2	23
1952M-9	1057206	10	9	125	4.5x6.0	20.0x13.2	30
1952M-10	1057213	10	10	135	4.8x6.5	22.0x14.6	40
1952M-11	1057220	10	11	145	5.0x7.0	24.0x16.2	49
1952M-12	1057237	10	12	155	5.2x7.5	26.5x17.5	61
1952M-13	1057244	10	13	170	5.6x8.0	28.5x19.0	68
1952M-14	1057251	10	14	185	6.0x8.5	31.0x20.0	80
1952M-15	1057268	10	15	185	6.2x9.0	33.0x21.5	100
1952M-16	1057275	10	16	205	6.5x9.8	35.0x23.0	110
1952M-17	1057282	10	17	220	7.0x10.6	37.0x24.5	135
1952M-18	1057299	10	18	230	7.2x11.4	39.0x26.0	155
1952M-19	1057305	10	19	245	7.5x12.2	41.5x27.0	195
1952M-20	1057312	10	20	265	8.0x13.0	43.5x28.5	217
1952M-21	1057329	10	21	265	8.0x13.0	43.5x30.0	240
1952M-22	1057336	5	22	265	8.5x13.5	48.0x32.0	297
1952M-23	1057343	5	23	300	8.5x13.5	48.0x33.0	290
1952M-24	1057350	5	24	300	9.0x14.5	52.0x34.5	375
1952M-25	1057367	5	25	330	9.5x15.5	54.5x36.0	400
1952M-26	1057374	5	26	330	9.5x15.5	54.5x36.5	400
1952M-27	1057381	5	27	330	10.0x16.5	59.0x38.5	590
1952M-28	1057398	1	28	370	10.0x17.0	61.0x40.0	700
1952M-29	1325763	1	29	370	10.0x17.0	61.0x40.0	690
1952M-30	1057404	1	30	370	10.7x18.0	64.0x42.5	727
1952M-32	1057411	1	32	390	11.5x19.0	68.0x45.5	745
1952M-34	1838553	1	34	415	12.0x20.0	72.0x48.0	800
1952M-36	1057428	1	36	435	13.5x21.0	78.0x52.0	1230
1952M-41	1057435	1	41	495	14.4x24.4	86.7x61.5	1350
1952M-46	1840105	1	46	520	15.4x25.4	93.6x67.0	1750
1952M-50	1840112	1	50	560	16.3x26.2	104.4x74.9	2200
1952M-55	1840129	1	55	570	19.1x28.6	113.3x82.7	3200
1952M-60	1840136	1	60	660	20.0x31.0	123.0x90.0	3600
1952M-65	0135226	1	65	710	22x33	133x98	4500
1952M-70	0135301	1	70	760	24x35	143x105	5600
1952M-75	0135325	1	75	810	26x38	153x110	6780
1952M-80	0135509	1	80	860	28x41	163x119	8780
SB1952M-7	0105441	1	7	105	3.8x5.0	16.0x11.0	19
SB1952M-8	0105458	1	8	115	4.2x5.5	18.0x12.2	23
SB1952M-10	0105205	1	10	135	4.8x6.5	22.0x14.6	40
SB1952M-12	0105229	1	12	155	5.2x7.5	26.5x17.5	61
SB1952M-13	0105236	1	13	170	5.6x8.0	28.5x19.0	68
SB1952M-14	0105243	1	14	185	6.0x8.5	31.0x20.0	80
SB1952M-17	0105274	1	17	220	7.0x10.6	37.0x24.5	135
SB1952M-19	0105298	1	19	245	7.5x12.2	41.5x27.0	195
SB1952M-24	0105342	1	24	300	9.0x14.5	52.0x34.5	375



COMBINATION WRENCHES

1952M/

1952 OFFSET COMBINATION WRENCHES



- Set of combination wrenches
- Packaging: In cardboard box

	 731415			 g
1952M/S10	0214471	1	10	770
1952M/S10 8, 9, 10, 11, 12, 13, 14, 15, 17, 19 mm				

1952M/T

1952 OFFSET COMBINATION WRENCHES



- Set of combination wrenches
- Packaging: Sets in black plastic pouch

	 731415			 g
1952M/7T	1806637	1	7	820
1952M/14T	1057695	1	14	3500
1952M/17T	1057473	1	17	1900
1952M/26T	1057701	1	26	7000
1952M/7T 8, 10, 13, 14, 17, 19, 22 mm				
1952M/14T 6, 8, 9, 10, 13, 14, 15, 17, 19, 22, 24, 27, 30, 32 mm				
1952M/17T 6, 7, 8, 9, 10, 11, 12, 13, 14, 15, 16, 17, 18, 19, 20, 21, 22 mm				
1952M/26T 6, 7, 8, 9, 10, 11, 12, 13, 14, 15, 16, 17, 18, 19, 20, 21, 22, 23, 24, 25, 26, 27, 28, 29, 30, 32 mm				

1952M/SH

1952 OFFSET COMBINATION WRENCHES



- Set of combination wrenches
- Packaging: Plastic holder

	 731415			 g
1952M/SH8	0214488	1	8	1080
1952M/SH12	3013330	1	12	1050
1952M/SH8 8, 10, 12, 13, 14, 17, 19, 22 mm				
1952M/SH12 8, 9, 10, 11, 12, 13, 14, 15, 16, 17, 18, 19 mm				



1952Z

1952 OFFSET COMBINATION WRENCHES

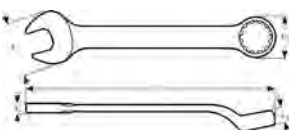

- Combination wrench, offset in inch sizes
- Standards: ISO 691, ISO 7738, ISO 3318, ISO 1711-1 and DIN 3113
- Material: High performance alloy steel
- Open end angle 15° with a slimmer head to get more accessibility
- 12 points Dynamic-Drive Profile provides longer life for screws and nuts
- Ring end angle 15° for knuckle clearance or better grip
- Chrome plated micro matt finishing provides high quality surface

	 731415			L mm	a2xa1 mm	b2xb1 mm	 g
1952Z-1/4	1057480	5	1/4	95	3.7x4.5	14.0x9.5	15
1952Z-5/16	1057497	5	5/16	115	4.2x5.5	18.0x12.2	23
1952Z-11/32	0111046	5	11/32	125	4.5x6.0	20.0x13.2	30
1952Z-3/8	1057503	5	3/8	125	4.5x6.0	20.0x13.2	30
1952Z-7/16	1057510	5	7/16	145	5.0x7.0	24.0x16.2	49
1952Z-1/2	1057527	5	1/2	170	5.6x8.0	28.5x19.0	68
1952Z-9/16	1057534	5	9/16	185	6.0x8.5	31.0x20.0	80
1952Z-5/8	1057541	5	5/8	205	6.5x9.8	35.0x23.0	110
1952Z-11/16	1057558	5	11/16	220	7.0x10.6	37.0x24.5	135
1952Z-3/4	1057565	5	3/4	245	7.5x12.2	41.5x27.0	195
1952Z-13/16	1057572	5	13/16	265	8.0x13.0	43.5x28.5	217
1952Z-7/8	1057589	5	7/8	265	8.5x13.5	48.0x32.0	305
1952Z-15/16	1057596	5	15/16	300	9.0x14.5	52.0x34.5	375
1952Z-1	1057602	1	1	330	9.5x15.5	54.5x36.0	400
1952Z-1.1/16	1057619	1	1 1/16	330	10.0x16.5	59.0x38.5	590
1952Z-1.1/8	1057626	1	1 1/8	370	10.0x17.0	61.0x40.0	700
1952Z-1.1/4	1057633	1	1 1/4	390	11.5x19.0	68.0x45.5	745
1952Z-1.5/16	1057718	1	1 5/16	415	12.0x20.0	72.0x48.0	800
1952Z-1.3/8	1057732	1	1 3/8	415	12.0x20.0	72.0x48.0	800
1952Z-1.7/16	1057749	1	1 7/16	435	13.5x21.0	78.0x52.0	990
1952Z-1.1/2	1057756	1	1 1/2	435	13.5x21.0	78.0x52.0	990
1952Z-1.5/8	1057763	1	1 5/8	495	14.4x24.4	86.7x61.5	1350

1952Z/T

1952 OFFSET COMBINATION WRENCHES



- Set of combination wrenches
- Packaging: Sets in black plastic pouch

	 731415			 g
1952Z/11T	1057725	1	11	1500

1952Z/11T 1/4, 5/16, 3/8, 7/16, 1/2, 9/16, 5/8, 11/16, 3/4, 13/16, 7/8





RATCHETING WRENCHES

1RM

COMBINATION RATCHETING WRENCHES

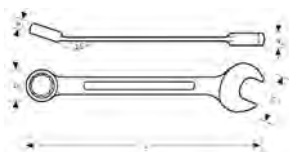

- Ratchet combination gear wrench in metric sizes
- Standards: ISO 1711-1 and DIN 3113
- Material: High performance alloy steel
- Open end angle 15° with a slimmer head to get more accessibility
- Ratchet in the ring for high productivity application
- 12 points Dynamic-Drive Profile provides longer life for screws and nuts
- 5° action angle
- Switch for quick change of right and left direction
- Bigger and bi-directional size marking for easy identification
- Chrome plated micro matt finishing provides high quality surface

	 731415		 mm	L mm	a1xa2 mm	b1xb2 mm	 g
1RM-6	3014146	1	6	128	6.3x3.9	14.0x15.0	27
1RM-7	3014153	1	7	140	6.5x4.6	16.6x16.7	35
1RM-8	3000552	1	8	140	6.5x4.6	16.6x16.7	38
1RM-9	3000569	1	9	150	6.9x4.9	18.4x18.8	48
1RM-10	3000576	1	10	159	7.3x5.3	20.0x20.8	159
1RM-11	3000583	1	11	165	7.7x5.6	21.8x23.0	67
1RM-12	3000590	1	12	172	8.2x6.0	22.7x25.0	82
1RM-13	3000606	1	13	178	8.8x6.4	24.7x27.1	95
1RM-14	3000613	1	14	191	9.0x6.8	27.0x29.2	113
1RM-15	3000620	1	15	200	9.4x7.0	28.3x31.3	130
1RM-16	3000637	1	16	208	9.9x7.2	30.0x33.4	158
1RM-17	3000644	1	17	226	10.3x7.7	31.8x35.5	180
1RM-18	3000651	1	18	237	10.7x8.2	32.8x37.6	213
1RM-19	3000668	1	19	248	11.2x8.8	33.8x39.7	233
1RM-21	0214495	1	21	290	13.0x9.0	40.0x46.0	343
1RM-22	3005915	1	22	290	13.0x9.0	40.0x46.0	343
1RM-24	3005922	1	24	323	14.5x10.0	46.0x52.0	503
1RM-27	3014177	1	27	359	15.5x10.5	52.5x56.5	550
1RM-30	3014184	1	30	493	17.0x11.4	58.5x62.7	750
1RM-32	3014191	1	32	425	17.5x12.5	62.5x66.4	900

1RM/

COMBINATION RATCHETING WRENCHES



- Set of ratchet combination wrenches
- Packaging: Plastic holder

	 731415			 g
1RM/S6	3000675	1	6	625
1RM/S12	3000682	10	12	1520
1RM/S6	8, 10, 12, 13, 14, 17 mm			
1RM/S12	8, 9, 10, 11, 12, 13, 14, 15, 16, 17, 18, 19 mm			



1RZ

COMBINATION RATCHETING WRENCHES

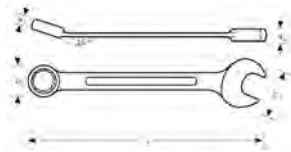

- Ratchet combination gear wrench in inch sizes
- Standards: ISO 1711-1 and DIN 3113
- Material: High performance alloy steel
- Open end angle 15° with a slimmer head to get more accessibility
- Ratchet in the ring for high productivity application
- 5° action angle
- 12 points Dynamic-Drive Profile provides longer life for screws and nuts
- Switch for quick change of right and left direction
- Bigger and bi-directional size marking for easy identification
- Chrome plated micro matt finishing provides high quality surface

	 731415			L mm	a1xa2 mm	b1xb2 mm	 g
1RZ-1/4	0153725	1	1/4	128	6.3x3.9	14.0x15.0	27
1RZ-5/16	3014207	1	5/16	140	6.5x4.3	17.0x16.7	38
1RZ-3/8	3014214	1	3/8	158	7.3x5.0	20.2x20.8	57
1RZ-7/16	3014221	1	7/16	165	7.7x5.3	22.0x23.0	67
1RZ-1/2	3014245	1	1/2	178	8.6x6.1	25.5x26.8	95
1RZ-9/16	3014238	1	9/16	190	9.0x6.5	26.9x29.0	113
1RZ-5/8	3014252	1	5/8	208	9.9x7.1	29.8x33.0	158
1RZ-11/16	3014269	1	11/16	225	10.3x7.5	31.8x36.5	180
1RZ-3/4	3014276	1	3/4	247	11.2x8.6	34.0x39.4	233

1RZ/

COMBINATION RATCHETING WRENCHES



- Set of ratchet combination wrenches
- Packaging: Plastic holder

	 731415			 g
1RZ/S8	3014283	1	8	1000
1RZ/S8 5/16, 3/8, 7/16, 1/2, 9/16, 5/8, 11/16, 3/4				



RATCHETING WRENCHES

10RM

COMBINATION RATCHETING WRENCHES, STUBBY



DYNAMIC-DRIVE™

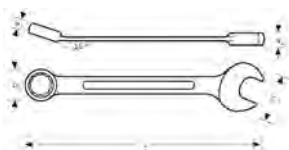

- Stubby version of ratchet combination wrench in metric sizes
- Standards: ISO 3318 and DIN 3113
- Material: High performance alloy steel
- Open end angle 15° with a slimmer head to get more accessibility
- Ratchet in the ring for high productivity application
- 5° action angle
- 12 points Dynamic-Drive Profile provides longer life for screws and nuts
- Switch for quick change of right and left direction
- Chrome plated micro matt finishing provides high quality surface

	 731415		 mm	L mm	a1xa2 mm	b1xb2 mm	 g
10RM-8	3014344	1	8	90	6.5x4.0	16.6x16.7	25
10RM-10	3014351	1	10	95	7.3x4.8	20.0x20.8	35
10RM-13	3014368	1	13	108	8.6x5.8	24.7x27.1	63
10RM-17	3014375	1	17	127	10.3x7.2	31.8x35.5	113
10RM-19	3014382	1	19	139	11.2x8.2	33.8x39.7	143

10RM/

COMBINATION RATCHETING WRENCHES, STUBBY



- Set of stubby version of ratchet combination wrenches
- Packaging: Plastic holder

	 731415			 g
10RM/S5	3014399	1	5	490
10RM/S5	8, 10, 13, 17, 19 mm			



41RM

RATCHET FLEX COMBINATION WRENCHES

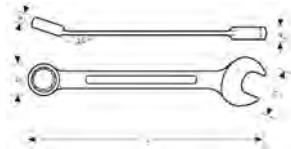

- Ratchet combination wrenches with swivel head in metric sizes
- Standards: ISO 3318 and DIN 3113
- Material: High performance alloy steel
- Open end angle 15° with a slimmer head to get more accessibility
- Ratchet swivel head in 180° with fixed steps in every 15°
- 5° ratchet action angle
- 12 points Dynamic-Drive Profile provides longer life for screws and nuts
- Chrome plated micro matt finishing provides high quality surface

	 731415		 mm	L mm	a1xa2 mm	b1xb2 mm	 g
41RM-8	3014412	1	8	127	6.5x4.3	17.0x17.0	35
41RM-10	3014429	1	10	136	7.3x5.0	20.0x21.0	55
41RM-11	3014436	1	11	141	7.7x5.4	22.0x23.0	63
41RM-12	3014443	1	12	148	8.2x5.8	23.0x25.0	83
41RM-13	3014450	1	13	154	8.6x6.1	25.0x27.0	93
41RM-14	3014467	1	14	160	9.0x6.4	27.0x29.0	113
41RM-17	3014474	1	17	190	10.3x7.6	32.0x36.0	173
41RM-19	3014481	1	19	215	11.2x8.6	34.0x40.0	233

41RM/S8

RATCHET FLEX COMBINATION WRENCHES



- Set of ratchet combination wrenches with swivel head
- Packaging: Plastic holder

	 731415			 g
41RM/S8	3014405	10	8	960

41RM/S8 8, 10, 11, 12, 13, 14, 17, 19 mm





RATCHETING WRENCHES

1320RM



RATCHETING RING WRENCHES

- Ratcheting ring wrenches in metric sizes
- Material: High performance alloy steel
- 5° ratchet action angle
- 12 points Dynamic-Drive Profile provides longer life for screws and nuts
- Bigger and bi-directional size marking for easy identification
- Chrome plated micro matt finishing provides high quality surface

	 731415		 mm	L mm	a1xa2 mm	b1xb2 mm	 g
1320RM-6-7	3014498	1	6-7	115	6.3x6.5	14.2x17.2	35
1320RM-8-9	3014504	1	8-9	128	6.5x6.9	16.8x20.2	45
1320RM-10-11	3014511	1	10-11	150	7.3x7.7	20.2x21.8	60
1320RM-12-13	3014528	1	12-13	170	8.2x8.6	23.0x24.8	80
1320RM-14-15	3014535	1	14-15	190	9.0x9.4	26.5x29.5	120
1320RM-16-17	3014542	1	16-17	200	9.9x10.3	29.5x31.5	160
1320RM-18-19	3014559	1	18-19	230	10.3x11.2	31.5x33.5	200

1320RM/



RATCHETING RING WRENCHES

- Set for ratcheting ring wrenches in metric sizes
- Packaging: Plastic holder

	 731415			 g
1320RM/S7	3014597	10	7	880
1320RM/S7 6x7, 8x9, 10x11, 12x13, 14x15, 16x17, 18x19 mm				

1320RZ



RATCHETING RING WRENCHES

- Ratcheting ring wrenches in inch sizes
- Material: High performance alloy steel
- 5° action angle
- 12 points Dynamic-Drive Profile provides longer life for screws and nuts
- Bigger and bi-directional size marking for easy identification
- Chrome plated micro matt finishing provides high quality surface

	 731415		 "	L mm	a1xa2 mm	b1xb2 mm	 g
1320RZ-1/4-5/16	3014566	1	1/4-5/16	115	6.3x6.5	14.2x17.2	35
1320RZ-3/8-7/16	3014573	1	3/8-7/16	128	6.5x6.9	16.8x20.2	45
1320RZ-1/2-9/16	3014580	1	1/2-9/16	170	8.2x8.8	23.0x24.8	80



1320SRM

RATCHETING RING WRENCHES

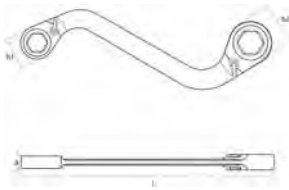

- S type ratcheting ring wrench in metric sizes
- Material: High performance alloy steel
- S shape allows better access to restricted working areas
- Switch for quick change of right and left direction, 5 ° action angle
- 6 points Dynamic-Drive Profile provides longer life for screws and nuts
- Ring spring works allows fastening screws with just one hand
- Flat adaptors can be attached to fasten multiple screw types and sizes
- Bigger and bi-directional size marking for easy identification
- Chrome plated micro matt finishing provides high quality surface

	 731415		 mm	L mm	a1xa2 mm	b1xb2 mm	 g
1320SRM-14-19	0190355	1	14-19	200	9.0x11.2	26.8x33.8	180

1320SRM/

RATCHETING RING WRENCHES



- S type ratcheting ring wrench and adaptors set, 29 pcs
- Supplied with a compact blow mould box with T3 modular 2 colour foam inlay
- Ratcheting box wrench 1320SRM-14-19 with 5° ratchet action and reverse lever
- Adaptor for 1/4" and 1/2" sockets with quick release press button
- Adaptors for hex screws to cover 8-19 mm and 5/16"-3/4" inch sizes
- Adaptors for TORX® screws to cover sizes from E8 to E22
- Pass-thru socket for 22 mm size
- Case: High Density Polythene (HDPE)
- Wrench and adaptors are available for replacement

	 731415			 g
1320SRM/S29	0188673	1	29	1190

1320SRM-14-19		1RMA-14-__-HEX 8, 9, 10, 11, 12, 5/16, 3/8, 7/16	
1RMA-19-__-HEX 13, 15, 16, 17, 1/2, 9/16, 5/8, 11/16		1RMA-14-__-TX E8, E10, E11, E12, E14	
1RMA-19-__-TX E16, E18, E20, E22		1RMA-19-1/4-SQ	
1RMA-19-1/2-SQ2		SBS19-TH22	



RATCHETING WRENCHES

1RMA/S4



ACCESSORIES

- Ratcheting wrench adaptors set, 4 pcs
- High performance alloy steel
- High polished finish
- Adaptors for 1/4", 3/8" and 1/2" sockets with quick release press button
- Adaptor for 1/4" bits with retaining ring
- Supplied with a compact plastic pocket box
- ISO 1174, DIN 3120
- Adaptors are available for replacement

	 731415		 mm	 g
1RMA/S4	3014658	1	35x100x84	45
1RMA-10-1/4-SQ			1RMA-13-3/8-SQ	
1RMA-19-1/2-SQ			1RMA-10-1/4-BIT	

1RMA/S8



ACCESSORIES

- Combination wrenches and adaptors set, 8 pcs
- High performance alloy steel
- High polished finish
- Supplied with a compact plastic pocket box
- Ratcheting wrenches 1RM-10, -13, -19 with 5° ratchet action, reverse lever and 15° offset
- Adaptor for 1/4", 3/8" and 1/2" sockets with quick release press button
- Adaptors for 1/4" and 5/16" bits with retaining ring
- Case: High Density Polythene (HDPE)
- ISO 3318 / 1174, DIN 3113 / 3120
- Wrenches and adaptors are available for replacements

	 731415		 mm	 g
1RMA/S8	3014665	1	75x283x160	95
1RMA-10-1/4-SQ			1RMA-13-3/8-SQ	
1RMA-19-1/2-SQ			1RMA-10-1/4-BIT	
1RMA-13-5/16-BIT			1RM 10, 13, 19 mm	



S4RM

FOUR SIZES RATCHETING WRENCHES



- Ratcheting box wrench in metric sizes
- Material: High performance alloy steel
- 4 sizes per wrench: 1 single wrench is useful for 4 screw sizes
- Switch for quick change of right and left direction, 5 ° action angle
- 12 points Dynamic-Drive Profile provides longer life for screws and nuts
- Chrome plated matt finishing provides high quality anti-rust protection

	 731415		 mm	L mm	a1xa2 mm	b1xb2 mm	 g
S4RM-4-7	0179930	60	4-5-6-7	115	12.3x12.8	14.2x17.2	50
S4RM-8-11	0179947	60	8-9-10-11	151	13.9x14.7	20.4x22.2	70
S4RM-12-15	0179954	30	12-13-14-15	191	17.3x18.1	27.3x30.3	150
S4RM-16-19	0179961	30	16-17-18-19	230	20.3x22.2	31.7x34.2	240
S4RM-21-27	0179978	20	21-22-24-27	275	26.0x30.0	40.0x52.5	640
S4RM-30-36	0179985	10	30-32-34-36	360	34.5x35.5	62.5x66.5	1.410

S4RM/

FOUR SIZES RATCHETING WRENCHES



- Sets for 4 in 1 ratcheting box wrenches in metric sizes
- Sets in practical pouch to carry on your belt

	 731415			 g
S4RM/3T	0117406	1	3	550
S4RM/4T	0179916	1	4	2200
S4RM/5T	0179923	1	5	4200
S4RM/3T	8x9x10x11, 12x13x14x15, 16x17x18x19			
S4RM/4T	8x9x10x11, 12x13x14x15, 16x17x18x19, 21x22x24x27			
S4RM/5T	8x9x10x11, 12x13x14x15, 16x17x18x19, 21x22x24x27, 30x32x34x36			



OPEN END WRENCHES

6M

DOUBLE OPEN-END WRENCHES



- Double open end wrench in metric sizes
- Standards: ISO 691, ISO 1085, ISO 10102 and ISO 3318
- Material: High performance alloy steel
- U shape shank provides better comfort
- Open end angle 15° with a slimmer head for more accessibility
- Large and one-directional size marking for easy identification
- Chrome plated micro matt finishing provides high quality surface
- Patented U shape design
- SB = Retail pack on a plastic info card

	 731415		 mm	L mm	a mm	b1 mm	b2 mm	 g
6M-4-5	1832018	10	4x5	105	3.2	13.0	15.0	15
6M-4.5-5.5	1832025	10	4.5x5.5	105	3.2	13.0	15.0	15
6M-5-5.5	1832032	10	5x5.5	105	3.2	13.0	15.0	15
6M-5.5-7	1832049	10	5.5x7	122	3.9	15.5	17.9	22
6M-6-7	1832056	10	6x7	122	3.9	15.5	17.9	22
6M-7-8	1832063	10	7x8	122	3.9	15.5	17.9	22
6M-8-9	1832070	10	8x9	138	4.0	18.7	21.2	28
6M-8-10	1832087	10	8x10	138	4.0	18.7	21.2	28
6M-10-11	1832094	10	10x11	153	5.2	23.0	24.9	45
6M-10-13	1832117	10	10x13	153	5.2	23.0	24.9	45
6M-12-13	1832131	10	12x13	168	5.8	28.7	30.5	73
6M-12-14	1832148	10	12x14	168	5.8	28.7	30.5	73
6M-13-14	1832155	10	13x14	168	5.8	28.7	30.5	73
6M-13-15	1832162	10	13x15	183	6.3	30.1	32.1	98
6M-13-16	1832179	10	13x16	183	6.3	30.1	32.1	98
6M-13-17	1832186	10	13x17	183	6.3	30.1	32.1	98
6M-14-15	1832193	10	14x15	183	6.3	30.1	32.1	98
6M-14-17	1832209	10	14x17	183	6.3	30.1	32.1	98
6M-16-17	1832216	10	16x17	201	7.0	34.7	35.6	122
6M-16-18	1832223	10	16x18	201	7.0	34.7	35.6	122
6M-17-19	1832230	10	17x19	222	7.3	37.4	40.5	170
6M-18-19	1832247	10	18x19	222	7.3	38.1	41.2	170
6M-19-22	1832261	10	19x22	225	7.3	42.0	46.0	188
6M-19-24	1832278	10	19x24	225	7.3	42.0	46.0	188
6M-20-22	1832285	10	20x22	225	7.2	42.0	43.0	188
6M-21-23	1832292	10	21x23	240	7.4	45.0	49.0	211
6M-21-24	1838072	10	21x24	240	7.4	45.0	49.0	211
6M-22-24	1832308	10	22x24	240	7.4	45.0	49.0	211
6M-24-26	1832315	10	24x26	260	7.8	49.0	53.0	293
6M-24-27	1832322	10	24x27	260	7.8	49.0	53.0	293
6M-24-30	1832339	5	24x30	280	8.4	53.0	58.0	366
6M-25-28	1832353	5	25x28	280	8.4	53.0	58.0	366
6M-27-30	1832360	5	27x30	280	8.4	53.0	58.0	366
6M-27-32	1832377	5	27x32	300	9.0	60.0	67.0	481
6M-30-32	1832384	5	30x32	300	9.0	60.0	67.0	481
6M-30-36	1832407	5	30x36	355	11.0	66.0	74.0	714
6M-32-36	1832414	5	32x36	355	11.0	66.0	74.0	714
6M-34-36	1832421	1	34x36	355	11.0	66.0	74.0	714
6M-36-41	1832438	1	36x41	385	11.5	74.0	83.0	880
6M-38-42	1832445	1	38x42	385	11.5	74.0	83.0	880
6M-41-46	1832452	1	41x46	400	13.3	85.0	94.0	1120
6M-46-50	1832469	1	46x50	446	14.2	94.0	100.5	1610
SB6M-4-5	0106042	1	4x5	105	3.2	13.0	15.0	15
SB6M-6-7	0106073	1	6x7	122	3.9	15.5	17.9	22
SB6M-8-9	0106103	1	8x9	138	5.2	18.7	21.2	28
SB6M-10-11	0105731	1	10x11	153	5.2	23.0	24.9	45
SB6M-12-13	0105762	1	12x13	168	5.8	28.7	30.5	73
SB6M-14-15	0105823	1	14x15	183	6.6	30.1	32.1	88
SB6M-16-17	0105847	1	16x17	201	7.0	34.7	35.6	122
SB6M-18-19	0105878	1	18x19	222	7.3	38.1	41.2	170
SB6M-20-22	0105915	1	20x22	225	7.3	42.0	46.0	188
SB6M-21-23	0105922	1	21x23	240	7.4	45.0	49.0	211
SB6M-22-24	0105946	1	22x24	240	7.4	45.0	49.0	211
SB6M-24-26	0105953	1	24x26	260	7.8	49.0	53.0	293
SB6M-24-27	0105960	1	24x27	260	7.8	49.0	53.0	293
SB6M-30-32	0106011	1	30x32	300	9.0	60.0	67.0	481



6M/SH



DOUBLE OPEN-END WRENCHES

- Set of double open end wrench in metric sizes
- Packaging: Plastic holder

	 731415			 g
6M/SH8	0201365	1	8	910
6M/SH12	3013439	1	12	1704
6M/SH8	6x7, 8x9, 10x11, 12x13, 14x15, 16x17, 18x19, 20x22 mm			
6M/SH12	6x7, 8x9, 10x11, 12x13, 13x17, 14x15, 16x17, 18x19, 19x22, 20x22, 21x23, 24x27 mm			

6M-BOX



DOUBLE OPEN-END WRENCHES

- Set of double open end wrench in metric sizes
- Packaging: Sets in laquered metal box with black plastic inlay (320 x 115 x 70 mm)

	 731415			 g
6M-BOX	1832513	1	12	2965
6M-BOX	6x7, 8x9, 10x11, 12x13, 14x15, 16x17, 18x19, 20x22, 21x23, 24x26, 27x30, 30x32			

6M/



DOUBLE OPEN-END WRENCHES

- Set of double open end wrench in metric sizes
- Packaging: Sets in black plastic clip

	 731415			 g
6M/8C	0212927	1	8	735
6M/10C	0212934	1	10	1570
6M/12C	0212941	1	12	2070
6M/8C	6x7, 8x9, 10x11, 12x13, 14x15, 16x17, 18x19, 20x22, mm			
6M/10C	6x7, 8x9, 10x11, 12x13, 14x15, 16x17, 18x19, 20x22, 24x27, 30x32, mm			
6M/12C	6x7, 8x9, 10x11, 12x13, 14x15, 16x17, 18x19, 20x22, 21x23, 24x27, 25x28, 30x32, mm			



OPEN END WRENCHES

6M/S

DOUBLE OPEN-END WRENCHES

- Set of double open end wrench in metric sizes
- Packaging: In a cardboard box



	 731415			
6M/S8	1832483	1	8	735

6M/S8 6x7, 8x9, 10x11, 12x13, 14x15, 16x17, 18x19, 20x22, mm



6Z

DOUBLE OPEN-END WRENCHES



- Double open end wrench in inch sizes
- Standards: ISO 691, ISO 1085, ISO 10102 and ISO 3318
- Material: High performance alloy steel
- U shape shank provides better comfort
- Open end angle 15° with a slimmer head to get more accessibility
- Bigger and one-directional size marking for easy identification
- Chrome plated micro matt finishing provides high quality surface
- Patented U shape design

	 731415			L mm	a mm	b1 mm	b2 mm	
6Z-1/4-5/16	1832520	5	1/4x5/16	122	3.9	15.5	17.9	22
6Z-3/8-7/16	1832544	5	3/8x7/16	153	5.2	23.0	24.9	45
6Z-7/16-1/2	1832551	5	7/16x1/2	168	5.8	28.7	30.5	73
6Z-1/2-9/16	1832568	5	1/2x9/16	168	5.8	28.7	30.5	73
6Z-9/16-5/8	1832575	5	9/16x5/8	183	6.6	30.1	32.1	98
6Z-19/32-11/16	1832582	5	19/32x11/16	201	7.0	34.7	35.6	122
6Z-5/8-3/4	1832605	5	5/8x3/4	201	7.0	34.7	35.6	122
6Z-11/16-3/4	1832612	5	11/16x3/4	222	7.3	37.4	40.5	170
6Z-3/4-7/8	1832629	5	3/4x7/8	225	7.3	42.0	46.0	188
6Z-25/32-13/16	1832636	5	25/32x13/16	225	7.3	42.0	46.0	188
6Z-13/16-7/8	1832643	5	13/16x7/8	225	7.3	42.0	46.0	188
6Z-7/8-15/16	1832650	5	7/8x15/16	240	7.4	45.0	49.0	211
6Z-15/16-1	1832667	5	15/16x1	260	7.8	49.0	53.0	293
6Z-1-1.1/8	1832674	1	1x1 1/8	280	8.4	53.0	58.0	366
6Z-1.1/16-1.1/4	1832681	1	1 1/16x1 1/4	280	8.4	53.0	58.0	366
6Z-1.1/4-1.3/8	1832698	1	1 1/4x1 3/8	355	11.0	66.0	74.0	714



6Z/

DOUBLE OPEN-END WRENCHES



- Set of double open end wrenches in inch sizes
- Packaging: Sets in black plastic clip

	 731415			 g
6Z/8C	0212958	1	8	1005
6Z/8C	1/4x5/16, 5/16x11/32, 3/8x7/16, 1/2x9/16, 19/32x11/16, 5/8x3/4, 13/16x7/8, 15/16x1			

S10

DOUBLE OPEN-END WRENCHES



- Double open-end wrench in metric sizes
- Standards: DIN 3110/ISO 1085/ISO 10102
- Finish: Matt
- Material: Vanadium extra
- SB = Retail packed on a plastic info card

	 731415		 mm	L mm	a mm	b1 mm	b2 mm	 g
SBS10-6-7	3009005	1	6x7	122	3.4	16.5	18.5	21
SBS10-8-9	3010650	1	8x9	140	3.7	21.0	22.5	31
SBS10-10-11	3009012	1	10x11	157	4.0	24.0	28.0	46
SBS10-12-13	3009029	1	12x13	172	4.5	28.5	31.5	59
SBS10-14-15	3009036	1	14x15	190	4.8	32.5	35.0	83
SBS10-16-17	3009043	1	16x17	205	5.5	36.5	39.0	125
SBS10-17-19	3010667	1	17x19	222	5.8	40.5	43.0	152
SBS10-18-19	3009050	1	18x19	222	5.8	41.0	43.0	159
SBS10-20-22	3009067	1	20x22	236	6.3	45.0	48.5	198
SBS10-21-23	3009074	1	21x23	245	6.8	46.5	50.5	230
SBS10-24-27	3009081	1	24x27	275	8.0	55.0	58.0	360
SBS10-30-32	3009098	1	30x32	300	8.6	64.0	68.5	440

S10/

DOUBLE OPEN-END WRENCHES



- Set of double open end wrench in metric sizes
- Packaging: Plastic holder

	 731415			 g
S10/SH6	3013309	1	6	553
S10/SH11	3013408	1	11	1604
S10/SH6	8x9, 10x11, 12x13, 14x15, 16x17, 18x19			
S10/SH11	6x7, 8x9, 10x11, 12x13, 14x15, 16x17, 17x19, 18x19, 20x22, 21x23, 24x27			



OPEN END WRENCHES

1931M

LILIPUT DOUBLE OPEN-END SPANNERS

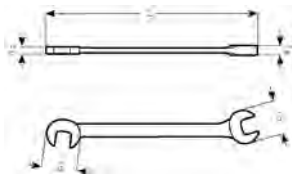

- Small double open end wrench in metric sizes
- Material: High performance alloy steel
- Open end angle of 82, 5 ° and 15°
- With equal openings at both ends
- Suitable for work in confined spaces
- Applications for radio, telecommunications, electrical and precision engineering, carburetors, etc
- Chrome plated micro matt finishing provides high quality surface

	 731415			L mm	a1xa2 mm	b1xb2 mm	
1931M-4	1049171	5	4	80	2.5	12.5	10
1931M-4.5	1049188	5	4.5	80	2.5	12.5	9
1931M-5	1049195	5	5	80	2.5	12.5	9
1931M-5.5	1049201	5	5.5	80	2.5	12.5	9
1931M-6	1049218	5	6	80	2.5	12.5	9
1931M-7	1049225	5	7	90	3.5	15.0	11
1931M-8	1049232	5	8	90	3.5	15.0	11
1931M-9	1049249	5	9	105	4.0	19.0	19
1931M-10	1049256	5	10	105	4.0	19.0	19
1931M-11	1049263	5	11	120	4.0	25.0	35
1931M-12	1049270	5	12	120	4.0	25.0	36
1931M-13	1049287	5	13	120	4.0	25.0	32
1931M-14	1049294	5	14	130	5.0	28.0	39
1931M-17	1049324	5	17	160	5.5	36.0	74

1931M/

LILIPUT DOUBLE OPEN-END SPANNERS



- Set for small double open end wrench
- Packaging: Sets in black plastic pouch

	 731415			
1931M/10T	1049409	1	10	275

1931M/10T 4, 4.5, 5, 5.5, 6, 7, 8, 9, 10, 11 mm





1931Z

LILIPUT DOUBLE OPEN-END SPANNERS

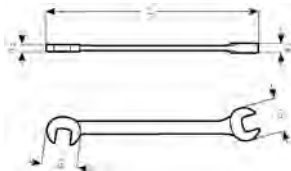

- Small double open end in inch sizes
- Material: High performance alloy steel
- Open end angle of 82, 5 ° and 15°
- With equal openings at both ends
- Suitable for work in confined spaces
- Applications for radio, telecommunications, electrical and precision engineering carburettors, etc
- Chrome plated micro matt finishing provides high quality surface

	 731415			L mm	a1xa2 mm	b1xb2 mm	 g
1931Z-5/32	1049669	5	5/32	80	2.5	12.5	10
1931Z-3/16	1049676	5	3/16	80	2.5	12.5	9
1931Z-13/64	1049683	5	13/64	80	2.5	12.5	9
1931Z-7/32	1049690	5	7/32	80	2.5	12.5	8
1931Z-1/4	1049713	5	1/4	80	2.5	12.5	8
1931Z-9/32	1049720	5	9/32	90	3.5	15.0	11
1931Z-5/16	1049737	5	5/16	90	3.5	15.0	11
1931Z-11/32	1049744	5	11/32	105	4.0	19.0	21
1931Z-3/8	1049751	5	3/8	105	4.0	19.0	19
1931Z-7/16	1049768	5	7/16	120	4.0	25.0	35
1931Z-1/2	1049775	5	1/2	120	4.0	25.0	35
1931Z-9/16	1049782	5	9/16	130	5.0	28.0	40
1931Z-5/8	1049799	5	5/8	130	5.0	30.0	47

1931Z/

LILIPUT DOUBLE OPEN-END SPANNERS



- Set for small double open end wrench
- Packaging: Sets in black plastic pouch

	 731415			 g
1931Z/12T	0107674	1	12	480

1931Z/10T 5/32, 3/16, 7/32, 1/4, 9/32, 5/16, 11/32, 3/8, 7/16, 1/2, 9/16, 5/8





OPEN END WRENCHES

1933M/



ELECTRONIC DOUBLE OPEN END WRENCHES

- Electronic double open end wrench
- Standards: DIN 934
- Material: High performance alloy steel
- Open end angle of 15° and 10° offset
- With equal openings at both ends
- Extra long and slim for work on electronic appliances and equipment etc
- Chrome plated micro matt finishing provides high quality surface
- Packaging: Sets in black plastic pouch

	 731415			 g
1933M/6T	1821654	1	6	70
1933M/6T 4x4, 4.5x4.5, 5x5, 5.5x5.5, 6x6, 7x7				

3280M/



ELECTRONIC DOUBLE OPEN END WRENCHES

- Magnetic wrench, on ring
- Material: High performance alloy steel
- 8 magnetic wrenches Nos 3280M
- 1 contact file No. 3280/1
- 1 feeler gauge No. 3280/2
- 1 screwdriver No. 3280/4
- Chrome plated micro matt finishing provides high quality surface

	 731415		 g
3280M	1071318	1	35
3280M 4, 4.5, 5, 5.5, 6, 6.5, 7, 7.5 mm, 3280/1, 3280/2, 3280/4			





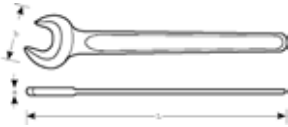

894M

SINGLE OPEN END WRENCH



- Single open end wrenches
- Standards: ISO 3318 and DIN 894
- Material: Standard alloy steel
- Open end angle 15°
- Gunmetal finishing

	 731415		 mm	L mm	a mm	b mm	 g
894M-7	1833008	10	7	78	3.2	16	10
894M-8	1833015	10	8	94	3.5	18	14
894M-9	1833022	10	9	100	4.0	20	16
894M-10	1833039	10	10	106	4.5	22	20
894M-11	1833046	10	11	112	5.0	24	23
894M-12	1833053	10	12	125	5.0	26	30
894M-13	1833060	10	13	125	5.0	29	40
894M-14	1833077	10	14	140	5.5	30	40
894M-15	1833084	10	15	140	5.5	32	49
894M-17	1833091	10	17	158	6.0	36	55
894M-19	1833107	10	19	171	7.0	40	75
894M-22	1833114	5	22	195	8.0	46	100
894M-24	1833121	5	24	216	9.0	50	150
894M-27	1833138	5	27	240	10.0	56	215
894M-30	1833145	5	30	262	11.0	62	270
894M-32	1833152	5	32	274	12.0	67	320
894M-36	1833169	5	36	303	13.0	74	400
894M-38	1833176	1	38	305	13.0	78	420
894M-41	1833183	1	41	343	14.0	85	590
894M-46	1833190	1	46	378	15.0	94	750
894M-50	1833206	1	50	413	16.0	102	945
894M-55	1833213	1	55	457	17.0	113	1185
894M-60	1833220	1	60	492	18.0	122	1380
894M-65	1833237	1	65	528	19.0	132	1750
894M-70	1833244	1	70	573	20.0	142	2270
894M-75	1833251	1	75	608	21.0	152	2770
894M-80	1833268	1	80	644	22.0	162	3180
894M-85	1833275	1	85	690	23.0	174	3630
894M-90	1833282	1	90	690	25.0	174	3630
894M-95	1833299	1	95	850	25.0	195	5750
894M-100	1833305	1	100	1000	28.0	195	5530
894M-105	1833312	1	105	1000	28.0	215	7300
894M-110	1833329	1	110	1000	28.0	215	7300
894M-115	1833336	1	115	1000	28.0	215	7300
894M-120	1833343	1	120	1000	28.0	215	7300
894M-125	0132478	1	125	1000	28	225	7300
894M-130	0132485	1	130	1000	28	225	7600
894M-135	0132492	1	135	1000	28	225	7400



OPEN END WRENCHES

895M

DOUBLE OPEN END WRENCH



- Double open end wrenches
- Standards: ISO 1085 and DIN 895
- Material: Standard alloy steel
- Open end angle 15°
- Gunmetal finishing

	 731415		 mm	L mm	a mm	b1 mm	b2 mm	 g
895M-6-7	1832711	10	6x7	96	3.2	14	16	13
895M-8-9	1832728	10	8x9	109	4.0	18	20	20
895M-8-10	1832735	10	8x10	115	4.5	18	22	26
895M-10-11	1832742	10	10x11	124	5.0	22	24	32
895M-10-13	1832759	10	10x13	110	5.5	22	28	37
895M-13-17	1832803	5	13x17	155	6.0	30	36	64
895M-17-19	1832827	5	17x19	172	7.0	36	40	99
895M-19-22	1832834	5	19x22	195	8.0	40	46	140
895M-19-24	1832841	5	19x24	206	8.5	40	50	170
895M-22-24	1832858	5	22x24	220	9.0	46	50	186
895M-24-27	1832865	5	24x27	244	10.0	50	56	250
895M-24-30	1832872	5	24x30	265	11.0	56	67	385
895M-27-32	1832889	5	27x32	270	12.0	60	67	385
895M-30-32	1832896	5	30x32	275	12.0	62	67	405
895M-30-36	1832902	1	30x36	305	13.0	62	75	500
895M-32-36	1832919	1	32x36	307	13.0	67	75	530
895M-36-41	1832926	1	36x41	345	14.0	75	85	740
895M-41-46	1832933	1	41x46	381	15.0	85	93	955
895M-46-50	1832940	1	46x50	420	16.0	95	103	1180
895M-50-55	1832957	1	50x55	460	17.0	103	113	1590
895M-55-60	1832964	1	55x60	500	18.0	112	122	1950
895M-65-70	1832971	1	65x70	580	20.0	132	142	2930



2M

DOUBLE RING END WRENCH, DEEP OFFSET



- Double end deep offset ring wrench in metric sizes
- Standards: ISO 1085, ISO 10104 and DIN 838
- Material: High performance alloy steel
- 12 points Dynamic-Drive Profile provides longer life for screws and nuts
- Chrome plated micro matt finishing provides high quality surface

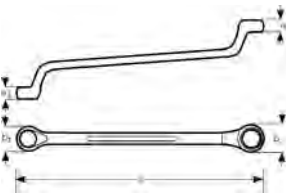

	 731415		 mm	L mm	a1xa2 mm	b1xb2 mm	 g
2M-6-7	1001209	5	6x7	165	5.0x6.0	10.5x12.0	40
2M-8-9	1001216	5	8x9	180	6.0x6.5	13.0x14.5	55
2M-8-10	1001506	5	8x10	180	6.0x6.5	13.0x14.5	65
2M-10-11	1001223	5	10x11	190	7.0x7.5	16.1x18.1	85
2M-10-13	1001513	5	10x13	220	7.9x9.1	16.6x20.0	120
2M-12-13	1001230	5	12x13	210	8.0x8.5	18.7x20.8	125
2M-13-17	1343972	5	13x17	243	9.5x10.0	20.8x27.0	180
2M-14-15	1001247	5	14x15	226	8.5x9.5	22.5x24.5	155
2M-16-17	1001254	5	16x17	246	9.5x10.0	25.0x27.0	200
2M-16-18	1001575	5	16x18	246	9.5x10.0	25.0x27.0	190
2M-17-19	1000844	5	17x19	266	10.5x11.0	27.5x29.5	255
2M-18-19	1001261	5	18x19	266	10.5x11.0	27.5x29.5	260
2M-19-22	1000868	5	19x22	291	11.5x12.0	30.6x33.7	340
2M-20-22	1001278	5	20x22	291	11.5x12.0	30.6x33.7	350
2M-21-23	1001285	5	21x23	306	12.0x13.0	32.7x35.8	390
2M-22-24	1001612	5	22x24	306	12.0x13.0	32.7x35.8	450
2M-24-26	1001292	5	24x26	326	13.0x14.0	35.8x40.0	470
2M-24-27	1000899	5	24x27	326	13.0x14.0	35.8x40.0	530
2M-25-28	1001308	5	25x28	336	13.5x14.5	37.8x43.0	510
2M-27-29	0205332	5	27x29	351	14.0x15.0	42.0x46.0	594
2M-27-30	1001636	5	27x30	351	14.0x15.0	42.0x46.1	610
2M-27-32	1001322	5	27x32	353	14.0x16.0	42.0x49.5	620
2M-30-32	1000929	5	30x32	362	15.0x16.0	46.5x49.5	650
2M-32-36	1001667	1	32x36	416	17.0x18.0	49.5x55.5	850
2M-36-41	1001681	1	36x41	444	18.5x19.5	55.0x61.5	1170
2M-41-46	1001704	1	41x46	483	20.0x21.0	61.5x67.5	1450
2M-46-50	1001711	1	46x50	541	21.0x22.0	67.5x74.0	1700

2M/

DOUBLE RING END WRENCH, DEEP OFFSET



- Set of double end deep offset ring wrenches
- Packaging: Sets in black plastic pouch

	 731415			 g
2M/8T	1001391	1	8	1330
2M/12T	1001414	1	12	3800

2M/8T 6x7, 8x9, 10x11, 12x13, 14x15, 16x17, 18x19, 20x22 mm



2M/12T 6x7, 8x9, 10x11, 12x13, 14x15, 16x17, 18x19, 20x22, 21x23, 24x27, 25x28, 30x32 mm





RING END WRENCHES

2M/S

DOUBLE RING END WRENCH, DEEP OFFSET



- Set of double end deep offset ring wrenches
- Packaging: Sets in cardboard box

	 731415			
2M/S8	1827335	1	8	1680

2M/S8 6x7, 8x9, 10x11, 12x13, 14x15, 16x17, 18x19, 20x22



2Z

DOUBLE RING END WRENCH, DEEP OFFSET



- Double end deep offset ring wrench in inch sizes
- Standards: ISO 1085, ISO 10104 and DIN 838
- Material: High performance alloy steel
- 12 points Dynamic-Drive Profile provides longer life for screws and nuts
- Chrome plated micro matt finishing provides high quality surface

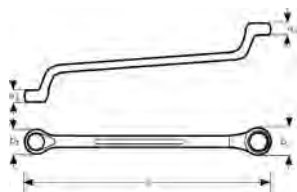

	 731415			L mm	a1xa2 mm	b1xb2 mm	
2Z-1/4-5/16	1001421	1	1/4x5/16	165	5x6	10.5x12	46
2Z-5/16-3/8	1001728	1	5/16x3/8	180	6x6.5	13x14.5	50
2Z-3/8-7/16	1001438	1	3/8x7/16	190	7x7.5	16.1x18.1	80
2Z-1/2-9/16	1001445	1	1/2x9/16	210	8x8.5	18.7x22.5	135
2Z-9/16-5/8	1001735	1	9/16x5/8	225.8	8.5x9.5	22.5x24.5	170
2Z-5/8-11/16	1001452	1	5/8x11/16	245.5	9.5x10	25x27	200
2Z-3/4-7/8	1001773	1	3/4x7/8	290.5	11.5x12	30.6x33.7	330
2Z-13/16-7/8	1001797	1	13/16x7/8	290.5	12x30	30.6x33.7	340
2Z-15/16-1	1001810	1	15/16x1	325.8	13x14	35.75x40	470
2Z-1-1.1/8	1001827	1	1x1 1/8	335.9	13.5x14.5	37.8x43	505
2Z-1.1/16-1.1/4	1001834	1	1 1/16x1 1/4	353	14x16	42x49.5	630



S30

DOUBLE RING END WRENCH, DEEP OFFSET

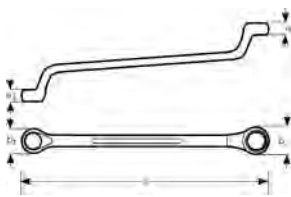

- Double ended deep offset ring wrenches in metric sizes
- Standards: DIN 838/ISO 1085 /ISO 10104
- Finish: Matt
- 12 points Dynamic-Drive Profile provides longer life for screws and nuts
- SB = Retail packed on a plastic info card

	 731415		 mm	L mm	a1xa2 mm	b1xb2 mm	 g
SBS30-6-7	3009425	1	6x7	168	5.4x5.9	10.5x12.2	40
SBS30-8-9	3009432	1	8x9	180	6.4x7.9	13.2x14.8	55
SBS30-10-11	3009449	1	10x11	195	7.2x7.9	16.0x17.4	85
SBS30-12-13	3009456	1	12x13	220	8.3x9.1	18.8x20.0	125
SBS30-14-15	3009463	1	14x15	230	9.1x9.9	21.8x23.0	155
SBS30-16-17	3009470	1	16x17	245	10.2x11.0	24.5x26.0	200
SBS30-17-19	3010674	1	17x19	270	11.0x11.8	26.0x27.8	255
SBS30-18-19	3009487	1	18x19	275	11.0x11.8	28.0x29.0	260
SBS30-20-22	3009494	1	20x22	300	12.3x12.8	30.6x33.0	350
SBS30-21-23	3009500	1	21x23	310	12.4x13.3	31.4x35.4	390
SBS30-24-27	3009517	1	24x27	340	14.3x15.2	36.0x40.2	530
SBS30-30-32	3009524	1	30x32	650	16.2x16.7	44.5x47.0	650

1300Z

DOUBLE RING END WRENCH, OFFSET

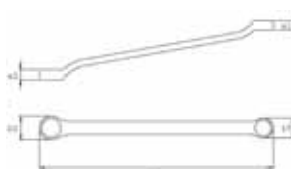

- Double ring end wrench, offset, in inch sizes
- Material: High performance alloy steel
- 12 points Dynamic-Drive Profile provides longer life for screws and nuts
- Extra thin-walled heads, ring heads with 15° swan neck
- Chrome plated micro matt finishing provides high quality surface

	 731415		 mm	L mm	a1xa2 mm	b1xb2 mm	 g
1300Z-1/4-5/16	3000965	1	1/4x5/16	156	6.0x6.9	10.1x12.2	35
1300Z-3/8-7/16	1039981	1	3/8x7/16	193	7.7x8.5	14.4x16.5	50
1300Z-1/2-9/16	1039998	1	1/2x9/16	220	9.0x9.4	18.7x20.8	105
1300Z-19/32-11/16	1040000	1	19/32x11/16	258	10.8x11.6	23.0x25.1	171
1300Z-5/8-3/4	1040017	1	5/8x3/4	268	10.8x12.3	23.0x27.3	210
1300Z-25/32-13/16	3000972	1	25/32x13/16	300	12.3x13.1	27.3x29.4	300
1300Z-7/8-15/16	3005649	1	7/8x15/16	334	13.8x14.6	31.6x33.8	410
1300Z-15/16-1	3005656	1	15/16x1	352	14.6x15.3	33.8x35.9	460
1300Z-1-1.1/8	3000989	1	1x1.1/8	404	16.0x17.3	38.1x42.2	680



RING END WRENCHES

4M

DOUBLE RING END WRENCH, FLAT



- Double flat ring wrench in metric sizes
- Standards: ISO 1085, ISO 10103 and DIN 837
- Material: High performance alloy steel
- 12 points Dynamic-Drive Profile provides longer life for screws and nuts
- Thin-walled heads, both sides chamfered
- Chrome plated micro matt finishing provides high quality surface



	 731415		 mm	L mm	a mm	b1 mm	b2 mm	 g
4M-6-7	1829407	10	6x7	100	4.7	9.9	11.2	12
4M-8-9	1829414	10	8x 9	115	5.2	12.5	14.0	16
4M-10-11	1829438	10	10x11	130	6.4	15.5	16.5	24
4M-12-13	1829445	10	12x13	143	7.3	18.5	20.5	36
4M-14-15	1829476	10	14x15	157	7.3	21.0	22.5	48
4M-16-17	1829490	10	16x17	168	8.5	23.5	24.5	62
4M-17-19	1829506	10	17x19	185	9.0	25.5	27.0	76
4M-18-19	1829513	10	18x19	189	9.2	26.0	27.5	80
4M-20-22	1829520	10	20x22	200	10.5	28.0	31.5	120
4M-21-23	0205363	5	21x23	225	9.5	30.0	33.0	154
4M-24-26	0205370	1	24x26	250	11.0	35.0	38.0	210
4M-24-27	1829551	1	24x27	255	11.0	35.0	38.0	182
4M-25-28	0205387	1	25x28	275	11.0	38.0	41.0	280
4M-27-29	0205394	1	27x29	275	11.0	38.0	41.0	275
4M-30-32	1829575	1	30x32	285	12.8	42.5	45.0	280

4M/T

DOUBLE RING END WRENCH, FLAT



- Set of double flat ring wrenches in metric sizes
- Packaging: Sets in black plastic pouch

	 731415			 g
4M/10T	1829605	1	10	1070
4M/10T	6x7, 8x9, 10x11, 12x13, 14x15, 16x17, 18x19, 20x22, 24x27, 30x32 mm			



4M/

DOUBLE RING END WRENCH, FLAT



- Set of double flat ring wrenches in metric sizes
- Packaging: Set in standard cardboard box

	 731415			 g
4M/8	0180493	1	8	510
4M/8	6x7, 8x9, 10x11, 12x13, 14x15, 16x17, 18x19, 20x22 mm			

1943M

STARTER AND MANIFOLD WRENCHES



- Starter and manifold double flat box wrench in metric sizes
- Material: High performance alloy steel
- Suitable for working in confined and hard to reach spaces
- 12 points Dynamic-Drive Profile provides longer life for screws and nuts
- Chrome plated micro matt finishing provides high quality surface

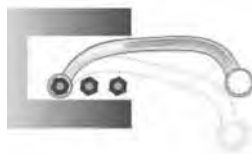
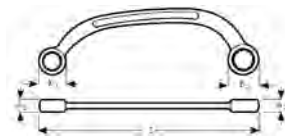

	 731415		 mm	L mm	a1xa2 mm	b1xb2 mm	 g
1943M-11-13	1052829	1	11x13	150	7.0x7.5	17.0x19.5	75
1943M-13-15	1804732	1	13x15	185	8.5x9.0	21.0x24.0	115
1943M-13-17	1804749	1	13x17	185	8.5x9.0	21.0x25.0	115
1943M-14-16	1052836	1	14x16	185	8.5x9.0	21.0x25.0	115
1943M-14-17	1052843	1	14x17	185	8.5x9.0	21.5x25.0	115
1943M-15-17	1052850	1	15x17	185	8.5x9.0	22.0x25.0	115
1943M-19-22	1052867	1	19x22	235	11.5x12.0	28.5x32.0	220



FLARE NUT WRENCHES

1949M

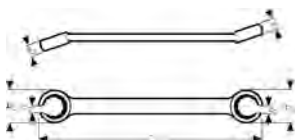

FLARE-NUT WRENCH DOUBLE END OFFSET

- Flare nut wrench double end offset in metric sizes
- Standards: DIN 3118
- Material: High performance alloy steel
- 6 points: 8x9, 10x11, 10x12, 12x13, 12x14
- 12 points: 14x15 and 14x17 onwards
- Ring end angle 15° for knuckle clearance or better grip
- Applications for tube tightening in auto and plumbing environments
- Special deep head to protect and apply heavy torque on the screw
- Chrome plated micro matt finishing provides high quality surface

	 731415		 mm	L mm	a1xa2 mm	b1xb2 mm	c1xc2 mm	 g
1949M-8-9	1304539	1	8x9	140	7.0x8.0	18.0x20.0	6x6.5	50
1949M-10-11	1055394	1	10x11	150	8.5x9.0	20.0x22.0	7x8.5	70
1949M-10-12	1055400	1	10x12	150	8.5x9.0	20.0x22.0	7x9.0	70
1949M-12-13	1055417	1	12x13	170	9.5x11.0	24.0x28.0	9x10.0	95
1949M-12-14	1055424	1	12x14	170	9.5x11.0	24.0x28.0	9x11.0	95
1949M-14-15	1304546	1	14x15	170	10.5x11.0	26.0x28.0	11x12.0	100
1949M-14-17	1055448	1	14x17	200	11.0x12.0	28.0x30.0	11x14.0	135
1949M-17-19	1055455	1	17x19	210	12.5x13.5	31.5x34.5	14x15.0	145
1949M-19-22	1055462	1	19x22	220	13.5x15.5	34.0x40.0	15x17.0	215
1949M-22-24	1304553	1	22x24	235	15.5x16.5	38.0x42.0	17x18.0	260
1949M-24-27	1055479	1	24x27	255	16.5x17.5	44.5x47.5	18x20.0	335
1949M-30-32	1304577	1	30x32	280	20.5x22.5	50.0x52.0	22x24.0	440

1949Z

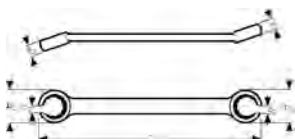

FLARE-NUT WRENCH DOUBLE END OFFSET

- Flare nut wrench double end offset in inch sizes
- Standards: DIN 3118
- Material: High performance alloy steel
- 12 points: 5/8-3/4 3/4-7/8 1-1.1/8
- 6 points: 3/8-7/16 1/2-9/16
- Ring end angle 15° for knuckle clearance or better grip
- Applications for tube tightening in auto and plumbing environments
- Special deep head to protect and apply heavy torque on the screw
- Chrome plated micro matt finishing provides high quality surface

	 731415		 mm	L mm	a1xa2 mm	b1xb2 mm	c1xc2 mm	 g
1949Z-3/8-7/16	1055486	1	3/8x7/16	150	8.5x9.0	20.0x22.0	7.0x8.5	60
1949Z-1/2-9/16	1055509	1	1/2x9/16	170	10.5x11.0	26.0x28.0	10.0x11.0	95
1949Z-5/8-3/4	1055523	1	5/8x3/4	210	12.5x13.5	31.5x34.5	13.5x15.0	155
1949Z-3/4-7/8	1055530	1	3/4x7/8	220	13.5x15.5	34.0x40.0	15.0x17.0	205
1949Z-1-1.1/8	1055547	1	1x1 1/8	255	16.5x17.5	44.5x47.5	19.0x21.0	290



1950M

OPEN-RING WRENCHES



- Crowfoot wrench, flare nut
- Standards: ISO 1174 and DIN 3120
- Material: High performance alloy steel
- Protected and easy to use gear wrench
- Right and left direction
- Chrome plated bright finishing provides high quality surface

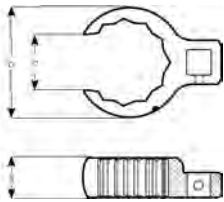

	 731415		 mm		a mm	b mm	c mm	 g
1950M-10	1055738	1	10	1/4	13.5	18.2	7.1	16
1950M-12	1314941	1	12	1/4	14.0	20.6	9.0	20
1950M-13	1055752	1	13	1/4	14.0	22.2	10.0	20
1950M-14	1055769	1	14	1/4	14.0	22.2	11.0	20
1950M-17	1055783	1	17	3/8	17.5	27.3	14.0	40
1950M-19	1055790	1	19	3/8	18.5	29.0	15.8	40
1950M-21	1055806	1	21	3/8	18.5	31.3	16.2	45
1950M-22	1055813	1	22	3/8	19.0	33.5	17.0	57
1950M-24	1055820	1	24	3/8	19.5	35.7	18.0	57
1950M-26	1314996	1	26	3/8	20.0	37.7	19.0	63
1950M-27	1055844	1	27	3/8	21.4	40.0	20.0	92
1950M-30	1055868	1	30	1/2	22.5	48.0	22.0	155
1950M-32	1055875	1	32	1/2	22.5	48.0	24.0	137
1950M-36	1055905	1	36	1/2	24.0	52.0	27.0	107
1950M-41	1055936	1	41	1/2	24.5	58.0	31.0	169
1950M-46	1055967	1	46	1/2	26.0	64.2	34.0	229

1950MZ

OPEN-RING WRENCHES



- 3/8" crowfoot adjustable wrench
- Standards: ISO 1174 and DIN 3120
- Material: High performance alloy steel
- Adjustable opening up to 29 mm and 1.1/8"
- Laser branded scale in mm and inches
- Chrome plated bright finishing provides high quality surface

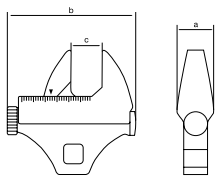

	 731415		 mm		a mm	b mm	c mm	 g
1950MZ-3/8	0130207	1	0-29 mm / 0-1.1/8"	3/8	14.5	65	29	170



7444SG-M

RING END SLOGGING WRENCHES



- Ring-end slogging wrench in metric sizes
- Standards: DIN 7444
- Material: Special steel
- 12 points profile ring
- Short and strong profiled handle and striking end for heavy duty applications
- Finish: Steel grey

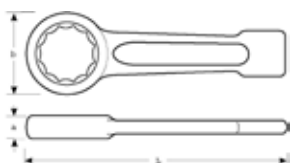

	 731415		 mm	L mm	a mm	b mm	 g
7444SG-M-24	0205400	1	24	165	15	43	235
7444SG-M-27	1829834	1	27	180	16	46	295
7444SG-M-30	1829841	1	30	190	17	52	400
7444SG-M-32	1829858	1	32	190	17	52	400
7444SG-M-34	1838560	1	34	205	18	57	400
7444SG-M-36	1829865	1	36	205	18	58	540
7444SG-M-38	0180936	1	38	205	18	58	540
7444SG-M-41	1829872	1	41	230	20	66	700
7444SG-M-42	1829889	1	42	230	20	66	700
7444SG-M-46	1829896	1	46	240	22	74	970
7444SG-M-50	1829919	1	50	255	24	80	1130
7444SG-M-55	1829926	1	55	270	25	86	1345
7444SG-M-60	1829933	1	60	280	26	93	1650
7444SG-M-65	1829940	1	65	300	30	102	2000
7444SG-M-70	1829957	1	70	330	33	110	2600
7444SG-M-75	1829964	1	75	330	33	110	2600
7444SG-M-80	1829971	1	80	360	36	126	3500
7444SG-M-85	1829988	1	85	360	36	126	3500
7444SG-M-90	1829995	1	90	390	40	142	5000
7444SG-M-95	1830007	1	95	390	40	142	5000
7444SG-M-100	1830014	1	100	420	45	155	6500
7444SG-M-105	1830021	1	105	420	45	155	6500
7444SG-M-110	1830038	1	110	450	48	170	7800
7444SG-M-115	1830045	1	115	450	48	170	7800
7444SG-M-120	1830052	1	120	480	54	182	9400
7444SG-M-125	1830069	1	125	480	54	182	8500
7444SG-M-130	1830076	1	130	520	58	202	13000
7444SG-M-135	1830083	1	135	520	58	202	11900
7444SG-M-140	1830090	1	140	520	58	202	12500
7444SG-M-145	1830106	1	145	580	64	228	18500
7444SG-M-150	1830113	1	150	580	64	228	18750
7444SG-M-155	1830120	1	155	580	64	228	18550
7444SG-M-160	0132508	1	160	580	64	228	18000
7444SG-M-165	0132515	1	165	650	70	565	25000
7444SG-M-170	0132522	1	170	650	70	565	25000
7444SG-M-175	0132539	1	175	650	70	565	25000



7444SG-Z

RING END SLOGGING WRENCHES



- Ring-end slogging wrench in inch sizes
- Standards: DIN 7444
- Material: Special steel
- 12 points profile ring
- Short and strong profiled handle and striking end for heavy duty applications
- Finish: Steel grey

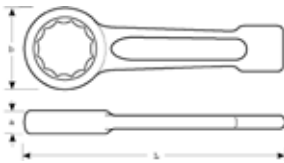

	 731415			L mm	a mm	b mm	 g
7444SG-Z-1.1/16	0132546	1	1 1/16	180	16	46	350
7444SG-Z-1.1/8	0132553	1	1 1/8	180	16	46	350
7444SG-Z-1.3/16	0132560	1	1 3/16	190	17	52	400
7444SG-Z-1.1/4	0132577	1	1 1/4	190	17	52	450
7444SG-Z-1.5/16	0132584	1	1 5/16	190	17	52	450
7444SG-Z-1.3/8	0132591	1	1 3/8	205	18	58	750
7444SG-Z-1.7/16	0132607	1	1 7/16	205	18	58	750
7444SG-Z-1.1/2	0132614	1	1 1/2	205	18	58	750
7444SG-Z-1.5/8	0132621	1	1 5/8	230	20	66	850
7444SG-Z-1.11/16	0132638	1	1 11/16	230	20	66	850
7444SG-Z-1.3/4	0132645	1	1 3/4	240	22	74	1050
7444SG-Z-1.13/16	0132652	1	1 13/16	240	22	74	1050
7444SG-Z-1.7/8	0132669	1	1 7/8	240	22	74	1050
7444SG-Z-2	0132676	1	2	255	24	80	1250
7444SG-Z-2.1/16	0132683	1	2 1/16	255	24	80	1250
7444SG-Z-2.1/8	0132690	1	2 1/8	270	25	86	1550
7444SG-Z-2.3/16	0132706	1	2 3/16	270	25	86	1550
7444SG-Z-2.1/4	0132713	1	2 1/4	270	25	86	1550
7444SG-Z-2.3/8	0132720	1	2 3/8	280	26	93	1650
7444SG-Z-2.9/16	0132744	1	2 9/16	300	30	102	2300
7444SG-Z-2.5/8	0132751	1	2 5/8	300	30	102	2300
7444SG-Z-2.3/4	0132768	1	2 3/4	330	33	110	2600
7444SG-Z-3	0132775	1	3	330	33	110	3350
7444SG-Z-3.1/8	0132782	1	3 1/8	360	36	126	3800
7444SG-Z-3.3/8	0132799	1	3 3/8	360	36	126	4200
7444SG-Z-3.1/2	0132805	1	3 1/2	390	40	142	5700
7444SG-Z-3.3/4	0132812	1	3 3/4	390	40	142	5700
7444SG-Z-3.7/8	0132829	1	3 7/8	420	45	155	6700
7444SG-Z-4	0132836	1	4	420	45	155	6700
7444SG-Z-4.1/8	0132843	1	4 1/8	420	45	155	6700
7444SG-Z-4.1/2	0132850	1	4 1/2	450	48	170	8500



HEAVY DUTY WRENCHES

133SGM

OPEN END SLOGGING WRENCH



- Open end sledge hammer wrench in metric sizes
- Standards: DIN 133
- Material: Special steel, forged
- Angle 15°
- Short and strong profiled handle
- Striking end for heavy duty operations in shipyards, railways and other demanding industrial operations

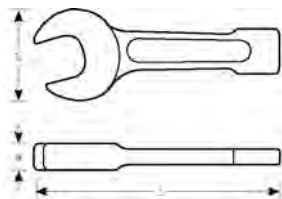

	 731415		 mm	L mm	a mm	b mm	 g
133SGM-27	1828363	1	27	180	16.0	56	305
133SGM-30	1828370	1	30	190	17.0	62	430
133SGM-32	1828387	1	32	190	17.0	62	440
133SGM-36	1828394	1	36	215	17.5	76	700
133SGM-41	1828400	1	41	235	18.5	86	930
133SGM-46	1828417	1	46	255	20.0	98	1280
133SGM-50	1828424	1	50	275	21.0	105	1565
133SGM-55	1828431	1	55	300	23.0	116	1940
133SGM-60	1828448	1	60	320	24.5	128	2500
133SGM-65	1828455	1	65	342	27.0	138	3510
133SGM-70	1828462	1	70	375	30.0	154	4260
133SGM-75	1828479	1	75	375	30.0	154	5000
133SGM-80	1828486	1	80	408	34.0	174	5830
133SGM-85	1828493	1	85	408	34.0	174	5860
133SGM-90	1828509	1	90	445	38.0	194	8140
133SGM-95	1828516	1	95	445	38.0	194	8230
133SGM-100	1828523	1	100	485	44.0	215	11500
133SGM-105	1828530	1	105	485	44.0	215	11500
133SGM-110	1828547	1	110	510	47.0	235	13650
133SGM-115	1828554	1	115	510	47.0	235	13500
133SGM-120	1828561	1	120	545	50.0	255	17850



315M

RING END SLOGGING WRENCH, DEEP OFFSET



- Ring end slogging wrench, deep offset, in metric sizes
- Material: Forged high carbon alloy steel for extra heavy duty strength
- 45 ° offset head
- 12 points profile ring
- Black oxide and waxed for a rust resistant finish

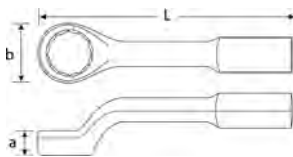

	 731415		 mm	L mm	a mm	b mm	 g
315M-27	0133291	1	27	279	22	51	1300
315M-30	0133307	1	30	279	22	51	1300
315M-32	0133314	1	32	279	22	51	1300
315M-36	0133321	1	36	317	29	70	2900
315M-41	0133345	1	41	317	28	70	2900
315M-46	0133352	1	46	324	29	79	2800
315M-50	0133369	1	50	324	29	79	2800
315M-55	0133376	1	55	355	35	92	4200
315M-60	0133383	1	60	355	35	92	4000
315M-65	0133390	1	65	362	35	101	4200
315M-70	0133406	1	70	406	44	124	7300
315M-75	0133413	1	75	406	44	124	7100
315M-80	0133420	1	80	406	44	124	6700

315Z

RING END SLOGGING WRENCH, DEEP OFFSET



- Ring end slogging wrench, deep offset, in inch sizes
- Material: Forged high carbon alloy steel for extra heavy duty strength
- 45 ° offset head
- 12 points profile ring
- Black oxide and waxed for a rust resistant finish

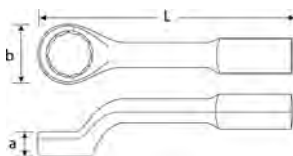

	 731415		 mm	L mm	a mm	b mm	 g
315Z-1.1/16	0133437	1	1.1/16	279	23	51	1300
315Z-1.1/8	0133444	1	1.1/8	279	23	51	1300
315Z-1.3/16	0133451	1	1.3/16	279	23	54	1300
315Z-1.1/4	0133468	1	1.1/4	279	23	54	1300
315Z-1.5/16	0133475	1	1.5/16	279	23	54	1300
315Z-1.3/8	0133482	1	1.3/8	279	23	54	1200
315Z-1.7/16	0133499	1	1.7/16	317	29	70	2900
315Z-1.1/2	0133505	1	1.1/2	317	29	70	2900
315Z-1.5/8	0133512	1	1.5/8	317	29	70	2800
315Z-1.11/16	0133529	1	1.11/16	317	29	73	2800
315Z-1.3/4	0133536	1	1.3/4	317	29	73	2800
315Z-1.13/16	0133543	1	1.13/16	317	29	76	2800
315Z-1.7/8	0133550	1	1.7/8	317	29	76	2800
315Z-1.15/16	0133567	1	1.15/16	317	29	76	2800
315Z-2	0133574	1	2	324	29	79	2800
315Z-2.1/16	0133581	1	2.1/16	324	29	79	2700
315Z-2.1/8	0133598	1	2.1/8	355	35	92	4200
315Z-2.3/16	0133604	1	2.3/16	355	35	95	4200
315Z-2.1/4	0133611	1	2.1/4	355	35	95	4200
315Z-2.5/16	0133628	1	2.5/16	355	35	95	4200
315Z-2.3/8	0133635	1	2.3/8	355	35	95	4100
315Z-2.1/2	0133642	1	2.1/2	362	34	101	4200
315Z-2.9/16	0133659	1	2.9/16	362	34	105	4200
315Z-2.5/8	0133666	1	2.5/8	362	34	105	4100
315Z-2.3/4	0133673	1	2.3/4	406	45	124	7000
315Z-2.7/8	0133680	1	2.7/8	406	45	124	7200
315Z-2.15/16	0133697	1	2.15/16	355	35	95	4200
315Z-3	0133703	1	3	406	45	124	6900
315Z-3.1/8	0133840	1	3.1/8	406	45	126	6800



HEAVY DUTY WRENCHES

310M

RING END HEAVY DUTY WRENCH, DEEP OFFSET

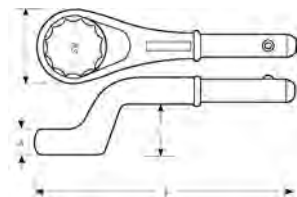

- Ring end heavy duty wrench, deep offset, in metric sizes
- Material: High performance alloy steel
- Without tubular handle
- 12 points profile ring
- Suitable for robust construction and for work under very tough conditions

	 731415		 mm	L mm	a mm	b mm	h mm	 g
310M-24	1829612	1	24	180	17.0	38	29.5	380
310M-27	1829629	1	27	190	17.0	41	31.5	410
310M-30	1829636	1	30	200	18.0	48	33.5	510
310M-32	1829643	1	32	235	18.0	49	34.0	740
310M-36	1829650	1	36	245	20.0	54	35.5	780
310M-38	1829667	1	38	250	21.0	56	37.5	860
310M-41	1829674	1	41	265	22.0	62	39.5	980
310M-46	1829681	1	46	280	23.0	69	40.0	1280
310M-50	1829698	1	50	290	25.5	76	42.5	1400
310M-55	1829704	1	55	300	28.0	81	45.5	1570
310M-60	1829711	1	60	345	30.5	90	49.0	2340
310M-65	1829728	1	65	355	33.0	98	53.0	2580
310M-70	1829735	1	70	365	35.5	105	55.0	2800
310M-75	1829742	1	75	375	38.0	110	57.5	3050
310M-80	1829759	1	80	385	40.5	125	59.0	3900
310M-85	1829766	1	85	385	40.5	125	59.0	3900
310M-90	1829773	1	90	410	45.0	140	63.0	5000
310M-95	1829780	1	95	410	45.0	140	63.0	5000

R310

TUBULAR HANDLE



- Tubular handle
- Material: High performance alloy steel
- Finish: Zinc-plated
- Handle to be used together with the ring wrench 310M

	 731415		∅ mm	 mm	 mm	 g
R310-0	1829797	1	19	24-30	460	595
R310-1	1829803	1	22	32-41	610	1110
R310-2	1829810	1	25	46-55	760	2150
R310-3	1829827	1	30	60-95	860	2900



28M

DOUBLE HEAD SOCKET WRENCHES OFFSET



- Double head socket wrench, offset in metric sizes
- Standards: ISO 2236
- Material: High performance alloy steel
- 12 points Dynamic-Drive Profile in offset ring
- 6 points Dynamic-Drive Profile in straight ring
- Go through in offset and deep socket in straight side to use even for long thread bar
- Chrome plated micro matt finishing provides high quality surface

	 731415		 mm	L mm	h mm	d mm	e Ø mm	 g
28M-6	1834630	5	6	95	17	10.0	5	22
28M-7	1834647	5	7	100	19	11.0	5	35
28M-8	1834654	5	8	110	24	12.0	7	40
28M-9	1834661	5	9	115	25	13.0	7	60
28M-10	1834678	5	10	125	27	14.5	7	80
28M-11	1834685	5	11	130	29	16.5	8	100
28M-12	1834692	5	12	145	31	17.5	9	120
28M-13	1834708	5	13	160	34	19.0	9	140
28M-14	1834715	5	14	175	36	20.5	10	160
28M-15	1834722	5	15	180	38	21.5	10	195
28M-16	1834739	5	16	190	43	23.0	13	235
28M-17	1834746	5	17	195	44	24.5	13	300
28M-18	1834753	3	18	200	45	25.5	14	370
28M-19	1834760	3	19	210	48	27.0	14	405
28M-20	0122561	3	20	220	50	28	15	435
28M-21	1834777	3	21	225	51	29.5	15	460
28M-22	1834784	3	22	235	53	31.0	16	520
28M-23	0122578	3	23	245	58	32.5	16	555
28M-24	1834791	3	24	255	60	33.5	18	640
28M-25	0122585	3	25	260	58	35	18	755
28M-26	0122592	3	26	265	58	36.5	20	785
28M-27	1834807	3	27	275	63	37.0	20	850
28M-28	0122608	1	28	285	63	39	22	990
28M-29	0122615	1	29	295	63	40	22	1100
28M-30	1834814	1	30	305	75	41.0	24	1015
28M-32	1834821	1	32	330	75	44.0	24	1115

28M/

DOUBLE HEAD SOCKET WRENCHES OFFSET



- Set of double head socket wrench, offset
- Packaging: In cardboard box

	 731415			 g
28M/8	1838119	1	8	1700
28M/11	1838126	1	11	2200
28M/12	1838133	1	12	2300
28M/15	1838140	1	15	4000

28M/8	8, 10, 11, 13, 16, 17, 18, 19 mm
28M/11	8, 9, 10, 11, 12, 13, 14, 15, 17, 19, 22 mm
28M/12	8, 9, 10, 11, 12, 13, 14, 15, 16, 17, 18, 19 mm
28M/15	8, 9, 10, 11, 12, 13, 14, 15, 16, 17, 18, 19, 21, 22, 24 mm





TUBULAR WRENCHES

29M

DOUBLE HEAD SOCKET WRENCHES OFFSET

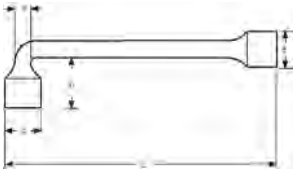
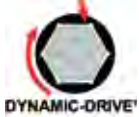

- Double head socket wrench, offset in metric sizes
- Standards: ISO 2236
- Material: High performance alloy steel
- 6 points Dynamic-Drive Profile in offset ring
- 6 points Dynamic-Drive Profile in straight ring
- Go through in offset and deep socket in straight side to use even for long thread bar
- Chrome plated micro matt finishing provides high quality surface

	 731415		 mm	L mm	h mm	d mm	e Ø mm	 g
29M-6	0122271	5	6	97	17	10	6	42
29M-7	0122288	5	7	105	19	11	7	44
29M-8	0122295	5	8	115	21	12	8	77
29M-9	0122301	5	9	126	22	13	9	86
29M-10	0122318	5	10	136	25	15	10	102
29M-11	0122325	5	11	145	28	16.5	11	116
29M-12	0122332	5	12	157	29	17.5	12	165
29M-13	0122349	5	13	168	31	19	13	181
29M-14	0122356	5	14	178	33	20.5	14	258
29M-15	0122363	5	15	187	36	21.5	15	276
29M-16	0122370	5	16	200	38	23	16	370
29M-17	0122387	5	17	208	40	24.5	17	410
29M-18	0122394	3	18	220	42	25.5	18	436
29M-19	0122400	3	19	232	43	27	19	464
29M-20	0122417	3	20	243	46	28	20	585
29M-21	0122424	3	21	252	48	29.5	21	644
29M-22	0122431	3	22	266	50	31	22	695
29M-23	0122448	3	23	278	52	32.5	23	745
29M-24	0122455	3	24	288	55	33.5	24	933
29M-25	0122462	3	25	299	58	35	25	988
29M-26	0122479	3	26	312	60	36.5	26	1044
29M-27	0122486	3	27	323	61	37	27	1091
29M-28	0122493	1	28	334	64	39	28	1318
29M-29	0122509	1	29	345	66	40	29	1357
29M-30	0122516	1	30	357	68	41	30	1398
29M-32	0122523	1	32	381	72	44	32	1606

29M/

DOUBLE HEAD SOCKET WRENCHES OFFSET



- Set of double head socket wrench, offset
- Packaging: In cardboard box

	 731415		 g
29M/8	0122530	1	1850
29M/10	0122547	1	2060
29M/14	0122554	1	4000
29M/8	8, 10, 12, 13, 14, 17, 19, 22 mm		
29M/10	8, 10, 11, 12, 13, 14, 16, 17, 18, 19 mm		
29M/14	8, 9, 10, 11, 12, 13, 14, 16, 17, 19, 21, 22, 23, 24 mm		



1936M

DOUBLE HEAD SOCKET WRENCHES



- Double head socket wrench in metric sizes
- Standards: DIN 896-B
- Material: Special steel of chrome-molybdenum
- Tubular, straight
- Chrome plated micro matt finishing provides high quality surface

	 731415		 mm	L mm	d1 mm	d2 mm	 mm	 g
1936M-6-7	1051389	5	6x7	102	10.0	11.0	6	25
1936M-8-9	1051396	5	8x9	102	13.0	14.0	6	35
1936M-8-10	1830137	5	8x10	117	13.5	16.0	6	65
1936M-10-11	1051402	5	10x11	117	16.0	17.0	8	65
1936M-10-13	1344146	5	10x13	137	16.0	20.0	8	95
1936M-12-13	1051419	5	12x13	137	19.0	20.0	8	95
1936M-13-17	1830144	5	13x17	147	20.5	25.5	10	160
1936M-14-15	1051426	5	14x15	137	21.0	22.5	8	95
1936M-14-17	1051129	5	14x17	147	21.5	25.5	10	160
1936M-16-17	1051433	5	16x17	147	24.0	25.5	10	160
1936M-17-19	1051136	5	17x19	152	25.5	28.0	12	180
1936M-18-19	1051440	5	18x19	152	26.5	28.0	12	180
1936M-19-22	1051150	5	19x22	162	28.0	31.5	12	215
1936M-20-22	1830151	5	20x22	162	29.0	31.5	12	215
1936M-21-23	1830168	5	21x23	162	30.5	33.0	14	265
1936M-22-24	1830175	5	22x24	177	32.0	34.5	14	285
1936M-24-26	1830182	5	24x26	177	34.5	37.0	14	350
1936M-24-27	1051181	5	24x27	177	34.5	38.0	14	350
1936M-25-28	1830199	1	25x28	192	35.5	39.0	16	380
1936M-30-32	1051501	1	30x32	192	41.5	44.0	16	450
1936M-30-34	1838577	1	30x34	210	40.5	44.0	16	502
1936M-36-41	1830205	1	36x41	213	50.0	56.0	18	730
1936M-46-50	1830212	1	46x50	233	62.0	66.5	20	950

1936M/

DOUBLE HEAD SOCKET WRENCHES



- Set of double head socket wrench
- Packaging: Cardboard box

	 731415		 g
1936M/7	1830243	1	1185
1936M/12	1830250	1	2685
1936M/7	26S-610, 26S-1216, 8x9, 10x11, 12x13, 14x15, 16x17, 18x19, 20x22 mm		
1936M/12	26S-610, 26S-1216, 6x7, 8x9, 10x11, 12x13, 14x15, 16x17, 18x19, 20x22, 21x23, 24x27, 25x28, 30x32 mm		



TUBULAR WRENCHES

27M

DOUBLE HEAD SOCKET WRENCHES



- Double head socket wrench in metric sizes
- Standards: UNE 16586
- Material: High performance alloy steel
- Hardness: 42-48 Hrc
- With hole to locate stud
- 6 points Dynamic-Drive Profile provides longer life for screws and nuts
- Sizes marked with * in the table have a hole along the shank
- Chrome plated micro matt finishing provides high quality surface
- SB = Retail pack on a plastic info card

	 731415		 mm	L mm	d1 mm	d2 mm	 g
27M-6-7	0180509	10	6x7	103	10.0	11.0	31
27M-8-9	0180516	10	8x9	108	12.5	13.5	53
27M-10-11	0180523	10	10x11	120	15.0	16.0	78
27M-12-13	0180547	10	12x13	138	17.0	19.0	127
27M-13-17	0180790	10	13x17*	153	20	24	176
27M-14-15	0180554	10	14x15	143	20.0	21.0	152
27M-16-17	0180561	10	16x17*	153	22.0	24.0	185
27M-16-18	0180806	10	16x18*	158	24.0	25.0	219
27M-18-19	0180578	10	18x19*	163	25.0	26.0	235
27M-20-22	0180585	10	20x22*	173	28.0	30.0	312
27M-21-23	0180592	5	21x23*	183	29.0	31.0	359
27M-21-24	0180813	5	21x24*	183	30.0	33.0	391
27M-24-26	0180608	5	24x26*	193	33.0	35.0	438
27M-24-27	0180820	5	24x27*	193	33.0	37.0	466
27M-25-28	0180622	5	25x28*	203	34.0	37.0	535
27M-27-29	0180639	5	27x29*	592	37.0	39.0	592
27M-30-32	0180646	5	30x32*	208	40.0	43.0	737
SB27M-6-7	0180837	10	6x7	103	10.0	11.0	31
SB27M-8-9	0180844	10	8x9	108	12.5	13.5	53
SB27M-10-11	0180851	10	10x11	120	15.0	16.0	78
SB27M-12-13	0180868	10	12x13	138	17.0	19.0	127
SB27M-14-15	0180875	10	14x15	143	20.0	21.0	152
SB27M-16-17	0180882	10	16x17*	153	22	24	185
SB27M-18-19	0180899	10	18x19*	163	25.0	26.0	235
SB27M-20-22	0180905	10	20x22*	173	28.0	30.0	312
SB27M-21-23	0180912	5	21x23*	183	29.0	31.0	359
SB27M-24-26	0180929	5	24x26*	193	33.0	35.0	438

27M/

DOUBLE HEAD SOCKET WRENCHES



- Set of double head socket wrench
- Packaging: In cardboard box

	 731415		 g
27M/6	0180653	1	650
27M/8	0180660	1	1206
27M/10	0180677	1	2000
27M/12	0180684	1	3270
27M/6	6x7, 8x9, 10x11, 12x13, 14x15, 16x17 mm		
27M/8	6x7, 8x9, 10x11, 12x13, 14x15, 16x17, 18x19, 20x22 mm		
27M/10	6x7, 8x9, 10x11, 12x13, 14x15, 16x17, 18x19, 20x22, 21x23, 24x26 mm		
27M/12	6x7, 8x9, 10x11, 12x13, 14x15, 16x17, 18x19, 20x22, 21x23, 24x26, 25x28, 30x32 mm		



27M/T



DOUBLE HEAD SOCKET WRENCHES

- Set of double head socket wrench
- Packaging: In plastic pouch

	 731415		 g
27M/8T	0180776	1	1310
27M/12T	0180783	1	3350

27M/8T	6x7, 8x9, 10x11, 12x13, 14x15, 16x17, 18x19, 20x22 mm	
27M/12T	6x7, 8x9, 10x11, 12x13, 14x15, 16x17, 18x19, 20x22, 21x23, 24x26, 25x28, 30x32 mm	

26S



STEPPED TOMMY BAR

- Stepped tommy bar
- Material: High performance alloy steel
- Chrome plated micro matt finishing provides high quality surface

	 731415		 mm	 mm	 g
26S-610	1830229	1	6 8 10	195	110
26S-1216	1830236	1	12 14 16	390	585

4040M



FLEX-HEAD WRENCHES

- Double ended flex-head wrenches with double hexagon sockets in metric sizes
- Material: High performance alloy steel
- Chrome plated micro matt finishing provides high quality surface
- 12 points Dynamic-Drive Profile provides longer life for screws and nuts
- Both heads 180° swivelling. New design of the sockets for better accessibility
- Retail packed on a plastic card

	 731415		 mm	 mm	 mm	 mm	 g
4040M-6-7	1831967	1	6x7	192	9.1	10.3	77
4040M-8-9	1078270	1	8x9	194	11.6	12.8	78
4040M-10-11	1078287	1	10x11	199	14.1	15.3	87
4040M-10-13	3000750	1	10x13	221	14.1	17.8	155
4040M-12-13	1078294	1	12x13	224	16.6	17.8	160
4040M-13-17	1804565	1	13x17	249	17.8	22.8	198
4040M-14-15	1078300	1	14x15	249	19.1	20.3	198
4040M-16-17	1078317	1	16x17	253	21.6	22.8	209
4040M-16-18	1839635	1	16x18	279	21.6	24.2	298
4040M-17-19	1804572	1	17x19	280	22.8	25.3	312
4040M-18-19	1078324	1	18x19	303	24.2	25.3	393
4040M-20-22	1078331	1	20x22	305	26.6	29.1	403
4040M-21-23	1078348	1	21x23	306	27.8	30.5	490
4040M-24-27	1831974	1	24x27	333	31.8	36.7	648



TUBULAR WRENCHES

4040M/6T



FLEX-HEAD WRENCHES

- Set of double ended flex-head wrenches with double hexagon sockets
- Packaging: In black plastic wallet with Velcro® fastening

	 731415			 g
4040M/6T	0112197	1	6	1220

4040M/6T 8x9, 10x11, 12x13, 14x15, 16x17, 18x19 mm



4040M/S6



FLEX-HEAD WRENCHES

- Set of double ended flex-head wrenches with double hexagon sockets
- Packaging: On functional black plastic wall holder

	 731415			 g
4040M/S6	0112180	1	6	1250

4040M/S6 8x9, 10x11, 12x13, 14x15, 16x17, 18x19 mm



4040Z



FLEX-HEAD WRENCHES

- Double ended flex-head wrenches with double hexagon sockets in inch sizes
- Material: High performance alloy steel
- Chrome plated micro matt finishing provides high quality surface
- 12 points Dynamic-Drive Profile provides longer life for screws and nuts
- Both heads 180° swivelling. New design of the sockets for better accessibility
- Retail packed on a plastic card



	 731415		 mm	L mm	D1 mm	D2 mm	 g
4040Z-3/8-7/16	1831981	1	3/8x7/16	199	13.5	15.5	87
4040Z-1/2-9/16	1831998	1	1/2x9/16	248	17.5	19.5	175
4040Z-5/8-11/16	1832001	1	5/8x11/16	253	21.4	23.4	209
4040Z-5/8-3/4	3001023	1	5/8x3/4	280	21.6	25.3	307







S50

FLEX-HEAD WRENCHES



- Double ended flex-head wrenches with double hexagon sockets in metric sizes
- Finish: Forged, nickel and matt chrome-plated
- Both heads 180° swivelling
- With Dynamic-Drive-Profile
- SB = Retail packed on plastic card



	 731415		 mm	L mm	D1 mm	D2 mm	 g
SBS50-8-9	3009326	1	8 x 9	168	9.1	10.3	77
SBS50-10-11	3009333	1	10 x 11	199	14.1	15.3	87
SBS50-12-13	3009340	1	12 x 13	224	16.6	17.8	160
SBS50-14-15	3009357	1	14 x 15	249	19.1	20.3	198
SBS50-16-17	3009364	1	16 x 17	253	21.6	22.8	209
SBS50-18-19	3009371	1	18 x 19	303	24.2	25.3	393
SBS50-20-22	3009388	1	20 x 22	305	26.6	29.1	403
SBS50-21-23	3009395	1	21 x 23	306	27.8	30.5	490



SPECIAL WRENCHES

4106

HOOK WRENCHES

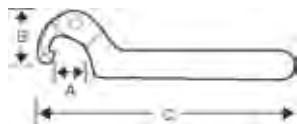

- Adjustable hook wrench
- Material: High performance alloy steel
- Flex head with hook to adapt for different diameters of collars, rings and bearings
- Chrome plated micro matt finishing provides high quality surface

	 731415		A mm	B mm	C mm	 g
4106-35-60	0213771	1	35-60	31	175	100
4106-60-90	0213788	1	60-90	50	250	280
4106-90-155	0213795	1	90-155	70	290	460

40B

HOOK WRENCHES

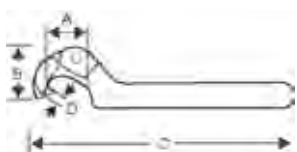

- Adjustable pin wrench to remove rings, collars and lock nuts
- Material: High performance alloy steel
- When in use, make sure jaw hook is properly positioned
- Chrome plated micro matt finishing provides high quality surface

	 731415		A mm	B mm	C mm	D mm	 g
40B-22-35	0214563	1	22-35	20	135	2.3	50
40B-35-60	0213726	1	35-60	31	175	3.0	100
40B-60-90	0213733	1	60-90	50	250	4.8	280
40B-95-155	0214570	1	95-155	70	290	5.8	460
40B-165-230	0214587	1	165-230	114	420	7.8	1000

4307/4310

PIN WRENCH, ADJUSTABLE

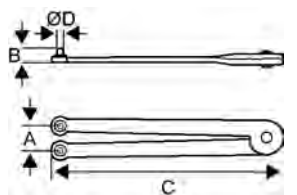

- Adjustable pin wrench
- For two-hole nuts DIN 547
- 4307 with capacity 50 mm and pin 3.8 mm
- 4310 with capacity 100 mm and pin 7.0 mm
- Material: High performance alloy steel
- Chrome plated micro matt finishing provides high quality surface

	 731151		A mm	B mm	C mm	D mm	 g
4307	1079444	1	10 - 50	11	160	3.8	190
4310	1079451	1	22 - 100	17	250	7.0	375



SOCKETS & ACCESSORIES

Bahco offers a broad range of sockets, ratchets and accessories covering the many requirements of professional users.

With more than 125 years' experience, Bahco has acquired unique specialist knowledge in the development of hand tools. The alloying of steel, combined with meticulous heat treatment produces the toughness, hardness and wear-resistance characteristic to all Bahco tools.

In co-operation with world-leading ergonomic specialists, Bahco has developed our special range of ERGO™ ratchets for the most demanding situations.



Chapter Index

SOCKETS 1/4"	202-207
SOCKET DRIVERS 1/4"	207-210
ACCESSORIES 1/4"	210-217
SOCKET SETS 1/4"	218-226
SOCKETS 3/8"	227-232
SOCKET DRIVERS 3/8"	232-235
ACCESSORIES 3/8"	235-244
SOCKET SETS 3/8"	244-248
SOCKETS 1/2"	249-253
SOCKET DRIVERS 1/2"	254-257
ACCESSORIES 1/2"	258-269
SOCKET SETS 1/2"	269-277
SOCKETS 3/4"	277-278
ACCESSORIES 3/4"	279-284
SOCKET SETS 3/4"	284-285
SOCKETS 1"	286
ACCESSORIES 1"	287-289
SOCKET SETS 1"	289-291
SOCKET SETS	291-307



SOCKETS

Dynamic-Drive™ Profile

All Bahco hexagon and double hexagon sockets have our Dynamic-Drive™ Profile to protect the nuts, screws and tools from unnecessary wear and damage. The profile has rounded corners and

additional flank areas that transmit torque onto the screw head or nut. The additional flank area moves pressure from the nut and screw corners to the sturdier side areas to give maximum load distribution and torque.

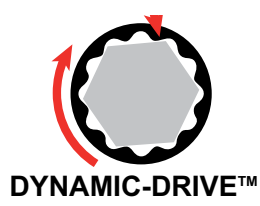
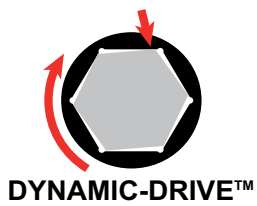

The superiority of Bahco sockets is the result of exacting tolerances as well as extraordinary high resistance to wear.



RATCHETS



ERGO™ RATCHETS



Bahco ERGO™ ratchets are developed in accordance with Bahco ERGO™ Process.

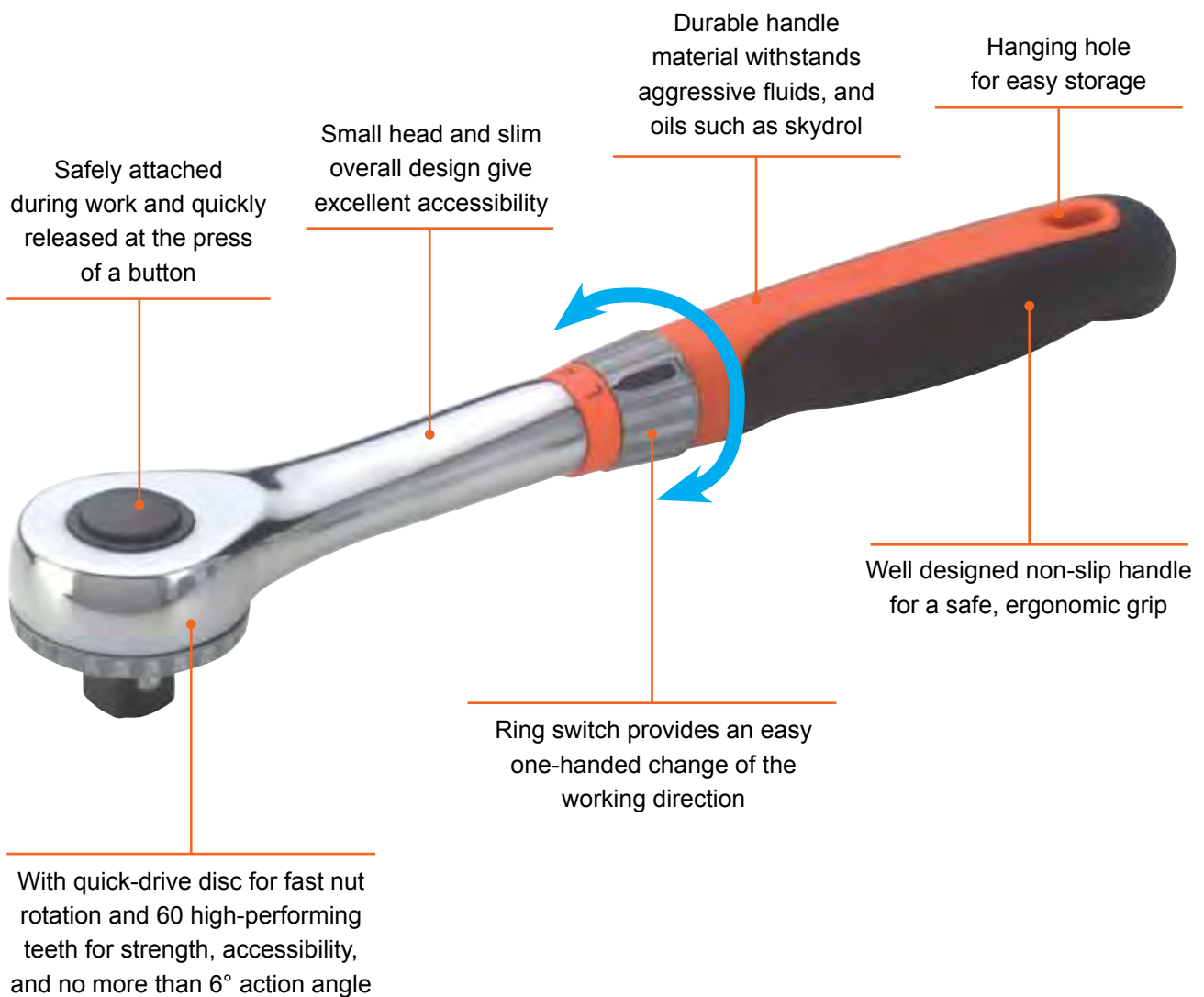

SOCKET SETS

Bahco socket sets are all equipped with qualitative tools, available in plastic or metal cases that are both shock-proof and resistant to extreme temperatures. The sets are available as small, basic sets as well as large combined socket and wrench sets designed to fulfil the most demanding jobs. All tools are made of high-performance alloy steel and comply with ISO/DIN standards.





SOCKETS 1/4"

6700SM

HEXAGON METRIC

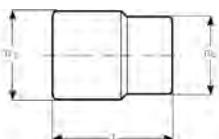

- Standard length sockets, 1/4" square drive
- Hex profile, metric sizes
- Not suitable for machine operation
- High performance alloy steel
- High polished finish
- Knurled
- ISO 2725/1174
- DIN 3124/3120
- SB = Retail packed on a plastic info card

	 731415		 mm	L mm	D1 mm	D2 mm	 g
6700SM-4	1087944	5	4	24.7	6.8	11.9	9
6700SM-4.5	1087951	5	4.5	24.7	7.4	11.9	10
6700SM-5	1087968	5	5	24.7	8.1	11.9	10
6700SM-5.5	1087975	5	5.5	24.7	8.7	11.9	10
6700SM-6	1087982	5	6	24.7	9.3	11.9	10
6700SM-7	1087999	5	7	24.7	10.8	11.9	12
6700SM-8	1088002	5	8	24.7	11.9	11.9	12
6700SM-9	1088019	5	9	24.7	13.4	12.4	12
6700SM-10	1088026	5	10	24.7	14.5	13	15
6700SM-11	1088033	5	11	24.7	15.9	14.1	18
6700SM-12	1088040	5	12	24.7	16.9	15	18
6700SM-13	1088057	5	13	24.7	18	15.6	20
6700SM-14	1088064	5	14	24.7	19.6	16	22
SB6700SM-4	0104307	1	4	24.7	6.8	11.9	9
SB6700SM-4.5	0104314	1	4.5	24.7	7.4	11.9	10
SB6700SM-5	0104321	1	5	24.7	8.1	11.9	10
SB6700SM-5.5	0104338	1	5.5	24.7	8.7	11.9	10
SB6700SM-6	0104345	1	6	24.7	9.3	11.9	10
SB6700SM-7	0104352	1	7	24.7	10.8	11.9	12
SB6700SM-8	0104369	1	8	24.7	11.9	11.9	12
SB6700SM-9	0104376	1	9	24.7	13.4	12.4	12
SB6700SM-10	0104383	1	10	24.7	14.5	13	15
SB6700SM-11	0104390	1	11	24.7	15.9	14.1	18
SB6700SM-12	0104406	1	12	24.7	16.9	15	18
SB6700SM-13	0104413	1	13	24.7	18	15.6	20
SB6700SM-14	0104420	1	14	24.7	19.6	16	22



A6800DM

DOUBLE HEXAGON LONG SERIES METRIC

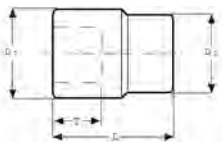

- Deep length sockets, 1/4" square drive
- Bi-hex profile, metric sizes
- Not suitable for machine operation
- High performance alloy steel
- High polished finish
- Knurled
- ISO 2725-1/1174-1
- DIN 3120
- Thin-walled
- These sockets are applicable to nuts and bolts used in the aerospace industry

	 731415		 mm	L mm	D1 mm	D2 mm	T mm	 g
A6800DM-4	1821777	1	4	50.6	6.7	12.1	4.6	16
A6800DM-5	1821784	1	5	50.6	7.7	12.1	5.1	20
A6800DM-5.5	1821791	1	5.5	50.6	8.3	12.1	5.3	19
A6800DM-6	1821807	1	6	50.6	9.3	12.1	5.9	21
A6800DM-7	1821814	1	7	50.6	10.5	12.1	6.6	25
A6800DM-8	1821821	1	8	50.6	11.5	12.1	8.1	26
A6800DM-9	1821838	1	9	50.6	12.7	12.1	8.1	30
A6800DM-10	1821845	1	10	50.6	14.0	12.1	9.7	33
A6800DM-11	1821852	1	11	50.6	15.4	13.1	11.2	41
A6800DM-12	1821869	1	12	50.6	16.5	14.0	12.7	33
A6800DM-13	1821876	1	13	50.6	17.6	15.0	12.7	53
A6800DM-14	1821883	1	14	50.6	18.8	16.0	15.8	58

6700SZ

HEXAGON INCH

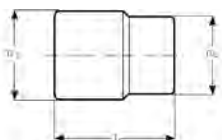

- Standard length sockets, 1/4" square drive
- Hex profile, inch sizes
- Not suitable for machine operation
- High performance alloy steel
- High polished finish
- Knurled
- ISO 2725/1174
- DIN 3124/3120

	 731415		 "	L mm	D1 mm	D2 mm	 g
6700SZ-5/32	1808556	5	5/32	24.7	6.8	11.9	9
6700SZ-3/16	1088118	5	3/16	24.7	7.9	11.9	10
6700SZ-7/32	1088125	5	7/32	24.7	8.9	11.9	10
6700SZ-1/4	1088132	5	1/4	24.7	9.9	11.9	11
6700SZ-9/32	1088149	5	9/32	24.7	11	11.9	12
6700SZ-5/16	1088156	5	5/16	24.7	11.9	11.9	12
6700SZ-11/32	1088163	5	11/32	24.7	13	12.4	13
6700SZ-3/8	1088170	5	3/8	24.7	14.5	13	16
6700SZ-7/16	1088187	5	7/16	24.7	15.9	14.1	16
6700SZ-1/2	1088194	5	1/2	24.7	17.6	15.2	23
6700SZ-9/16	1088200	5	9/16	24.7	19.6	16.0	29



SOCKETS 1/4"

A6700DM

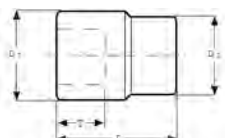

DOUBLE HEXAGON

- Standard length sockets, 1/4" square drive
- Bi-hex profile, metric sizes
- Not suitable for machine operation
- High performance alloy steel
- High polished finish
- Knurled
- ISO 2725/1174
- DIN 3124/3120
- Thin-walled
- These sockets are applicable to nuts and bolts used in the aerospace industry

	 731415		 mm	L mm	D1 mm	D2 mm	T mm	 g
A6700DM-5.5	1821678	5	5.5	24.7	8.7	11.9	8	10
A6700DM-6	1821685	5	6	24.7	9.3	11.9	8	10
A6700DM-7	1821692	5	7	24.7	10.8	11.9	8	10
A6700DM-8	1821708	5	8	24.7	11.9	11.9	8	11
A6700DM-9	1821715	5	9	24.7	13.4	12.4	8	14
A6700DM-10	1821722	5	10	24.7	14.5	13	9	15
A6700DM-11	1821739	5	11	24.7	15.9	14.1	11.5	18
A6700DM-12	1821746	5	12	24.7	16.9	15	11.5	20
A6700DM-13	1821753	5	13	24.7	18	15.6	11.5	25
A6700DM-14	1821760	5	14	24.7	19.6	16	11.5	27

A6700DZ

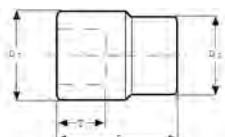

DOUBLE HEXAGON

- Standard length sockets, 1/4" square drive
- Bi-hex profile, inch sizes
- Not suitable for machine operation
- High performance alloy steel
- High polished finish
- Knurled
- ISO 2725/1174
- DIN 3124/3120
- Thin-walled
- These sockets are applicable to nuts and bolts used in the aerospace industry

	 731415		 "	L mm	D1 mm	D2 mm	T mm	 g
A6700DZ-3/16	1751029	5	3/16	24.7	7.9	11.9	7.5	10
A6700DZ-7/32	1751296	5	7/32	24.7	8.9	11.9	8	10
A6700DZ-1/4	1751371	5	1/4	24.7	9.9	11.9	8	10
A6700DZ-9/32	1751456	5	9/32	24.7	11	11.9	8	10
A6700DZ-5/16	1751531	5	5/16	24.7	11.9	11.9	8	10
A6700DZ-11/32	1819842	5	11/32	24.7	13	12.4	8	10
A6700DZ-3/8	1751616	5	3/8	24.7	14.5	13	9	16
A6700DZ-7/16	1819859	5	7/16	24.7	15.9	14.1	11.5	25
A6700DZ-1/2	1751883	5	1/2	24.7	17.6	15.2	11.5	27
A6700DZ-9/16	1751968	5	9/16	24.7	19.6	16	11.5	28



A6710DM

DOUBLE HEXAGON

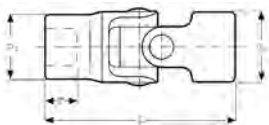

- Swivel sockets, 1/4" square drive
- Bi-hex profile, metric sizes
- Not suitable for machine operation
- High performance alloy steel
- High polished finish
- ISO 1174
- DIN 3120
- Thin-walled
- These sockets are applicable to nuts and bolts used in the aerospace industry

	 731415		 mm	L mm	D1 mm	D2 mm	T mm	 g
A6710DM-5.5	1756178	1	5.5	30.5	8.4	12	5.5	15
A6710DM-6	1756253	1	6	31.0	9.0	12	6.0	16
A6710DM-7	1756338	1	7	32.0	10.3	12	6.5	18
A6710DM-8	1756413	1	8	33.0	11.5	12	7.0	20
A6710DM-9	1756680	1	9	34.5	12.8	12	8.0	21
A6710DM-10	1756765	1	10	35.5	14.0	12	9.0	25
A6710DM-11	1756840	1	11	37.0	15.3	12	10.0	30
A6710DM-12	1756925	1	12	38.0	16.5	12	11.0	33
A6710DM-13	1757069	1	13	39.5	17.8	12	12.0	36
A6710DM-14	1757144	1	14	40.5	19.0	12	12.5	40

A6710DZ

DOUBLE HEXAGON

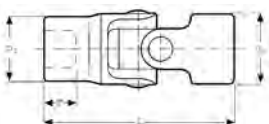

- Swivel sockets, 1/4" square drive
- Bi-hex profile, inch sizes
- Not suitable for machine operation
- High performance alloy steel
- High polished finish
- ISO 1174
- DIN 3120
- Thin-walled
- These sockets are applicable to nuts and bolts used in the aerospace industry

	 731415		 "	L mm	D1 mm	D2 mm	T mm	 g
A6710DZ-3/16	1820435	1	3/16	30.5	7.5	12	5.0	12
A6710DZ-7/32	1820442	1	7/32	30.5	8.5	12	5.5	12
A6710DZ-1/4	1757229	1	1/4	31.0	9.5	12	6.0	12
A6710DZ-9/32	1820459	1	9/32	32.0	10.5	12	6.5	12
A6710DZ-5/16	1757496	1	5/16	33.0	11.5	12	7.0	12
A6710DZ-11/32	1757571	1	11/32	34.5	12.5	12	8.0	13
A6710DZ-3/8	1757656	1	3/8	35.0	13.5	12	8.5	14
A6710DZ-7/16	1757731	1	7/16	37.0	15.4	12	10.0	16
A6710DZ-1/2	1820466	1	1/2	39.0	17.4	12	11.5	25
A6710DZ-9/16	1820473	1	9/16	40.5	19.4	12	12.5	30



SOCKETS 1/4"

A6800DZ

DOUBLE HEXAGON LONG SERIES INCH

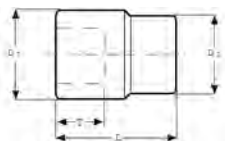

- Deep length sockets, 1/4" square drive
- Bi-hex profile, inch sizes
- Not suitable for machine operation
- High performance alloy steel
- High polished finish
- Knurled
- ISO 2725-1/1174-1
- DIN 3120
- Thin-walled
- These sockets are applicable to nuts and bolts used in the aerospace industry

	 731415			L mm	D1 mm	D2 mm	T mm	 g
A6800DZ-3/16	1758035	1	3/16	50.6	7.7	12.1	5.1	21
A6800DZ-7/32	1758110	1	7/32	50.6	8.5	12.1	5.3	21
A6800DZ-1/4	1758387	1	1/4	50.6	9.3	12.1	5.8	23
A6800DZ-9/32	1758462	1	9/32	50.6	10.5	12.1	6.6	21
A6800DZ-5/16	1758547	1	5/16	50.6	11.5	12.1	8.1	23
A6800DZ-11/32	1803872	1	11/32	50.6	12.6	12.1	8.1	25
A6800DZ-3/8	1758622	1	3/8	50.6	14.1	12.1	8.1	28
A6800DZ-7/16	1803889	1	7/16	50.6	15.4	13.0	11.2	30
A6800DZ-1/2	1758899	1	1/2	50.6	17.5	15.0	12.7	41
A6800DZ-9/16	1758974	1	9/16	50.6	18.8	16.0	12.7	49

S60

HEXAGON METRIC

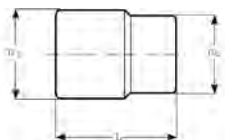

- Standard length sockets, 1/4" square drive
- Hex profile, metric sizes
- Not suitable for machine operation
- High performance alloy steel
- Matt finish
- ISO 2725/1174
- DIN 3124/3120
- SB = Retail packed on a plastic info card

	 731415			L mm	D1 mm	D2 mm	 g
SBS60-4	3009531	1	4	25.0	6.7	12.1	9
SBS60-4.5	3009548	1	4.5	25.0	7.2	12.1	10
SBS60-5	3009555	1	5	25.0	7.7	12.1	10
SBS60-5.5	3009562	1	5.5	25.0	8.3	12.1	10
SBS60-6	3009579	1	6	25.0	9.3	12.1	10
SBS60-7	3009586	1	7	25.0	10.5	12.1	12
SBS60-8	3009593	1	8	25.0	11.5	12.1	12
SBS60-9	3009609	1	9	25.0	12.7	12.1	12
SBS60-10	3009616	1	10	25.0	14.0	12.1	15
SBS60-11	3009623	1	11	25.0	15.4	13.1	18
SBS60-12	3009630	1	12	25.0	16.5	14.0	18
SBS60-13	3009647	1	13	25.0	17.6	15.0	20
SBS60-14	3009654	1	14	25.0	18.8	16.0	22



6700TORX-E

TORX®-E

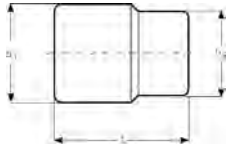

- TORX® sockets, 1/4" square drive
- For TORX® head screws
- Not suitable for machine operation
- High performance alloy steel
- High polished finish
- Knurled
- ISO 2725/1174
- DIN 3124/3120

	 731415			L mm	D1 mm	D2 mm		 g
6700TORX-E4	3011671	5	E4	25	5.4	12	M3	9
6700TORX-E5	3011688	5	E5	25	6.7	12	M4	9
6700TORX-E6	3011695	5	E6	25	7.7	12	M5	10
6700TORX-E7	3011701	5	E7	25	8.3	12	M6	10
6700TORX-E8	3011718	5	E8	25	9.6	12	M5+M6	10
6700TORX-E10	3011725	5	E10	25	11.3	12	M6+M8	12

SOCKET DRIVERS 1/4"



6709F

FOR SLOTTED SCREWS

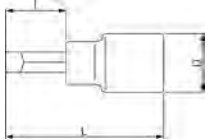

- 1/4" square drive socket drivers, for slotted head screws
- Not suitable for machine operation
- High performance alloy steel
- High polished finish
- Knurled
- ISO 1174
- DIN 3120

	 731415		L mm	I mm	 mm	 mm	D mm	 g
6709F-4.5	1830762	5	36	16	0.6	4.5	12.0	9
6709F-5.5	1830779	5	36	16	0.8	5.5	12.0	11
6709F-8	1830786	5	36	16	1.2	8.0	12.0	12

6709PH

FOR PHILLIPS HEAD SCREWS

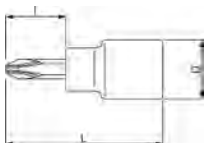

- 1/4" square drive socket drivers, for Phillips head screws
- Not suitable for machine operation
- High performance alloy steel
- High polished finish
- Knurled
- ISO 1174
- DIN 3120

	 731415			I mm	L mm	D mm	 g
6709PH-1	1830700	5	1	16	36	12.0	11
6709PH-2	1830717	5	2	16	36	12.0	12
6709PH-3	1830724	5	3	16	36	12.0	12



SOCKET DRIVERS 1/4"

6709PZ

FOR POZIDRIV HEAD SCREWS

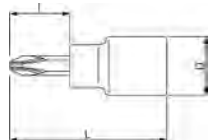

- 1/4" square drive socket drivers, for Pozidriv head screws
- Not suitable for machine operation
- High performance alloy steel
- High polished finish
- Knurled
- ISO 1174
- DIN 3120

	 731415			I mm	L mm	D mm	 g
6709PZ-1	1830731	5	1	16	36	12.0	11
6709PZ-2	1830748	5	2	16	36	12.0	12
6709PZ-3	1830755	5	3	16	36	12.0	12

6709TORX

FOR TORX® HEAD SCREWS

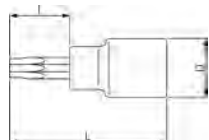

- 1/4" square drive socket drivers, for TORX® head screws
- Not suitable for machine operation
- High performance alloy steel
- High polished finish
- Knurled
- ISO 1174
- DIN 3120

	 731415			I mm	L mm	D mm		 g
6709TORX-T8	3002440	5	T-8	16	36	12.0	M2.5	10
6709TORX-T9	1811662	5	T-9	16	36	12.0	-	10
6709TORX-T10	1811679	5	T-10	16	36	12.0	M3	10
6709TORX-T15	1811686	5	T-15	16	36	12.0	M3.5	12
6709TORX-T20	1811693	5	T-20	16	36	12.0	M4	12
6709TORX-T25	1811709	5	T-25	16	36	12.0	M5	15
6709TORX-T27	1811716	5	T-27	16	36	12.0	-	15
6709TORX-T30	1811723	5	T-30	16	36	12.0	M6	15
6709TORX-T40	3002457	5	T-40	16	36	12.0	M8	15

6709TORX-R

FOR TORX® HEAD SCREWS

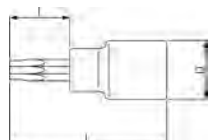

- 1/4" square drive socket drivers, for TORX® head screws, tamper resistant
- Not suitable for machine operation
- High performance alloy steel
- High polished finish
- Knurled
- ISO 1174
- DIN 3120

	 731415			I mm	L mm	D mm		 g
6709TORX-R-T8	3002464	1	TR 8	16	36	12.0	0.5	10
6709TORX-R-T10	3002471	1	TR 10	16	36	12.0	M3	10
6709TORX-R-T15	3002488	1	TR 15	16	36	12.0	M4	12
6709TORX-R-T20	3002495	1	TR 20	16	36	12.0	M4	12
6709TORX-R-T25	3002501	1	TR 25	16	36	12.0	M5	12



6709M

HEX HEAD DRIVER, METRIC

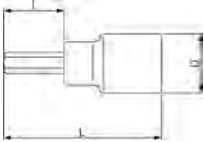

- 1/4" square drive socket drivers, for hex head screws
- Metric sizes
- Not suitable for machine operation
- High performance alloy steel
- High polished finish
- Knurled
- ISO 1174
- DIN 3120

	 731415		 mm	I mm	L mm	D mm	 g
6709M-3	1830656	5	3	16	36	12.0	10
6709M-4	1830663	5	4	16	36	12.0	10
6709M-5	1830670	5	5	16	36	12.0	11
6709M-6	1830687	5	6	16	36	12.0	12
6709M-8	1830694	5	8	16	36	12.0	13

A6709M

HEX HEAD DRIVERS, LONG METRIC

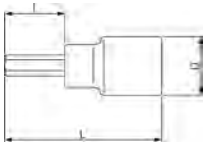

- 1/4" square drive socket drivers, long, for hex head screws
- Metric sizes
- Not suitable for machine operation
- High performance alloy steel
- High polished finish
- Knurled
- ISO 1174
- DIN 3120

	 731415		 mm	I mm	L mm	D mm	 g
A6709M-2.5	1753740	1	2.5	7.5	50.0	12.0	20
A6709M-3	1753825	1	3	8.5	50.0	12.0	20
A6709M-4	1754129	1	4	10.5	50.0	12.0	20
A6709M-5	1754471	1	5	12.5	50.0	12.0	20
A6709M-6	1754556	1	6	14.0	50.0	12.0	20

A6709Z

HEX HEAD DRIVERS, LONG INCH

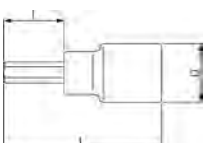

- 1/4" square drive socket drivers, long, for hex head screws
- Inch sizes
- Not suitable for machine operation
- High performance alloy steel
- High polished finish
- Knurled
- ISO 1174
- DIN 3120

	 731415		 "	I mm	L mm	D mm	 g
A6709Z-1/8	1755447	1	1/8	9.0	50.0	12.0	20
A6709Z-9/64	1755522	1	9/64	9.5	50.0	12.0	20
A6709Z-5/32	1755799	1	5/32	10.5	50.0	12.0	20
A6709Z-3/16	1755874	1	3/16	12.0	50.0	12.0	20



SOCKET DRIVERS 1/4"

6972H

ADAPTOR, BIT HOLDER

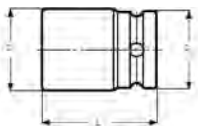

- 1/4" square drive bit holder
- For screwdriver bits with 1/4" male hexagon drive: DIN 3126-C 6,3 ISO 1173
- DIN 7427 Form A
- DIN 3121-G 6,3 ISO 1174
- High performance alloy steel
- With spring collar

6972H	731415 1215934	5	1/4"	1/4"	26.0	13.0	13.0	K560F-1	18



ACCESSORIES 1/4"

6950

REVERSIBLE RATCHET



- 1/4" ratchet, reversible
- 72 teeth/5° action angle
- High performance alloy steel
- High polished finish
- ISO 3315/1174-2; DIN 3122/3120; UNE 16512
- Sealed
- Smooth operation
- Double pawl system for superior strength
- Patented mechanism
- Spare parts available
- SB = Retail pack

6950	731415 1089641	1	120	115
SB6950	0104987	1	120	115

6950RN

REVERSIBLE RATCHET



- 1/4" ratchet, reversible
- 72 teeth/5° action angle
- High performance alloy steel
- High polished finish
- ISO 3315/1174-2
- DIN 3122/3120; UNE 16512
- Indicating arrow for turning direction - patented
- Spare parts available
- SB = Retail pack

6950RN	731415 1831189	1	120	95
SB6950RN	0104994	1	120	95



SBS61

REVERSIBLE RATCHET



- Reversible ratchet, 1/4" drive
- DIN 3122 and 3123. 1/4" 6.3 DIN 3120/ISO 1174
- Finish: Nickel and matt chrome plated
- Material: Vanadium-extra
- With plastic grip
- 60 teeth/6° action
- SB = Retail packed on a info plastic card

	 731415		 L mm	 g
SBS61	3009661	1	145	95

R6950

REVERSIBLE RATCHET



- 1/4" ratchet, for refrigeration shut-off valves
- 32 teeth/11.5° action angle
- High performance alloy steel
- High polished finish
- ISO 1174; DIN 3120
- Female squares in handle: 8.5, 9.5 (3/8"); 13 mm



	 731415		 L mm	 g
R6950	1089658	1	160	225

6951

RATCHET ADAPTOR



- 1/4" ratchet adaptor
- 60 teeth/6° action angle
- High performance alloy steel
- High polished finish
- Head diameter 23 mm

	 731415		 L mm	 g
6951	1089764	1	35	50

6952

SPEEDER



- 1/4" speeder, with rotary steel handle
- High performance alloy steel
- High polished finish
- ISO 3315/1174
- DIN 3122/3123/3120

	 731415		 L mm	 g
6952	1089771	1	410	270



ACCESSORIES 1/4"

6958

BREAKER BAR



- 1/4" breaker bar
- High performance alloy steel
- High polished finish
- ISO 3315/1174
- DIN 3122/3123/3120

	 731415		 L mm	 g
6958	1089849	1	153	95

S67

BREAKER BAR



- 1/4" breaker bar
- High performance alloy steel
- Matt finish
- ISO 3315/1174
- DIN 3122/3123/3120
- Retail pack

	 731415		 L mm	 g
SBS67	3089678	1	153	95

6954

SLIDING T-HANDLE



- 1/4" sliding T-handle
- High performance alloy steel
- High polished finish
- 100% sliding
- ISO 3315/1174
- DIN 3122/3123/3120; UNE 16512

	 731415		 L mm	 g
6954	1089795	1	115	40

S64

SLIDING T-HANDLE



- 1/4" sliding T-handle
- High performance alloy steel
- Matt finish
- ISO 3315/1174
- DIN 3122/3123/3120
- Retail pack

	 731415		 L mm	 g
SBS64	3012609	1	125	40



6956

SPINNER HANDLES



- 1/4" spinner handle
- Integrated 1/4" female square drive in the handle for use as extension bar or with a sliding T-handle
- High performance alloy steel
- High polished finish
- ISO 3315/1174
- DIN 3122/3123/3120; UNE 16512

	 731415		 L mm	 9
6956	1089825	1	150	102

6960 - 6962L

EXTENSION BARS



- 1/4" extension bars
- High performance alloy steel
- High polished finish
- ISO 3316/1174
- DIN 3122/3123/3120; UNE 16511
- SB = Retail packed on a plastic info card

	 731415		 L mm	 9
6960	1089856	1	50	23
6961	1089870	1	101	45
6962	1089894	1	152	65
6962L	1089917	1	355	158
SB6960	0104925	1	53	23
SB6961	0104932	1	101	45
SB6962	0104949	1	152	65

6960-W - 6962-W

EXTENSION BARS



- 1/4" wobbler extension bars
- High performance alloy steel
- High polished finish
- ISO 1174
- DIN 3120

	 731415		 L mm	 9
6960-W	3010506	1	50	36
6962-W	3010520	1	150	83



ACCESSORIES 1/4"

6963

EXTENSION BARS



- 1/4" flexible extension bar
- High performance alloy steel
- High polished finish
- Not designed for final tightening or initial loosening
- ISO 1174
- DIN 3120

	 731415		 L mm	 g
6963	1089931	1	148	45

S63

EXTENSION BARS



- 1/4" extension bars
- High performance alloy steel
- Matt finish
- ISO 3316/1174
- DIN 3122/3123/3120
- Retail pack

	 731415		 L mm	 g
SBS63-2	3009685	1	50	23
SBS63-4	3009692	1	100	45
SBS63-6	3009708	1	150	65

6966

UNIVERSAL JOINT



- 1/4" universal joint
- High performance alloy steel
- High polished finish
- ISO 3316/1174
- DIN 3122/3123/3120; UNE 16511

	 731415		 L mm	 g
6966	1089986	1	35	18



S65

UNIVERSAL JOINT



- 1/4" universal joint
- High performance alloy steel
- Matt finish
- ISO 3316/1174
- DIN 3122/3123/3120; UNE 16511
- Retail pack

	 731415		 mm	 g
SBS65	3009715	1	32.5	18

6968

UNIVERSAL JOINT



- 1/4" universal joint, smooth operation
- High performance alloy steel
- High polished finish
- ISO 3316/1174
- DIN 3122/3123/3120; UNE 16511
- Curved shapes give a very smooth movement transmission improving working efficiency
- Action spring for a correct fixing
- 45° action angle

	 731415		 mm	 g
6968	0128426	1	34	30

7765

ADAPTOR



- Increasing adaptor for 1/4" square drive and 3/8" socket
- High performance alloy steel
- High polished finish
- ISO 1174
- DIN 3120; UNE 16503

	 731415				 mm	 g
7765	1096687	1	1/4	3/8	25	25



ACCESSORIES 1/4"

S69

ADAPTOR



- Increasing adaptor for 1/4" square drive and 3/8" socket
- High performance alloy steel
- Matt finish
- ISO 1174
- DIN 3120; UNE 16503
- Retail pack

SBS69	731415	3009722	1	1/4"	3/8"	25	25

7767

ADAPTOR



- Increasing flat adaptor for 1/4" square drive and 3/8" socket
- High performance alloy steel
- Galvanised finish
- With magnet in the drive disc
- ISO 1174
- DIN 3120; UNE 16503

7767	731415	3003577	1	1/4"	3/8"	3.0	18

8967/

ADAPTOR SET



- Increasing flat adaptors set, 3 pcs
- Content: 7767, 8167 and 8967
- High performance alloy steel
- Galvanised finish
- With magnet in the drive disc
- ISO 1174
- DIN 3120; UNE 16503

8967/S3	731415	3003607	1	30x194x110	109

8967/S3 7767-8167-8967





6950-SPARE

SPARE PARTS ASSORTMENT



- Spare parts kit for 1/4" ratchet 6950

	 731415		
6950-SPARE	0187867	1	20

6950RN-SPARE

SPARE PARTS ASSORTMENT



- Spare parts kit for 1/4" ratchet 6950RN

	 731415		
6950RN-SPARE	0209149	1	20

187/264/340

SOCKET RAILS



- Socket rails in zinc coated metal with 2 holes for screws (-340 with 3 holes)
- Suitable for CLIPS-1/4 (1/4") CLIPS-3/8 (3/8") and CLIPS-1/2 (1/2")
- Fitting sockets or socket drivers, in the respective square size

	 731415		 L mm	
RAIL-187	3003621	3	187	15
RAIL-264	3003638	3	264	20
RAIL-340	3003645	3	340	30

C1/4

CLIPS



- Rail-clips for 1/4" sockets and socket drivers
- Nickel plated, spring metal
- To be used on RAIL-187, -264 or -340

	 731415		 L mm	
CLIPS-1/4	3003188	25	19	1



SOCKET SETS 1/4"

6712R



SOCKET SETS

- 1/4" socket set
- High performance alloy steel
- High polished finish
- Metal case
- Insert of elastic plastic material to secure the tools
- ISO 1174
- DIN 3120

	 731415		 mm	 g
6712R	1838225	1	178x108x31	835

6700SM 4, 5, 5.5, 6, 7, 8, 10, 11, 13 mm			6950	
6960 50 mm			6962 150 mm	

6712RN



SOCKET SETS

- 1/4" socket set
- High performance alloy steel
- High polished finish
- Metal case
- Insert of elastic plastic material to secure the tools
- ISO 1174
- DIN 3120

	 731415		 mm	 g
6712RN	1838232	1	178x108x31	835

6700SM 4, 5, 5.5, 6, 7, 8, 10, 11, 13 mm			6950RN	
6960 50 mm			6962 150 mm	

A6716DM



SOCKET SETS

- 1/4" socket set
- High performance alloy steel
- High polished finish
- Metal case
- Insert of elastic plastic material to secure the tools
- ISO 1174
- DIN 3120

	 731415		 mm	 g
A6716DM	1820824	1	223x113x41	1175

A6700DM 5.5, 6, 7, 8, 9, 10, 11, 12, 13, 14 mm			6950	
6956			6954	
6962 150 mm			6966	



6715MGS



SOCKET SETS

- 1/4" socket set
- High performance alloy steel
- High polished finish
- Metal case
- Insert of elastic plastic material to secure the tools
- ISO 1174
- DIN 3120

	 731415		 mm	 g
6715MGS	1831332	1	223x113x41	1105
6700SM 4, 4.5, 5, 5.5, 6, 7, 8, 9, 10, 11, 13 mm			6950RN	
6956		6954		
6962 150 mm		6966		

6719SM



SOCKET SETS

- 1/4" socket set
- High performance alloy steel
- High polished finish
- Metal case
- Insert of elastic plastic material to secure the tools
- ISO 1174
- DIN 3120

	 731415		 mm	 g
6719SM	1820817	1	223x113x41	1175
6700SM 4, 4.5, 5, 5.5, 6, 7, 8, 9, 10, 11, 12, 13 mm			6950	
6956		6954		
6962 150 mm		6966		



SOCKET SETS 1/4"

6715MG

SOCKET SETS



- 1/4" socket set
- High performance alloy steel
- High polished finish
- Metal case
- Insert of elastic plastic material to secure the tools
- ISO 1174
- DIN 3120

	 731415		 mm	 g
6715MG	1831349	1	223x113x41	1330
6700SM 4, 4.5, 5, 5.5, 6, 7, 8, 9, 10, 11, 12, 13, 14 mm			6950RN	
6958		6956		
6954		6960 50 mm		
6962 150 mm		6966		

6721NM

SOCKET SETS



- 1/4" socket set
- High performance alloy steel
- High polished finish
- Metal case
- Insert of elastic plastic material to secure the tools
- ISO 1174
- DIN 3120

	 731415		 mm	 g
6721NM	1088309	1	223x113x41	1345
6700SM 4, 4.5, 5, 5.5, 6, 7, 8, 9, 10, 11, 12, 13, 14 mm			6950	
6958		6956		
6954		6960 50 mm		
6962 150 mm		6951		
6966				



6722M

SOCKET SETS



- 1/4" socket set
- High performance alloy steel
- High polished finish
- Metal case
- Insert of elastic plastic material to secure the tools
- ISO 1174
- DIN 3120

	 731415		 mm	 g
6722M	1594411	1	223x113x41	1260
6700SM 4, 5, 6, 7, 8, 9, 10, 11, 13, 14, mm			6950	
6956		6954		
50MH 0.6x4, 1x6, 1x7		52H PH No. 1, 2, 3		
55M 3, 4, 5, 6 mm		6972H		
6960 50 mm		6962 150 mm		
6966				

6715GE

SOCKET SETS



- 1/4" socket set
- High performance alloy steel
- High polished finish
- Metal case
- Insert of elastic plastic material to hold the tools
- ISO 1174
- DIN 3120

	 731415		 mm	 g
6715GE	1831370	1	223x113x41	1210
6700SM 4, 5, 6, 7, 8, 9, 10, 11, 13, 14 mm			6950RN	
6956		6954		
50MH 0.6x4, 1x6, 1x7		52H PH No. 1, 2, 3		
55M 3, 4, 5, 6 mm		6972H		
6960 50 mm		6962 150 mm		
6966				



SOCKET SETS 1/4"

6715PZ



SOCKET SETS

- 1/4" socket set
- High performance alloy steel
- High polished finish
- Metal case
- Insert of elastic plastic material to secure the tools
- ISO 1174
- DIN 3120

	 731415		 mm	 g
6715PZ	1837525	1	223x113x41	1370
6700SM 4, 4.5, 5, 5.5, 6, 7, 8, 9, 10, 11, 12, 13 mm			6950	
6956			6954	
6709F 0.6x4.5, 1.0x5.5, 1.2x8.0 mm			6709PZ No. 1, 2, 3	
6709M 3, 4, 5, 6, 8 mm			6960 50 mm	
6962 150 mm			6966	

6715GJ



SOCKET SETS

- 1/4" socket set
- High performance alloy steel
- High polished finish
- Metal case
- Insert of elastic plastic material to secure the tools
- ISO 1174
- DIN 3120

	 731415		 mm	 g
6715GJ	1831363	1	223x113x41	1370
6700SM 4, 4.5, 5, 5.5, 6, 7, 8, 9, 10, 11, 12, 13 mm			6950	
6956			6954	
6709F 0.6x4.5, 1.0x5.5, 1.2x8 mm			6709PH PH 1, 2, 3	
6709M 3, 4, 5, 6, 8 mm			6960 50 mm	
6962 150 mm			6966	



6720NM



SOCKET SETS

- 1/4" socket set
- High performance alloy steel
- High polished finish
- Metal case
- Insert of elastic plastic material to secure the tools
- ISO 1174
- DIN 3120

	 731415		 mm	 g
6720NM	1088262	1	351x114x43	2150
6700SM 4, 4.5, 5, 5.5, 6, 7, 8, 9, 10, 11, 12, 13, 14 mm			6950	
1931M 4, 4.5, 5, 5.5, 6, 7, 8, 9, 10, 11, 12, 13, 14 mm			6956	
6954			6962 150 mm	
221 D			7372 0.5x3x80 mm	
6966				

A6716DZ



SOCKET SETS

- 1/4" socket set
- High performance alloy steel
- High polished finish
- Metal case
- Insert of elastic plastic material to secure the tools
- ISO 1174
- DIN 3120

	 731415		 mm	 g
A6716DZ	1820831	1	223x113x41	1185
A6700DZ 3/16, 7/32, 1/4, 9/32, 5/16, 11/32, 3/8, 7/16, 1/2, 9/16			6950	
6956			6954	
6962 150 mm			6966	



SOCKET SETS 1/4"

6821NZ

SOCKET SETS



- 1/4" socket set
- High performance alloy steel
- High polished finish
- Metal case
- Insert of elastic plastic material to secure the tools
- ISO 1174
- DIN 3120

	 731415		 mm	 g
6821NZ	1089269	1	223x113x41	1385
6700SZ				
5/32, 3/16, 7/32, 1/4, 9/32, 5/16, 11/32, 3/8, 7/16, 1/2, 9/16				
6950		6958		
6956		6954		
6960 50 mm		6962 150 mm		
6951		6966		

6715MZ

SOCKET SETS



- 1/4" socket set
- High performance alloy steel
- High polished finish
- Metal case
- Insert of elastic plastic material to secure the tools
- ISO 1174
- DIN 3120

	 731415		 mm	 g
6715MZ	3003218	1	230x126x40	1105
6700SM				
4, 4.5, 5, 5.5, 6, 7, 8, 9, 10, 11, 13 mm				
6950		6950		
6700SZ		6956		
3/16, 7/32, 1/4, 9/32, 5/16, 11/32, 3/8, 7/16, 1/2				
6954		6962 150 mm		
6966				



6729SM

SOCKET SETS



- 1/4" socket set with 13 pcs of ref 6700SM on rail-187
- High performance alloy steel
- High polished finish
- ISO 1174
- DIN 3120

	 731415		 mm	 g
6729SM	3003225	1	190x55x25	276
6700SM	4, 4.5, 5, 5.5, 6, 7, 8, 9, 10, 11, 12, 13, 14 mm			
6956				

6729SZ

SOCKET SETS



- 1/4" socket set with 7 pcs of ref 6700SZ on rail-187
- High performance alloy steel
- High polished finish
- ISO 1174
- DIN 3120

	 731415		 mm	 g
6729SZ	3003232	1	190x55x25	193
6700SZ	3/16, 7/32, 1/4, 11/32, 3/8, 7/16, 1/2			
6956				



SOCKET SETS 1/4"

R6725MK



SOCKET SETS

- 1/4" socket set
- Includes ratchet R6950 for refrigeration
- High performance alloy steel
- High polished finish
- Metal case
- Plastic inlay
- ISO 1174
- DIN 3120

	 731415		 mm	 g
R6725MK	1088354	1	175x105x26	950
6700SM 7, 8, 10 mm			R6950	
6954		6962		
R6967		R6964A		
R6810M 3.4, 4, 4.5, 5, 6, 7, 8, 9, 10 mm		R6810Z 1/4		
6966				

R6725ZK



SOCKET SETS

- 1/4" socket set
- Includes ratchet R6950 for refrigeration
- High performance alloy steel
- High polished finish
- Metal case
- Plastic inlay
- ISO 1174
- DIN 3120

	 731415		 mm	 g
R6725ZK	1784898	1	175x105x26	1000
6700SZ 1/4, 5/16, 3/8, 7/16, 1/2, 11/32			R6950	
6954		6962		
R6967		R6964A		
R6810Z 3/16, 1/4, 5/16, 7/32, 3/8		R6810M 6 mm		
R6822Z 15/32x11/32		6966		



7400SM

HEXAGON METRIC

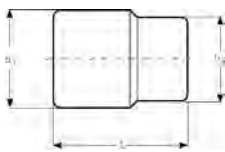

- Standard length sockets, 3/8" square drive
- Hex profile, metric sizes
- Not suitable for machine operation
- High performance alloy steel
- High polished finish
- Knurled
- ISO 2725/1174
- DIN 3124/3120

	 731415		 mm	L mm	D1 mm	D2 mm	 g
7400SM-6	1092917	5	6	25.5	9.3	17	15
7400SM-7	1092924	5	7	25.5	10.9	17	15
7400SM-8	1092931	5	8	25.5	11.8	17	16
7400SM-9	1092948	5	9	25.5	13.4	17	19
7400SM-10	1092955	5	10	25.5	14.6	17	19
7400SM-11	1092962	5	11	25.5	15.9	17	20
7400SM-12	1092979	5	12	25.5	17	17	22
7400SM-13	1092986	5	13	25.5	18.4	17	22
7400SM-14	1092993	5	14	27	19.6	18.4	23
7400SM-15	1093006	5	15	27	20.9	19	25
7400SM-16	1831127	5	16	27	22	20	25
7400SM-17	1093020	5	17	27	24.5	20	30
7400SM-18	1831134	5	18	27	24.5	20	30
7400SM-19	1093044	5	19	29	25.6	21	40
7400SM-20	3002570	5	20	29	26.8	24	63
7400SM-21	3002587	5	21	29	27.9	24	73
7400SM-22	3002594	5	22	31	29.6	26	78

7400SR/

HEXAGON METRIC



- 3/8" socket set with 12 pce of ref 7400SM on rail-264
- High performance alloy steel
- High polished finish
- ISO 1174
- DIN 3120

	 731415		 mm	 g
7400SR/S12	3003294	1	41x273x44	438

7400SM 8, 9, 10, 11, 12, 13, 14, 15, 16, 17,





A7400DM

DOUBLE HEXAGON METRIC

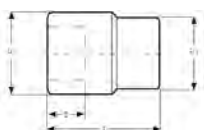

- Standard length sockets, 3/8" square drive
- Bi-hex profile, metric sizes
- Not suitable for machine operation
- High performance alloy steel
- High polished finish
- Knurled
- Thin-walled
- ISO 2725/1174
- DIN 3124/3120
- These sockets are applicable to nuts and bolts used in the aerospace industry

	 731415		 mm	L mm	D1 mm	D2 mm	T mm	 g
A7400DM-6	0118212	5	6	25.5	9.3	17	7	14
A7400DM-7	0118229	5	7	25.5	10.9	17	7	14
A7400DM-8	0118236	5	8	25.5	11.8	17	8	14
A7400DM-9	1819965	5	9	25.5	13.4	17	8	19
A7400DM-10	1819972	5	10	25.5	14.6	17	8	19
A7400DM-11	1819989	5	11	25.5	15.9	17	8	19
A7400DM-12	1819996	5	12	25.5	17.0	17	8.5	22
A7400DM-13	1820008	5	13	25.5	18.4	17	8.5	22
A7400DM-14	1820015	5	14	27	19.6	19	13	22
A7400DM-15	1820022	5	15	27	20.9	19	13	26
A7400DM-16	1820039	5	16	27	22	20	13	28
A7400DM-17	1820046	5	17	27	13.4	20	13	30
A7400DM-18	1820053	5	18	27	24.5	20	13	36
A7400DM-19	1820060	5	19	29	25.6	21	14	39
A7400DM-20	1820077	5	20	29	26.8	24	14	42
A7400DM-21	1820084	5	21	29	27.9	24	14	49
A7400DM-22	1820091	5	22	31	29.6	26	16	50



A7400DZ

DOUBLE HEXAGON INCH

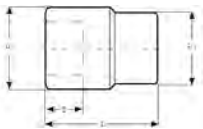

- Standard length sockets, 3/8" square drive
- Bi-hex profile, inch sizes
- Not suitable for machine operation
- High performance alloy steel
- High polished finish
- Knurled
- Thin-walled
- ISO 2725/1174
- DIN 3124/3120
- These sockets are applicable to nuts and bolts used in the aerospace industry

	 731415			L mm	D1 mm	D2 mm	T mm	 g
A7400DZ-1/4	1759193	5	1/4	25.5	10	17	7	15
A7400DZ-5/16	1759278	5	5/16	25.5	11.8	17	8	16
A7400DZ-3/8	1759438	5	3/8	25.5	14.3	17	8	19
A7400DZ-7/16	1759513	5	7/16	25.5	16	17	8	21
A7400DZ-1/2	1759780	5	1/2	25.5	18.4	17	8.5	22
A7400DZ-17/32	1819866	5	17/32	25.5	19.6	18.4	8.5	23
A7400DZ-9/16	1759865	5	9/16	27	20.2	18.4	13	25
A7400DZ-19/32	1819873	5	19/32	27	20.9	19	13	26
A7400DZ-5/8	1819880	5	5/8	27	22	20	13	28
A7400DZ-11/16	1819897	5	11/16	27	23.9	20	13	30
A7400DZ-3/4	1819903	5	3/4	29	25.6	21	14	40
A7400DZ-13/16	1819910	5	13/16	29	27.9	24	14	44
A7400DZ-7/8	1819927	5	7/8	31	30	26	16	50

A7410DZ

DOUBLE HEXAGON INCH

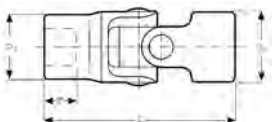

- Swivel sockets, 3/8" square drive
- Bi-hex profile, inch sizes
- Not suitable for machine operation
- High performance alloy steel
- High polished finish
- Thin-walled
- ISO 1174
- DIN 3120
- These sockets are applicable to nuts and bolts used in the aerospace industry

	 731415			L mm	D1 mm	D2 mm	T mm	 g
A7410DZ-5/16	3006271	1	5/16	55.9	11.4	19.0	6.0	39
A7410DZ-3/8	3006288	1	3/8	55.9	11.4	19.0	6.0	39
A7410DZ-7/16	3006295	1	7/16	55.9	15.7	19.0	7.6	45
A7410DZ-1/2	3006301	1	1/2	55.9	18.0	19.0	8.7	60
A7410DZ-9/16	3006318	1	9/16	55.9	16.6	19.0	10.7	69
A7410DZ-5/8	3006325	1	5/8	57.8	21.2	19.0	12.2	79
A7410DZ-11/16	3006332	1	11/16	57.8	23.6	19.0	13.8	95
A7410DZ-3/4	3006349	1	3/4	59.9	25.2	19.0	15.5	100



SOCKETS 3/8"

A7402DM

DOUBLE HEXAGON LONG SERIES METRIC

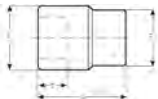

- Deep length sockets, 3/8" square drive
- Bi-hex profile, metric sizes
- Not suitable for machine operation
- High performance alloy steel
- High polished finish
- Knurled
- Thin-walled
- ISO 2725-1/1174-1
- DIN 3120
- These sockets are applicable to nuts and bolts used in the aerospace industry

	 731415		 mm	L mm	D1 mm	D2 mm	T mm	 g
A7402DM-10	1820138	1	10	56	14.3	17.3	9.7	41
A7402DM-11	1820145	1	11	56	15.8	17.3	11.2	42
A7402DM-12	1820152	1	12	56	16.6	17.3	12.7	44
A7402DM-13	1820169	1	13	60	18.0	17.3	12.7	58
A7402DM-14	1820176	1	14	60	19.6	18.0	15.5	63
A7402DM-15	1820183	1	15	60	20.4	19.0	15.5	75
A7402DM-16	1820190	1	16	60	21.1	20.0	15.5	79
A7402DM-17	1820206	1	17	60	22.8	20.0	15.5	93
A7402DM-18	1820213	1	18	60	24.3	21.0	18.5	100
A7402DM-19	1820220	1	19	60	25.1	22.0	18.5	109

A7402DZ

DOUBLE HEXAGON LONG SERIES INCH

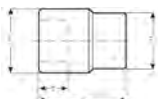

- Deep length sockets, 3/8" square drive
- Bi-hex profile, inch sizes
- Not suitable for machine operation
- High performance alloy steel
- High polished finish
- Knurled
- Thin-walled
- ISO 2725-1/1174-1
- DIN 3120
- These sockets are applicable to nuts and bolts used in the aerospace industry

	 731415		 "	L mm	D1 mm	D2 mm	T mm	 g
A7402DZ-1/4	1759940	1	1/4	56	10.0	17.3	5.8	41
A7402DZ-5/16	1760014	1	5/16	56	11.4	17.3	7.4	42
A7402DZ-3/8	1760366	1	3/8	56	14.3	17.3	10.2	45
A7402DZ-7/16	1760441	1	7/16	56	15.7	17.3	11.2	45
A7402DZ-1/2	1760526	1	1/2	60	18.0	17.3	12.7	60
A7402DZ-9/16	1760793	1	9/16	60	19.6	18.0	15.5	69
A7402DZ-19/32	3003041	1	19/32	60	20.4	18.5	10.7	76
A7402DZ-5/8	1820107	1	5/8	60	21.1	19.0	15.5	79
A7402DZ-11/16	1820114	1	11/16	60	23.6	20.5	15.5	95
A7402DZ-3/4	1820121	1	3/4	60	25.2	22.0	18.5	100
A7402DZ-13/16	3003027	1	13/16	60	26.7	23.5	17.0	109
A7402DZ-7/8	3003034	1	7/8	60	29.1	26.0	18.3	109



SF

HEXAGON METRIC

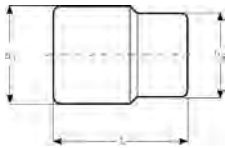

- Standard length sockets, 3/8" square drive
- Hex profile, metric sizes
- Not suitable for machine operation
- High performance alloy steel
- Matt finish
- ISO 2725/1174
- DIN 3124/3120
- Retail packed on a plastic info card

	 731415			L mm	D1 mm	D2 mm	
SBSF-10	3012654	1	10	25.8	14.3	17.3	19
SBSF-11	3012661	1	11	25.8	15.7	17.3	20
SBSF-12	3012678	1	12	25.8	16.6	17.3	22
SBSF-13	3012685	1	13	25.8	18.0	17.3	22
SBSF-14	3012692	1	14	26.2	19.6	18.0	23
SBSF-15	3012708	1	15	27.8	20.4	19.0	25
SBSF-16	3012715	1	16	28.3	21.1	20.0	25
SBSF-17	3012722	1	17	28.8	22.8	20.0	30
SBSF-18	3012739	1	18	29.5	24.3	21.0	30
SBSF-19	3012746	1	19	30.1	25.1	22.0	40

7400TORX-E

TORX®-E

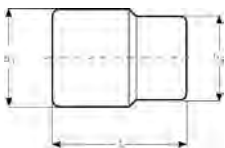

- TORX® sockets, 3/8" square drive
- For TORX® head screws
- Not suitable for machine operation
- High performance alloy steel
- High polished finish
- Knurled
- ISO 2725/1174
- DIN 3124/3120

	 731415			L mm	D1 mm	D2 mm		
7400TORX-E8	0118243	5	E8	31	10.2	17	M5+M6	25
7400TORX-E10	3003058	5	E10	31	12.3	17	M6+M8	25
7400TORX-E11	3003065	5	E11	31	13.3	17	–	25
7400TORX-E12	3003072	5	E12	31	14.3	17	M8+M10	25
7400TORX-E14	3003089	5	E14	31	15.8	17	M10+M12	25
7400TORX-E16	3003096	5	E16	31	19.6	19.6	–	26
7400TORX-E18	3003102	5	E18	31	21	21	M12+M14	27



SOCKETS 3/8"

7400TORX-ER/

TORX®-E



- 3/8" socket set with 7 pcs of ref 7400TORX-E on rail-264
- High performance alloy steel
- High polished finish
- ISO 1174
- DIN 3120



	 731415		 mm	 g
7400TORX-ER/S7	3003300	1	190x55x25	333
7400TORX-E E8, E10, E11, E12, E14, E16, E18				



SOCKET DRIVERS 3/8"

7409F

FOR SLOTTED SCREWS



- 3/8" square drive socket drivers, for slotted head screws
- Not suitable for machine operation
- High performance alloy steel
- High polished finish
- Knurled
- ISO 1174
- DIN 3120

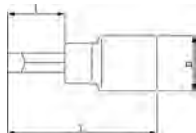

	 731415		L mm	l mm	 mm	 mm	D mm	 g
7409F-6.5	3002129	5	47	17	0.8	6.4	19	55
7409F-8	3002136	5	50.5	20.5	1.2	7.9	19	55
7409F-10	3002143	5	50.5	20.5	1.5	9.5	19	59

7409PH

FOR PHILLIPS HEAD SCREWS



- 3/8" square drive socket drivers, for Phillips head screws
- Not suitable for machine operation
- High performance alloy steel
- High polished finish
- Knurled
- ISO 1174
- DIN 3120

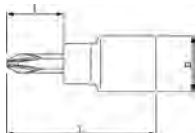

	 731415			l mm	L mm	D mm	 g
7409PH-1	3002150	5	1	17	47	19	55
7409PH-2	3002167	5	2	17	47	19	55
7409PH-3	3002174	5	3	17	47	19	60



7409TORX

FOR TORX® HEAD SCREWS

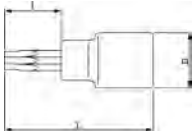

- 3/8" square drive socket drivers, for TORX® head screws
- Not suitable for machine operation
- High performance alloy steel
- High polished finish
- Knurled
- ISO 1174
- DIN 3120

	 731415			I mm	L mm	D mm		 g	
	7409TORX-T25	3001771	5	T25	17	47	19	M5	54
	7409TORX-T27	3001788	5	T27	17	47	19	–	54
	7409TORX-T30	3001795	5	T30	17	47	19	M6	54
	7409TORX-T40	3001801	5	T40	17	47	19	M8	55
	7409TORX-T45	3001818	5	T45	20.5	50.5	19	–	55
	7409TORX-T50	3001825	5	T50	20.5	50.5	19	M10	55

7409TORX-R

FOR TORX® HEAD SCREWS

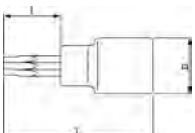

- 3/8" square drive socket drivers, for TORX® head screws, tamper resistant
- Not suitable for machine operation
- High performance alloy steel
- High polished finish
- Knurled
- ISO 1174
- DIN 3120

	 731415			I mm	L mm	D mm		 g	
	7409TORX-R-T27	3001856	5	TR 27	17	47	19	–	54
	7409TORX-R-T30	3001863	5	TR 30	17	47	19	M6	54
	7409TORX-R-T40	3001870	5	TR 40	17	47	19	M8	55
	7409TORX-R-T45	3001887	5	TR 45	20.5	50.5	19	–	55
	7409TORX-R-T50	3001894	5	TR 50	20.5	50.5	19	M10	55

7409TORX-TRR/

FOR TORX® HEAD SCREWS



- 3/8" socket set with 5 pcs of ref 7409TORX-R, tamper resistant, on Rail-187
- High performance alloy steel
- High polished finish
- ISO 1174
- DIN 3120

	 731415		 mm	 g
	7409TORX-TRR/S5	3003263	190x55x25	333

7409TORX-R TR-27, TR-30, TR-40, TR-45, TR-50





SOCKET DRIVERS 3/8"

7409TORX-L

FOR TORX® HEAD SCREWS

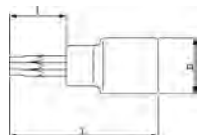

- 3/8" square drive socket drivers, long, for TORX® head screws
- Not suitable for machine operation
- High performance alloy steel
- High polished finish
- Knurled
- ISO 1174
- DIN 3120

	 731415			I mm	L mm	D mm		 g

7409M

HEX HEAD DRIVERS

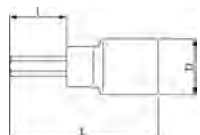

- 3/8" square drive socket drivers, for hex head screws
- Metric sizes
- Not suitable for machine operation
- High performance alloy steel
- High polished finish
- Knurled
- ISO 1174
- DIN 3120

	 731415		 mm	I mm	L mm	D mm	 g

7409MR/

HEX HEAD DRIVERS



- 3/8" socket set with 7 pcs of ref 7409M on Rail-187
- High performance alloy steel
- High polished finish
- ISO 1174
- DIN 3120

	 731415		 mm	 g

7409MR/S7	3003256	1	190x55x25	332
7409MR/S7	3, 4, 5, 6, 7, 8, 10 MM			



7409BH

HEX HEAD DRIVERS

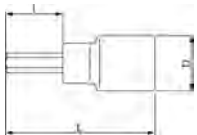

- 3/8" square drive ball hex socket drivers, for hex head screws
- Metric sizes
- Not suitable for machine operation
- High performance alloy steel
- High polished finish
- Knurled
- ISO 1174
- DIN 3120

	 731415		 mm	I mm	L mm	D mm	 g
7409BH-4	3002075	5	4	65.5	95.5	19	54
7409BH-5	3002082	1	5	65.5	95.5	19	54
7409BH-6	3002099	5	6	65.5	95.5	19	55
7409BH-8	3002105	5	8	65.5	95.5	19	57
7409BH-10	3002112	5	10	65.5	95.5	19	59

ACCESSORIES 3/8"



7755-3/8

REVERSIBLE RATCHET

ergo[®]



- 3/8" ratchet, developed according to the scientific ERGO™ process
- 72 teeth/5° action angle
- High performance alloy steel
- High polished finish
- Easy change of direction with one hand, by a short turn of reversing ring, patented
- Quick release of sockets by pressing the locking button
- Integrated quick-turning disc to accelerate operation in fastening or releasing easy running screws
- Spare parts available
- ISO 3315/1174-2
- DIN 3122/3120; UNE 16512
- SB = Retail packed on a plastic info card

	 731415		 mm	 g
7755-3/8	3002372	1	215	245
SB7755-3/8	3010100	1	215	245



ACCESSORIES 3/8"

7750

REVERSIBLE RATCHET



- 3/8" ratchet, reversible
- 80 teeth/4.5° action angle
- High performance alloy steel
- High polished finish
- Sealed
- Smooth operation
- Double pawl system for superior strength
- Patented mechanism
- Spare parts available
- ISO 3315/1174-2; DIN 3122/3120; UNE 16512



7750

1096427

1

205

260

7750RN

REVERSIBLE RATCHET



- 3/8" ratchet, reversible
- 72 teeth/5° action angle
- High performance alloy steel
- High polished finish
- Indicating arrow for turning direction. Patented
- Spare parts available
- ISO 3315/1174-2
- DIN 3122/3120; UNE 16512



7750RN

1831240

1

202

205

SBS750

REVERSIBLE RATCHET



- 3/8" Ratchet, reversible
- 60 teeth/6° action angle
- High performance alloy steel
- Matt finish
- Quick release
- ISO 3315/1174-2; DIN 3122/3120; UNE 16512
- Retail pack



SBS750

3012883

1

200

235



7710

REVERSIBLE FLEX-HEAD RATCHET



- 3/8" flex-head ratchet, reversible
- 60 teeth/6° action angle
- High performance alloy steel
- High polished finish
- Quick release
- ISO 3315/1174-2; DIN 3122/3120; UNE 16512

	 731415		 L mm	 g
7710	1551445	1	280	340

7752

SPEEDER



- 3/8" speeder, with rotary steel handle
- High performance alloy steel
- High polished finish
- ISO 3315/1174
- DIN 3122/3123/3120

	 731415		 L mm	 g
7752	1096533	1	435	410

7758

BREAKER BAR



- 3/8" breaker bar
- High performance alloy steel
- High polished finish
- ISO 3315/1174
- DIN 3122/3123/3120

	 731415		 L mm	 g
7758	1096595	1	250	250

S705

BREAKER BAR



- 3/8" breaker bar
- High performance alloy steel
- Matt finish
- ISO 3315/1174
- DIN 3122/3123/3120
- Retail pack

	 731415		 L mm	 g
SBS705	3012968	1	240	250



ACCESSORIES 3/8"

7754

SLIDING T-HANDLE



- 3/8" sliding T-handle
- High performance alloy steel
- High polished finish
- 100% sliding
- ISO 3315/1174
- DIN 3122/3123/3120; UNE 16512

7754	1096557	1	160	130

S755

SLIDING T-HANDLE



- 3/8" sliding T-handle
- High performance alloy steel
- Matt finish
- ISO 3315/1174
- DIN 3122/3123/3120
- Retail pack

SBS755	3012913	1	160	130

7757

SPINNER HANDLE



- 3/8" spinner handle
- Integrated 3/8" female square drive in the handle for use as extension bar or with a sliding T-handle
- High performance alloy steel
- High polished finish
- ISO 3315/1174
- DIN 3122/3123/3120; UNE 16512

7757	1096588	1	150	170



7760-7761-7762

EXTENSION BARS



- 3/8" extension bars
- High performance alloy steel
- High polished finish
- ISO 3316/1174
- DIN 3122/3123/3120; UNE 16511
- SB = Retail packed on a plastic info card

	 731415			
7760	1096618	1	75	80
7761	1096632	1	127	115
7762	1096649	1	252	210
SB7760	3003980	1	75	80
SB7762	3004000	1	252	210

7760-W - 7761-W

EXTENSION BARS

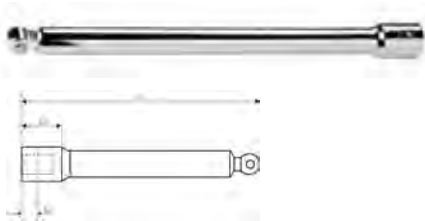

- 3/8" wobbler extension bars
- High performance alloy steel
- High polished finish
- ISO 1174
- DIN 3120

	 731415		L1 mm	L2 mm	L3 mm	
7760-W	0107155	1	75	18	8	75
7761-W	0107162	1	150	18	8	145

7759

EXTENSION BARS



- 3/8" flexible extension bar
- High performance alloy steel
- High polished finish
- ISO 1174
- DIN 3120
- Not designed for final tightening or initial loosening

	 731415			
7759	1096601	1	208	125



ACCESSORIES 3/8"

S760 - S762

EXTENSION BARS



- 3/8" extension bars
- High performance alloy steel
- Matt finish
- ISO 3316/1174
- DIN 3122/3123/3120
- Retail pack

	 731415		 L mm	 g
SBS760	3012937	1	75	80
SBS761	3012944	1	125	115
SBS762	3012951	1	250	210

7766

UNIVERSAL JOINT



- 3/8" universal joint
- High performance alloy steel
- High polished finish
- ISO 3316/1174
- DIN 3122/3123/3120; UNE 16511

	 731415		 L mm	 g
7766	1096694	1	51.5	70

S775

UNIVERSAL JOINT



- 3/8" universal joint
- High performance alloy steel
- Matt finish
- ISO 3316/1174
- DIN 3122/3123/3120; UNE 16511
- Retail pack

	 731415		 L mm	 g
SBS775	3012920	1	52	70



7768

UNIVERSAL JOINT



- 3/8" universal joint , smooth operation
- High performance alloy steel
- High polished finish
- ISO 3316/1174
- DIN 3122/3123/3120; UNE 16511
- Curved shapes give a very smooth movement transmission improving working efficiency
- Action spring for a correct fixing
- 45° action angle

7768	731415 0128433	1	45 mm	60 g

7764

ADAPTORS



- Decreasing adaptor for 3/8" square drive and 1/4" sockets
- High performance alloy steel
- High polished finish
- ISO 1174
- DIN 3120/3123; UNE 16503

7764	731415 1096670	1	3/8	1/4	24.7 mm	25 g

8164-1/2

ADAPTORS



- Increasing adaptor for 3/8" square drive and 1/2" sockets
- High performance alloy steel
- High polished finish
- ISO 1174
- DIN 3120/3123; UNE 16503

8164-1/2	731415 1105266	1	3/8"	1/2"	33 mm	62 g

8167

ADAPTORS



- Increasing flat adaptor for 3/8" square drive and 1/2" sockets
- High performance alloy steel
- Galvanised finish
- With magnet in the drive disc
- ISO 1174
- DIN 3120; UNE 16503

8167	731415 3003584	1	3/8	1/2	13.0 mm	30 g



ACCESSORIES 3/8"

S723/S724

ADAPTORS



- Adaptors for 3/8" square drive and 1/4" and 1/2" sockets
- High performance alloy steel
- Matt finish
- ISO 1174
- DIN 3120/3123; UNE 16503
- Retail pack

	 731415					
SBS723	3012890	1	3/8"	1/4"	27	25
SBS724	3012906	1	3/8"	1/2"	35	62

7106

ADAPTORS



- 3/8" adaptor for 5/16" bits
- High performance alloy steel
- High polished finish
- ISO 1174
- DIN 3120; UNE 16503

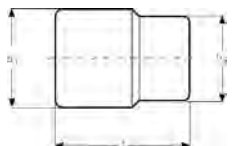

	 841334			L mm	D1 mm	D2 mm	
7106J0080	5025164	1	5/16"	28	17	13	32

8967/

ADAPTOR SET



- Increasing flat adaptors set, 3 pcs
- Content: 7767, 8167 and 8967
- High performance alloy steel
- Galvanised finish
- With magnet in the drive disc
- ISO 1174
- DIN 3120; UNE 16503

	 731415			
8967/S3	3003607	1	30x194x110	109



7755-SO/1

SPARE PARTS ASSORTMENT



- Spare parts kit for 3/8" ratchet 7755-3/8
- Contents: 6 pcs

	 731415		 g
7755-SO/1	3010728	1	53

7750-SPARE

SPARE PARTS ASSORTMENT



- Spare parts kit for 3/8" ratchet 7750

	 731415		 g
7750-SPARE	0187874	1	60

7750RN-SPARE

SPARE PARTS ASSORTMENT



- Spare parts kit for 3/8" ratchet 7750RN

	 731415		 g
7750RN-SPARE	0209361	1	60

7710-SO/1

SPARE PARTS ASSORTMENT



- Spare parts kit for 3/8" ratchet 7710

	 731415		 g
7710-SO/1	1809744	1	109



ACCESSORIES 3/8"

187/264/340

SOCKET RAILS



- Socket rails in zinc coated metal with 2 holes for screws, (-340 with 3 holes)
- Suitable for CLIPS-1/4 (1/4"), CLIPS-3/8 (3/8") and CLIPS-1/2 (1/2")
- Fitting sockets or socket drivers, in the respective square size

	 731415			
RAIL-187	3003621	3	187	15
RAIL-264	3003638	3	264	20
RAIL-340	3003645	3	340	30

C3/8

CLIPS



- Rail-clips for 3/8" sockets and socket drivers
- Nickel plated, spring metal
- To be used on RAIL-187, -264 or -340

	 731415			
CLIPS-3/8	3003195	25	19	2



SOCKET SETS 3/8"

7420RE

SOCKET SETS



- 3/8" socket set
- Includes 3/8" ratchet, developed according to the scientific ERGO™ process
- Hex sockets, metric sizes
- High performance alloy steel
- High polished finish
- Metal case
- Insert of elastic plastic material to hold the tools
- ISO 1174
- DIN 3120

	 731415			
7420RE	3014962	1	312x115x50	1900

7755-3/8		7761 125 mm	
----------	--	----------------	--

7400SM	8, 10, 11, 12, 13, 14, 15, 16, 17, 18, 19 mm		
--------	--	--	--



7440ME



SOCKET SETS

- 3/8" socket set
- Includes 3/8" ratchet, developed according to the scientific ERGO™ process
- Hex sockets, metric sizes
- High performance alloy steel
- High polished finish
- Metal case
- Insert of elastic plastic material to hold the tools
- ISO 1174
- DIN 3120

	 731415		 mm	 g
7440ME	3014986	1	312x115x50	2075
7400SM 6, 7, 8, 9, 10, 11, 12, 13, 14, 15, 17, 19 mm			7755-3/8	
7758			7761 125 mm	

7430GE



SOCKET SETS

- 3/8" socket set
- Includes 3/8" ratchet, developed according to the scientific ERGO™ process
- Hex sockets, metric sizes
- High performance alloy steel
- High polished finish
- Metal case
- Insert of elastic plastic material to hold the tools
- ISO 1174
- DIN 3120

	 731415		 mm	 g
7430GE	3014979	1	312x115x50	2300
7754			7761 125 mm	
7762 250 mm			7766	
7400SM 6, 7, 8, 9, 10, 11, 12, 13, 14, 15, 17, 19 mm			7755-3/8	



SOCKET SETS 3/8"

A7435DME



SOCKET SETS

- 3/8" socket set
- Includes 3/8" ratchet, developed according to the scientific ERGO™ process
- Bi-hex sockets, metric sizes
- High performance alloy steel
- High polished finish
- Metal case
- Insert of elastic plastic material to hold the tools
- ISO 1174
- DIN 3120

	 731415		 mm	 g
A7435DME	3015006	1	490X150X38	3300
A7400DM	9, 10, 11, 12, 13, 14, 15, 16, 17, 18, 19, 20, 21, 22 mm			
7755-3/8		7758		
7754		7752		
7760 75 mm		7761 125 mm		
7762 250 mm		7766		

A7440DZE



SOCKET SETS

- 3/8" socket set
- Includes 3/8" ratchet, developed according to the scientific ERGO™ process
- Bi-hex sockets, inch sizes
- High performance alloy steel
- High polished finish
- Metal case
- Insert of elastic plastic material to hold the tools
- ISO 1174
- DIN 3120

	 731415		 mm	 g
A7440DZE	3014993	1	490X150X38	2050
A7400DZ	1/4, 5/16, 3/8, 7/16, 1/2, 9/16, 5/8, 11/16, 3/4, 13/16, 7/8			
7755-3/8		7758		
7761 125 mm				



A7440DME

SOCKET SETS



- 3/8" socket set
- Includes 3/8" ratchet, developed according to the scientific ERGO™ process
- Bi-hex sockets, metric sizes
- High performance alloy steel
- High polished finish
- Metal case
- Insert of elastic plastic material to hold the tools
- ISO 1174
- DIN 3120

	 731415		 mm	 g
A7440DME	3015419	1	312x115x50	2050
A7400DM	9, 10, 11, 12, 13, 14, 15, 16, 17, 18, 19, 20, 21, 22 mm			
7755-3/8		7758		
7761 125 mm				

A7535DZE

SOCKET SETS



- 3/8" socket set
- Includes 3/8" ratchet, developed according to the scientific ERGO™ process
- Bi-hex sockets, inch sizes
- High performance alloy steel
- High polished finish
- Metal case
- Insert of elastic plastic material to hold the tools
- ISO 1174
- DIN 3120

	 731415		 mm	 g
A7535DZE	3015013	1	45x500x165	3150
A7400DZ	1/4, 5/16, 3/8, 7/16, 1/2, 17/32, 9/16, 19/32, 5/8, 11/16, 3/4, 13/16, 7/8			
7755-3/8		7758		
7754		7752		
7760 75 mm		7762 250 mm		
7766				



SOCKET SETS 3/8"

7429JDE

SOCKET SETS



- 3/8" socket set
- Includes 3/8" ratchet, developed according to the scientific ERGO™ process
- Bi-hex sockets, metric sizes
- High performance alloy steel
- High polished finish
- Metal case
- Insert of elastic plastic material to hold the tools
- ISO 1174
- DIN 3120

	 731415		 mm	 g
7429JDE	3003348	1	490X150X38	3743
A7400DM	6, 7, 8, 9, 10, 11, 12, 13, 14, 15, 16, 17, 18, 19, 20, 21, 22 mm			
7755-3/8		7757		
7754		7409F 6.5, 8 mm		
7409PH PH 1, 2, 3		7409M 3, 4, 5, 6, 8 mm		
7760 75 mm		7762 250 mm		
7407H		7766		





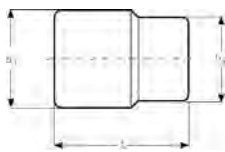

7800SM

HEXAGON METRIC



- Standard length sockets, 1/2" square drive
- Hex profile, metric sizes
- Not suitable for machine operation
- High performance alloy steel
- High polished finish
- Knurled
- ISO 2725/1174
- DIN 3124/3120
- SB = Retail packed on a plastic info card

	 731415		 mm	L mm	D1 mm	D2 mm	 g
7800SM-8	1830793	10	8	38	12.9	22.0	42
7800SM-9	1830809	10	9	38	14.2	22.0	42
7800SM-10	1097851	10	10	38	15.4	22.0	51
7800SM-11	1097868	10	11	38	16.6	22.0	51
7800SM-12	1097875	10	12	38	17.9	22.0	51
7800SM-13	1097882	10	13	38	19.1	22.0	53
7800SM-14	1097899	10	14	38	20.4	22.0	54
7800SM-15	1097905	10	15	38	21.6	22.0	64
7800SM-16	1097912	10	16	38	22.9	22.0	64
7800SM-17	1097929	10	17	38	24.1	23.0	72
7800SM-18	1097936	10	18	38	25.4	23.5	76
7800SM-19	1097943	10	19	38	26.6	24.0	80
7800SM-21	1097967	5	21	39	29.1	25.0	102
7800SM-22	1097974	5	22	39	30.4	25.5	109
7800SM-23	1097981	5	23	40	31.6	26.0	109
7800SM-24	1097998	5	24	41	32.9	26.5	121
7800SM-25	1098001	5	25	42	34.1	27.0	124
7800SM-26	1830823	5	26	43	35.4	28.0	136
7800SM-27	1098025	5	27	44	36.6	29.0	173
7800SM-28	1830830	5	28	45	37.9	29.0	173
7800SM-30	1098056	5	30	47	40.4	29.5	189
7800SM-32	1098063	5	32	47	42.9	30.5	227
7800SM-34	3011305	5	34	47	43.0	42.0	228
7800SM-36	1098087	1	36	57	50.0	42.0	315
SB7800SM-8	0104680	1	8	38	12.9	22.0	42
SB7800SM-9	0104697	1	9	38	14.2	22.0	42
SB7800SM-10	0104703	1	10	38	15.4	22.0	51
SB7800SM-11	0104710	1	11	38	16.6	22.0	51
SB7800SM-12	0104727	1	12	38	17.9	22.0	51
SB7800SM-13	0104734	1	13	38	19.1	22.0	53
SB7800SM-14	0104741	1	14	38	20.4	22.0	54
SB7800SM-15	0104758	1	15	38	21.6	22.0	64
SB7800SM-16	0104765	1	16	38	22.9	22.0	64
SB7800SM-17	0104772	1	17	38	24.1	23.0	72
SB7800SM-18	0104789	1	18	38	25.4	23.5	76
SB7800SM-19	0104796	1	19	38	26.6	24.0	80
SB7800SM-21	0104819	1	21	39	29.1	25.0	102
SB7800SM-22	0104826	1	22	39	30.4	25.5	109
SB7800SM-23	0104833	1	23	40	31.6	26.0	109
SB7800SM-24	0104840	1	24	41	32.9	26.5	121
SB7800SM-25	0104857	1	25	41	34.1	27.0	124
SB7800SM-26	0104864	1	26	43	35.4	28.0	136
SB7800SM-27	0104871	1	27	44	36.6	29.0	173
SB7800SM-28	0104888	1	28	45	37.9	29.0	173
SB7800SM-30	0104895	1	30	47	40.4	29.5	189
SB7800SM-32	0104901	1	32	47	42.9	30.5	227



7805SM

HEXAGON LONG SERIES METRIC

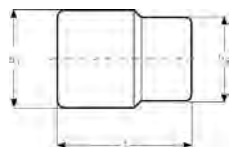

- Deep length sockets, 1/2" square drive
- Hex profile, metric sizes
- Not suitable for machine operation
- High performance alloy steel
- High polished finish
- Knurled
- ISO 2725-1/1174-1
- DIN 3120

	 731415		 mm	L mm	D1 mm	D2 mm	 g
7805SM-10	3011312	5	10	82.6	14.9	22.5	95
7805SM-12	3011329	5	12	82.6	17.9	22.5	103
7805SM-13	3011336	5	13	82.6	17.9	22.5	109
7805SM-14	3011343	5	14	82.6	20.4	22.5	135
7805SM-15	3011350	5	15	82.6	21.6	22.5	138
7805SM-16	3011367	5	16	82.6	22.9	22.5	150
7805SM-17	3011374	5	17	82.6	24.1	22.5	180
7805SM-18	3011381	5	18	82.6	25.2	22.5	164
7805SM-19	3011398	5	19	82.6	26.3	22.5	163
7805SM-20	3011404	5	20	82.6	26.3	22.5	163
7805SM-21	3011411	1	21	82.6	28.3	24.3	228
7805SM-22	3011428	1	22	82.6	29.9	25.9	234
7805SM-23	3011435	1	23	82.6	28.3	24.3	228
7805SM-24	3011442	1	24	82.6	32.0	28.0	296
7805SM-25	3011459	1	25	82.6	32.0	28.0	296
7805SM-26	3011466	1	26	82.6	34.7	30.7	320
7805SM-27	3011473	1	27	82.6	36.2	32.2	353
7805SM-28	3011480	1	28	82.6	36.2	32.2	353
7805SM-29	3011497	1	29	82.6	36.2	32.2	353
7805SM-30	3011503	1	30	82.6	40.9	36.4	421
7805SM-32	3011527	1	32	82.6	40.9	36.4	421



7800DM

DOUBLE HEXAGON METRIC

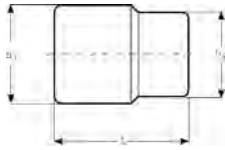

- Standard length sockets, 1/2" square drive
- Bi-hex profile, metric sizes
- Not suitable for machine operation
- High performance alloy steel
- High polished finish
- Knurled
- ISO 2725/1174
- DIN 3124/3120
- SB = Retail packed on a plastic info card

	 731415		 mm	L mm	D1 mm	D2 mm	 g
7800DM-8	1830854	10	8	38	12.9	22.0	42
7800DM-9	1830861	10	9	38	14.2	22.0	42
7800DM-10	1096991	10	10	38	15.4	22.0	51
7800DM-11	1097011	10	11	38	16.6	22.0	51
7800DM-12	1097035	10	12	38	17.9	22.0	51
7800DM-13	1097059	10	13	38	19.1	22.0	56
7800DM-14	1097073	10	14	38	20.4	22.0	56
7800DM-15	1097097	10	15	38	21.6	22.0	64
7800DM-16	1097110	10	16	38	22.9	22.0	64
7800DM-17	1097134	10	17	38	24.1	23.0	72
7800DM-18	1097158	10	18	38	25.4	23.5	76
7800DM-19	1097172	10	19	38	26.6	24.0	80
7800DM-20	1097196	5	20	38	27.9	24.5	81
7800DM-21	1097219	10	21	39	29.1	25.0	102
7800DM-22	1097233	5	22	39	30.4	25.5	109
7800DM-23	1097257	5	23	40	31.6	26.0	109
7800DM-24	1097271	5	24	41	32.9	26.5	121
7800DM-25	1097295	5	25	42	34.1	27.0	124
7800DM-26	1097318	5	26	43	35.4	28.0	136
7800DM-27	1097332	5	27	44	36.6	29.0	173
7800DM-28	1097356	5	28	45	37.9	27.6	173
7800DM-29	1097363	5	29	46	39.1	28.6	175
7800DM-30	1097370	5	30	47	40.4	29.5	189
7800DM-32	1097387	5	32	47	42.9	30.5	227
7800DM-36	1097400	1	36	57	50.0	42.0	315
SB7800DM-8	0104437	1	8	38	12.9	22.0	42
SB7800DM-9	0104444	1	9	38	14.2	22.0	42
SB7800DM-10	0104451	1	10	38	15.4	22.0	51
SB7800DM-11	0104468	1	11	38	16.6	22.0	51
SB7800DM-12	0104475	1	12	38	17.9	22.0	51
SB7800DM-13	0104482	1	13	38	19.1	22.0	56
SB7800DM-14	0104499	1	14	38	20.4	22.0	56
SB7800DM-15	0104505	1	15	38	21.6	22.0	64
SB7800DM-16	0104512	1	16	38	22.9	22.0	64
SB7800DM-17	0104529	1	17	38	24.1	23.0	72
SB7800DM-18	0104536	1	18	38	25.4	23.5	76
SB7800DM-19	0104543	1	19	38	26.6	24.0	80
SB7800DM-20	0104550	1	20	38	27.9	24.5	81
SB7800DM-21	0104567	1	21	39	29.1	25.0	102
SB7800DM-22	0104574	1	22	39	30.4	25.5	109
SB7800DM-23	0104581	1	23	40	31.6	26.0	109
SB7800DM-24	0104598	1	24	41	32.9	26.5	121
SB7800DM-25	0104604	1	25	42	34.1	27.0	124
SB7800DM-26	0104611	1	26	43	35.4	28.0	136
SB7800DM-27	0104628	1	27	44	36.6	29.0	173
SB7800DM-28	0104635	1	28	45	37.9	27.6	173
SB7800DM-29	0104642	1	29	46	39.1	28.6	175
SB7800DM-30	0104659	1	30	47	40.4	29.5	189
SB7800DM-32	0104666	1	32	47	42.9	30.5	227
SB7800DM-36	0104673	1	36	57	50.0	42.0	315



SOCKETS 1/2"

7800DZ

DOUBLE HEXAGON INCH

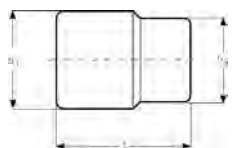

- Standard length sockets, 1/2" square drive
- Bi-hex profile, inch sizes
- Not suitable for machine operation
- High performance alloy steel
- High polished finish
- Knurled
- ISO 2725/1174
- DIN 3124/3120

	 731415			L mm	D1 mm	D2 mm	
7800DZ-3/8	1097431	5	3/8	38	14.5	22.0	41
7800DZ-7/16	1097448	5	7/16	38	16.6	22.0	46
7800DZ-1/2	1097455	5	1/2	38	18.8	22.0	51
7800DZ-9/16	1097462	5	9/16	38	20.8	22.0	53
7800DZ-19/32	1097479	5	19/32	38	21.6	22.0	56
7800DZ-5/8	1097486	5	5/8	38	22.9	22.0	65
7800DZ-11/16	1097493	5	11/16	38	24.7	23.0	75
7800DZ-3/4	1097509	5	3/4	38	26.6	24.0	76
7800DZ-25/32	1097516	5	25/32	38	27.9	24.5	85
7800DZ-13/16	1097523	5	13/16	39	28.7	25.0	92
7800DZ-7/8	1097530	5	7/8	39	30.7	25.5	99
7800DZ-15/16	1097554	5	15/16	41	32.7	26.0	120
7800DZ-1	1097561	5	1	42	34.7	27.5	139
7800DZ-1.1/16	1097578	1	1 1/16	44	36.6	29.0	142
7800DZ-1.1/8	1097585	1	1 1/8	46	38.6	29.0	157
7800DZ-1.3/16	1097592	1	1 3/16	47	40.4	29.0	178
7800DZ-1.1/4	1097608	1	1 1/4	47	42.3	30.5	185

7805DM

DOUBLE HEXAGON LONG SERIES METRIC

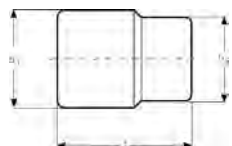

- Deep length sockets, 1/2" square drive
- Bi-hex profile, metric sizes
- Not suitable for machine operation
- High performance alloy steel
- High polished finish
- Knurled
- ISO 2725-1/1174-1
- DIN 3120

	 731415			L mm	D1 mm	D2 mm	
7805DM-10	1822101	5	10	82.6	14.9	22.5	95
7805DM-12	1098452	5	12	82.6	17.9	22.5	103
7805DM-13	1098469	5	13	82.6	17.9	22.5	109
7805DM-14	1098476	5	14	82.6	20.4	22.5	135
7805DM-15	1098483	5	15	82.6	21.6	22.5	138
7805DM-16	1098490	5	16	82.6	22.9	22.5	150
7805DM-17	1098506	5	17	82.6	24.1	22.5	180
7805DM-18	1098513	5	18	82.6	25.2	22.5	164
7805DM-19	1098520	5	19	82.6	26.3	22.5	163
7805DM-21	1098544	1	21	82.6	28.3	24.3	228
7805DM-22	1098551	1	22	82.6	29.9	25.9	234
7805DM-24	1098568	1	24	82.6	32.0	28.0	296
7805DM-26	1098582	1	26	82.6	34.7	30.7	320
7805DM-27	1098599	1	27	82.6	36.2	32.2	353
7805DM-30	1098605	1	30	82.6	40.9	36.4	421



S80

HEXAGON METRIC

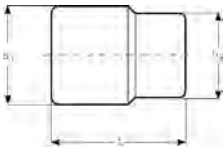

- Standard length sockets, 1/2" square drive
- Hex profile, metric sizes
- Not suitable for machine operation
- High performance alloy steel
- Matt finished
- ISO 2725/1174
- DIN 3124/3120
- Retail pack

	 731415		 mm	L mm	D1 mm	D2 mm	 g
SBS80-8	3013194	1	8	38	12.9	22.0	42
SBS80-9	3013200	1	9	38	14.2	22.0	42
SBS80-10	3009746	1	10	38	15.4	22.0	51
SBS80-11	3009753	1	11	38	16.6	22.0	51
SBS80-12	3009760	1	12	38	17.9	22.0	51
SBS80-13	3009777	1	13	38	19.1	22.0	53
SBS80-14	3009784	1	14	38	20.4	22.0	54
SBS80-15	3009791	1	15	38	21.6	22.0	64
SBS80-16	3009807	1	16	38	22.9	22.0	64
SBS80-17	3009814	1	17	38	24.1	23.0	72
SBS80-18	3009821	1	18	38	25.4	23.5	76
SBS80-19	3009838	1	19	38	26.6	24.0	80
SBS80-21	3009852	1	21	39	29.1	25.0	102
SBS80-22	3010117	1	22	38	30.4	25.5	109
SBS80-23	3009869	1	23	40	31.6	26.0	109
SBS80-24	3009876	1	24	41	32.9	26.5	121
SBS80-27	3009883	1	27	44	36.6	29.0	173
SBS80-30	3009890	1	30	47	40.4	29.5	189
SBS80-32	3009906	1	32	47	42.9	30.5	227

7800TORX-E

TORX®-E

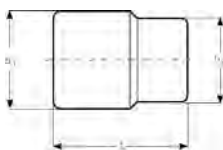

- TORX® sockets, 1/2" square drive
- For TORX® head screws
- Not suitable for machine operation
- High performance alloy steel
- High polished finish
- Knurled
- ISO 2725/1174
- DIN 3124/3120

	 731415			L mm	D1 mm	D2 mm		 g
7800TORX-E12	3011800	5	E12	38	22	22	M8+ M10	35
7800TORX-E14	3011756	5	E14	38	22	22	M10+M12	35
7800TORX-E16	3011763	5	E16	38	22	22	–	35
7800TORX-E18	3011770	5	E18	38	22	22	M12+M14	35
7800TORX-E20	3011787	5	E20	38	22	22	M14+M16	35
7800TORX-E24	3011794	5	E24	38	22	22	M18+M20	35



SOCKET DRIVERS 1/2"

7809F

FOR SLOTTED SCREWS

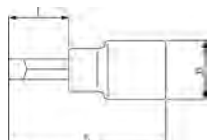

- 1/2" square drive socket drivers, for slotted head screws
- Not suitable for machine operation
- High performance alloy steel
- High polished finish
- Knurled
- ISO 1174
- ISO 3120

	 731415		L mm	l mm	$\frac{+}{-}$ mm	$\frac{+}{-}$ mm	D mm	 g
7809F-8	1830885	5	60	23	1.2	8.0	22	45
7809F-10	1830892	5	60	23	1.6	10.0	22	55

7809PH

FOR PHILLIPS HEAD SCREWS

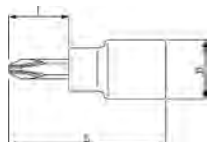

- 1/2" square drive socket drivers, for Phillips head screws
- Not suitable for machine operation
- High performance alloy steel
- High polished finish
- Knurled
- ISO 1174
- ISO 3120

	 731415			l mm	L mm	D mm	 g
7809PH-2	1830908	5	2	23	60	22	45
7809PH-3	1830915	5	3	23	60	22	50
7809PH-4	3003423	5	4	22	60	22	50

7809PZ

FOR POZIDRIV HEAD SCREWS

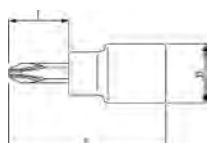

- 1/2" square drive socket drivers, for Pozidriv head screws
- Not suitable for machine operation
- High performance alloy steel
- High polished finish
- Knurled
- ISO 1174
- ISO 3120

	 731415			l mm	L mm	D mm	 g
7809PZ-2	3003430	5	2	23	60	22	50
7809PZ-3	3003447	5	3	23	60	22	50



7809TORX

FOR TORX® HEAD SCREWS

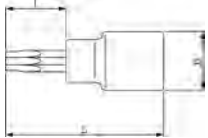

- 1/2" square drive socket drivers, for TORX® head screws
- Not suitable for machine operation
- High performance alloy steel
- High polished finish
- Knurled
- ISO 1174
- ISO 3120
- SB = Retail packed on a plastic info card

	 731415			I mm	L mm	D mm		
7809TORX-T20	1811730	5	T20	23	60	22	M 4	50
7809TORX-T25	1811747	5	T25	23	60	22	M 5	50
7809TORX-T27	1811754	5	T27	23	60	22	–	55
7809TORX-T30	1811761	5	T30	23	60	22	M 6	55
7809TORX-T40	1811778	5	T40	23	60	22	M 8	60
7809TORX-T45	1811785	5	T45	23	60	22	–	60
7809TORX-T50	1811792	5	T50	23	60	22	M 10	65
7809TORX-T55	1811808	5	T55	23	60	22	M 12	80
7809TORX-T60	1811815	5	T60	23	60	22	M 14	85
SB7809TORX-T20	3004017	1	T20	23	60	22	M 4	50
SB7809TORX-T25	3004024	1	T25	23	60	22	M 5	50
SB7809TORX-T27	3004031	1	T27	23	60	22	–	55
SB7809TORX-T30	3004048	1	T30	23	60	22	M 6	55
SB7809TORX-T40	3004055	1	T40	23	60	22	M 8	60
SB7809TORX-T45	3004062	1	T45	23	60	22	–	60
SB7809TORX-T50	3004079	1	T50	23	60	22	M 10	65
SB7809TORX-T55	3004086	1	T55	23	60	22	M 12	80
SB7809TORX-T60	3004093	1	T60	23	60	22	M 14	85



SOCKET DRIVERS 1/2"

7809M

HEX HEAD DRIVERS

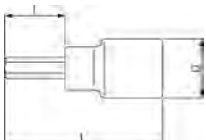

- 1/2" square drive socket drivers, for hex head screws
- Metric sizes
- Not suitable for machine operation
- High performance alloy steel
- High polished finish
- Knurled
- ISO 1174
- ISO 3120
- SB = Retail packed on a plastic info card

	 731415		 mm	I mm	L mm	D mm	 g
7809M-5	1815561	5	5	23	60	22	70
7809M-5-180	1830922	5	5	143	180	22	115
7809M-6	1815578	5	6	23	60	22	75
7809M-6-140	1830946	5	6	103	140	22	115
7809M-7	1815585	5	7	23	60	22	80
7809M-7-100	1830960	5	7	63	100	22	115
7809M-8	1815592	5	8	23	60	22	85
7809M-8-120	1830984	5	8	83	120	22	125
7809M-9	1830991	5	9	23	60	22	55
7809M-10	1815608	5	10	23	60	22	90
7809M-10-140	1831011	5	10	103	140	22	125
7809M-12	1815615	5	12	23	60	22	100
7809M-14	1815622	5	14	23	60	23	115
7809M-17	1831028	5	17	20	60	27	85
7809M-19	1831035	5	19	20	60	30	90
SB7809M-5	3004109	1	5	23	60	22	70
SB7809M-5-180	3004116	1	5	143	180	22	115
SB7809M-6	3004123	1	6	23	60	22	75
SB7809M-6-140	3013231	1	6	103	140	22	115
SB7809M-7	3004130	1	7	23	60	22	80
SB7809M-7-100	3004147	1	7	63	100	22	115
SB7809M-8	3004154	1	8	23	60	22	85
SB7809M-8-120	3004161	1	8	83	120	22	125
SB7809M-9	3004178	1	9	23	60	22	55
SB7809M-10	3004185	1	10	23	60	22	90
SB7809M-10-140	3004192	1	10	103	140	22	125
SB7809M-12	3004208	1	12	23	60	22	100
SB7809M-14	3004215	1	14	23	60	23	115
SB7809M-17	3004222	1	17	20	60	27	85
SB7809M-19	3004239	1	19	20	60	30	90



7809Z

HEX HEAD DRIVERS

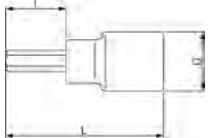

- 1/2" square drive socket drivers, for hex head screws
- Inch sizes
- Not suitable for machine operation
- High performance alloy steel
- High polished finish
- Knurled
- ISO 1174
- DIN 3120

	 731415			I mm	L mm	D mm	 g
7809Z-3/16	3003461	5	3/16	22	60	22	70
7809Z-1/4	3003478	5	1/4	22	60	22	70
7809Z-5/16	3003485	5	5/16	22	60	22	70
7809Z-3/8	3003492	5	3/8	22	60	22	90
7809Z-7/16	3003508	5	7/16	22	60	22	95
7809Z-1/2	3003515	5	1/2	22	60	22	90
7809Z-9/16	3003539	5	9/16	23	60	23	115
7809Z-19/32	3003546	5	19/32	23	60	23	115
7809Z-5/8	3003553	5	5/8	27	61	27	170

7809XZN

FOR MULTIPLE SCREWS

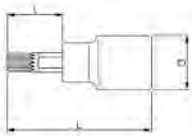

- 1/2" square drive socket drivers, for multipoint head screws (XZN)
- Metric sizes
- Not suitable for machine operation
- High performance alloy steel
- High polished finish
- Knurled
- ISO 1174
- DIN 3120

	 731415			I mm	L mm	D mm		 g
7809XZN-8	1831066	1	8	23	60	22	M 8	50
7809XZN-8-100	1831073	1	8	63	100	22	M 8	75
7809XZN-10	1831080	1	10	23	60	22	M 10	65
7809XZN-10-100	1831097	1	10	63	100	22	M 10	95
7809XZN-12	1831103	1	12	23	60	22	M 12	70
7809XZN-12-100	1831110	1	12	63	100	22	M 12	110
7809XZN-14	3004574	1	14	23	60	22	M 14	75
7809XZN-14-100	3004567	1	14	63	100	22	M 14	120



8155-1/2

REVERSIBLE RATCHET, ONE HAND

ergo®



- 1/2" ratchet, developed according to the scientific ERGO™ process
- 60 teeth/6° action angle
- High performance alloy steel
- High polished finish
- Easy change of direction with one hand, by a short turn of reversing ring, patented
- Quick release of sockets by pressing the locking button
- Integrated quick-turning disc to accelerate operation in fastening or releasing easy running screws
- Spare parts available
- ISO 3315/1174-2
- DIN 3122/3120; UNE 16512
- SB = Retail packed on a plastic info card

	 731415		 L mm	 g
8155-1/2	1827595	1	260	575
SB8155-1/2	0105021	1	260	575

8150-1/2

REVERSIBLE RATCHET



- 1/2" ratchet, reversible
- 80 teeth/4.5° action angle
- High performance alloy steel
- High polished finish
- Sealed
- Smooth operation
- Double pawl system for superior strength
- Patented mechanism
- Spare parts available
- ISO 3315/1174-2
- DIN 3122/3120; UNE 16512
- SB = Retail pack

	 731415		 L mm	 g
8150-1/2	1105006	1	270	585
SB8150-1/2	0105014	1	270	585



SBS81

REVERSIBLE RATCHET



- 1/2" ratchet, reversible
- 60 teeth/6° action angle
- High performance alloy steel
- Matt finish
- Quick release
- ISO 3315/1174-2
- DIN 3122/3120; UNE 16512
- Retail pack

	 731415		 mm	 g
SBS81	3009937	1	270	575

8150RN-1/2

REVERSIBLE RATCHET



- 1/2" ratchet, reversible
- 72 teeth/5° action angle
- High performance alloy steel
- High polished finish
- Direction indication arrow
- Patented
- Spare parts available
- ISO 3315/1174-2
- DIN 3122/3120; UNE 16512
- SB: Retail pack

	 731415		 mm	 g
8150RN-1/2	1831202	1	267	445
SB8150RN-1/2	0105007	1	267	445

SBS82

REVERSIBLE RATCHET



- 1/2" ratchet, reversible
- 60 teeth/6° action angle
- High performance alloy steel
- Matt finish
- ISO 3315/1174-2
- DIN 3122/3120; UNE 16512
- Retail pack

	 731415		 mm	 g
SBS82	3009944	1	270	470



ACCESSORIES 1/2"

8193-1/2

REVERSIBLE RATCHET



- 1/2" female square drive ratchet, reversible
- 7.5° action angle, without square drive
- High performance alloy steel
- High polished finish
- ISO 3315/1174-2
- DIN 3122/3120
- Male square drive adaptor 8194-1/2 supplied separately

	 731415		 L mm	 g
8193-1/2	1831219	1	255	310

8194-1/2

SQUARE DRIVE



- Fitting square drive for ratchet 8193-1/2
- High performance alloy steel
- High polished finish
- ISO 3315/1174
- DIN 3122/3123/3120
- Male square drive adaptor for 8193-1/2

	 731415		 L mm	 g
8194-1/2	1831226	1	32	40

8110-1/2

FLEX-HEAD RATCHET



- 1/2" flex-head ratchet, reversible
- 60 teeth/6° action angle
- High performance alloy steel
- High polished finish
- ISO 3315/1174-2
- DIN 3122/3120; UNE 16512
- SB = Retail packed on a plastic card

	 731415		 L mm	 g
8110-1/2	1808853	1	410	760
SB8110-1/2	3004246	1	410	760



8110H-1/2

FLEX-HEAD RATCHET



- 1/2" flex-head ratchet, reversible
- 32 teeth, 11.25° action
- High performance alloy steel
- High polished finish
- Quick release
- Heavy duty
- ISO 3315/1174-2
- DIN 3122/3120; UNE 16512

	 731415		 L mm	 g
8110H-1/2	3015860	1	450	925

8151-1/2

RATCHET ADAPTOR



- 1/2" ratchet adaptor
- 60 teeth/6° action angle
- High performance alloy steel
- High polished finish
- ISO 3315/1174
- DIN 3122/3123/3120
- Head diameter 36 mm

	 731415		 L mm	 g
8151-1/2	1105112	1	55	200

8152-1/2

SPEEDER



- 1/2" speeder, with rotary steel handle
- High performance alloy steel
- High polished finish
- ISO 3315/1174
- DIN 3122/3123/3120

	 731415		 L mm	 g
8152-1/2	1105129	1	417	690



ACCESSORIES 1/2"

8158-1/2

BREAKER BAR



- 1/2" breaker bar
- High performance alloy steel
- High polished finish
- ISO 3315/1174
- DIN 3122/3123/3120
- SB = Retail packed on a plastic info card

	 731415		 L mm	 g
8158-1/2	1105167	1	390	610
SB8158-1/2	3004253	1	390	610

S87

BREAKER BAR



- 1/2" breaker bars
- High performance alloy steel
- Matt finish
- ISO 3315/1174
- DIN 3122/3123/3120
- Retail pack

	 731415		 L mm	 g
SBS87S	3009951	1	257	450
SBS87	3009968	1	390	610

8167

OFFSET HANDLE



- 1/2" offset handle
- High performance alloy steel
- High polished finish
- ISO 3315/1174
- DIN 3122/3123/3120; UNE 16512

	 731415		H mm	 L mm	 g
8167-1/2	0181094	1	40	200	430



8154-1/2

SLIDING T-HANDLE



- 1/2" sliding T-handle
- High performance alloy steel
- High polished finish
- 100% sliding
- ISO 3315/1174
- DIN 3122/3123/3120; UNE 16512

	 731415		 mm	 g
8154-1/2	1105143	1	283	425

S86

SLIDING T-HANDLE



- 1/2" sliding T-handle
- High performance alloy steel
- Matt finish
- ISO 3315/1174
- DIN 3122/3123/3120
- Retail pack

	 731415		 mm	 g
SBS86	3009999	1	283	425

8159/8160/8162

EXTENSION BARS



- 1/2" extension bars
- High performance alloy steel
- High polished finish
- ISO 3316/1174
- DIN 3122/3123/3120; UNE 16511
- SB = Retail packed on a plastic info card

	 731415		 mm	 g
8159-1/2	1105198	1	75	120
8160-1/2	1105204	1	125	185
8162-1/2	1105211	1	250	365
SB8159-1/2	0104956	1	75	120
SB8160-1/2	0104963	1	125	185



ACCESSORIES 1/2"

S83

EXTENSION BARS



- 1/2" extension bars
- High performance alloy steel
- Matt finish
- ISO 3316/1174
- DIN 3122/3123/3120; UNE 16511
- Retail pack

	 731415			
SBS83-3	3013156	1	75	126
SBS83-5	3009975	1	125	120
SBS83-10	3009982	1	250	365

8159-W - 8162-W

EXTENSION BARS

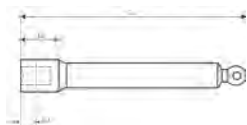

- 1/2" wobbler extension bars
- High performance alloy steel
- High polished finish
- ISO 3316/1174
- DIN 3120; UNE 16511

	 731415		L1 mm	L2 mm	L3 mm	
8159-W	0107186	1	75	24	10.7	135
8160-W	0107193	1	125	24	10.7	210
8162-W	0107209	1	250	24	10.7	420

8160-B

EXTENSION BARS



- 1/2" locking extension bar
- Finish: Chrome
- Material: Chrome vanadium
- To release and lock the socket, pull ring upwards

	 731415		D mm	L mm	
8160-B	0182565	1	24	150	135



8166-1/2



UNIVERSAL JOINT

- 1/2" universal joint
- High performance alloy steel
- High polished finish
- ISO 3316/1174
- DIN 3122/3123/3120; UNE 16511
- SB = Retail packed on a plastic info card

	 731415			
8166-1/2	1105280	1	72	160
SB8166-1/2	3004260	1	72	160

S85



UNIVERSAL JOINT

- 1/2" universal joint
- High performance alloy steel
- Matt finish
- ISO 3316/1174
- DIN 3122/3123/3120; UNE 16511
- Retail pack

	 731415			
SBS85	3010025	1	72	160

8168



UNIVERSAL JOINT

- 1/2" universal joint, smooth operation
- High performance alloy steel
- High polished finish
- ISO 3316/1174
- DIN 3122/3123/3120; UNE 16511
- Curved shapes give a very smooth movement transmission improving working efficiency
- Action spring for a correct fixing
- 45° action angle

	 731415			
8168	0128440	1	62	150

8165-1/2



ADAPTORS

- Decreasing adaptor for 1/2" square drive and 3/8" sockets
- High performance alloy steel
- High polished finish
- ISO 1174
- DIN 3120/3123; UNE 16503

	 731415					
8165-1/2	1105273	1	1/2	3/8	37	70



ACCESSORIES 1/2"

S88

ADAPTORS



- Decreasing adaptor for 1/2" square drive and 3/8" sockets
- High performance alloy steel
- Matt finish
- ISO 1174
- DIN 3120/3123; UNE 16503
- Retail pack

	 731415				 L mm	 g
SBS88	3010001	1	1/2"	3/8"	37	70

8964

ADAPTORS



- Increasing adaptor for 1/2" square drive and 3/4" sockets
- High performance alloy steel
- High polished finish
- ISO 1174
- DIN 3120/3123; UNE 16503

	 731415				 L mm	 g
8964	1106874	1	1/2"	3/4"	45	140

S89

ADAPTORS



- Increasing adaptor for 1/2" square drive and 3/4" sockets
- High performance alloy steel
- Matt finish
- ISO 1174
- DIN 3120/3123; UNE 16503
- Retail pack

	 731415				 L mm	 g
SBS89	3010018	1	1/2"	3/4"	45	140

8967

ADAPTORS



- Increasing flat adaptor for 1/2" square drive and 3/4" socket
- High performance alloy steel
- Galvanised finish
- With magnet in the drive disc
- ISO 1174
- DIN 3120; UNE 16503

	 731415				 L mm	 g
8967	3003591	1	1/2"	3/4"	22.0	59



7106

ADAPTORS

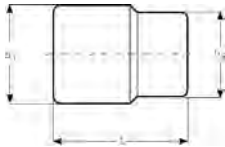

- 1/2" adaptor for 5/16" bits
- High performance alloy steel
- High polished finish
- ISO 1174
- DIN 3121; UNE 16503

	 841334			L mm	D1 mm	D2 mm	 g
7106S0080	5025171	1	5/16"	30	13	22	50

8967/

ADAPTOR SET



- Increasing flat adaptors set, 3 pcs
- Content: 7767, 8167 and 8967
- High performance alloy steel
- Galvanised finish
- With magnet in the drive disc
- ISO 1174
- DIN 3120; UNE 16503

	 731415			 g
8967/S3	3003607	1	30x194x110	109

8155-SO/1

SPARE PARTS ASSORTMENT



- Spare parts kit for 1/2" ratchet 8155-1/2
- Content: 6 pcs

	 731415		 g
8155-SO/1	3000811	1	120

8150-1/2-SPARE

SPARE PARTS ASSORTMENT



- Spare parts kit for 1/2" ratchet 8150-1/2

	 731415		 g
8150-1/2-SPARE	0187881	1	150



ACCESSORIES 1/2"

8150RN-1/2-SPARE

SPARE PARTS ASSORTMENT



- Spare parts kit for 1/2" ratchet 8150RN-1/2

	 731415		 g
8150RN-1/2-SPARE	0209378	1	150

8110-SO/1

SPARE PARTS ASSORTMENT



- Spare parts kit for 1/2" ratchet 8110-1/2
- Content: 7 pcs

	 731415		 g
8110-SO/1	1809751	1	128

8158-SO/1

SPARE PARTS ASSORTMENT



- Spare parts kit for 1/2" breaker bar 8158-1/2
- Content: 3 pcs

	 731415		 g
8158-SO/1	0111039	1	70

187/264/340

SOCKET RAILS



- Socket rails in zinc coated metal with 2 holes for screws, (-340 with 3 holes)
- Suitable for CLIPS-1/4 (1/4"), CLIPS-3/8 (3/8") and CLIPS-1/2 (1/2")
- Fitting sockets or socket drivers, in the respective square size

	 731415		 L mm	 g
RAIL-187	3003621	3	187	15
RAIL-264	3003638	3	264	20
RAIL-340	3003645	3	340	30



C1/2

CLIPS



- Rail-clips for 1/2" sockets and socket drivers
- Nickel plated, spring metal
- To be used on RAIL-187, -264 or -340

	 731415		 mm	 g
CLIPS-1/2	3003201	25	19	3

SOCKET SETS 1/2"



7819SRE

SOCKET SETS



- 1/2" socket set
- Includes 1/2" ratchet, developed according to the scientific ERGO™ process
- Hex sockets, metric sizes
- High performance alloy steel
- High polished finish
- Metal case
- Insert of elastic plastic material to secure the tools
- ISO 1174
- DIN 3120

	 731415		 mm	 g
7819SRE	1837921	1	312x115x50	1970

7800SM 10, 11, 12, 13, 17, 19, 22, 24 mm			8155-1/2	
8160-1/2 125 mm				

7819DME

SOCKET SETS



- 1/2" socket set
- Includes 1/2" ratchet, developed according to the scientific ERGO™ process
- Bi-hex sockets, metric sizes
- High performance alloy steel
- High polished finish
- Metal case
- Insert of elastic plastic material to secure the tools
- ISO 1174
- DIN 3120

	 731415		 mm	 g
7819DME	1838270	1	312x115x50	2570

7800DM 10, 13, 16, 17, 18, 19, 22, 24 mm			8155-1/2	
8160-1/2 125 mm				



SOCKET SETS 1/2"

7819HNRE



SOCKET SETS

- 1/2" socket set
- Includes 1/2" ratchet, developed according to the scientific ERGO™ process
- Hex sockets, metric sizes
- High performance alloy steel
- High polished finish
- Metal case
- Insert of elastic plastic material to secure the tools
- ISO 1174
- DIN 3120

	 731415		 mm	 g
7819HNRE	1837938	1	448x187x55	5725
7800SM	10, 11, 12, 13, 14, 15, 16, 17, 19, 22, 24, 27, 30, 32 mm			
8155-1/2		8154-1/2		
8160-1/2 125 mm		8162-1/2 250 mm		
8166-1/2				

7886SME



SOCKET SETS

- 1/2" socket set
- Includes 1/2" ratchet, developed according to the scientific ERGO™ process
- Hex sockets, metric sizes
- High performance alloy steel
- High polished finish
- Metal case
- Insert of elastic plastic material to secure the tools
- ISO 1174
- DIN 3120

	 731415		 mm	 g
7886SME	1837945	1	448x230x55	6250
7800SM	12, 13, 14, 15, 16, 17, 18, 19, 21, 22, 23, 24, 27, 30, 32 mm			
8155-1/2		8154-1/2		
8159-1/2 75 mm		8160-1/2 125 mm		
8162-1/2 250 mm		8166-1/2		



7886DME



SOCKET SETS

- 1/2" socket set
- Includes 1/2" ratchet, developed according to the scientific ERGO™ process
- Bi-hex sockets, metric sizes
- High performance alloy steel
- High polished finish
- Metal case
- Insert of elastic plastic material to secure the tools
- ISO 1174
- DIN 3120

	 731415		 mm	 g
7886DME	1837952	1	448x230x55	6145
7800DM	12, 13, 14, 15, 16, 17, 18, 19, 21, 22, 23, 24, 27, 30, 32 mm			
8155-1/2		8154-1/2		
8159-1/2 75 mm		8160-1/2 125 mm		
8162-1/2 250 mm		8166-1/2		

7819HRN



SOCKET SETS

- 1/2" socket set
- Hex sockets, metric sizes
- High performance alloy steel
- High polished finish
- Metal case
- Insert of elastic plastic material to secure the tools
- ISO 1174
- DIN 3120

	 731415		 mm	 g
7819HRN	1831493	1	448x230x55	6405
7800SM	10, 11, 12, 13, 14, 15, 16, 17, 18, 19, 21, 22, 23, 24, 25, 26, 27, 28, 30, 32 mm			
8150RN-1/2		8154-1/2		
8162-1/2 250 mm				



SOCKET SETS 1/2"

7819DRN

SOCKET SETS

- 1/2" socket set
- Bi-hex sockets, metric sizes
- High performance alloy steel
- High polished finish
- Metal case
- Insert of elastic plastic material to secure the tools
- ISO 1174
- DIN 3120



	 731415		 mm	 g
7819DRN	1831547	1	448x230x55	7100
7800DM	10, 11, 12, 13, 14, 15, 16, 17, 18, 19, 21, 22, 23, 24, 26, 27, 28, 30, 32 mm			
8150RN-1/2		8154-1/2		
8152-1/2		8160-1/2 125 mm		
8162-1/2 250 mm		8166-1/2		

7888SM

SOCKET SETS

- 1/2" socket set
- Hex sockets, metric sizes
- High performance alloy steel
- High polished finish
- Metal case
- Insert of elastic plastic material to secure the tools
- ISO 1174
- DIN 3120



	 731415		 mm	 g
7888SM	1820916	1	448x230x55	7075
7800SM	10, 11, 12, 13, 14, 15, 16, 17, 18, 19, 21, 22, 23, 24, 25, 27, 30, 32 mm			
8150-1/2		8158-1/2		
8154-1/2		8159-1/2 75 mm		
8160-1/2 125 mm		8162-1/2 250 mm		
8166-1/2				



7888DM

SOCKET SETS



- 1/2" socket set
- Bi-hex sockets, metric sizes
- High performance alloy steel
- High polished finish
- Metal case
- Insert of elastic plastic material to secure the tools
- ISO 1174
- DIN 3120

	 731415		 mm	 g
7888DM	1820923	1	448x230x55	6955
7800DM	10, 11, 12, 13, 14, 15, 16, 17, 18, 19, 21, 22, 23, 24, 25, 27, 30, 32 mm			
8150-1/2		8158-1/2		
8154-1/2		8159-1/2 75 mm		
8160-1/2 125 mm		8162-1/2 250 mm		
8166-1/2				

7819JE

SOCKET SETS



- 1/2" socket set
- Includes 1/2" ratchet, developed according to the scientific ERGO™ process
- Hex sockets, metric sizes
- Socket drivers
- High performance alloy steel
- High polished finish
- Metal case
- Insert of elastic plastic material to secure the tools
- ISO 1174
- DIN 3120

	 731415		 mm	 g
7819JE	1837976	1	448x187x55	5585
7800SM	10, 11, 12, 13, 14, 15, 17, 19, 22, 24, 27, 30 mm			
8155-1/2		8154-1/2 300 mm		
7809F 1.2x8, 1.6x10 mm		7809PH PH 2, 3		
7809M 5, 6, 7, 8, 10, 12, 14 mm		8160-1/2 125 mm		
8166-1/2				



SOCKET SETS 1/2"

7819DZE

SOCKET SETS



- 1/2" socket set
- Includes 1/2" ratchet, developed according to the scientific ERGO™ process
- Bi-hex sockets, inch sizes
- High performance alloy steel
- High polished finish
- Metal case
- Insert of elastic plastic material to secure the tools
- ISO 1174
- DIN 3120

	 731415		 mm	 g
7819DZE	1838287	1	312x115x50	2570
7800DZ 1/2, 9/16, 5/8, 11/16, 3/4, 7/8, 15/16			8155-1/2	
8160-1/2 125 mm				

7819DZ

SOCKET SETS



- 1/2" socket set
- Bi-hex sockets, inch sizes
- High performance alloy steel
- High polished finish
- Metal case
- Insert of elastic plastic material to secure the tools
- ISO 1174
- DIN 3120

	 731415		 mm	 g
7819DZ	1831516	1	448x187x55	6130
7800DZ 3/8, 7/16, 1/2, 9/16, 19/32, 5/8, 11/16, 3/4, 25/32, 13/16, 7/8, 15/16, 1, 1 1/16, 1 1/8, 1 3/16				
8150RN-1/2			8154-1/2	
8162-1/2 250 mm			8166-1/2	



7886DZE

SOCKET SETS



- 1/2" socket set
- Includes 1/2" ratchet, developed according to the scientific ERGO™ process
- Bi-hex sockets, inch sizes
- High performance alloy steel
- High polished finish
- Metal case
- Insert of elastic plastic material to hold the tools
- ISO 1174
- DIN 3120

	 731415		 mm	 g
7886DZE	1837969	1	448x230x55	6235
7800DZ	7/16, 1/2, 9/16, 19/32, 5/8, 11/16, 3/4, 25/32, 13/16, 7/8, 15/16, 1, 1 1/16, 1 3/16, 1 1/4			
8155-1/2		8154-1/2		
8159-1/2 75 mm		8160-1/2 125 mm		
8162-1/2 250 mm		8166-1/2		

4003M

SOCKET SETS



- 1/2" socket set
- Bi-hex sockets, metric sizes
- Combination spanners
- High performance alloy steel
- High polished finish
- Metal case with metal inlay
- ISO 1174
- DIN 3120

	 731415		 mm	 g
4003M	1077372	1	544x303x59	12300
1952M	10, 11, 12, 13, 14, 15, 16, 17, 18, 19, 22, 24, 27, 32 mm			
7800DM	10, 11, 12, 13, 14, 15, 16, 17, 18, 19, 20, 21, 22, 23, 24, 25, 26, 27, 28, 30, 32 mm			
8150-1/2		8158-1/2		
8154-1/2		8160-1/2 125 mm		
8162-1/2 250 mm		8166-1/2		



SOCKET SETS 1/2"

S80/

SOCKET SETS



S80/8



S80/17

- 1/2" socket set
- Hex sockets, metric sizes
- High performance alloy steel
- Matt finish
- Plastic rail holder
- ISO 1174
- DIN 3120

	 731415		 mm	 mm	 g
S80/6	3013163	1	10 13 16 17 19 24	235x75x33	365
S80/8	3013170	1	10 12 13 16 17 18 19 24	315x75x34	402
S80/17	3013187	1	10 11 12 13 14 15 16 17 18 19 21 22 24 27 30 32 & S82	180x165x60	1380

7809M/10

HEX HEAD DRIVERS



- 1/2" socket drivers set
- Hex socket drivers, metric sizes
- High performance alloy steel
- High polished finish
- Metal case
- Plastic inlay
- ISO 1174
- DIN 3120



	 731415		 mm	 g
7809M/10	1831448	1	312x115x50	1490
7809M	5, 6, 7, 8, 9, 10, 12, 14, 17, 19 mm			

7809Z/10

HEX HEAD DRIVERS



- 1/2" socket drivers set
- Hex socket drivers, inch sizes
- High performance alloy steel
- High polished finish
- Metal case
- Plastic inlay
- ISO 1174
- DIN 3120



	 731415		 mm	 g
7809Z/10	3003560	1	312x115x50	1990
7809Z	3/16, 1/4, 5/16, 3/8, 7/16, 1/2, 17/32, 9/16, 19/32, 5/8			



7809TORX/10

FOR TORX® AND PHILLIPS HEAD SCREWS



- 1/2" socket drivers set
- Socket drivers, TORX® and Phillips sizes
- High performance alloy steel
- High polished finish
- Metal case
- Plastic inlay
- ISO 1174
- DIN 3120

	 731415		 mm	 g
7809TORX/10	1831455	1	312x115x50	1490

7809TORX T 20, 25, 27, 30, 40, 45, 50, 55



7809PH PH 2, 3



SOCKETS 3/4"



8900SM

HEXAGON METRIC



- Standard length sockets, 3/4" square drive
- Hex profile, metric sizes
- Not suitable for machine operation
- High performance alloy steel
- High polished finish
- Knurled
- ISO 2725/1174
- DIN 3124/3120

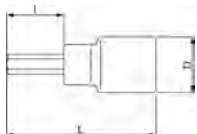

	 731415		 mm	L mm	D1 mm	D2 mm	 g
8900SM-22	1810795	1	22	47	33.0	40	140
8900SM-24	1810801	1	24	50	35.5	40	175
8900SM-27	1810818	1	27	53	38.5	40	210
8900SM-30	1810825	1	30	58	42.5	40	270
8900SM-32	1810832	1	32	58	45.0	40	280
8900SM-34	1838461	1	34	60	48.0	40	320
8900SM-36	1810849	1	36	63	50.0	40	355
8900SM-38	1810856	1	38	66	52.0	40	370
8900SM-41	1810863	1	41	66	56.0	40	425
8900SM-46	1810870	1	46	68	62.5	40	535
8900SM-50	1810887	1	50	68	67.5	40	580
8900SM-55	1810894	1	55	69	74.0	45	830
8900SM-60	1810900	1	60	72	80.5	45	960



SOCKETS 3/4"

8900DM

DOUBLE HEXAGON METRIC



- Standard length sockets, 3/4" square drive
- Bi-hex profile, metric sizes
- Not suitable for machine operation
- High performance alloy steel
- High polished finish
- Knurled
- ISO 2725/1174
- DIN 3124/3120

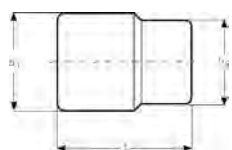

	 731415		 mm	L mm	D1 mm	D2 mm	 g
8900DM-19	1105730	1	19	47	29.5	40	130
8900DM-22	1105754	1	22	47	33.0	40	140
8900DM-24	1105778	1	24	50	35.5	40	175
8900DM-25	1105785	1	25	53	36.5	40	190
8900DM-27	1105822	1	27	53	38.5	40	210
8900DM-28	1105846	1	28	53	40.0	40	230
8900DM-30	1105884	1	30	58	42.5	40	270
8900DM-32	1105891	1	32	58	45.0	40	280
8900DM-34	1838478	1	34	60	48.0	40	320
8900DM-36	1105914	1	36	63	50.0	40	355
8900DM-41	1105938	1	41	66	56.0	40	425
8900DM-46	1105952	1	46	68	62.5	40	535
8900DM-50	1105969	1	50	68	67.5	40	580
8900DM-55	1105983	1	55	69	74.0	45	830
8900DM-60	1106003	1	60	72	80.5	45	960

8900DZ

DOUBLE HEXAGON INCH



- Standard length sockets, 3/4" square drive
- Bi-hex profile, inch sizes
- Not suitable for machine operation
- High performance alloy steel
- High polished finish
- Knurled
- ISO 2725/1174
- DIN 3124/3120

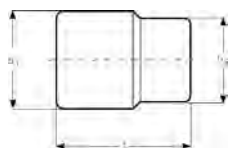

	 731415		 "	L mm	D1 mm	D2 mm	 g
8900DZ-15/16	1106034	1	15/16	50	35.5	40	170
8900DZ-1	1106058	1	1	53	36.5	40	180
8900DZ-1.1/16	1106065	1	1 1/16	53	38.5	40	200
8900DZ-1.1/8	1106072	1	1 1/8	53	40.0	40	215
8900DZ-1.3/16	1106089	1	1 3/16	58	42.5	40	240
8900DZ-1.1/4	1106096	1	1 1/4	58	45.0	40	275
8900DZ-1.5/16	1106102	1	1 5/16	61	48.5	40	300
8900DZ-1.3/8	1106119	1	1 3/8	63	48.5	40	300
8900DZ-1.7/16	1106126	1	1 7/16	63	50.0	40	325
8900DZ-1.1/2	1106133	1	1 1/2	66	52.0	40	375
8900DZ-1.5/8	1106157	1	1 5/8	66	56.0	40	420
8900DZ-1.3/4	1106171	1	1 3/4	68	62.5	40	480
8900DZ-1.13/16	1106188	1	1 13/16	68	62.5	40	500
8900DZ-1.7/8	1106195	1	1 7/8	68	64.5	40	530
8900DZ-2	1106201	1	2	68	67.5	40	585



8950N

REVERSIBLE RATCHET



- 3/4" ratchet, reversible
- 72 teeth/5° action angle
- High performance alloy steel
- High polished finish
- ISO 3315/1174-2
- DIN 3122/3120; UNE 16512
- Consisting of ratchet head 8950 N/A and universal handle 8953

	 731415		 L mm	 g
8950N	1810931	1	610	2550

8952N

REVERSIBLE RATCHET



- 3/4" ratchet, reversible
- 24 teeth/15° action angle
- High performance alloy steel
- High polished finish
- Push through square drive to change direction
- Consisting of ratchet head 8952 N/A and universal handle 8952 N/B
- ISO 3315/1174-2
- DIN 3122/3120; UNE 16512

	 731415		 L mm	 g
8952N	0180196	1	525	2160

8953

UNIVERSAL HANDLE



- 3/4" universal handle
- High performance alloy steel
- High polished finish
- For ratchet head 8950 N/A, breaker bar 8958A and sliding head 8954A
- ISO 3315/3316
- DIN 3122/3123

	 731415		 L mm	 g
8953	1106799	1	505	1470



ACCESSORIES 3/4"

8952N/B

UNIVERSAL HANDLE



- Universal handle 3/4
- DIN 3122 , ISO 3315
- Finish: Nickel and chrome plated
- Material: Vanadium extra
- For ratchet head No. 8952N/A

8952N/B	731415 0180219	1	450 mm	1085 g

8950N/A

RATCHET HEAD



- 3/4" ratchet head, reversible
- 72 teeth/5° action angle
- High performance alloy steel
- High polished finish
- ISO 3315/1174
- DIN 3122/3120; UNE 16512
- 8950N/A + 8953 = 8950N

8950N/A	731415 1810948	1	170 mm	1080 g

8952N/A

RATCHET HEAD



- 3/4" ratchet head, reversible
- 24 teeth/15° action angle
- High performance alloy steel
- High polished finish
- Changes tightening direction by moving the square drive
- 8952N/A + 8952N/B = 8952N
- ISO 3315/1174
- DIN 3122/3120; UNE 16512

8952N/A	731415 0180202	1	145 mm	1130 g



8951

RATCHET ADAPTOR



- 3/4" ratchet adaptor, reversible
- 60 teeth/6° action angle
- High performance alloy steel
- High polished finish
- ISO 3315/1174
- DIN 3122/3123/3120
- Max diameter head: 60 mm

	 731415		 L mm	 g
8951	1106782	1	95	1080

8954

SLIDING T-HANDLE



- 3/4" sliding T-handle
- High performance alloy steel
- High polished finished
- ISO 3315/1174
- DIN 3122/3123/3120; UNE 16512
- Plastic handle
- Consisting of universal handle 8953 and sliding head 8954A

	 731415		 L mm	 g
8954	1106805	1	505	1760

8954A

SLIDING HEAD



- 3/4" sliding T-head
- High performance alloy steel
- High polished finished
- ISO 1174
- DIN 3120
- 8954A + 8953 = 8954

	 731415		 L mm	 g
8954A	1106812	1	62	290



ACCESSORIES 3/4"

8958

BREAKER BAR



- 3/4" breaker bar
- High performance alloy steel
- High polished finish
- ISO 3315/1174
- DIN 3122/3120; UNE 16512
- Consisting of flex head 8958A and universal handle 8953

	 731415		 L mm	 g
8958	1106829	1	570	2275

8958A

BREAKER BAR HEAD



- 3/4" breaker bar flex head
- High performance alloy steel
- High polished finish
- ISO 1174
- DIN 3120
- 8958A + 8953 = 8958

	 731415		 L mm	 g
8958A	1106836	1	125	805

8963

OFFSET HANDLE



- 3/4" offset handle
- High performance alloy steel
- High polished finish
- ISO 3315/1174
- DIN 3122/3120; UNE 16512

	 731415		 L mm	 g
8963	0181087	1	415	1710



8961/8962

EXTENSION BARS



- 3/4" extension bars
- High performance alloy steel
- High polished finish
- ISO 3316/1174
- DIN 3123/3120; UNE 16511

	 731415		 L mm	 g
8961	1106850	1	200	665
8962	1106867	1	400	1190

8966

UNIVERSAL JOINT



- 3/4" universal joint
- High performance alloy steel
- High polished finish
- ISO 3316/1174
- DIN 3122/3123/3120; UNE 16511

	 731415		 L mm	 g
8966	1106898	1	103.5	540

8965

ADAPTORS



- Decreasing adaptor for 3/4" square drive and 1/2" sockets
- High performance alloy steel
- High polished finish
- ISO 1174
- DIN 3120/3123; UNE 16503

	 731415				 L mm	 g
8965	1106881	1	3/4	1/2	58	260

9564

ADAPTORS



- Increasing adaptor for 3/4" square drive and 1" sockets
- High performance alloy steel
- High polished finish
- ISO 1174
- DIN 3120/3123; UNE 16503

	 731415				 L mm	 g
9564	1107543	1	3/4"	1"	62	345



ACCESSORIES 3/4"

8950NA-SO/2

SPARE PARTS ASSORTMENT

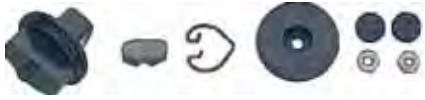

- Spare parts kit for 3/4" ratchets 8950N, 8950N/A
- Content: 8 pce

	 731415		 g
8950NA-SO/2	1816605	1	546

744T

SPARE PARTS ASSORTMENT



744T01190

- Spare parts kit for 3/4" ratchets 8952N, 8952N/A
- 744T01190 spare reversible square drive
- 744T00000 full repair kit



744T00000

	 841334		 g
744T01190	5206761	1	170
744T00000	5210638	1	340



SOCKET SETS 3/4"

8845NM

SOCKET SETS METRIC



- 3/4" socket set
- Hex sockets, metric sizes
- High performance alloy steel
- High polished finish
- Metal case with metallic inlay
- ISO 1174
- DIN 3120

	 731415		 mm	 g
8845NM	1810955	1	591x206x94	13200

8900SM	22, 24, 27, 30, 32, 36, 38, 41, 46, 50 mm		
8953		8950N/A	
8954A		8961 200 mm	
8962 400 mm			



8845DM

SOCKET SETS METRIC



- 3/4" socket set
- Bi-hex sockets, metric sizes
- High performance alloy steel
- High polished finish
- Metal case with metallic inlay
- ISO 1174
- DIN 3120

	 731415		 mm	 g
8845DM	1105525	1	591x206x94	13200
8900DM	19, 22, 24, 27, 30, 32, 36, 41, 46, 50 mm			
8953		8950N/A		
8954A		8961 200 mm		
8962 400 mm				

8840M

SOCKET SETS METRIC



- 3/4" socket set
- Bi-hex sockets, metric sizes
- High performance alloy steel
- High polished finish
- Metal case with metallic inlay
- ISO 1174
- DIN 3120

	 731415		 mm	 g
8840M	1105495	1	595x210x100	21200
8900DM	19, 22, 24, 25, 27, 28, 30, 32, 36, 41, 46, 50, 55, 60 mm			
8953		8950N/A		
8954A		8961 200 mm		
8962 400 mm		8951		
8966		8964		
8965		8958A		



SOCKETS 1"

9500SM

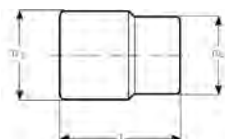

HEXAGON METRIC

- Standard length sockets, 1" square drive
- Hex profile, metric sizes
- Not suitable for machine operation
- High performance alloy steel
- Matt finish
- ISO 2725/1174
- DIN 3124/3120
- With locking pin for release from square drive

	 731415		 mm	L mm	D1 mm	D2 mm	 g
9500SM-41	3013699	1	41	67	57	48	625
9500SM-46	3013705	1	46	71	63	48	740
9500SM-50	3013712	1	50	74	69	48	880
9500SM-54	3013729	1	54	78	74	48	1040
9500SM-55	3013736	1	55	79	75	54	1175
9500SM-58	3013743	1	58	82	79	54	1285
9500SM-60	3013750	1	60	83	82	54	1360
9500SM-63	3013767	1	63	85	86	54	1590
9500SM-65	3013774	1	65	86	88	54	1625
9500SM-67	3013781	1	67	89	90	54	1725
9500SM-70	3013798	1	70	91	94	60	1970
9500SM-71	3013804	1	71	92	95	60	2025
9500SM-75	3013811	1	75	95	101	60	2300
9500SM-77	3013828	1	77	98	103	60	2500
9500SM-80	3013835	1	80	101	108	60	2885
9500SM-82	3013842	1	82	104	110	60	2900

9500SZ

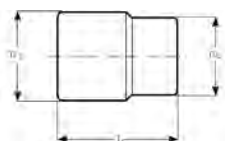

HEXAGON INCH

- Standard length sockets, 1" square drive
- Hex profile, inch sizes
- Not suitable for machine operation
- High performance alloy steel
- Matt finish
- ISO 2725/1174
- DIN 3124/3120
- With locking pin for release from square drive

	 731415		 "	L mm	D1 mm	D2 mm	 g
9500SZ-1.5/8	3013859	1	1.5/8	67	57	48	620
9500SZ-1.13/16	3013866	1	1.13/16	71	63	48	745
9500SZ-1.7/8	3013873	1	1.7/8	73	65	48	785
9500SZ-2	3013880	1	2	74	69	48	875
9500SZ-2.1/8	3013897	1	2.1/8	78	74	48	1050
9500SZ-2.3/16	3013903	1	2.3/16	79	75	54	1110
9500SZ-2.1/4	3013910	1	2.1/4	82	79	54	1310
9500SZ-2.3/8	3013927	1	2.3/8	83	82	54	1380
9500SZ-2.1/2	3013934	1	2.1/2	85	86	54	1530
9500SZ-2.9/16	3013941	1	2.9/16	86	88	54	1610
9500SZ-2.5/8	3013958	1	2.5/8	89	90	54	1765
9500SZ-2.3/4	3013965	1	2.3/4	91	94	60	1865
9500SZ-2.15/16	3013972	1	2.15/16	95	101	60	1965
9500SZ-3	3013989	1	3	98	103	60	2320
9500SZ-3.1/8	3013996	1	3.1/8	101	108	60	2585



9551

REVERSIBLE RATCHET



- 1" ratchet, reversible
- 72 teeth/5° action angle
- High performance alloy steel
- Matt finish
- ISO 3315/1174-2
- DIN 3122/3120; UNE 16512
- Consisting of ratchet head 9550AB and universal handle 9552AB

	 731415		 L mm	 g
9551	3014030	1	640	3810

9550AB

RATCHET HEAD



- 1" ratchet head, reversible
- 72 teeth/5° action angle
- High performance alloy steel
- Matt finish
- ISO 3315/1174-2
- DIN 3122/3120; UNE 16512
- Together with universal handle 9552AB it completes the ratchet 9551
- 9550AB + 9552AB = 9551

	 731415		 L mm	 g
9550AB	3014009	1	190	1870

9552AB

UNIVERSAL HANDLE



- 1" universal handle
- High performance alloy steel
- Matt finish
- ISO 3315/1174
- DIN 3122/3120; UNE 16512
- For ratchet head 9550AB and sliding head 9555AB

	 731415		 L mm	 g
9552AB	3014023	1	508	1945



ACCESSORIES 1"

9555

SLIDING T-HANDLE



- 1" sliding T-handle
- High performance alloy steel
- Matt finished
- ISO 3315/1174
- DIN 3122/3120

	 731415		 mm	 g
9555	3014047	1	508	2625

9555AB

SLIDING HEAD



- 1" sliding T-head
- High performance alloy steel
- Matt finished
- ISO 1174
- DIN 3120
- Together with universal handle 9550AB completes the sliding T-handle 9555
- 9555AB + 9550AB = 9555

	 731415		 mm	 g
9555AB	3014061	1	78x78x78	685

9560AB/9563AB

EXTENSION BARS



- 1" extension bars
- High performance alloy steel
- Matt finish
- ISO 3316/1174
- DIN 3123/3120; UNE 16511

	 731415		 mm	 g
9560AB	3014078	1	200	1175
9563AB	3014085	1	400	2085

9565AB

ADAPTOR



- Decreasing adaptor for 1" square drive and 3/4" sockets
- High performance alloy steel
- Matt finish
- ISO 1174/3316
- DIN 3120/3123; UNE 16503

	 731415				 mm	 g
9565AB	3014092	1	1"	3/4"	72	550



9550AB-SO/1

SPARE PARTS ASSORTMENT



- Spare parts kit for 1" reversible ratchets 9551 and 9550AB
- Content: 5 pce

9550AB-SO/1	731415 3014016	1	610 g

SOCKET SETS 1"



9540MB

SOCKET SETS METRIC



- 1" socket set
- High performance alloy steel
- Matt finish
- Metal case with metal inlay to hold the tools
- ISO 1174
- DIN 3120

9540MB	731415 3014108	1	120x560x210 mm	26000 g
9500SM	46, 50, 55, 60, 65, 70, 75, 80 mm			
9550AB		9555		
9560AB 200 mm		9563AB 400 mm		



SOCKET SETS 1"

9540MBL

SOCKET SETS METRIC



- 1" socket set
- High performance alloy steel
- Matt finish
- Metal case with metal inlay to hold the tools
- ISO 1174
- DIN 3120

	 731415		 mm	 g
9540MBL	3014115	1	120x605x225	37600

9500SM	46, 50, 54, 55, 58, 60, 63, 65, 67, 70, 71, 75, 77, 80 mm		
9550AB		9555	
9560AB 200 mm		9563AB 400 mm	
9565AB			

9540ZB

SOCKET SETS INCH



- 1" socket set
- High performance alloy steel
- Matt finish
- Metal case with metal inlay
- ISO 1174
- DIN 3120

	 731415		 mm	 g
9540ZB	3014122	1	120x560x210	26200

9550SZ	1.13/16, 2, 2.3/16, 2.3/8, 2.5/8, 2.3/4, 3, 3.1/8		
9550AB		9555	
9560AB 200 mm		9563AB 400 mm	



9540ZBL

SOCKET SETS INCH



- 1" socket set
- High performance alloy steel
- Matt finish
- Metal case with metal inlay
- ISO 1174
- DIN 3120

	 731415		 mm	 g
9540ZBL	3014139	1	120x605x225	36.5
9500SZ	1.13/16, 1.7/8, 2, 2.1/8, 2.3/16, 2.1/4, 2.3/8, 2.1/2, 2.9/16, 2.5/8, 2.3/4, 2.15/16, 3, 3.1/8			
9550AB		9555		
9560AB 200 mm		9563AB 400 mm		
9565AB				

SOCKET SETS



SL24

SOCKET SETS 1/4"



- 1/4" socket set
- High performance alloy steel
- Matt finish
- ISO 1174
- DIN 3120
- Case: High Density Polythene (HDPE), 35 x 165 x 85 mm
- Contents, 24 pcs
 - 1 pc ratchet 1/4" quick release, extra narrow head, 72 teeth 5° action angle
 - 6 pcs 1/4" hex sockets: 4, 5, 6, 7, 8, 10 mm
 - 2 pcs bits 1/4" slotted: 4, 5 mm
 - 3 pcs bits 1/4": PH 1, 2, 3
 - 2 pcs bits hex: 4, 5 mm
 - 1 pc locking bit socket 1/4" x 1/4"
 - 4 pcs bits TORX®: T 10, 15, 20, 25
 - 3 pcs bits 1/4" Pozidriv PZ 1, 2, 3
 - 1 pc 1/4" smooth operation universal joint
 - 1 pc 1/4" locking extension bar, length 100 mm

	 731415		 mm	 g
SL24	0128389	1	35x165x85	430



SOCKET SETS

SL25



SOCKET SETS 1/4"

- 1/4" socket set
- High performance alloy steel
- Matt finish
- ISO 1174
- DIN 3120
- Case: High Density Polythene (HDPE), 35x165x85 mm
- Contents, 25 pce
 - 12 pcs 1/4" hex sockets: 4, 4.5, 5, 5.5, 6, 7, 8, 9, 10, 11, 12, 13 mm
 - 1 pc ratchet 1/4" compact length 125 mm, quick release, 60 teeth/ 6° action angle
 - 2 pcs bit 1/4" PH 2
 - 2 pcs bit HEX 5, 6
 - 6 pcs bit TORX® 10, 15, 20, 25, 30, 40
 - 1 pcs bit holder 1/4" with locking spring, 1/4" female square
 - 1 pcs 1/4" wobblers extension bar, length 100 mm
- SB = Retail packaging

	 731415		 mm	 g
SL25	3013422	1	35x165x85	235
SBSL25	3015853	5	280x205x55	580

S160



SOCKET SETS 1/4"

- 1/4" socket set
- High performance alloy steel
- Matt finish
- ISO 1174
- DIN 3120
- Case: High Density Polythene (HDPE)
- Contents, 16 pcs
 - 12 pcs 1/4" hex sockets: 4, 4.5, 5, 5.5, 6, 7, 8, 9, 10, 11, 12, 13 mm
 - 1 pc 1/4" ratchet quick release, 60 teeth / 6° action angle
 - 1 pc 1/4" sliding T-bar, 100 mm / 4"
 - 1 pc 1/4" extension bar, 75 mm / 3"
 - 1 pc 1/4" flexible extension bar 150 mm / 6"
 - 2 pc removable three section plastic box with lid

	 731415		 mm	 g
S160	0104031	1	280x160x70	1060



S160AF

SOCKET SETS 1/4"



- 1/4" socket set
- High performance alloy steel
- Matt finish
- ISO 1174
- DIN 3120
- Case: High Density Polythene (HDPE)
- Contents, 16 pcs
 - 12 pcs 1/4" hex sockets: 1/8", 5/32", 3/16", 7/32", 1/4", 9/32", 5/16", 11/32", 3/8", 7/16", 1/2", 9/16"
 - 1 pc 1/4" ratchet quick release, 60° teeth/6° action angle
 - 1 pc 1/4" sliding T-bar, 100 mm / 4"
 - 1 pc 1/4" extension bar, 75 mm / 3"
 - 1 pc 1/4" flexible extension bar 150 mm / 6"
 - 2 pc removable three section plastic box with lid

	 731415		 mm	 g
S160AF	0137510	1	280x158x70	1025

S290

SOCKET SETS 1/4"



- 1/4" socket set
- High performance alloy steel
- Matt finish
- ISO 1174
- DIN 3120
- Case: High Density Polythene (HDPE)
- Contents, 29 pcs
 - 12 pcs 1/4" hex sockets: 4, 4.5, 5, 5.5, 6, 7, 8, 9, 10, 11, 12, 13 mm
 - 1 pc 1/4" ratchet quick release, 60 teeth / 6° action angle
 - 3 pcs 1/4" socket drivers: PH 1, 2, 3
 - 3 pcs 1/4" socket drivers: slotted 4, 5.5, 7 mm
 - 5 pcs 1/4" socket drivers: hex 3, 4, 5, 6, 8 mm
 - 1 pc 1/4" extension bar 50 mm / 2"
 - 1 pc 1/4" extension bar 150 mm / 6"
 - 1 pc 1/4" sliding T-bar 100 mm / 4"
 - 1 pc 1/4" universal joint
 - 1 pc 1/4" spinner with 2-components handle
 - 2 pc removable three section plastic box with lid

	 731415		 mm	 g
S290	3000859	6	280x160x70	1300



SOCKET SETS

S460



SOCKET SETS 1/4"

- 1/4" socket set
- High performance alloy steel
- Matt finish
- ISO 1174
- DIN 3120
- Case: High Density Polythene (HDPE)
- Contents, 46 pcs
 - 12 pcs 1/4" hex sockets: 4, 4.5, 5, 5.5, 6, 7, 8, 9, 10, 11, 12, 13 mm
 - 1 pc 1/4" ratchet quick release, 60 teeth/6° action angle
 - 4 pcs 1/4" socket drivers: PH 1, 2, 3, 4
 - 3 pcs 1/4" socket drivers: slotted 4, 5.5, 7 mm
 - 6 pcs 1/4" socket drivers: hex 3, 4, 5, 6, 8, 10 mm
 - 7 pcs 1/4" socket drivers: T 8, 10, 15, 20, 25, 27, 30
 - 3 pcs 1/4" TORX® sockets: E 6, 7, 8
 - 1 pc 1/4" spinner disc
 - 2 pcs 1/4" extension bars 2" & 4"
 - 1 pc 1/4" sliding T-bar
 - 1 pc 1/4" universal joint
 - 1 pc 1/4" spinner with 2-component handle
 - 1 pc 1/4" flexible extension bar 6"
 - 3 pcs L-Keys: hex 1.5, 2, 2.5 mm
 - 3 pcs removable three section plastic box with lid



S460



731415

0111060



6



375x215x100



2220

S330



SOCKET SET 1/4" AND 3/8"

- 1/4" and 3/8" socket set
- High performance alloy steel
- Matt finish
- ISO 1174
- DIN 3120
- Case: High Density Polythene (HDPE)
- Contents, 34 pcs
 - 12 pcs 3/8" hex sockets: 10, 11, 12, 13, 14, 15, 16, 17, 18, 19, 20, 22 mm
 - 1 pc 3/8" ratchet quick release, 60 teeth / 6° action angle
 - 2 pcs 3/8" extension bars 75 mm / 3" & 150 mm / 6"
 - 1 pc 3/8" universal joint
 - 1 pc 3/8" x 1/4" bit holder
 - 2 pcs 3/8" spark plug sockets hex: 16 mm (5/8"), 21 mm (13/16")
 - 1 pc 1/4" spinner with 2-component handle
 - 1 pc 1/4" x 1/4" bit holder
 - 3 pcs 1/4" bits: slotted 4, 5.5, 7 mm
 - 4 pcs 1/4" bits: PH 1, 2, 3, 4,
 - 6 pcs 1/4" bits: Hex 3, 4, 5, 6, 7, 8 mm



S330



731415

0104024



6



280x160x70



2040



S330AF

SOCKET SET 1/4" AND 3/8"



- 1/4" and 3/8" socket set
- High performance alloy steel
- Matt finish
- ISO 1174
- DIN 3120
- Case: High Density Polythene (HDPE)
- Contents, 34 pcs
 - 12 pcs 3/8" hex sockets: 1/4", 5/16", 11/32", 3/8", 7/16", 1/2", 9/16", 5/8", 11/16", 3/4", 13/16", 7/8"
 - 1 pc 3/8" ratchet quick release, 60 teeth / 6° action angle
 - 2 pcs 3/8" extension bars 75 mm/3" & 150 mm / 6"
 - 1 pc 3/8" universal joint
 - 1 pc 3/8" x 1/4" bit holder
 - 2 pcs 3/8" spark plug sockets hex: 16 mm (5/8"), 21 mm (13/16")
 - 1 pc 1/4" spinner with 2-component handle
 - 1 pc 1/4" x 1/4" bit holder
 - 3 pcs 1/4" bits: slotted 4, 5.5, 7 mm
 - 4 pcs 1/4" bits: PH 1, 2, 3, 4
 - 6 pcs 1/4" bits: hex 3, 4, 5, 6, 7, 8 mm

	 731415		 mm	 g
S330AF	0137503	6	280x158x70	1970

S240

SOCKET SETS 1/2"



- 1/2" socket set
- High performance alloy steel
- Matt finish
- ISO 1174
- DIN 3120
- Case: High Density Polythene (HDPE)
- Contents, 24 pcs
 - 18 pcs 1/2" hex sockets: 10, 11, 12, 13, 14, 15, 16, 17, 18, 19, 20, 21, 22, 23, 24, 27, 30, 32 mm
 - 1 pc 1/2" ratchet quick release, 60 teeth / 6° action angle
 - 2 pcs 1/2" extension bar 5" and 10"
 - 1 pc 1/2" universal joint
 - 1 pc 1/2" T-adaptor
 - 1 pc 1/2" breaker bar with 2-component handle, 10"
 - 1 pc removable three section plastic box with lid

	 731415		 mm	 g
S240	0104017	4	375x215x100	4710



SOCKET SETS

S240AF



SOCKET SETS 1/2"

- 1/2" socket set
- High performance alloy steel
- Matt finish
- ISO 1174
- DIN 3120
- Case: High Density Polythene (HDPE)
- Contents, 23 pcs
 - 15 pcs 1/2" hex sockets:
 - AF 3/8, 7/16, 1/2, 9/16, 5/8, 11/16, 3/4, 13/16, 7/8, 15/16, 1, 1.1/16, 1.1/8, 1.3/16, 1.1/4"
 - 1 pc 1/2" ratchet quick release, 60 teeth/6° action angle
 - 2 pcs 1/2" extension bar 5" and 10"
 - 1 pc 1/2" universal joint
 - 1 pc 1/2" T-adapter
 - 1 pc 1/2" breaker bar with 2-component handle, 10"
 - 2 pcs 1/2" spark plug sockets hex: 5/8" (16), 13/16" (21)
 - 1 pc removable three section plastic box with lid



S240AF



731415
0111077



4



375x215x100



4880

S400



SOCKET SETS 1/2"

- 1/2" sockets and combination spanners set
- High performance alloy steel
- Matt finish
- ISO 1174
- DIN 3120
- Case: High Density Polythene (HDPE)
- Contents, 40 pcs
 - 21 pcs 1/2" hex sockets:
 - 10, 11, 12, 13, 14, 15, 16, 17, 18, 19, 20, 21, 22, 23, 24, 25, 26, 27, 28, 30, 32 mm
 - 1 pc 1/2" ratchet quick release, 60° teeth / 6° action angle
 - 2 pcs 1/2" extension bars 5" and 10"
 - 1 pc 1/2" universal joint
 - 1 pc 1/2" T-adapter
 - 1 pc 1/2" breaker bar with 2-component handle, 10"
 - 13 pcs combination spanners: 7, 8, 9, 10, 11, 12, 13, 14, 15, 16, 17, 18, 19 mm, on practical removable tool-rack
 - 1 pc removable three section plastic box with lid



S400



731415
0111053



2



375x320x110



6880



S350AF



SOCKET SETS 1/2"

- 1/2" sockets and combination spanners set
- High performance alloy steel
- Matt finish
- ISO 1174
- DIN 3120
- Case: High Density Polythene (HDPE)
- Contents, 35 pcs
 - 21 pcs 1/2" hex sockets: AF 13/16", 7/8", 15/16", 31/32", 1", 1.1/16", 1.1/8", 1.3/16", 1.1/4", 3/8", 7/16", 15/32", 1/2", 9/16", 19/32", 5/8", 21/32", 11/16", 23/32", 3/4", 25/32"
 - 1 pc 1/2" ratchet quick release, 60° teeth / 6° action angle
 - 2 pcs 1/2" extension bars 5" and 10"
 - 1 pc 1/2" universal joint
 - 1 pc 1/2" T-adapter
 - 1 pc 1/2" breaker bar with 2-component handle, 10"
 - 8 pcs combination spanners: AF 1/4", 5/16", 3/8", 7/16", 1/2", 9/16", 11/16", 3/4", on a practical removable tool-rack
 - 1 pc removable three section plastic box with lid

	 731415		 mm	 g
S350AF	0137527	2	371x313x70	6515

S140T



PASS-THROUGH SOCKET SETS

- Pass-through socket set
- High performance alloy steel
- Matt finish
- ISO 1174
- DIN 3120
- Case: High Density Polythene (HDPE)
- Contents, 14 pcs
 - 12 pcs pass-through sockets: 10, 11, 12, 13, 14, 15, 16, 17, 19, 21, 22, 24 mm
 - 1 pc pass-through ratchet, with flexible head, 72 teeth / 5° action
 - 1 pc pass-through extension bar, 75 mm

	 731415		 mm	 g
S140T	0125203	10	280x160x70	1350



SOCKET SETS

S140T-R



PASS-THROUGH SOCKET SETS

- High performance alloy steel
- Matt finish
- Contents, 3 pcs
 - 1 pc pass-through ratchet, with flexible head, 72 teeth / 5° action angle
 - 1 pc 19 mm (3/4") hex drive x 3/8" sq. drive adaptor, with quick release
 - 1 pc 19 mm (3/4") hex drive x 1/2" sq. drive adaptor, with quick release



S140T-R



731415
0136353



40



30x280x121



382

S530T



PASS-THROUGH SOCKET SETS

- Pass-through socket set
- Finish: Matt chrome plated
- Material: High performance alloy steel
- Case: High Density Polythene (HDPE)
- Contents, 53 pcs
 - 13 pcs pass-through sockets 10, 11, 12, 13, 14, 15, 16, 17, 18, 19, 21, 22, 24 mm
 - 1 pc pass-through ratchet, with flexible head, 72 teeth / 5° action angle
 - 1 pc pass-through extension bar, 75 mm
 - 10 pcs ring driver adapter hex shank: 8, 9, 10, 11, 12, 13, 14, 15, 16, 17 mm
 - 9 pcs E-TORX® ring driver adaptors: E8, E10, E11, E12, E14, E16, E18, E20, E22
 - 8 pcs bits 5/16" x 25 mm (Zinc Phosphate)
HEX: 7, 8, 10, 12 mm
TORX® Tamper: TR-40, TR-45, TR-50, TR-55
 - 6 pcs bits 1/4" x 25 mm (Zinc Phosphate)
HEX: 5, 6 mm
TORX® Tamper: TR-20, TR-25, TR-27, TR-30
 - 1 pc 19 mm (3/4") hex drive x 1/4" bit adaptor
 - 1 pc 19 mm (3/4") hex drive x 5/16" bit adaptor
 - 1 pc 19 mm (3/4") hex drive x 3/8" sq. drive adaptor, with quick release
 - 1 pc 19 mm (3/4") hex drive x 1/4" sq. drive adaptor, with quick release
 - 1 pc 19 mm (3/4") hex drive x 1/2" sq. drive adaptor, with quick release



S530T



731415
0169122



4



375x215x100



4.500

S910
SOCKET SETS 1/4" AND 1/2"

- 1/4" and 1/2" sockets, and combination spanners set
- High performance alloy steel
- Matt finish
- ISO 1174
- DIN 3120
- Case: High Density Polythene (HDPE)
- Contents, 92 pcs
 - 12 pcs 1/4" hex sockets: 4, 4.5, 5, 5.5, 6, 7, 8, 9, 10, 11, 12, 13 mm
 - 10 pcs 1/4" hex deep sockets 4, 5, 6, 7, 8, 9, 10, 11, 12, 13 mm
 - 13 pcs 1/2" hex sockets: 10, 11, 12, 13, 14, 15, 17, 19, 22, 24, 27, 30, 32 mm
 - 2 pcs 1/4" extension bars 50 mm / 2" and 100 mm / 4"
 - 1 pc 1/4" sliding T-bar
 - 1 pc 1/4" universal joint
 - 1 pc 1/4" bit holder
 - 1 pc 1/4" bit adapter
 - 1 pc 1/4" spinner with 2-component handle
 - 1 pc 1/4" magnetic adapter
 - 5 pcs 1/4" bits Phillips: PH 0, 1, 2, 3, 4
 - 3 pcs 1/4" bits slotted: 4, 5.5, 7 mm
 - 3 pcs 1/4" bits Pozidriv: PZ 1, 2, 3
 - 6 pcs 1/4" bits Hex: 3, 4, 5, 6, 8, 10 mm
 - 8 pcs 1/4" bits TORX®: T 8, 10, 15, 20, 25, 27, 30, 40
 - 3 pcs 5/16" bits TORX®: T 45, 50, 55
 - 2 pcs 1/2" extension bars 5" & 10"
 - 1 pc 1/2" universal joint
 - 1 pc 1/2" spark plug socket hex 21 mm (13/16")
 - 1 pc 1/2" x 5/16" bit holder
 - 1 pc 1/2" T-adapter
 - 3 pcs L-keys hex: 1.5, 2, 2.5 mm
 - 1 pc 1/4" ratchet, 60 teeth / 6° action angle, quick release
 - 1 pc 1/2" ratchet, 60 teeth / 6° action angle, quick release
 - 4 pcs flex head wrenches: 8-9, 10-11, 12-13, 14-15 mm
 - 6 pcs combination spanners: 8, 10, 12, 13, 14, 17 mm on a practical removable tool-rack
 - 1 pc removable three section plastic box with lid



S910



731415

0104000



2



375x320x110



6880



S910AF

SOCKET SETS 1/4" AND 1/2"



- 1/4" and 1/2" sockets, and combination spanners set
- High performance alloy steel
- Matt finish
- ISO 1174
- DIN 3120
- Case: High Density Polythene (HDPE)
- Contents, 92 pcs
 - 14 pcs 1/4" hex sockets: 1/8", 5/32", 3/16", 7/32", 1/4", 9/32", 5/16", 11/32", 3/8", 7/16", 1/2", 9/16", 5/8", 11/16"
 - 10 pcs 1/4" hex deep sockets: 5/32", 3/16", 7/32", 1/4", 9/32", 5/16", 11/32", 3/8", 7/16", 1/2"
 - 11 pcs 1/2" hex sockets: 1/2", 9/16", 5/8", 11/16", 3/4", 13/16", 7/8", 15/16", 1", 1-1/16", 1.3/16"
 - 2 pcs 1/4" extension bars 50 mm / 2" and 100 mm / 4"
 - 1 pc 1/4" sliding T-bar
 - 1 pc 1/4" universal joint
 - 1 pc 1/4" bit holder
 - 1 pc 1/4" bit adapter
 - 1 pc 1/4" spinner with 2-component handle
 - 1 pc 1/4" magnetic adapter
 - 5 pcs 1/4" bits Phillips: PH 0, 1, 2, 3, 4
 - 3 pcs 1/4" bits slotted: 4, 5.5, 7 mm
 - 3 pcs 1/4" bits Pozidriv: PZ 1, 2, 3
 - 6 pcs 1/4" bits hex: 3, 4, 5, 6, 8, 10 mm
 - 8 pcs 1/4" bits TORX®: T 8, 10, 15, 20, 25, 27, 30, 40
 - 3 pcs 5/16" bits TORX®: T 45, 50, 55
 - 2 pcs 1/2" extension bars 5" & 10"
 - 1 pc 1/2" universal joint
 - 1 pc 1/2" spark plug socket hex 21 mm (13/16")
 - 1 pc 1/2" x 5/16" bit holder
 - 1 pc 1/2" T-adapter
 - 3 pcs L-keys hex: 1.5, 2, 2.5 mm
 - 1 pc 1/4" ratchet, 60 teeth / 6° action angle, quick release
 - 1 pc 1/2" ratchet, 60 teeth / 6° action angle, quick release
 - 4 pcs flex head wrenches: 9/16"-19/32", 15/32"-1/2", 3/8"-7/16", 5/16"-11/32"
 - 6 pcs combination spanners: 5/16", 3/8", 7/16", 1/2", 9/16", 11/16" on a practical removable tool-rack
 - 1 pc removable three section plastic box with lid

S910AF	731415 0137541	2	371x321x108 mm	9 g

S87+7
SOCKET SETS 1/4" AND 1/2"

- 1/4" and 1/2" sockets, and combination spanners set
- High performance alloy steel
- Matt finish
- ISO 1174
- DIN 3120
- Case: High Density Polythene (HDPE)
- Contents, 94 pcs
 - 12 pcs 1/4" hex sockets:
4, 4.5, 5, 5.5, 6, 7, 8, 9, 10, 11, 12, 13 mm
 - 9 pcs 1/4" hex deep sockets:
4, 5, 6, 7, 8, 9, 10, 11, 13 mm
 - 15 pcs 1/2" hex sockets:
10, 12, 13, 14, 15, 16, 17, 18, 20, 21, 23, 24, 27, 32, 34 mm
 - 9 pcs hex sockets AF:
3/8 7/16 (11) 1/2 9/16 11/16 3/4 (19) 13/16 7/8 (22) 1-3/16"
 - 4 pcs 1/2" hex impact sockets: 17, 19, 21, 24 mm
 - 4 pcs 1/4" socket drivers Phillips PH 1, 2, 3, 4
 - 3 pcs 1/4" socket drivers slotted 4, 5.5, 7 mm
 - 6 pcs 1/4" socket drivers hex 3, 4, 5, 6, 8, 10 mm
 - 2 pcs 1/4" extension bars 50 mm / 2" & 100 mm / 4"
 - 1 pc 1/4" sliding T-bar 100 mm / 4"
 - 1 pc 1/4" universal joint
 - 1 pc 1/4" spinner with 2-component handle
 - 2 pcs 1/2" extension bars 125 mm / 5" & 250 mm / 10"
 - 1 pc 1/2" universal joint
 - 1 pc 1/2" spark plug socket hex 21 mm (13/16")
 - 1 pc 1/2" T-adaptor
 - 3 pcs L-Keys hex 1.5, 2, 2.5 mm
 - 1 pc 1/4" ratchet, 60 teeth / 6° action angle, quick release
 - 1 pc 1/2" ratchet, 60 teeth / 6° action angle, quick release
 - 4 pcs flex head spanners 8-9, 10-11, 12-13, 14-15 mm
 - 13 pcs combination spanners 7, 8, 9, 10, 11, 12, 13, 14, 15, 16, 17, 18, 19 mm,
on a practical removable tool-rack
 - 1 pce removable three section plastic box with lid



S87+7



731415

0103980



2



375x430x110



9560



S106

SOCKET SETS 1/4" AND 1/2"



- 1/4" and 1/2" sockets, and combination spanners set
- High performance alloy steel
- Matt finish
- ISO 1174
- DIN 3120
- Case: High Density Polythene (HDPE)
- Contents, 106 pcs
 - 12 pcs 1/4" hex sockets: 4, 4.5, 5, 5.5, 6, 7, 8, 9, 10, 11, 12, 13 mm
 - 10 pcs 1/4" hex deep sockets: 4, 5, 6, 7, 8, 9, 10, 11, 12, 13 mm
 - 15 pcs 1/2" hex sockets: 10, 12, 13, 14, 15, 16, 17, 18, 20, 21, 23, 24, 27, 32, 34 mm
 - 9 pcs hex sockets AF: 3/8 7/16 (11) 1/2 9/16 11/16 3/4 (19) 13/16 7/8 (22) 1-3/16"
 - 4 pcs 1/2" hex impact sockets: 17, 19, 21, 24 mm
 - 4 pcs 1/4" socket drivers Phillips PH 1, 2, 3, 4
 - 3 pcs 1/4" socket drivers slotted 4, 5.5, 7 mm
 - 6 pcs 1/4" socket drivers hex 3, 4, 5, 6, 8 10 mm
 - 3 pcs 1/4" socket drivers Pozidriv PZ 1, 2, 3
 - 8 pcs 1/4" socket drivers Torx® T 8, 10, 15, 20, 25, 27, 30, 40
 - 2 pcs 1/4" extension bars 50 mm / 2" & 100 mm / 4"
 - 1 pc 1/4" sliding T-bar 100 mm / 4"
 - 1 pc 1/4" universal joint
 - 1 pc 1/4" spinner with 2-component handle
 - 2 pcs 1/2" extension bars 125 mm / 5" & 250 mm / 10"
 - 1 pc 1/2" universal joint
 - 1 pc 1/2" spark plug socket hex 21 mm (13/16")
 - 1 pc 1/2" T-adaptor
 - 3 pcs L-Keys hex 1.5, 2, 2.5 mm
 - 1 pc 1/4" ratchet, 60 teeth / 6° action angle, quick release
 - 1 pc 1/2" ratchet, 60 teeth / 6° action angle, quick release
 - 4 pcs flex head spanners 8-9, 10-11, 12-13, 14-15 mm
 - 13 pcs combination spanners 7, 8, 9, 10, 11, 12, 13, 14, 15, 16, 17, 18, 19 mm, on a practical removable tool-rack
 - 1 pce removable three section plastic box with lid



S106



731415

0103997



2



375x430x110



9540

S108
SOCKET SETS 1/4" AND 1/2"

- 1/4" and 1/2" sockets, and combination spanners set
- High performance alloy steel
- Matt finish
- ISO 1174
- DIN 3120
- Case: High Density Polythene (HDPE)
- Contents, 108 pcs
 - 12 pcs 1/4" hex sockets: 4, 4.5, 5, 5.5, 6, 7, 8, 9, 10, 11, 12, 13 mm
 - 10 pcs 1/4" hex deep sockets: 4, 5, 6, 7, 8, 9, 10, 11, 12, 13 mm
 - 20 pcs 1/2" hex sockets: 8, 9, 10, 11, 12, 13, 14, 15, 16, 17, 18, 19, 20, 21, 22, 23, 24, 27, 30, 32 mm
 - 6 pcs 1/2" TORX® sockets: E12, E14, E16, E18, E20, E24
 - 4 pcs 1/2" hex impact sockets: 17, 19, 21, 24 mm
 - 4 pcs 1/4" socket drivers Phillips PH 1, 2, 3, 4
 - 3 pcs 1/4" socket drivers Pozidriv PZ 1, 2, 3
 - 3 pcs 1/4" socket drivers slotted 4, 5.5, 7 mm
 - 6 pcs 1/4" socket drivers hex 3, 4, 5, 6, 8, 10 mm
 - 8 pcs 1/4" socket drivers TORX® T 8, 10, 15, 20, 25, 27, 30, 40
 - 2 pcs 1/4" extension bars 50 mm / 2" & 100 mm / 4"
 - 1 pc 1/4" sliding T-bar 100 mm / 4"
 - 1 pc 1/4" universal joint
 - 1 pc 1/4" spinner with 2-component handle
 - 2 pcs 1/2" extension bars 125 mm / 5" & 250 mm / 10"
 - 1 pc 1/2" universal joint
 - 1 pc 1/2" spark plug socket hex 21 mm (13/16")
 - 1 pc 1/2" T-adapter
 - 3 pcs L-Keys hex 1.5, 2, 2.5 mm
 - 1 pc 1/4" ratchet, 60 teeth / 6° action angle, quick release
 - 1 pc 1/2" ratchet, 60 teeth / 6° action angle, quick release
 - 4 pcs flex head spanners 8-9, 10-11, 12-13, 14-15 mm
 - 13 pcs combination spanners 7, 8, 9, 10, 11, 12, 13, 14, 15, 16, 17, 18, 19 mm, on a practical removable tool-rack
 - 1 pc removable three section plastic box with lid



S108

 731415
0122257

2



375x430x110



9560



S560

SOCKET SETS 1/4" AND 1/2"



- 1/4" and 1/2" socket set
- High performance alloy steel
- Matt finish
- ISO 1174
- DIN 3120
- Case: High Density Polythene (HDPE)
- Contents, 56 pcs
 - 12 pcs 1/4" bi-hex sockets:
4, 4.5, 5, 5.5, 6, 7, 8, 9, 10, 11, 12, 13 mm
 - 10 pcs 1/4" bi-hex deep sockets:
4, 5, 6, 7, 8, 9, 10, 11, 12, 13 mm
 - 13 pcs 1/2" bi-hex sockets:
10, 11, 12, 13, 14, 15, 17, 19, 22, 24, 27, 30, 32 mm
 - 3 pcs 5/16" bits TORX® T 45, 50, 55
 - 1 pc 1/4" magnetic adaptor
 - 1 pc 1/4" magnetic adaptor
 - 2 pcs 1/4" extension bars 50 mm / 2" & 100 mm / 4"
 - 1 pc 1/4" sliding T-bar 100 mm / 4"
 - 1 pc 1/4" universal joint
 - 1 pc 1/4" spinner with 2-component handle
 - 1 pc 1/4" bit holder
 - 1 pc 1/4" bit adaptor
 - 2 pcs 1/2" extension bars 125 mm / 5" & 250 mm / 10"
 - 1 pc 1/2" universal joint
 - 1 pc 1/2" spark plug socket hex 21 mm (13/16")
 - 1 pc 1/2" T-adaptor
 - 1 pc 1/2" x 5/16 bit holder
 - 3 pcs L-Keys hex 1.5, 2, 2.5 mm
 - 1 pc 1/4" ratchet, 72 teeth / 5° action angle, quick release, slim head
 - 1 pc 1/2" ratchet, 72 teeth / 5° action angle, quick release, slim head



S560



731415

0122264



4



375x215x100



4665



S410

SOCKET SETS 1/4" AND 1/2"



- 1/4" and 1/2" socket set
- High performance alloy steel
- Matt finish
- ISO 1174
- DIN 3120
- Case: High Density Polythene (HDPE)
- Contents, 41 pcs
 - 10 pcs 1/4" hex sockets: 5, 5.5, 6, 7, 8, 9, 10, 11, 12, 13 mm
 - 2 pcs 1/4" extension bars 50 mm / 2" & 100 mm / 4"
 - 1 pc 1/4" sliding T-bar 100 mm / 4"
 - 1 pc 1/4" universal joint
 - 1 pc 1/4" ratchet, 60 teeth / 6° action angle, quick release
 - 10 pcs 1/2" hex sockets: 10, 12, 13, 14, 15, 16, 17, 19, 21, 24 mm
 - 2 pcs 1/2" extension bars 125 mm / 5" & 250 mm / 10"
 - 1 pc 1/2" universal joint
 - 1 pc 1/2" ratchet, 60 teeth / 6° action angle, quick release
 - 12 pcs combination spanners 8, 9, 10, 11, 12, 13, 14, 15, 16, 17, 18, 19 mm on a practical removable tool-rack



S410



731415
3019370



2



375x320x110



2040

SLX 17

SOCKET SETS 3/4"



- 3/4" socket set
- High performance alloy steel
- Matt finish
- ISO 1174
- DIN 3120
- Case: High Density Polythene (HDPE)
- Contents, 17 pcs
 - 12 pcs 3/4" hex sockets: 22, 24, 27, 30, 32, 33, 34, 36, 38, 41, 46, 50 mm
 - 1 pc 3/4" ratchet head 24 teeth / 15° action angle
 - 1 pc telescopic handle 500 > 815 mm
 - 1 pc 3/4" sliding T-bar head
 - 1 pc 3/4" extension bar 200 mm
 - 1 pc 3/4" extension bar 400 mm



SLX 17



731415
3015785



1



105 x 430 x 370



12838



SOCKET SETS

SLX17AF

SOCKET SETS 3/4"



- 3/4" socket set
- High performance alloy steel
- Matt finish
- ISO 1174
- DIN 3120
- Case: High Density Polythene (HDPE)
- Contents, 17 pcs
 - 12 pcs 3/4" hex sockets:
11/16", 13/16", 15/16", 7/8", 1.1/4", 1.5/16", 1.3/8", 1.7/16", 1.1/12", 1.5/8", 1.13/16", 2"
 - 1 pc 3/4" ratchet head 24 teeth / 15° action angle
 - 1 pc telescopic handle 500 > 815 mm
 - 1 pc 3/4" sliding T-bar head
 - 1 pc 3/4" extension bar 200 mm / 8"
 - 1 pc 3/4" extension bar 400 mm / 16"



SLX 17AF



731415

0137558



1



430x380x70



13000

S160-CASE

EMPTY SOCKET SET CASES



- Case for socket set S160
- Material: High Density Polythene (HDPE)
- 2 pcs removable three section plastic box with lid



S160-CASE



731151

0136209



1



530

S240-CASE

EMPTY SOCKET SET CASES



- Case for socket set S240
- Material: High Density Polythene (HDPE)



S240-CASE



731151

0136216



1



1120



S290-CASE

EMPTY SOCKET SET CASES



- Case for socket set S290
- Material: High Density Polythene (HDPE)

	 731151		 g
S290-CASE	0126385	10	490

S330-CASE

EMPTY SOCKET SET CASES



- Case for socket set S330
- Material: High Density Polythene (HDPE)

	 731151		 g
S330-CASE	0136223	1	500

S87+7-CASE

EMPTY SOCKET SET CASES



- Case for socket set S87+7
- Material: High Density Polythene (HDPE)

	 731151		 g
S87+7-CASE	0126392	5	2170

S910-CASE

EMPTY SOCKET SET CASES



- Case for socket set S910
- Material: High Density Polythene (HDPE)

	 731151		 g
S910-CASE	0137961	1	1620

TORQUE TOOLS

The award-winning Bahco torque tool range fulfils a wide array of application requirements.

Bahco torque tools are designed and produced, then meticulously tested and certified to ensure they can withstand the toughest working conditions.

They are used around the world in industrial production, assembly lines, aviation industry and vehicle maintenance.

Certified to the highest level.

Bahco torque tools are certified according to ISO 6789, guaranteeing its users undisputable quality and accuracy in the most demanding applications.

The ISO 6789 standard for hand tools states:

- The accuracy shall be within the range of 20% to 100% of the maximum torque value of the wrench
- The overload ability of the tool should be 125% of the maximum torque capacity
- The maximum level of torque for each square size
- Test points should be at 20%, 60% and 100% of the torque value



Chapter Index

TORQUE TOOLS

312-331



ELECTRONIC TORQUE WRENCHES

VERSATILE. Bahco's electronic torque wrenches are used in a range of highly demanding sectors including the automotive and aviation industries, where quality is not compromised.

SEALED. Bahco IZO torque wrench is both dustproof and splashproof, ensuring safe and reliable torque in rough, humid and dusty conditions.

THREE SIGNALS. The torque tool automatically generates three different signals for fast and reliable control when the accurate band is reached: A clear numerical display, an audible sound and a vibration in the handle.

ROBUST. Long-life, no moving or wearing parts, robust design, reliable and durable.



TORQUE SCREWDRIVERS



Bahco's ERGO™ torque screwdrivers are developed in accordance with Bahco ERGO™ Process.

Care for your most important assets

By using the ERGO™ torque screwdriver the physical constraint on your body is reduced. It also reduces the risk of excessively high tightening

torque which can cause rapid screw fractures.

It is specifically developed for changing cutting plates on automatic cutting machines to ensure that consistent and accurate cutting is achieved, and reducing the risk of inaccurately tightened screws that may result in an irregular cut surface and cause the cutting plates to wear out quickly.

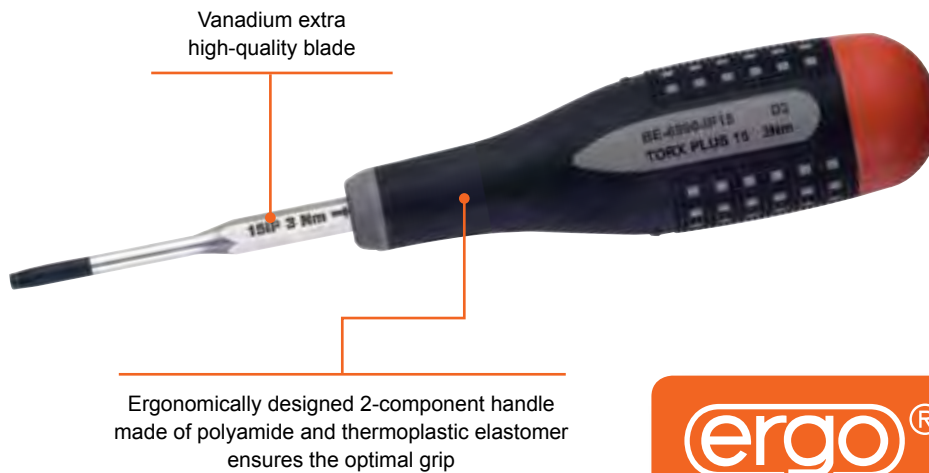

DIGITAL TORQUE TESTER

Bahco Digital Torque Tester is used to make sure the torque tools maintain their accuracy between calibrations.

The device is wall mounted and designed for easy operation, giving an exact and reliable value in real-time. It is controlled through a LCD touch screen, and the data can be easily extracted via a USB connection.



THE DIGITAL TORQUE TESTER SHOULD BE USED:

- When a torque tool has been overloaded
- When a torque tool has been repaired
- When inappropriate usage might have affected the accuracy
- Whenever there is a need to verify the accuracy of torque tools





7451/7851

TORQUE WRENCHES WITH SCALE



- Mechanical torque wrench
- Accuracy: $\pm 3\%$
- Fixed ratchet head
- 32 teeth/11.25° action
- ISO 6789

	 731415			 L mm	 Nm	 Nm	 g
7451-20	1845452	1	3/8"	355	2-20	1	900
7451-60	0124879	1	3/8"	415	10-60	5	1100
7451-100	1845469	1	3/8"	415	10-100	5	1100
7851-100	0124886	1	1/2"	415	10-100	5	1100
7851-200	1845476	1	1/2"	515	20-200	10	1300
7851-340	1845483	1	1/2"	515	70-340	20	1300

7455

TORQUE WRENCHES WITH SCALE, METAL HANDLE



- Mechanical torque wrench
- Accuracy: $\pm 4\%$ (tightening) and $\pm 6\%$ (reverse)
- Fixed ratchet head
- 32 teeth/11.25° action
- Dual scale, metric and imperial
- ISO 6789

	 731415			 Nm	 lb.ft	 lb.in	 L mm	 g
7455-5	0119639	1	1/4	1-5	.74-3.7	8.9-44.3	258	386
7455-15	0119646	1	3/8	3-15	2.2-11.1	26.5-132.8	258	409
7455-20	0125074	1	3/8	4-20	3-14.8	35.4-177	258	386
7455-25	0125081	1	3/8	5-25	3.7-18.4	44.3-221.3	286	431
7455-60	0125098	1	3/8	10-60	7.4-44.3	88.5-531	406	1135
7455-100	0125111	1	3/8	20-100	14.8-73.8	177-885	406	1135
7455-200	0125128	1	1/2	40-200	29.5-147.5	354-1770	483	1430
7455-300	0125104	1	1/2	60-300	44.3-221.3	531-2655	457	1453
7455-340	0125135	1	1/2	60-340	44.3-221.3	531-3009	620	1430
7455-500	0125142	1	3/4	100-500	73.8-368.8	885-4425	870	4676
7455-800	0125159	1	3/4	150-800	110.6-590	1328-7081	1067	5380
7455-1500	0125166	1	1"	300-1500	221.3-1106.4	2655-13275	1778	11395
7455-2500	0125173	1	1"	500-2500	368.8-1844	4425-22125	2756	22133



7456

TORQUE WRENCHES WITH SCALE, METAL HANDLE



- Mechanical torque wrench
- Accuracy: $\pm 4\%$ (tightening) and $\pm 6\%$ (reverse)
- Fixed ratchet head
- 32 teeth/11.25° action
- Dual scale, metric and imperial
- ISO 6789

	 731415			 Nm	 lb.ft	 lb.in	 L mm	 g
7456-80LB	0119783	1	3/8	13.6-108.5	10-80	120-960	422	1135

8951-F-800

TORQUE WRENCH "BREAK-BACK"



- Mechanical torque limiting wrench
- Accuracy: $\pm 4\%$
- Over-torque limiting clutch
- Reversible fixed ratchet head
- 48 teeth/7.5° action
- ISO 6789

	 731415			 Nm	 lb.ft	 lb.in	 L mm	 g
8951-F-800	0125456	1	3/4"	200-800	148-590	1770-7080	1090	6000

6852/7452/7852

TORQUE WRENCHES WITH PRESETTABLE TORQUE VALUE



- Mechanical torque wrench
- Accuracy: $\pm 3\%$
- Interchangeable ratchet head
- Preset
- ISO 6789

	 731415		 Nm	 Nm	 mm	 L mm	 g
6852-20	1845490	1	2-20	1	9x12	335	800
7452-100	1845506	1	10-100	5	9x12	380	900
7852-200	1845513	1	20-200	10	14x18	493	1300
7852-340	1845520	1	70-340	20	14x18	493	1300



TORQUE TOOLS

8952F



TORQUE WRENCH WITH SCALE, SOCKET ACCOMMODATION

- Mechanical torque wrench
- Accuracy: $\pm 3\%$
- Interchangeable head
- ISO 6789

	 731415		 Nm	 Nm	 mm	 L mm	 g
8952F	1808433	1	100-600	50	14x18	900	5.820

7452P/7852P



TORQUE WRENCHES WITH PRESET TORQUE VALUE

- Mechanical torque wrench
- Accuracy: $\pm 3\%$
- Interchangeable head
- Fixed presetting, no scale
- Fixed setting can be preformed, or by the user on suitable inspection instruments
- ISO 6789

*Please state Nm value when ordering

	 731415			 mm	 L mm	 B mm	 H mm	 g
7452P-50	3013583	1	3/8"	9x12	240	-	-	365
7452P-85	3013590	1	3/8"	9x12	320	-	-	450
7852P-200	3013606	1	1/2"	14x18	400	-	-	955

6852/7452/7852/8952 -1

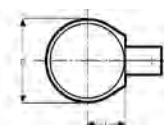
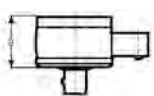

REVERSIBLE RATCHET INSERT TOOL

- Reversible ratchet head insert
- High performance alloy steel
- Forged chrome plated

	 731415			 mm	 L mm	 B mm	 H mm	 g
6852-1	1827519	1	1/4"	9x12	20	36	21,0	65
7452-1	1703646	1	3/8"	9x12	20	36	21,0	75
7852-1	1703998	1	1/2"	14x18	25	38	22,5	200
8952-1	1815493	1	3/4"	14x18	33	64	33,0	770



7452-9

FLARE NUT INSERT TOOL



- Flare nut insert head 9 x 12 mm
- High performance alloy steel
- Forged chrome plated

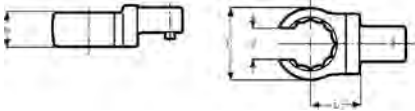

	 731415		 mm	 mm	L mm	B mm	H mm	W mm	 g
7452-9-10	1707125	1	10	9x12	15	21.5	11.0	7.1	40
7452-9-11	1707392	1	11	9x12	15	22.5	11.0	8.6	40
7452-9-12	1707477	1	12	9x12	15	23.5	11.0	9.0	40
7452-9-13	1707552	1	13	9x12	15	24.5	11.0	10.0	40
7452-9-14	1707637	1	14	9x12	15	27.0	12.0	11.0	50
7452-9-16	1848590	1	16	9x12	15	30.0	12.0	13.0	55
7452-9-17	1708870	1	17	9x12	15	30.0	12.0	14.0	65
7452-9-18	1708955	1	18	9x12	15	32.5	14.5	14.9	65
7452-9-19	1709099	1	19	9x12	15	33.5	14.5	15.8	65

7452-8

RING INSERT TOOL



- Ring insert head, 9 x 12 mm
- High performance alloy steel
- Forged chrome plated

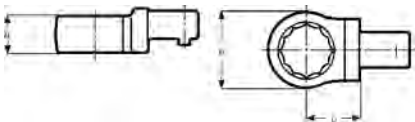

	 731415		 mm	 mm	L mm	B mm	H mm	 g
7452-8-7	1706234	1	7	9x12	15	12.2	8	30
7452-8-8	1706319	1	8	9x12	15	13.5	8	30
7452-8-10	1706586	1	10	9x12	15	16.3	9	30
7452-8-11	1706661	1	11	9x12	15	17.5	9	30
7452-8-12	1706746	1	12	9x12	15	18.5	9	35
7452-8-13	1706821	1	13	9x12	15	20.5	11	35
7452-8-14	1707040	1	14	9x12	15	22.0	11	40
7452-8-15	1708443	1	15	9x12	15	23.3	11	40
7452-8-17	1708528	1	17	9x12	15	26.0	11	40
7452-8-19	1708795	1	19	9x12	15	29.0	11	40



7852-8

RING INSERT TOOL



- Ring insert head, 14 x 18 mm
- High performance alloy steel
- Forged chrome plated

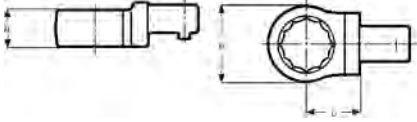

	 731415		 mm	 mm	L mm	B mm	H mm	 g
7852-8-13	1710347	1	13	14x18	25	20.5	11	120
7852-8-14	1710422	1	14	14x18	25	22.0	11	120
7852-8-15	1710699	1	15	14x18	25	23.3	11	115
7852-8-17	1710774	1	17	14x18	25	26.0	11	125
7852-8-19	1710859	1	19	14x18	25	29.0	11	125
7852-8-22	1713362	1	22	14x18	25	33.3	15	140
7852-8-24	1710934	1	24	14x18	25	36.0	15	140
7852-8-27	1711078	1	27	14x18	25	40.0	17	150
7852-8-30	1808716	1	30	14x18	25	45.0	19	160
7852-8-32	1808723	1	32	14x18	25	47.5	19	165

8952-3

INSERT SQUARE DRIVE 3/4"



- 3/4" insert square drive head
- Max torque value of 650 Nm
- High performance alloy steel
- Forged chrome plated



	 731415		 mm	L mm	B mm	H mm	 g	
8952-3	1848644	1	3/4"	14x18	66	28	24	249

7452-10

WELDING INSERT TOOL



- Welding insert head, 9 x 12 mm
- High performance alloy steel
- Black finish

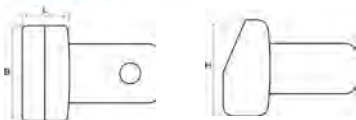

	 731415		 mm	L mm	B mm	H mm	 g
7452-10	1848736	1	9x12	8	14	14.5	30



7852-10

WELDING INSERT TOOL



- Welding insert head, 14 x 18 mm
- High performance alloy steel
- Black finish

				L	B	H	
	731415		mm	mm	mm	mm	g
7852-10	1848743	1	14x18	12	25	21.5	98

7452-7

OPEN-END INSERT TOOL

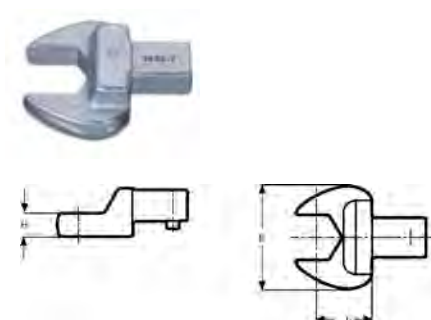

- Open-end insert head, 9 x 12 mm
- High performance alloy steel
- Forged chrome plated

					L	B	H	
	731415		mm	mm	mm	mm	mm	g
7452-7-7	1713010	1	7	9x12	15	22	5.0	35
7452-7-8	1713287	1	8	9x12	15	22	5.0	35
7452-7-9	1705770	1	9	9x12	15	25	5.5	35
7452-7-10	1705855	1	10	9x12	15	25	5.5	40
7452-7-11	1705930	1	11	9x12	15	25	5.5	30
7452-7-13	1706074	1	13	9x12	16	30	7.0	35
7452-7-14	1706159	1	14	9x12	17	35	8.0	40
7452-7-15	1707989	1	15	9x12	17	35	8.0	40
7452-7-16	1708016	1	16	9x12	17	38	8.5	45
7452-7-17	1708283	1	17	9x12	20	38	8.5	60
7452-7-18	1839321	1	18	9x12	20	42	9.0	70
7452-7-19	1708368	1	19	9x12	20	42	9.0	70



7852-7

OPEN-END INSERT TOOL

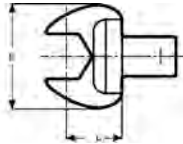
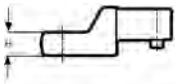

- Open-end insert head, 14 x 18 mm
- High performance alloy steel
- Forged chrome plated

	 731415		 mm	 mm	L mm	B mm	H mm	 g
7852-7-13	1709334	1	13	14x18	25.0	30	7	120
7852-7-14	1709419	1	14	14x18	25.0	35	8	120
7852-7-15	1709686	1	15	14x18	25.0	35	8	120
7852-7-17	1709761	1	17	14x18	25.0	38	9	130
7852-7-18	1839338	1	18	14x18	25.0	42	10	145
7852-7-19	1709846	1	19	14x18	25.0	42	10	145
7852-7-22	1839345	1	22	14x18	25.0	53	10	175
7852-7-24	1710187	1	24	14x18	27.5	53	10	170
7852-7-27	1710262	1	27	14x18	30.0	60	11	185
7852-7-30	1839352	1	30	14x18	30.0	66	14	186
7852-7-32	1808693	1	32	14x18	32.5	66	14	220

6852-5/S17

TORQUE TOOL SETS



- Torque tool set, 17 pcs

	 731415		 g
6852-5/S17	0135875	1	3295
52H PH 0, PH 1			
51PZSDVH PZ 0, PZ 1			
64TORX T-5, T-6, T-7, T-8			
55M 1.5, 2.0, 2.5			
50K 0.6x4.5; 0.8x5.5			
KM653-QR			
6852-5			
6700SM 4 mm			



7454

DIAL TORQUE WRENCHES, DOUBLE SCALE



- Dial torque wrench
- Accuracy: $\pm 4\%$
- Visual and audio signal
- Reversible operation
- Dual scale in metric and imperial
- Memory needle
- Anti-shock protected dial
- With rubber sleeve in 1/4", 3/8" and 1/2" models

	731415			Nm	lb.ft	lb.in	Nm	mm	g	
7454-3	0119493	1	1/4	0-3.5	0-2.6	0-30	0.1	292	499	
7454-9	0119509	1	1/4	0-9	0-6.6	0-75	0.2	292	499	
7454-18	0119516	1	3/8	0-18	0-13.3	0-150	0.5	292	499	
7454-35	0119523	1	3/8	0-35	0-25.8	0-300	1	292	499	
7454-70	0119530	1	3/8	0-70	0-50	0-620	2	381	726	
7454-140	0119547	1	1/2	0-140	0-100	0-1239	5	552	1680	
7454-240	0119554	1	1/2	0-240	0-175	0-2124	5	552	1680	
7454-350	0119561	1	1/2	0-350	0-250	0-3098	10	552	1680	
7454-480	0119578	1	3/4	0-480	0-350	0-4248	10	711	2611	
7454-800	0119585	4	3/4	0-800	0-600	0-7081	20	1194	4585	
7454-1400	0119592	1	1"	0-1400	0-1000	0-12391	25	1880	13620	
7454-800E	0119608	1	3/4	0-800	0-600	0-7081	20	1194	4585	
7454-1400E	0119615	1	1"	0-1400	0-1000	0-12391	25	1880	13620	

IZO-D

MEASURING WRENCH



- Electronic torque wrench
- Accuracy: $\pm 2\%$
- Visual, audio and vibration signal
- Reversible interchangeable heads (supplied with ratchet head)
- 60 teeth/6° action
- Automatic shut off and auto zero check on power up
- Data and set value retention during battery exchange
- Operating temperature range: 5 °C - 42 °C
- Storage temperature range: -10 °C - 50 °C
- 3 AA batteries included
- Ranges programmable in Nm, Lbf.ft., Lbf.in.
- ISO 6789
- 89/336/EEC

	731415		mm		Nm	lb.ft	lb.in		mm	g
IZO-D-30	1846824	1	9x12	1/4"	3-30	2.21-22.13	26.6-265.5	6852-1	405	930
IZO-D-135	1845827	1	9x12	3/8"	13.5-135	10-99.57	62-1195	7452-1	450	1000
IZO-D-200	1846831	1	14x18	1/2"	20-200	14.75-147.50	177-1770	7852-1	535	1345
IZO-D-340	1846848	1	14x18	1/2"	34-340	25.07-250.80	301-3009	7852-1	650	1525



IZO-DR

MEASURING WRENCH



- Electronic torque wrench
- Accuracy: $\pm 2\%$
- Visual, audio and vibration signal
- Fixed ratchet head
- 32 teeth/11.25° action
- Automatic shut off and auto zero check on power up
- Data and set value retention during battery exchange
- Operating temperature range: 5 °C - 42 °C
- Storage temperature range: -10 °C - 50 °C
- 3 AA batteries included
- Ranges programmable in Nm, Lbf.ft., Lbf.in.
- ISO 6789
- 89/336/EEC

	 731415			 Nm	 lb.ft	 lb.in	 mm	 g
IZO-DR-810	1846817	1	3/4"	81-810	59.74-5974.2	716.9-7169	1230	4530

IZO-DAG

MEASURING WRENCH



- Electronic torque wrench
- Accuracy: $\pm 2\%$
- Visual, audio and vibration signal
- Reversible interchangeable heads (supplied with ratchet head)
- 60 teeth/6° action
- Performs tightening operations specified by first a given torque and then a specific angle rotation
- Automatic shut off and auto zero check on power up
- Data and set value retention during battery exchange
- Operating temperature range: 5 °C - 42 °C
- Storage temperature range: -10 °C - 50 °C
- 3 AA batteries included
- Ranges programmable in Nm, Lbf.ft., Lbf.in.
- ISO 6789
- 89/336/EEC

	 731415			 Nm	 lb.ft	 lb.in	 mm	 g
IZO-DAG-135	3016270	1	3/8"	13.5-135	5-100	60-1200	450	1000
IZO-DAG-340	3016287	1	1/2"	34-340	25-250	150-3000	650	1525



IZO-DM

MEASURING WRENCH



- Electronic torque wrench
- Accuracy: $\pm 2\%$
- Visual, audio and vibration signal
- Reversible interchangeable heads (supplied with ratchet head)
- 60 teeth/6° action
- Memory capacity of 1 000 readings
- Automatic shut off and auto zero check on power up
- Data and set value retention during battery exchange
- Operating temperature range: 5 °C - 42 °C
- Storage temperature range: -10 °C - 50 °C
- PC software (Excel format), RS 232 serial link, supplied with software, cable and 3 AA batteries
- Ranges programmable in Nm, Lbf.ft., Lbf.in.
- ISO 6789
- 89/336/EEC

		 731415		 mm		 Nm	 lb.ft	 lb.in		 L mm	 g
IZO-DM-30		1846909	1	9x12	1/4"	3-30	2.21-22.13	26.6-265.5	6852-1	405	930
IZO-DM-135		1848200	1	9x12	3/8"	13.5-135	10-99.57	62-1195	7452-1	450	1000
IZO-DM-200		1846916	1	14x18	1/2"	20-200	14.75-147.50	177-1770	7852-1	535	1345
IZO-DM-340		1846923	1	14x18	1/2"	34-340	25.07-250.80	301-3009	7852-1	650	1525

IZO-DRM

MEASURING WRENCH



- Electronic torque wrench
- Accuracy: $\pm 2\%$
- Visual, audio and vibration signal
- Fixed ratchet head
- 32 teeth/11.25° action
- Memory capacity of 1 000 readings
- Automatic shut off and auto zero check on power up
- Data and set value retention during battery exchange
- Operating temperature range: 5 °C - 42 °C
- Storage temperature range: -10 °C - 50 °C
- PC software (Excel format), RS 232 serial link, supplied with software, cable and 3 AA batteries
- Ranges programmable in Nm, Lbf.ft., Lbf.in.
- ISO 6789
- 89/336/EEC

		 731415			 Nm	 lb.ft	 lb.in	 L mm	 g
IZO-DRM-810		1846893	1	3/4"	81-810	59.74-5974.2	716.9-7169	1230	4530



BE-6990

ERGO™ TORQUE SCREWDRIVER, FIXED SETTING



- Torque screwdriver developed according to the scientific ERGO™ process
- Torque screwdriver, fixed setting
- Accuracy: $\pm 10\%$
- Over-torque limiting clutch, with a “click” sound
- High performance alloy steel
- Chrome plated and entirely hardened. Black finish tip for higher accuracy
- Designed for correct tightening of precision fasteners, for example in CNC machines
- 6 mm hex shank
- Replaceable blades available
- Supplied with one TORX® and one TORX PLUS® blade

	 731415		 max Nm		 mm	 mm	 mm	 g
BE-6990-IP6	1846725	1	0.6	T6	55	32x113	168	100
BE-6990-IP7	1846732	1	0.9	T7	55	32x113	168	100
BE-6990-IP8	1846749	1	1.2	T8	55	32x113	168	100
BE-6990-IP9	1846756	1	1.4	T9	65	32x113	178	100
BE-6990-IP10	1846763	1	2.0	T10	65	32x113	178	100
BE-6990-IP15	1846770	1	3.0	T15	65	32x113	178	100

BE-6990TX-KL

ERGO™ TORQUE SCREWDRIVER, FIXED SETTING



- Replaceable blade for ERGO™ torque screwdriver, BE-6990-IP6 to BE-6990-IP15
- High performance alloy steel
- Chrome plated and entirely hardened. Black finish tip for higher accuracy
- For TORX® head screws

	 731415			 mm	 mm	 g
BE-6990TX-T6-KL	1847722	10	T6	1.70	170	40
BE-6990TX-T7-KL	1847739	10	T7	1.99	170	40
BE-6990TX-T8-KL	1847746	10	T8	2.31	170	40
BE-6990TX-T9-KL	1847753	10	T9	2.50	170	40
BE-6990TX-T10KL	1847760	10	T10	2.74	170	40
BE-6990TX-T15KL	1847777	10	T15	3.27	170	40



BE-6990-IP-KL

ERGO™ TORQUE SCREWDRIVER, FIXED SETTING



- Replaceable blade for ERGO™ torque screwdriver, BE-6990-IP6 to BE-6990-IP15
- High performance alloy steel
- Chrome plated and entirely hardened
- Black finish tip for higher accuracy
- For TORX PLUS® head screws

	 731415			 D mm	 L mm	 g
BE-6990-IP6-KL	1847494	10	IP6	1.70	170	40
BE-6990-IP7-KL	1847500	10	IP7	1.99	170	40
BE-6990-IP8-KL	1847517	10	IP8	2.31	170	40
BE-6990-IP9-KL	1847524	10	IP9	2.50	170	40
BE-6990-IP10-KL	1847531	10	IP10	2.74	170	40
BE-6990-IP15-KL	1847548	10	IP15	3.27	170	40

BE-6990-IPSET

ERGO™ TORQUE SCREWDRIVER, FIXED SETTING



- Torque screwdriver developed according to the scientific ERGO™ process
- Torque screwdriver, fixed setting
- Accuracy: ± 10%
- Over-torque limiting clutch, with a “click” sound
- High performance alloy steel
- Chrome plated and entirely hardened. Black finish tip for higher accuracy
- Designed for correct tightening of precision fasteners, for example in CNC machines
- 6 mm hex shank

	 731115		 g
BE-6990-IPSET	3019356	1	755



BE-6990-IP20/25



ERGO™ TORQUE SCREWDRIVER, FIXED SETTING, WITH SLIDING T-HANDLE

- Torque screwdriver, fixed setting
- Accuracy: $\pm 6\%$
- Over-torque limiting clutch, with a "click" sound
- High performance alloy steel
- Chrome plated and entirely hardened. Black finish tip for higher accuracy
- Designed for correct tightening of precision fasteners, for example in CNC machines
- $\frac{1}{4}$ " hex drive for blades
- $\frac{1}{4}$ " square drive for sliding T-handle
- Replaceable blades available
- Supplied with one TORX® and one TORX PLUS® blade

	731415		max Nm		mm	mm	mm	g
BE-6990-IP20	1848606	1	4	T20	65	149	214	370
BE-6990-IP25	1848613	1	5	T25	65	149	214	370

BE-6990-IP-KL



ERGO™ TORQUE SCREWDRIVER, FIXED SETTING, WITH SLIDING T-HANDLE

- Replaceable blade for torque screwdriver, BE-6990-IP20 & BE-6990-IP25 and loose handle BE-6990-AH
- High performance alloy steel
- Chrome plated and entirely hardened
- Black finish tip for higher accuracy
- For TORX PLUS® head screws

731415			mm	mm	g	
BE-6990-IP20-KL	1848668	10	IP20	4.5	90	20



BE-6990TX-KL



ERGO™ TORQUE SCREWDRIVER, FIXED SETTING, WITH SLIDING T-HANDLE

- Replaceable blade for torque screwdriver, BE-6990-IP20 & BE-6990-IP25 and loose handle BE-6990-AH
- High performance alloy steel
- Chrome plated and entirely hardened. Black finish tip for higher accuracy
- For TORX® head screws

	 731415			 mm	 mm	 g
BE-6990TX-T20KL	1848682	10	T20	4.5	90	20
BE-6990TX-T25KL	1848699	10	T25	6	90	20

6973N-6978N



TORQUE SCREWDRIVER WITH SCALE, ADJUSTABLE

- Micro adjustable torque screwdriver
- Accuracy: ±6%
- Over-torque limiting clutch
- 1/4" hex magnet spring loaded bit holder
- ISO 6789, ISO 1174

	 731415				 mm	 g
6973N	1845605	1	1/4"	10-80 cNm	140	200
6976N	1845612	1	1/4"	40-200 cNm	160	260
6978N	1845629	1	1/4"	50-450 cNm	170	300

6881



TORQUE SCREWDRIVERS WITH DIAL INDICATION

- Adjustable torque screwdriver with dial indication
- Accuracy: ±6%
- Chrome plated finish
- Over-torque limiting clutch
- Reversible operation
- ESD safe (IEC 61340-5-1 & EN 100015-1)
- 1/4" hex drive
- ISO 6789

	 731415							 mm	 g
6881B	1816438	1	1/4"	0-50 cNm	2 cNm	0-70 ozf.-in	5 ozf.-in	178	190
6881D	1816636	1	1/4"	0-100 cNm	5 cNm	0-140 ozf.-in	10 ozf.-in	178	190



6976E

TORQUE CALIBRATION RIG



- Torque calibration rig for pre-settable torque screwdrivers
- The torque calibration rig guarantee an accuracy to within $\pm 2\%$ throughout the measuring range
- The torque calibration rig has a slave pointer and a pointer damping
- Aluminium body

	 731415			 Nm	 Nm	 lbf-in	 lbf-in	
6976E/1	1808785	1	1/4" 3/8"	0.2-4	0.05	2-36	0.5	1900
6976E/2	1808792	1	1/4" 3/8"	1-12	0.2	10-120	2	1900

6976AN

TORQUE SCREWDRIVERS WITH SCALE, ADJUSTMENT RING



- Torque screwdriver with 1/4" - male square
- Smooth disengagement prevents over tightening
- Bi-directional operation with torque limiting effect
- Automatic re-setting by precision radial ball clutch
- Comprehensive range of accessories for universal applications
- Accuracy: $\pm 6\%$
- DIN/ISO 6789 / EN26789/1994

	 731415						
6976AN	1808457	1	1/4"	20-120 cNm	1 cNm	160	158

6976CN

TORQUE SCREWDRIVERS WITH SCALE, ADJUSTMENT RING



- Torque screwdriver with 1/4" - male square
- Smooth disengagement prevents over tightening
- Bi-directional operation with torque limiting effect
- Automatic re-setting by precision radial ball clutch
- Comprehensive range of accessories for universal applications
- With additional female square to hold a sliding T-handle 1/4"
- Accuracy: $\pm 6\%$
- DIN/ISO 6789 / EN26789/1994

	 731415			 Nm	 Nm		
6976CN	1808471	1	1/4"	1-6	0.1	222	340



6976



6976A

TORQUE SCREWDRIVERS WITH PRESET TORQUE VALUES

- Torque screwdriver with 1/4" - male square
- Smooth disengagement prevents over tightening
- Bi-directional operation with torque limiting effect
- Automatic re-setting by precision radial ball clutch
- Comprehensive range of accessories for universal applications
- Accuracy: $\pm 6\%$
- DIN/ISO 6789 / EN26789/1994

	 731415						
6976A	1807795	1	1/4"	2-135 cNm	3 ozf.in-12 lb.in	143	210

6975A



TORQUE SCREWDRIVERS WITH PRESET TORQUE VALUES

- Available with 1/4" female hexagon socket only
- Fitted with special twist/radial bearing which minimises the effect of high operator end loads on torque output
- End cap has a "finger dimple" enabling the tool to be used as a jewellers' screwdriver
- Specially shaped body profile
- Accuracy: $\pm 5\%$

	 731415						
6975A	1827489	1	1/4"	2-22 cNm	1 cNm	72	50

6873N-6880N



TORQUE SCREWDRIVERS WITH PRESET TORQUE VALUES

- Torque screwdriver
- Accuracy: $\pm 6\%$
- Preset
- Over-torque limiting clutch, with a "click" sound
- 1/4" hex magnet spring loaded bit holder
- Includes a 1/4" square adaptor for sockets
- Chrome plated finish
- ISO 6789

	 731415					
6873N	1845568	1	1/4"	4-22 cNm	115	145
6876N	1845575	1	1/4"	7-70 cNm	145	200
6878N	1845582	1	1/4"	15-170 cNm	145	200
6880N	1845599	1	1/4"	45-450 cNm	155	280



BE-6990-AH



TORQUE SCREWDRIVERS WITH PRESET TORQUE VALUES

- Torque screwdriver handle, fixed setting
- Accuracy: $\pm 6\%$
- Over-torque limiting clutch, with a "click" sound
- Designed for correct tightening of precision fasteners, for example in CNC machines
- 1/4" hex drive for blades
- 1/4" square drive for sliding T-handle
- Replaceable blades available

	 7314155			 Nm	 L mm	 g
BE-6990-AH	1848651	1	1/4	0.5-15	150	335

7453



PRESET TORQUE HANDLES

- Torque screwdriver
- Accuracy: $\pm 4\%$ (tightening) and $\pm 6\%$ (reverse)
- Preset
- Over-torque limiting clutch
- ISO 6789

	 731415				 Nm	 L mm	 g
7453-20-6F	0119462	1	1/4	-	2-20	134	255
7453-20-6	0119479	1	-	1/4	2-20	134	255
7453-20-10	0119486	1	-	3/8	2-20	134	255

6852-5



TORQUE WRENCH 5 NM

- 5 Nm mechanical torque wrench
- Accuracy: $\pm 3\%$
- Fixed head, no ratchet mechanism
- Automatic reset
- Supplied in a plastic box
- ISO 6789

	 731415			 Nm	 Nm	 L mm	 g
6852-5	0125463	1	1/4" 1/4"	1-5	0.1	170	120



7851-M/8951-M

ANGLE METER



- Angle meter with magnet
- With flexible arm and magnetic fixing
- Enables tightening at any specific angle
- Maximum output of torque wrench must not be passed

	 731415			 L mm	 g
7851-M	0124893	1	1/2"	465	300

7851-G

ANGLE METER



- Angle meter with grip
- With flexible arm and grip for fixing
- Enables tightening at any specific angle
- Maximum output of torque wrench must not be passed

	 731415			 L mm	 g
7851-G	0124909	1	1/2"	455	300

8905-TM/9505-TM

AUTOMOTIVE TORQUE MULTIPLIER



- Torque multiplier
- Accuracy: $\pm 4\%$
- Reaction arm included
- Supplied in double plastic wall case

	 731415			 Nm	 lb.ft	 lb.in		 L mm	 g
8905-TM	0125470	1	1/2" 3/4"	260-1300	192-960	2300-11500	5:1	210	3700
9505-TM	0125487	1	3/4" 1"	540-2700	400-2000	4780-23900	5:1	210	3500



9505/9605/9525/9625

STD TORQUE MULTIPLIER



- Torque multiplier
- Accuracy: $\pm 4\%$
- Reaction arm included
- Supplied in a leather case

	 731415			 Nm		 L mm	 g
9505-1700	0125494	1	3/4" 1"	340-1700	5:1	217	5200
9505-3400	0125517	1	3/4" 1"	680-3400	5:1	264	7200
9525-1700	0125500	1	1/2" 1"	68-1700	25:1	217	7800
9525-3400	0125524	1	1/2" 1"	136-3400	25:1	264	10000
9605-6000	0125531	1	3/4" 1.1/2"	1200-6000	5:1	333	14400
9625-6000	0125548	1	1/2" 1.1/2"	240-6000	25:1	333	17000
9625-9500	0125555	1	3/4" 1.1/2"	380-9500	25:1	351	25700

8905S/9675S

SLIM LINE TORQUE MULTIPLIER



- Torque multiplier, slim line
- To be used in narrow places
- Accuracy: $\pm 4\%$
- Reaction arm included
- Supplied in a leather case









	 731415			 Nm		 L mm	 g
8905S-1000	0125579	1	1/2" 3/4"	200-1000	5:1	143	14100
9505S-3000	0125609	1	3/4" 1"	600-3000	5:1	14	7000
9515S-3000	0125616	1	1/2" 1"	200-3000	15:1	141	9000
9525S-1500	0125586	1	1/2" 1"	60-1500	25:1	143	4500
9625S-6000	0125647	1	1/2" 1.1/2"	240-6000	25:1	154	14600
9675S-6000	0125630	1	1/2" 1.1/2"	80-6000	75:1	154	16100

DTT

TORQUE CONTROL



- Digital torque tester
- 2 Installation options, on a wall or fastened in a vice
- LCD touch pad screen, coloured graphic display
- Downloads stored torque data to a PC
- Units of torque: Nm, kgcm, ft.lb., in.lb., in-oz
- Audible (tone) and LED light-bar
- Present alerts torque accuracy: $\pm 0.5\% \pm 1$ count CW and CCW from 10 to 100% of full scale at 25° C
- Display accuracy: 4 digits, 9999 cycle counts
- Six "AA" Alkaline cells for battery power included
- Track, peak and first peak modes of operation
- Operating temperature: 40 to 110 °F (5 to 42 °C)
- Storage temperature: 0 to 122 °F (-20 to 50 °C); Humidity up to 85% non-condensing
- Manual available in 9 languages
- Traceability from 10% to 100% of full scale. Includes storage case, AC adapter and USB cable
- ISO-6789-2003 and ASME B107-28-2005 standards compliant

	 731415			 Nm	 lb.ft	 lb.in	 g
69DTT-5	0184132	1	1/4"	0,5-5	0,4-4	4,4-44	5.000
74DTT-100	0184149	1	3/8"	10-100	7-75	88-880	5.000
78DTT-340	0182626	1	1/2"	34-340	25-250	300-3.000	5.000
89DTT-800	0184156	1	3/4"	80-800	60-580	705-7.050	5.000

IMPACT TOOLS & BITS

Impact tools, concentration of Power.

Bahco offers an extensive range of impact sockets, extensions, ball joints and adaptors to ensure the most efficient use of powerful impact tools. Professional power sockets are suitable for any application, under almost any conditions. Bahco ultra-resistant power tool accessories are ideal for the most demanding tasks and guarantee a safe operation.

The range of power sockets covers metric and imperial sizes of standard length and deep length, magnetic, thin walled etc. to make sure users have the right tools for the application at hand. Bahco's high-quality impact sockets are made of the high performance alloy steel chrome-molybdenum, with a black finish, making them ideal for impact use. All impact sockets and accessories meet applicable ISO and DIN standards.

There is a wide range of sizes available for 1/4", 3/8", 1/2", 3/4", 1" and 1 1/2" drives.

Bits that make the difference.

The Bahco screwdriver bit range consists of screwdriver bits of all kinds:

Phillips, Pozidriv, TORX®, TORX® Tamper, Slotted, Hex, Hex ball point, Robertson, Torq-set, Tri-wing, XZN.

Bahco meets professional demands by providing the appropriate quality levels: Standard, Torsion, Extra Hard Torsion, Torsion Stainless, TiN Torsion, ACR Torsion and Diamond Torsion bits.

Choosing the right bit to use depends on the type of fastening to be carried out. Each task also has its own characteristics that depend on numerous factors such as the user's preference, the type of fastening to be applied, the torque level required, the screw being used, etc.



Chapter Index

IMPACT TOOLS 1/4"	340-341
IMPACT TOOLS 3/8"	341-343
IMPACT TOOLS 1/2"	344-352
IMPACT TOOLS 3/4"	353-358
IMPACT TOOLS 1"	358-362
IMPACT TOOLS 1 1/2"	363-368
DIAMOND TORSION BITS 1/4"	369-372
TIN TORSION BITS 1/4"	373-374
TORSION BITS 1/4"	375-377
EXTRA HARD TORSION BITS 1/4"	377-380
ACR TORSION BITS 1/4"	380-381
STAINLESS STEEL TORSION BITS 1/4"	382-384
STANDARD BITS 1/4"	385-406
BITS FOR MAGAZINE SCREWDRIVERS	407
BIT SETS 1/4"	408-418
BITS 5/32"	418
BITS 5/16"	419-420
BIT SETS 5/16"	421
BITS 11.2 MM (7/16")	421



BAHCO IMPACT SOCKETS AND ACCESSORIES

ASSORTMENT OVERVIEW

	Drive: 1/4"	Drive: 3/8"	Drive: 1/2"	Drive: 3/4"	Drive: 1"	Drive: 1. 1/2"
Sockets; metric	6 - 14 mm	7 - 24 mm	8 - 36 mm	17 - 60 mm	22 - 80 mm	46 - 155 mm
Sockets; metric, magnetic	7 - 10 mm					
Sockets; metric, deep		10 - 17 mm	10 - 30 mm	13 - 41 mm	22 - 60 mm	41 - 120 mm
Reinforced Sockets for Wheel nuts; metric			17 - 24 mm			
Sockets; imperial			3/8" - 1 1/2"	3/4" - 2 3/8"	1" - 2 3/4"	1 3/8" - 4 3/4"
Sockets; imperial, deep			3/8" - 1 1/2"	3/4" - 2"	1" - 1 7/8"	1 3/8" - 4 3/4"
Sockets TORX®			E10 - E24			
Extensions		•	•	•	•	•
Ball Joints		•	•	•	•	•
Adaptors		•	•	•	•	•
Adaptors, bit holders	•	•	•	•	•	•
Bit for Hexagon Metric Socket Head Screws					•	
Socket drivers			•	•	•	
Clamping springs		•	•	•	•	•
Socket sets		•	•			

CLAMPING SPRINGS

FOR A SECURE JOINT BETWEEN MACHINE AND IMPACT SOCKET

All Bahco impact sockets are intended for machine use only. To achieve maximum safety, we recommend the user to always use clamping springs. Both the male and female square drives have a through-hole, making it simple and safe to attach the clamping spring. Information for each product - which clamping spring is to be used for each impact socket, adaptor, extension or ball joint - can be found in the catalogue.



DYNAMIC DRIVE™ PROFILE

FOR AN INCREASED TORQUE AND LONG TOOL LIFE

All Bahco impact sockets feature a Dynamic Drive™ Profile giving a higher torque and a thin-wall construction that enables better accessibility to confined spaces. Moreover, the nut and screw heads are protected by the Dynamic Drive™ mechanism, minimizing wear and optimizing the life of the tools.

STANDARD HEXAGON PROFILE

High surface pressure due to small force-applying surfaces

DYNAMIC DRIVE™ PROFILE

Low surface pressure due to large force-applying surfaces



High Notching Sensitivity



No Notching Sensitivity



IMPACT SOCKETS AND ACCESSORIES

ALL THE WAY FROM MACHINE TO SCREW

A complete overview of how the Bahco range of impact tools is fitted to the machines [on the right] all the way to the nut/screw [on the left]. The entire range of Bahco impact sockets and accessories is, of course, adapted to our top and base line air tools range.

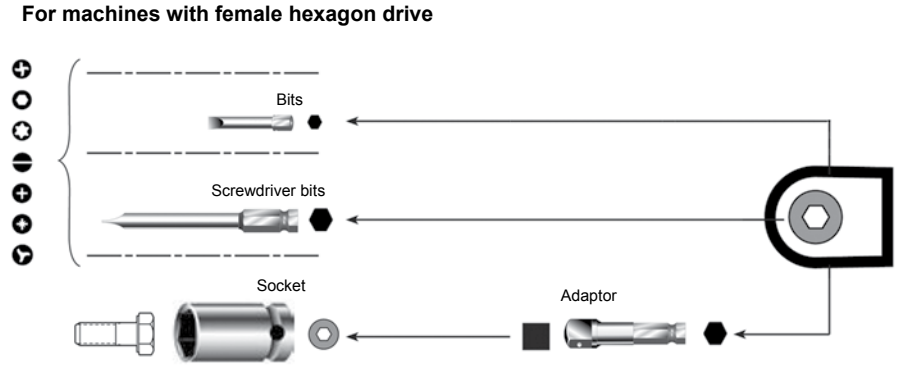
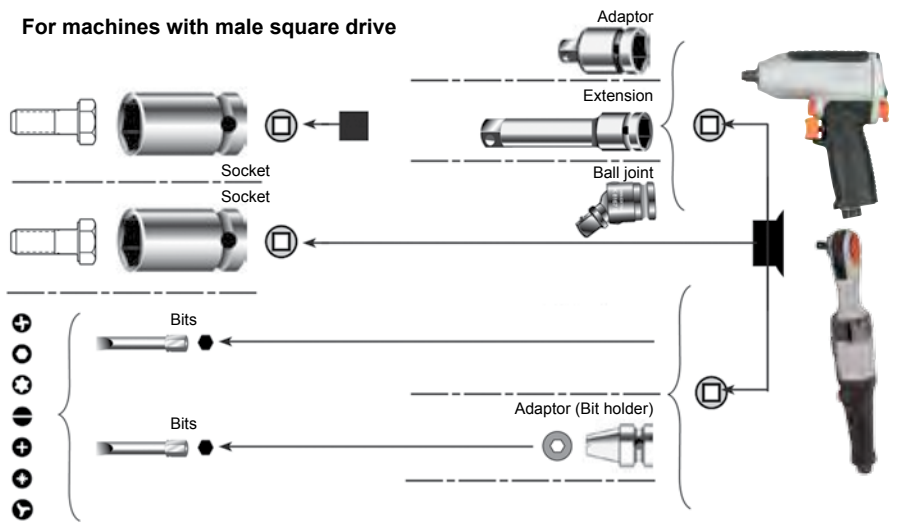

WHEN HIGH POWER IS NEEDED



SCREWDRIVER BITS

THE CHOICE

DIAMOND TORSION (63D)

High performance in any application.
Suitable for power tools.



Tip-coated with thousands of tiny industrial-grade diamond particles that significantly reduce the cam-out effect (stopping the screw head slipping out).

Reduces the wear and tear to both the bit and the screw.
 Reduces the torque required to successfully drive the screw.
 Increases productivity by reducing down-time.

- Thousands of diamond particles provide safe grip
- Torsion zone (extended bar)
- Nucleus Hardness HRc 60-62
- Torsion zone absorbs torque peaks and prolongs bit life

TORSION (60T)

Suitable for metal and hard materials.



When fastening in metal, the torque increases abruptly at the end of the fastening process, generating large amounts of peak torque that affects both the screw and the tool.

Bits that are too hard can be broken under these conditions.
 A softer bit is more wear resistant against sudden impacts, preventing the tip from breaking prematurely.

- Surface-coated with clear lacquer for rust protection
- Torsion zone (extended bar)
- Torsion zone absorbs torque peaks and prolongs bit life
- Nucleus Hardness HRc 60-62

ACR TORSION (64A)

Recommended for tasks requiring reduction of the cam-out effect.



ACR Torsion bits have a grooved tip (ACR system). Avoids the cam-out effect.

Recommended for tasks requiring reduction of the cam-out effect, avoiding erosion of the bit-screw.

- Surface coated with clear lacquer for rust protection
- Grooved tip (ACR system) avoids the cam-out effect
- Torsion zone (extended bar)
- Nucleus Hardness HRc 60-62
- Torsion zone absorbs torque peaks and prolongs bit life

STANDARD (59S)

Suitable for all applications.



Robust bits that can be used in manual and machine applications. High-quality bits resistant to wear and tear.

- Precisely machined tip
- Nucleus Hardness HRc 58-62

TIN TORSION (62TiN)

Suitable for mass-production line.



Industrial applications are subject to permanent stresses that place high demands on the durability of the tool.

Bits for these applications are coated with extremely hard titanium nitride. This abrasion-proof coating provides the necessary hardness that is required on a mass production line.

- Titanium nitride (TiN) coating
- Torsion zone (extended bar)
- Nucleus Hardness HRc 60-62
- Torsion zone absorbs torque peaks and prolongs bit life

EXTRA HARD TORSION (6IH)

Suitable for wood and soft material application.



When fastening in wood, the torque increases steadily until the head of the screw reaches the surface of the material.

The deeper the screw penetrates into the wood, the more the torque increases.

Extra hard bits are subject to special heating processes that make it harder and reduce the risk of the breakage - extending the service life of the bit.

- Surface-coated with yellow lacquer for rust protection
- Torsion zone (extended bar)
- Torsion zone absorbs torque peaks and prolongs bit life
- Nucleus Hardness HRc 62-64

INOX TORSION (65I)

Ideal for use on stainless steel screws.



Stainless steel does not rust.

However, if conventional steel tools are used on stainless steel elements or stainless steel screws, the wear debris of these tools can adhere to the surface and begin to rust.

Wear debris causes extraneous rust, but can be prevented by using stainless steel tools. Inox in combination with torsion gives a superior bit that can withstand even highest demands.

- Surface coated with yellow lacquer for rust protection
- Torsion zone (extended bar)
- Nucleus Hardness HRc 60-62
- Torsion zone absorbs torque peaks and prolongs bit life

31 PCS BIT SETS 59S/31 & 60T/31

Standard & Torsion

4 different versions

Drive: 1/4" DIN 3126-C6.3, ISO 1173

Bit Length: 25 mm

Finish: ZnPh (zinc-phosphated)

Material: High-performance alloy steel

Each bit is Bahco branded, with the size and tip stamped.

- Small and compact set that contains 30 bits and a magnetic quick release bit holder
- Inlay: Soft touch material with tampo print for easy bit identification
- Transparent lid of polypropylene with rubber protection and a solid belt clip on the back
- Different bit compositions meet the requirements of the following screw heads: Phillips, Pozidriv, TORX®, Slotted, Hexagon, Phillips Grabber, TORX® Tamper TR



Bit Holder: 1/4" DIN 3126-C6.3, ISO 1173

60 mm (L)

Quick-release magnetic bit holder. Knurled black body for a better grip. Matt and black finish for higher resistance. Lock-in type system (forward function).



17 PCS BIT SETS 59S/17 & 60T/17

Standard & Torsion

4 different versions

Drive: 1/4" DIN 3126-C6.3, ISO 1173

Bit Length: 25 mm

Finish: ZnPh (zinc-phosphated)

Material: High performance alloy steel

Each bit is Bahco branded, with the size and tip stamped.

- Attractive and innovative set that contains 16 bits and a magnetic quick release bit holder
- Knurled effect on the sides of the set for a better grip
- The bits have a good protection due to the surrounding solid frame
- Easy to open and to be handled with one hand when working
- Firm belt clip on the back side and clear tamper printing for easy bit identification
- Different bit compositions meet the requirements of the following screw heads: Phillips, Pozidriv, TORX®, Slotted, Hexagon, Phillips Grabber



Bit Holder: 1/4" DIN 3126-C6.3, ISO 1173

50 mm (L)

Quick-release magnetic bit holder. Knurled black body for a better grip. Matt and black finish for higher resistance. Lock-in type system (forward function).



7 PCS BIT SETS 59S/7 & 60T/7

Standard, Torsion, Inox, TiN & Diamond

8 different versions

Drive: 1/4" DIN 3126-C6.3, ISO 1173

Bit Length: 25 mm

Finish:

- ZnPh (zinc-phosphated): Standard and Torsion bits
- TiN coating: TiN Torsion bits
- Nickel Plating: Stainless steel
- Diamond coating: Diamond bits

Material: High performance alloy steel

Each bit is Bahco branded, with the size and tip stamped.

- Small and compact set that contains 6 bits and a magnetic universal holder
- The smooth opening and closing system makes the set easy to be handle, also with one hand
- The small size of the set makes it ideal to be carried in a pocket
- Knurled sides for a better grip
- Clear symbols and text for identification of the bit



Universal holder: 1/4" DIN 3126-C6.3, ISO 1173
50 mm (L)

- **Magnetic universal holder:**
Standard, TiN Torsion and Torsion sets
- **Magnetic universal holder + retaining ring:**
Diamond set
- **Stainless steel universal holder + retaining ring:**
Stainless steel set





K6701M

SOCKETS METRIC



- DIN 3129, ISO 2725
- Drive: 1/4" DIN 3121-G 6,3, ISO 1174
- Finish: Black finish
- Material: High performance alloy steel
- To be used with machines. For maximum safety, use clamping springs

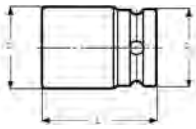

	 731415		 mm	L mm	D1 mm	D2 mm		 g
K6701M-6	1813260	1	6	22	10.2	13	K560F-1	14
K6701M-7	1777920	1	7	22	11.5	13	K560F-1	14
K6701M-8	1778064	1	8	22	12.7	13	K560F-1	15
K6701M-9	1815110	1	9	22	14.0	13	K560F-1	15
K6701M-10	1778149	1	10	22	15.2	13	K560F-1	16
K6701M-11	1778224	1	11	22	16.4	13	K560F-1	19
K6701M-12	1811891	1	12	22	17.4	13	K560F-1	22
K6701M-13	1778491	1	13	22	19.0	13	K560F-1	23
K6701M-14	1844172	1	14	23	20.5	13	K560F-1	25

KM6701M

SOCKETS METRIC, MAGNETIC



- DIN 3129, ISO 2725
- Drive: 1/4" DIN 3121-G 6,3, ISO 1174
- Finish: Black finish
- Material: High performance alloy steel
- To be used with machines. For maximum safety, use clamping springs

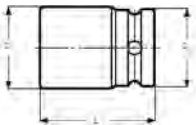

	 731415		 mm	L mm	D1 mm	D2 mm		 g
KM6701M-7	1844240	1	7	28	11.5	13	K560F-1	16
KM6701M-8	1844257	1	8	28	12.7	13	K560F-1	17
KM6701M-10	1844264	1	10	28	15.2	13	K560F-1	19

6972H

ADAPTORS, BIT HOLDER



- Form A, DIN 7427
- Drive: 1/4" DIN 3121-G 6,3, ISO 1174
- Finish: Nickel and chrome plated
- Material: High performance alloy steel
- To be used with machines. For maximum safety, use clamping springs

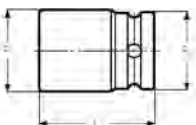

	 731415				L mm	D1 mm	D2 mm		 g
6972H	1215934	5	1/4"	1/4"	26.0	13.0	13.0	K560F-1	18



K560F-1

CLAMPING SPRINGS



- Safety clamping spring
- To be used in impact sockets and accessories
- Material: Spring steel

	 731415				
K560F-1	1825492	5	1/4"	6-14	1



K7401M

SOCKETS METRIC



- DIN 3129, ISO 2725
- Drive: 3/8" DIN 3121-F 10 ISO 1174
- Finish: Black finish
- Material: High performance alloy steel
- To be used with machines. For maximum safety, use clamping springs

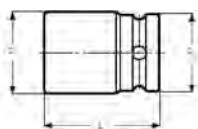

	 731415		 mm	L mm	D1 mm	D2 mm		
K7401M-7	1812126	1	7	26	12.5	19	K560F-2	35
K7401M-8	1780043	1	8	26	12.9	19	K560F-2	35
K7401M-9	1812133	1	9	26	14.5	19	K560F-2	35
K7401M-10	1780128	1	10	26	15.9	19	K560F-2	35
K7401M-11	1780395	1	11	27	16.7	19	K560F-2	35
K7401M-12	1811907	1	12	27	18.0	19	K560F-2	40
K7401M-13	1780470	1	13	27	19.7	22	K560F-3	45
K7401M-14	1780555	1	14	27	20.5	22	K560F-3	55
K7401M-15	1812140	1	15	28	21.2	22	K560F-3	55
K7401M-16	1780630	1	16	28	22.8	22	K560F-3	60
K7401M-17	1780715	1	17	29	24.5	22	K560F-3	65
K7401M-18	1812157	1	18	29	25.3	22	K560F-3	70
K7401M-19	1812164	1	19	30	26.8	22	K560F-3	75
K7401M-20	1844271	1	20	31	28.5	22	K560F-3	100
K7401M-21	1845216	1	21	31	29.3	22	K560F-3	85
K7401M-22	1845223	1	22	33	30.0	22	K560F-3	100
K7401M-24	1844295	1	24	34	33.2	22	K560F-3	120



IMPACT TOOLS 3/8"

K7406M

SOCKETS METRIC, LONG



- Drive: 3/8" DIN 3121-F 10 ISO 1174
- Finish: Black finish
- Material: High performance alloy steel
- To be used with machines. For maximum safety, use clamping springs
- T = depth of female hexagon

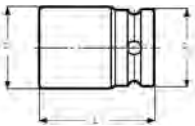

	 731415		 mm	L mm	D1 mm	D2 mm	T mm		 g
K7406M-10	1844479	1	10	54	15.9	19	7.0	K560F-2	47
K7406M-13	1844486	1	13	54	19.7	19	10.4	K560F-2	68
K7406M-17	1844493	1	17	66	24.5	22	11.2	K560F-3	100

K7760C

EXTENSIONS



- Drive: 3/8" DIN 3121-G 10 ISO 1174
- Finish: Black finish
- Material: High performance alloy steel
- With through hole
- To be used with machines. For maximum safety, use clamping springs
- D2 = outside diameter of the female end

	 731415				 mm	D2 mm		 g
K7760C-1	1222369	1	3/8"	3/8"	75	20	K560F-2	76
K7760C-2	1222376	1	3/8"	3/8"	150	20	K560F-2	148

K7767S

BALL JOINT



- Drive: 3/8" DIN 3121-G 10 ISO 1174
- Finish: Black finish
- Material: High performance alloy steel
- With spring loaded pin
- Maximum angle 35°
- To be used with machines. For maximum safety, use clamping springs
- D2 = outside diameter of the female end

	 731415				 mm	D2 mm		 g
K7767S	1222512	1	3/8"	3/8"	49	20	K560F-3	82



K6964C/K8164C

ADAPTORS



K6964C



K8164C

- Drive: 3/8" DIN 3121-G 10 ISO 1174
- Finish: Black finish
- Material: High performance alloy steel
- With spring loaded pin
- To be used with machines. For maximum safety, use clamping springs
- D2 = outside diameter of the female end
- Warning: The torque to be applied should be limited to the smallest drive

		 731415				 mm	D2 mm		 g
K6964C		1215170	1	1/4"	3/8"	30	20	K560F-2	35
K8164C		1237523	1	1/2"	3/8"	35	20	K560F-2	53

7407H-7409H

ADAPTORS, BIT HOLDER



7407H / 7408H



7409H

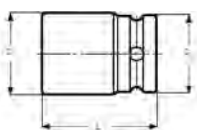

- DIN 3126-C, ISO 1173
- Drive: 3/8" DIN 3121-F 10 ISO 1174
- Finish: Black finish
- Material: High performance alloy steel
- For bits with 1/4", 5/16", 11 mm male hexagon drive
- To be used with machines. For maximum safety, use clamping springs
- 11 mm size is out of standards DIN 3126-C, ISO 1173

		 731415				L mm	D1 mm	D2 mm		 g
7407H		1218249	1	1/4"	3/8"	26	13	20	K560F-2	35
7408H		1218300	1	5/16"	3/8"	26	13	20	K560F-2	43
7409H		1218355	1	11 mm	3/8"	34	22	22	K560F-3	43

K560F-2/3

CLAMPING SPRINGS



- Safety clamping spring
- To be used in impact sockets and accessories
- Material: Spring steel

		 731415				 g
K560F-2		1825324	5	3/8"	7-12	2
K560F-3		1825331	5	3/8"	13-24	2



K7801M

SOCKETS METRIC



- DIN 3129, ISO 2725
- Drive: 1/2" DIN 3121-G 12,5 ISO 1174
- Finish: Black finish
- Material: High performance alloy steel
- To be used with machines. For maximum safety, use clamping springs

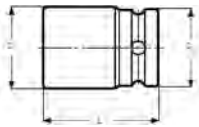

	 731415		 mm	L mm	D1 mm	D2 mm		 g
K7801M-8	1845230	1	8	38	15.0	25	K560F-4	80
K7801M-9	1845247	1	9	38	16.0	25	K560F-4	85
K7801M-10	1778576	1	10	38	17.0	25	K560F-4	85
K7801M-11	1778651	1	11	38	18.5	25	K560F-4	88
K7801M-12	1815790	1	12	38	19.5	25	K560F-4	90
K7801M-13	1778736	1	13	38	21.0	25	K560F-4	95
K7801M-14	1778811	1	14	38	22.5	25	K560F-4	100
K7801M-15	1815806	1	15	38	23.0	30	K560F-5	120
K7801M-16	1779030	1	16	38	25.0	30	K560F-5	130
K7801M-17	1779115	1	17	38	26.0	30	K560F-5	135
K7801M-18	1779382	1	18	38	27.5	30	K560F-5	145
K7801M-19	1779467	1	19	38	28.5	30	K560F-5	150
K7801M-20	1844509	1	20	38	30.0	30	K560F-5	160
K7801M-21	1779542	1	21	38	31.0	30	K560F-5	165
K7801M-22	1779627	1	22	38	32.5	30	K560F-5	170
K7801M-23	1844516	1	23	38	34.0	30	K560F-5	175
K7801M-24	1779894	1	24	38	35.0	30	K560F-5	180
K7801M-25	1844523	1	25	45	36.0	30	K560F-5	185
K7801M-26	1844530	1	26	45	37.5	30	K560F-5	190
K7801M-27	1779979	1	27	45	38.5	30	K560F-5	200
K7801M-30	1811914	1	30	50	42.0	30	K560F-5	230
K7801M-32	1825157	1	32	50	44.0	38	K560F-5	245
K7801M-34	1844547	1	34	50	45.0	38	K560F-6	260
K7801M-36	1844554	1	36	50	48.0	38	K560F-6	330

K7801VM

REINFORCED SOCKETS FOR WHEEL NUTS, METRIC



- Drive: 1/2" DIN 3121-G 12,5 ISO 1174
- Finish: Black finish
- Material: High performance alloy steel
- To be used with machines
- For maximum safety, use clamping springs
- Reinforced design, especially suited for wheel nuts
- T = depth of female hexagon

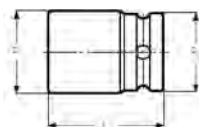

	 731415		 mm	L mm	D1 mm	D2 mm	T mm		 g
K7801VM-17	1781521	1	17	45	30	30	15	K560F-5	130
K7801VM-19	1781798	1	19	45	33	30	18	K560F-5	155
K7801VM-22	1781873	1	22	45	36	30	18	K560F-5	180
K7801VM-24	1781958	1	24	45	38	30	18	K560F-5	215



K7801VM/S4

SOCKET SETS



- Set of 1/2" impact sockets
- 1/2" DIN 3121-G 12,5 ISO 1174
- Finish: Black finish
- Material: High performance alloy steel
- To be used with machines. For maximum safety, use clamping springs
- In metal-sheet box



	 731415		 g
K7801VM/S4	1799090	1	910

K7801VM 17, 19, 22, 24 mm



D/

SOCKET SETS



D/S10

- Set of 1/2" impact sockets
- DIN 3129, ISO 2725
- 1/2" DIN 3121-G 12,5 ISO 1174
- Finish: Black finish
- Material: High performance alloy steel
- To be used with machines. For maximum safety, use clamping springs
- Removable three section plastic box, 1 pc in D/S14 and 2 pc in D/S10



D/S14

	 731151		 mm	 g
D/S10	8280307	6	280x160x70	1595
D/S14	8280314	6	280x160x70	2155

D/S10 K7801 10, 11, 12, 13, 14, 15, 16, 17, 18, 19 mm



D/S14 K7081 10, 11, 2, 13, 14, 15, 16, 17, 18, 19, 21, 22, 24, 27 mm





IMPACT TOOLS 1/2"

K7806M

SOCKETS METRIC, LONG



- Drive: 1/2" DIN 3121-G 12,5 ISO 1174
- Finish: Black finish
- Material: High performance alloy steel
- To be used with machines. For maximum safety, use clamping springs
- T = depth of female hexagon

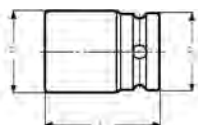

	 731415		 mm	L mm	D1 mm	D2 mm	T mm		 g
K7806M-10	1844677	1	10	80	17.5	25	7.6	K560F-4	215
K7806M-11	1844684	1	11	80	18.0	25	8.6	K560F-4	215
K7806M-12	1844691	1	12	80	19.3	25	9.4	K560F-4	215
K7806M-13	1805944	1	13	80	20.9	25	10.2	K560F-4	220
K7806M-14	1844707	1	14	80	22.3	25	10.7	K560F-4	220
K7806M-16	1844714	1	16	80	24.4	30	12.0	K560F-5	320
K7806M-17	1805951	1	17	80	25.2	30	12.7	K560F-5	320
K7806M-18	1844721	1	18	80	26.8	30	12.7	K560F-5	320
K7806M-19	1805968	1	19	80	28.5	30	14.0	K560F-5	320
K7806M-21	1823597	1	21	83	31.4	30	14.2	K560F-5	350
K7806M-22	1805975	1	22	89	32.7	30	14.2	K560F-5	390
K7806M-23	1844738	1	23	89	34.0	30	16.3	K560F-5	490
K7806M-24	1805982	1	24	89	34.9	30	16.3	K560F-5	490
K7806M-27	1805999	1	27	89	38.9	30	20.3	K560F-5	495
K7806M-30	1844578	1	30	89	42.8	30	21.6	K560F-5	535

K7806M/S4

SOCKET SETS, LONG



- Set of 1/2" deep impact sockets
- 1/2" DIN 3121-G 12,5 ISO 1174
- Finish: Black finish
- Material: High performance alloy steel
- To be used with machines. For maximum safety, use clamping springs
- Reinforced design, especially suited for wheel nuts
- In cardboard packaging



	 731415		 g
K7806M/S4	1813222	1	1250

K7806M 17, 19, 22, 24 mm





DD/

SOCKET SETS, LONG



DD/S10



DD/S14



- Set of 1/2" deep impact sockets
- 1/2" DIN 3121-G 12,5 ISO 1174
- Finish: Black finish
- Material: High performance alloy steel
- To be used with machines. For maximum safety, use clamping springs
- Case with 2-component handle. 3 pcs removable three section plastic box in DD/S14

	 731151		 mm	 g
DD/S10	8280321	6	280x160x70	3020
DD/S14	8280338	4	375x215x100	5085

DD/S10	K7806M 10, 11, 12, 13, 14, 15, 16, 17, 18, 19 mm	
DD/S14	K7806M 10, 11, 12, 13, 14, 15, 16, 17, 18, 19, 21, 22, 24, 27 mm	

D-DD/

SOCKET SETS METRIC MIXED



- 1/2" mixed set with 10 pcs deep and 10 pcs standard impact sockets
- DIN 3129, ISO 2725
- 1/2" DIN 3121-G 12,5 ISO 1174
- Finish: Black finish
- Material: High performance alloy steel
- To be used with machines. For maximum safety, use clamping springs
- Case with 2-component handle

	 731415		 mm	 g
D-DD/S20	8280345	4	375x215x100	4765

K7801M	10, 11, 12, 13, 14, 15, 16, 17, 18, 19 mm	
K7806M	10, 11, 12, 13, 14, 15, 16, 17, 18, 19 mm	



K7801Z

SOCKETS INCH



- DIN 3129, ISO 2725
- Drive: 1/2" DIN 3121-G 12,5 ISO 1174
- Finish: Black finish
- Material: High performance alloy steel
- To be used with machines. For maximum safety, use clamping springs

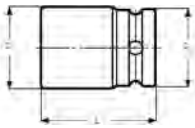

	 731415			L mm	D1 mm	D2 mm		
	1822606	1	3/8	38	17.0	25	K560F-4	80
	1844561	1	7/16	38	18.5	25	K560F-4	80
	1822620	1	1/2	38	20.5	25	K560F-4	85
	1822637	1	9/16	38	22.5	25	K560F-4	85
	1844585	1	5/8	38	25.0	30	K560F-5	120
	1844592	1	11/16	38	26.5	30	K560F-5	130
	1822668	1	3/4	40	29.0	30	K560F-5	130
	1844608	1	13/16	40	31.0	30	K560F-5	155
	1844615	1	7/8	40	33.0	30	K560F-5	165
	1844622	1	15/16	45	35.0	30	K560F-5	170
	1844639	1	1	45	36.5	30	K560F-5	180
	1844646	1	1 1/16	46	39.0	30	K560F-5	185
	1844653	1	1 1/8	46	41.0	30	K560F-5	200
	1844660	1	1 1/4	51	44.2	30	K560F-5	245
	0137671	5	1 5/16	46	44.8	30	K560F-5	230
	0137688	5	1 3/8	50	47.8	30	K560F-5	250
	0137695	5	1 7/16	50	49.8	30	K560F-5	280
	0137701	5	1 1/2	50	51.8	30	K560F-5	310

K7806Z

SOCKETS INCH, DEEP



- Drive: 1/2" DIN 3121-G 12,5 ISO 1174
- Finish: Black finish
- Material: High performance alloy steel
- To be used with machines. For maximum safety, use clamping springs
- T = depth of female hexagon

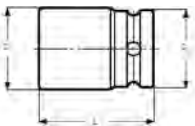

	 731415			L mm	D1 mm	D2 mm	T mm		
	0137725	10	3/8	78	17	25	12	K560F-4	160
	0137732	10	7/16	78	18.5	25	13	K560F-4	160
	0137749	10	1/2	78	20.5	25	14	K560F-4	180
	0137756	10	9/16	78	23	25	14	K560F-4	180
	0137763	5	5/8	78	24.5	30	16	K560F-5	180
	0137770	5	11/16	78	27	30	17	K560F-5	220
	0137787	5	3/4	78	28	30	20	K560F-5	225
	0137794	5	13/16	78	30	30	22	K560F-5	290
	0137800	5	7/8	78	31.8	30	22	K560F-5	320
	0137718	5	15/16	78	33.8	30	24	K560F-5	320
	0137817	5	1	78	35.8	30	27	K560F-5	340
	0137824	5	1 1/16	78	37.8	30	27	K560F-5	410
	0137831	5	1 1/8	78	39.8	30	27	K560F-5	410
	0137848	5	1 1/4	78	43.8	30	32	K560F-5	430
	0137855	5	1 5/16	78	44.8	30	32	K560F-5	430
	0137862	5	1 3/8	78	47.8	30	32	K560F-5	480
	0137879	5	1 7/16	78	49.8	30	32	K560F-5	570
	0137886	5	1 1/2	78	49.8	30	32	K560F-5	570



K7801Z/10

SOCKET SETS INCH



- Set of 1/2" impact sockets, in inches
- DIN 3129, ISO 2725
- Drive: 1/2" DIN 3121-G 12,5 ISO 1174
- Finish: Black finish
- Material: High performance alloy steel
- To be used with machines. For maximum safety, use clamping springs
- In metal-sheet box



	 731415		 mm	 g
K7801Z/10	0165018	1	90x220x110	2200

K7801Z/10 7/16, 1/2, 9/16, 5/8, 11/16, 3/4, 13/16, 7/8, 15/16, 1



K7806Z/10

SOCKET SETS INCH



- Set of 1/2" deep impact sockets, in inches
- 1/2" DIN 3121-G 12,5 ISO 1174
- Finish: Black finish
- Material: High performance alloy steel
- To be used with machines. For maximum safety, use clamping springs
- In metal-sheet box



	 731415		 mm	 g
K7806Z/10	0165025	1	90x220x110	3385

K7806Z/10 7/16, 1/2, 9/16, 5/8, 11/16, 3/4, 13/16, 7/8, 15/16, 1





K7801TORX-E

SOCKETS TORX®



- Drive: 1/2" for TORX® head screws, external
- Finish: Black finish
- Material: High performance alloy steel
- To be used with machines. For maximum safety, use clamping springs
- Drive with through hole for power driven machines

** special screws

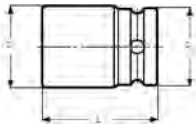

	 731415			L mm	D1 mm	D2 mm			
K7801TORX-E10	1811587	1	E10	38	13.5	25	M 6+8	K560F-4	80
K7801TORX-E12	1811594	1	E12	38	15.5	25	M 8+10	K560F-4	80
K7801TORX-E14	1811600	1	E14	38	17.5	25	M 10+12	K560F-4	85
K7801TORX-E16	1811617	1	E16	38	19.6	25	**	K560F-4	85
K7801TORX-E18	1811624	1	E18	38	21.7	30	M 12+14	K560F-4	85
K7801TORX-E20	1811631	1	E20	38	23.8	30	M 14+16	K560F-4	85
K7801TORX-E24	1811648	1	E24	38	28.3	30	M 18+20	K560F-5	90

K8160D

EXTENSIONS



- Drive: 1/2" DIN 3121-G 12,5 ISO 1174
- Finish: Black finish
- Material: High performance alloy steel
- With through hole
- To be used with machines. For maximum safety, use clamping springs
- D2 = outside diameter of the female end

	 731415				 mm	D2 mm		
K8160D-1	1237400	1	1/2"	1/2"	75	25	K560F-4	140
K8160D-2	1237417	1	1/2"	1/2"	125	25	K560F-4	225
K8160D-3	1237424	1	1/2"	1/2"	250	25	K560F-4	440

K8167S

BALL JOINT



- Drive: 1/2" DIN 3121-G 12,5 ISO 1174
- Finish: Black finish
- Material: High performance alloy steel
- Maximum angle 30° with through hole
- To be used with machines. For maximum safety, use clamping springs
- D2 = outside diameter of the female end

	 731415				 mm	D2 mm		
K8167S	1237592	1	1/2"	1/2"	62	34	K560F-5	205



K7764D/K8964D

ADAPTORS



K7764D



K8964D

- Drive: 1/2" DIN 3121-G 10 ISO 1174
- Finish: Black finish
- Material: High performance alloy steel
- With through hole
- To be used with machines. For maximum safety, use clamping springs
- D2 = outside diameter of the female end
- Warning: The torque to be applied should be limited to the smallest drive

	 731415				 mm	D2 mm		
K7764D	1222475	1	3/8"	1/2"	35	25	K560F-4	81
K8964D	1268237	1	3/4"	1/2"	45	25	K560F-4	112

7807H-7809H

ADAPTORS, HOLDER



Mo. 1



Mo. 2

- Drive: 1/2" DIN 3121-G 12,5 ISO 1174
- Finish: Black finish
- Material: High performance alloy steel
- With spring loaded pin
- To be used with machines. For maximum safety, use clamping springs
- D2 = outside diameter of the female end
- * with spring collar
- ** with locking screw

	 731415		Mo			L mm	D2 mm		
7807H	1232764	1	* 1	1/4"	1/2"	38	25	K560F-4	70
7808H	1232771	1	* 1	5/16"	1/2"	38	25	K560F-4	75
7809H	1232788	1	** 2	11.2 mm	1/2"	38	25	K560F-4	90

K560F-4/5

CLAMPING SPRINGS



- Safety clamping spring
- To be used in impact sockets and accesories
- Material: Spring steel

	 731415					
K560F-4	1825348	5	1/2"	10-14	E10-E20	3
K560F-5	1825355	5	1/2"	15-32	E24	3



7993S

SOCKET DRIVERS



- 1/2" hexagonal socket driver
- Finish: Black finish
- Material: High performance alloy steel
- To be used with machines. For maximum safety, use clamping springs

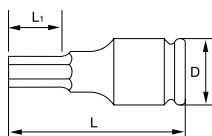

	 841334			D mm	L mm	L1 mm	 g
7993S0050	5115070	1	5	25	44	8	65
7993S0060	5115094	1	6	25	44	9	65
7993S0080	5115117	1	8	25	44	12	65
7993S0100	5115131	1	10	25	47	16	65
7993S0120	5115155	1	12	30	50	18	140
7993S0140	5115179	1	14	30	50	21	140
7993S0170	5115193	1	17	30	50	26	140
7993S0190	5115216	1	19	30	50	26	140

7994S

SOCKET DRIVERS



- 1/2" TORX® socket driver
- Finish: Black finish
- Material: High performance alloy steel
- To be used with machines. For maximum safety, use clamping springs

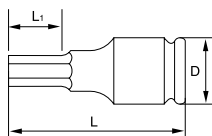

	 841334			D mm	L mm	L1 mm	 g
7994S0300	5129305	1	T-30	25	55	30	80
7994S0400	5129312	1	T-40	25	55	30	80
7994S0450	5129329	1	T-45	25	55	30	82
7994S0500	5129336	1	T-50	25	55	30	84
7994S0550	5129343	1	T-55	25	55	30	92
7994S0600	5129350	1	T-60	25	55	30	98



K8901M

SOCKETS METRIC

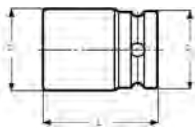

- DIN 3129, ISO 2725
- Drive: 3/4" DIN 3121-H 20, ISO 1174
- Finish: Black finish
- Material: High performance alloy steel
- To be used with machines. For maximum safety, use clamping springs

	 731415		 mm	L mm	D1 mm	D2 mm		 g
K8901M-17	1803155	1	17	51	30.0	44	K560F-6	365
K8901M-18	1844189	1	18	51	31.0	44	K560F-6	365
K8901M-19	1803162	1	19	51	32.5	44	K560F-6	365
K8901M-21	1803179	1	21	51	35.0	44	K560F-6	370
K8901M-22	1803186	1	22	51	36.0	44	K560F-6	375
K8901M-23	1803193	1	23	51	37.5	44	K560F-6	375
K8901M-24	1803209	1	24	51	38.5	44	K560F-6	380
K8901M-27	1803216	1	27	53	42.5	44	K560F-6	395
K8901M-28	1803223	1	28	53	44.0	44	K560F-6	400
K8901M-29	1803230	1	29	53	45.0	44	K560F-6	410
K8901M-30	1803247	1	30	53	46.0	44	K560F-6	420
K8901M-32	1803254	1	32	57	48.5	44	K560F-6	425
K8901M-33	1803261	1	33	57	50.0	44	K560F-6	520
K8901M-34	1803278	1	34	57	51.0	44	K560F-6	520
K8901M-36	1803285	1	36	57	53.5	44	K560F-6	540
K8901M-38	1803292	1	38	57	56.0	44	K560F-6	590
K8901M-41	1803308	1	41	58	60.0	44	K560F-6	600
K8901M-46	1803315	1	46	62	66.0	44	K560F-6	690
K8901M-50	1846398	1	50	68	71.0	44	K560F-7	700
K8901M-55	1846404	1	55	72	77.5	54	K560F-7	750
K8901M-60	1846411	1	60	72	83.5	54	K560F-7	800

K8901Z

SOCKETS INCH

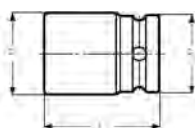

- DIN 3129, ISO 2725
- Drive: 3/4" DIN 3121-H 20, ISO 1174
- Finish: Black finish
- Material: High performance alloy steel
- To be used with machines. For maximum safety, use clamping springs

	 731415		 "	L mm	D1 mm	D2 mm		 g
K8901Z-3/4	1844202	1	3/4	50	33.0	44	K560F-6	360
K8901Z-13/16	1844226	1	13/16	50	35.0	44	K560F-6	370
K8901Z-7/8	1844301	1	7/8	50	37.0	44	K560F-6	370
K8901Z-15/16	1844745	1	15/16	50	39.0	44	K560F-6	380
K8901Z-1	1844752	1	1	50	41.0	44	K560F-6	380
K8901Z-1.1/16	1844769	1	1 1/16	50	43.0	44	K560F-6	370
K8901Z-1.1/8	1844776	1	1 1/8	50	45.0	44	K560F-6	380
K8901Z-1.1/4	1844783	1	1 1/4	53	49.0	44	K560F-6	450
K8901Z-1.5/16	1844790	1	1 5/16	56	50.0	44	K560F-6	475
K8901Z-1.3/8	1844806	1	1 3/8	56	53.5	44	K560F-6	530
K8901Z-1.7/16	1844813	1	1 7/16	56	53.5	44	K560F-6	560
K8901Z-1.1/2	1844820	1	1 1/2	58	55.0	44	K560F-6	580
K8901Z-1.5/8	1844837	1	1 5/8	58	61.0	44	K560F-6	610
K8901Z-1.3/4	1844844	1	1 3/4	63	65.0	44	K560F-6	720
K8901Z-1.15/16	0130290	1	1 15/16	68	70	44	K560F-6	830
K8901Z-2	0130306	1	2	68	71	44	K560F-6	830
K8901Z-2.1/16	0130313	1	2 1/16	71	73	54	K560F-7	1020
K8901Z-2.3/16	0130337	1	2 3/16	71	78	54	K560F-7	1150
K8901Z-2.1/4	0130344	1	2 1/4	73	80	54	K560F-7	1230
K8901Z-2.3/8	0130351	1	2 3/8	73	83	54	K560F-7	1260



IMPACT TOOLS 3/4"

K8906M

SOCKETS METRIC, LONG



- Drive: 3/4" DIN 3121-H 20, ISO 1174
- Finish: Black finish
- Material: High performance alloy steel
- To be used with machines. For maximum safety, use clamping springs
- T = depth of the female hexagon

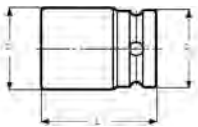

	 731415		 mm	L mm	D1 mm	D2 mm	T mm		 g
K8906M-17	1803056	1	13	100	30.0	44	13	K560F-6	910
K8906M-19	1803063	1	19	100	32.5	44	14	K560F-6	880
K8906M-21	1844851	1	21	100	36.5	44	14	K560F-6	845
K8906M-22	1803070	1	22	100	36.5	44	16	K560F-6	845
K8906M-24	1803087	1	24	100	39.0	44	16	K560F-6	700
K8906M-27	1803094	1	27	100	43.0	44	18	K560F-6	750
K8906M-30	1803117	1	30	100	46.0	44	19	K560F-6	770
K8906M-32	1803124	1	32	100	49.0	44	22	K560F-6	870
K8906M-33	1844868	1	33	100	50.8	44	22	K560F-6	990
K8906M-34	1844875	1	34	100	50.8	44	22	K560F-6	990
K8906M-36	1803148	1	36	100	54.0	44	22	K560F-6	1000
K8906M-41	1845254	1	41	100	60.5	44	24	K560F-6	1150

K8906Z

SOCKETS INCH, LONG



- DIN 3129, ISO 2725
- Drive: 3/4" DIN 3121-H 20, ISO 1174
- Finish: Black finish
- Material: High performance alloy steel
- To be used with machines. For maximum safety, use clamping springs
- T = depth of female hexagon

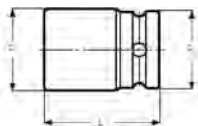

	 731415		 "	L mm	D1 mm	D2 mm	T mm		 g
K8906Z-3/4	0130399	1	3/4	90	32	41.4	26	K560F-6	480
K8906Z-13/16	0130405	1	13/16	90	35	41.4	26	K560F-6	510
K8906Z-7/8	0130412	1	7/8	90	36	41.4	26	K560F-6	550
K8906Z-15/16	0130429	1	15/16	90	38.5	41.4	26	K560F-6	580
K8906Z-1	0130436	1	1	90	40	41.4	26	K560F-6	610
K8906Z-1.1/16	0130443	1	1 1/16	90	42.5	44	28	K560F-6	630
K8906Z-1.1/8	0130450	1	1.1/8	90	44	44	28	K560F-6	650
K8906Z-1.1/4	0130474	1	1.1/4	90	48.5	44	28	K560F-6	740
K8906Z-1.5/16	0130481	1	1.5/16	90	50	44	30	K560F-6	760
K8906Z-1.3/8	0130498	1	1.3/8	90	52.5	44	30	K560F-6	840
K8906Z-1.7/16	0130504	1	1.7/16	90	53.5	44	30	K560F-6	850
K8906Z-1.1/2	0130511	1	1.1/2	90	56	44	34	K560F-6	880
K8906Z-1.5/8	0130535	1	1.5/8	90	60	44	34	K560F-6	950
K8906Z-1.3/4	0130559	1	1.3/4	90	64.5	44	34	K560F-6	1040
K8906Z-2	0130580	1	2	90	71	44	36	K560F-6	1240





K8901M/8



SOCKET SETS

- Set of 3/4" impact sockets, in metric sizes
- DIN 3129, ISO 2725
- 3/4" DIN 3121-H 20, ISO 1174
- Finish: Black finish
- Material: High performance alloy steel
- To be used with machines. For maximum safety, use clamping springs
- In metal-sheet box

	 731415		 mm	 g
K8901M/8	0165032	1	110x250x125	4900

K8901M 21, 22, 24, 27, 30, 32, 36, 41 mm



K8901Z/8



SOCKET SETS

- Set of 3/4" impact sockets, in inches
- DIN 3129, ISO 2725
- 3/4" DIN 3121-H 20, ISO 1174
- Finish: Black finish
- Material: High performance alloy steel
- To be used with machines. For maximum safety, use clamping springs
- In metal-sheet box

	 731415		 mm	 g
K8901Z/8	0165049	1	110x250x125	4100

K8901Z 1, 1.1/16, 1.1/8, 1.1/4, 1.5/16, 1.3/8, 1.7/16, 1.1/2



K8906M/8



SOCKET SETS

- Set of 3/4" deep impact sockets, in metric sizes
- 3/4" DIN 3121-H 20, ISO 1174
- Finish: Black finish
- Material: High performance alloy steel
- To be used with machines. For maximum safety, use clamping springs
- In metal-sheet box

	 731415		 mm	 g
K8906M/8	0165056	1	110x250x125	8330

K8906M 21, 22, 24, 27, 30, 32, 36, 41 mm





IMPACT TOOLS 3/4"

K8906Z/8

SOCKET SETS



- Set of 3/4" deep impact sockets, in inches
- 3/4" DIN 3121-H 20, ISO 1174
- Finish: Black finish
- Material: High performance alloy steel
- To be used with machines. For maximum safety, use clamping springs
- In metal-sheet box



K8906Z/8	731415 0165063	1	110x250x125 mm	7360 g

K8906Z 1, 1.1/16, 1.1/8, 1.1/4, 1.5/16, 1.3/8, 1.7/16, 1.1/2



K8960F

EXTENSIONS



- Drive: 3/4" DIN 3121H 20, ISO 1174
- Finish: Black finish
- Material: High performance alloy steel
- With through hole
- To be used with machines. For maximum safety, use clamping springs
- D2 = outside diameter of the female end

K8960F-2	731415 1268138	1	3/4"	3/4"	175 mm	44.0 mm	K560F-6	850
K8960F-3	1268145	1	3/4"	3/4"	250	44.0	K560F-6	1190

K8967S

BALL JOINT



- Drive: 3/4" DIN 3121-H 20 ISO 1174
- Finish: Black finish
- Material: High performance alloy steel
- Maximum angle 35°
- With through hole
- To be used with machines. For maximum safety, use clamping springs
- D2 = outside diameter of the female end

K8967S	731415 1268329	1	3/4"	3/4"	98 mm	44.0 mm	K560F-6	670





K8164F/K9564F

ADAPTORS



K8164F



K9564F

- Drive: 3/4" DIN 3121-H 20 ISO 1174
- Finish: Black finish
- Material: High performance alloy steel
- With through hole
- To be used with machines. For maximum safety, use clamping springs
- D2 = outside diameter of the female end

						D2 mm		
K8164F	731415 1237554	1	1/2"	3/4"	56.0	44.0	K560F-6	350
K9564F	1286026	1	1"	3/4"	63.0	44.0	K560F-6	410

K8909H

ADAPTORS, BIT HOLDER

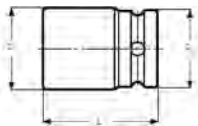

- Drive 3/4" DIN 3121-H 20 ISO 1174
- Finish: Black finish
- Material: High performance alloy steel
- With bit holding locking system
- For screwdriver bits with 22 mm male hexagon drive

					L mm	D1 mm	D2 mm		
K8909H-5	731415 1619343	1	22 mm	3/4"	59	44	44	K560F-6	380

7993T

SOCKET DRIVERS

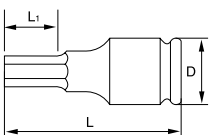

- 3/4" hexagonal tip socket driver
- Finish: Black finish
- Material: High performance alloy steel
- To be used with machines. For maximum safety, use clamping springs

				D mm	L mm	L1 mm	
7993T0120	841334 5115230	1	12	38	67	18	280
7993T0140	5115254	1	14	38	67	21	280
7993T0170	5115278	1	17	38	67	26	280
7993T0190	5115292	1	19	44	67	26	450
7993T0220	5115315	1	22	44	71	26	460
7993T0240	5115339	1	24	44	71	26	500



IMPACT TOOLS 3/4"

K560F-6

CLAMPING SPRINGS



- Safety clamping spring
- To be used in impact sockets and accessories
- Material: Spring steel

	 731415			 mm	 g
K560F-6	1825362	5	3/4"	17-46	6



IMPACT TOOLS 1"

K9501M

SOCKETS METRIC



- DIN 3129, ISO 2725
- Drive: 1" DIN 3121-H 25 ISO 1174
- Finish: Black finish
- Material: High performance alloy steel
- To be used with machines. For maximum safety, use clamping springs

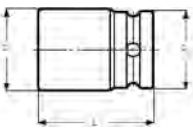

	 731415		 mm	L mm	D1 mm	D2 mm		 g
K9501M-22	1844882	1	22	58	39	54	K560F-7	500
K9501M-24	1802677	1	24	58	42	54	K560F-7	510
K9501M-27	1802684	1	27	59	45.5	54	K560F-7	655
K9501M-30	1802714	1	30	64	49	54	K560F-7	680
K9501M-32	1802721	1	32	64	52	54	K560F-7	690
K9501M-33	1802738	1	33	62	53.0	54	K560F-7	700
K9501M-34	1802745	1	34	62	54.0	54	K560F-7	700
K9501M-36	1802752	1	36	66	57.0	54	K560F-7	765
K9501M-38	1802769	1	38	67	60.0	54	K560F-7	810
K9501M-41	1802776	1	41	69	63.0	54	K560F-7	850
K9501M-42	1802783	1	42	69	64.0	54	K560F-7	865
K9501M-46	1802790	1	46	75	69.5	54	K560F-7	1000
K9501M-50	1802806	1	50	81	74.0	54	K560F-7	1250
K9501M-55	1802813	1	55	86	79.5	54	K560F-7	1550
K9501M-60	1802820	1	60	90	86.0	54	K560F-7	1650
K9501M-65	1802837	1	65	94	90.5	54	K560F-7	2000
K9501M-70	1802844	1	70	98	98.0	54	K560F-7	2150
K9501M-75	1802851	1	75	98	100.0	86	K560F-8	3350
K9501M-80	1802868	1	80	99	105.0	86	K560F-8	3750



K9501Z

SOCKETS INCH



- DIN 3129, ISO 2725
- Drive: 1" DIN 3121-H 25 ISO 1174
- Finish: Black finish
- Material: High performance alloy steel
- To be used with machines. For maximum safety, use clamping springs



	 731415			L mm	D1 mm	D2 mm		
K9501Z-1	1844912	1	1	59	43.0	54	K560F-7	600
K9501Z-1.1/16	0130634	1	1 1/16	60	44.5	54	K560F-7	540
K9501Z-1.1/8	0130641	1	1 1/8	62	46	54	K560F-7	660
K9501Z-1.3/16	0130658	1	1 3/16	62	49	54	K560F-7	680
K9501Z-1.1/4	1844929	1	1 1/4	62	52.0	54	K560F-7	640
K9501Z-1.5/16	0130665	1	1 5/16	63	54	54	K560F-7	710
K9501Z-1.3/8	0130672	1	1 3/8	66	55	54	K560F-7	720
K9501Z-1.7/16	1844936	1	1 7/16	66	57.0	54	K560F-7	680
K9501Z-1.1/2	1844943	1	1 1/2	67	60.0	54	K560F-7	790
K9501Z-1.9/16	0130689	1	1 9/16	66	61	54	K560F-7	800
K9501Z-1.5/8	1844950	1	1 5/8	69	63.0	54	K560F-7	830
K9501Z-1.11/16	0130696	1	1 11/16	70	65	54	K560F-7	910
K9501Z-1.3/4	0130702	1	1 3/4	70	67.5	60.3	K560F-7	1100
K9501Z-1.13/16	1844967	1	1 13/16	75	69.5	54	K560F-7	1140
K9501Z-1.7/8	1844974	1	1 7/8	78	70.5	54	K560F-7	1190
K9501Z-1.15/16	0130719	1	1 5/16	58	40.5	60.3	K560F-7	510
K9501Z-2	0130726	1	2	76	74	60.3	K560F-7	1400
K9501Z-2.1/8	0130740	1	2 1/8	80	79	60.3	K560F-7	1460
K9501Z-2.3/16	0130757	1	2 3/16	84	80	60.3	K560F-7	1630
K9501Z-2.1/4	0130764	1	2 1/4	84	82.5	60.3	K560F-7	1700
K9501Z-2.5/16	0130771	1	2 5/16	84	84	60.3	K560F-7	1780
K9501Z-2.9/16	0130801	1	2 9/16	92	92.5	60.3	K560F-7	2100
K9501Z-2.3/4	0130832	1	2 3/4	96	99	60.3	K560F-7	2440

K9506M

SOCKETS METRIC, LONG



- DIN 3129, ISO 2725
- Drive: 1" DIN 3121-H 25 ISO 1174
- Finish: Black finish
- Material: High performance alloy steel
- To be used with machines. For maximum safety, use clamping springs
- T = depth of female hexagon



	 731415			L mm	D1 mm	D2 mm	T mm		
K9506M-22	1844998	1	22	110	40.0	54	16	K560F-7	1400
K9506M-24	1802530	1	24	110	42.0	54	19	K560F-7	1400
K9506M-27	1802547	1	27	110	46.0	54	19	K560F-7	1400
K9506M-30	1802554	1	30	110	49.5	54	22	K560F-7	1320
K9506M-32	1802561	1	32	110	52.0	54	22	K560F-7	1280
K9506M-33	1802578	1	33	110	53.0	54	22	K560F-7	1250
K9506M-34	1845018	1	34	110	53.5	54	22	K560F-7	1250
K9506M-36	1802585	1	36	110	57.0	54	23	K560F-7	1320
K9506M-38	1802592	1	38	110	59.5	54	25	K560F-7	1400
K9506M-41	1802608	1	41	110	63.0	54	28	K560F-7	1500
K9506M-46	1802615	1	46	110	69.5	54	30	K560F-7	1700
K9506M-50	1802622	1	50	110	74.5	54	32	K560F-7	1930
K9506M-55	1802639	1	55	110	81.0	54	35	K560F-7	2150
K9506M-60	1802646	1	60	110	87.5	54	38	K560F-7	2400



IMPACT TOOLS 1"

K9506Z

SOCKETS INCH, LONG



- DIN 3129, ISO 2725
- Drive: 1" DIN 3121-H 25 ISO 1174
- Finish: Black finish
- Material: High performance alloy steel
- To be used with machines. For maximum safety, use clamping springs
- T = depth of female hexagon

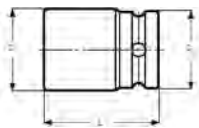

	 731415			L mm	D1 mm	D2 mm	T mm		
K9506Z-1	0131686	1	1	108	42.5	54	30	K560F-7	1060
K9506Z-1.1/16	0131693	1	1 1/16	108	44.5	54	30	K560F-7	1120
K9506Z-1.3/16	0131716	1	1 3/16	108	49	54	30	K560F-7	1200
K9506Z-1.1/4	0131723	1	1 1/4	108	51.5	54	30	K560F-7	1220
K9506Z-1.7/16	0131754	1	1 7/16	108	56.5	54	35	K560F-7	1280
K9506Z-1.1/2	0131761	1	1 1/2	108	59	54	35	K560F-7	1330
K9506Z-1.5/8	0131785	1	1 5/8	108	62.5	54	38	K560F-7	1470
K9506Z-1.13/16	0131808	1	1 13/16	108	69	60.3	42	K560F-7	1640
K9506Z-1.7/8	0131815	1	1 7/8	108	70	60.3	42	K560F-7	1680

K9560G

EXTENSIONS



- Drive: 1" DIN 3121 - F 25/ISO 1174
- Finish: Black finish
- Material: High performance alloy steel
- With through hole
- To be used with machines. For maximum safety, use clamping springs
- D2 = outside diameter of the female end

	 731415				 mm	D2 mm		
K9560G-1	1285944	1	1"	1"	125	53	K560F-7	1085
K9560G-2	1285951	1	1"	1"	175	53	K560F-7	1400
K9560G-3	1285968	1	1"	1"	325	53	K560F-7	2395
K9560G-4	0133970	6	1	1	300	54	K560F-7	2300
K9560G-5	0133987	1	1	1	400	54	K560F-7	3000

K9567S

BALL JOINT



- Drive: 1" DIN 3121-H 25, ISO 1174
- Finish: Black finish
- Material: High performance alloy steel
- With spring loaded pin, maximum angle 35°
- To be used with machines. For maximum safety, use clamping springs
- D2 = outside diameter of the female end

	 731415				 mm	D2 mm		
K9567S	1286095	1	1"	1"	124	64	K560F-7	1426





K8964G/K9895G

ADAPTORS



- Drive: 1" DIN 3121-H 25, ISO 1174
- Finish: Black finish
- Material: High performance alloy steel
- With through hole
- To be used with machines. For maximum safety, use clamping springs
- D2 = outside diameter of the female end

	 731415				 mm	D2 mm		 g
K8964G	1268268	1	3/4"	1"	75	54	K560F-7	620
K9895G	0133949	1	1 1/2"	1"	81	54	K560F-7	1000

K9509H5

ADAPTORS, BIT HOLDER

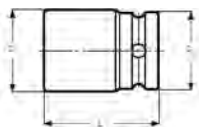

- Drive 1" DIN 3121-H 25 ISO 1174
- Finish: Black finish
- Material: High performance alloy steel
- With bit holding locking screw
- For screwdriver bits with 22 mm male hexagon drive

	 731415				L mm	D1 mm	D2 mm		 g
K9509H5	1619428	1	22 mm	1"	70	46	54	K560F-7	1050

7993M

SOCKET DRIVER

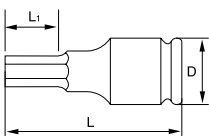

- 1" hexagonal tip socket driver
- Finish: Black finish
- Material: High performance alloy steel
- To be used with machines. For maximum safety, use clamping springs

	 841334			D mm	L mm	L1 mm	 g
7993M0170	5115353	1	17	54	74	26	680
7993M0190	5115377	1	19	54	74	26	700
7993M0220	5115391	1	22	54	78	26	730
7993M0270	5115414	1	27	54	78	26	790



IMPACT TOOLS 1"

K8909ML/K9509ML



SCREWDRIVER BITS FOR HEXAGON METRIC SOCKET HEAD SCREWS

- Finish: Steel-grey, greased
- With 22 mm male hexagon drive
- Bit holding: Locking screw
- Suitable adaptors K8909H-5, K9509H5

	 731415				
K8909ML-12	1232863	1	12	40	53
K8909ML-14	1232870	1	14	40	60
K8909ML-17	1232887	1	17	40	70
K9509ML-19	1618964	1	19	50	117
K9509ML-22	1619183	1	22	50	136
K9509ML-24	1619268	1	24	50	146

K560F-7/8



CLAMPING SPRINGS

- Safety clamping spring
- To be used in impact sockets and accessories
- Material: Spring steel

	 731415				
K560F-7	1825379	5	1"	19-70	9
K560F-8	1825508	5	1 & 1 1/2"	75-80 & 46-90	13



K9801M

SOCKETS METRIC



- DIN 3129, ISO 2725
- Drive: 1.1/2" DIN 3121-H40, ISO1174
- Black finish
- Material: High performance alloy steel
- To be used with machines. For maximum safety, use clamping springs

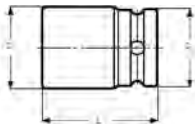

	 731415		 mm	L mm	D1 mm	D2 mm		 g
K9801M-46	1845056	1	46	80	76.3	86	K560F-8	2280
K9801M-50	1845063	1	50	82	81.5	86	K560F-8	2360
K9801M-55	1845070	1	55	82	87.4	86	K560F-8	2370
K9801M-60	1845087	1	60	91	93.6	86	K560F-8	3000
K9801M-65	1845094	1	65	95	99.8	86	K560F-8	3530
K9801M-70	1845100	1	70	100	105.5	86	K560F-8	3710
K9801M-75	1845117	1	75	105	112.0	86	K560F-8	3800
K9801M-80	1845124	1	80	110	117.5	86	K560F-8	4450
K9801M-85	1845131	1	85	120	124.8	86	K560F-8	5440
K9801M-90	1845148	1	90	120	130.0	86	K560F-8	5600
K9801M-95	1845155	1	95	125	136.5	127	K560F-9	8100
K9801M-100	1845162	1	100	125	143.7	127	K560F-9	8600
K9801M-105	1845179	1	105	130	147.6	127	K560F-9	9200
K9801M-110	1845186	1	110	130	153.2	127	K560F-9	1000
K9801M-115	1845193	1	115	140	158.8	127	K560F-9	10800
K9801M-120	1845209	1	120	140	166.7	127	K560F-9	12100
K9801M-125	0167159	1	125	165.1	170.1	82.6	K560F-8	13610
K9801M-130	0167166	1	130	165.1	176.0	82.6	K560F-8	14590
K9801M-135	0167173	1	135	171.5	181.9	82.6	K560F-8	16170
K9801M-140	0167180	1	140	177.8	187.7	82.6	K560F-8	17860
K9801M-145	0167197	1	145	184.2	193.7	82.6	K560F-8	18800
K9801M-150	0167203	1	150	184.2	199.5	82.6	K560F-8	19120
K9801M-155	0167210	1	155	190.5	205.5	82.6	K560F-8	19470



K9801Z

SOCKETS INCH



- DIN 3129, ISO 2725
- Drive: 1.1/2" DIN 3121-H40, ISO1174
- Black finish
- Material: High performance alloy steel
- To be used with machines. For maximum safety, use clamping springs
- Manufactured on demand

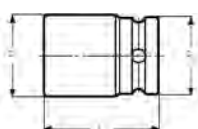

	 731415			L mm	D1 mm	D2 mm		
K9801Z-1.3/8	0131952	1	1 3/8	69.9	63.8	82.6	K560F-8	2060
K9801Z-1.7/16	0131969	1	1 7/16	76.2	65.7	82.6	K560F-8	2030
K9801Z-1.1/2	0131976	1	1 1/2	79.4	67.6	82.6	K560F-8	2000
K9801Z-1.9/16	0131983	1	1 9/16	79.4	69.3	82.6	K560F-8	1970
K9801Z-1.5/8	0131990	1	1 5/8	82.6	71.2	82.6	K560F-8	1960
K9801Z-1.11/16	0132003	1	1 11/16	82.6	73.2	82.6	K560F-8	1980
K9801Z-1.3/4	0132010	1	1 3/4	85.7	75.1	82.6	K560F-8	2250
K9801Z-1.13/16	0132027	1	1 13/16	85.7	76.8	82.6	K560F-8	2200
K9801Z-1.7/8	0132034	1	1 7/8	88.9	78.7	82.6	K560F-8	2320
K9801Z-1.15/16	0132041	1	1 15/16	88.9	80.6	82.6	K560F-8	2490
K9801Z-2	0132058	1	2	88.9	82.6	82.6	K560F-8	2800
K9801Z-2.1/16	0132065	1	2 1/16	92.1	84.8	82.6	K560F-8	2740
K9801Z-2.1/8	0132072	1	2 1/8	95.3	86.2	82.6	K560F-8	2680
K9801Z-2.3/16	0132089	1	2 3/16	95.3	88.1	82.6	K560F-8	2630
K9801Z-2.1/4	0132096	1	2 1/4	95.3	90.0	82.6	K560F-8	3240
K9801Z-2.5/16	0132102	1	2 5/16	98.4	91.8	82.6	K560F-8	3170
K9801Z-2.3/8	0132119	1	2 3/8	98.4	93.7	82.6	K560F-8	3600
K9801Z-2.7/16	0132126	1	2 7/16	101.6	95.6	82.6	K560F-8	3520
K9801Z-2.1/2	0132133	1	2 1/2	101.6	97.5	82.6	K560F-8	3460
K9801Z-2.9/16	0132140	1	2 9/16	104.8	99.3	82.6	K560F-8	3430
K9801Z-2.5/8	0132157	1	2 5/8	104.8	101.2	82.6	K560F-8	3880
K9801Z-2.11/16	0132164	1	2 11/16	108.0	103.1	82.6	K560F-8	4030
K9801Z-2.3/4	0132171	1	2 3/4	111.1	105.0	82.6	K560F-8	4010
K9801Z-2.13/16	0132188	1	2 13/16	111.1	106.8	82.6	K560F-8	4420
K9801Z-2.7/8	0132195	1	2 7/8	111.1	108.7	82.6	K560F-8	4500
K9801Z-2.15/16	0132201	1	2 15/16	114.3	110.6	82.6	K560F-8	4580
K9801Z-3	0132218	1	3	114.3	112.5	82.6	K560F-8	4660
K9801Z-3.1/16	0132225	1	3 1/16	117.5	114.3	82.6	K560F-8	5310
K9801Z-3.1/8	0132232	1	3 1/8	117.5	116.2	82.6	K560F-8	5720
K9801Z-3.1/4	0132249	1	3 1/4	120.7	120.0	82.6	K560F-8	5580
K9801Z-3.5/16	0132256	1	3 5/16	123.8	121.8	82.6	K560F-8	6220
K9801Z-3.3/8	0132263	1	3 3/8	123.8	123.7	82.6	K560F-8	5870
K9801Z-3.7/16	0132270	1	3 7/16	123.8	125.6	82.6	K560F-8	6290
K9801Z-3.1/2	0132287	1	3 1/2	127	127.5	82.6	K560F-8	6640
K9801Z-3.9/16	0132294	1	3 9/16	127	129.3	82.3	K560F-8	6510
K9801Z-3.5/8	0132300	1	3 5/8	130.2	131.2	82.6	K560F-8	6380
K9801Z-3.11/16	0132317	1	3 11/16	130.2	133.1	82.6	K560F-8	6950
K9801Z-3.3/4	0132324	1	3 3/4	133.4	135.0	82.3	K560F-8	7440
K9801Z-3.13/16	0132331	1	3 13/16	133.4	136.8	82.6	K560F-8	7260
K9801Z-3.7/8	0132348	1	3 7/8	136.5	138.7	82.6	K560F-8	7650
K9801Z-3.15/16	0132355	1	3 15/16	136.5	140.6	82.6	K560F-8	7870
K9801Z-4	0132362	1	4	136.5	142.5	82.6	K560F-8	8430
K9801Z-4.1/16	0132379	1	4 1/16	142.9	144.3	82.6	K560F-8	8700
K9801Z-4.1/8	0132386	1	4 1/8	142.9	146.2	82.6	K560F-8	8830
K9801Z-4.1/4	0132393	1	4 1/4	146.1	150.0	82.6	K560F-8	9690
K9801Z-4.5/16	0132409	1	4 5/16	146.1	151.8	82.6	K560F-8	11000
K9801Z-4.3/8	0132416	1	4 3/8	146.1	153.7	82.6	K560F-9	10800
K9801Z-4.7/16	0132423	1	4 7/16	149.2	155.6	82.6	K560F-8	10570
K9801Z-4.1/2	0132430	1	4 1/2	152.4	157.5	82.6	K560F-8	10830
K9801Z-4.5/8	0132447	1	4 5/8	155.6	161.2	82.6	K560F-8	12420
K9801Z-4.3/4	0132454	1	4 3/4	155.6	165.0	82.6	K560F-8	12370



K9806M

SOCKETS METRIC, LONG



- DIN 3129, ISO 2725
- Drive: 1.1/2" DIN 3121-H 40, ISO1174
- Black finish
- Material: High performance alloy steel
- To be used with machines. For maximum safety, use clamping springs
- T = depth of female hexagon
- Manufactured on demand

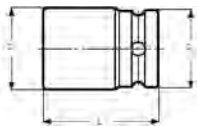

	 731415		 mm	L mm	D1 mm	D2 mm	T mm		 g
K9806M-41	0130986	1	41	114.3	71.0	82.6	27.4	K560F-8	2640
K9806M-46	0130993	1	46	120.7	76.8	82.6	30.6	K560F-8	3110
K9806M-50	0131006	1	50	127.0	81.5	82.6	33.1	K560F-8	3480
K9806M-55	0131013	1	55	127.0	87.5	82.6	36.3	K560F-8	3950
K9806M-60	0131020	1	60	133.4	93.3	82.6	39.5	K560F-8	4420
K9806M-65	0131037	1	65	139.7	99.3	82.6	42.7	K560F-8	4890
K9806M-70	0131044	1	70	146.1	105.2	82.6	45.9	K560F-8	5350
K9806M-75	0131051	1	75	152.4	111.1	82.6	49.1	K560F-8	5580
K9806M-80	0131068	1	80	158.8	117.0	82.6	52.3	K560F-8	7240
K9806M-85	0131075	1	85	165.1	122.8	82.6	55.5	K560F-8	7830
K9806M-90	0131082	1	90	171.5	128.8	82.6	58.7	K560F-8	9070
K9806M-95	0131099	1	95	177.8	134.6	82.6	61.9	K560F-8	9980
K9806M-100	0131105	1	100	184.2	140.6	82.6	65.1	K560F-8	10910
K9806M-105	0131112	1	105	190.5	146.4	82.6	68.3	K560F-8	11820
K9806M-110	0131129	1	110	196.9	152.4	82.6	71.5	K560F-8	12740
K9806M-115	0131136	1	115	203.2	158.2	82.6	74.7	K560F-8	13650
K9806M-120	0131143	1	120	209.6	164.2	82.6	77.9	K560F-8	14580



K9806Z

SOCKETS INCH, LONG



- DIN 3129, ISO 2725
- Drive: 1.1/2" DIN 3121-H 40, ISO1174
- Black finish
- Material: High performance alloy steel
- To be used with machines. For maximum safety, use clamping springs
- T = depth of female hexagon
- Manufactured on demand

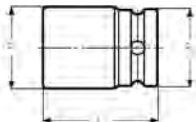

	 731415			L mm	D1 mm	D2 mm	T mm		
K9806Z-1.3/8	0131150	1	1 3/8	104.8	63.8	82.6	23.5	K560F-8	2870
K9806Z-1.7/16	0131167	1	1 7/16	104.8	65.7	82.6	24.5	K560F-8	2820
K9806Z-1.1/2	0131174	1	1 1/2	108.0	67.6	82.6	25.5	K560F-8	2770
K9806Z-1.5/8	0131181	1	1 5/8	111.1	71.2	82.6	27.6	K560F-8	2820
K9806Z-1.11/16	0131198	1	1 11/16	114.3	73.2	82.6	28.6	K560F-8	2900
K9806Z-2	0131204	1	2	123.8	82.6	82.6	33.7	K560F-8	3540
K9806Z-2.1/16	0131211	1	2 1/16	123.8	84.8	82.6	34.7	K560F-8	3530
K9806Z-2.3/16	0131228	1	2 3/16	130.2	88.1	82.6	36.7	K560F-8	3780
K9806Z-2.1/4	0131235	1	2 1/4	130.2	90.0	82.6	37.7	K560F-8	4030
K9806Z-2.5/16	0131242	1	2 5/16	133.4	91.8	82.6	38.7	K560F-8	4120
K9806Z-2.3/8	0131259	1	2 3/8	133.4	93.7	82.6	39.8	K560F-8	4300
K9806Z-2.7/16	0131266	1	2 7/16	136.5	95.6	82.6	40.8	K560F-8	4380
K9806Z-2.1/2	0131273	1	2 1/2	139.7	97.5	82.6	41.8	K560F-8	4590
K9806Z-2.9/16	0131280	1	2 9/16	139.7	99.3	82.6	42.8	K560F-8	4770
K9806Z-2.5/8	0131297	1	2 5/8	142.9	101.2	82.6	43.8	K560F-8	4970
K9806Z-2.11/16	0131303	1	2 11/16	142.9	103.1	82.6	44.8	K560F-8	5170
K9806Z-2.3/4	0131310	1	2 3/4	146.1	105.0	82.6	45.8	K560F-8	5250
K9806Z-2.13/16	0131327	1	2 13/16	149.2	106.8	82.6	46.9	K560F-8	5730
K9806Z-2.7/8	0131334	1	2 7/8	149.2	108.7	82.6	47.9	K560F-8	5820
K9806Z-2.15/16	0131341	1	2 15/16	152.4	110.6	82.6	48.9	K560F-8	5920
K9806Z-3	0131358	1	3	152.4	112.5	82.6	49.9	K560F-8	6300
K9806Z-3.1/16	0131365	1	3 1/16	155.6	114.3	82.6	50.9	K560F-8	6680
K9806Z-3.1/8	0131372	1	3 1/8	158.8	116.2	82.6	51.9	K560F-8	6780
K9806Z-3.3/16	0131389	1	3 3/16	158.8	118.1	82.6	53.0	K560F-8	7190
K9806Z-3.1/4	0131396	1	3 1/4	161.9	120.0	82.6	54.0	K560F-8	7460
K9806Z-3.5/16	0131402	1	3 5/16	161.9	121.8	82.6	55.0	K560F-8	7580
K9806Z-3.3/8	0131419	1	3 3/8	165.1	123.7	82.6	56.0	K560F-8	7860
K9806Z-3.7/16	0131426	1	3 7/16	168.3	125.6	82.6	57.0	K560F-8	8310
K9806Z-3.1/2	0131433	1	3 1/2	168.3	127.5	82.6	58.0	K560F-8	8450
K9806Z-3.9/16	0131440	1	3 9/16	171.5	129.3	82.6	59.1	K560F-8	8740
K9806Z-3.5/8	0131457	1	3 5/8	171.5	131.2	82.6	60.1	K560F-8	9420
K9806Z-3.11/16	0131464	1	3 11/16	174.6	133.1	82.6	61.1	K560F-8	9560
K9806Z-3.3/4	0131471	1	3 3/4	177.8	135.0	82.6	62.1	K560F-8	9710
K9806Z-3.13/16	0131488	1	3 13/16	177.8	136.8	82.6	63.1	K560F-8	10210
K9806Z-3.7/8	0131495	1	3 7/8	181.0	138.7	82.6	64.1	K560F-8	10560
K9806Z-3.15/16	0131501	1	3 15/16	181.0	140.6	82.6	65.2	K560F-8	11130
K9806Z-4	0131518	1	4	184.2	142.5	82.6	66.2	K560F-8	11290
K9806Z-4.1/16	0131525	1	4 1/16	187.3	144.3	82.6	67.2	K560F-8	12080
K9806Z-4.1/8	0131532	1	4 1/8	187.3	146.2	82.6	68.2	K560F-8	12240
K9806Z-4.1/4	0131549	1	4 1/4	190.5	150.0	82.6	70.2	K560F-8	13260
K9806Z-4.5/16	0131556	1	4 5/16	193.7	151.8	82.6	71.2	K560F-8	15120
K9806Z-4.3/8	0131563	1	4 3/8	196.9	153.7	82.6	72.3	K560F-8	14830
K9806Z-4.1/2	0131570	1	4 1/2	200.0	157.5	82.6	74.3	K560F-8	14680
K9806Z-4.5/8	0131587	1	4 5/8	203.2	161.2	82.6	76.3	K560F-8	15360
K9806Z-4.3/4	0131594	1	4 3/4	206.4	165.0	82.6	78.4	K560F-8	15500



K9860H

SOCKETS EXTENSIONS



- DIN 3129, ISO 2725
- Drive: 1.1/2" DIN 3121, ISO1174
- Black finish
- Material: High performance alloy steel
- With through hole
- To be used with machines. For maximum safety, use clamping springs
- D2 = outside diameter of the female end

	 731415				 mm	D2 mm		 g
K9860H-1	0133994	1	1.1/2"	1.1/2"	200	86	K560F-8	4.080
K9860H-2	0134007	1	1.1/2"	1.1/2"	300	86	K560F-8	6.120
K9860H-3	0134014	1	1.1/2"	1.1/2"	400	86	K560F-8	8.160

K9867S

BALL JOINT



- DIN 3129, ISO 2725
- Drive: 1.1/2" DIN 3121, ISO1174
- Black finish
- Material: High performance alloy steel, ideal for impact use
- Maximum angle 35°
- To be used with machines. For maximum safety, use clamping springs
- D2 = outside diameter of the female end

	 731415				 mm	D2 mm		 g
K9867S	0133932	1	1 1/2	1 1/2	154.2	88.9	K560F-8	4050



IMPACT TOOLS 1 1/2"

K9598H/K9998H

ACCESSORIES 1 1/2"



- DIN 3129, ISO 2725
- Drive: 1.1/2" DIN 3121, ISO1174
- Black finish
- Material: High performance alloy steel
- With through hole
- To be used with machines. For maximum safety, use clamping springs
- D2 = outside diameter of the female end
- Warning: The torque to be applied should be limited to the smallest drive

	 731415				 mm	D2 mm		 g
K9598H	0133956	1	1	1 1/2	105	86	K560F-8	2700
K9998H	0133963	1	2 1/2	1 1/2	120.7	82.6	K560F-8	3920
K9899H	0166763	1	1 1/2	2 1/2	162.1	127.0	K560F-9	8290

K560F-9

CLAMPING SPRINGS



- Safety clamping spring
- To be used in impact sockets and accessories
- Material: Spring steel

	 731415			 mm	 g
K560F-9	1846688	5	1 1/2"	95-120	15



63D/PH



BITS FOR PHILLIPS SCREWS, 25 MM

- Drive: 1/4" DIN 3126-C 6,3, ISO 1173
- Finish: Gold coloured diamond coating
- Material: High performance alloy steel
- Application: High performance in any application
- Minimises the cam-out effect reducing "down-time"
- Reduces wear of bit and screw
- Torsion zone that absorbs torque peaks avoiding premature wear and tear and improving service life
- In plastic box of 5 pcs

	 731415			 L mm	 g
63D/PH1	0198917	5	1	25	5
63D/PH2	0198931	5	2	25	5
63D/PH3	0198948	5	3	25	5

63D/PH 2P



BITS FOR PHILLIPS SCREWS, 25 MM

- Drive: 1/4" DIN 3126-C 6,3, ISO 1173
- Finish: Gold coloured diamond coating
- Material: High performance alloy steel
- Application: High performance in any application
- Minimises the cam-out effect reducing "down-time"
- Reduces wear of bit and screw
- Torsion zone that absorbs torque peaks avoiding premature wear and tear and improving service life
- In small blister pack of 2 pcs

	 731415			 L mm	 g
63D/PH1-2P	0201051	1	1	25	18
63D/PH2-2P	0201068	1	2	25	18

63D/PH2G



BITS FOR PHILLIPS DRY WALL SCREWS, 25 MM

- Drive: 1/4" DIN 3126-C 6,3, ISO 1173
- Finish: Gold coloured diamond coating
- Material: High performance alloy steel
- Application: Grabber bits for drywall screws (with reduced nose diameter \varnothing 4.8 mm)
- Minimises the cam-out effect reducing "down-time"
- Reduces wear of bit and screw
- Torsion zone that absorbs torque peaks avoiding premature wear and tear and improving service life
- In plastic box of 5 pcs

	 731415			 L mm	 g
63D/PH2G	0198979	5	PH2G	25	5



DIAMOND TORSION BITS 1/4"

63D/PH2G-2P



BITS FOR PHILLIPS DRY WALL SCREWS, 25 MM

- Drive: 1/4" DIN 3126-C 6,3, ISO 1173
- Finish: Gold coloured diamond coating
- Material: High performance alloy steel
- Application: Grabber bits for drywall screws (with reduced nose diameter Ø 4.8 mm)
- Minimises the cam-out effect reducing "down-time"
- Reduces wear of bit and screw
- Torsion zone that absorbs torque peaks avoiding premature wear and tear and improving service life
- In small blister pack of 2 pcs

63D/PH2G-2P	731415	1	PH2G	25	5

63D/50PH



BITS FOR PHILLIPS SCREWS, 50 MM

- Drive: 1/4" DIN 3126-E6,3, ISO 1173
- Finish: Gold coloured diamond coating
- Material: High performance alloy steel
- Application: High performance in any application
- Minimises the cam-out effect reducing "down-time"
- Reduces wear of bit and screw
- Torsion zone that absorbs torque peaks avoiding premature wear and tear and improving service life
- In plastic box of 5 pcs

63D/50PH1	0200351	5	1	50	10
63D/50PH2	0200368	5	2	50	10
63D/50PH3	0200375	5	3	50	10

63D/PZ



BITS FOR POZIDRIV SCREWS, 25 MM

- Drive: 1/4" DIN 3126-C 6,3, ISO 1173
- Finish: Gold coloured diamond coating
- Material: High performance alloy steel
- Application: High performance in any application
- Minimises the cam-out effect reducing "down-time"
- Reduces wear of bit and screw
- Torsion zone that absorbs torque peaks avoiding premature wear and tear and improving service life
- In plastic box of 5 pcs

63D/PZ1	0198856	5	1	25	5
63D/PZ2	0198870	5	2	25	5
63D/PZ3	0198894	5	3	25	5









63D/PZ 2P

BITS FOR POZIDRIV SCREWS, 25 MM



- Drive: 1/4" DIN 3126-C 6,3, ISO 1173
- Finish: Gold coloured diamond coating
- Material: High performance alloy steel
- Application: High performance in any application
- Minimises the cam-out effect reducing "down-time"
- Reduces wear of bit and screw
- Torsion zone that absorbs torque peaks avoiding premature wear and tear and improving service life
- In small blister pack of 2 pcs



	 731415			 L mm	 g
63D/PZ1-2P	0201037	1	1	25	18
63D/PZ2-2P	0201044	1	2	25	18







63D/50PZ

BITS FOR POZIDRIV SCREWS, 50 MM



- Drive: 1/4" DIN 3126-E 6,3, ISO 1173
- Finish: Gold coloured diamond coating
- Material: High performance alloy steel
- Application: High performance in any application
- Minimises the cam-out effect reducing "down-time"
- Reduces wear of bit and screw
- Torsion zone that absorbs torque peaks avoiding premature wear and tear and improving service life
- In plastic box of 5 pcs



	 731415			 L mm	 g
63D/50PZ1	0200320	5	1	50	10
63D/50PZ2	0200337	5	2	50	10
63D/50PZ3	0200344	5	3	50	10



DIAMOND TORSION BITS 1/4"

63D/T

BITS FOR TORX® SCREWS, 25 MM



- Drive: 1/4" DIN 3126-C 6,3, ISO 1173
- Finish: Gold coloured diamond coating
- Material: High performance alloy steel
- Application: High performance in any application
- Minimises the cam-out effect reducing "down-time"
- Reduces wear of bit and screw
- Torsion zone that absorbs torque peaks avoiding premature wear and tear and improving service life
- In plastic box of 5 pcs

	 731415			 D mm	 L mm	 g	
	63D/T10	0198665	5	T10	2.74	25	5
	63D/T15	0198733	5	T15	3.27	25	5
	63D/T20	0198764	5	T20	3.86	25	5
	63D/T25	0198818	5	T25	4.43	25	5
	63D/T30	0198788	5	T30	5.52	25	6
	63D/T40	0198832	5	T40	6.65	25	7

63D/T 2P

BITS FOR TORX® SCREWS, 25 MM



- Drive: 1/4" DIN 3126-C 6,3, ISO 1173
- Finish: Gold coloured diamond coating
- Material: High performance alloy steel
- Application: High performance in any application
- Minimises the cam-out effect reducing "down-time"
- Reduces wear of bit and screw
- Torsion zone that absorbs torque peaks avoiding premature wear and tear and improving service life
- In small blister pack of 2 pcs

	 731415			 D mm	 L mm	 g	
	63D/T15-2P	0201006	1	T15	3.27	25	18
	63D/T20-2P	0201013	1	T20	3.86	25	18
	63D/T25-2P	0201020	1	T25	4.43	25	18



62TIN/PH

BITS FOR PHILLIPS SCREWS, 25 MM



- Drive: 1/4" DIN 3126-C6.3, ISO 1173
- Finish: Titanium nitride
- Material: High performance alloy steel
- Application: TIN bits are extremely wear resistant when used for high volume production and continuous use
- Torsion zone absorbs torque peaks avoiding premature wear and tear and improving service life
- In plastic box of 10 pcs

	 731415			 L mm	 g
62TIN/PH1	0199259	10	1	25	5
62TIN/PH2	0199297	10	2	25	5
62TIN/PH3	0199303	10	3	25	5

62TIN/50PH

BITS FOR PHILLIPS SCREWS, 50 MM



- Drive: 1/4" DIN 3126-E6.3, ISO 1173
- Finish: Titanium nitride
- Material: High performance alloy steel
- Application: TIN bits are extremely wear resistant when used for high volume production and continuous use
- Torsion zone absorbs torque peaks avoiding premature wear and tear and improving service life
- In plastic box of 5 pcs

	 731415			 L mm	 g
62TIN/50PH1	0200504	5	1	50	10
62TIN/50PH2	0200511	5	2	50	10
62TIN/50PH3	0200528	5	3	50	10

62TIN/PZ

BITS FOR POZIDRIV SCREWS, 25 MM



- Drive: 1/4" DIN 3126-C6.3, ISO 1173
- Finish: Titanium nitride
- Material: High performance alloy steel
- Application: TIN bits are extremely wear resistant when used for high volume production and continuous use
- Torsion zone absorbs torque peaks avoiding premature wear and tear and improving service life
- In plastic box of 10 pcs

	 731415			 L mm	 g
62TIN/PZ1	0199327	10	1	25	5
62TIN/PZ2	0199334	10	2	25	5
62TIN/PZ3	0199358	10	3	25	5



TIN TORSION BITS 1/4"

62TIN/PZ 2P



BITS FOR POZIDRIV SCREWS, 25 MM

- Drive: 1/4" DIN 3126-C6.3, ISO 1173
- Finish: Titanium nitride
- Material: High performance alloy steel
- Application: TIN bits are extremely wear resistant when used for high volume production and continuous use
- Torsion zone absorbs torque peaks avoiding premature wear and tear and improving service life
- In small blister pack of 2 pcs

	 731415			 L mm	 g
62TIN/PZ1-2P	0201105	1	1	25	18
62TIN/PZ2-2P	0201112	1	2	25	18
62TIN/PZ3-2P	0201129	1	3	25	18

62TIN/50PZ



BITS FOR POZIDRIV SCREWS, 50 MM

- Drive: 1/4" DIN 3126-E6.3, ISO 1173
- Finish: Titanium nitride
- Material: High performance alloy steel
- Application: TIN bits are extremely wear resistant when used for high volume production and continuous use
- Torsion zone absorbs torque peaks avoiding premature wear and tear and improving service life
- In plastic box of 5 pcs

	 731415			 L mm	 g
62TIN/50PZ1	0200535	5	1	50	10
62TIN/50PZ2	0200542	5	2	50	10
62TIN/50PZ3	0200559	5	3	50	10

62TIN/T



BITS FOR TORX® SCREWS, 25 MM

- Drive: 1/4" DIN 3126-C6.3, ISO 1173
- Finish: Titanium nitride
- Material: High performance alloy steel
- Application: TIN bits are extremely wear resistant when used for high volume production and continuous use at normal torque levels
- Torsion zone absorbs torque peaks avoiding premature wear and tear and improving service life
- In plastic box of 10 pcs

	 731415			 D mm	 L mm	 g
62TIN/T10	0199372	10	T10	2.74	25	5
62TIN/T15	0199402	10	T15	3.27	25	5
62TIN/T20	0199426	10	T20	3.86	25	5
62TIN/T25	0199440	10	T25	4.43	25	5
62TIN/T30	0199464	10	T30	5.52	25	6
62TIN/T40	0199471	10	T40	6.65	25	7



60T/PH



BITS FOR PHILLIPS SCREWS, 25 MM

- Drive: 1/4" DIN 3126-C6.3, ISO 1173
- Finish: Steel grey surface coated with clear lacquer for rust protection
- Material: High performance alloy steel
- Application: Torsion bits are suitable for hard material applications
- Torsion zone that absorbs torque peaks avoiding premature wear and tear and improving service life
- In plastic box of 10 pcs

	 731415			 L mm	 9
60T/PH1	0199488	10	1	25	5
60T/PH2	0199495	10	2	25	5
60T/PH3	0199501	10	3	25	5

60T/PH 2P



BITS FOR PHILLIPS SCREWS, 25 MM

- Drive: 1/4" DIN 3126-C6.3, ISO 1173
- Finish: Steel grey surface coated with clear lacquer for rust protection
- Material: High performance alloy steel
- Application: Torsion bits are suitable for hard material applications
- Torsion zone that absorbs torque peaks avoiding premature wear and tear and improving service life
- In small blister pack of 2 pcs

	 731415			 L mm	 9
60T/PH1-2P	0201136	1	1	25	18
60T/PH2-2P	0201143	1	2	25	18
60T/PH3-2P	0201150	1	3	25	18

60T/PZ



BITS FOR POZIDRIV SCREWS, 25 MM

- Drive: 1/4" DIN 3126-C6.3, ISO 1173
- Finish: Steel grey surface coated with clear lacquer for rust protection
- Material: High performance alloy steel
- Application: Torsion bits are suitable for hard material applications
- Torsion zone that absorbs torque peaks avoiding premature wear and tear and improving service life
- In plastic box of 10 pcs

	 731415			 L mm	 9
60T/PZ1	0199525	10	1	25	5
60T/PZ2	0199549	10	2	25	5
60T/PZ3	0199563	10	3	25	5



TORSION BITS 1/4"

60T/PZ 2P

BITS FOR POZIDRIV SCREWS, 25 MM



- Drive: 1/4" DIN 3126-C6.3, ISO 1173
- Finish: Steel grey surface coated with clear lacquer for rust protection
- Material: High performance alloy steel, ideal for bits
- Application: Torsion bits are suitable for hard material applications
- Torsion zone that absorbs torque peaks avoiding premature wear and tear and improving service life
- In small blister pack of 2 pcs

	 731415				
60T/PZ1-2P	0201167	1	1	25	18
60T/PZ2-2P	0201174	1	2	25	18
60T/PZ3-2P	0201181	1	3	25	18

60T/T

BITS FOR TORX® SCREWS, 25 MM



- Drive: 1/4" DIN 3126-C6.3, ISO 1173
- Finish: Steel grey surface coated with clear lacquer for rust protection
- Material: High performance alloy steel
- Application: Torsion bits are suitable for hard material applications
- Torsion zone that absorbs torque peaks avoiding premature wear and tear and improving service life
- In plastic box of 10 pcs

	 731415					
60T/T7	0199587	10	T7	1.99	25	5
60T/T8	0199600	10	T8	2.31	25	5
60T/T9	0199624	10	T9	2.50	25	5
60T/T10	0199648	10	T10	2.74	25	5
60T/T15	0199662	10	T25	3.27	25	5
60T/T20	0199686	10	T20	3.86	25	5
60T/T25	0199709	10	T25	4.43	25	5
60T/T27	0199723	10	T27	4.43	25	5
60T/T30	0199747	10	T30	5.52	25	6
60T/T40	0199761	10	T40	6.65	25	7



60T/T 2P

BITS FOR TORX® SCREWS, 25 MM



- Drive: 1/4" DIN 3126-C6.3, ISO 1173
- Finish: Steel grey surface coated with clear lacquer for rust protection
- Material: High performance alloy steel
- Application: Torsion bits are suitable for hard material applications
- Torsion zone that absorbs torque peaks avoiding premature wear and tear and improving service life
- In small blister pack of 2 pcs

	 731415			 mm	 mm	 g
60T/T10-2P	0201198	1	T10	2.74	25	18
60T/T15-2P	0201204	1	T15	3.27	25	18
60T/T20-2P	0201211	1	T20	3.86	25	18
60T/T25-2P	0201228	1	T25	4.43	25	18
60T/T30-2P	0201235	1	T30	5.52	25	20
60T/T40-2P	0201242	1	T40	6.65	25	22

EXTRA HARD TORSION BITS 1/4"



61H/PH

BITS FOR PHILLIPS SCREWS, 25 MM



- Drive: 1/4" DIN 3126-C6.3, ISO 1173
- Finish: Surface coated with yellow lack for rust protection
- Material: High performance alloy steel, ideal for bits
- Application: Extra hard bits are suitable for wood and soft material applications
- Torsion zone that absorbs torque peaks avoiding premature wear and tear and improving service life
- In plastic box of 10 pcs (PH3 = 5 pcs)

	 731415			 mm	 g
61H/PH1	0199006	10	1	25	5
61H/PH2	0199020	10	2	25	5
61H/PH3	0199044	5	3	25	5



EXTRA HARD TORSION BITS 1/4"

61H/PH 2P



BITS FOR PHILLIPS SCREWS, 25 MM

- Drive: 1/4" DIN 3126-C6.3, ISO 1173
- Finish: Surface coated with yellow lacquer for rust protection
- Material: High performance alloy steel, ideal for bits
- Application: Extra hard bits are suitable for wood and soft material applications
- Torsion zone that absorbs torque peaks avoiding premature wear and tear and improving service life
- In small blister pack of 2 pcs

	 731415			 L mm	 g
61H/PH2-2P	0201082	1	2	25	18

61H/50PH



BITS FOR PHILLIPS SCREWS, 50 MM

- Drive: 1/4" DIN 3126-E6.3, ISO 1173
- Finish: Surface coated with yellow lacquer for rust protection
- Material: High performance alloy steel, ideal for bits
- Application: Extra hard bits are suitable for wood and soft material applications
- Torsion zone that absorbs torque peaks avoiding premature wear and tear and improving service life
- In plastic box of 5 pcs

	 731415			 L mm	 g
61H/50PH1	0200382	5	1	50	10
61H/50PH2	0200399	5	2	50	10
61H/50PH3	0200405	5	3	50	10

61H/PZ



BITS FOR POZIDRIV SCREWS, 25 MM

- Drive: 1/4" DIN 3126-C6.3, ISO 1173
- Finish: Surface coated with yellow lacquer for rust protection
- Material: High performance alloy steel, ideal for bits
- Application: Extra hard bits are suitable for wood and soft material applications
- Torsion zone that absorbs torque peaks avoiding premature wear and tear and improving service life
- In plastic box of 10 pcs (PZ3 = 5 pcs)

	 731415			 L mm	 g
61H/PZ1	0199068	10	1	25	5
61H/PZ2	0199082	10	2	25	5
61H/PZ3	0199105	5	3	25	5



61H/PZ 2P



BITS FOR POZIDRIV SCREWS, 25 MM

- Drive: 1/4" DIN 3126-C6.3, ISO 1173
- Finish: Surface coated with yellow lacquer for rust protection
- Material: High performance alloy steel, ideal for bits
- Application: Extra hard bits are suitable for wood and soft material applications
- Torsion zone that absorbs torque peaks avoiding premature wear and tear and improving service life
- In small blister pack of 2 pcs

	 731415			 L mm	 g
61H/PZ2-2P	0201099	1	2	25	18

61H/50PZ



BITS FOR POZIDRIV SCREWS, 50 MM

- Drive: 1/4" DIN 3126-E6.3, ISO 1173
- Finish: Surface coated with yellow lacquer for rust protection
- Material: High performance alloy steel, ideal for bits
- Application: Extra hard bits are suitable for wood and soft material applications
- Torsion zone that absorbs torque peaks avoiding premature wear and tear and improving service life
- In plastic box of 5 pcs

	 731415			 L mm	 g
61H/50PZ1	0200412	5	1	50	10
61H/50PZ2	0200429	5	2	50	10
61H/50PZ3	0200436	5	3	50	10

61H/T



BITS FOR TORX® SCREWS, 25 MM

- Drive: 1/4" DIN 3126-C6.3, ISO 1173
- Finish: Surface coated with yellow lacquer for rust protection
- Material: High performance alloy steel, ideal for bits
- Application: Extra hard bits are suitable for wood and soft material applications
- Torsion zone that absorbs torque peaks avoiding premature wear and tear and improving service life
- In plastic box of 10 pcs (T40 = 5 pcs)

	 731415			 D mm	 L mm	 g
61H/T10	0199129	10	T10	2.74	25	5
61H/T15	0199143	10	T15	3.27	25	5
61H/T20	0199167	10	T20	3.86	25	5
61H/T25	0199181	10	T25	4.43	25	5
61H/T30	0199211	10	T30	5.52	25	6
61H/T40	0199235	5	T40	6.65	25	7



EXTRA HARD TORSION BITS 1/4"

61H/50T

BITS FOR TORX® SCREWS, 50 MM



- Drive: 1/4" DIN 3126-E6.3, ISO 1173
- Finish: Surface coated with yellow lacquer for rust protection
- Material: High performance alloy steel, ideal for bits
- Application: Extra hard bits are suitable for wood and soft material applications
- Torsion zone that absorbs torque peaks avoiding premature wear and tear and improving service life
- In plastic box of 5 pcs

	 731415			 D mm	 L mm	 g
61H/50T10	0200443	5	T10	2.74	50	10
61H/50T15	0200450	5	T15	3.27	50	10
61H/50T20	0200467	5	T20	3.86	50	10
61H/50T25	0200474	5	T25	4.43	50	10
61H/50T30	0200481	5	T30	5.52	50	12
61H/50T40	0200498	5	T40	6.65	50	14



ACR TORSION BITS 1/4"

64A/PH

BITS FOR PHILLIPS SCREWS, 25 MM



- Drive: 1/4" DIN 3126-C6.3, ISO 1173
- Finish: Surface coated with clear lacquer for rust protection
- Material: High performance alloy steel, ideal for bits
- Application: Recommended for tasks requiring reduction of the "cam-out" effect, avoiding the erosion of the bit-screws
- In plastic box of 10 pcs

	 731415			 L mm	 g
64A/PH1	0198481	10	1	25	5
64A/PH2	0198559	10	2	25	5
64A/PH3	0198573	10	3	25	5



64A/PH 2P

BITS FOR PHILLIPS SCREWS, 25 MM



- Drive: 1/4" DIN 3126-C6.3, ISO 1173
- Finish: Surface coated with clear lacquer for rust protection
- Material: High performance alloy steel, ideal for bits
- Application: Recommended for tasks requiring reduction of the "cam-out" effect, avoiding the erosion of the bit-screws
- In small blister pack of 2 pcs

	 731415			 L mm	 g
64A/PH1-2P	0200948	1	1	25	18
64A/PH2-2P	0200955	1	2	25	18
64A/PH3-2P	0200962	1	3	25	18

64A/PZ

BITS FOR POZIDRIV SCREWS, 25 MM



- Drive: 1/4" DIN 3126-C6.3, ISO 1173
- Finish: Surface coated with clear lacquer for rust protection
- Material: High performance alloy steel, ideal for bits
- Application: Recommended for tasks requiring reduction of the "cam-out" effect, avoiding the erosion of the bit-screws
- In plastic box of 10 pcs

	 731415			 L mm	 g
64A/PZ1	0198603	10	1	25	5
64A/PZ2	0198627	10	2	25	5
64A/PZ3	0198634	10	3	25	5

64A/PZ 2P

BITS FOR POZIDRIV SCREWS, 25 MM



- Drive: 1/4" DIN 3126-C6.3, ISO 1173
- Finish: Surface coated with clear lacquer for rust protection
- Material: High performance alloy steel, ideal for bits
- Application: Recommended for tasks requiring reduction of the "cam-out" effect, avoiding the erosion of the bit-screws
- In small blister pack of 2 pcs

	 731415			 L mm	 g
64A/PZ1-2P	0200979	1	1	25	18
64A/PZ2-2P	0200986	2	2	25	18
64A/PZ3-2P	0200993	1	3	25	18



STAINLESS STEEL TORSION BITS 1/4"

65I/PH

BITS FOR PHILLIPS SCREWS, 25 MM



- Drive: 1/4" DIN 3126-C6.3, ISO 1173
- Finish: Surface-passivated
- Material: High performance stainless steel, ideal for bits
- Application: Ideal for use on stainless steel screws. Stainless steel bits prevent the formation of rust on stainless steel surfaces
- Torsion zone that absorbs torque peaks avoiding premature wear and tear and improving service life
- In plastic box of 10 pcs

	 731415				
65I/PH1	0199785	10	1	25	5
65I/PH2	0199884	10	2	25	5
65I/PH3	0199907	10	3	25	5

65I/PH 2P

BITS FOR PHILLIPS SCREWS, 25 MM



- Drive: 1/4" DIN 3126-C6.3, ISO 1173
- Finish: Surface-passivated
- Material: High performance stainless steel, ideal for bits
- Application: Ideal for use on stainless steel screws. Stainless steel bits prevent the formation of rust on stainless steel surfaces
- Torsion zone that absorbs torque peaks avoiding premature wear and tear and improving service life
- In small blister pack of 2 pcs

	 731415				
65I/PH1-2P	0207985	1	1	25	18
65I/PH2-2P	0201259	1	2	25	18
65I/PH3-2P	0201266	1	3	25	18



65I/PZ

BITS FOR POZIDRIV SCREWS, 25 MM



- Drive: 1/4" DIN 3126-C6.3, ISO 1173
- Finish: Surface-passivated
- Material: High performance stainless steel, ideal for bits
- Application: Ideal for use on stainless steel screws. Stainless steel bits prevent the formation of rust on stainless steel surfaces
- Torsion zone that absorbs torque peaks avoiding premature wear and tear and improving service life
- In plastic box of 10 pcs

	 731415			 L mm	 g
65I/PZ1	0199921	10	1	25	5
65I/PZ2	0199945	10	2	25	5
65I/PZ3	0199969	10	3	25	3

65I/PZ 2P

BITS FOR POZIDRIV SCREWS, 25 MM



- Drive: 1/4" DIN 3126-C6.3, ISO 1173
- Finish: Surface-passivated
- Material: High performance stainless steel,
- Application: Ideal for use on stainless steel screws. Stainless steel bits prevent the formation of rust on stainless steel surfaces
- Torsion zone that absorbs torque peaks avoiding premature wear and tear and improving service life
- In small blister pack of 2 pcs

	 731415			 L mm	 g
65I/PZ1-2P	0201273	1	1	25	18
65I/PZ2-2P	0201280	1	2	25	18
65I/PZ3-2P	0201297	1	3	25	18



STAINLESS STEEL TORSION BITS 1/4"

65I/T

BITS FOR TORX® SCREWS, 25 MM



- Drive: 1/4" DIN 3126-C6.3, ISO 1173
- Finish: Surface-passivated
- Material: High performance stainless steel
- Application: Ideal for use on stainless steel screws
- Stainless steel bits prevent the formation of rust on stainless steel surfaces
- Torsion zone that absorbs torque peaks avoiding premature wear and tear and improving service life
- In plastic box of 5 pcs

	 731415			 D mm	 L mm	 g
65I/T10	0199983	5	T10	2.74	25	5
65I/T15	0199990	5	T15	3.27	25	5
65I/T20	0200016	5	T20	3.86	25	5
65I/T25	0200030	5	T25	4.43	25	5
65I/T30	0200054	5	T30	5.52	25	6
65I/T40	0200078	5	T40	6.65	25	7

65I/T 2P

BITS FOR TORX® SCREWS, 25 MM



- Drive: 1/4" DIN 3126-C6.3, ISO 1173
- Finish: Surface-passivated
- Material: High performance stainless steel
- Application: Ideal for use on stainless steel screws. Stainless steel bits prevent the formation of rust on stainless steel surfaces
- Torsion zone that absorbs torque peaks avoiding premature wear and tear and improving service life
- In small blister pack of 2 pcs

	 731415			 D mm	 L mm	 g
65I/T10-2P	0201303	1	T10	2.74	25	18
65I/T15-2P	0201310	1	T15	3.27	25	18
65I/T20-2P	0201327	1	T20	3.86	25	18
65I/T25-2P	0201334	1	T25	4.43	25	18
65I/T30-2P	0201341	1	T30	5.52	25	20
65I/T40-2P	0201358	1	T40	6.65	25	22



59S/

BITS FOR SLOTTED SCREWS, 25 MM



- Drive: 1/4" DIN 3126-C 6,3, ISO 1173
- Finish: Zinc phosphated
- Material: High performance alloy steel
- Application: For all screw applications in trade and industry
- In plastic box of 10 pcs

	 731415		 mm	 mm	 L mm	 g
59S/0.5-3.0	0199815	10	0.5	3.0	25	5
59S/0.5-4.0	0199822	10	0.5	4.0	25	5
59S/0.5-6.5	0198825	10	0.5	6.5	25	5
59S/0.6-3.5	0199839	10	0.6	3.5	25	5
59S/0.6-4.5	0198801	10	0.6	4.5	25	5
59S/0.8-5.5	0198849	10	0.8	5.5	25	5
59S/1.0-5.5	0198863	10	1.0	5.5	25	6
59S/1.2-6.5	0198887	10	1.2	6.5	25	6
59S/1.2-8.0	0198900	10	1.2	8.0	25	6
59S/1.6-10	0199846	10	1.6	10	25	14
59S/1.6-9.0	0199853	10	1.6	9.0	25	14

59S/ 3P

BITS FOR SLOTTED SCREWS, 25 MM



- Drive: 1/4" DIN 3126-C 6,3, ISO 1173
- Finish: Zinc phosphated
- Material: High performance alloy steel
- Application: For all screw applications in trade and industry
- In small blister pack of 3 pcs

	 731415		 mm	 mm	 L mm	 g
59S/0.5-6.5-3P	0201617	1	0.5	6.5	25	20
59S/0.6-4.5-3P	0201600	1	0.6	4.5	25	20
59S/0.8-5.5-3P	0201624	1	0.8	5.5	25	20



STANDARD BITS 1/4"

59S/50

BITS FOR SLOTTED SCREWS, 50 MM



- Drive: 1/4" DIN 3126-E 6,3, ISO 1173
- Finish: Zinc phosphated
- Material: High performance alloy steel
- Application: For all screw applications in trade and industry
- In plastic box of 5 pcs

	 731415		 mm	 mm	 L mm	 g
59S/50/0.6-3.5	0199976	5	0.6	3.5	50	6
59S/50/0.8-4.0	0200009	5	0.8	4.0	50	6
59S/50/0.8-5.5	0200023	5	0.8	5.5	50	9
59S/50/1.0-6.0	0200047	5	1.0	6.0	50	10
59S/50/1.2-6.5	0200061	5	1.2	6.5	50	11

59S/PH

BITS FOR PHILLIPS SCREWS, 25 MM



- Drive: 1/4" DIN 3126-C 6,3, ISO 1173
- Finish: Zinc phosphated
- Material: High performance alloy steel
- Application: For all screw applications in trade and industry
- In plastic box of 10 pcs
- *Available in industrial pack: 100 pcs (-IP), 500 pcs (-IPB)

	 731415			 L mm	 g
59S/PH0	0198177	10	0	25	5
59S/PH1	0198313	10	1	25	5
59S/PH1-IP	0206780	100	*1	25	5
59S/PH2	0198320	10	2	25	5
59S/PH2-IP	0206797	100	*2	25	5
59S/PH2-IPB	0204038	500	*2	25	5
59S/PH3	0198351	10	3	25	5
59S/PH4	0198368	10	4	32	8

59S/PH 3P

BITS FOR PHILLIPS SCREWS, 25 MM



- Drive: 1/4" DIN 3126-C 6,3, ISO 1173
- Finish: Zinc phosphated
- Material: High performance alloy steel
- Application: For all screw applications in trade and industry
- In small blister pack of 3 pcs

	 731415			 L mm	 g
59S/PH1-3P	0201396	1	1	25	20
59S/PH2-3P	0201402	1	2	25	20
59S/PH3-3P	0201419	1	3	25	20



59S/PH 30P



BITS FOR PHILLIPS SCREWS, 25 MM

- Drive: 1/4" DIN 3126-C 6,3, ISO 1173
- Finish: Zinc phosphated
- Material: High performance alloy steel
- Application: For all screws applications in trade and industry
- 30 pcs boxed

	 731415			 L mm	 g
59S/PH1-30P	0200801	1	1	25	180
59S/PH2-30P	0200818	1	2	25	180
59S/PH3-30P	0200825	1	3	25	180

59S/50PH



BITS FOR PHILLIPS SCREWS, 50 MM

- Drive: 1/4" DIN 3126-E 6,3, ISO 1173
- Finish: Zinc phosphated
- Material: High performance alloy steel
- Application: For all screws applications in trade and industry
- In plastic box of 5 pcs

	 731415			 L mm	 g
59S/50PH1	0199860	5	1	50	8
59S/50PH2	0199877	5	2	50	9
59S/50PH3	0199891	5	3	50	10

59S/50PH 2P



BITS FOR PHILLIPS SCREWS, 50 MM

- Drive: 1/4" DIN 3126-E 6,3, ISO 1173
- Finish: Zinc phosphated
- Material: High performance alloy steel
- Application: For all screws applications in trade and industry
- In small blister pack of 2 pcs

	 731415			 L mm	 g
59S/50PH1-2P	0203642	1	1	50	15
59S/50PH2-2P	0203758	1	2	50	15
59S/50PH3-2P	0203802	1	3	50	15



STANDARD BITS 1/4"

59S/70PH

BITS FOR PHILLIPS SCREWS, 70 MM



- Drive: 1/4" DIN 3126-E 6,3, ISO 1173
- Finish: Zinc phosphated
- Material: High performance alloy steel
- Application: For all screw applications in trade and industry

	 731415				
59S/70PH1	0200269	5	1	70	8
59S/70PH2	0200276	5	2	70	9

59S/125PH

BITS FOR PHILLIPS SCREWS, 125 MM



- Drive: 1/4" DIN 3126-E 6,3, ISO 1173
- Finish: Zinc phosphated
- Material: High performance alloy steel
- Application: For all screw applications in trade and industry

	 731415				
59S/125PH1	0206834	5	1	125	20
59S/125PH2	0204298	5	2	125	23
59S/125PH3	0204304	5	3	125	25

59S/PH2G

BITS FOR PHILLIPS DRY WALL SCREWS, 25 MM



- Drive: 1/4" DIN 3126-C 6,3, ISO 1173
- Finish: Zinc phosphated
- Material: High performance alloy steel
- Application: Grabber bits for drywall screws
- With reduced nose diameter \varnothing 4.8 mm
- In a plastic box of 10 pcs

	 731415				
59S/PH2G	0204182	10	PH 2G	25	5



59S/PH2G-30P



BITS FOR PHILLIPS DRY WALL SCREWS, 25 MM

- Drive: 1/4" DIN 3126-C 6,3, ISO 1173
- Finish: Zinc phosphated
- Material: High performance alloy steel
- Application: Grabber bits for drywall screws
- With reduced nose diameter \varnothing 4.8 mm
- 30 pcs boxed

59S/PH2G-30P	731415 0200832	1	PH2G	25 mm	5 g

59S/PZ



BITS FOR POZIDRIV SCREWS, 25 MM

- Drive: 1/4" DIN 3126-C 6,3, ISO 1173
- Finish: Zinc phosphated
- Material: High performance alloy steel
- Application: For all screw applications in trade and industry
- In plastic box of 10 pcs
- *Available in industrial pack: 100 pcs (-IP), 500 pcs (-IPB)

59S/PZ0	731415 0198375	10	0	25 mm	5 g
59S/PZ1	0198382	10	1	25	5
59S/PZ1-IP	0206803	100	*1	25	500
59S/PZ1-IPB	0204373	500	*1	25	2500
59S/PZ2	0198405	10	2	25	5
59S/PZ2-IP	0206810	100	*2	25	500
59S/PZ2-IPB	0204380	500	*2	25	2500
59S/PZ3	0198429	10	3	25	5
59S/PZ4	0198436	10	4	32	8

59S/PZ 3P



BITS FOR POZIDRIV SCREWS, 25 MM

- Drive: 1/4" DIN 3126-C 6,3, ISO 1173
- Finish: Zinc phosphated
- Material: High performance alloy steel
- Application: For all screw applications in trade and industry
- In small blister pack of 3 pcs

59S/PZ1-3P	731415 0201426	1	1	25 mm	20 g
59S/PZ2-3P	0201433	1	2	25	20
59S/PZ3-3P	0201440	1	3	25	20



STANDARD BITS 1/4"

59S/PZ 30P



BITS FOR POZIDRIV SCREWS, 25 MM

- Drive: 1/4" DIN 3126-C 6,3, ISO 1173
- Finish: Zinc phosphated
- Material: High performance alloy steel
- Application: For all screw applications in trade and industry
- 30 pcs boxed

	 731415				
59S/PZ1-30P	0200849	1	1	25	180
59S/PZ2-30P	0200856	1	2	25	180
59S/PZ3-30P	0200863	1	3	25	180

59S/50PZ



BITS FOR POZIDRIV SCREWS, 50 MM

- Drive: 1/4" DIN 3126-E 6,3, ISO 1173
- Finish: Zinc phosphated
- Material: High performance alloy steel
- Application: For all screw applications in trade and industry
- In plastic box of 5 pcs

	 731415				
59S/50PZ1	0199914	5	1	50	10
59S/50PZ2	0199938	5	2	50	10
59S/50PZ3	0199952	5	3	50	10

59S/50PZ 2P



BITS FOR POZIDRIV SCREWS, 50 MM

- Drive: 1/4" DIN 3126-E 6,3, ISO 1173
- Finish: Zinc phosphated
- Material: High performance alloy steel
- Application: For all screw applications in trade and industry
- In small blister pack of 2 pcs

	 731415				
59S/50PZ1-2P	0204007	1	1	50	15
59S/50PZ2-2P	0204014	1	2	50	15
59S/50PZ3-2P	0204021	1	3	50	15



59S/70PZ

BITS FOR POZIDRIV SCREWS, 70 MM



- Drive: 1/4" DIN 3126-E 6,3, ISO 1173
- Finish: Zinc phosphated
- Material: High performance alloy steel
- Application: For all screw applications in trade and industry

	 731415			 L mm	 g
59S/70PZ1	0200283	5	1	70	8
59S/70PZ2	0200290	5	2	70	9
59S/70PZ3	0200306	5	3	70	10

59S/125PZ

BITS FOR POZIDRIV SCREWS, 125 MM



- Drive: 1/4" DIN 3126-E 6,3, ISO 1173
- Finish: Zinc phosphated
- Material: High performance alloy steel
- Application: For all screws applications in trade and industry

	 731415			 L mm	 g
59S/125PZ1	0200733	5	1	125	21
59S/125PZ2	0200740	5	2	125	23
59S/125PZ3	0200757	5	3	125	25

59S/T

BITS FOR TORX® SCREWS, 25 MM



- Drive: 1/4" DIN 3126-C 6,3, ISO 1173
- Finish: Zinc phosphated
- Material: High performance alloy steel
- Application: For all screws applications in trade and industry
- In plastic box of 5 or 10 pcs

	 731415			 D mm	 L mm	 g
59S/T3	0198443	5	T3	1.10	25	4
59S/T4	0198450	5	T4	1.30	25	4
59S/T5	0198467	5	T5	1.43	25	4
59S/T6	0198474	10	T6	1.70	25	4
59S/T7	0198498	10	T7	1.99	25	5
59S/T8	0198504	10	T8	2.31	25	5
59S/T9	0198511	10	T9	2.50	25	5
59S/T10	0198528	10	T10	2.74	25	5
59S/T15	0198535	10	T15	3.27	25	5
59S/T20	0198542	10	T20	3.86	25	5
59S/T25	0198566	10	T25	4.43	25	5
59S/T27	0198580	10	T27	4.99	25	5
59S/T30	0198597	5	T30	5.52	25	6
59S/T40	0198610	5	T40	6.65	25	7
59S/T45	0198641	5	T45	7.82	25	8
59S/T50	0198658	5	T50	8.83	25	8



STANDARD BITS 1/4"

59S/T 3P

BITS FOR TORX® SCREWS, 25 MM



- Drive: 1/4" DIN 3126-C 6,3, ISO 1173
- Finish: Zinc phosphated
- Material: High performance alloy steel
- Application: For all screw applications in trade and industry
- In small blister pack of 3 pcs



	 731415			 D mm	 L mm	 g
59S/T10-3P	0201457	1	T10	2.74	25	20
59S/T15-3P	0201464	1	T15	3.27	25	20
59S/T20-3P	0201471	1	T20	3.86	25	20
59S/T25-3P	0201488	1	T25	4.43	25	20
59S/T27-3P	0201495	1	T27	4.99	25	20
59S/T30-3P	0201501	1	T30	5.52	25	20
59S/T40-3P	0201518	1	T40	6.65	25	20

59S/T 30P

BITS FOR TORX® SCREWS, 25 MM



- Drive: 1/4" DIN 3126-C 6,3, ISO 1173
- Finish: Zinc phosphated
- Material: High performance alloy steel
- Application: For all screw applications in trade and industry
- 30 pcs boxed



	 731415			 D mm	 L mm	 g
59S/T10-30P	0200870	1	T10	2.74	25	180
59S/T15-30P	0200887	1	T15	3.27	25	180
59S/T20-30P	0200894	1	T20	3.86	25	180
59S/T25-30P	0200900	1	T25	4.43	25	180
59S/T30-30P	0200924	1	T30	5.52	25	180
59S/T40-30P	0200931	1	T40	6.65	25	180



59S/50T

BITS FOR TORX® SCREWS, 50 MM



- Drive: 1/4" DIN 3126-E 6,3, ISO 1173
- Finish: Zinc phosphated
- Material: High performance alloy steel
- Application: For all screws applications in trade and industry
- In plastic box of 5 pcs

	 731415			 D mm	 L mm	 g
59S/50T8	0200085	5	T 8	2.4	50	12
59S/50T10	0200092	5	T 10	2.7	50	13
59S/50T15	0200108	5	T 15	3.3	50	13
59S/50T20	0200115	5	T 20	3.8	50	14
59S/50T25	0200122	5	T 25	4.4	50	14
59S/50T27	0200139	5	T 27	4.9	50	14
59S/50T30	0200146	5	T 30	5.5	50	15
59S/50T40	0200153	5	T 40	6.6	50	17

59S/50T 2P

BITS FOR TORX® SCREWS, 50 MM



- Drive: 1/4" DIN 3126-E 6,3, ISO 1173
- Finish: Zinc phosphated
- Material: High performance alloy steel
- Application: For all screw applications in trade and industry
- In small blister pack of 2 pcs

	 731415			 D mm	 L mm	 g
59S/50T10-2P	0201723	1	T10	2.7	50	15
59S/50T15-2P	0201730	1	T15	3.3	50	15
59S/50T20-2P	0201747	1	T20	3.8	50	15
59S/50T25-2P	0201754	1	T25	4.4	50	15
59S/50T30-2P	0201761	1	T30	5.5	50	15



STANDARD BITS 1/4"

59S/70T

BITS FOR TORX® SCREWS, 70 MM



- Drive: 1/4" DIN 3126-E 6,3, ISO 1173
- Finish: Zinc phosphated
- Material: High performance alloy steel
- Application: For all screw applications in trade and industry

** for special screws

	 731415			 D mm	 L mm	 g
59S/70T10	0200313	5	T10	2.7	70	7
59S/70T15	0200566	5	T15	3.3	70	7
59S/70T20	0200573	5	T20	3.8	70	8
59S/70T25	0200580	5	T25	4.4	70	8
59S/70T27	0200597	5	T27	4.9	70	9
59S/70T30	0200603	5	T30	5.5	70	10
59S/70T40	0200610	5	T40	6.6	70	12

59S/70T 2P

BITS FOR TORX® SCREWS, 70 MM



- Drive: 1/4" DIN 3126-E 6,3, ISO 1173
- Finish: Zinc phosphated
- Material: High performance alloy steel
- Application: For all screw applications in trade and industry
- In blister pack of 2 pcs

	 731415			 D mm	 L mm	 g
59S/70T20-2P	0201839	1	T20	3.8	70	40

59S/150T

BITS FOR TORX® SCREWS 150 MM



- Drive: 1/4" DIN 3126-E 6,3, ISO 1173
- Finish: Zinc phosphated
- Material: High performance alloy steel
- Application: For all screw applications in trade and industry

	 731415			 D mm	 L mm	 g
59S/150T15	0200764	5	T15	3.3	150	10
59S/150T20	0200771	5	T20	3.8	150	20
59S/150T25	0200788	5	T25	4.4	150	20
59S/150T30	0200795	5	T30	5.5	150	20



59S/TR



BITS FOR TORX® TAMPER SCREWS, 25 MM

- Drive: 1/4" DIN 3126-C 6,3, ISO 1173
- Finish: Zinc phosphated
- Material: High performance alloy steel
- Application: For all screw applications in trade and industry
- TORX® Tamper resistant screws have a centre pin to prevent a standard TORX® driver being inserted
- In plastic box of 5 pcs

	 731415			 D mm	 L mm	 g
59S/TR7	0198672	5	TR 7	1.99	25	4
59S/TR8	0198689	5	TR 8	2.31	25	4
59S/TR9	0198696	5	TR 9	2.50	25	4
59S/TR10	0198702	5	TR 10	2.74	25	5
59S/TR15	0198719	5	TR 15	3.27	25	5
59S/TR20	0198726	5	TR 20	3.86	25	6
59S/TR25	0198740	5	TR 25	4.43	25	6
59S/TR27	0198757	5	TR 27	4.99	25	6
59S/TR30	0198771	5	TR 30	5.52	25	6
59S/TR40	0198795	5	TR 40	6.65	25	7

59S/TR 3P



BITS FOR TORX® TAMPER SCREWS, 25 MM

- Drive: 1/4" DIN 3126-C 6,3, ISO 1173
- Finish: Zinc phosphated
- Material: High performance alloy steel
- Application: For all screws applications in trade and industry
- TORX® Tamper resistant screws have a centre pin to prevent a standard TORX® driver being inserted
- In small blister pack of 3 pcs

	 731415			 D mm	 L mm	 g
59S/TR10-3P	0201525	1	TR 10	2.74	25	20
59S/TR15-3P	0201532	1	TR 15	3.27	25	20
59S/TR20-3P	0201549	1	TR 20	3.86	25	20
59S/TR25-3P	0201556	1	TR 25	4.43	25	20
59S/TR27-3P	0201570	1	TR 27	4.99	25	20
59S/TR30-3P	0201587	1	TR 30	5.52	25	20
59S/TR40-3P	0201594	1	TR 40	6.65	25	20



STANDARD BITS 1/4"

59S/70TR

BITS FOR TORX® TAMPER SCREWS, 70 MM



- Drive: 1/4" DIN 3126-E 6,3, ISO 1173
- Finish: Zinc phosphated
- Material: High performance alloy steel
- Application: For all screws applications in trade and industry
- TORX® Tamper resistant screws have a centre pin to prevent a standard TORX® driver being inserted

	 731415			 b mm	 L mm	 g
59S/70TR15	0200627	5	TR15	3.27	70	8
59S/70TR20	0200634	5	TR20	3.86	70	8
59S/70TR25	0200641	5	TR25	4.43	70	8
59S/70TR27	0200658	5	TR27	4.99	70	9
59S/70TR30	0200665	5	TR30	5.52	30	9
59S/70TR40	0200672	5	TR40	6.65	70	10

59S/H mm

BITS FOR HEXAGON SCREWS, 25 MM



- Drive: 1/4" DIN 3126-C 6,3, ISO 1173
- Finish: Zinc phosphated
- Material: High performance alloy steel, ideal for bits
- Application: For all screws applications in trade and industry
- In plastic box of 5 pcs

	 731415		 mm	 L mm	 g
59S/H1.5	0198924	5	1.5	25	3
59S/H2	0198955	5	2	25	3
59S/H2.5	0198962	5	2.5	25	3
59S/H3	0198986	5	3	25	3
59S/H4	0198993	5	4	25	6
59S/H5	0199013	5	5	25	6
59S/H6	0199037	5	6	25	10
59S/H8	0199051	5	8	25	12
59S/H10	0199075	5	10	25	17



59S/H "

BITS FOR HEXAGON SCREWS, 25 MM



- Drive: 1/4" DIN 3126-C 6,3, ISO 1173
- Finish: Zinc phosphated
- Material: High performance alloy steel
- Application: For all screw applications in trade and industry
- In plastic box of 5 pcs

	 731415			 L mm	 g
59S/H1/4	0199266	5	1/4	25	5
59S/H1/8	0199174	5	1/8	25	5
59S/H1/16	0204205	5	1/16	25	5
59S/H3/8	0204212	5	3/8	25	5
59S/H3/16	0199228	5	3/16	25	5
59S/H3/32	0199136	5	3/32	25	5
59S/H5/16	0199273	5	5/16	25	5
59S/H5/32	0199204	5	5/32	25	5
59S/H5/64	0199112	5	5/64	25	8
59S/H7/32	0199242	5	7/32	25	8
59S/H7/64	0199150	5	7/64	25	12
59S/H9/64	0199198	5	9/64	25	15

59S/H 3P

BITS FOR HEXAGON SCREWS, 25 MM



- Drive: 1/4" DIN 3126-C 6,3, ISO 1173
- Finish: Zinc phosphated
- Material: High performance alloy steel
- Application: For all screw applications in trade and industry
- In small blister pack of 3 pcs

	 731415		 mm	 L mm	 g
59S/H3-3P	0201662	1	3	25	20
59S/H4-3P	0201679	1	4	25	20
59S/H5-3P	0201686	1	5	25	20
59S/H6-3P	0201693	1	6	25	20
59S/H8-3P	0201709	1	8	25	20



STANDARD BITS 1/4"

59S/50H

BITS FOR HEXAGON SCREWS, 50 MM



- Drive: 1/4" DIN 3126-E 6,3, ISO 1173
- Finish: Zinc phosphated
- Material: High performance alloy steel
- Application: For all screw applications in trade and industry
- In plastic box of 5 pcs

	 731415		 mm	 L mm	 g
59S/50H2	0200160	5	2	50	10
59S/50H2.5	0200177	5	2.5	50	10
59S/50H3	0200184	5	3	50	10
59S/50H4	0200191	5	4	50	10
59S/50H5	0200207	5	5	50	10
59S/50H6	0200214	5	6	50	10
59S/50H8	0200221	5	8	50	10

59S/H BALL

BITS FOR HEXAGON BALL POINT SCREWS, 89 MM



- Drive: 1/4" DIN 3126-E 6,3, ISO 1173
- Finish: Zinc phosphated
- Material: High performance alloy steel
- Application: For all screw applications in trade and industry
- Hex ball point bits facilitate working in confined spaces by using at an angle

	 731415		 mm	 L mm	 g
59S/H3BALL	0200689	5	3	89	20
59S/H4BALL	0200696	5	4	89	20
59S/H5BALL	0200702	5	5	89	20
59S/H6BALL	0200719	5	6	89	20
59S/H8BALL	0200726	5	8	89	20

59S/H BALL 3P

BITS FOR HEXAGON BALL POINT SCREWS, 89 MM



- Drive: 1/4" DIN 3126-E 6,3, ISO 1173
- Finish: Zinc phosphated
- Material: High performance alloy steel
- Application: For all screw applications in trade and industry
- Hex ball point bits facilitate working in confined spaces by using at an angle
- In blister pack of 3 pcs

	 731415		 mm	 L mm	 g
59S/HBALL-3P	0201716	1	5, 6, 8	89	65



59S/R



BITS FOR ROBERTSON SCREWS, 25 MM

- Drive: 1/4" DIN 3126-C 6,3, ISO 1173
- Finish: Zinc phosphated
- Material: High performance alloy steel
- Application: For all screw applications in trade and industry
- Robertson bits tapered tip retains the screw for easier operation and give more surface contact, reducing cam out effect
- In plastic box of 10 pcs

	 731415			 L mm	 g
59S/R1	0199310	10	# 1	25	5
59S/R2	0199341	10	# 2	25	6
59S/R3	0199365	10	# 3	25	8

59S/R 3P



BITS FOR ROBERTSON SCREWS, 25 MM

- Drive: 1/4" DIN 3126-C 6,3, ISO 1173
- Finish: Zinc phosphated
- Material: High performance alloy steel
- Application: For all screw applications in trade and industry
- Robertson bits tapered tip retains screw for easier operation and give more surface contact, reducing cam out effect
- In small blister pack of 3 pcs

	 731415			 L mm	 g
59S/R1-3P	0201631	1	#1	25	20
59S/R2-3P	0201648	1	#2	25	20
59S/R3-3P	0201655	1	#3	25	20

59S/50R



BITS FOR ROBERTSON SCREWS, 50 MM

- Drive: 1/4" DIN 3126-E 6,3, ISO 1173
- Finish: Zinc phosphated
- Material: High performance alloy steel
- Application: For all screws applications in trade and industry
- Robertson bits tapered tip retains screw for easier operation
- In plastic box of 5 pcs

	 731415			 L mm	 g
59S/50R1	0200238	5	#1	50	8
59S/50R2	0200245	5	#2	50	9
59S/50R3	0200252	5	#3	50	10



STANDARD BITS 1/4"

59S/TS mm

BITS FOR TORQ-SET SCREWS, 25 MM



- Drive: 1/4" DIN 3126-C 6,3, ISO 1173
- Finish: Zinc phosphated
- Material: High performance alloy steel
- Application: For applications where screws or bolts must be torque-tight
- In plastic boxes of 5 pcs

	 731415			 L mm	 g
59S/TS-0	0199389	5	0	25	5
59S/TS-1	0199396	5	1	25	5
59S/TS-2	0199419	5	2	25	5
59S/TS-3	0199433	5	3	25	5
59S/TS-4	0199457	5	4	25	5
59S/TS-5	0199518	5	5	25	5
59S/TS-6	0199532	5	6	25	6
59S/TS-8	0199556	5	8	25	6
59S/TS-10	0199570	5	10	25	6

59S/TW

BITS FOR TRI-WING SCREWS, 25 MM



- Drive: 1/4" DIN 3126-C 6,3, ISO 1173
- Finish: Zinc phosphated
- Material: High performance alloy steel
- Application: On tamper resistant screws in electronic products
- In plastic box of 5 pcs

	 731415			 L mm	 g
59S/TW0	0199617	5	TW 0	25	5
59S/TW1	0199631	5	TW 1	25	5
59S/TW2	0199655	5	TW 2	25	5
59S/TW3	0199679	5	TW 3	25	5
59S/TW4	0199693	5	TW 4	25	5
59S/TW5	0199716	5	TW 5	25	5



59S/M

BITS FOR XZN SCREWS, 25 MM



- Drive: 1/4" DIN 3126-C 6,3, ISO 1173
- Finish: Zinc phosphated
- Material: High performance alloy steel
- Application: For automotive applications. These screws are used in high torque applications
- In plastic box of 10 pcs

	 731415			 L mm	 g
59S/M3	0199730	10	M3	25	5
59S/M4	0199754	10	M4	25	5
59S/M5	0199778	10	M5	25	5
59S/M6	0199792	10	M6	25	5
59S/M8	0199808	10	M8	25	5

59S/PH COMBI 2P

BITS FOR PHILLIPS/SLOTTED SCREWS, 125 MM



- Drive: DIN 3126, ISO 1173
- Finish: Zinc phosphated
- Material: High performance alloy steel
- Application: The special slotted/Phillips profiles are used in many electrical racks and terminals because of the better torque and flexibility to the end user

	 731415				 L mm	 g
59S/PH2COMBI-2P	0203604	1	6.0	2	125	25
59S/PH3COMBI-2P	0203611	1	8.0	3	125	25

K6750

POWER NUT DRIVERS



- Drive: 1/4"DIN 3126 E6.3, ISO 1173
- Finish: Black finish
- Material: High performance alloy steel
- Hexagon socket
- In plastic box containing one nut driver

	 731415				 Ø mm	 L mm	 g
K6750-6	0204670	1	6 mm	1/4"	11.5	50	25
K6750-7	0204687	1	7 mm	1/4"	12	50	28
K6750-8	0204694	1	8 mm	1/4"	12.5	50	36
K6750-10	0204700	1	10 mm	1/4"	14.5	50	36
K6750-13	0204823	1	13 mm	1/4"	17	50	40
K6750-1/4	0204663	1	1/4"	1/4"	10.5	50	22
K6750-3/8	0204656	1	3/8"	1/4"	14.4	50	35



STANDARD BITS 1/4"

KM6750

POWER MAGNETIC NUT DRIVER



- Drive: 1/4" DIN 3126 E6.3, ISO 1173
- Finish: Black finish
- Material: High performance alloy steel
- With strong magnet
- Hexagon socket
- In plastic box containing one nut driver

	 731415				\varnothing mm	$\frac{L}{mm}$	 g
KM6750-6	0204601	1	6 mm	1/4"	11.5	50	25
KM6750-7	0204618	1	7 mm	1/4"	12	50	28
KM6750-8	0204625	1	8 mm	1/4"	12.5	50	31
KM6750-10	0204649	1	10 mm	1/4"	14.5	50	36
KM6750-13	0204632	1	13 mm	1/4"	17	50	40
KM6750-1/4	0204595	1	1/4"	1/4"	10.5	50	22
KM6750-3/8	0204588	1	3/8"	1/4"	14.4	50	35

K6625

ADAPTORS



- Drive: 1/4" DIN 3126-A6,3, ISO 1173
- Finish: Black finish
- Material: High performance alloy steel
- Male hexagon to male square 1/4" DIN 3120-A6,3
- Ball type

	 731415				$\frac{L}{mm}$	 g
K6625-1/4	0204496	5	1/4"	1/4"	25	5

K6638

ADAPTORS



- Drive: 1/4" DIN 3126-A6,3, ISO 1173
- Finish: Black finish
- Material: High performance alloy steel
- Hexagon male to square male 3/8" DIN 3120-A10
- Ball type

	 731415				$\frac{L}{mm}$	 g
K6638-3/8	0204557	5	3/8"	1/4"	38	25



K6650

ADAPTORS



- Drive: 1/4" DIN 3126-A6,3, ISO 1173
- Finish: Black finish
- Material: High performance alloy steel
- Hexagon male to square male DIN 3120
- K6650-1/4-1P in plastic holder
- Pin type (except K6650-1/4-1P ball type)

	 731415					
K6650-1/4	0204526	5	1/4"	1/4"	50	18
K6650-1/4-1P	0204533	1	1/4"	1/4"	50	18
K6650-3/8	0204502	5	3/8"	1/4"	50	25
K6650-1/2	0204519	5	1/2"	1/4"	50	35

K66100

ADAPTORS



- Drive: 1/4" DIN 3126-A6,3, ISO 1173
- Finish: Black finish
- Material: High performance alloy steel
- Hexagon male to square male DIN 3120
- K66100-1/4: Pin type
- K66100-3/8: Ball type

	 731415					
K66100-1/4	0204540	5	1/4"	1/4"	100	32
K66100-3/8	0204564	5	3/8"	1/4"	100	50

K6660-QR

ADAPTOR WITH QUICK RELEASE SYSTEM



- Drive: 1/4" DIN 3126-A6,3, ISO 1173
- Finish: Black finish
- Material: High performance alloy steel
- With quick release system for easy lock
- Hexagon male to square male DIN 3120
- In plastic holder
- Ball type

	 731415					
K6660-QR-1P	0204571	1	1/4"	1/4"	60	20



STANDARD BITS 1/4"

KR653



UNIVERSAL HOLDERS

- Drive: 1/4" DIN 3126-E 6,3, ISO 1173
- Finish: Black finish
- Material: High performance alloy steel
- With retaining ring, non magnetic
- DIN 3126 D 6,3

	 731415		 mm	 mm	 L mm	 g
KR653	0204885	5	1/4"	1/4"	60	11

KSR753



UNIVERSAL HOLDERS

- Drive: 1/4" DIN 3126-E 6,3, ISO 1173
- Finish: Stainless steel
- Material: High performance stainless steel
- With retaining ring. Non magnetic
- DIN 3126 D 6,3
- Application: Non-rusting stainless steel, suitable to use with stainless steel bits
- KSR753-1P, in plastic holder

	 731415		 mm	 mm	 L mm	 g
KSR753	0204892	5	1/4"	1/4"	75	30
KSR753-1P	0204908	1	1/4"	1/4"	75	45

KCB753



UNIVERSAL HOLDERS

- Drive: 1/4" DIN 3126-E 6,3, ISO 1173
- Finish: Copper-Beryllium (sleeve)
- Material: High performance alloy steel
- With retaining ring, non magnetic
- DIN 3126 D 6,3
- Application: Suitable for applications that require a very high torque or peak loads
- High wear and corrosion resistance

	 731415		 mm	 mm	 L mm	 g
KCB753	0204915	1	1/4"	1/4"	75	40



KM653

MAGNETIC UNIVERSAL HOLDERS



- Drive: 1/4" DIN 3126-E 6,3, ISO 1173
- Finish: Black finish
- Material: High performance alloy steel
- With strong magnet; without retaining ring
- DIN 3126 D 6,3
- KM653-1P, in plastic holder containing 1 adaptor

	 731415				\varnothing mm	 L mm	 g
KM653	1786915	5	1/4"	1/4"	10	60	12

KMR653

MAGNETIC UNIVERSAL HOLDERS



- Drive: 1/4" DIN 3126-E 6,3, ISO 1173
- Finish: Black finish
- Material: High performance alloy steel
- With strong magnet and retaining ring
- DIN 3126 D 6,3
- KMR653-1P, in plastic holder

	 731415				\varnothing mm	 L mm	 g
KMR653	0204922	5	1/4"	1/4"	11	60	15
KMR653-1P	0204939	1	1/4"	1/4"	11	60	20

KMR753

MAGNETIC UNIVERSAL HOLDERS



- Drive: 1/4" DIN 3126-E 6,3, ISO 1173
- Finish: Black finish
- Material: High performance alloy steel
- With strong magnet and retaining ring
- DIN 3126 D 6,3
- KMR753-1P, in plastic holder

	 731415				\varnothing mm	 L mm	 g
KMR753	0204946	5	1/4"	1/4"	11	70	30
KMR753-1P	0204953	1	1/4"	1/4"	11	70	35



STANDARD BITS 1/4"

KMR150



MAGNETIC UNIVERSAL HOLDERS

- Drive: 1/4" DIN 3126-E 6,3, ISO 1173
- Finish: Black finish
- Material: High performance alloy steel
- With strong magnet and retaining ring
- DIN 3126 D 6,3
- KMR150-1P, in plastic holder

	 731415				 mm	 L mm	 g
KMR150	0204960	5	1/4"	1/4"	11	150	60
KMR150-1P	0204977	1	1/4"	1/4"	11	150	65

KM653-QR



ADAPTORS WITH PERMANENT MAGNET AND QUICK RELEASE

- Drive: DIN 3126-E6.3, ISO 1173
- Material: High performance alloy steel
- DIN 3126 D 6,3
- With permanent magnet
- KM653-QR-1P, in plastic holder

	 731415				 mm	 L mm	 g
KM653-QR	0115983	5	1/4"	1/4"	14	60	15
KM653-QR-1P	1848507	1	1/4"	1/4"	14	60	20

KM753-QR



ADAPTORS WITH PERMANENT MAGNET AND QUICK RELEASE

- Drive: DIN 3126-E6.3, ISO 1173
- Material: High performance alloy steel
- DIN 3126 D 6,3
- With permanent magnet
- In plastic holder

	 731415				 mm	 L mm	 g
KM753-QR-1P	0204830	1	1/4"	1/4"	15	75	40

KM653-SF



ADAPTOR WITH SWIVEL FUCTION

- Drive: DIN 3126-E6.3, ISO 1173
- Material: High performance alloy steel
- DIN 3126 D 6,3
- With permanent magnet and with swivel function providing movility to reach tight spots
- In plastic holder

	 731415				 mm	 L mm	 g
KM653-SF	0204984	1	1/4"	1/4"	14	60	20



K18NF

BITS FOR PHILLIPS® PH HEAD SCREWS



- With thread drive for magazine screwdriver, thread 10-32NF 2A (DUOFAST) e.g. DUOFAST automatic screwdriver, on BOSCH, FEIN and MAKITA screwdrivers or HOLZ-HER magazine screwdriver
- Finish: Steel-grey, greased
- Material: High performance alloy steel

	 731415			 L mm	 g
K18NF-2	1347161	5	2	44.5	12

K19PZD

BITS FOR POZIDRIV® PZ HEAD SCREWS



- With thread drive for magazine screwdriver, thread 10-32NF 2A (DUOFAST) e.g. DUOFAST automatic screwdriver, on BOSCH, FEIN and MAKITA screwdrivers or HOLZ-HER magazine screwdriver
- Finish: Steel-grey, greased
- Material: High performance alloy steel

	 731415			 L mm	 g
K19PZD-2NF	1586157	10	2	44.5	10
K19PZD-2M5	1693237	10	2	44.5	10

K20TORX

BITS FOR TORX® HEAD SCREWS



- With thread drive for magazine screwdriver, thread 10-32NF 2A (DUOFAST) e.g. DUOFAST automatic screwdriver, on BOSCH, FEIN and MAKITA screwdrivers or HOLZ-HER magazine screwdriver
- Finish: Steel-grey, greased
- Material: High performance alloy steel

	 731415			 D mm	 L mm	 g
K20TORX-T25	1825799	10	T25	4.43	44.5	8



BIT SETS 1/4"

59S/31-1

BIT SET FOR SLOTTED, PHILLIPS PH, POZIDRIV PZ, TORX® AND HEXAGON HEAD SCREWS



- 31 pce bit set: 30 bits and 1 magnetic quick release bit holder
- In cardboard packaging
- Drive: 1/4" DIN 3126-C6.3, ISO 1173
- Finish: Zinc phosphate
- Material: High performance alloy steel

	 731151		 mm	 g
59S/31-1	0191451	1	110x65x42	250
59S/PH PH1, 3xPH2, PH3, 2xPH2G			59S/PZ PZ1, 3xPZ2, PZ3	
59S/T T10, 3xT15, 3xT20, 2xT25, T27, T30			59S/ 0.5x3.0, 0.6x4.5, 0.8x5.5	
59S/H 3.0, 4.0, 5.0, 6.0			KM653-QR 1/4" - 60 mm	

59S/31-2

31 PCE BIT SET FOR PHILLIPS, POZIDRIV AND TORX® SCREWS



- 31 pce bit set: 30 bits and 1 magnetic quick release bit holder
- In cardboard packaging
- Drive: 1/4" DIN 3126-C6.3, ISO 1173
- Finish: Zinc phosphate
- Material: High performance alloy steel

	 731151		 mm	 g
59S/31-2	0191468	1	110x65x42	250
59S/PH 4xPH2, 4xPH2G			59S/PZ 4xPZ2	
59S/T 2xT10, 4xT15, 5xT20, 5xT25, 2xT30			KM653-QR 1/4" - 60 mm	



59S/31-3

31 PCE BIT SET FOR PHILLIPS, POZIDRIV AND TORX® TAMPER RESISTANT SCREWS



- 31 pce bit set: 30 bits and 1 magnetic quick release bit holder
- In cardboard packaging
- Drive: 1/4" DIN 3126-C6.3, ISO 1173
- Finish: Zinc phosphate
- Material: High performance alloy steel

	 731151		 mm	 g
59S/31-3	0191475	1	110x65x42	245

59S/PH
2xPH1, 2xPH2, PH3



59S/PZ
2xPZ1, 3xPZ2, PZ3



59S/TR
2xTR10, 3xTR15, 5xTR20, 4xTR25,
TR27, 4xTR30, TR40



KM653-QR
1/4" - 60 mm



60T/31-1

31 PCE TORSION BIT SET FOR SLOTTED, PHILLIPS, POZIDRIV, TORX® AND HEXAGON SCREWS



- 31 pce bit set: 30 (Torsion+Standard) bits and 1 magnetic quick release bit holder
- In hanging cardboard packaging
- Drive: 1/4" DIN 3126-C6.3, ISO 1173
- Finish: Zinc phosphate
- Material: High performance alloy steel
- Torsion bits are suitable for hard material applications

	 731415		 mm	 g
60T/31-1	0191482	1	110x65x42	245

60T/PH
PH1, 3xPH2, PH3, 2xPH2G



60T/PZ
PZ1, 3xPZ2, PZ3



60T/T
T10, 3xT15, 3xT20, 2xT25, T27,
2xT30



60T/
0.6-4.5, 0.8x5.5



60T/H
3.0, 4.0, 5.0, 6.0



1 pce
1/4" - 60 mm





BIT SETS 1/4"

59S/17-1

17 PCE BIT SET FOR SLOTTED, PHILLIPS, POZIDRIV, HEXAGON SCREW



- 17 pce bit set: 16 bits and 1 magnetic quick release bit holder
- In cardboard packaging
- Drive: 1/4" DIN 3126-C6.3, ISO 1173
- Finish: Zinc phosphate
- Material: High performance alloy steel

	 731151		 mm	 g
59S/17-1	0191499	1	82x73x27	130
59S/PH PH1, 3xPH2, 2xPH2G			59S/PZ PZ1, 2xPZ2	
59S/H 3.0, 4.0, 5.0, 6.0			59S/ 3.0, 4.5, 5.5	
1 pce 1/4" - 50 mm				

59S/17-2

17 PCE BIT SET FOR TORX® SCREWS



- 17 pce bit set: 16 bits and 1 magnetic quick release bit holder
- In cardboard packaging
- Drive: 1/4" DIN 3126-C6.3, ISO 1173
- Finish: Zinc phosphate
- Material: High performance alloy steel

	 731151		 mm	 g
59S/17-2	0191505	1	82x73x27	130
59S/T T7,T8,T9,T10, 2xT15, 3xT20, 3xT25,T27, 2xT30,T40				
1 pce 1/4" - 50 mm				



59S/17-3

17 PCE BIT SET FOR POZIDRIV, PHILLIPS, TORX® TAMPER RESISTANT AND HEXAGONAL SCREWS



- 17 pce bit set: 16 bits and 1 magnetic quick release bit holder
- In cardboard packaging
- Drive: 1/4" DIN 3126-C6.3, ISO 1173
- Finish: Zinc phosphate
- Material: High performance alloy steel

	 731151		 mm	 g
59S/17-3	0191512	1	82x73x27	130
59S/PH PH1, 2xPH2			59S/PZ PZ1, PZ2, PZ3	
59S/T T10, T15, T20, T25, T27, T30, T40			59S/H 3.0, 4.0, 5.0	
1 pce 1/4" - 50 mm				

60T/17-1

17 PCE TORSION BIT SET FOR PHILLIPS AND TORX® SCREWS



- 17 pce bit set: 16 bits and 1 magnetic quick release bit holder
- Drive: 1/4" DIN 3126-C6.3, ISO 1173
- Finish: Zinc phosphate
- Material: High performance alloy steel
- Torsion bits are suitable for hard material applications

	 731151		 mm	 g
60T/17-1	0191529	1	82x73X27	130
60T/PH PH1,PH2				
60T/T T7,T8,T9,T10, 2xT15, 2xT20, 2xT25,T27, 2xT30,T40				
1 pce 1/4" - 50 mm				



BIT SETS 1/4"

59S/7-1

7 PCE BIT SET FOR PHILLIPS, POZIDRIV AND TORX® SCREW



- 7 pce bit set: 6 bits and 1 universal bit holder
- In a hanging cardboard sleeve
- Drive: 1/4" DIN 3126-C6.3, ISO 1173
- Finish: Zinc phosphate
- Material: High performance alloy steel

	 731151		 mm	 g
59S/7-1	0191536	1	75x65x22	105
59S/PH PH1, PH2			59S/PZ PZ1, PZ2	
59S/T T15, T20			1 pce 1/4" - 50 mm	

59S/7-2

7 PCE BIT SET FOR PHILLIPS AND TORX® SCREWS



- 7 pce bit set: 6 bits and 1 universal bit holder
- In a hanging cardboard sleeve
- Drive: 1/4" DIN 3126-C6.3, ISO 1173
- Finish: Zinc phosphate
- Material: High performance alloy steel

	 731151		 mm	 g
59S/7-2	0191543	1	75x65x22	105
59S/PH PH2				
59S/T 2xT15, 2xT20, T25				
1 pce 1/4" - 50 mm				



59S/7-3

7 PCE BIT SET FOR TORX® TAMPER RESISTANT SCREWS



- 7 pce bit set: 6 bits and 1 universal bit holder
- In a hanging cardboard sleeve
- Drive: 1/4" DIN 3126-C6.3, ISO 1173
- Finish: Zinc phosphate
- Material: High performance alloy steel

	 731151		 mm	 g
59S/7-3	0191550	1	75x65x22	105

59S/TR
TR10, TR15, TR20, TR25, TR30, TR40



1 pce
1/4" - 50 mm



59S/7-4

7 PCE BIT SET FOR TORX® SCREWS



- 7 pce bit set: 6 bits and 1 universal bit holder
- In a hanging cardboard sleeve
- Drive: 1/4" DIN 3126-C6.3, ISO 1173
- Finish: Zinc phosphate
- Material: High performance alloy steel

	 731151		 mm	 g
59S/7-4	0191567	1	75x65x22	105

59S/T
T10, T15, T20, T25, T30, T40



1 pce
1/4" - 50 mm





BIT SETS 1/4"

60T/7-1

7 PCE TORSION BIT SET FOR PHILLIPS, POZIDRIV AND TORX® SCREWS



- 7 pcs bits set: 6 torsion bits and 1 universal bit holder
- In a hanging cardboard card
- Drive: 1/4" DIN 3126-C6.3, ISO 1173
- Finish: Zinc phosphate
- Material: High performance alloy steel
- Torsion bits are suitable for hard material applications

60T/7-1	731151 0191574	1	75x65x22 mm	105 g
60T/PH PH2		60T/PZ PZ2		
60T/T T15, T20, T25, T30		1 pce 1/4" - 50 mm		

65I/7-1

7 PCE STAINLESS STEEL BIT SET FOR PHILLIPS, POZIDRIV AND TORX® SCREWS



- 7 pcs bits set: 6 stainless steel bits and 1 universal bit holder
- In a hanging cardboard sleeve
- Drive: 1/4" DIN 3126-C6.3, ISO 1173
- Finish: Zinc phosphate
- Material: High performance alloy steel
- Stainless steel bits prevent the formation of rust on stainless steel surfaces
- With a stainless universal bit holder

65I/7-1	731151 0204113	1	75x65x22 mm	105 g
65I/PH PH2		65I/PZ PZ2		
65I/T T15, 20, 25, 30		1 pce 1/4" - 50 mm		



62TIN/7-1

7 PCE TIN BIT SET FOR PHILLIPS, POZIDRIV AND TORX® SCREWS



- 7 pce bit set: 6 tin bits and 1 universal bit holder
- In a hanging cardboard sleeve
- Drive: 1/4" DIN 3126-C6.3, ISO 1173
- Finish: Titanium nitride
- Material: High performance alloy steel
- TIN bits are extremely wear resistant when used for high volume production and continuous use at normal torque levels

	 731151		 mm	 g
62TIN/7-1	0203505	1	75x65x22	105
62TIN/PH PH2		62TIN/PZ PZ2		
62TIN/T T15, T20, T25, T30		1 pce 1/4" - 50 mm		

63D/7-1

7 PCE DIAMOND BIT SET FOR PHILLIPS, POZIDRIV AND TORX® SCREWS



- 7 pce bit set: 6 diamond bits and 1 universal bit holder
- In a hanging cardboard sleeve
- Drive: 1/4" DIN 3126-C6.3, ISO 1173
- Finish: Diamond coating
- Material: High performance alloy steel
- Tip coated with thousands of tiny industrial grade diamond particles. Diamond bit has high strength and good wear resistance. Reduces significantly the "cam-out" effect and the necessary torque required to successfully drive the screw

	 731151		 mm	 g
63D/7-1	0191604	1	80x50x20	155
63D/PH PH2		63D/PZ PZ2		
63D/T T15, T20, T25, T30		1 pce 1/4" - 50 mm		



BIT SETS 1/4"

59S/22-1

22 PCE RUBBER BIT HOLDER FOR SLOTTED, PHILLIPS, POZIDRIV, TORX® SCREWS

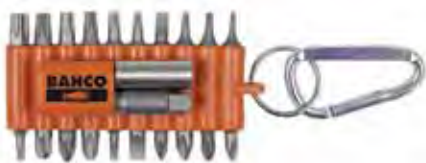

- 22 pce rubber holder: 20 bits, 1 universal magnetic bit holder and 1 socket adaptor 1/4"
- In a hanging cardboard sleeve
- Drive: 1/4" DIN 3126-C6.3, ISO 1173
- Finish: Zinc phosphate
- Material: High performance alloy steel

	 731151		 mm	 g
59S/22-1	0204229	1	80x50x20	155
59S/PH PH1, PH2, PH3, PH2G			59S/PZ PZ1, PZ2, PZ3	
59S/T T6, T8, T9, T10, T15, T20, T25, T27, T30, T40			59S/ 3.0, 4.5, 5.5	
1 pce 1/4" - 50 mm			K6650-1/4 1/4" - 50 mm	

59S/22-2

22 PCE RUBBER BIT HOLDER FOR PHILLIPS, TORX® AND HEXAGONAL SCREWS

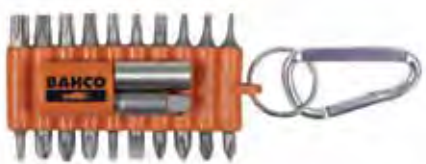

- 22 pce rubber holder: 20 bits, 1 universal magnetic bit holder and 1 socket adaptor 1/4"
- In a hanging cardboard card
- Drive: 1/4" DIN 3126-C6.3, ISO 1173
- Finish: Zinc phosphate
- Material: High performance alloy steel

	 731151		 mm	 g
59S/22-2	0204236	1	80x50x20	155
59S/PH 3xPH2, 3xPH2G			59S/PZ 2xPZ2	
59S/T T10, 4xT15, 3xT20, 2xT25			59S/ 2.5, 3.0	
1 pce 1/4" - 50 mm			K6650 1/4" - 50 mm	



59/S28-4

BIT SET FOR SLOTTED, PHILLIPS® PH, TORX®, HEXAGON AND TORQ-SET HEAD SCREWS



- 28 pce set: 26 bits + 1 adaptor + 1 universal holder
- Small box with rounded corners that can be easily stored in a pocket
- Drive: 1/4" DIN3126-C 6.3, ISO 1173
- Finish: Zinc phosphate
- Material: High performance alloy steel



	 731151		 g
59/S28-4	1847173	1	
59S/ 0.6x4.5, 1.2x6.5, 1.2x8.0		59S/PH 2xPH1, 2xPH2, PH3	
59S/T T6, T15		59S/H 5/64", 3/32", 7/64", 1/8", 9/64", 5/32", 3/16", 7/32"	
59S/TS 2x4, 2x6, 2x8, 2x10		K6625-1/4 1/4"	
KM653 1/4" - 60 mm			

2058/S26

26 PCE BIT AND SOCKETS SET BIT SET FOR SLOTTED, PHILLIPS, POZIDRIV, HEXAGON AND TORX® HEAD SCREWS



- 26 pce set: 18 bits + 5 sockets + 1 bit ratchet + 1 adaptor + 1 bit holder
- In a plastic box
- Drive: 1/4" DIN 3126-C 6, ISO 1173
- Finish: Bits; zinc phosphate, sockets; chrome, ratchet; plated
- Material: High performance alloy steel

	 731151		 mm	 g
2058/S26	1849276	1	35x100x80	300
SB-2058/S26	1849498	1	55x120x190	325
PH 1, 2, 3		PZ 1, 2, 3		
TORX T10, T15, T20, T25, T30		HEX 3, 4, 5, 6		
SL 4, 5, 6 mm		5 pieces 6, 7, 8, 10, 13 mm		
2058-BR 1/4" - 8 mm		1 pce 1/4" - 1/4"		



BIT SETS 1/4"

2058/S26-2

26 PCE BITS AND SOCKETS SET BIT SET FOR SLOTTED, PHILLIPS, POZIDRIV, HEXAGON AND TORX® HEAD SCREWS



- 26 pce set: 18 bits + 5 sockets + 1 bit ratchet + 1 adaptor + 1 bit holder
- In a plastic box
- Drive: 1/4" DIN 3126-C 6, ISO 1173
- Finish: Bits: Steel grey greased
- Finish: Sockets; chrome, ratchet; plated
- Material: High performance alloy steel

2058/S26-2	731151 1849283	1	35x100x80 mm	300 g
PH 0, 1, 2		PZ 0, 1, 2		
TORX T4, T5, T6, T7, T8		HEX 1.5, 2, 2.5, 3		
SL 3, 4, 5 mm		2058-BR 1/4" - 8 mm		
1 pce 1/4" - 1/4"		K6625-1/4 1/4"		
5 pieces 4, 5, 6, 7, 8 mm				



BITS 5/32"

42H



BITS FOR PHILLIPS® PH HEAD SCREWS

- Drive: 5/32" DIN 3126-C 4, ISO 1173
- Finish: Steel-grey, greased
- Material: High performance alloy steel

42H-1	731415 1140373	5	1	25 mm	2
42H-2	1140380	5	2	25	2

45M



BITS FOR HEXAGON SOCKET HEAD SCREWS

- Drive: 5/32" DIN 3126-C 4, ISO 1173
- Finish: Steel-grey, greased
- Material: High performance alloy steel

45M-1.5	731415 1140465	5	1.5 mm	20	2
45M-2	1140472	5	2	20	2
45M-2.5	1140489	5	2.5	20	2
45M-3.0	1140496	5	3	20	2









70MH

BITS FOR SLOTTED HEAD SCREWS



- Drive: 5/16" DIN 3126-C 8, ISO 1173
- Finish: Steel-grey, greased
- Material: High performance alloy steel
- * additional non standard size







	 731415					
70MH-1.2-8.0	1145071	5	1.2	8.0	41	12
70MH-1.6-9.0	1145101	5	* 1.6	* 9.0	41	15
70MH-1.6-10.0	1803575	5	1.6	10.0	41	16
70MH-2.0-12.0	1616755	5	2.0	12.0	41	20
70MH-2.5-14.0	1727314	5	2.5	14.0	41	25

72H

BITS FOR PHILLIPS® PH HEAD SCREWS



- Drive: 5/16" DIN 3126-C 8, ISO 1173
- Finish: Steel-grey, greased
- Material: High performance alloy steel







	 731415				
72H-1	1404222	5	1	32	10
72H-2	1147044	5	2	32	10
72H-3	1147051	5	3	32	10
72H-4	1147068	5	4	38	10

71PZDSDVH

BITS FOR POZIDRIV® PZ HEAD SCREWS



- Drive: 5/16" DIN 3126-C 8, ISO 1173
- Finish: Steel-grey, greased
- Material: High performance alloy steel

	 731415				
71PZDSDVH-1	1672584	5	1	32	10
71PZDSDVH-2	1672669	5	2	32	10
71PZDSDVH-3	1672744	5	3	32	10
71PZDSDVH-4	1672829	5	4	38	10



BITS 5/16"

65TORX



BITS FOR TORX® HEAD SCREWS

- Drive: 5/16" DIN 3126-C 8, ISO 1173
- Finish: Steel-grey, greased
- Material: High performance alloy steel

	 731415			 D mm	 L mm	 g
65TORX-T20	0206841	5	T20	3.86	35	10
65TORX-T25	0206858	5	T25	4.43	35	10
65TORX-T27	0206865	5	T27	4.99	35	10
65TORX-T30	1679835	5	T30	5.52	35	11
65TORX-T40	1679910	5	T40	6.65	35	12
65TORX-T45	1680091	5	T45	7.82	35	13
65TORX-T50	1680176	5	T50	8.83	35	14
65TORX-T55	1680251	5	T55	11.22	35	18

62



SCREWDRIVER BITS FOR TORQ-SET® HEAD SCREWS

- Drive: 5/16" DIN 3126-C 8, ISO 1173
- Finish: Steel-grey, greased
- Material: High performance alloy steel

	 731415			 L mm	 g
62-8	1628680	5	8 mm	32	11
62-10	1628765	5	10 mm	32	11
62-1/4	1628840	5	1/4"	32	12
62-5/16	1628925	5	5/16"	32	12

75M



BITS FOR HEXAGON METRIC SOCKET HEAD SCREWS

- Drive: 5/16" DIN 3126-C 8, ISO 1173
- Finish: Steel-grey, greased
- Material: High performance alloy steel

	 731415		 mm	 L mm	 g
75M-4	1147167	5	4	30	8
75M-5	1147174	5	5	30	10
75M-6	1147181	5	6	30	10
75M-7	0206926	5	7	30	10
75M-8	1147198	5	8	30	14
75M-10	1091859	5	10	30	20
75M-12	0206933	5	12	30	20
75M-14	0206940	5	14	30	20



7865

IMPACT DRIVER BIT SET



- Impact driver set with 15 pcs in black plastic box
- Content:
 - 1 impact driver, 1/2" square drive
 - 1 bit holding adapter for screwdriver bits, 5/16" hexagon and 1/2" square drive
 - 4 slotted bits, 5/16" hexagon drive (size 5, 6, 8, 10 mm)
 - 4 Phillips bits, 5/16" hexagon drive (size 1, 2, 3, 4 mm)
 - 4 hexagon bits, 5/16" hexagon drive (size 4, 5, 6, 8 mm)
 - 1 adapter, hexagon 5/16" to 3/8" square drive

7865	731151 8276720	1	220x90x55 mm	1000 g

BITS 11.2 MM (7/16")



7409KML

BITS FOR HEXAGON METRIC SOCKET HEAD SCREWS



- Drive: 11.2 mm (7/16") DIN 3126-E11,2, ISO 1173
- Finish: Steel-grey, greased
- Material: High performance alloy steel
- Bit holding: Locking screw
- Suitable adaptors 7409H, 7809H

	731415		mm	mm	g
7409KML-4	1218478	5	4	35	15
7409KML-5	1218485	5	5	35	15
7409KML-6	1218492	5	6	35	20
7409KML-7	1312190	5	7	35	20
7409KML-8	1218508	5	8	35	20
7409KML-10	1218515	5	10	35	22
7409KML-12	1218522	5	12	35	25
7409KML-14	1218539	5	14	35	30
7409KML-17	1233150	5	17	35	35

SCREWDRIVERS

Encounters of the ergonomic kind.

Discover new dimensions of working comfort with Bahco screwdrivers.

Bahco's research and development programme continues to prove its expertise in the field of hand tools. Our tools require less effort to use and are designed with safety in mind. Bahco ERGO™ screwdrivers meets demanding test procedures and end-users all over the world regularly rate them among the very best.

In this chapter you will find the full range of Bahco screwdrivers comprising ERGO™, Heavy Duty/ Tekno+, 800-series, blade through, ratcheting, precision, T-handles, hex key sets and folders. They all offer professional end-users the right tool for the right application.



Chapter Index

ERGO™ SCREWDRIVERS	434-449
TEKNO+ SCREWDRIVERS	450-465
800-SERIES SCREWDRIVERS	466-474
PREMIUM SCREWDRIVERS	475-487
600-SERIES SCREWDRIVERS	488-493
9000-SERIES SCREWDRIVERS	494-495
8000/9000 SERIES SCREWDRIVERS	495
RATCHETING SCREWDRIVERS	496-498
PRECISION SCREWDRIVERS	499-502
ELECTRONIC SCREWDRIVERS	502
T-HANDLE SCREWDRIVERS	503-505
SPECIAL SCREWDRIVERS	506-508
OFFSET SCREWDRIVERS	509-526



MORE THAN JUST AESTHETICALLY PLEASING - ERGO™ SCREWDRIVER



The ERGO™ Screwdriver has been developed through our three-phase Bahco ERGO™ Process. This program takes account of facts and experiences from users, ergonomists, industrial designers, and R&D departments, as well as extensive testing and trials. It is easier to use, more comfortable to hold and significantly more functional. It reduces muscle tension and risk of accidents and injuries, while increasing job satisfaction, productivity and profitability.



Choosing the right colour code/colour codes

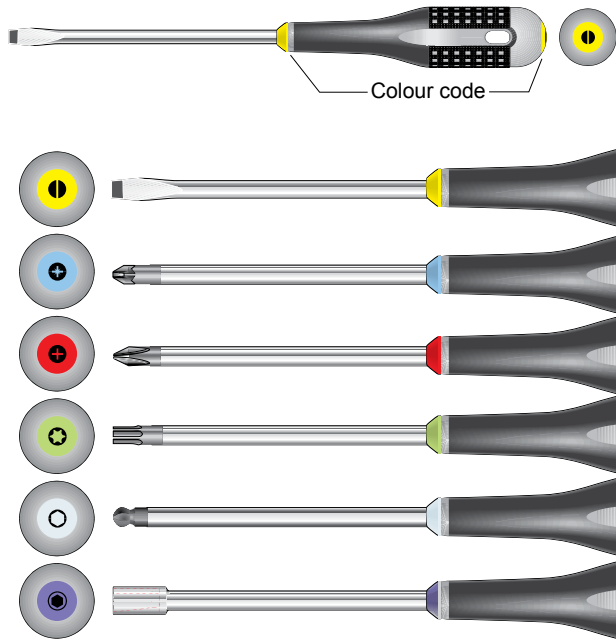

Double-shape handle allows the screwdriver to be held with both hands, for maximum torque.

INSULATED COMBI SCREWDRIVERS

Some tasks demand speciality tools. That is why we have specially made combi screwdrivers for use in terminal blocks, control cabinets, switches, relays, or similar. In order to differentiate the combis from other ERGO™ insulated screwdrivers, the colour used for the insulating material is orange.



Insulated combi screwdriver for slotted and Phillips head screws.



Insulated combi screwdriver for slotted and Pozidriv head screws.

FOR HEAVY DUTY APPLICATIONS



HEAVY DUTY

Hexagonal profile shank with hexagonal nut from 8 mm blade diameter allows the use of a wrench or an open-end spanner for demanding jobs which require extremely high torque power

Black tip for added protection, precisely machined

High performance alloy steel. Laser branding of the code number and size

Flat face to avoid rolling

A third colour together with an indelible symbol helps to quickly identify the tip required

Double-shaped handle, for use with both hands. Heavy duty design for a maximum torque power

The hard plastic provides high impact resistance to the tool as well as a perfect join between handle and shank

The hole in the handle permits the insertion of a T-bar for added force transmission and for hanging the tool



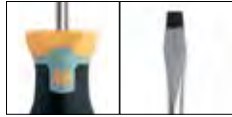

SLOTTED
TIP - STRAIGHT TIP



PHILLIPS TIP



POZIDRIV TIP



TORX TIP



ROBERTSON TIP
HEXAGONAL BALL TIP
HEXAGONAL
TUBULAR NUT DRIVER

THROUGH BLADE



The shank continues through the handle before connecting to a striking metal cap for added strength.

METALLIC CAP



The metal striking cap at the top of the handle gives additional protection for jobs requiring high impact and maximum force.

INTERCHANGEABLE BLADES SET

- Double-ended 11 blades and a Tekno+ handle in a compact aluminium case
- Slotted, Phillips, Pozidriv, TORX® and hexagon tips
- 22 screwdrivers stored in minimal space



SERIES 900 T- HANDLE

The optimal tool for jobs where torque is required, combining operational characteristics of a T-shaped

wrench with those of an offset key, with two blades positioned at 90°.



PRECISION SCREWDRIVERS

WHEN PRECISION IS A MUST

Specially designed screwdriver for precision work, especially for mechanical and electronic applications. Developed for comfortable and secure work.

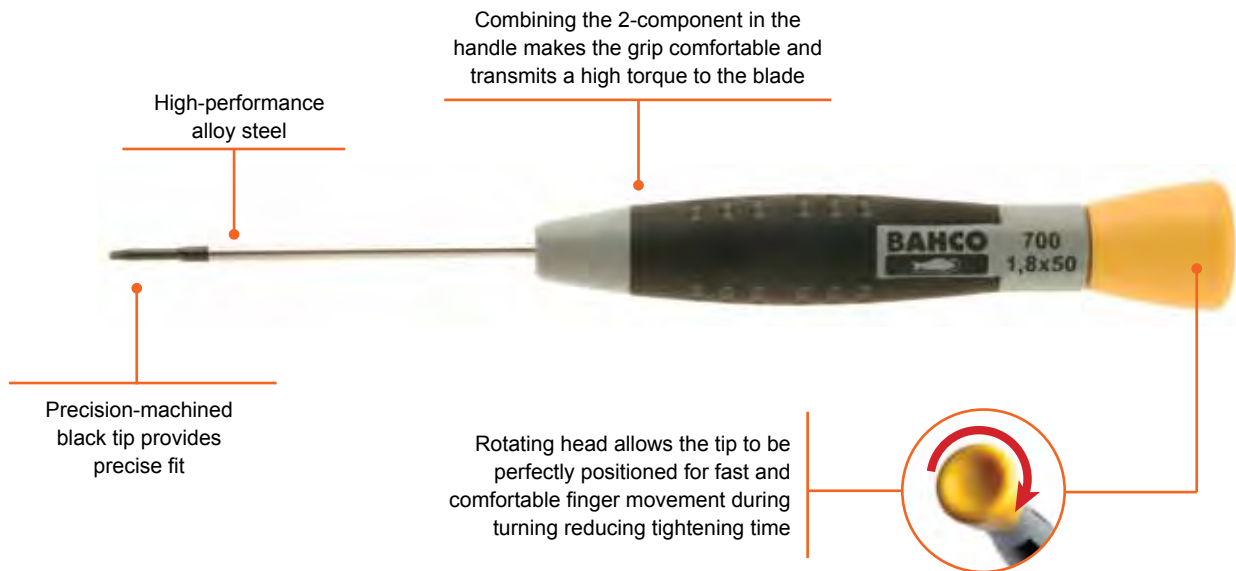

RATCHET & BITS SCREWDRIVERS

- Fast-tightening, thus time saving
- 48-teeth ratchet function
- Super grip 2-component handle
- Cartridge for bit storage

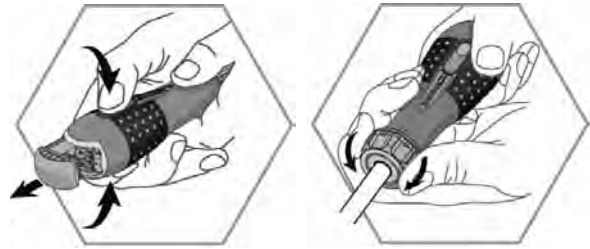

EFFICIENT MAGNETIC DEVICE
1/4" magnetic bit holder

SUPERIOR TORQUE
Quality mechanism ensures high torque bearing capacity

COMFORT AND STRENGTH
Oval handle shape with high-friction surface for increased torque and comfort

STRENGTH AND RELIABILITY
Alloy steel shank

EASY TO USE
Self-explanatory push buttons

FASTER SPINNING FEATURE
Knurled part for fast spinning

THREE MODES OF OPERATION
Reversing ring for quick mode selection. Clockwise, counter-clockwise and non-ratchet (fixed) mode

BIT STORAGE
Cartridge-style bit holder stores six bits



T-handle and pistol-grip for application when accessibility is a challenge.



Led light for enabling working in dark conditions.

THE WIDEST RANGE

	5,5 ▶ 14 8 ref.	PH 1 ▶ PH 4 4 ref.	PZ 1 ▶ PZ 4 4 ref.										
	2,5 ▶ 10 26 ref.	PH 0 ▶ PH 4 11 ref.	PZ 0 ▶ PZ 4 11 ref.	T 4 ▶ T 45 14 ref.	TR 7 ▶ TR 40 10 ref.	2 ▶ 10 8 ref.	3 ▶ 14 22 ref.	# 1 ▶ # 3 3 ref.	# 1 ▶ # 10 8 ref.	1/4" 1 ref.			6 Ø 2 ref.
	4 ▶ 14 7 ref.	PH 0 ▶ PH 4 5 ref.	PZ 0 ▶ PZ 4 5 ref.	T 6 ▶ T 40 11 ref.	TR 10 ▶ TR 40 7 ref.	2 ▶ 6 6 ref.							
	3 ▶ 10 14 ref.	PH 0 ▶ PH 3 7 ref.	PZ 0 ▶ PZ 3 6 ref.				4 ▶ 10 13,14 11 ref.	# 1 ▶ # 3 3 ref.		1/4" 2 ref.	1/4" 1 ref.		
	5,5 ▶ 14 6 ref.	PH 1 ▶ PH 4 4 ref.	PZ 1 ▶ PZ 3 3 ref.										
	2,5 ▶ 10 30 ref.	PH 0 ▶ PH 3 12 ref.	PZ 0 ▶ PZ 3 11 ref.	T 6 ▶ T 30 13 ref.		2 ▶ 8 7 ref.							6 Ø 4 ref.
	2,5 ▶ 12 25 ref.	PH 0 ▶ PH 4 10 ref.	PZ 0 ▶ PZ 4 7 ref.	T 4 ▶ T 40 13 ref.	TR 7 ▶ TR 40 10 ref.	2,5 ▶ 6 5 ref.	3,2 ▶ 14 14 ref.			1/4" 1 ref.			
	3 ▶ 10 21 ref.	PH 0 ▶ PH 3 5 ref.	PZ 0 ▶ PZ 3 4 ref.	T 10 ▶ T 40 7 ref.									6 Ø 2 ref.
	3,5 ▶ 10 5 ref.	PH 1 ▶ PH 3 3 ref.	PZ 1 ▶ PZ 2 2 ref.										
				T 6 ▶ T 50 13 ref.		2 ▶ 10 8 ref.	5 ▶ 13 10 ref.						
	1 ▶ 4 14 ref.	PH 00 ▶ PH 1 5 ref.	PZ 0 ▶ PZ 1 2 ref.	T 4 ▶ T 20 9 ref.		1,5 ▶ 3 4 ref.							

	2,5 ▶ 8 7 ref.	PH 0 ▶ PH 4 5 ref.	PZ 0 ▶ PZ 4 5 ref.	T 10 ▶ T 30 5 ref.	2,5 ▶ 8 6 ref.		5/PH 1 ▶ 6/PH 2 2 ref.	5/PZ 1 ▶ 6/PZ 2 2 ref.	
	3 ▶ 10 W ref.	PH 0 ▶ PH 3 4 ref.	PZ 0 ▶ PZ 3 4 ref.				5,5 ▶ 8 10,13 6 ref.		
	3 ▶ 12 14 ref.	PH 0 ▶ PH 4 9 ref.	PZ 0 ▶ PZ 3 7 ref.						
	2,5 ▶ 12 9 ref.	PH 0 ▶ PH 4 5 ref.	PZ 0 ▶ PZ 3 4 ref.				5 ▶ 13 10 ref.		
	3 ▶ 6,5 5 ref.	PH 0 ▶ PH 2 3 ref.							

INTELLIGENT HEX KEY SETS



- Key folder that keeps the most commonly used hex keys in one tool
- Easily carried in a pocket
- Practical to use on places which are hard to access

The folder permits to work easily in three different positions. In the 180° position, the folder can be used as a screwdriver. Positive stop at 270° open, mostly used for extreme turn, like a T-handle. Any angle between 90° and 270° can be selected depending on the working situation.



Practical hanging hole.

Bigger-sized handle makes it a handier tool. However, use caution when working with small blades as they can be over-torqued

Wide easy access release button for automatic release of the hex keys. When turning a key into the working position, the remaining keys stay stored



Convenient 'flip and turn' feature permits continuous tightening. This saves time when working in confined spaces as there is no need to continually remove and reinsert the tool into the screw head.

HEX KEY HOLDERS

- Foldable hex key holder available in a wide variety of key combinations
- Easy access to the hex key wrenches



You can take out the size needed without having to move the rest.



Integrated magnet in holder allows magnetizing and demagnetizing when needed.





BE-8010 - BE-8252

SLOTTED SCREWDRIVER



- Screwdriver developed according to the scientific ERGO™ process
- Screwdriver for slotted head screws
- Handle: 3-component handle, for maximum user comfort and force transmission
- Easy to choose the right tip, with the colour-coded handle and the symbol on the domed end
- Blade: High performance alloy steel. Chrome plated and entirely hardened. Black finish tip for higher accuracy
- ISO 2380/DIN 5264

	 731415		 mm	 mm	 mm	 mm	 mm	 g
BE-8010	0010615	5	0.4	2.5	60	20x122	182	31
BE-8210	1838584	5	0.4	2.5	75	20x122	197	33
BE-8020	0010639	5	0.5	3.0	60	20x122	182	30
BE-8020L	1838591	5	0.5	3.0	75	20x122	197	33
BE-8220	0047741	5	0.5	3.0	125	20x122	247	36
BE-8030	0010653	5	0.6	3.5	75	20x122	197	34
BE-8230	0047758	5	0.6	3.5	125	20x122	247	37
BE-8040	0010677	5	0.8	4.0	100	20x122	222	39
BE-8240	0047765	5	0.8	4.0	175	20x122	297	47
BE-8242	3010803	5	1.0	5.5	150	27x122	272	47
BE-8250L	1838607	5	1.0	5.5	200	27x122	322	90
BE-8252	3010810	5	1.2	6.5	150	36x122	272	47

BE-8150 - BE-8258

SLOTTED SCREWDRIVER



- Screwdriver developed according to the scientific ERGO™ process
- Screwdriver for slotted head screws
- Handle: 3-component handle, for maximum user comfort and force transmission
- Easy to choose the right tip, with the colour-coded handle and the symbol on the domed end
- Blade: High performance alloy steel. Chrome plated and entirely hardened. Black finish tip for higher accuracy
- ISO 2380/DIN 5264

	 731415		 mm	 mm	 mm	 mm	 mm	 g
BE-8150	0010707	5	1.0	5.5	100	27x122	222	66
BE-8155	0010721	5	1.2	6.5	125	36x122	247	112
BE-8250	0047772	5	1.0	5.5	150	27x122	272	73
BE-8255	0047789	5	1.2	6.5	150	36x122	272	116
BE-8256	3010827	5	1.6	8.0	150	36x122	272	135
BE-8257	3010834	5	1.6	8.0	175	36x122	297	140
BE-8258	3010841	5	1.6	10.0	200	36x161	361	195



BE-8158 - BE-8890

SLOTTED SCREWDRIVER



- Screwdriver developed according to the scientific ERGO™ process
- Screwdriver for slotted head screws
- Handle: 3-component handle, for maximum user comfort and force transmission
- Easy to choose the right tip, with the colour-coded handle and the symbol on the domed end
- Blade: High performance alloy steel. Chrome plated and entirely hardened. Black finish tip for higher accuracy
- ISO 2380/DIN 5264
- Hexagon profile blade and bolster for wrench assisted turning

	 731415		 mm	 mm	 mm	 mm	 mm	 mm	 g
BE-8158	3010858	5	1.0	5.5	125	27x122	247	9	75
BE-8159	3010865	5	1.2	6.5	150	36x122	272	11	125
BE-8160	0010745	5	1.6	8	125	36x122	247	14	162
BE-8260	0047796	5	1.6	8	175	36x122	297	14	179
BE-8865	0010851	5	1.6	8	175	36x165	336	14	209
BE-8870	0010875	5	1.6	10	175	36x165	336	18	210
BE-8880	0010899	5	2.0	12	200	36x165	361	18	291
BE-8890	0010905	5	2.5	14	200	36x165	361	18	293

BE-8330 - BE-8455

SLOTTED SCREWDRIVER



- Screwdriver developed according to the scientific ERGO™ process
- Screwdriver for slotted head screws, stubby type for working in confined spaces
- Handle: 3-component handle, for maximum user comfort and force transmission
- Easy to choose the right tip, with the colour-coded handle and the symbol on the domed end
- Blade: High performance alloy steel. Chrome plated and entirely hardened. Black finish tip for higher accuracy
- ISO 2380/DIN 5264

	 731415		 mm	 mm	 mm	 mm	 mm	 g
BE-8330	1838614	5	0.6	3.5	25	36x58	83	37
BE-8340	1838621	5	0.8	4.0	25	36x58	83	38
BE-8350	1838638	5	1.0	5.5	25	36x58	83	40
BE-8450	1838645	5	1.0	5.5	45	36x58	103	44
BE-8355	1838652	5	1.2	6.5	25	36x58	83	43
BE-8455	1838669	5	1.2	6.5	45	36x58	103	48
BE-8360	1838676	5	1.2	8.0	25	36x58	83	44



BE-8600 - BE-8624

PHILLIPS SCREWDRIVER



- Screwdriver developed according to the scientific ERGO™ process
- Screwdriver for Phillips head screws
- Handle: 3-component handle, for maximum user comfort and force transmission
- Easy to choose the right tip, with the colour-coded handle and the symbol on the domed end
- Blade: High performance alloy steel. Chrome plated and entirely hardened. Black finish tip for higher accuracy
- ISO 8764/DIN 5260

	 731415			 mm	 mm	 mm	 g
BE-8600	0010769	5	PH 0	60	20x122	182	30
BE-8610	0010776	5	PH 1	75	27x122	197	62
BE-8611	8292317	5	PH 1	75	20x122	197	62
BE-8610L	1838683	5	PH 1	200	27x122	322	81
BE-8620	0010783	5	PH 2	100	36x122	222	106
BE-8621	8292324	5	PH 2	100	27x122	222	106
BE-8620L	1838690	5	PH 2	200	36x122	322	127
BE-8623	3010872	5	PH 3	150	36x122	272	150
BE-8624	3010889	5	PH 4	200	36x165	361	225

BE-8628 - BE-8640

PHILLIPS SCREWDRIVER



- Screwdriver developed according to the scientific ERGO™ process
- Screwdriver for Phillips head screws
- Handle: 3-component handle, for maximum user comfort and force transmission
- Easy to choose the right tip, with the colour-coded handle and the symbol on the domed end
- Blade: High performance alloy steel. Chrome plated and entirely hardened. Black finish tip for higher accuracy
- ISO 8764/DIN 5260
- Hexagon profile blade and bolster for wrench assisted turning

	 731415			 mm	 mm	 mm	 mm	 g
BE-8628	3010896	5	PH 1	100	27x122	222	9	72
BE-8629	3010902	5	PH 2	125	36x122	247	11	122
BE-8630	0010790	5	PH 3	150	36x122	272	14	173
BE-8640	0010806	5	PH 4	200	36x165	361	18	292



BE-8601/BE-8602

PHILLIPS SCREWDRIVER



- Screwdriver developed according to the scientific ERGO™ process
- Screwdriver for Phillips head screws, stubby type for working in confined spaces
- Handle: 3-component handle, for maximum user comfort and force transmission
- Easy to choose the right tip, with the colour-coded handle and the symbol on the domed end
- Blade: High performance alloy steel. Chrome plated and entirely hardened. Black finish tip for higher accuracy
- ISO 8764/DIN 5260

	 731415			 mm	 mm	 mm	 g
BE-8601	1838706	5	PH 1	25	36x58	83	40
BE-8602	1838713	5	PH 2	25	36x58	83	43

BE-8800 - BE-8824

POZIDRIV SCREWDRIVER



- Screwdriver developed according to the scientific ERGO™ process
- Screwdriver for Pozidriv head screws
- Handle: 3-component handle, for maximum user comfort and force transmission
- Easy to choose the right tip, with the colour-coded handle and the symbol on the domed end
- Blade: High performance alloy steel. Chrome plated and entirely hardened. Black finish tip for higher accuracy
- ISO 8764

	 731415			 mm	 mm	 mm	 g
BE-8800	0042012	5	PZ 0	60	20x122	182	30
BE-8810	0010813	5	PZ 1	75	27x122	197	62
BE-8811	8292331	5	PZ 1	75	20x122	197	62
BE-8810L	1838720	5	PZ 1	200	27x122	322	81
BE-8820	0010820	5	PZ 2	100	36x122	222	106
BE-8821	8292348	5	PZ 2	100	27x122	222	106
BE-8820L	1838737	5	PZ 2	200	36x122	322	127
BE-8823	3010919	5	PZ 3	150	36x122	272	150
BE-8824	3010926	5	PZ 4	200	36x165	361	224



BE-8828 - BE-8840

POZIDRIV SCREWDRIVER



- Screwdriver developed according to the scientific ERGO™ process
- Screwdriver for Pozidriv head screws
- Handle: 3-component handle, for maximum user comfort and force transmission
- Easy to choose the right tip, with the colour-coded handle and the symbol on the domed end
- Blade: High performance alloy steel. Chrome plated and entirely hardened. Black finish tip for higher accuracy
- ISO 8764
- Hexagon profile blade and bolster for wrench assisted turning

	731415			mm	mm	mm	mm	g
BE-8828	3010933	5	PZ 1	100	27x122	222	9	72
BE-8829	3010940	5	PZ 2	125	36x122	247	11	122
BE-8830	0010837	5	PZ 3	150	36x122	272	14	173
BE-8840	0010844	5	PZ 4	200	36x165	361	18	292

BE-8801/BE-8802

POZIDRIV SCREWDRIVER



- Screwdriver developed according to the scientific ERGO™ process
- Screwdriver for Pozidriv head screws, stubby type for working in confined spaces
- Handle: 3-component handle, for maximum user comfort and force transmission
- Easy to choose the right tip, with the colour-coded handle and the symbol on the domed end
- Blade: High performance alloy steel. Chrome plated and entirely hardened. Black finish tip for higher accuracy
- ISO 8764

	731415			mm	mm	mm	mm	g
BE-8801	1838744	5	PZ 1	25	36x58	83	40	
BE-8802	1838751	5	PZ 2	25	36x58	83	43	



BE-8904 - BE-8945

TORX® SCREWDRIVER

ergo®



- Screwdriver developed according to the scientific ERGO™ process
- Screwdriver for TORX® head screws
- Handle: 3-component handle, for maximum user comfort and force transmission
- Easy to choose the right tip, with the colour-coded handle and the symbol on the domed end
- Blade: High performance alloy steel. Chrome plated and entirely hardened. Black finish tip for higher accuracy

	 731415			 D	 mm	 mm	 mm	 g
BE-8904	3010957	5	T 4	1,30	75	20x122	197	30
BE-8905	3010049	5	T 5	1,37	75	20x122	197	31
BE-8906	0027729	5	T 6	1.65	75	20x122	197	31
BE-8907	0027736	5	T 7	1.97	75	20x122	197	31
BE-8908	0027743	5	T 8	2.30	75	20x122	197	31
BE-8909	0027750	5	T 9	2.48	75	20x122	197	31
BE-8910	0027767	5	T 10	2.72	75	20x122	197	31
BE-8915	0027774	5	T 15	3.26	100	27x122	222	57
BE-8920	0027781	5	T 20	3.84	100	27x122	222	57
BE-8925	0027798	5	T 25	4.40	125	27x122	247	70
BE-8927	0027804	5	T 27	4.96	125	27x122	247	70
BE-8930	0027811	5	T30	5.49	150	36x122	272	119
BE-8940	0027828	5	T40	6.60	150	36x165	311	130
BE-8945	1838782	5	T45	7.70	150	36x165	311	178

BE-7907 - BE-7940

TORX® SCREWDRIVER

ergo®



- Screwdriver developed according to the scientific ERGO™ process
- Screwdriver for TORX® and TORX® tamper resistant head screws
- Handle: 3-component handle, for maximum user comfort and force transmission
- Easy to choose the right tip, with the colour-coded handle and the symbol on the domed end
- Blade: High performance alloy steel. Chrome plated and entirely hardened. Black finish tip for higher accuracy

	 731415			 D	 mm	 mm	 mm	 g
BE-7907	3010964	5	TR 7	1.97	75	20x122	197	31
BE-7908	3010971	5	TR 8	2.30	75	20x122	197	31
BE-7909	3010988	5	TR 9	2.48	75	20x122	197	31
BE-7910	1838799	5	TR 10	2.72	75	20x122	197	31
BE-7915	1838805	5	TR 15	3.26	100	27x122	222	57
BE-7920	1838812	5	TR 20	3.84	100	27x122	222	57
BE-7925	1838829	5	TR 25	4.40	125	27x122	247	70
BE-7927	1838836	5	TR 27	4.96	125	27x122	247	70
BE-7930	1838843	5	TR 30	5.49	150	36x122	272	119
BE-7940	1838850	5	TR 40	6.60	150	36x165	311	130



BE-8702 - BE-8710

HEXAGON BALL END SCREWDRIVER



- Screwdriver developed according to the scientific ERGO™ process
- Screwdriver for hexagonal head screws, ball ended, easy to insert in the screw head from a range of angles. More efficient than the standard hex and time saver
- Handle: 3-component handle, for maximum user comfort and force transmission
- Easy to choose the right tip, with the colour-coded handle and the symbol on the domed end
- Blade: High performance alloy steel. Chrome plated and entirely hardened. Black finish tip for higher accuracy

	 731415		 mm	 mm	 mm	 mm	 g
BE-8702	1838768	5	2	100	20x122	222	32
BE-8725	1838775	5	2.5	100	20x122	222	32
BE-8703	0027651	5	3	100	20x122	222	35
BE-8704	0027668	5	4	100	27x122	222	66
BE-8705	0027675	5	5	100	36x122	222	105
BE-8706	0027682	5	6	125	36x122	247	125
BE-8708	0027699	5	8	150	36x122	272	197
BE-8710	0027705	5	10	150	36x165	311	250

BE-9001 - BE-9003

ROBERTSON (SQUARE) SCREWDRIVER



- Screwdriver developed according to the scientific ERGO™ process
- Screwdriver for Robertson (square) head screws
- Handle: 3-component handle, for maximum user comfort and force transmission
- Easy to choose the right tip, with the colour-coded handle and the symbol on the domed end
- Blade: High performance alloy steel. Chrome plated and entirely hardened. Black finish tip for higher accuracy

	 731151			 mm	 mm	 mm	 g
BE-9001	8269005	1	# 1	80	27x122	202	62
BE-9002	8269012	5	# 2	80	27x122	202	62
BE-9003	8269029	5	# 3	100	27x122	202	105



BE-8080

TORQ-SET®

ergo®



- Screwdriver developed according to the scientific ERGO™ process
- Screwdriver for TORQ-SET® security screws, meets aerospace rigorous torque requirements
- Handle: 3-component handle, for maximum user comfort and force transmission
- Easy to choose the right tip, with the colour-coded handle
- Blade: High performance alloy steel. Chrome plated and entirely hardened. Black finish tip for higher accuracy

	731415			mm	mm	mm	g
BE-8080-1	3010995	5	1	75	27x122	195	58
BE-8080-2	3011008	5	2	75	27x122	195	58
BE-8080-3	3011015	5	3	75	27x122	195	58
BE-8080-4	3011022	5	4	75	27x122	195	58
BE-8080-5	3011039	5	5	75	27x122	195	58
BE-8080-6	3011046	5	6	75	27x122	195	58
BE-8080-8	3011053	5	8	100	27x122	220	75
BE-8080-10	3011060	5	10	100	27x122	220	75

BE-8985

AWL

ergo®



- Developed according to the scientific ERGO™ process
- Awl, for pre-punching and drilling holes
- Handle: 3-component handle, for maximum user comfort and force transmission
- Easy to choose the right tip, with the colour-coded handle
- Blade: High performance alloy steel. Chrome plated and entirely hardened

	731415		mm	mm	mm	mm	g
BE-8985	3010698	5	6.0	100	27x122	222	67

BE-8980

REAMER

ergo®



- Developed according to the scientific ERGO™ process
- Reamer, for enlarging and drilling holes
- Handle: 3-component handle, for maximum user comfort and force transmission
- Easy to choose the right tip, with the colour-coded handle
- Blade: High performance alloy steel. Chrome plated and entirely hardened

	731415		mm	mm	mm	mm	g
BE-8980	3010681	5	6.0	100	27x122	222	67



BE-8577

BIT HOLDER



- Developed according to the scientific ERGO™ process
- Bit holder for 1/4" bits
- Handle: 3-component handle, for maximum user comfort and force transmission
- Easy to choose the right tip, with the colour-coded handle
- Blade: High performance alloy steel. Chrome plated and entirely hardened

	 731415		 1/4	 118	 36x122	 240	 5.5
BE-8577	1839048	5	1/4	118	36x122	240	5.5

BE-76

NUT DRIVERS WITH HANDLE, WITH FLEXIBLE BLADE



- Nut driver developed according to the scientific ERGO™ process
- Handle: 3-component handle, for maximum user comfort and force transmission
- Easy to choose the right tip, with the colour-coded handle and the symbol on the domed end
- Blade: Flexible shaft. High performance alloy steel. Chrome plated

	 731415		 mm	 1mm	 mm	 mm	 g
BE-7606	1839017	5	6	150	27x122	272	126
BE-7607	1839024	5	7	150	27x122	272	126
BE-7608	1839031	5	8	150	27x122	272	126

BE-6400M

NUT DRIVERS WITH HANDLE, MAGNETIC, SLIM BORE



- Nut driver developed according to the scientific ERGO™ process
- Handle: 3-component handle, for maximum user comfort and force transmission
- Easy to choose the right tip, with the colour-coded handle and the symbol on the domed end
- Blade: Slim magnetic bore. High performance alloy steel. Chrome plated and entirely hardened

	 731415		 mm	 mm	 mm	 mm	 g
BE-6400M-4	3011145	5	4	5.9x23	100	20x122	36
BE-6400M-5	3011169	5	5	6.95x23	100	20x122	38
BE-6400M-5.5	3011176	5	5.5	7.65x23	100	20x122	38
BE-6400M-7	3011190	5	7	9.8x23	100	20x122	42



BE-78

NUT DRIVERS WITH HANDLE, LONG BORE

ergo®



- Nut driver developed according to the scientific ERGO™ process
- Handle: 3-component handle, for maximum user comfort and force transmission
- Easy to choose the right tip, with the colour-coded handle and the symbol on the domed end
- Blade: Long bore. High performance alloy steel. Chrome plated and entirely hardened

	 731415		 mm	 mm	 mm	 mm	 mm	 g
BE-7803	1838867	5	3	40	125	20x122	247	52
BE-7835	1838874	5	3.5	40	125	20x122	247	54
BE-7804	1838881	5	4	50	125	20x122	247	57
BE-7845	1838898	5	4.5	50	125	20x122	247	58
BE-7805	1838904	5	5	50	125	20x122	247	60
BE-7855	1838911	5	5.5	50	125	20x122	247	62
BE-7806	1838928	5	6	50	125	20x122	247	64
BE-7807	1838935	5	7	50	125	27x122	247	100
BE-7808	1838942	5	8	50	125	27x122	247	104
BE-7809	1838959	5	9	50	125	36x122	247	136
BE-7810	1838966	5	10	50	125	36x122	247	140
BE-7811	1838973	5	11	50	125	36x122	247	169
BE-7812	1838980	5	12	50	125	36x122	247	184
BE-7813	1838997	5	13	50	125	36x165	286	215
BE-7814	1839000	5	14	50	125	36x165	286	230

BE-8010S - BE-8065S

INSULATED SCREWDRIVERS

ergo®



IEC 60900 1000V

- Screwdriver developed according to the scientific ERGO™ process
- Insulated screwdriver for slotted head screws
- For work on live equipment, up to 1000 V
- Handle: 3-component handle, for maximum user comfort and force transmission
- Easy to choose the right tip, with the colour-coded handle and the symbol on the domed end
- High performance alloy steel, insulation moulded directly onto blade. Black finish tip for higher accuracy
- ISO 2380/DIN 5264
- Individually inspected and manufactured according to IEC 60900

	 731415		 mm	 mm	 mm	 mm	 mm	 g
BE-8010S	0033058	5	0.4	2.5	75	20x122	197	30
BE-8220S	0048243	5	0.5	3.0	100	20x122	222	33
BE-8230S	0048250	5	0.6	3.5	100	20x122	222	33
BE-8040S	0033089	5	0.8	4.0	100	20x122	222	33
BE-8050S	0033096	5	1.0	5.5	125	27x122	247	62
BE-8255S	0048281	5	1.2	6.5	150	36x122	272	105
BE-8065S	0033119	5	1.2	8.0	175	36x122	297	127



ERGO™ SCREWDRIVERS

BE-8600S - BE-8640S

INSULATED SCREWDRIVERS

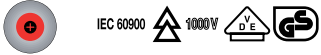

- Screwdriver developed according to the scientific ERGO™ process
- Insulated screwdriver for Phillips head screws
- For work on live equipment, up to 1000 V
- Handle: 3-component handle, for maximum user comfort and force transmission
- Easy to choose the right tip, with the colour-coded handle and the symbol on the domed end
- High performance alloy steel, insulation moulded directly onto blade. Black finish tip for higher accuracy
- ISO 8764/DIN 5260
- Individually inspected and manufactured according to IEC 60900

	 731415			 mm	 mm	 mm	 g
BE-8600S	0033126	5	PH 0	75	20x122	197	31
BE-8610S	0033133	5	PH 1	80	27x122	202	64
BE-8620S	0033140	5	PH 2	100	36x122	222	108
BE-8630S	0033157	5	PH 3	150	36x122	272	159
BE-8640S	0033164	5	PH 4	200	36x165	365	268

BE-8800S - BE-8840S

INSULATED SCREWDRIVERS



- Screwdriver developed according to the scientific ERGO™ process
- Insulated screwdriver for Pozidriv head screws
- For work on live equipment, up to 1000 V
- Handle: 3-component handle, for maximum user comfort and force transmission
- Easy to choose the right tip, with the colour-coded handle and the symbol on the domed end
- Blade: High performance alloy steel, insulation moulded directly onto blade. Black finish tip for higher accuracy
- ISO 8764
- Individually inspected and manufactured according to IEC 60900

	 731415			 mm	 mm	 mm	 g
BE-8800S	1839055	5	PZ 0	75	20x122	197	31
BE-8810S	0048298	5	PZ 1	80	27x122	202	64
BE-8820S	0048304	5	PZ 2	100	36x122	222	110
BE-8830S	0048311	5	PZ 3	150	36x122	272	159
BE-8840S	1839062	5	PZ 4	200	36x161	365	268



BE-8910S - BE-8930S

INSULATED SCREWDRIVERS

ergo®



IEC 60900 1000V D'E GS

- Screwdriver developed according to the scientific ERGO™ process
- Insulated screwdriver for TORX® head screws
- For work on live equipment, up to 1000 V
- Handle: 3-component handle, for maximum user comfort and force transmission
- Easy to choose the right tip, with the colour-coded handle and the symbol on the domed end
- Blade: High performance alloy steel. Black finish and entirely hardened
- Individually inspected and manufactured according to IEC 60900

	731415			D mm	mm	mm	mm	g
BE-8910S	1839079	5	T 10	2.72	100	20x122	222	33
BE-8915S	1839086	5	T 15	3.26	125	27x122	247	62
BE-8920S	1839093	5	T 20	3.84	125	27x122	247	62
BE-8925S	1839109	5	T 25	4.40	150	27x122	272	77
BE-8930S	1839116	5	T 30	5.49	175	36x122	297	129

BE-8725S - BE-8708S

INSULATED SCREWDRIVERS

ergo®



IEC 60900 1000V D'E GS

- Screwdriver developed according to the scientific ERGO™ process
- Insulated screwdriver for hexagon head screws
- For work on live equipment, up to 1000 V
- Handle: 3-component handle, for maximum user comfort and force transmission
- Easy to choose the right tip, with the colour-coded handle and the symbol on the domed end
- Blade: High performance alloy steel. Black finish and entirely hardened
- Individually inspected and manufactured according to IEC 60900

	731415		mm	mm	mm	mm	g
BE-8725S	1839123	5	2.5	75	20x122	197	33
BE-8703S	1839130	5	3	75	20x122	197	62
BE-8704S	1839147	5	4	75	20x122	197	78
BE-8705S	1839154	5	5	175	27x122	297	128
BE-8706S	1839161	5	6	200	27x122	322	159
BE-8708S	1839178	5	8	200	36x122	322	235



ERGO™ SCREWDRIVERS

BE-8510S - BE-8520S



IEC 60900 1000V DVE GS



INSULATED SCREWDRIVERS

- Screwdriver developed according to the scientific ERGO™ process
- Combi insulated screwdriver, two tips in one, for slotted and Phillips head screws
- For work on live equipment, up to 1000 V
- Handle: 3-component handle, for maximum user comfort and force transmission
- Easy to choose the right tip, with the colour-coded handle and the symbol on the domed end
- Blade: High performance alloy steel. Black finish and entirely hardened
- Individually inspected and manufactured according to IEC 60900

BE-8510S	731415 0126507	5	5	-	1	80	27x122	202	60
BE-8520S	0126514	5	6	-	2	100	36x122	222	100

BE-8710S - BE-8720S



IEC 60900 1000V DVE GS



INSULATED SCREWDRIVERS

- Screwdriver developed according to the scientific ERGO™ process
- Combi insulated screwdriver, two tips in one, for slotted and Pozidriv head screws
- For work on live equipment, up to 1000 V
- Handle: 3-component handle, for maximum user comfort and force transmission
- Easy to choose the right tip, with the colour-coded handle and the symbol on the domed end
- Blade: High performance alloy steel. Black finish and entirely hardened
- Individually inspected and manufactured according to IEC 60900

BE-8710S	731415 0126521	5	5	1		80	27x122	202	60
BE-8720S	0126538	5	6	2		100	36x122	222	100

BE-9881



SCREWDRIVER SETS

- ERGO™ screwdriver set, 6 pcs
- For slotted and Phillips head screws
- In cardboard box

BE-9881	731415 0043279	1	450

BE-8020, BE-8040 0.5x3x60, 0.8x4x100		
BE-8150, BE-8155 1.0x5.5x100, 1.2x6.5x125		
BE-8610, BE-8620 PH1x75, PH2x100		



BE-9882

SCREWDRIVER SETS



- ERGO™ screwdriver set, 6 pcs
- For slotted and Pozidriv head screws
- In cardboard box

	 731415		 g
BE-9882	1839284	1	450
BE-8020, BE-8040 0.5x3x60, 0.8x4x100			
BE-8150, BE-8155 1.0x5.5x100, 1.2x6.5x125			
BE-8810, BE-8820 PZ1x75, PZ2x100			

BE-9883

SCREWDRIVER SETS



- ERGO™ screwdriver set, 6 pcs
- For Pozidriv and TORX® head screws
- In cardboard box

	 731415		 g
BE-9883	1839291	1	450
BE-8810, BE-8820, BE-8830 PZ1x75, PZ2x100, PZ3x150			
BE-8910, BE-8915, BE-8925 T10x75, T15x100, T25x125			

BE-9885

SCREWDRIVER SETS



- ERGO™ screwdriver set, 5 pcs
- For TORX® head screws
- In cardboard box

	 731415		 g
BE-9885	0048465	1	355
BE-8910, BE-8930 T10, T15, T20, T25, T30			



ERGO™ SCREWDRIVERS

BE-9886



SCREWDRIVER SETS

- ERGO™ screwdriver set, 6 pcs
- For slotted, Phillips and Pozidriv head screws
- In cardboard box

	 731415		 g
BE-9886	0048472	1	430
BE-8030 0.6x3.5x75 mm			
BE-8150 1x5.5x100 mm			
BE-8610, BE-8620 PH1x75, PH2x100			
BE-8810, BE-8820 PZ1x75, PZ2x100			

BE-9889



SCREWDRIVER SETS

- ERGO™ screwdriver set, 5 pcs
- For Pozidriv and TORX® head screws
- In cardboard box

	 731415		 g
BE-9889	3010711	1	490
BE-8810, BE-8820 PZ1x75, PZ2x100			
BE-8910, BE-8915, BE-8925 T10x75, T15x100, T-25x125			

BE-9881S



SCREWDRIVER SETS

- ERGO™ insulated screwdriver set, 5 pcs
- For slotted and Phillips head screws
- In cardboard box

	 731415		 g
BE-9881S	1839307	1	450
BE-8220S, BE-8040S, BE-8050S 0.5x3x100, 0.8x4x100, 1x5.5x125			
BE-8610S, BE-8620S PH1x80, PH2x100			



BE-9882S

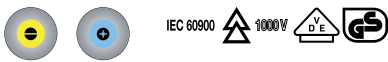

SCREWDRIVER SETS

- ERGO™ insulated screwdriver set, 5 pcs
- For slotted and Pozidriv head screws
- In cardboard box

	 731415		 g
BE-9882S	1839314	1	450
BE-8220S, BE-8040S, BE-8050S 0.5x3x100, 0.8x4x100, 1x5.5x125			
BE-8810S, BE-8820S PZ1x80, PZ2x100			

BE-9888S



SCREWDRIVER SETS

- ERGO™ insulated screwdriver set, 7 pcs
- For slotted and Pozidriv head screws
- In cardboard box

	 731415		 g
BE-9888S	3006158	1	530
BE-8010S, BE-8220S, BE-8040S, BE-8050S 0.4x2.5x75, 0.5x3.0x100, 0.8x4.0x100, 1.0x5.5x125			
BE-8800S, BE-8820S, BE-8830S PZ0x75, PZ2x100, PZ3x150			

BE-9885S



SCREWDRIVER SETS

- ERGO™ combi insulated screwdriver set, 4 pcs (8 different tips) and a voltage tester
- For slotted, Phillips and Pozidriv head screws
- In cardboard box

	 731415		 g
BE-9885S	0126491	1	445
806-1-1 0.6x3x65			
BE-8510S, BE-8520S 5/PH1, 6/PH2			
BE-8710S, BE-8720S 5/PZ1, 6/PZ2			



020

SLOTTED SCREWDRIVER

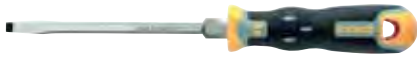

- Screwdriver for slotted head screws
- Handle: Double shape handle that allows an optimum grip and maximum torque power. The hole in the handle permits the insertion of a T-bar for added force transmission
- Permanent colour codes at both ends of the handle, for a quick identification of the tip
- Blade: High performance alloy steel. Chrome plated and entirely hardened. Black finish tip for higher accuracy
- Branding: Size and part number laser branded on the blade for easier identification
- ISO 2380/DIN 5264
- Hexagon profile blade and bolster allows the use of a wrench for jobs that require more torque

	 841281		 mm	 mm	 mm	 mm	 mm	 g
020.040.100	4020419	10	4.0	0.8	100	100		48
020.055.125	4020518	10	5.5	1.0	125	115	9	90
020.065.150	4020617	10	6.5	1.2	150	130	11	143
020.080.175	4020815	10	8.0	1.6	175	145	14	243
020.100.200	4020105	10	10.0	1.6	200	145	14	254
020.120.250	4020129	10	12.0	2.0	250	145	18	372
020.140.250	4020143	10	14.0	2.5	250	145	18	372

021

SLOTTED SCREWDRIVER



- Screwdriver for slotted head screws
- Handle: Double shape handle that allows an optimum grip and maximum torque power. The hole in the handle permits the insertion of a T-bar for added force transmission
- Permanent colour codes at both ends of the handle, for a quick identification of the tip
- Blade: High performance alloy steel. Chrome plated and entirely hardened. Black finish tip for higher accuracy
- Branding: Size and part number laser branded on the blade for easier identification
- ISO 2380/DIN 5264

	 841281		 mm	 mm	 mm	 mm	 mm	 g
021.040.100	4021416	10	4.0	0.8	100	100		46
021.055.125	4021515	10	5.5	1.0	125	115	8	82
021.065.150	4021614	10	6.5	1.2	150	130	10	128
021.080.175	4021812	10	8.0	1.6	175	130	12	154
021.100.200	4021102	10	10.0	1.6	200	145	14	215



022

SLOTTED SCREWDRIVER



- Screwdriver for slotted head screws
- Handle: Double shape handle that allows an optimum grip and maximum torque power. The hole in the handle permits the insertion of a T-bar for added force transmission
- Permanent colour codes at both ends of the handle, for a quick identification of the tip
- Blade: High performance alloy steel. Chrome plated and entirely hardened. Black finish tip for higher accuracy
- Branding: Size and part number laser branded on the blade for easier identification
- ISO 2380/DIN 5264

	 841281		 mm	 mm	 mm	 mm	 mm	 g
022.030.100	4022314	10	3.0	0.5	100	100	39	
022.030.200	4022321	10	3.0	0.5	200	100	45	
022.035.100	4022338	10	3.5	0.6	100	100	41	
022.040.125	4022413	10	4.0	0.8	125	100	49	
022.040.250	4022420	10	4.0	0.8	250	100	61	
022.055.150	4022512	10	5.5	1.0	150	115	83	
022.055.300	4022529	10	5.5	1.0	300	115	116	
022.065.150	4022611	10	6.5	1.2	150	130	129	
022.065.300	4022628	10	6.5	1.2	300	130	167	

023

PHILLIPS SCREWDRIVER



- Screwdriver for Phillips head screws
- Handle: Double shape handle that allows an optimum grip and maximum torque power. The hole in the handle permits the insertion of a T-bar for added force transmission
- Permanent colour codes at both ends of the handle, for a quick identification of the tip
- Blade: High performance alloy steel. Chrome plated and entirely hardened. Black finish tip for higher accuracy
- Branding: Size and part number laser branded on the blade for easier identification
- ISO 8764/DIN 5260
- Hexagon profile blade and bolster allow the use of a wrench for jobs that require more torque

	 841281			 mm	 mm	 mm	 mm	 g
023.000.075	4023014	10	PH 0	75	100			45
023.001.100	4023113	10	PH 1	100	115	9		86
023.002.125	4023212	10	PH 2	125	130	11		137
023.003.150	4023311	10	PH 3	150	145	14		233
023.004.200	4023410	10	PH 4	200	145	14		338



024

PHILLIPS SCREWDRIVER



- Screwdriver for Phillips head screws
- Handle: Double shape handle that allows an optimum grip and maximum torque power. The hole in the handle permits the insertion of a T-bar for added force transmission
- Permanent colour codes at both ends of the handle, for a quick identification of the tip
- Blade: High performance alloy steel. Chrome plated and entirely hardened. Black finish tip for higher accuracy
- Branding: Size and part number laser branded on the blade for easier identification
- ISO 8764/DIN 5260

	 841281			 mm	 mm	 g
024.000.075	4024011	10	PH 0	75	100	38
024.001.100	4024110	10	PH 1	100	115	78
024.001.250	4024127	10	PH 1	250	115	98
024.002.125	4024219	10	PH 2	125	130	122
024.002.300	4024226	10	PH 2	300	130	156
024.003.150	4024318	10	PH 3	150	145	194

025

POZIDRIV SCREWDRIVER



- Screwdriver for Pozidriv head screws
- Handle: Double shape handle that allows an optimum grip and maximum torque power. The hole in the handle permits the insertion of a T-bar for added force transmission
- Permanent colour codes at both ends of the handle, for a quick identification of the tip
- Blade: High performance alloy steel. Chrome plated and entirely hardened. Black finish tip for higher accuracy
- Branding: Size and part number laser branded on the blade for easier identification
- ISO 8764
- Hexagon profile blade and bolster allow the use of a wrench for jobs that require more torque

	 841281			 mm	 mm	 mm	 g
025.000.075	4025018	10	PZ 0	75	100	-	45
025.001.100	4025117	10	PZ 1	100	115	9	86
025.002.125	4025216	10	PZ 2	125	130	11	137
025.003.150	4025315	10	PZ 3	150	145	14	233
025.004.200	4025414	10	PZ 4	200	145	14	338



026

POZIDRIV SCREWDRIVER



- Screwdriver for Pozidriv head screws
- Handle: Double shape handle that allows an optimum grip and maximum torque power. The hole in the handle permits the insertion of a T-bar for added force transmission
- Permanent colour codes at both ends of the handle, for a quick identification of the tip
- Blade: High performance alloy steel. Chrome plated and entirely hardened. Black finish tip for higher accuracy
- Branding: Size and part number laser branded on the blade for easier identification
- ISO 8764

	 841281			 mm	 mm	 g
026.000.075	4026015	10	PZ 0	75	100	175
026.001.100	4026114	10	PZ 1	100	115	75
026.001.250	4118758	10	PZ 1	250	115	98
026.002.125	4026213	10	PZ 2	125	130	118
026.002.300	4118741	10	PZ 2	300	130	156
026.003.150	4026312	10	PZ 3	150	145	191

027

TORX® SCREWDRIVER



- Screwdriver for TORX® head screws
- Handle: Double shape handle that allows an optimum grip and maximum torque power. The hole in the handle permits the insertion of a T-bar for added force transmission
- Permanent colour codes at both ends of the handle, for a quick identification of the tip
- Blade: High performance alloy steel. Chrome plated and entirely hardened. Black finish tip for higher accuracy
- Branding: Size and part number laser branded on the blade for easier identification
- Hexagon profile blade and bolster allow the use of a wrench for jobs that require more torque

	 841281			 mm	 mm	 mm	 g
027.006.075	4027067	10	T 6	75	100	-	38
027.007.075	4027074	10	T 7	75	100	-	38
027.008.075	4027081	10	T 8	75	100	-	38
027.009.075	4027098	10	T 9	75	100	-	38
027.010.075	4027104	10	T 10	75	100	-	38
027.015.100	4027159	10	T 15	100	100	-	48
027.020.100	4027203	10	T 20	100	100	-	48
027.025.125	4027258	10	T 25	125	115	9	90
027.027.125	4027272	10	T 27	125	115	9	90
027.030.150	4027302	10	T 30	150	130	11	143
027.040.150	4027401	10	T 40	150	145	14	233



028

TORX® SCREWDRIVER



- Screwdriver for TORX® and TORX® tamper resistant head screws
- Handle: Double shape handle that allows an optimum grip and maximum torque power. The hole in the handle permits the insertion of a T-bar for added force transmission
- Permanent colour codes at both ends of the handle, for a quick identification of the tip
- Blade: High performance alloy steel. Chrome plated and entirely hardened. Black finish tip for higher accuracy
- Branding: Size and part number laser branded on the blade for easier identification
- Hexagon profile blade and bolster allow the use of a wrench for jobs that require more torque

	 841281			 mm	 mm	 mm	 g
028.010.075	4028101	5	TR 10	75	100	-	38
028.015.100	4028156	5	TR 15	100	100	-	45
028.020.100	4028200	5	TR 20	100	100	-	45
028.025.125	4028255	5	TR 25	125	115	9	85
028.027.125	4028279	5	TR 27	125	115	9	85
028.030.150	4028309	5	TR 30	150	130	11	133
028.040.150	4028408	5	TR 40	150	145	14	195

029

HEXAGON BALL END SCREWDRIVER



- Screwdriver for hexagonal head screws, ball ended, easy to insert in the screw head from a range of angles. More efficient than the standard hex and time saver
- Handle: Double shape handle that allows an optimum grip and maximum torque power. The hole in the handle permits the insertion of a T-bar for added force transmission
- Permanent colour codes at both ends of the handle, for a quick identification of the tip
- Blade: High performance alloy steel. Chrome plated and entirely hardened. Black finish tip for higher accuracy
- Branding: Size and part number laser branded on the blade for easier identification
- Hexagon profile blade and bolster allow the use of a wrench for jobs that require more torque

	 841281		 mm	 mm	 mm	 mm	 g
029.020.100	4029207	10	2,0	100	100	-	38
029.025.100	4029252	10	2.5	100	100	-	38
029.030.100	4029306	10	4.5	100	100	-	64
029.040.100	4029405	10	4.0	100	100	-	53
029.050.100	4029504	10	5.0	100	115	9	92
029.060.125	4029603	10	6.0	125	130	11	141



030

NUT DRIVER WITH HANDLE



- Nut driver
- Handle: Double shape handle that allows an optimum grip and maximum torque power. The hole in the handle permits the insertion of a T-bar for added force transmission
- Permanent colour codes at both ends of the handle, for a quick identification of the tip
- Blade: High performance alloy steel. Chrome plated and entirely hardened
- Branding: Size and part number laser branded on the blade for easier identification

	 841281		 mm	 mm	 mm	 g
030.040.125	4030401	5	4.0	125	100	64
030.045.125	4030456	5	4.5	125	100	64
030.050.150	4030500	5	5.0	125	115	86
030.055.150	4030555	5	5.5	125	115	86
030.060.150	4030609	5	6.0	125	115	89
030.070.150	4030708	5	7.0	125	130	131
030.080.150	4030807	5	8.0	125	130	132
030.090.150	4030906	5	9.0	125	130	134
030.100.150	4030104	5	10.0	125	145	201
030.130.150	4030135	5	13.0	125	145	216
030.140.150	4030142	5	14.0	125	145	217

031

ROBERTSON (SQUARE) SCREWDRIVER



- Screwdriver for Robertson (square) head screws
- Handle: Double shape handle that allows an optimum grip and maximum torque power. The hole in the handle permits the insertion of a T-bar for added force transmission
- Permanent colour codes at both ends of the handle, for a quick identification of the tip
- Blade: High performance alloy steel. Chrome plated and entirely hardened. Black finish tip for higher accuracy
- Branding: Size and part number laser branded on the blade for easier identification

	 841281			 mm	 mm	 g
031.001.100	4031118	10	# 1	100	115	75
031.002.125	4031217	10	# 2	125	115	79
031.003.150	4031316	10	# 3	150	130	123

032.1/4

MAGNETIC BIT HOLDER



- Bit holder for 1/4" bits
- Handle: Double shape handle that allows an optimum grip and maximum torque power. The hole in the handle permits the insertion of a T-bar for added force transmission
- Permanent colour codes at both ends of the handle, for a quick identification of the tip
- Blade: High performance alloy steel
- Branding: Size and part number laser branded on the blade for easier identification

	 841281		 mm	 mm	 mm	 g
032.1/4.125	4032009	5	1/4"	125	130	130



032

FLEXIBLE BLADE BIT HOLDER



- Bit holder for 1/4" bits
- Handle: Double shape handle that allows an optimum grip and maximum torque power. The hole in the handle permits the insertion of a T-bar for added force transmission
- Permanent colour codes at both ends of the handle, for a quick identification of the tip
- Blade: Flexible blade. High performance alloy steel
- Branding: Size and part number laser branded on the blade for easier identification

032.001.125	841281	1	1/4"	125	130	130

037

FLEXIBLE SPINNER HANDLE 1/4"



- Spinner handle 1/4"
- Handle: Double shape handle that allows an optimum grip and maximum torque power. The hole in the handle permits the insertion of a T-bar for added force transmission
- Permanent colour codes at both ends of the handle, for a quick identification of the tip
- Blade: Flexible blade. High performance alloy steel
- Branding: Size and part number laser branded on the blade for easier identification

037.001.115	841281	1	1/4"	115	100	100

232

BIT HOLDER SET



- 1/4" bit holder with 30 bits
- Slotted, Phillips, Pozidriv, TORX®, hexagonal and Robertson bits
- In a metal case and clamshell packaging

232.030	841281	1	1183

032.1/4.125



59S/
0.5x3.0 - 0.6x4.5 - 0.8x5.5 - 1.0x5.5 - 1.2x6.5 - 1.2x8.0



59S/PH
PH0 - PH1 - PH2 - PH3 - PH4



59S/PZ
PZ0 - PZ1 - PZ2 - PZ3 - PZ4



59S/T
T10 - T15 - T20 - T25 - T30 - T40



59S/H
3 - 4 - 5 - 6



59S/R
#1 - #2 - #3 - #4





038

THROUGH BLADE SCREWDRIVERS



- Screwdriver for slotted head screws
- Handle: Double shape handle that allows an optimum grip and maximum torque power
- Permanent colour codes at both ends of the handle, for a quick identification of the tip
- Blade: High performance alloy steel. Chrome plated and entirely hardened. Black finish tip for higher accuracy
- Branding: Size and part number laser branded on the blade for easier identification
- ISO 2380/DIN 5264
- Hexagon profile blade and bolster allow the use of a wrench for jobs that require more torque
- The blade continues through the handle with no loss of hammer blow energy. Metallic cap gives protection during jobs requiring high impact

	 841281		 mm	 mm	 mm	 mm	 mm	 mm	 g
038.055.100	4038513	5	5.5	1.0	100	115	9	114	
038.065.125	4038612	5	6.5	1.2	125	130	11	164	
038.080.150	4038810	5	8.0	1.6	150	145	14	279	
038.100.175	4038100	5	10.0	1.6	175	145	14	290	
038.120.200	4038124	5	12.0	2.0	200	145	18	430	
038.140.200	4038148	5	14.0	2.5	200	145	18	430	

039

THROUGH BLADE SCREWDRIVERS



- Screwdriver for Phillips head screws
- Handle: Double shape handle that allows an optimum grip and maximum torque power
- Permanent colour codes at both ends of the handle, for a quick identification of the tip
- Blade: High performance alloy steel. Chrome plated and entirely hardened. Black finish tip for higher accuracy
- Branding: Size and part number laser branded on the blade for easier identification
- ISO 8764/DIN 5260
- Hexagon profile blade and bolster allow the use of a wrench for jobs that require more torque
- The blade continues through the handle with no loss of hammer blow energy. Metallic cap gives protection during jobs requiring high impact

	 841281			 mm	 mm	 mm	 mm	 g
039.001.100	4039114	5	PH1	100	115	9	114	
039.002.125	4039213	5	PH 2	125	130	11	182	
039.003.150	4039312	5	PH 3	150	145	14	316	
039.004.200	4039411	5	PH 4	200	145	14	430	



TEKNO+ SCREWDRIVERS

040

THROUGH BLADE SCREWDRIVERS



- Screwdriver for Pozidriv head screws
- Handle: Double shape handle that allows an optimum grip and maximum torque power
- Permanent colour codes at both ends of the handle, for a quick identification of the tip
- Blade: High performance alloy steel. Chrome plated and entirely hardened. Black finish tip for higher accuracy
- Branding: Size and part number laser branded on the blade for easier identification
- ISO 8764
- Hexagon profile blade and bolster allow the use of a wrench for jobs that require more torque
- The blade continues through the handle with no loss of hammer blow energy. Metallic cap gives protection during jobs requiring high impact

	 841281			 mm	 mm	 mm	 g
040.001.100	4040110	5	PZ1	100	115	9	114
040.002.125	4040219	5	PZ2	125	130	11	114
040.003.150	4040318	5	PZ3	150	145	14	316

202.020

THROUGH BLADE SCREWDRIVERS



- Tekno+ through blade screwdriver set, 6 pcs
- For slotted and Phillips head screws
- In cardboard box

	 841281		 g
202.020	4202204	1	1.342

038
5.5x100, 6.5x125, 8x150



039
PH1x100, PH2x125, PH3x150



202.021

THROUGH BLADE SCREWDRIVERS



- Tekno+ through blade screwdriver set, 6 pcs
- For slotted and Pozidriv head screws
- In cardboard box

	 841281		 g
202.021	4202211	1	1.342

038
5.5x100, 6.5x125, 8x150



040
PZ1x100, PZ2x125, PZ3x150





033

INSULATED SCREWDRIVERS



IEC 60900



- Insulated screwdriver for slotted head screws
- For work on live equipment, up to 1000 V
- Handle: Double shape handle that allows an optimum grip and maximum torque power. The hole in the handle permits the insertion of a T-bar for added force transmission
- Permanent colour codes at both ends of the handle, for a quick identification of the tip
- Blade: High performance alloy steel, insulation moulded directly onto blade. Black finish tip for higher accuracy
- ISO 2380/DIN 5264
- Individually inspected and manufactured according to IEC 60900

	 841281		 mm	 mm	 mm	 mm	 g
033.030.100	4033310	10	3.0	0.5	100	100	42
033.035.100	4033327	10	3.5	0.6	100	100	42
033.040.100	4033419	10	4.0	0.8	100	100	42
033.055.125	4033518	10	5.5	1.0	125	115	75
033.065.150	4033617	10	6.5	1.2	175	130	135
033.080.175	4033815	10	8.0	1.2	175	130	135
033.100.200	4033112	10	10.0	1.6	200	145	227

034

INSULATED SCREWDRIVERS



IEC 60900



- Insulated screwdriver for Phillips head screws
- For work on live equipment, up to 1000 V
- Handle: Double shape handle that allows an optimum grip and maximum torque power. The hole in the handle permits the insertion of a T-bar for added force transmission
- Permanent colour codes at both ends of the handle, for a quick identification of the tip
- Blade: High performance alloy steel, insulation moulded directly onto blade. Black finish tip for higher accuracy
- ISO 8764/DIN 5260
- Individually inspected and manufactured according to IEC 60900

	 841281			 mm	 mm	 g
034.000.100	4034010	10	PH 0	100	100	42
034.001.150	4034119	10	PH 1	150	115	91
034.002.175	4034218	10	PH 2	175	130	141
034.003.200	4034317	10	PH 3	200	145	228



035

INSULATED SCREWDRIVERS



- Insulated screwdriver for Pozidriv head screws
- For work on live equipment, up to 1000 V
- Handle: Double shape handle that allows an optimum grip and maximum torque power. The hole in the handle permits the insertion of a T-bar for added force transmission
- Permanent colour codes at both ends of the handle, for a quick identification of the tip
- Blade: High performance alloy steel, insulation moulded directly onto blade. Black finish for higher accuracy
- ISO 8764
- Individually inspected and manufactured according to IEC 60900

	 841281			 mm	 mm	 g
035.000.100	4035017	10	PZ 0	100	100	40
035.001.150	4035116	10	PZ 1	150	115	87
035.002.175	4035215	10	PZ 2	175	130	135
035.003.200	4035314	10	PZ 3	200	145	228

036

INSULATED SCREWDRIVERS



- Insulated nut driver
- For work on live equipment, up to 1000 V
- Handle: Double shape handle that allows an optimum grip and maximum torque power. The hole in the handle permits the insertion of a T-bar for added force transmission
- Permanent colour codes at both ends of the handle, for a quick identification of the tip
- Blade: High performance alloy steel, insulation moulded directly onto blade. Black finish for higher accuracy
- Individually inspected and manufactured according to IEC 60900

	 841281		 mm	 mm	 mm	 g
036.055.125	4036519	5	5.5	125	115	103
036.060.125	4036618	5	6.0	125	115	105
036.070.125	4036717	5	7.0	125	130	151
036.080.125	4036816	5	8.0	125	130	155
036.100.125	4036106	5	10.0	125	130	157
036.130.125	4036137	5	13.0	125	145	222



202.005

SCREWDRIVER SETS



- Tekno+ screwdriver set, 6 pcs
- For slotted and Phillips head screws
- In cardboard box

	 841281		 g
202.005	4202051	1	719

022 3.0x100, 4.0x125		
020 5.5x125, 6.5x150		
023 PH1x100, PH2x125		

202.006

SCREWDRIVER SETS

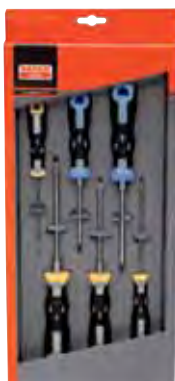

- Tekno+ screwdriver set, 6 pcs
- For slotted and Pozidriv head screws
- In cardboard box

	 841281		 g
202.006	4202068	1	719

022 3x100, 4x125		
020 5.5x125, 6.5x150		
025 PZ1x100, PZ2x125		

202.007

SCREWDRIVER SETS



- Tekno+ screwdriver set, 7 pcs
- For slotted and Phillips head screws
- In cardboard box

	 841281		 g
202.007	4202075	1	961

022 3.0x100, 4.0x125		
020 5.5x125, 6.5x150, 8x175		
023 PH1x100, PH2x125		



TEKNO+ SCREWDRIVERS

202.008

SCREWDRIVER SETS



- Tekno+ screwdriver set, 7 pcs
- For slotted and Pozidriv head screws
- In cardboard box

	 841281		 g
202.008	4202082	1	961

022 3x100, 4x125		
020 5.5x125, 6.5x150, 8x175		
025 PZ1x100, PZ2x125		



202.030

INSULATED SCREWDRIVER SETS



- Tekno+ insulated screwdriver set, 7 pcs
- For slotted and Phillips head screws
- In cardboard box

	 841281		 g
202.030	4202303	1	722

033 3x100, 4x100, 5.5x125, 6.5x150		
034 PH0x100, PH1x150, PH2x175		



202.031

INSULATED SCREWDRIVER SETS

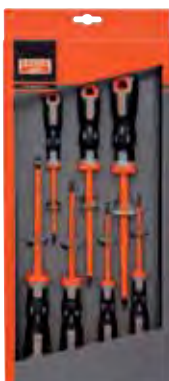

- Tekno+ insulated screwdriver set, 7 pcs
- For slotted and Pozidriv head screws
- In cardboard box

	 841281		 g
202.031	4202310	1	722

033 3x100, 4x100, 5.5x125, 6.5x150		
035 PZ0x100, PZ1x150, PZ2x175		





202.035

INSULATED SCREWDRIVER SETS



- Tekno+ insulated screwdriver set, 6 pcs + tester
- For slotted and Phillips head screws
- In cardboard box



	 841281		 g
202.035	4108742	1	675
033 3x100, 4x100, 5.5x125			
034 PH0x100, PH1x150, PH2x175			
806-1-2			

202.013

SETS IN ZIP CASE



- Tekno+ screwdriver set, 7 pcs
- For slotted and Phillips head screws
- In cardboard box and zip case



	 841281		 g
202.013	4121406	1	1.250
022 3x100, 4x125			
020 5.5x125, 6.5x150, 8x175			
023 PH1x100, PH2x125			

202.033

SETS IN ZIP CASE



- Tekno+ insulated screwdriver set, 7 pcs
- For slotted and Phillips head screws
- In cardboard box and zip case



	 841281		 g
202.033	4121376	1	1.000
033 3x100, 4x100, 5.5x125, 6.5x150			
034 PH0x100, PH1x150, PH2x175			



202.032

SETS IN ZIP CASE



- Tekno+ insulated screwdriver set, 7 pcs
- For slotted and Pozidriv head screws
- In cardboard box and zip case



	 841281		 9
202.032	4119298	1	1.000
033 3x100, 4x100, 5.5x125, 6.5x150			
035 PZ0x100, PZ1x150, PZ2x175			

350.011

INTERCHANGEABLE BLADES SET



- Tekno+ handle with interchangeable blades
- 11 blades, 22 tips; slotted, Phillips, Pozidriv, TORX®, hexagon
- In metal case and cramshaft packaging



	 841281		 9
350.011	4108032	1	1.457
351.130.140 - 351.155.165 3 - 4 - 5 - 6.5			
351.200.201 - 351.202.203 PH 0 - PH 1 - PH 2 - PH 3			
351.310.315 - 351.320.325 - 351.330.340 T 10 - T 15 - T 20 - T 25 - T 30 - T 40			
351.430.440 - 351.450.460 3 - 4 - 5 - 6			
351.500.501 - 351.502.503 PZ 0 - PZ 1 - PZ 2 - PZ 3			
351.000.000			



350.008.1

INTERCHANGEABLE BLADES WALLET



- Tekno+ handle with interchangeable blades
- 8 blades, 16 tips; slotted, Phillips, TORX®, hexagon
- In a leather wallet

	 841281		 g
350.008.1	4108070	1	637
351.130.140 - 351.155.165 3-4; 5.5-6.5 mm			
351.200.201 - 351.202.203 PH0-PH1; PH2-PH3			
351.310.315 - 351.320.325 T10-T15; T20-T25			
351.430.440 - 351.450.460 3-4; 5-6mm			
351.000.000			

350.008.2

INTERCHANGEABLE BLADES WALLET



- Tekno+ handle with interchangeable blades
- 8 blades, 16 tips; slotted, Pozidriv, TORX®, hexagon
- In a leather wallet

	 841281		 g
350.008.2	4108087	1	637
351.130.140 - 351.155.165 3-4; 5.5-6.5 mm			
351.500.501 - 351.502.503 PZ0-PZ1; PZ2-PZ3			
351.310.315 - 351.320.325 T10-T15; T20-T25			
351.430.440 - 351.450.460 3-4; 5-6 mm			
351.000.000			



800-SERIES SCREWDRIVERS

811

SLOTTED SCREWDRIVER



- Screwdriver for slotted head screws
- Handle: 2-component handle, with hanging hole and anti-roll design
- Easy identification of the tip, with the symbol marked on the domed end
- Blade: High performance alloy steel. Chrome plated and entirely hardened. Black finish tip for higher accuracy
- ISO 2380/DIN 5264
- SB: Retail packed

	 731415		 mm	 mm	 mm	 mm	 mm	 g
811-5,5-25	1845971	10	1.0	5.5	25	33x60	85	39
811-5,5-100	8013738	10	1.0	5.5	100	30x100	200	60
811-5,5-125	8013745	10	1.0	5.5	125	30x100	225	65
811-6,5-25	8013783	10	1.2	6.5	25	33x60	85	43
811-6,5-125	1845865	10	1.2	6.5	125	33x110	235	90
811-6,5-150	8013752	10	1.2	6.5	150	33x110	260	95
811-8-150	1845872	10	1.6	8.0	150	33x110	260	110
811-10-200	8013776	10	1.6	10.0	200	36x120	320	160
SB811-5,5-25	3001450	1	1.0	5.5	25	33x60	85	43
SB811-5,5-100	3001153	1	1.0	5.5	100	30x100	200	64
SB811-5,5-125	3001160	1	1.0	5.5	125	30x100	225	69
SB811-6,5-25	3001467	1	1.2	6.5	25	33x60	85	47
SB811-6,5-125	3001177	1	1.2	6.5	125	33x110	235	94
SB811-6,5-150	3001184	1	1.2	6.5	150	33x110	260	99
SB811-8-150	3001191	1	1.6	8.0	150	33x110	260	114
SB811-10-200	3001207	1	1.6	10.0	200	36x120	320	164

813

SLOTTED SCREWDRIVER



- Screwdriver for slotted head screws
- Handle: 2-component handle, with hanging hole and anti-roll design
- Easy identification of the tip, with the symbol marked on the domed end
- Blade: High performance alloy steel. Chrome plated and entirely hardened. Black finish tip for higher accuracy
- ISO 2380/DIN 5264
- SB: Retail packed

	 731415		 mm	 mm	 mm	 mm	 mm	 g
813-2,5-75	1845889	10	0.4	2.5	75	27x90	165	35
813-3-75	8013844	10	0.5	3.0	75	27x90	165	36
813-3-100	1845896	10	0.5	3.0	100	27x90	190	40
813-3,5-100	8013851	10	0.6	3.5	100	27x90	190	42
813-4-100	1845902	10	0.8	4.0	100	27x90	190	42
813-4-125	8013868	10	0.8	4.0	125	27x90	215	46
813-5,5-150	8013875	10	1.0	5.5	150	30x100	250	75
SB813-2,5-75	3001214	1	0.4	2.5	75	27x90	165	39
SB813-3-75	3001221	1	0.5	3.0	75	27x90	165	40
SB813-3-100	3001238	1	0.5	3.0	100	27x90	190	44
SB813-3,5-100	3001245	1	0.6	3.5	100	27x90	190	46
SB813-4-100	3001252	1	0.8	4.0	100	27x90	190	46
SB813-4-125	3001269	1	0.8	4.0	125	27x90	215	44
SB813-5,5-150	3001276	1	1.0	5.5	150	30x100	250	79



815

PHILLIPS SCREWDRIVER



- Screwdriver for Phillips head screws
- Handle: 2-component handle, with hanging hole and anti-roll design
- Easy identification of the tip, with the symbol marked on the domed end
- Blade: High performance alloy steel. Chrome plated and entirely hardened. Black finish tip for higher accuracy
- ISO 8764/DIN 5260
- SB: Retail packed

	 731415			 mm	 mm	 mm	 g
815-0-75	1845919	10	PH 0	75	27x90	165	36
815-1-25	8013967	10	PH 1	25	33x60	85	39
815-1-100	1845926	10	PH 1	100	30x100	200	60
815-2-25	8013974	10	PH 2	25	33x60	85	43
815-2-125	1845933	10	PH 2	125	33x110	235	90
815-3-150	8013943	10	PH 3	150	36x120	270	145
SB815-0-75	3001283	1	PH 0	75	27x90	165	40
SB815-1-25	3001474	1	PH 1	25	33x60	85	43
SB815-1-100	3001290	1	PH 1	100	30x100	200	64
SB815-2-25	3001481	1	PH 2	25	33x60	85	47
SB815-2-125	3001306	1	PH 2	125	33x110	235	94
SB815-3-150	3001313	1	PH 3	150	36x120	270	149

816

POZIDRIV SCREWDRIVER



- Screwdriver for Pozidriv head screws
- Handle: 2-component handle, with hanging hole and anti-roll design
- Easy identification of the tip, with the symbol marked on the domed end
- Blade: High performance alloy steel. Chrome plated and entirely hardened. Black finish tip for higher accuracy
- ISO 8764
- SB: Retail packed

	 731415			 mm	 mm	 mm	 g
816-0-75	1845940	10	PZ 0	75	27x90	165	36
816-1-25	8014032	10	PZ 1	25	33x60	85	39
816-1-100	1845957	10	PZ 1	100	30x100	200	60
816-2-25	8014049	10	PZ 2	25	33x60	85	43
816-2-125	1845964	10	PZ 2	125	33x110	235	90
816-3-150	8014018	10	PZ 3	150	36x120	270	145
SB816-0-75	3001320	1	PZ 0	75	27x90	165	40
SB816-1-100	3001337	1	PZ 1	100	30x100	200	64
SB816-2-25	3001504	1	PZ 2	25	33x60	85	47
SB816-2-125	3001344	1	PZ 2	125	33x110	235	94
SB816-3-150	3001351	1	PZ 3	150	36x120	270	149



800-SERIES SCREWDRIVERS

818

TORX® SCREWDRIVER



- Screwdriver for TORX® head screws
- Handle: 2-component handle, with hanging hole and anti-roll design
- Easy identification of the tip, with the symbol marked on the domed end
- Blade: High performance alloy steel. Chrome plated and entirely hardened. Black finish tip for higher accuracy
- SB: Retail packed

	 731415			 mm	 mm	 mm	 mm	 g
818-6-75	1846565	10	T 6	1.65	75	27x90	165	35
818-7-75	1845988	10	T 7	1.97	75	27x90	165	35
818-8-75	1845995	10	T 8	2.30	75	27x90	165	35
818-9-75	1846008	10	T 9	2.49	75	27x90	165	35
818-10-75	1846015	10	T 10	2.72	75	27x90	165	35
818-15-100	1846022	10	T 15	3.26	100	27x90	190	42
818-20-100	1846039	10	T 20	3.84	100	27x90	190	42
818-25-125	1846046	10	T 25	4.40	125	30x100	225	65
818-30-150	1846053	10	T 30	5.49	150	33x110	260	95
SB818-6-75	3001368	1	T 6	1.65	75	27x90	165	39
SB818-7-75	3001375	1	T 7	1.97	75	27x90	165	39
SB818-15-100	3001412	1	T 15	3.26	100	27x90	190	46
SB818-20-100	3001429	1	T 20	3.84	100	27x90	190	46

819

HEXAGON SCREWDRIVER



- Screwdriver for hexagon head screws. Ball-ended, easy to insert in the screw head from a range of angles. More efficient and time saving than standard hex driver
- Handle: 2-component handle, with hanging hole and anti-roll design
- Easy identification of the tip, with the symbol marked on the domed end
- Blade: High performance alloy steel. Chrome plated and entirely hardened. Black finish tip for higher accuracy
- SB: Retail packed

	 731415		 mm	 mm	 mm	 mm	 g
819-2-100	1846060	10	2	100	27x90	190	35
819-2,5-100	1846077	10	2.5	100	27x90	190	35
819-3-100	1846084	10	3	100	27x90	190	40
819-4-100	1846091	10	4	100	27x90	190	60
819-5-100	1846107	10	5	100	30x100	200	85
819-6-125	1846114	10	6	125	33x110	235	105
819-8-150	1846121	5	8	150	36x120	270	155



813VDE

INSULATED SCREWDRIVERS



IEC 60900 1000V D'E GS

- Insulated screwdriver for slotted head screws
- For work on live equipment, up to 1000 V
- Handle: 2-component handle, with hanging hole and anti-roll design
- Easy identification of the tip, with the symbol marked on the domed end
- Blade: High performance alloy steel, insulation moulded directly onto blade. Black finish tip for higher accuracy
- ISO 2380/DIN 5264
- Individually inspected and manufactured according to IEC 60900
- SB: Retail packed

	 731415		 mm	 mm	 mm	 mm	 mm	 mm	 g
813VDE-3-100	1846176	10	0.5	3.0	100	27x90	190	40	
813VDE-3,5-100	1846183	10	0.6	3.5	100	27x90	190	40	
813VDE-4-100	1846190	10	0.8	4.0	100	27x90	190	40	
813VDE-5,5-125	1846206	10	1.0	5.5	125	30x100	225	60	
813VDE-6,5-150	1846213	10	1.2	6.5	150	33x110	260	90	
813VDE-8-175	1846220	10	1.2	8.0	175	33x110	285	110	
813VDE-10-200	1846237	10	1.6	10.0	200	36x120	320	175	
813VDE-12-200	1846244	10	2.0	12.0	200	36x120	320	205	
SB813VDE-3-100	3001627	1	0.5	3.0	100	27x90	190	44	
SB813VDE-3,5-100	3001634	1	0.6	3.5	100	27x90	190	44	
SB813VDE-4-100	3001641	1	0.8	4.0	100	27x90	190	44	
SB813VDE-5,5-125	3001658	1	1.0	5.5	125	30x100	225	64	
SB813VDE-6,5-150	3001665	1	1.2	6.5	150	33x110	260	94	
SB813VDE-8-175	3001672	1	1.2	8.0	175	33x110	285	114	

815VDE

INSULATED SCREWDRIVERS



IEC 60900 1000V D'E GS

- Insulated screwdriver for Phillips head screws
- For work on live equipment, up to 1000 V
- Handle: 2-component handle, with hanging hole and anti-roll design
- Easy identification of the tip, with the symbol marked on the domed end
- Blade: High performance alloy steel, insulation moulded directly onto blade. Black finish tip for higher accuracy
- ISO 8764/DIN 5260
- Individually inspected and manufactured according to IEC 60900
- SB: Retail packed

	 731415			 mm	 mm	 mm	 mm	 g
815VDE-0-100	1846251	10	PH 0	100	27x90	190	40	
815VDE-1-150	1846268	10	PH 1	150	30x110	250	75	
815VDE-2-175	1846275	10	PH 2	175	33x110	285	110	
815VDE-3-200	1846282	10	PH 3	200	36x120	320	175	
815VDE-4-200	1846299	10	PH 4	200	36x120	320	205	
SB815VDE-0-100	3001702	1	PH 0	100	27x90	190	64	
SB815VDE-1-150	3001719	1	PH 1	150	30x110	250	79	
SB815VDE-2-175	3001726	1	PH 2	175	33x110	285	114	
SB815VDE-3-200	3001733	1	PH 3	200	36x120	320	179	



800-SERIES SCREWDRIVERS

816VDE

INSULATED SCREWDRIVERS



IEC 60900



- Insulated screwdriver for Pozidriv head screws
- For work on live equipment, up to 1000 V
- Handle: 2-component handle, with hanging hole and anti-roll design
- Easy identification of the tip, with the symbol marked on the domed end
- Blade: High performance alloy steel, insulation moulded directly onto blade. Black finish tip for higher accuracy
- ISO 8764
- Individually inspected and manufactured according to IEC 60900
- SB: Retail packed

	 731415			 mm	 mm	 mm	 g
816VDE-0-100	1846138	10	PZ 0	100	27x90	190	40
816VDE-1-150	1846145	10	PZ 1	150	30x110	250	75
816VDE-2-175	1846152	10	PZ 2	175	33x110	285	110
816VDE-3-200	1846169	10	PZ 3	200	36x120	320	175
SB816VDE-0-100	3001580	1	PZ 0	100	27x90	190	44
SB816VDE-1-150	3001597	1	PZ 1	150	30x110	250	79
SB816VDE-2-175	3001603	1	PZ 2	175	33x110	285	114

817V

INSULATED SCREWDRIVERS



IEC 60900



- Insulated nut driver
- For work on live equipment, up to 1000 V
- Handle: 2-component handle, with hanging hole and anti-roll design
- Easy identification of the tip, with the symbol marked on the domed end
- Blade: High performance alloy steel, insulation moulded directly onto blade
- Individually inspected and manufactured according to IEC 60900
- SB: Retail packed

	 731415		 mm	 mm	 mm	 mm	 g
817V-6	0128976	5	6	125	30x100	225	85
817V-7	0128983	5	7	125	33x110	235	120
817V-8	0128990	5	8	125	33x110	235	120
817V-10	0129003	5	10	125	36x120	245	145
817V-13	0129010	5	13	125	36x120	245	170



814

AWL



- Awl, for pre-punching and drilling holes
- Handle: 2-component handle, with hanging hole and anti-roll design
- Easy identification of the tip, with the symbol marked on the domed end
- Blade: High performance alloy steel. Chrome plated and entirely hardened
- SB: Retail packed

	 731415		\varnothing mm	 mm	 mm	 mm	 g
814-100	1846572	10	6.0	100	33x110	210	79
SB814-100	3001757	1	6.0	100	33x110	210	83

817

REAMER



- Reamer, for enlarging and drilling holes
- Handle: 2-component handle, with hanging hole and anti-roll design
- Easy identification of the tip, with the symbol marked on the domed end
- Blade: High performance alloy steel. Chrome plated and entirely hardened
- SB: Retail packed

	 731415		\varnothing mm	 mm	 mm	 mm	 g
817-100	8014254	10	6.0	100	33x110	210	79
SB817-100	3001764	1	6.0	100	33x110	210	83

800-4

SCREWDRIVER SETS



- 800-series screwdriver set, 4 pcs
- For slotted and Phillips head screws
- In cardboard box

	 731415		 g
800-4	1846497	1	354

813-
0.8x4x100 mm



811-
1.0x5.5x100 mm



815-
PH 1x100 PH 2x125





800-SERIES SCREWDRIVERS

804-6

SCREWDRIVER SETS



- 800-series screwdriver set, 6 pcs
- For slotted and Phillips head screws
- In cardboard box

	 731415		 g
804-6	1846510	1	360

813- 0.5x3x75 0.8x4x100 mm		
811- 1.0x5.5x100 1.2x6.5x125 mm		
815- PH 1x100 PH 2x125		

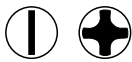

805-6

SCREWDRIVER SETS



- 800-series screwdriver set, 6 pcs
- For slotted, Phillips and Pozidriv head screws
- In cardboard box

	 731415		 g
805-6	0138685	1	450

813 3x75, 4x100		
815 1x100, 2x125		
816 1x100, 2x125		



806-6

SCREWDRIVER SETS



- 800-series screwdriver set, 6 pcs
- For slotted and Pozidriv head screws
- In cardboard box

	 731415		 g
806-6	1846527	1	492

813- 0.5x3x75 0.8x4x100 mm		
811- 1.0x5.5x100 1.2x6.5x125 mm		
816- PZ 1x100 PZ 2x125		





807-5



SCREWDRIVER SETS

- 800-series screwdriver set, 5 pcs
- For Pozidriv and TORX® head screws
- In cardboard box

	 731415		 g
807-5	3010704	1	287
816- PZ 1x100 PZ 2x125			
818- T10x75 T15x100 T25x125			

808-9



SCREWDRIVER SETS

- 800-series screwdriver set, 9 pcs
- For slotted and Phillips head screws
- In cardboard box

	 731415		 g
808-9	1846534	1	809
813- 0.5x3x75 0.8x4x100 mm			
811- 1.0x5.5x100 1.2x6.5x125 1.2x8x150 mm			
815- PH0x75 PH1x100 PH2x125 PH3x150			

808-10



SCREWDRIVER SETS

- 800-series screwdriver set, 10 pcs
- For slotted, Phillips, Pozidriv and TORX® head screws
- In cardboard box

	 731415		 g
808-10	3010797	1	630
813 3.5x100			
815 PH2x125			
816 PZ1x100, PZ 2x125			
816 PZ2x25			
818 T15x100, T20x100, T25x125			
814			



800-SERIES SCREWDRIVERS

810-5

SCREWDRIVER SETS



- 800-series screwdriver set, 5 pcs
- For TORX® head screws
- In cardboard box

	 731415		 g
810-5	1846541	1	397

818-
T10x75, T15x100, T20x100, T25x125, T30x150



820VDE

SCREWDRIVER SETS



- 800-series insulated screwdriver set, 5 pcs
- For slotted and Pozidriv head screws
- In cardboard box

	 731415		 g
820VDE-5	3001146	1	360

813VDE
3.5-100, 4-100, 6.5-150 mm



816VDE
PZ1-150, PZ2-175



822VDE

SCREWDRIVER SETS



- 800-series insulated screwdriver set, 5 pcs
- For slotted and Phillips head screws
- In cardboard box

	 731415		 g
822VDE-5	3002365	1	360

813VDE
3-100, 4-100, 5.5-125 mm



815VDE
PH1-150, PH2-175





190

SLOTTED SCREWDRIVER



- Screwdriver for slotted head screws
- Handle: Triangle shaped 2-component handle, with hanging hole. It is perfectly adapted to the forces exerted by the hand and permits to work efficiently
- Blade: High performance alloy steel. Chrome plated and entirely hardened. Vapour blasted tip for greater screw-tip adherence and full anti-rust guarantee
- Branding: Size and part number laser branded on the blade for easier identification
- ISO 2380/DIN 5264

	 841281		 mm	 mm	 mm	 mm	 g
190.040.075	4190419	10	4.0	0.8	75	88	44
190.040.100	4190426	10	4.0	0.8	100	88	46
190.055.100	4190518	10	5.5	1.0	100	100	67
190.055.125	4190525	10	5.5	1.0	125	100	73
190.065.125	4190617	10	6.5	1.2	125	110	98
190.065.150	4190624	10	6.5	1.2	150	110	105
190.080.150	4190815	10	8.0	1.6	150	110	119
190.080.175	4190822	10	8.0	1.6	175	110	126
190.100.200	4190112	10	10.0	1.6	200	120	175
190.120.250	4190129	10	12.0	2.0	250	120	228

191

SLOTTED SCREWDRIVER



- Screwdriver for slotted head screws
- Handle: Triangle shaped 2-component handle, with hanging hole. It is perfectly adapted to the forces exerted by the hand and permits to work efficiently
- Blade: High performance alloy steel. Chrome plated and entirely hardened. Vapour blasted tip for greater screw-tip adherence and full anti-rust guarantee
- Branding: Size and part number laser branded on the blade for easier identification
- ISO 2380/DIN 5264

	 841281		 mm	 mm	 mm	 mm	 g
191.025.075	4107486	10	2.5	0.4	75	75	26
191.030.075	4191317	10	3.0	0.5	75	75	27
191.030.100	4191324	10	3.0	0.5	100	75	28
191.030.200	4191331	10	3.0	0.5	200	75	38
191.035.100	4191348	10	3.5	0.6	100	75	31
191.040.100	4191416	10	4.0	0.8	100	88	46
191.040.125	4191423	10	4.0	0.8	125	88	48
191.040.250	4191430	10	4.0	0.8	250	88	67
191.055.125	4191515	10	5.5	1.0	125	100	81
191.055.150	4191522	10	5.5	1.0	150	100	82
191.055.300	4191539	10	5.5	1.0	300	100	113
191.065.150	4191614	10	6.5	1.2	150	110	111
191.065.300	4191621	10	6.5	1.2	300	110	153



PREMIUM SCREWDRIVERS

192

PHILLIPS SCREWDRIVER



- Screwdriver for Phillips head screws
- Handle: Triangle shaped 2-component handle, with hanging hole. It is perfectly adapted to the forces exerted by the hand and permits to work efficiently
- Blade: High performance alloy steel. Chrome plated and entirely hardened. Vapour blasted tip for greater screw-tip adherence and full anti-rust guarantee
- Branding: Size and part number laser branded on the blade for easier identification
- ISO 8764/DIN 5260

	 841281			 mm	 mm	 g
192.000.075	4192000	10	PH 0	75	75	27
192.000.200	4192055	10	PH 0	200	75	38
192.001.100	4192017	10	PH 1	100	100	67
192.001.250	4192154	10	PH 1	250	100	96
192.002.125	4192024	10	PH 2	125	100	99
192.002.300	4192253	10	PH 2	300	110	127
192.003.150	4192031	10	PH 3	150	120	157
192.004.200	4192048	10	PH 4	200	120	202

193

POZIDRIV SCREWDRIVER



- Screwdriver for Pozidriv head screws
- Handle: Triangle shaped 2-component handle, with hanging hole. It is perfectly adapted to the forces exerted by the hand and permits to work efficiently
- Blade: High performance alloy steel. Chrome plated and entirely hardened. Vapour blasted tip for greater screw-tip adherence and full anti-rust guarantee
- Branding: Size and part number laser branded on the blade for easier identification
- ISO 8764

	 841281			 mm	 mm	 g
193.000.075	4193007	10	PZ 0	75	75	27
193.001.100	4193014	10	PZ 1	100	100	67
193.002.125	4193021	10	PZ 2	125	110	99
193.003.150	4193038	10	PZ 3	150	120	157
193.004.200	4193045	10	PZ 4	200	120	202



194

TORX® SCREWDRIVER



- Screwdriver for TORX® head screws
- Handle: Triangle shaped 2-component handle, with hanging hole. It is perfectly adapted to the forces exerted by the hand and permits to work efficiently
- Blade: High performance alloy steel. Chrome plated and entirely hardened. Vapour blasted tip for greater screw-tip adherence and full anti-rust guarantee
- Branding: Size and part number laser branded on the blade for easier identification

	 841281			 mm	 mm	 g
194.004.075	4194042	10	T 4	75	75	27
194.005.075	4194059	10	T 5	75	75	27
194.006.075	4194066	10	T 6	75	75	27
194.007.075	4194073	10	T 7	75	75	27
194.008.075	4194080	10	T 8	75	75	27
194.009.075	4194097	10	T 9	75	75	27
194.010.075	4194103	10	T 10	75	75	27
194.015.100	4194158	10	T 15	100	88	46
194.020.100	4194202	10	T 20	100	88	46
194.025.125	4194257	10	T 25	125	100	73
194.027.125	4194271	10	T 27	125	100	73
194.030.150	4194301	10	T 30	150	110	105
194.040.150	4194400	10	T 40	150	110	120

141

TAMPER RESISTANT TORX® SCREWDRIVER



- Screwdriver for TORX® and TORX® tamper resistant head screws
- Handle: Triangle shaped 2-component handle, with hanging hole. It is perfectly adapted to the forces exerted by the hand and permits to work efficiently
- Blade: High performance alloy steel. Chrome plated and entirely hardened. Vapour blasted tip for greater screw-tip adherence and full anti-rust guarantee
- Branding: Size and part number laser branded on the blade for easier identification

	 841281			 mm	 mm	 g
141.007.075	4141077	5	TR 7	75	75	27
141.008.075	4141084	5	TR 8	75	75	27
141.009.075	4141091	5	TR 9	75	75	27
141.010.075	4141107	5	TR 10	75	75	27
141.015.100	4141152	5	TR 15	100	88	46
141.020.100	4141206	5	TR 20	100	88	46
141.025.125	4141251	5	TR 25	125	100	73
141.027.125	4141275	5	TR 27	125	100	73
141.030.150	4141305	5	TR 30	150	110	105
141.040.150	4141404	5	TR 40	150	110	120



PREMIUM SCREWDRIVERS

195

STUBBY SCREWDRIVERS



- Screwdriver for Phillips head screws, stubby type, for working in confined spaces
- Handle: 2-component handle, with hanging hole
- Blade: High performance alloy steel. Chrome plated and entirely hardened. Vapour blasted tip for greater screw-tip adherence and full anti-rust guarantee
- Branding: Size and part number laser branded on the blade for easier identification

	 84128			 mm	 mm	 g
195.001.025	4195001	10	PH 1	25	60	39
195.002.025	4195025	10	PH 2	25	60	43

195

STUBBY SCREWDRIVERS



- Screwdriver for slotted head screws, stubby type, for working in confined spaces
- Handle: 2-component handle, with hanging hole
- Blade: High performance alloy steel. Chrome plated and entirely hardened. Vapour blasted tip for greater screw-tip adherence and full anti-rust guarantee
- Branding: Size and part number laser branded on the blade for easier identification

	 841281		 mm	 mm	 mm	 mm	 mm	 g
195.055.025	4107523	10	5.5	1.2	25	60	39	
195.060.025	4195612	10	6.5	1.2	25	60	43	

195

STUBBY SCREWDRIVERS



- Screwdriver for Pozidriv head screws, stubby type, for working in confined spaces
- Handle: 2-component handle, with hanging hole
- Blade: High performance alloy steel. Chrome plated and entirely hardened. Vapour blasted tip for greater screw-tip adherence and full anti-rust guarantee
- Branding: Size and part number laser branded on the blade for easier identification

	 841281			 mm	 mm	 g
195.901.025	4195919	10	PZ 1	25	60	39
195.902.025	4195926	10	PZ 2	25	60	43



143

HEXAGON BALL END SCREWDRIVER



- Screwdriver for hexagonal head screws, ball-ended, easy to insert in the screw head from a range of angles. More efficient than the standard hex and time saver
- Handle: 2-component handle, with hanging hole. It is perfectly adapted to the forces exerted by the hand and permits to work efficiently
- Blade: High performance alloy steel. Chrome plated and entirely hardened. Vapour blasted tip for greater screw-tip adherence and full anti-rust guarantee
- Branding: Size and part number laser branded on the blade for easier identification

	 841281			 mm	 mm	 g
143.025.100	4143255	10	2.5	100	75	28
143.030.100	4143309	10	3.0	100	75	31
143.040.100	4143408	10	4.0	100	88	54
143.050.100	4143507	10	5.0	100	100	77
143.060.125	4143606	10	6.0	125	110	111

198

NUT DRIVER WITH HANDLE



- Nut driver
- Handle: 2-component handle, with hanging hole. It is perfectly adapted to the forces exerted by the hand and permits to work efficiently
- Blade: High performance alloy steel. Chrome plated and entirely hardened
- Branding: Size and part number laser branded on the blade for easier identification

	 841281		 mm	 mm	 mm	 g
198.032.125	4198323	5	3,2	125	88	64
198.040.125	4198415	10	4.0	125	88	67
198.045.125	4198422	10	4.5	125	88	69
198.050.150	4198514	5	5.0	150	100	86
198.055.150	4198521	5	5.5	150	100	85
198.060.150	4198613	5	6.0	150	100	88
198.070.150	4198712	5	7.0	150	110	120
198.080.150	4198811	5	8.0	150	110	124
198.090.150	4198910	5	9.0	150	110	124
198.100.150	4198101	5	10.0	150	110	169
198.110.150	4198118	5	11.0	150	120	182
198.120.150	4198125	5	12.0	150	120	183
198.130.150	4198132	5	13.0	150	120	184
198.140.150	4198149	5	14.0	150	120	185



PREMIUM SCREWDRIVERS

705

MAGNETIC BIT HOLDER



- Magnetic bit holder for 1/4" bits
- Handle: 2-component handle, with hanging hole. It is perfectly adapted to the forces exerted by the hand and permits to work efficiently
- Blade: High performance alloy steel
- Branding: Size and part number laser branded on the blade for easier identification

705.1/4.125	841281	5	1/4"	125	110	235

196

INSULATED SCREWDRIVERS



- Insulated screwdriver for slotted head screws
- For work on live equipment, up to 1000 V
- Handle: Triangle shaped 2-component handle, with hanging hole. It is perfectly adapted to the forces exerted by the hand and permits to work efficiently
- Blade: High performance alloy steel, insulation moulded directly onto blade. Black finish tip for higher accuracy
- Branding: Size and part number laser branded on the blade for easier identification
- ISO 2380/DIN 5264
- Individually inspected and manufactured according to IEC 60900

	841281		mm	mm	mm	mm	g
196.025.100	4107516	10	2.5	0.4	100	75	28
196.030.100	4196312	10	3.0	0.5	100	75	31
196.035.100	4196329	10	3.5	0.6	100	75	31
196.040.100	4196411	10	4.0	0.8	100	88	43
196.055.125	4196510	10	5.5	1.0	125	100	68
196.065.150	4196619	10	6.5	1.2	150	110	100
196.080.175	4196817	10	8.0	1.2	175	110	118
196.100.200	4196114	10	10.0	1.6	200	120	191
196.120.200	4196121	10	12.0	2.0	200	120	217



197

INSULATED SCREWDRIVERS



IEC 60900 1000V DE GS

- Insulated screwdriver for Phillips head screws
- For work on live equipment, up to 1000 V
- Handle: Triangle shaped 2-component handle, with hanging hole. It is perfectly adapted to the forces exerted by the hand and permits to work efficiently
- High performance alloy steel, insulation moulded directly onto blade. Black finish tip for higher accuracy
- Branding: Size and part number laser branded on the blade for easier identification
- ISO 8764/DIN 5260
- Individually inspected and manufactured according to IEC 60900

	 841281			 mm	 mm	 g
197.000.100	4197005	10	PH 0	100	75	31
197.001.150	4197012	10	PH 1	150	100	84
197.002.175	4197029	10	PH 2	175	110	121
197.003.200	4197036	10	PH 3	200	120	190
197.004.200	4197043	10	PH 4	200	120	218

142

INSULATED SCREWDRIVERS



IEC 60900 1000V DE GS

- Insulated screwdriver for Pozidriv head screws
- For work on live equipment, up to 1000 V
- Handle: Triangle shaped 2-component handle, with hanging hole. It is perfectly adapted to the forces exerted by the hand and permits to work efficiently
- High performance alloy steel, insulation moulded directly onto blade. Black finish tip for higher accuracy
- Branding: Size and part number laser branded on the blade for easier identification
- ISO 8764
- Individually inspected and manufactured according to IEC 60900

	 841281			 mm	 mm	 g
142.000.100	4142098	10	PZ 0	100	75	31
142.001.150	4142012	10	PZ 1	150	100	84
142.002.175	4142029	10	PZ 2	175	110	122
142.003.200	4142036	10	PZ 3	200	120	190



PREMIUM SCREWDRIVERS

199

INSULATED SCREWDRIVERS



- Insulated nut driver
- For work on live equipment, up to 1000 V
- Handle: Triangle shaped 2-component handle, with hanging hole. It is perfectly adapted to the forces exerted by the hand and permits to work efficiently
- High performance alloy steel, insulation moulded directly onto blade. Black finish tip for higher accuracy
- Branding: size and part number laser branded on the blade for easier identification
- Individually inspected and manufactured according to IEC 60900

	 841281		 mm	 mm	 mm	 g
199.050.125	4108759	5	5,0	125	100	101
199.055.125	4199511	5	5.5	125	100	101
199.060.125	4199610	5	6.0	125	100	127
199.070.125	4199719	5	7.0	125	110	151
199.080.125	4199818	5	8.0	125	110	142
199.090.125	4199917	5	9.0	125	110	142
199.100.125	4199108	5	10.0	125	110	142
199.110.125	4199115	5	11.0	125	120	181
199.120.125	4199122	5	12.0	125	120	183
199.130.125	4199139	5	13.0	125	120	188

219.100

SCREWDRIVER SETS



- Premium screwdriver set, 6 pcs
- For slotted and Phillips head screws
- In clamshell packaging

	 841281		 g
219.100	4219103	1	412
190 5.5x125, 6.5x125			
191 3.5x100, 4.0x125			
192 PH0x75, PH1x100			



219.101

SCREWDRIVER SETS

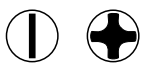

- Premium screwdriver set, 6 pcs
- For slotted and Phillips head screws
- In clamshell packaging

	 841281		 g
219.101	4219110	1	412
190 6.5x125, 8.0x150			
191 3.5x100, 4.0x125, 5.5x150			
192 PH1x100, PH2x125			

219.102

SCREWDRIVER SETS

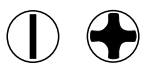

- Premium screwdriver set, 8 pcs
- For slotted and Phillips head screws
- In clamshell packaging

	 841281		 g
219.102	4219127	1	598
190 5.5x125, 6.5x125, 8x150			
192 PH0x75, PH1x100, PH2x125			
		195 6.5x25	
		195 PH2x25	

219.105

SCREWDRIVER SETS



- Premium screwdriver set, 7 pcs
- For slotted and Pozidriv head screws
- In clamshell packaging

	 841281		 g
219.105	4107837	1	717
190 6.5x125, 8.0x150			
191 3.5x100, 4.0x125, 5.5x150			
193 PZ1x100, PZ2x125			



PREMIUM SCREWDRIVERS

219.109

SCREWDRIVER SETS

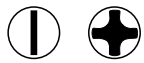

- Premium screwdriver set, 5 pcs
- For slotted and Phillips head screws
- In clamshell packaging

	 841281		 g
219.109	4219196	1	438

190 4x100, 6.5x125		
191 3.5x100		
192 PH1x100, PH2x125		

219.110

SCREWDRIVER SETS



- Premium screwdriver set, 5 pcs
- For TORX® head screws
- In clamshell packaging

	 841281		 g
219.110	4219134	1	438

194 T10, T20, T25, T30, T40		
--------------------------------	--	--

219.000

SCREWDRIVER SETS



- Premium screwdriver set, 6 pcs
- For slotted and Phillips head screws
- In cardboard packaging

	 841281		 g
219.000	4219004	1	536

190 5.5x125, 6.5x125		
191 3.5x100, 4.0x125		
192 PH0x75, PH1x100		



219.001

SCREWDRIVER SETS



- Premium screwdriver set, 7 pcs
- For slotted and Phillips head screws
- In cardboard packaging

	 841281		 g
219.001	4219011	1	717
190 6.5x125, 8.0x150			
191 3.5x100, 4.0x125, 5.5x150			
192 PH1x100, PH2x125			

219.002

SCREWDRIVER SETS

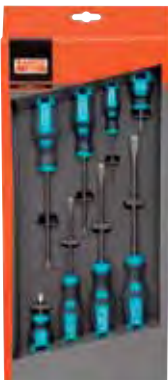

- Premium screwdriver set, 8 pcs
- For slotted and Phillips head screws
- In cardboard packaging

	 841281		 g
219.002	4219028	1	788
190 5.5x125, 6.5x125, 8x150			195 6.5x25
192 PH0x75, PH1x100, PH2x125			195 PH2x25

219.003

SCREWDRIVER SETS

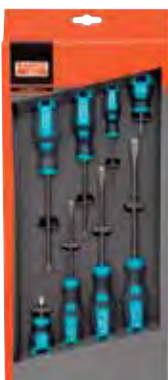

- Premium screwdriver set, 8 pcs
- For slotted, Phillips and Pozidriv head screws
- In cardboard packaging

	 841281		 g
219.003	4109503	1	788
190 5.5x125, 6.5x125, 8.0x150			195 PH2x25
193 PZ0x75, PZ1x100, PZ2x125			195 6.5x25



PREMIUM SCREWDRIVERS

219.005

SCREWDRIVER SETS



- Premium screwdriver set, 7 pcs
- For slotted and Pozidriv head screws
- In cardboard packaging



	 841281		 g
219.005	4121147	1	717
190 6.5x125, 8.0x150			
191 3.5x100, 4.0x125, 5.5x150			
193 PZ1x100, PZ2x125			

219.600

INSULATED SCREWDRIVER SETS



- Premium insulated screwdriver set, 7 pcs
- For slotted and Phillips head screws
- In cardboard packaging



	 841281		 g
219.600	4219608	1	717
196 3x100, 4x100, 5.5x125, 6.5x150			
197 PH0x100, PH1x150, PH2x175			

219.605

INSULATED SCREWDRIVER SETS



- Premium insulated screwdriver set, 7 pcs
- For slotted and Pozidriv head screws
- In cardboard packaging



	 841281		 g
219.605	4219653	1	717
196 3x100, 4x100, 5.5x125, 6.5x150			
142 PZ0x100, PZ1x150, PZ2x175			



219.601

INSULATED SCREWDRIVER SETS



- Premium insulated screwdriver set, 6 pcs + tester
- For slotted and Phillips head screws
- In cardboard packaging



	 841281		 g
219.601	4107820	1	638
196			
3x100, 4x100, 5.5x125			
197			
PH0x100, PH1x150, PH2x175			
806-1-1			

219.602

PREMIUM SETS IN ZIP CASE



- Premium insulated screwdriver set, 7 pcs
- For slotted and Pozidriv head screws
- In cardboard box and zip case



	 841281		 g
219.602	4119304	1	900
196			
3x100, 4x100, 5.5x125, 6.5x150			
142			
PZ0x100, PZ1x150, PZ2x175			



600-SERIES SCREWDRIVERS

611

SLOTTED SCREWDRIVER



- Screwdriver for slotted head screws
- Handle: 2-component handle with hanging hole. Perfect handle-blade joint
- Blade: High quality steel. Nickel plated and entirely hardened
- Branding: Size and part number marked on the handle
- ISO 2380/DIN 5264



	 731415		 mm	 mm	 mm	 mm	 mm	 g
611-3.5-50	0124312	10	0.6	3.5	50	80	130	29
611-3.5-75	0124329	10	0.6	3.5	50	80	130	30
611-3.5-100	0124336	10	0.6	3.5	100	80	130	31
611-4-75	0124343	10	0.8	4.0	75	80	155	35
611-4-100	0124350	10	0.8	4.0	100	80	180	37
611-5.5-125	0124381	10	1.0	5.5	100	97	197	68
611-6.5-25	0124602	10	1.2	6.5	125	110	135	43
611-6.5-125	0124374	10	1.2	6.5	125	110	135	100
611-6.5-150	0124398	10	1.2	6.5	150	110	165	103
611-8-150	0124404	10	1.2	8.0	150	110	160	115
611-8-175	0124411	10	1.2	8.0	175	110	185	127
611-10-200	0124428	10	1.6	10.0	200	110	310	160

613

SLOTTED SCREWDRIVER



- Screwdriver for slotted head screws
- Handle: 2-component handle with hanging hole. Perfect handle-blade joint
- Blade: High quality steel. Nickel plated and entirely hardened
- Branding: Size and part number marked on the handle
- ISO 2380/DIN 5264



	 731415		 mm	 mm	 mm	 mm	 mm	 g
613-3-75	0124435	10	0.5	3.0	75	80	155	30
613-3-100	0124442	10	0.5	3.0	100	80	180	31
613-3.5-100	0124459	10	0.60	3.5	100	80	180	33
613-4-100	0124466	10	0.80	4.0	100	80	180	37
613-4-125	0124473	10	0.80	4.0	125	80	205	41
613-5.5-125	0124480	10	1.0	5.5	125	97	222	73
613-5.5-150	0124497	10	1.0	5.5	150	97	247	78
613-6.5-150	0124503	10	1.20	6.5	150	110	260	110

615

PHILLIPS SCREWDRIVER



- Screwdriver for Phillips head screws
- Handle: 2-component handle with hanging hole. Perfect handle-blade joint
- Blade: High quality steel. Nickel plated and entirely hardened
- Branding: Size and part number marked on the handle
- ISO 8764/DIN 5260



	 731415			 mm	 mm	 mm	 g
615-0-75	0124558	10	PH 0	75	80	155	30
615-1-100	0124565	10	PH 1	100	97	197	63
615-2-25	0124596	10	PH 2	25	60	85	43
615-2-125	0124572	10	PH 2	125	110	235	98
615-3-150	0124589	10	PH 3	150	110	260	113



616

POZIDRIV SCREWDRIVER



- Screwdriver for Pozidriv head screws
- Handle: 2-component handle with hanging hole. Perfect handle-shank joint
- Blade: High quality steel. Nickel plated and entirely hardened
- Branding: Size and part number marked on the handle
- ISO 8764

	 731415			 mm	 mm	 mm	 g
616-0-75	0124510	10	PZ 0	75	80	155	30
616-1-100	0124527	10	PZ 1	100	97	197	63
616-2-125	0124534	10	PZ 2	125	110	235	98
616-3-150	0124541	10	PZ 3	150	110	260	113

618

TORX® SCREWDRIVER



- Screwdriver for TORX® head screws
- Handle: 2-component handle with hanging hole. Perfect handle-blade joint
- Blade: High quality steel. Nickel plated and entirely hardened
- Branding: Size and part number marked on the handle

	 731415			 D mm	 mm	 mm	 mm	 g
618-10-75	0124619	10	T 10	2.72	75	80	155	30
618-15-100	0124626	10	T 15	3.26	100	80	180	37
618-20-100	0124633	10	T 20	3.84	100	80	180	37
618-25-125	0124640	10	T 25	4.40	125	97	222	68
618-27-125	0124657	10	T 27	4.96	125	97	222	68
618-30-150	0124664	10	T 30	5.49	150	110	260	103
618-40-150	0124671	10	T 40	6.60	150	110	260	115

614

AWL SCREWDRIVER



- Awl, for pre-punching and drilling holes
- Handle: 2-component handle with hanging hole. Perfect handle-blade joint
- Blade: High quality steel. Nickel plated and entirely hardened
- Branding: Size and part number marked on the handle

	 731415		 mm	 mm	 mm	 mm	 g
614-100	0124688	10	6.0	100	97	197	92



600-SERIES SCREWDRIVERS

617

REAMER SCREWDRIVER



- Reamer, for enlarging and drilling holes
- Handle: 2-component handle with hanging hole. Perfect handle-blade joint
- Blade: High quality steel. Nickel plated and entirely hardened
- Branding: Size and part number marked on the handle

	 731415		 mm	 mm	 mm	 mm	 g
617-100	0124695	10	6.0	100	97	197	92

623

INSULATED SCREWDRIVERS



- Insulated screwdriver for slotted head screws
- For work on live equipment, up to 1000 V
- Handle: 2-component handle with hanging hole. Perfect handle-blade joint
- Blade: High quality steel, insulation moulded directly onto blade. Black finish tip for higher accuracy
- Branding: Size and part number marked on the handle
- ISO 2380/DIN 5264
- Individually inspected and manufactured according to IEC 60900

	 731415		 mm	 mm	 mm	 mm	 mm	 g
623-3-100	0128518	10	0.5	3.0	100	80	180	32
623-3.5-100	0128525	10	0.6	3.5	100	80	180	32
623-4-100	0128532	10	0.8	4.0	100	80	180	33
623-5.5-125	0128549	10	1.0	5.5	125	97	223	61
623-6.5-150	0128556	10	1.2	6.5	150	100	250	94

625

INSULATED SCREWDRIVERS



- Insulated screwdriver for Phillips head screws
- For work on live equipment, up to 1000 V
- Handle: 2-component handle with hanging hole. Perfect handle-blade joint
- Blade: High quality steel, insulation moulded directly onto blade. Black finish tip for higher accuracy
- Branding: Size and part number marked on the handle
- ISO 8764/DIN 5260
- Individually inspected and manufactured according to IEC 60900

	 731415			 mm	 mm	 mm	 g
625-0-100	0128563	10	PH 0	100	80	180	32
625-1-150	0128570	10	PH 1	150	97	247	68
625-2-175	0128587	10	PH 2	175	110	285	116



600-3

SCREWDRIVER SETS



- 600 series screwdriver set, 3 pcs
- For slotted and Phillips head screws
- In clamshell packaging

	 731415		 g
600-3	0124787	1	210

613 3x100		
611 5.5x125		
615 PH1x100		



602-4

SCREWDRIVER SETS



- 600 series screwdriver set, 4 pcs
- For slotted and Phillips head screws
- In clamshell packaging

	 731415		 g
602-4	0124794	1	315

613 3x100, 6.5x150		
611 5.5x125		
615 PH1x100		

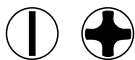

604-5

SCREWDRIVER SETS



- 600 series screwdriver set, 5 pcs
- For slotted and Phillips head screws
- In clamshell packaging

	 731415		 g
604-5	0124800	1	385

613 3x100		
611 4x100, 6.5x125		
615 PH1x100, PH2x125		





600-SERIES SCREWDRIVERS

605-6

SCREWDRIVER SETS



- 600 series screwdriver set, 6 pcs
- For slotted, Phillips and Pozidriv head screws
- In clamshell packaging



	 731415		 g
605-6	0153770	1	445
613 3x75, 4x100			
615 PH1x100, PH2x125			
616 PZ1x100, PZ2x125			

606-6

SCREWDRIVER SETS



- 600 series screwdriver set, 6 pcs
- For slotted and Phillips head screws
- In clamshell packaging



	 731415		 g
606-6	0124824	1	445
611 5.5x100, 6.5x125			
613 3x75, 4x100			
615 PH1x100, PH2x125			

608-6

SCREWDRIVER SETS



- 600 series screwdriver set, 6 pcs
- For slotted and Phillips head screws
- In clamshell packaging



	 731415		 g
608-6	0124831	1	385
611 5.5x100, 6.5x125			
613 3.0x75, 4.0x100			
615 PH0x75, PH1x100			



610-6

SCREWDRIVER SETS



- 600 series screwdriver set, 6 pcs
- For slotted and Pozidriv head screws
- In clamshell packaging

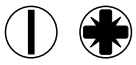

	 731415		 g
610-6	0124848	1	445
611 5.5x100, 6.5x125			
613 3.0x75, 4.0x100			
616 PZ1x100, PZ2x125			

612-5

SCREWDRIVER SETS



- 600 series screwdriver set, 5 pcs
- For TORX® head screws
- In clamshell packaging



	 731415		 g
612-5	0124817	1	348
618 T10, T15, T20, T25, T30			

620-6

SCREWDRIVER SETS



- 600 series insulated screwdriver set, 6 pcs
- For slotted and Phillips head screws
- In clamshell packaging



	 731415		 g
620-6	0128594	1	465
623 3x100, 4x100, 5.5x125, 6.5x150			
625 PH1x150, PH2x175			



9000-SERIES SCREWDRIVERS

9710

FLAT SCREWDRIVER



- Screwdriver for slotted head screws
- Handle: Lacquered wooden handle
- Blade: High quality steel. Bright chrome plated. Black finish tip for higher accuracy. Blade extending through handle and hexagon collar for wrench assisted turning. With impact cap and ferrule
- Branding: Size and part number marked on the handle
- ISO 2380/DIN 5264

	731415		mm	mm	mm	mm	mm	mm	g
9710-3.5-75	1785192	10	0.6	3.5	75	22x95	170	7	47
9710-5.5-100	1785352	10	1.0	5.5	100	24x100	200	8	67
9710-6.5-125	1785437	10	1.2	6.5	125	27x110	235	10	114
9710-8-150	1785512	5	1.2	8.0	150	30x120	270	13	174
9710-10-175	1785789	5	1.6	10.0	175	32x125	300	13	223

9778

PHILLIPS SCREWDRIVER



- Screwdriver for Phillips head screws
- Handle: Lacquered wooden handle
- Blade: High quality steel. Bright chrome plated. Black finish tip for higher accuracy. Blade extending through handle and hexagon collar for wrench assisted turning. With impact cap and ferrule
- Branding: Size and part number marked on the handle
- ISO 8764/DIN 5260

	731415			mm	mm	mm	mm	g
9778-1	1793524	10	PH 1	80	24x100	180	6	45
9778-2	1793531	10	PH 2	110	27x110	220	10	90
9778-3	1793548	5	PH 3	150	30x120	270	13	160

9778PZD

POZIDRIV SCREWDRIVER



- Screwdriver for Pozidriv head screws
- Handle: Lacquered wooden handle
- Blade: High quality steel. Bright chrome plated. Black finish tip for higher accuracy. Blade extending through handle and hexagon collar for wrench assisted turning. With impact cap and ferrule
- Branding: Size and part number marked on the handle
- DIN ISO 8764-1, ISO 8764-1

	731415			mm	mm	mm	mm	g
9778PZD-1	1823535	10	PZ 1	80	24x100	180	6	45
9778PZD-2	1823542	10	PZ 2	110	27x110	220	10	90



9710/S6

SCREWDRIVER SETS



- Screwdriver set, 6 pcs
- For slotted and Phillips head screws
- In cardboard box

	 731415		 9
9710/S6	1802301	1	650

9710
0.8x4.5x90 1x5.5x100 1.2x6.5x125 1.2x8x150 mm



9778
PH 1x80 PH 2x110



8000/9000 SERIES SCREWDRIVERS



9715

THROUGH BLADE SCREWDRIVER



- Through blade screwdriver for slotted head screws
- Handle: Black square impact resistant plastic handle. With impact cap
- Blade: High quality steel. Hexagonal blade. Black finish tip



	 731415									 9
9715-14-250	3010148	5	2.5 mm	14.0 mm	250 mm	140 mm	395 mm	12 mm	460	

8052

REVERSIBLE BLADE SCREWDRIVER



- Reversible blade screwdriver for slotted and Phillips head screws
- Handle: Black square impact resistant plastic handle
- Blade: High quality steel. Black finish tip



	 731415									 9
8052	1318406	5	PH 2	1.0 mm	6.0 mm	80 mm	110 mm	190 mm	90	



RATCHETING SCREWDRIVERS

808050

RATCHETING SCREWDRIVER



- Ratcheting bit holder screwdriver 1/4"
- Handle: 3-component handle with textured finish for maximum torque and minimum effort
- Interchangeable bit storage compartment with release button for quick access
- Slide tray that keeps 6 different bits handy and secure: PH 1, PH 2, PZ 1, PZ 2, slotted 4,5 and 5,5
- Magnetic blade secures bit in screwdriver and makes bit changing easy
- Knurled blade makes the grip firm, providing finger tip control for faster turning
- Smooth ratcheting stroke, three position ratchet mechanism: forward, reverse and neutral

808050	731415 3017642	1	1/4"	125	255	230

808050L

LED LIGHT RATCHETING SCREWDRIVER



- Ratcheting bit holder screwdriver 1/4"
- Handle: 3-component handle with textured finish for maximum torque and minimum effort
- Interchangeable bit storage compartment with release button for quick access
- Slide tray that keeps 6 different bits handy and secure: PH 1, PH 2, PZ 1, PZ 2, slotted 4,5 and 5,5
- Magnetic blade secures bit in screwdriver and makes bit changing easy
- Knurled blade makes the grip firm providing finger tip control for faster turning
- Smooth ratcheting stroke, allowing three position ratchet mechanism: forward, reverse and neutral
- Long-lasting LED lights mounted in front casing provide illumination in dark conditions
- 3 batteries & 2 lights. AG-3 4.5V battery type. It meets ROHS requirements
- 808050L-SP1: spare led panel + 3 batteries AG-3, 4.5 V

808050L	731415 0128075	1	1/4"	135	250	215
808050L-SP1	0129218	1				

808050P

PISTOL HANDLE SCREWDRIVER



- Pistol handle ratcheting bit holder screwdriver 1/4"
- Handle: 3-component handle with textured finish for maximum torque and minimum effort
- Handle swivels and locks at 30° position for application of higher torque when necessary. This is especially important in work areas where there is little room to twist the screwdriver and the user's hand
- Locks at 180° for normal operation
- Interchangeable bit storage compartment with release button for quick access
- Slide tray that keeps 6 different bits handy and secure: PH 1, PH 2, PZ 1, PZ 2, slotted 4,5 and 5,5
- Magnetic blade secures bit in screwdriver and makes bit changing easy
- Knurled blade makes the grip firm providing finger tip control for faster turning (rapid action)
- Smooth ratcheting stroke, allowing three position ratchet mechanism: forward, reverse and neutral

808050P	731415 0128105	1	1/4"	135	260	270



808050P-

PISTOL HANDLE SCREWDRIVER



- Pistol handle ratcheting and ratchet wrenches set
- Lightweight, rounded corners handy blow moulded case
- Contents: 25 pcs
 - 1 pce pistol grip ratcheting screwdriver with fixed bit holder
 - 6 pcs 25 mm 1/4" bits in the screwdriver bit storage: PH 1, PH 2, PZ 1, PZ 2, slotted 4.5 and 5.5
 - 3 pcs ratchet wrenches: 8 x 10-9 x 11 mm, 12 x 14-13 x 15 mm and 16 x 17-18 x 19 mm
 - 1 pce 1/4"x1/4" socket adaptor in bit holder block
 - 1 pce bit adaptor for 1/4" 10 mm reverse gear
 - 13 pcs 25 mm 1/4" bits; 2 plastic bit holder block; PH 3, PZ 3, SL 6.5, HEX 3, HEX 4, HEX 5, T-10, T-15, T-20, T-25, T-27, T-30, T-40

808050P-25	731415	1	285x158x70	1400

808050TS

STUBBY T-HANDLE RATCHETING SCREWDRIVER



- Stubby ratcheting 1/4" bit holder screwdriver with T-handle
- Handle: 3-component T-handle with textured finish, maximizes force on the fastener, torque on the tool and user comfort
- Magnetic blade secures bit in screwdriver and makes bit changing easy
- Smooth ratcheting stroke, allowing three position ratchet mechanism: forward, reverse and neutral

808050TS	731415	1	1/4"	68	95	165

808050S

STUBBY RATCHETING SCREWDRIVER



- Stubby ratcheting 1/4" bit holder screwdriver
- Handle: 3-component handle with textured finish, compact for access to enclosed spaces
- Magnetic shank secures bit in screwdriver and makes bit changing easy
- Smooth ratcheting stroke, allowing three position ratchet mechanism: forward, reverse and neutral

808050S	731415	1	1/4"	68	95	135



RATCHETING SCREWDRIVERS

808050S-

STUBBY RATCHETING SCREWDRIVER



- Stubby ratcheting 1/4" bit holder, bits and sockets set
- Lightweight, rounded corners handy injection case
- Detachable square driver blade
- 808050S-18
 - 1 pce detachable square driver blade stubby ratcheting screwdriver
 - 8 pcs S2 Zinc Phosphate bits: PH 1, PH 2, PZ 1, PZ 2, T-15, T-20, SL 4, HEX 3
 - 1 pce 1/4" x 1/4" socket adaptor
 - 1 pce 1/4" Sq. x 1/4" hex bit holder 50 mm (changeable type)
 - 1 pce 1/4" Sq. x 1/4" square flexible socket adaptor 150 mm
 - 1 pce 1/4" x 1/4" bit adaptor
 - 5 pcs 1/4" sockets: 4, 5, 6, 7, 8 mm
- 808050S-22
 - 1 pce detachable square driver blade stubby ratcheting screwdriver
 - 17 pcs S2 Zinc Phosphate bits: PH 1, PH 2, PH 3, PZ 1, PZ 2, T-10, T-15, T-20, T-25, T-27, T-30, T-40, SL 4, SL 5, SL 5.5, SL 6.5, SL 1/4"
 - 1 pce 1/4" x 1/4" socket adaptor
 - 1 pce 1/4" Sq. x 1/4" hex bit holder 50 mm (changeable type)
 - 1 pce 1/4" Sq. x 1/4" square flexible socket adaptor 150 mm
 - 1 pce 1/4" x 1/4" bit adaptor

	 731415		 mm	 g
808050S-18	0128921	1	195x130x46	530
808050S-22	0128938	1	195x130x46	530

808050A/TORX

BIT HOLDER



- Bit holder screwdriver 1/4"
- Handle: 3-component handle with textured finish for maximum torque and minimum effort
- Interchangeable bit storage compartment with release button for quick access
- Slide tray that keeps 6 different bits handy and secure:
 - 808050A: PH 1, PH 2, PZ 1, PZ 2, Slotted 4,5 and 5,5
 - 808050TORX: T-10, T-15, T-20, T-25, T-30, T-40
- Magnetic blade secures bit in screwdriver and makes bit changing easy
- Knurled blade makes the grip firm providing finger tip control for faster turning

	 731415			 mm	 mm	 g
808050A	0127306	1	1/4	115	230	150
808050TORX	0127313	1	1/4	115	230	150



700

SLOTTED SCREWDRIVERS



- Precision screwdriver for slotted head screws
- Handle: 2-component handle. The rotating head allows a fast and comfortable finger movement during turning
- Cap in different colours, for an easy identification of the tip
- Blade: High performance alloy steel. Chrome plated and entirely hardened
- Precision machined black finish tip guarantees high accuracy and precision fitting
- Branding: Size and part number laser branded on the blade

	 731415		 mm	 mm	 mm	 mm	 mm	 g
700-1-50	3017673	5	0.18	1	50	87	137	20
700-1.2-50	3017680	5	0.20	1.2	50	87	137	20
700-1.5-50	3017697	5	0.25	1.5	50	87	137	20
700-1.8-50	3017703	5	0.30	1.8	50	87	137	20
700-2-50	3017710	5	0.40	2	50	87	137	20
700-2-75	3017727	5	0.40	2	75	87	162	22
700-2.5-50	3017741	5	0.40	2.5	50	87	137	22
700-2.5-100	3017758	5	0.40	2.5	100	87	187	23
700-3-50	3017765	5	0.50	3	50	87	137	23
700-3-100	3017772	5	0.50	3	100	87	187	24
700-3-200	3017789	5	0.50	3	200	87	287	39
700-3.5-75	3017796	5	0.60	3.5	75	87	162	26
700-4-75	3017802	5	0.80	4	75	87	162	29
700-4-250	3017819	5	0.80	4	250	87	337	61

701

PHILLIPS SCREWDRIVERS



- Precision screwdriver for Phillips head screws
- Handle: 2-component handle. The rotating head allows a fast and comfortable finger movement during turning
- Cap in different colours, for an easy identification of the tip
- Blade: High performance alloy steel. Chrome plated and entirely hardened
- Precision machined black finish tip guarantees high accuracy and precision fitting
- Branding: Size and part number laser branded on the blade

	 731415			 mm	 mm	 mm	 mm	 g
701-00-50	3017833	5	PH 00	50	87	137	20	
701-0-50	3017840	5	PH 0	50	87	137	23	
701-0-200	3017857	5	PH 0	200	87	287	39	
701-1-75	3017864	5	PH 1	75	87	162	29	
701-1-250	3017871	5	PH 1	250	87	337	61	



PRECISION SCREWDRIVERS

702

POZIDRIV SCREWDRIVERS



- Precision screwdriver for Pozidriv head screws
- Handle: 2-component handle. The rotating head allows a fast and comfortable finger movement during turning
- Cap in different colours, for an easy identification of the tip
- Blade: High performance alloy steel. Chrome plated and entirely hardened
- Precision machined black finish tip guarantees high accuracy and precision fitting
- Branding: Size and part number laser branded on the blade

	 731415			 mm	 mm	 mm	 g
702-0-50	3017888	5	PZ 0	50	87	137	23
702-1-75	3017895	5	PZ 1	75	87	162	29

703

TORX® SCREWDRIVERS



- Precision screwdriver for TORX® head screws
- Handle: 2-component handle. The rotating head allows a fast and comfortable finger movement during turning
- Cap in different colours, for an easy identification of the tip
- Blade: High performance alloy steel. Chrome plated and entirely hardened
- Precision machined black finish tip guarantees high accuracy and precision fitting
- Branding: Size and part number laser branded on the blade

	 731415			 D mm	 mm	 mm	 mm	 g
703-4-50	3017901	5	T 4	1,30	50	87	137	21
703-5-50	3017918	5	T 5	1,37	50	87	137	21
703-6-50	3017925	5	T 6	1,65	50	87	137	21
703-7-50	3017932	5	T 7	1,97	50	87	137	21
703-8-50	3017949	5	T 8	2,30	50	87	137	23
703-9-50	3017956	5	T 9	2,48	50	87	137	23
703-10-50	3017963	5	T 10	2,72	50	87	137	23
703-15-75	3017970	5	T 15	3,26	75	87	162	30
703-20-75	3017987	5	T 20	3,84	75	87	162	30

704

HEXAGONAL BALL SCREWDRIVERS



- Precision screwdriver for hexagon head screws
- Handle: 2-component handle. The rotating head allows a fast and comfortable finger movement during turning
- Cap in different colours, for an easy identification of the tip
- Blade: High performance alloy steel. Chrome plated and entirely hardened
- Precision machined black finish tip guarantees high accuracy and precision fitting
- Branding: Size and part number laser branded on the blade

	 731415		 mm	 mm	 mm	 mm	 g
704-1.5-50	3017994	5	1.5	50	87	137	21
704-2-50	3018007	5	2	50	87	137	21
704-2.5-50	3018014	5	2.5	50	87	137	21
704-3-75	3018021	5	3	75	87	162	26
704Z-3/32	0137428	5	3/32	75	87	162	26



706-1



SETS

- Precision screwdriver set, 6 pcs
- For slotted and Phillips head screws
- In plastic case with hanging hole

	 731415		 g
706-1	3018045	1	240

700
1.5x50, 2.0x50, 2.5x50, 3.0x50



701
PH0x50, PH1x75



706-2



SETS

- Precision screwdriver set, 6 pcs
- For slotted and Phillips head screws
- In plastic case with hanging hole

	 731415		 g
706-2	3018052	1	226

700
1.0x50, 1.2x50, 1.5x50, 1.8x50



701
PH00x50, PH0x50



706-3



SETS

- Precision screwdriver set, 6 pcs
- For slotted head screws
- In plastic case with hanging hole

	 731415		 g
706-3	3018069	1	222

700
1.0x50, 1.2x50, 1.5x50, 1.8x50, 2.0x50, 2.5x50





PRECISION SCREWDRIVERS

706-4



SETS

- Precision screwdriver set, 7 pcs
- For slotted, Phillips and TORX® head screws
- In plastic case with hanging hole

	 731415		 g
706-4	3018076	1	350
700			1.5x50, 2.5x50, 3.5x75
701			PH0x50, PH1x75
703			T6x50, T8x50

706-5



SETS

- Precision screwdriver set, 24 pcs
- For slotted, Phillips, Pozidriv, TORX® and hexagon head screws
- In plastic case with hanging hole

	 731415		 g
706-5	3018083	1	820
700			1.0x50, 1.2x50, 1.5x50, 1.8x50, 2.0x50, 3.0x50, 3.5x75, 4x75
701			PH00x50, PH0x50, PH1x75
702			PZ0x50, PZ1x75
703			T6x50, T7x50, T8x50, T9x50, T10x50, T15x75, T20x75
704			H1.5x50, H2x50, H2.5x50, H3x75



ELECTRONIC SCREWDRIVERS

7372I



SLOTTED SCREWDRIVER

- Precision screwdriver for slotted head screws
- Handle: Conical slender plastic handle. Impact resistant
- Blade: High quality steel. Chrome plated and entirely hardened. Black finish tip for higher accuracy
- Blade plastic protection up to the tip
- ISO 2380-1A

	 731415		 mm	 mm	 mm	 mm	 mm	 mm	 g
7372I-2-63	1398668	10	0.4	2.0	63	13x80	143	10	
7372I-2.5-75	1399047	10	0.4	2.5	75	13x80	155	13	
7372I-3-80	1341602	10	0.5	3.0	80	13x80	165	27	



900T

HEXAGONAL



- T-handle screwdriver for hexagonal head screws
- Handle: 2-component soft grip handle provides extra comfort and reduces pressure points in the hand
- Blade: High quality steel. Chrome plated and entirely hardened. Black finish tip for higher accuracy
- The long blade allows to apply a controlled torque and provides an easy access to screws requiring depth
- The short 90° blade is used for extreme torque or to work in areas where height is limited
- Branding: Size and part number laser branded on the blade for easier identification

	 731415		 mm				 g
900T-020-100	3018106	5	2	150	103	50x85	23
900T-025-100	3018113	5	2.5	150	103	50x85	25
900T-030-100	3018120	5	3	150	103	50x85	28
900T-040-150	3018137	5	4	188	136	50x85	48
900T-050-150	3018144	5	5	195	136	60x105	59
900T-060-200	3018151	5	6	245	185	60x105	73
900T-080-200	3018168	5	8	245	185	60x105	150
900T-100-200	3018175	5	10	245	185	60x105	210

901T

TORX®



- T-handle screwdriver for TORX® head screws
- Handle: 2-component soft grip handle provides extra comfort and reduces pressure points in the hand
- Blade: High quality steel. Chrome plated and entirely hardened. Black finish tip for higher accuracy
- The long blade allows to apply a controlled torque and provides an easy access to screws requiring depth
- The short 90° blade is used for extreme torque or to work in areas where height is limited
- Branding: Size and part number laser branded on the blade for easier identification

	 731415			 mm				 g
901T-006-100	3018182	5	T 6	1,65	153	103	50x85	37
901T-007-100	3018199	5	T 7	1,97	153	103	50x85	37
901T-008-100	3018205	5	T 8	2,30	153	103	50x85	37
901T-009-100	3018212	5	T 9	2,48	153	103	50x85	37
901T-010-100	3018229	5	T 10	2,72	153	103	50x85	37
901T-015-150	3018236	5	T 15	3,26	186	136	50x85	42
901T-020-150	3018243	5	T 20	3,84	186	136	50x85	42
901T-025-150	3018250	5	T 25	4,40	196	136	60x105	49
901T-027-150	3018267	5	T 27	4,96	196	136	60x105	52
901T-030-200	3018274	5	T 30	5,49	245	185	60x105	61
901T-040-200	3018281	5	T 40	6,60	245	185	60x105	135
901T-045-200	3018298	5	T 45	7,70	245	185	60x105	135
901T-050-200	3018304	5	T 50	8,79	245	185	60x105	139



T-HANDLE SCREWDRIVERS

902T

NUT DRIVER



- T-handle nut driver
- Handle: 2-component soft grip handle provides extra comfort and reduces pressure points in the hand
- Blade: High quality steel. Chrome plated and entirely hardened
- Branding: Size and part number laser branded on the blade for easier identification

	 731415		 mm				 g
902T-050-150	3018311	5	5	186	136	50x85	77
902T-055-150	3018328	5	5.5	186	136	50x85	77
902T-060-150	3018335	5	6	186	136	50x85	77
902T-070-175	3018342	5	7	220	160	60x105	77
902T-080-175	3018359	5	8	220	160	60x105	112
902T-090-175	3018366	5	9	220	160	60x105	98
902T-100-175	3018373	5	10	220	160	60x105	155
902T-110-175	3018380	5	11	220	160	60x105	155
902T-120-175	3018397	5	12	220	160	60x105	155
902T-130-175	3018403	5	13	220	160	60x105	155

904T

BIT HOLDER



- Bit holder 1/4"
- Handle: 2-component soft grip handle provides extra comfort and reduces pressure points in the hand
- Blade: High quality steel. Chrome plated and entirely hardened
- Branding: Part number laser branded on the blade for easier identification

	 731415		 mm				 g
904T-060-150	3019837	5	1/4"	180	120	60x105	125

905T

SOCKET DRIVER



- 1/4" socket driver
- Handle: 2-component soft grip handle provides extra comfort and reduces pressure points in the hand
- Blade: High quality steel. Chrome plated and entirely hardened
- Branding: Part number laser branded on the blade for easier identification

	 731415		 mm				 g
905T-060-100	3019844	5	1/4"	100	60	60x105	90



903T-1



SETS

- T-handle screwdriver set, 6 pcs
- For hexagonal head screws
- In clamshell packaging

	 731415		 g
903T-1	3018410	1	855

900T
3 - 4 - 5 - 6 - 8 - 10 mm



903T-2



SETS

- T-handle screwdriver set, 6 pcs
- For TORX® head screws
- In clamshell packaging

	 731415		 g
903T-2	3018427	1	400

901T
T 10, T 15, T 20, T 25, T 30, T 40



903T-3



SETS

- T-handle nut driver set, 6 pcs
- In clamshell packaging

	 731415		 g
903T-3	3018434	1	810

902T
5 - 6 - 7 - 8 - 10 - 13 mm





SPECIAL SCREWDRIVERS

806

VOLTAGE TESTER



- Mains tester 150-250V
- Handle: Clear transparent plastic handle, impact resistant
- Blade: High quality steel. Nickel plated blade. Plastic protection up to the tip
- According to DIN VDE 0680/6 GS-marked
- 806-1-3; auto tester 6-24V



	 731151		 mm	 mm	 mm	 mm	 mm	 mm	 g
806-1-1	8003760	6	0.6	3.0	65	75	140	30	
806-1-2	0183258	6	-	3.5	100	90	190	29	
806-1-3	0183265	6	-	3	45	75	120	22	

8045LVDE

VOLTAGE TESTER



- Mains tester up to 250V
- Handle: Clear transparent plastic handle, impact resistant. Light model with cylindrical handle and clip
- Blade: High quality steel. Chrome plated blade. Plastic protection up to the tip. Black finish tip
- According to DIN VDE 0680/6 GS-marked



	 731415		 mm	 mm	 mm	 mm	 mm	 g
8045LVDE	1509163	10	0.5	3.5	42	16x90	134	28

8045VDE

VOLTAGE TESTER



- Mains tester up to 250V
- Handle: Clear transparent plastic handle, impact resistant
- Blade: High quality steel. Chrome plated blade. Plastic protection up to the tip. Black finish tip
- According to DIN VDE 0680/6 GS-marked



	 731415		 mm	 mm	 mm	 mm	 mm	 g
8045VDE	1317256	10	0.5	3.5	77	14x92	170	40



1019/1067/13561

REVERSIBLE SCREWDRIVERS



- Reversible blade screwdriver for slotted and Phillips head screws
- Handle: Impact resistant plastic handle
- Blade: High performance alloy steel. Nickel plated blade

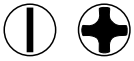

	 841281		 mm	 mm		 mm	 g
1019	4010199	10	1,2	6	PH 2	156	26
1067	4010670	10	0,8	4,5	PH 1	120	30
13561	4135618	10	1,2	6,0	PH 2	156	48

6

REVERSIBLE SCREWDRIVERS



- Reversible blade screwdriver set, 6 pcs
- PH 0, PH 1, PH 2 and slotted 3,5-5,0-6,5
- In plastic pouch with hanging hole



	 841281				 g
6	4220048	1	PH 0, PH 1, PH 2	3,5-5,0-6,5	250

2252

TRIMMER'S TOOL



- Trimmer's tool
- Handle: Impact resistant plastic handle. Metallic cap
- Blade: High quality steel. Through blade

	 731415		 mm	 mm	 mm	 mm	 g
2252	1062224	1	7	95	27x130	230	125

M780

MAGNETISER



- For magnetising and demagnetising of screwdriver blades, tweezers, and other tools made of steel
- Extremely durable plastic box

	 731415		 mm	 g
M780	1826215	1	50x52x29	95



SPECIAL SCREWDRIVERS

M781

MAGNETISER



- For magnetising and demagnetising of screwdriver blades, tweezers, scissors and other tools made of steel
- Comfortable handle for easy use
- Hanging hole

	 731415		 mm	 g
M781	3016218	5	40x125x22	35

BKE850901

BICYCLE TOOL



- Special mixed pocket set for bicycle
- In a metal holder. Tool set pouch in canvas with sleeve for waist-belt. Clamshell packed with info card
- 17 different tools
 - sockets 1/4", 8, 9, 10 mm
 - socket driver 1/4"
 - screwdrivers 0.8 x 5.0, PH 2, HEX 2, 2.5, 3, 4, 5, 6, 8
 - open end spanners 9, 13, 14 mm
 - spoke aligner

	 731415		 mm	 g
BKE850901	3013446	10	35x200x170	315



1997M

CHROME PLATED KEYS FOR HEX SCREWS, METRIC

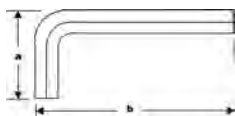

- Offset screwdriver for hexagon head screws, metric
- High quality steel, entirely hardened
- Black finish up to 3 mm; from 3,5 mm and above chrome plated
- Size stamped in the blade for easy identification
- ISO 2936

	 731415		 mm	a mm	b mm	 g
1997M-1.5	1302054	10	1.5	16	47	1
1997M-2	1059262	10	2	18	52	1
1997M-2.5	1059279	10	2.5	21	59	3
1997M-3	1059286	10	3	23	66	4
1997M-3.5	1302078	10	3.5	26	70	6
1997M-4	1059293	10	4	29	74	10
1997M-4.5	1302085	10	4.5	31	80	15
1997M-5	1059309	10	5	33	85	17
1997M-6	1059316	10	6	38	96	30
1997M-7	1059323	10	7	41	102	45
1997M-8	1059330	10	8	44	108	65
1997M-9	1059347	10	9	47	114	90
1997M-10	1059354	10	10	50	122	115
1997M-11	1059361	10	11	53	129	150
1997M-12	1059378	5	12	57	137	190
1997M-14	1059385	5	14	70	154	250
1997M-16	1059392	1	16	73	168	375
1997M-17	1059408	1	17	80	177	508
1997M-19	1059415	1	19	89	199	690

1997M/T

CHROME PLATED KEYS SETS, METRIC



- Set of chrome plated hexagon offset screwdrivers, metric
- In plastic wallet
- Sizes marked at the top of the wallet, for an easy selection

	 731151		 g
1997M/7T	1059439	1	200
1997M/10T	1302108	1	195
1997M/11T	1059453	1	760

1997M/7T
2, 3, 4, 5, 6, 7, 8 mm



1997M/10T
1.5, 2, 2.5, 3, 3.5, 4, 4.5, 5, 6, 8 mm



1997M/11T
2, 3, 4, 5, 6, 7, 8, 9, 10, 11, 12 mm





OFFSET SCREWDRIVERS

BE-9778

CHROME PLATED KEYS SETS, METRIC



- Set of chrome plated hexagon offset screwdrivers, 9 pcs, metric
- 2-component compact holder enables easy removal of individual keys
- All sizes marked on the holder for an easy selection
- Hanging hole



	 731415		 g
BE-9778	0123780	1	305

BE-9778
1.5, 2, 2.5, 3, 4, 5, 6, 8, 10 mm



1999M/7H

ZINC PLATED KEYS SET, METRIC



- Set of zinc plated hexagon offset screwdrivers, 7 pcs, metric
- In metallic folder with lever action



	 731415		 mm	 g
1999M/7H	1801076	1	2.5, 3, 4, 5, 6, 8, 10	380



1998M

NICKEL PLATED KEYS FOR HEX SCREWS, METRIC



- Offset screwdriver for hexagon head screws, metric
- High quality steel, entirely hardened
- Nickel plated
- Size stamped in the blade for easy identification
- ISO 2936

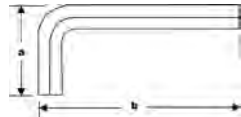

	 731415		 mm	a mm	b mm	 g
1998M-1.5	0185719	1	1.5	15	47	1
1998M-2	0185726	10	2	18	52	1
1998M-2.5	0185733	1	2.5	21	59	3
1998M-3	0185740	1	3.0	23	66	4
1998M-4	0185757	1	4.0	29	74	10
1998M-5	0185764	1	5.0	33	85	18
1998M-6	0185863	1	6.0	38	96	29
1998M-7	0185771	1	7.0	41	102	41
1998M-8	0185788	1	8.0	44	108	57
1998M-9	0185795	1	9.0	47	114	76
1998M-10	0185801	1	10	50	122	100
1998M-12	0185818	1	12.0	57	137	163
1998M-14	0185825	1	14.0	70	154	253
1998M-17	0185832	1	17.0	80	177	427
1998M-19	0185849	1	19.0	89	199	600
1998M-22	0185856	1	22.0	102	222	910

1998M/

NICKEL PLATED KEYS SETS, METRIC



- Set of nickel plated hexagon offset screwdrivers, metric
- In plastic wallet
- Sizes marked at the top of the wallet, for an easy selection
- Hanging hole

	 731415		 g
1998M/6T	0186204	1	76
1998M/8T	0186211	1	180
1998M/10T	0186228	1	380
1998M/11T	0186235	1	570
1998M/15T	0186242	1	2920

1998M/6T
2, 2.5, 3, 4, 5, 6 mm



1998M/8T
2, 2.5, 3, 4, 5, 6, 7, 8 mm



1998M/10T
2, 2.5, 3, 4, 5, 6, 7, 8, 9, 10 mm



1998M/11T
2, 2.5, 3, 4, 5, 6, 7, 8, 9, 10, 12 mm



1998M/15T
2, 2.5, 3, 4, 5, 6, 7, 8, 9, 10, 12, 14, 17, 19, 22 mm





OFFSET SCREWDRIVERS

BE-9878



NICKEL PLATED KEYS SETS, METRIC

- Set of nickel plated hexagon offset screwdrivers, 9 pcs, metric
- 2-component compact holder enables easy removal of each key
- All sizes marked on the holder for an easy selection
- Hanging hole

	 731415		 g
BE-9878	0186259	1	305



BE-9878
1.5, 2, 2.5, 3, 4, 5, 6, 8, 10 mm



1998M/8R



- Set of nickel plated hexagon offset screwdrivers, 8 pcs, metric
- On ring

	 731415		 g
1998M/8R	0186266	1	175



1998M/8R
2, 2.5, 3, 4, 5, 6, 7, 8 mm



1995M



BLACK KEYS FOR HEX SCREWS, METRIC

- Offset screwdriver for hexagon head screws, metric
- High quality steel, entirely hardened
- Black finish
- Size stamped in the blade for easy identification
- ISO 2936

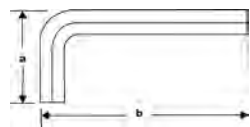

	 731415		 mm	a mm	b mm	 g
1995M-1.5	0122158	10	1.5	15	47	1
1995M-2	0122745	10	2.0	18	52	2
1995M-2,5	0122752	10	2.5	21	59	3
1995M-3	0122769	10	3.0	23	66	5
1995M-4	0122776	10	4.0	29	74	10
1995M-5	0122790	10	5.0	33	85	13
1995M-6	0122813	10	6.0	38	96	29
1995M-7	0122837	10	7.0	41	102	41
1995M-8	0122851	10	8.0	44	108	57
1995M-9	0122875	10	9.0	47	114	76
1995M-10	0122912	10	10	50	122	100
1995M-12	0122943	10	12	57	137	163
1995M-14	0122967	10	14	70	154	253
1995M-17	0122974	10	17	80	177	427
1995M-19	0122981	10	19	89	199	600
1995M-22	0122998	10	22	102	222	910



1995LM

BLACK KEYS FOR HEX SCREWS, LONG METRIC

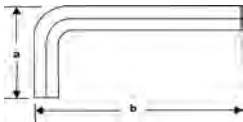

- Offset screwdriver for hexagon head screws, metric
- High quality steel, entirely hardened
- Black finish
- Size stamped in the blade for easy identification
- Long arm provides higher torque transmission and accessibility
- ISO 2936

	 731415		 mm	a mm	b mm	 g
1995LM-1.5	0122172	10	1.5	15	91	1
1995LM-2	0122189	10	2	18	102	3
1995LM-2,5	0123162	10	2.5	21	114	5
1995LM-3	0123179	10	3.0	23	129	8
1995LM-4	0123186	10	4.0	29	144	17
1995LM-5	0123209	10	5.0	33	165	31
1995LM-6	0123216	10	6.0	38	186	51
1995LM-7	0123223	10	7.0	41	197	64
1995LM-8	0123230	10	8.0	44	208	100
1995LM-9	0123247	10	9.0	47	219	134
1995LM-10	0123254	10	10	50	234	175
1995LM-12	0123261	10	12	57	262	283
1995LM-14	0123278	10	14	70	294	439

1995M/

BLACK KEYS SETS, METRIC



- Set of black finish hexagon offset screwdrivers, metric
- In plastic wallet
- Sizes marked at the top of the wallet, for easy selection
- Hanging hole

	 731415		 g
1995M/6T	0123629	1	75
1995M/8T	0123636	1	180
1995M/10T	0123643	1	365
1995M/11T	0123650	1	535
1995M/15T	0123667	1	2800

1995M/6T
2, 2.5, 3, 4, 5, 6 mm

1995M/8T
2, 2.5, 3, 4, 5, 6, 7, 8 mm

1995M/10T
2, 2.5, 3, 4, 5, 6, 7, 8, 9, 10 mm

1995M/11T
2, 2.5, 3, 4, 5, 6, 7, 8, 9, 10, 12 mm

1995M/15T
2, 2.5, 3, 4, 5, 6, 7, 8, 9, 10, 12, 14, 17, 19, 22 mm





OFFSET SCREWDRIVERS

BE-9578

BLACK KEYS SETS, METRIC



- Set of black finish hexagon offset screwdrivers, 9 pcs, metric
- 2-component compact holder enables easy removal of each key
- All sizes marked onto the lid for an easy selection
- Hanging hole



	 731415		 g
BE-9578	0123803	1	270

BE-9578
1.5, 2, 2.5, 3, 4, 5, 6, 8, 10 mm



BE-9777B

BLACK KEYS SETS, METRIC



- Set of black finish hexagon offset screwdrivers, 7 pcs, metric
- 2-component soft grip handle
- Resistant to impact, does not conduct heat or cold or rust
- Wide opening push button for automatic release of the blades
- For different working positions
- Positive stop at 270°, for maximum leverage
- Easy to store
- Retail packaging with hanger



	 731415		 mm	 g
BE-9777B	0188734	6	2.5, 3, 4, 5, 6, 8, 10	290



BE-9776/BE-9777

BLACK KEYS SETS, METRIC



- Set of black finish hexagon offset screwdrivers, 7 pcs, metric
- In high quality impact resistant folder
- Allows many different working positions
- Positive stop at 270° degrees, for maximum leverage
- Easy to store
- Retail packaging with hanger



	 731415		 mm	 g
BE-9776	0056545	6	1.5, 2, 2.5, 3, 4, 5, 6	150
BE-9777	0056552	6	2.5, 3, 4, 5, 6, 8, 10	410

BE-9588

BLACK KEYS SETS, METRIC



- Set of long black finish hexagon offset screwdrivers, 9 pcs metric
- 2-component compact holder enables easy removal of individual keys
- All sizes marked on the holder for an easy selection
- Hanging hole



	 731151		 g
BE-9588	0123810	1	435

BE-9588
1.5, 2, 2.5, 3, 4, 5, 6, 8, 10 mm





OFFSET SCREWDRIVERS

1995Z

BLACK KEYS FOR HEX SCREWS, INCH

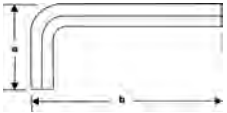

- Offset screwdriver for hexagon head screws, inch
- High quality steel, entirely hardened
- Black finish
- Size stamped in the blade

	 731415			a mm	b mm	 g
1995Z-1/16	0122165	10	1/16	15	47	1
1995Z-5/64	0123001	10	5/64	18	52	2
1995Z-3/32	0123018	10	3/32	21	59	3
1995Z-1/8	0123025	10	1/8	23	66	5
1995Z-5/32	0123049	10	5/32	29	74	10
1995Z-3/16	0123056	10	3/16	33	85	16
1995Z-7/32	0123063	10	7/32	35.5	91	24
1995Z-1/4	0123070	10	1/4	38	96	32
1995Z-5/16	0123087	10	5/16	44	108	60
1995Z-3/8	0123094	10	3/8	50	122	100
1995Z-7/16	0123100	10	7/16	53	129	140
1995Z-1/2	0123117	10	1/2	63	145	182
1995Z-5/8	0123131	10	5/8	76	168	370
1995Z-3/4	0123155	10	3/4	89	199	601

BE-9787

BLACK KEYS SETS, INCH



- Set of black finish hexagon offset screwdrivers, 7 pcs, inch
- In high quality impact resistant folder
- Allows many different working positions
- Positive stop at 270°, for maximum leverage
- Easy to store
- Retail packaging with hanger

	 731415			 g
BE-9787	0056569	6	3/32, 1/8, 5/32, 3/16, 1/4, 5/16, 3/8	410



1996M

BLACK KEYS FOR HEX SCREWS, LONG BALL END

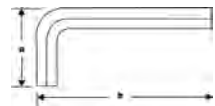

- Offset ball end screwdriver for hexagon head screws, metric
- High quality steel, entirely hardened
- Black finish
- Size stamped in the blade for easy identification
- Long arm provides higher torque transmission and accessibility
- Ball end allows to easily insert the key in the screw head from a range of angles
- More efficient and time saving than a standard hex key
- ISO 2936

	 731415			a mm	b mm	
1996M-1.5	0122202	10	1.5	15	91	1
1996M-2	0122653	10	2.0	18	102	3
1996M-2.5	0122660	10	2.5	21	114	5
1996M-3	0122677	10	3.0	23	129	8
1996M-4	0122684	10	4.0	29	144	17
1996M-5	0122691	10	5.0	33	165	31
1996M-6	0122707	10	6.0	38	186	50
1996M-8	0122714	10	8.0	44	208	100
1996M-10	0122721	10	10	50	234	171
1996M-12	0122738	10	12	57	262	275

BE-9765/BE-9770

BLACK KEYS SETS FOR HEX SCREWS, LONG BALL END



- Set of long ball end black finish hexagon offset screwdrivers, metric
- In plastic holder
- All sizes branded onto the lid for an easy selection
- Hanging hole

	 731415		
BE-9765	0055128	3	60
BE-9770	0027712	3	355

BE-9765
1.5, 2, 2.5, 3, 4, 5 mm



BE-9770
1.5, 2, 2.5, 3, 4, 5, 6, 8, 10 mm





OFFSET SCREWDRIVERS

BE-9678

BLACK KEYS SETS FOR HEX SCREWS, LONG BALL END



- Set of long ball end black finish hexagon offset screwdrivers, 9 pcs, metric
- 2-component compact holder enables easy removal of keys
- All sizes marked on the holder for an easy selection
- Hanging hole



BE-9678	0123827	1	430
---------	---------	---	-----

BE-9678
1.5, 2, 2.5, 3, 4, 5, 6, 8, 10 mm



BE-9688

BLACK KEYS SETS FOR HEX SCREWS, LONG BALL END



- Set of long ball end black finish hexagon offset screwdrivers, 9 pcs, metric
- 2-component compact holder enables easy removal of each individual key without having to move any other of the set
- Magnet/demagnetising function integrated in the holder
- All sizes marked on the holder for an easy selection
- Hanging hole



BE-9688	0123834	1	450
---------	---------	---	-----

BE-9688
1.5, 2, 2.5, 3, 4, 5, 6, 8, 10 mm





BE-9775-BE-9785

BLACK KEYS SETS FOR HEX SCREWS, LONG BALL END



- Set of long ball end black finish hexagon offset screwdrivers, inch
- In plastic holder
- All sizes marked on the holder for an easy selection
- Hanging hole

	 731415		 g
BE-9775	0056330	3	70
BE-9780	0033386	3	240
BE-9785	0056347	3	370

BE-9775

5/64, 3/32, 1/4, 1/8, 1/16, 5/32, 3/16



BE-9780

0.050, 1/16, 5/64, 3/32, 7/64, 1/8, 9/64, 5/32, 3/16, 7/32, 1/4, 5/16



BE-9785

0.050, 1/16, 5/64, 3/32, 7/64, 1/8, 9/64, 5/32, 3/16, 7/32, 1/4, 5/16, 3/8



1995TORX

BLACK KEYS FOR TORX® SCREWS

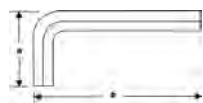

- Offset screwdrivers for TORX® head screws
- High performance alloy steel, entirely hardened
- Black finish
- Size laser marked on the blade for easy identification
- Long arm provides higher torque transmission and accessibility

	 731415			a mm	b mm	 g
1995TORX-T6	0122196	5	T 6	15	75	4
1995TORX-T7	0123285	5	T 7	16	80	4
1995TORX-T8	0123292	5	T 8	16	80	5
1995TORX-T9	0122219	5	T 9	16	80	60
1995TORX-T10	0123308	5	T 10	17	86	5.4
1995TORX-T15	0123322	5	T 15	18	90	10
1995TORX-T20	0123339	5	T 20	19	95	11
1995TORX-T25	0123346	5	T 25	20	100	17
1995TORX-T27	0123353	5	T 27	21	105	19
1995TORX-T30	0123360	5	T 30	24	114	29
1995TORX-T40	0123377	5	T 40	26	124	43
1995TORX-T45	0123407	5	T 45	29	133	61
1995TORX-T50	0123421	5	T 50	32	152	88



OFFSET SCREWDRIVERS

1995TORX/



BLACK KEYS SET FOR TORX® SCREWS

- Set of black finish offset screwdrivers, for TORX® head screws in plastic wallet. Sizes marked at the top of the wallet, for an easy selection
- Hanging hole

	 731415		 g
1995TORX/4T	0123674	1	200
1995TORX/7T	0123711	1	155
1995TORX/11T	0123742	1	325
1995TORX/13T	0123759	1	335
1995TORX/4T			
1995TORX/4T T10, T20, T30, T40			
1995TORX/7T			
1995TORX/7T T10, T15, T20, T25, T27, T30, T40			
1995TORX/11T			
1995TORX/11T T7, T9, T10, T15, T20, T25, T27, T30, T40, T45, T50			
1995TORX/13T			
1995TORX/13T T6, T7, T8, T9, T10, T15, T20, T25, T27, T30, T40, T45, T50			

BE-9575



BLACK KEYS SET FOR TORX® SCREWS

- Set of long black finish offset screwdriver for TORX® head screws, 8 pcs
- 2-component compact holder enables easy removal of individual key
- All sizes marked on the holder for an easy selection
- Hanging hole

	 731415		 g
BE-9575	0123841	1	180
BE-9575			
BE-9575 T9, T10, T15, T20, T25, T27, T30, T40			

BE-9585



BLACK KEYS SET FOR TORX® SCREWS

- Set of long black finish offset screwdrivers, for TORX® head screws, 8 pcs
- 2-component compact holder enables easy removal of individual keys
- Magnet/demagnetising function integrated in the holder
- All sizes marked onto the holder for an easy selection
- Hanging hole

	 731415		 g
BE-9585	0123858	1	180
BE-9585			
BE-9585 T9, T10, T15, T20, T25, T27, T30, T40			



BE-8975B

BLACK KEYS SET FOR TORX® SCREWS



- Set of black finish offset screwdrivers for TORX® head screws, 8 pcs
- 2-component soft grip handle. Resistant to impact, does not conduct heat or cold or rust
- Wide opening push button for automatic release of the blades
- For different working positions
- Positive stop at 270°, for maximum leverage
- Easy to store
- Retail packaging with hanger



	 731415			
BE-8975B	0188741	6	T9, T10, T15, T20, T25, T27, T30, T40	290

BE-8975

BLACK KEYS SET FOR TORX® SCREWS



- Set of black finish offset screwdrivers for TORX® head screws, 8 pcs
- In high quality impact resistant folder
- Allows many different working positions
- Positive stop at 270° degrees, for maximum leverage
- Retail packaging with hanger

	 731415			
BE-8975	0056576	6	T9, T10, T15, T20, T25, T27, T30, T40	295



OFFSET SCREWDRIVERS

1996TORX

BLACK KEYS FOR TORX® SCREWS, BALL END



- Offset screwdrivers for TORX® head screws
- High performance alloy steel, entirely hardened
- Black finish
- Size laser marked on blade for easy identification
- Long arm provides higher torque transmission and accessibility
- Ball end allows to easily insert the key in the screw head from a range of angles
- More efficient and time saving than a standard hex key

	 731415			a mm	b mm	Ø mm	 g
1996TORX-T9	0122226	5	T 9	16	80	3.0	4
1996TORX-T10	0122783	5	T 10	17	86	3.0	5
1996TORX-T15	0122806	5	T 15	18	90	4.0	7
1996TORX-T20	0122820	5	T 20	19	95	4.0	10
1996TORX-T25	0122844	5	T 25	20	100	5.0	14
1996TORX-T27	0122868	5	T 27	21	105	5.0	22
1996TORX-T30	0122882	5	T 30	24	114	6.0	30
1996TORX-T40	0122899	5	T 40	26	124	7.0	46
1996TORX-T45	0122905	5	T 45	29	133	8.0	61
1996TORX-T50	0122929	5	T 50	32	152	9.0	82

1996TORX/

BLACK KEYS SET FOR TORX® SCREWS BALL END



- Set of long ball end black finish offset screwdrivers for TORX® head screws, 5 pcs
- In plastic wallet
- Sizes marked at the top of the wallet, for an easy selection
- Hanging hole

	 731415		 g
1996TORX/5T	0123698	1	200



1996TORX/5T
T10, T20, T25, T30, T40





BE-9675

BLACK KEYS SET FOR TORX® SCREWS BALL END



- Set of long ball end black finish offset screwdrivers for TORX® head screws, 8 pcs
- 2-component compact holder enables easy removal of individual keys without having to move any other of the set
- All sizes branded onto the lid for an easy selection
- Hanging hole



	 731415		 g
BE-9675	0123889	1	175

BE-9675
T9, T10, T15, T20, T25, T27, T30, T40



1986TORX

BLACK KEYS FOR TORX® TAMPER RESISTANT SCREWS



- Offset screwdrivers for TORX® and TORX® tamper resistant head screws
- High performance alloy steel, entirely hardened
- Black finish
- Size laser marked on the blade for easy identification
- Long arm provides higher torque transmission and accessibility



	 731415			Ø mm	b mm	a mm	 g
1986TORX-T9	0122233	5	TR 9	3.0	80	16	4
1986TORX-T10	0123537	5	TR 10	3.0	86	17	5
1986TORX-T15	0123544	5	TR 15	4.0	90	18	8
1986TORX-T20	0123551	5	TR 20	4.0	95	19	11
1986TORX-T25	0123568	5	TR 25	5.0	100	20	17
1986TORX-T27	0123575	5	TR 27	5.0	105	21	19
1986TORX-T30	0123582	5	TR 30	6.0	114	24	29
1986TORX-T40	0123599	5	TR 40	7.0	124	26	43



OFFSET SCREWDRIVERS

1986TORX/



BLACK KEYS SETS FOR TORX® TAMPER RESISTANT SCREWS

- Set of long black finish offset screwdrivers for TORX® and TORX® tamper resistant head screws, 8 pcs
- In plastic wallet. Sizes marked at the top of the wallet, for easy selection
- Hanging hole

1986TORX/7T	731415 0123735	1	200 g



BE-8675
TR-9, TR-10, TR-15, TR-20, TR-25, TR-27, TR-30, TR-40



BE-8675



BLACK KEYS SETS FOR TORX® TAMPER RESISTANT SCREWS

- Set of long black finish offset screwdrivers for TORX® and TORX® tamper resistant head screws, 8 pcs
- 2-component compact holder enables easy removal of individual keys
- All sizes marked on the holder for easy selection
- Hanging hole

BE-8675	731415 0123872	1	180 g



BE-8675
TR-9, TR-10, TR-15, TR-20, TR-25, TR-27, TR-30, TR-40





1976TORX

BLACK KEYS FOR TORX® PLUS SCREWS



- Offset screwdrivers for TORX® and TORX® PLUS head screws
- High performance alloy steel, entirely hardened
- Black finish
- Size laser marked on the blade for easy identification
- Long arm provides higher torque transmission and accessibility

	 731415			a mm	b mm	Ø mm	 g
1976TORX-T6	0122240	5	IP 6	15	75	2.5	4
1976TORX-T7	0123384	5	IP 7	16	80	2.5	4
1976TORX-T8	0123391	5	IP 8	16	80	2.5	5
1976TORX-T9	0123414	5	IP 9	16	80	3.0	5
1976TORX-T10	0123438	5	IP 10	17	86	3.0	5
1976TORX-T15	0123452	5	IP 15	18	90	4.0	10
1976TORX-T20	0123469	5	IP 20	19	95	4.0	10
1976TORX-T25	0123476	5	IP 25	20	100	5.0	17
1976TORX-T27	0123490	5	IP 27	21	105	5.0	19
1976TORX-T30	0123506	5	IP 30	24	114	6.0	29
1976TORX-T40	0123513	5	IP 40	26	124	7.0	43

1976TORX/

BLACK KEYS SETS FOR TORX® PLUS SCREWS



- Set of long black finish offset screwdrivers for TORX® PLUS head screws, 5 pcs
- In plastic wallet. Sizes marked at the top of the wallet, for an easy selection
- Hanging hole

	 731415		 g
1976TORX/5T	0126927	1	0

1976TORX/5T
IP10, IP20, IP25, IP30, IP40





OFFSET SCREWDRIVERS

BE-7675

BLACK KEYS SETS FOR TORX® PLUS SCREWS



- Set of long black finish offset screwdrivers for TORX® PLUS head screws, 8 pcs
- 2-component compact holder enables easy removal of individual keys
- All sizes marked on the holder for easy selection
- Hanging hole

	 731151		 g
BE-7675	0123896	1	220

BE-7675
IP9, IP10, IP15, IP20, IP25, IP27, IP30, IP40



2047

DOUBLE OFFSET KEYS FOR SLOTTED SCREWS



- Double offset key, for slotted screws
- Nickel and chrome plated blade, polypropylene handle
- DIN 5200
- Tip angles 0° and 90° respectively



	 731415		 mm	 mm	 mm	 g
2047-0.8-4	1060459	5	0.8	4.0	100	14
2047-1-5.5	1060473	5	1.0	5.5	125	21
2047-1.2-8	1060480	5	1.2	8.0	150	37
2047-1.6-10	1060497	1	1.6	10.0	175	60
2047-2-12	1060503	1	2.0	12.0	200	115

2047PR

DOUBLE OFFSET KEYS FOR PHILLIPS SCREWS



- Double offset key for Phillips screws
- Nickel and chrome plated blade, polypropylene handle
- DIN 5208



	 731415			 mm	 g
2047PR-1-2	1060558	5	PH 1 & 2	100	25
2047PR-3-4	1060565	5	PH 3 & 4	200	110



PLIERS

Bahco has a wide range of pliers and cutters for every use - from small, convenient electronic cutters and neat, high-precision gripping pliers to sturdy cutters and heavy duty slip-joint pliers. This extensive range meets all high-quality demands in terms of materials and manufacturing processes as well as ergonomics and safety.



Chapter Index

SIDE CUTTERS	540-546
END CUTTERS	546
COMBINATION PLIERS	547-551
SNIPER NOSE PLIERS	552-555
SNIPER NOSE PLIERS, BENT TIP	556-559
MACHINISTS PLIERS	559
FLAT NOSE PLIERS	560-564
ROUND NOSE PLIERS	564-566
WIRE STRIPPERS	566-569
FINE MECHANICAL CUTTERS AND PLIERS	569-572
ELECTRONICS AND FINE MECHANICAL PLIERS	573-576
CIRCLIP PLIERS	577-582
CABLE CUTTERS	582-584
BOLT CUTTERS	585
GRIP AND WELDING PLIERS	586-591
FENCING PLIERS	592-593
SLIP JOINT PLIERS	594-598
PLIER SETS	598-599
WIRE TWISTING PLIERS	600
RIVETING TOOLS	600-601

TYPES OF PLIERS

CUTTING PLIERS



Side cutter



Oblique cutter



End cutter



Cable cutter

HOLDING PLIERS



Flat nose pliers are used mostly for assembly work.



Combination pliers are used both for holding and for cutting.



Slip joint pliers have an adjustable joint which provides a wide range of jaw openings and a firm grip on work pieces of varying shape.



Nut pliers are intended to use for gripping small nuts (counter grip) in confined spaces.



Snipe nose pliers are also used for assembly work. The slender jaws make the work easier in confined spaces.



Gripping and welding pliers are used for clamping work pieces during welding and assembly work.



Pincers are mainly intended for pulling nails, but can also be used for medium hard wire.



Round nose pliers are used mostly for bending and shaping wire.



Circlips pliers are intended for fitting internal and external circlips.



Use the right tool for the right job

- Using cutters or pliers in the wrong way will shorten their lifespan by damaging the tool, and may even result in a personal injury
- Don't use cutting pliers that are too small for the job. This not only damages the cutting edges and the work piece, but could also cause personal injury from flying splinters
- Always use the right tool and safety equipment



PLIERS - BASIC PRINCIPLES

1. CUTTING FORCE - The smaller the distance between the rivet and the bevel, the higher the leverage you can achieve.

F1 = force applied by the user's hand

F2 = force applied by the cutting edges

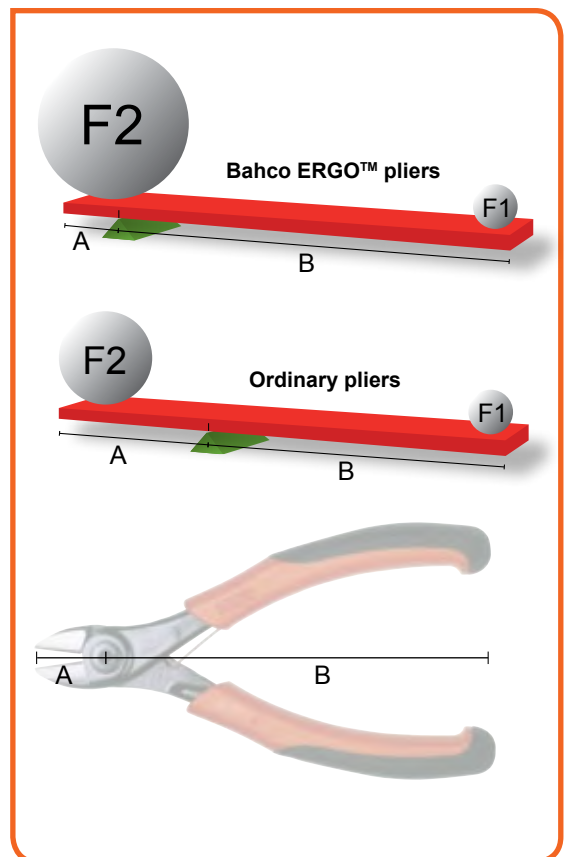
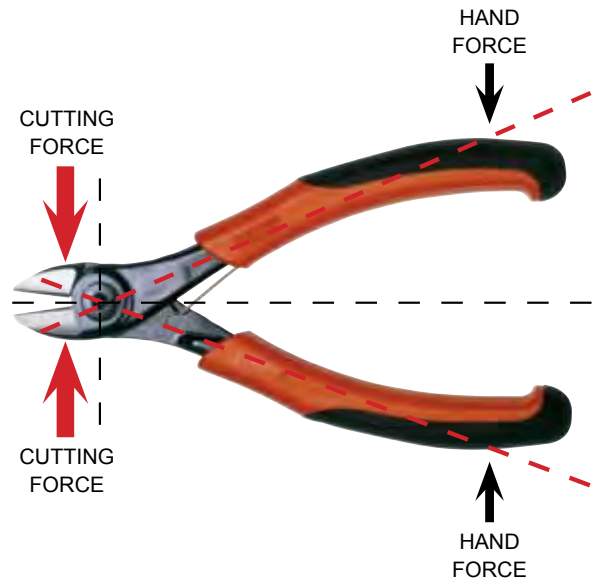
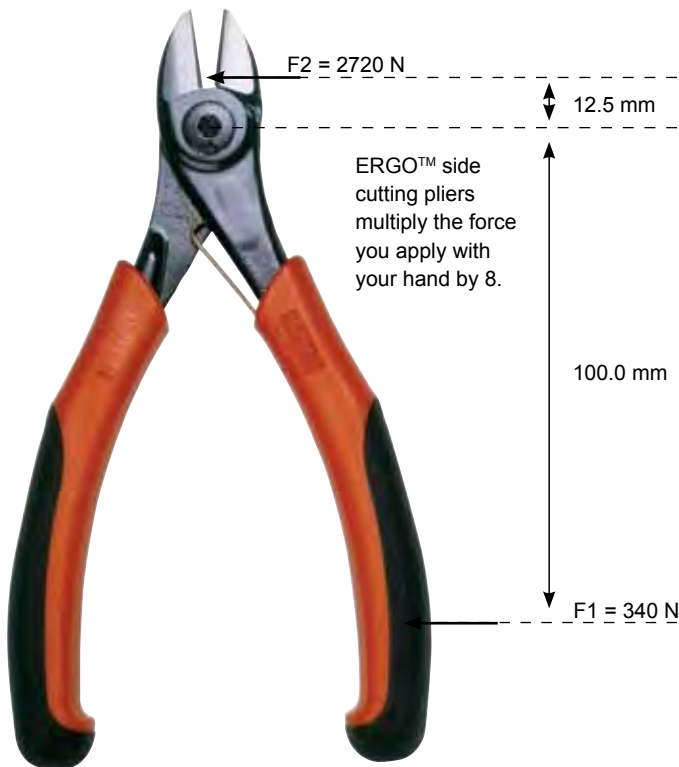

2. CUTTING EDGES - The cutting edges are designed to suit the intended use. The sharper the cutting edge, the softer materials it is intended to cut. Bahco has 2-in-1 pliers with progressive edges that cut both soft cables and thick wires.

HEAVY DUTY CUT
for materials like piano wire

MEDIUM HARD CUT
for materials like steel wire

SOFT CUT
for materials like copper wire or plastic

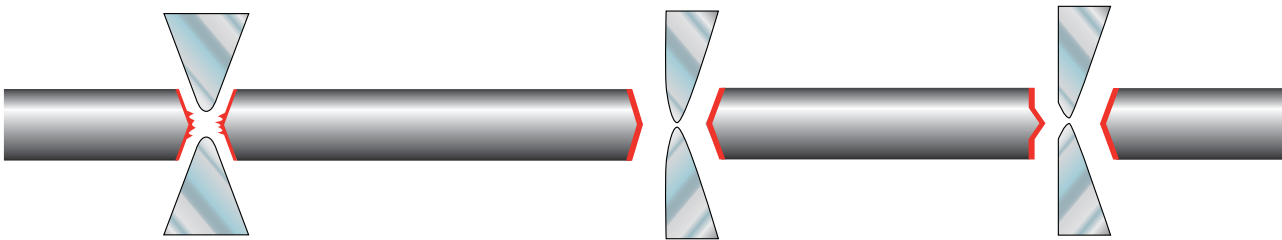

2-PLIERS-IN-1

The ERGO™ side cutting pliers have a so called progressive edge. Effectively, this means you can cut soft, thin wire close to the tip, and hard wire close to the screw. At the tip, the cutting edge is sharper so that it can cut softer materials such as copper, instead of simply squeezing them like most of the heavy duty pliers would.

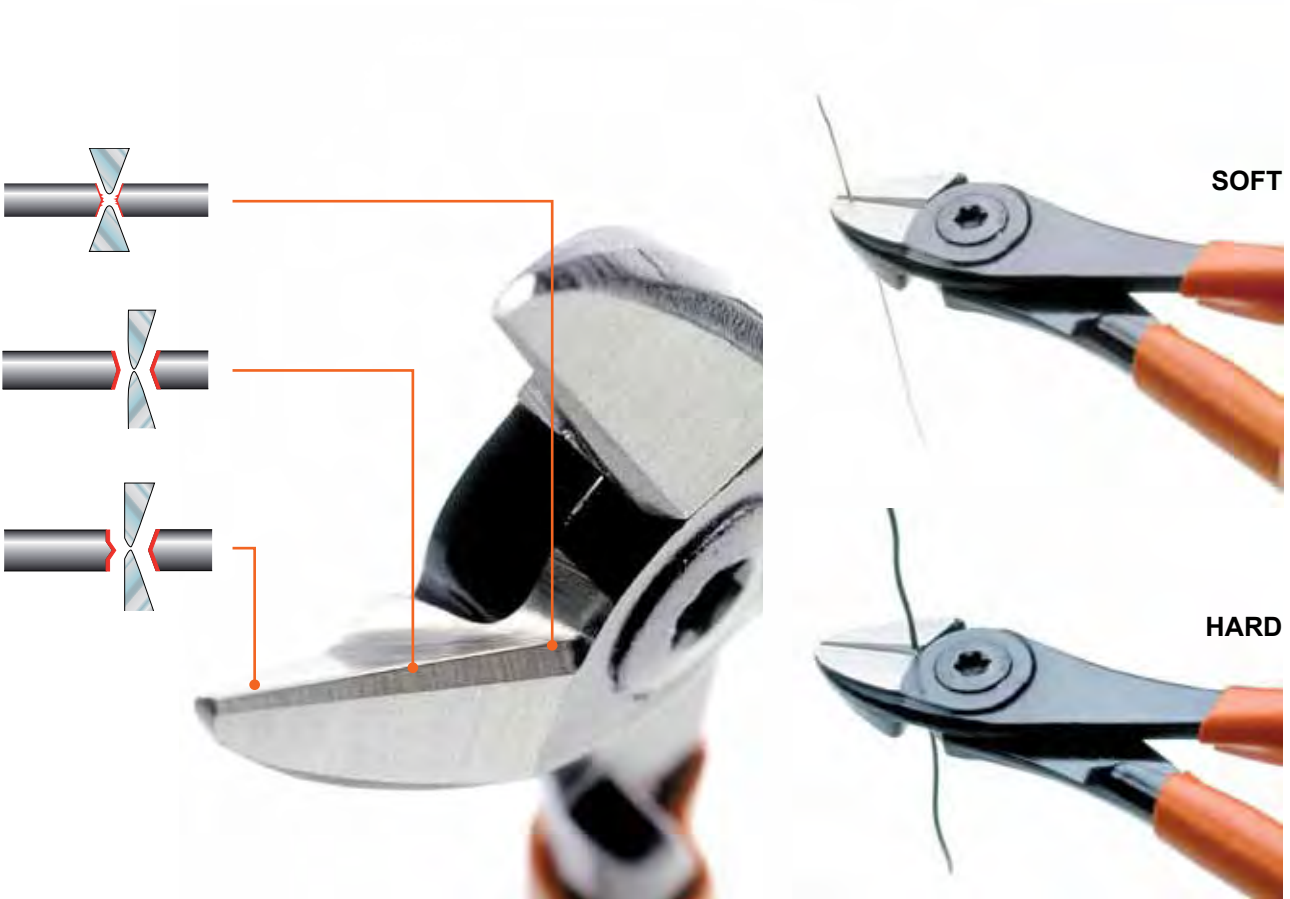

3. EDGE ALIGNMENT - The joint must move easily, yet stay tight without loosening, to achieve optimum cutting accuracy and leverage.

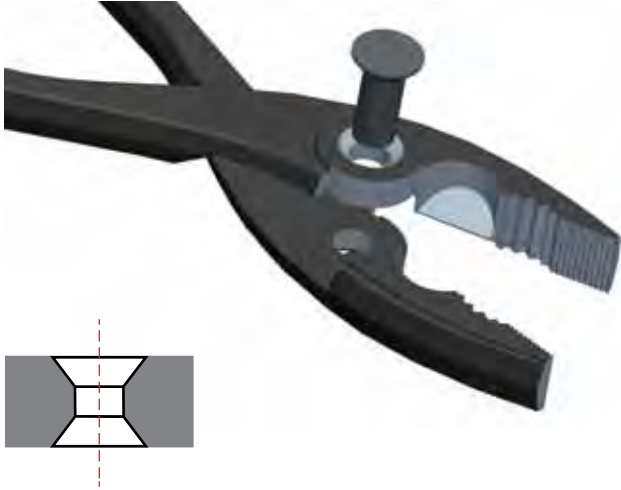

Rivet joints are effective joints for pliers where precision is not a priority.

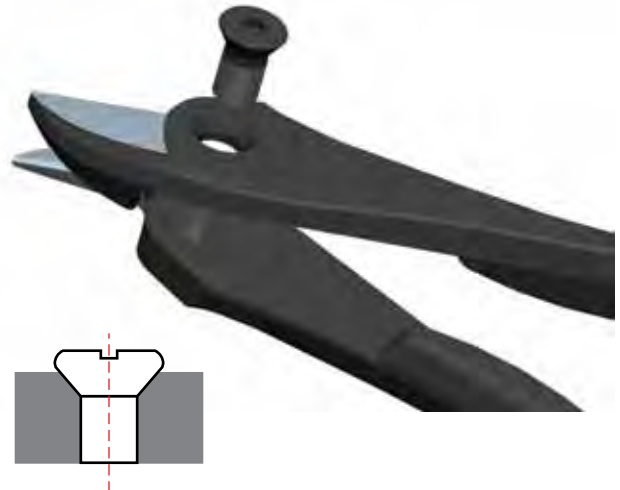

Screw joints allow excellent precision and adjustment for perfect alignment of the cutting edges and maximum cutting accuracy.

4. RETURN SPRING - The Bahco ERGO™ cutters and pliers have return springs, with on/off function.

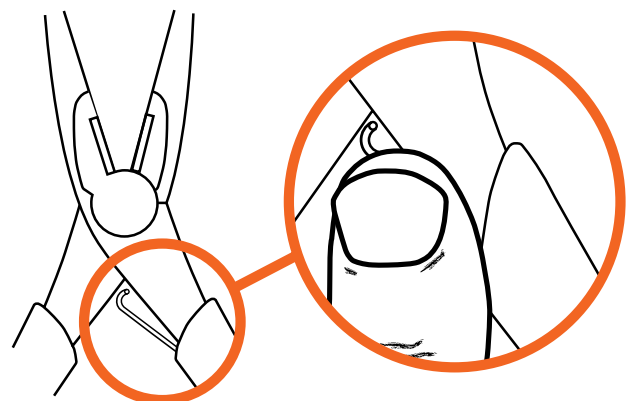

The on-off return spring increases ease of cutting with an automatic opening of the jaws and handles when the grip is loosened.

5. COMFORTABLE GRIPS - High cutting forces and an intensive pace of work place stringent demands on the design of handles for pliers. There are grips suited for every need and user.



PVC coated handles



2-component handles



2-component **ergo**® handles



1000V injected handles



1000V 3-layer insulated handles

6. JAWS - The jaws of Bahco cutters and pliers are designed to suit the intended type of work. Cutters have high-frequency hardened edges, whereas gripping and holding pliers have flat or serrated surfaces to provide a firmer grip.



7. RUSTPROOFING - All Bahco cutters and pliers are subjected to various anti-corrosion treatments, depending on the intended application. The most common methods are black-oxidation with a heat-cured layer of transparent plastic varnish, a drying anti-corrosion oil or chromium plating.



Black-oxidizing is a process that partially protects against rust by covering the metal with a layer of oxide that gives a characteristic deep black colour.



Chrome-plating is a layer of nickel and chrome that protects the pliers from corrosion. If the treatment is not well implemented the layer can peel off. Bahco pliers are tested to ensure that the nickel and chrome layers are perfectly adhered.

PLIERS



Bahco ERGO™ pliers are developed in accordance with the Bahco ERGO™ Process. For more details, please refer to the chapter on ERGO™.

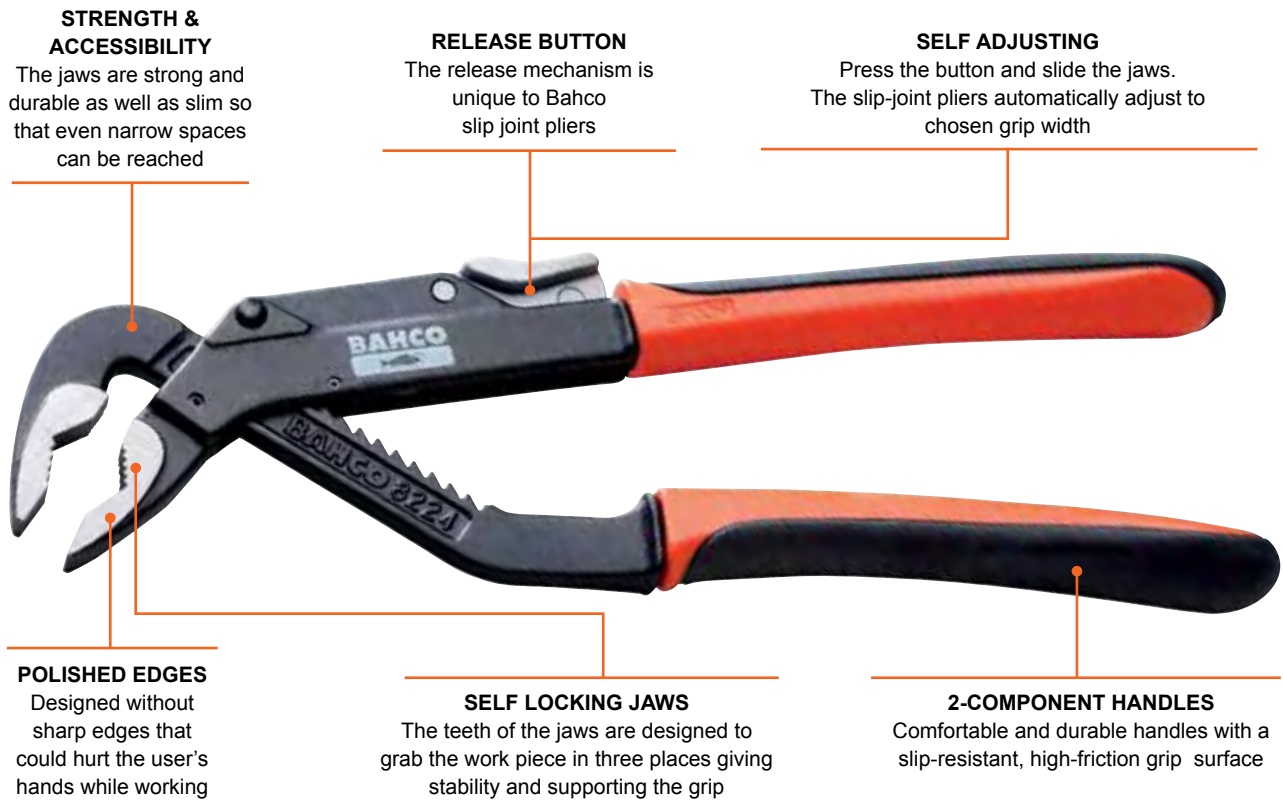
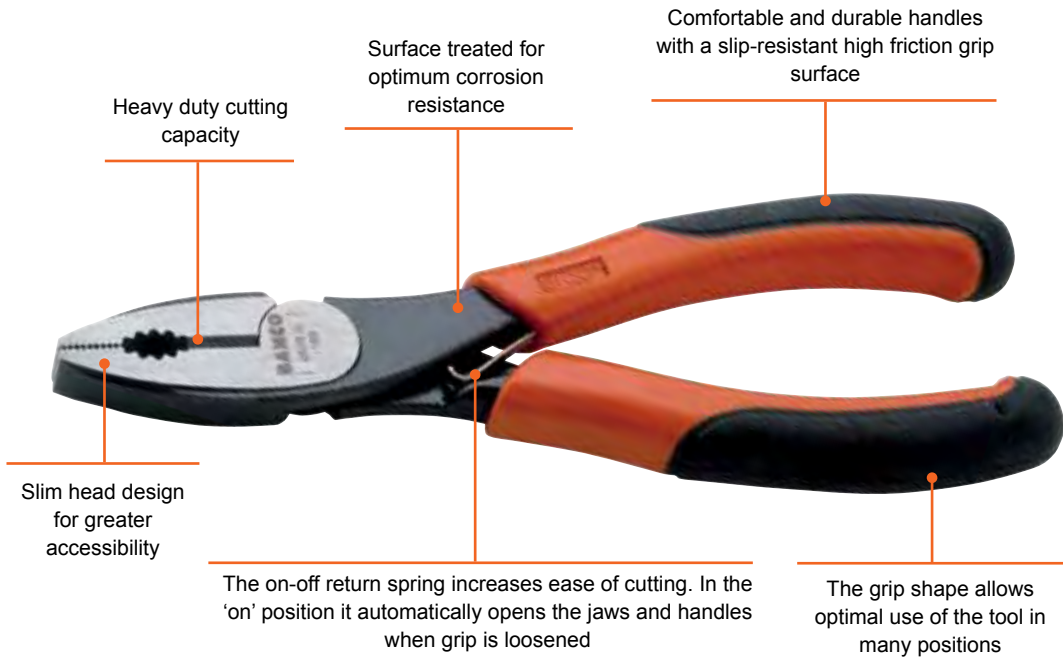

CHOICE OF PLIERS

■ Plastic
 ■ Cu
 ■ Fe
 ■ Fe+
 ■ Piano
 ■ Wire stripping capacity

N/mm² 230 - 250 1600 - 1800 1800 - 2100 2100<

Wire

Ø 0,5 0,6 0,7 0,8 0,9 1,0 1,1 1,2 1,3 1,4 1,5 1,6 1,7 1,8 1,9 2,0 2,1 2,2 2,3 2,4 2,5 2,6 2,7 2,8 2,9 3,0 3,1 3,2 3,3 3,4 3,5 3,6 3,7 3,8 3,9 4,0

SIDE CUTTING PLIERS

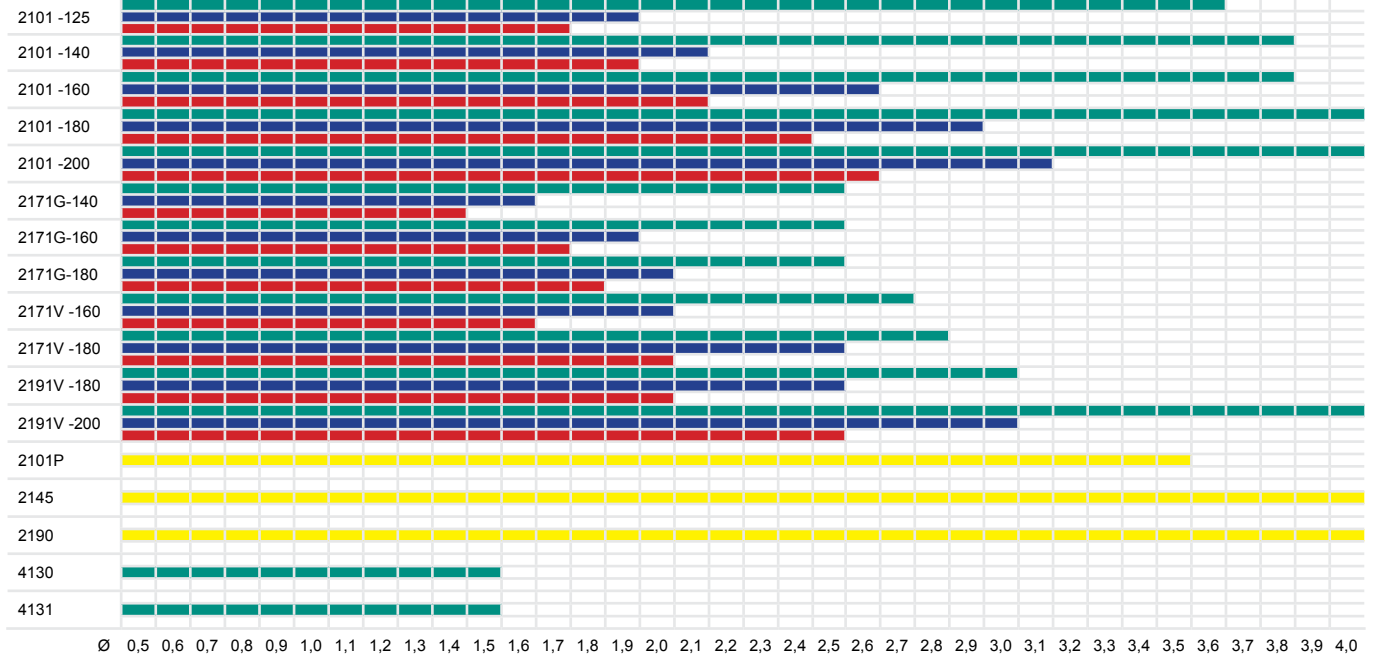

Ø 0,5 0,6 0,7 0,8 0,9 1,0 1,1 1,2 1,3 1,4 1,5 1,6 1,7 1,8 1,9 2,0 2,1 2,2 2,3 2,4 2,5 2,6 2,7 2,8 2,9 3,0 3,1 3,2 3,3 3,4 3,5 3,6 3,7 3,8 3,9 4,0

POWER CUTTER

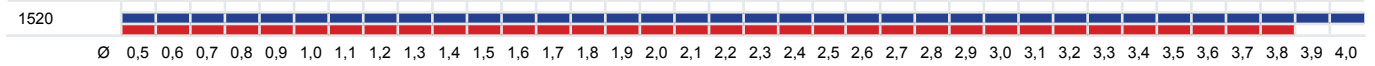

Ø 0,5 0,6 0,7 0,8 0,9 1,0 1,1 1,2 1,3 1,4 1,5 1,6 1,7 1,8 1,9 2,0 2,1 2,2 2,3 2,4 2,5 2,6 2,7 2,8 2,9 3,0 3,1 3,2 3,3 3,4 3,5 3,6 3,7 3,8 3,9 4,0

OBLIQUE CUTTERS

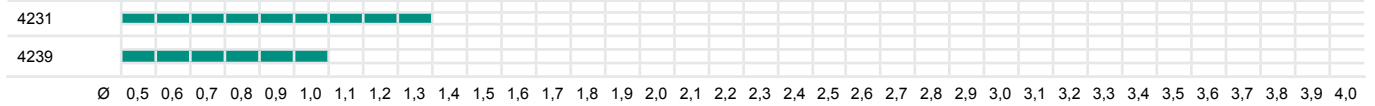

Ø 0,5 0,6 0,7 0,8 0,9 1,0 1,1 1,2 1,3 1,4 1,5 1,6 1,7 1,8 1,9 2,0 2,1 2,2 2,3 2,4 2,5 2,6 2,7 2,8 2,9 3,0 3,1 3,2 3,3 3,4 3,5 3,6 3,7 3,8 3,9 4,0

END CUTTERS

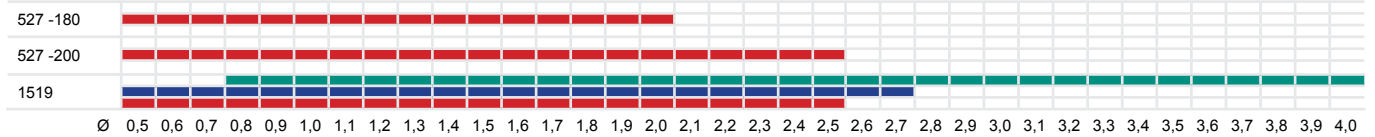

Ø 0,5 0,6 0,7 0,8 0,9 1,0 1,1 1,2 1,3 1,4 1,5 1,6 1,7 1,8 1,9 2,0 2,1 2,2 2,3 2,4 2,5 2,6 2,7 2,8 2,9 3,0 3,1 3,2 3,3 3,4 3,5 3,6 3,7 3,8 3,9 4,0

COMBINATION PLIERS

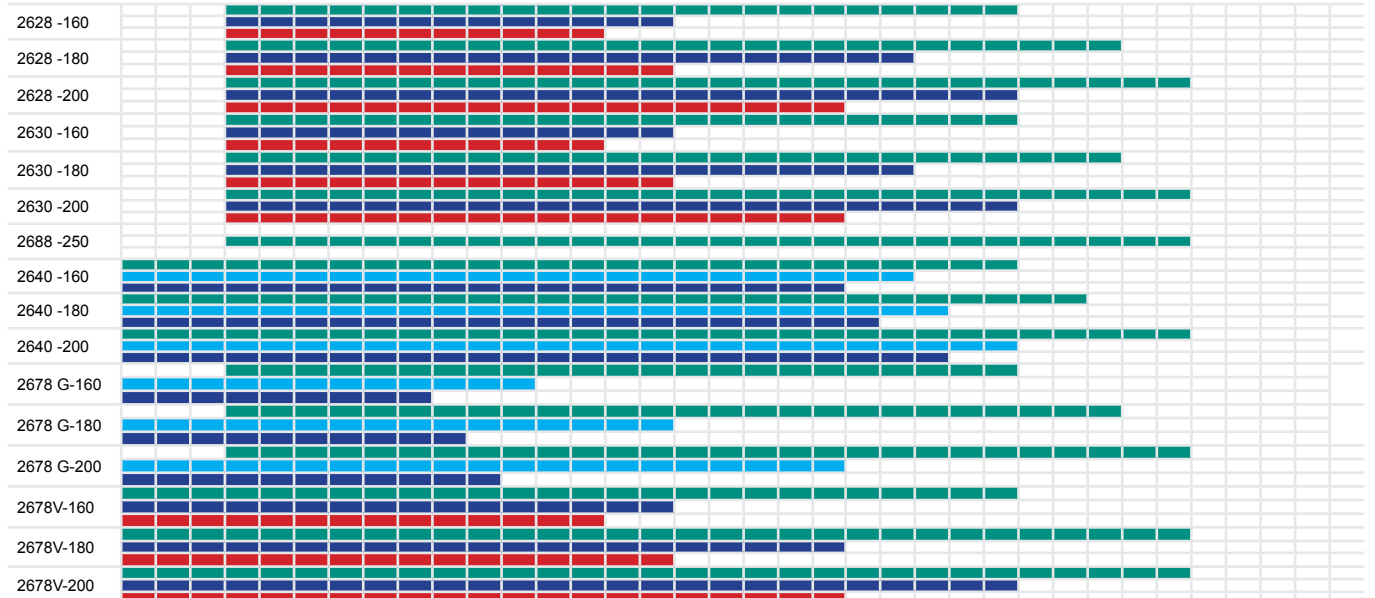

■ Plastic
 ■ Cu
 ■ Fe
 ■ Fe+
 ■ Piano
 ■ Wire stripping capacity

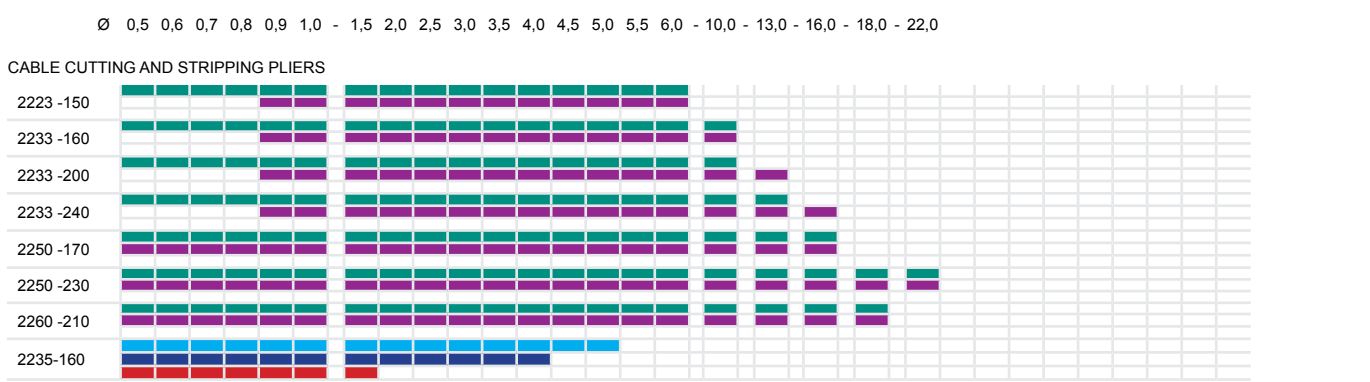
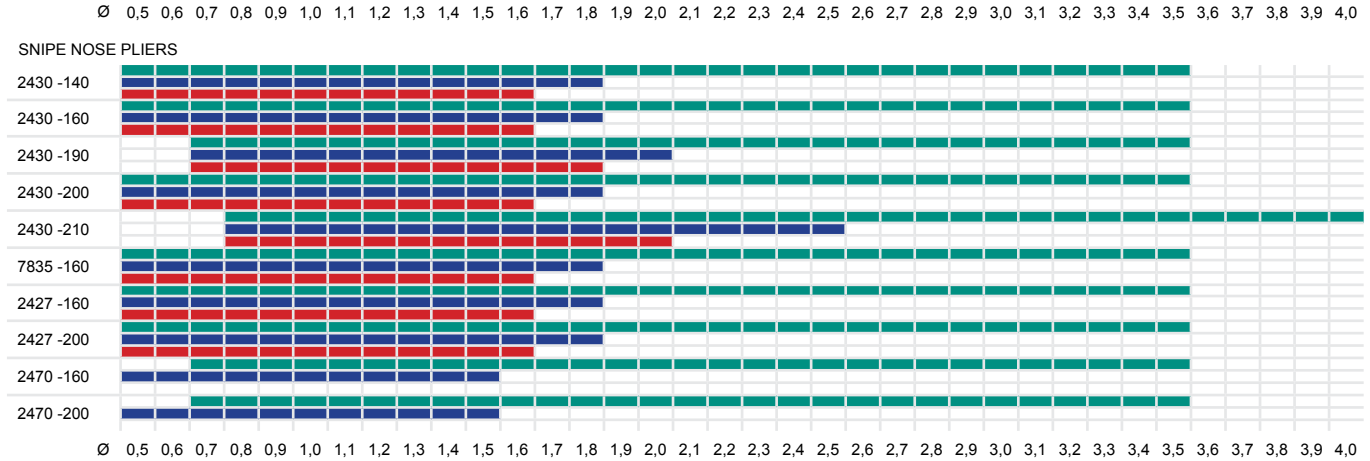
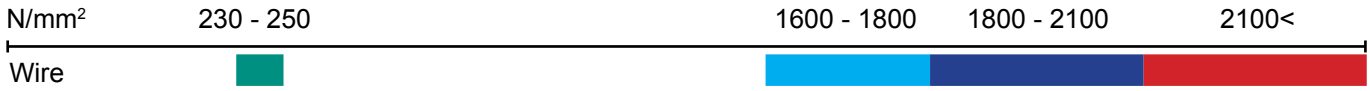

BELZER

Ø 0,5 0,6 0,7 0,8 0,9 1,0 1,1 1,2 1,3 1,4 1,5 1,6 1,7 1,8 1,9 2,0 2,1 2,2 2,3 2,4 2,5 2,6 2,7 2,8 2,9 3,0 3,1 3,2 3,3 3,4 3,5 3,6 3,7 3,8 3,9 4,0 - 6,0

SIDE CUTTING PLIERS

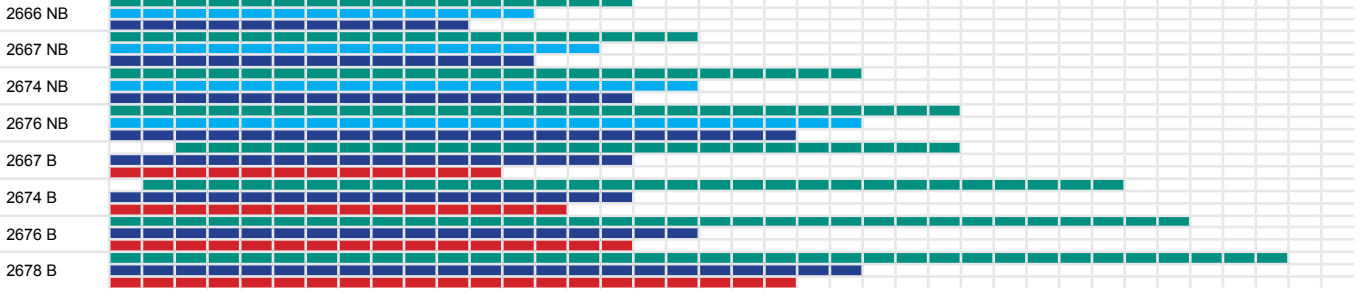

Ø 0,5 0,6 0,7 0,8 0,9 1,0 1,1 1,2 1,3 1,4 1,5 1,6 1,7 1,8 1,9 2,0 2,1 2,2 2,3 2,4 2,5 2,6 2,7 2,8 2,9 3,0 3,1 3,2 3,3 3,4 3,5 3,6 3,7 3,8 3,9 4,0 - 6,0

END CUTTERS

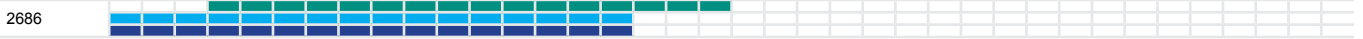

COMBINATION PLIERS

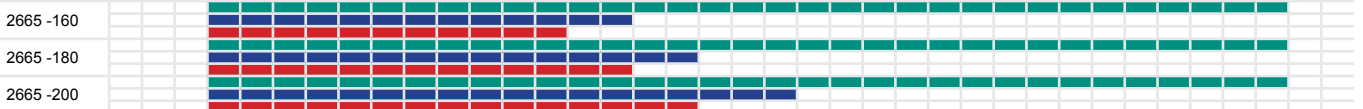

Ø 0,5 0,6 0,7 0,8 0,9 1,0 1,1 1,2 1,3 1,4 1,5 1,6 1,7 1,8 1,9 2,0 2,1 2,2 2,3 2,4 2,5 2,6 2,7 2,8 2,9 3,0 3,1 3,2 3,3 3,4 3,5 3,6 3,7 3,8 3,9 4,0 - 6,0

SNIPE NOSE PLIERS

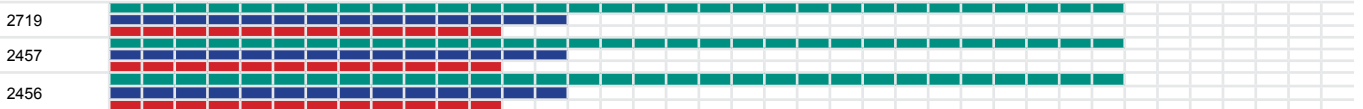

Ø 0,5 0,6 0,7 0,8 0,9 1,0 1,1 1,2 1,3 1,4 1,5 1,6 1,7 1,8 1,9 2,0 2,1 2,2 2,3 2,4 2,5 2,6 2,7 2,8 2,9 3,0 3,1 3,2 3,3 3,4 3,5 3,6 3,7 3,8 3,9 4,0 - 6,0

CABLE CUTTING AND STRIPPING PLIERS

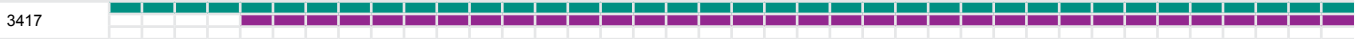



SIDE CUTTERS

2101G

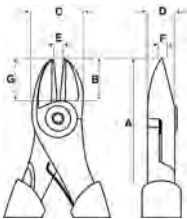

SIDE CUTTING PLIERS

- Side cutting pliers developed according to the scientific ERGO™ process
- ISO 5749
- Finish: Black finish, anti-corrosion treated
- Material: High performance alloy steel, ERGO™ handles with 2-component combination, thermoplastic surface on tough polypropylene which gives superior grip
- Induction hardened cutting edges
- Progressive edges: The cutting radius progresses along the edge in order to cut hard material like piano wire close to the joint and soft materials like copper and plastic insulated wire at the tip
- Screw joint that provides excellent running and accurate alignment of the cutting edges
- The distance from the joint to the centre of the cutting edges is reduced: giving greater leverage and increased cutting capacity
- Round shaped jaws give improved accessibility in confined spaces
- Equipped with a return spring featuring an on/off function
- IP: Industrial packed

			A	B	C	D	E	F	G				
	731415		mm	mm	mm	mm	mm	mm	mm	mm	mm	mm	
2101G-125	0106462	5	125	14	17.5	8	1.0	1.2	14	3.5	1.8	1.6	105
2101G-140	0106479	5	140	16	19.5	9	1.5	1.3	16	3.7	2.0	1.8	126
2101G-160	0106486	5	160	18	21.5	10	2.0	1.5	18	3.8	2.5	2.0	162
2101G-180	0106493	5	180	20	23.5	11	2.5	1.5	20	4.0	2.7	2.3	245
2101G-200	0106509	5	200	22	25.5	11	2.5	1.5	22	4.5	3.0	2.5	304
2101G-125IP	0106516	5	125	14	17.5	8	1.0	1.2	14	3.5	1.8	1.6	105
2101G-140IP	0106288	5	140	16	19.5	9	1.5	1.3	16	3.7	2.0	1.8	126
2101G-160IP	0106295	5	160	18	21.5	10	2.0	1.5	18	3.8	2.5	2.0	162
2101G-180IP	0106523	5	180	20	23.5	11	2.5	1.5	20	4.0	2.7	2.3	245
2101G-200IP	0106530	5	200	22	25.5	11	2.5	1.5	22	4.5	3.0	2.5	304

2101G-A

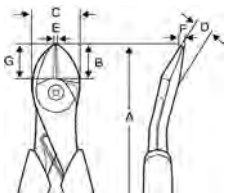

SIDE CUTTING PLIERS

- Side cutting pliers developed according to the scientific ERGO™ process
- ISO 5749
- Finish: Black finish, anti-corrosion treated
- Material: High performance alloy steel, ERGO™ handles with 2-component combination, thermoplastic surface on tough polypropylene which gives superior grip
- Induction hardened cutting edges
- Progressive edges: The cutting radius progresses along the edge in order to cut hard material like piano wire close to the joint and soft materials like copper and plastic insulated wire at the tip
- Screw joint that provides excellent running and accurate alignment of the cutting edges
- The distance from the joint to the centre of the cutting edges is reduced: giving greater leverage and increased cutting capacity
- Round shaped jaws give improved accessibility in confined spaces
- Equipped with a return spring featuring an on/off function
- 14° head angle enables better accessibility

			A	B	C	D	E	F	G				
	731151		mm	mm	mm	mm	mm	mm	mm	mm	mm	mm	
2101G-140A	8269500	5	140	16	19.5	9	1.5	1.3	16	3.7	2.0	1.8	126
2101G-160A	8269517	5	160	18	21.5	10	2.0	1.5	18	3.8	2.5	2.0	162
2101G-180A	8269524	5	180	20	23.5	11	2.5	1.5	20	4.0	2.7	2.3	245



2101G-AHL

SIDE CUTTING PLIERS

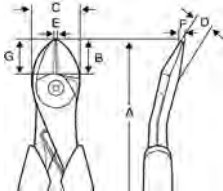

- High leverage side cutting pliers
- ISO 5749
- Finish: Black finish, anti-corrosion treated
- Material: High performance alloy steel, handles with 2-component combination, thermoplastic surface on tough polypropylene which gives superior grip
- Induction hardened cutting edges
- Progressive edges: The cutting radius progresses along the edge in order to cut hard material like piano wire close to the joint and soft materials like copper and plastic insulated wire at the tip
- Screw joint that provides excellent running and accurate alignment of the cutting edges
- High leverage: Redesigned for optimum cutting performance and reduced cutting effort
- Equipped with a return spring featuring an on/off function
- 14° head angle enables better accessibility

			A	B	C	D	E	F	G				
2101G-200AHL	8259921	5	200	21	29	11	2.5	1.5	21	4.5	3.0	2.5	304

2101GC

SIDE CUTTING PLIERS

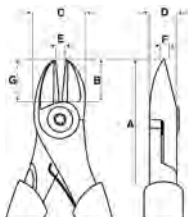

- Side cutting pliers developed according to the scientific ERGO™ process
- ISO 5749
- Finish: Nickel-chrome plated, anti-corrosion treated
- Material: High performance alloy steel
- ERGO™ handles with 2-component combination, thermoplastic surface on tough polypropylene which gives superior grip
- Induction hardened cutting edges
- Progressive edges: The cutting radius progresses along the edge in order to cut hard material like piano wire close to the joint and soft materials like copper and plastic insulated wire at the tip
- Screw joint that provides excellent running and accurate alignment of the cutting edges
- The distance from the joint to the centre of the cutting edges is reduced: giving greater leverage and increased cutting capacity
- Round shaped jaws give improved accessibility in confined spaces
- Equipped with a return spring featuring an on/off function
- IP: Industrial packed

			A	B	C	D	E	F	G				
2101GC-125IP	0106547	5	125	14	17.5	8	1.0	1.2	14	3.5	1.8	1.6	105
2101GC-140IP	0106554	5	140	16	19.5	9	1.5	1.3	16	3.7	2.0	1.8	126
2101GC-160IP	0106561	5	160	18	21.5	10	2.0	1.5	18	3.8	2.5	2.0	162
2101GC-180IP	0106578	5	180	20	23.5	11	2.5	1.5	20	4.0	2.7	2.3	245
2101GC-200IP	0106585	5	200	22	25.5	11	2.5	1.5	22	4.5	3.0	2.5	304



SIDE CUTTERS

2101PG

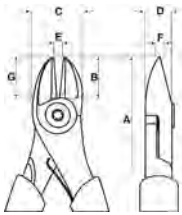

SIDE CUTTING PLIERS

- Side cutting pliers developed according to the scientific ERGO™ process
- Dimensions according to ISO 5749
- Finish: Black finish, anti-corrosion treated
- Material: High performance alloy steel. ERGO handles with 2-component combination, thermoplastic surface on tough polypropylene which gives superior grip
- Induction hardened cutting edges
- Full flush cutting edge without bevelling which is designed to smoothly cut all kinds of plastic parts such as the flash of plastic component
- Screw joint that provides excellent running and accurate alignment of the cutting edges
- Round shaped jaws give improved accessibility in confined spaces
- Equipped with a return spring featuring an on/off function
- Max cutting capacity: Cu 1.5 mm and plastic material PA (Nylon) 3 mm

			A	B	C	D	E	F	G	
	731415		mm	mm	mm	mm	mm	mm	mm	
2101PG-160	0113972	5	160	18	21.5	10	2.0	1.5	18	162

2101D

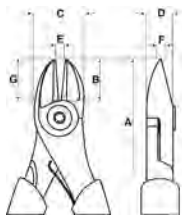

SIDE CUTTING PLIERS

- ISO 5749
- Finish: Black finish, anti-corrosion treated
- Material: High performance alloy steel, PVC coated handles
- Induction hardened cutting edges
- Progressive edges: The cutting radius progresses along the edge in order to cut hard material like piano wire close to the joint and soft materials like copper and plastic insulated wire at the tip
- Screw joint that provides excellent running and accurate alignment of the cutting edges
- The distance from the joint to the centre of the cutting edges is reduced, giving greater leverage and increased cutting capacity
- Round shaped jaws give improved accessibility in confined spaces
- IP: Industrial packed

			A	B	C	D	E	F	G				
	731415		mm	mm	mm	mm	mm	mm	mm	mm	mm	mm	
2101D-125	0106387	5	125	14	17.5	8	1.0	1.2	14	3.5	1.8	1.6	104
2101D-140	0106394	5	140	16	19.5	9	1.5	1.3	16	3.7	2.0	1.8	107
2101D-160	0106400	5	160	18	21.5	10	2.0	1.5	18	3.8	2.5	2.0	144
2101D-180	0106417	5	180	20	23.5	11	2.5	1.5	20	4.0	2.7	2.3	235
2101D-200	0106424	5	200	22	25.5	11	2.5	1.5	22	4.5	3.0	2.5	282
2101D-125IP	0106431	5	125	14	17.5	8	1.0	1.2	14	3.5	1.8	1.6	104
2101D-140IP	0106325	5	140	16	19.5	9	1.5	1.3	16	3.7	2.0	1.8	107
2101D-160IP	0106318	5	160	18	21.5	10	2.0	1.5	18	3.8	2.5	2.0	144
2101D-180IP	0106448	5	180	20	23.5	11	2.5	1.5	20	4.0	2.7	2.3	235
2101D-200IP	0106455	5	200	22	25.5	11	2.5	1.5	22	4.5	3.0	2.5	282



2145PD

SIDE CUTTING PLIERS



PLASTIC

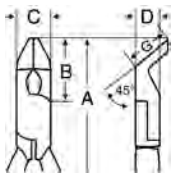

- Side cutting pliers for plastic and other soft materials
- Finish: Black finish, anti-corrosion treated
- Material: Carbon steel and PVC coated handles
- Shape: 45° angled plane cutting edge for improved accessibility
- Full flush cutting edges without bevelling which are designed to smoothly cut all kinds of plastic parts e.g. the flash of plastic components
- With opening spring
- Max cutting capacity: Cu 1.8 mm and plastic material PA (Nylon) 3 mm

			A mm	B mm	C mm	D mm	G mm	
2145PD-150	731415	5	154	21	15	11	17	135

2190PD

SIDE CUTTING PLIERS



PLASTIC

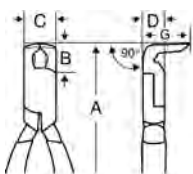

- Oblique cutting pliers for plastic and other soft materials
- Finish: Black finish, polished head, anti-corrosion treated
- Material: Carbon steel and PVC coated handles
- Shape: 90° angled plane cutting edge for improved accessibility
- Full flush cutting edges without bevelling which are designed to smoothly cut all kinds of plastic parts e.g. the flash of plastic components
- With opening spring
- Max cutting capacity: Cu 1.8 mm and plastic material PA (Nylon) 3 mm

			A mm	B mm	C mm	D mm	G mm	
2190PD-150	731415	5	143	11.5	15	11	20	135



SIDE CUTTERS

2101S



IEC 60900 1000V

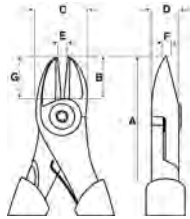

SIDE CUTTING PLIERS

- Insulated side cutting pliers
- ISO 5749, IEC 60900
- Finish: Black finish, anti-corrosion treated
- Material: High performance alloy steel, plastic injected handles
- Induction hardened cutting edges
- Progressive edges: The cutting radius progresses along the edge in order to cut hard material like piano wire close to the joint and soft materials like copper and plastic insulated wire at the tip
- Screw joint that provides excellent running and accurate alignment of the cutting edges
- The distance from the joint to the centre of the cutting edges is reduced, giving greater leverage and increased cutting capacity
- Round shaped jaws give improved accessibility in confined spaces

			A mm	B mm	C mm	D mm	E mm	F mm	G mm				
	731415												
	0106592	3	140	16	19.5	9	1.5	1.3	16	3.7	2.0	1.8	126
	0106608	3	160	18	21.5	10	2.0	1.5	18	3.8	2.5	2.0	162
	0106615	3	180	20	23.5	11	2.5	1.5	20	4.0	2.7	2.3	245
	0106622	3	200	22	25.5	11	2.5	1.5	22	4.5	3.0	2.5	304

2666NB-2676NB

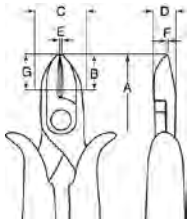

SIDE CUTTING PLIERS

- Side cutting pliers with external edge bevel
- ISO 5749
- Finish: Nickel-chrome plated, fine-polished, anti-corrosion treated
- Material: Vanadium-extra, handles are orange, transparent cellulose acetate
- Induction hardened cutting edges
- Screw joint that provides excellent running and accurate alignment of the cutting edges

			A mm	B mm	C mm	D mm	E mm	F mm	G mm					
	731415													
	1066093	1	125	16	16	8.0	1.5	1.2	16	2.0	1.7	1.5	-	100
	1066192	1	140	17	18	8.5	1.8	1.2	17	2.2	1.9	1.7	-	145
	1066321	1	160	18	20	10.0	2.0	1.2	18	2.7	2.2	2.0	-	200
	1066413	1	180	21	22	11.0	2.1	1.2	21	3.0	2.7	2.0	-	250

2667B-2678B

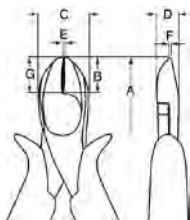

SIDE CUTTING PLIERS

- Heavy duty side cutting pliers with external edge bevel
- ISO 5749
- Finish: Nickel-chrome plated, fine-polished, anti-corrosion treated
- Material: Vanadium-extra, handles are orange, transparent cellulose acetate
- Induction hardened cutting edges
- Screw joint that provides excellent running and accurate alignment of the cutting edges

			A mm	B mm	C mm	D mm	E mm	F mm	G mm					
	731415													
	1066154	1	125	14	18	8.0	1.5	1.2	14	3.0	2.0	1.6	1.6	120
	1066307	1	140	17	20	10.0	2.0	1.5	17	3.5	2.0	1.8	1.8	150
	1066390	1	160	19	23	11.0	2.1	2.0	19	3.7	2.2	2.0	2.0	215
	1066468	1	200	21	26	11.0	2.1	2.0	21	4.0	2.7	2.5	2.5	325



2667NVDE-2676NVDE

SIDE CUTTING PLIERS



- Insulated side cutting pliers with external edge bevel
- ISO 5749, IEC 60900
- Finish: Nickel-chrome plated, fine-polished, anti-corrosion treated
- Material: Vanadium-extra, handles are red, transparent cellulose acetate
- Induction hardened cutting edges
- Screw joint that provides excellent running and accurate alignment of the cutting edges

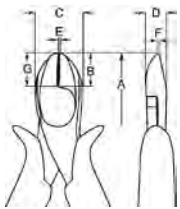

			A	B	C	D	E	F	G					
	731415		mm	mm	mm	mm	mm	mm	mm	mm	mm	mm	mm	
2667 NVDE	1497996	1	140	17	18	8.5	1.8	1.2	17	3.5	2.0	1.8	1.8	150
2674 NVDE	1498535	1	160	18	20	10.0	2.0	1.2	18	3.7	2.2	2.0	2.0	205
2676 NVDE	1498962	1	180	21	22	11.0	2.1	1.2	21	4.0	2.7	2.5	2.5	255

2171G

SIDE CUTTING PLIERS



- ISO 5749
- Finish: Polished and oiled
- Material: High performance alloy steel, 2-component handles for added comfort

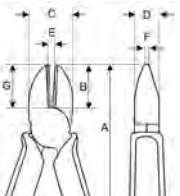

			A	B	C	D	E	F	G				
	731415		mm	mm	mm	mm	mm	mm	mm	mm	mm	mm	
2171G-140	0116232	5	150	18.5	20	10.5	2	1.5	18.5	2.5	1.6	1.5	170
2171G-160	0116133	5	165	20	22	12	2.5	1.5	20	2.5	1.6	1.5	240
2171G-180	0116140	5	185	22	24	12	3	1.5	22	2.5	1.6	1.5	290

1520G

SIDE CUTTING PLIERS



- Power cutter with centric precision cutting edges
- Finish: Black finish anti-corrosion treated
- Material: High performance alloy steel, handles in 2-component thermoplastic elastomer surface on tough polypropylene which gives a superior grip
- Forged with cutting edges for piano, hard and soft wire
- High leverage giving exceptional cutting performance with minimum effort
- The precision cutting edges are additionally induction hardened 63-64 HRC

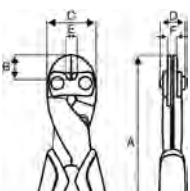

			A	B	C	D	E	F		
	731151		mm	mm	mm	mm	mm	mm	mm	
1520 G	8266516	5	210	16	33.5	17.1	8	6	3.8	310



SIDE CUTTERS

1520D

SIDE CUTTING PLIERS



- Power cutter with centric precision cutting edges
- Finish: Black finish anti-corrosion treated
- Material: High performance alloy steel, PVC coated handles
- Forged with cutting edges for piano, hard and soft wire
- High leverage giving exceptional cutting performance with minimum effort
- The precision cutting edges are additionally induction hardened 63-64 HRC

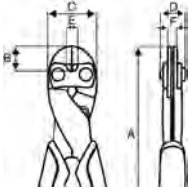

			A mm	B mm	C mm	D mm	E mm	F mm		
1520 D	731151 8278922	5	205	16	33.5	17.1	8	6	Piano mm 3.8	300



END CUTTERS

527D

END CUTTING PLIERS

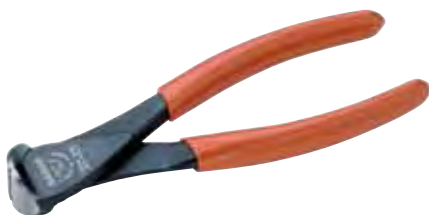

- ISO 5748
- Finish: Black finish, anti-corrosion treated
- Material: High performance alloy steel
- Handles of orange PVC

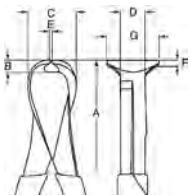

			A mm	B mm	C mm	D mm	E mm	F mm	G mm		
527 D-160	731415 0032723	3	160	7	26.5	11	3.0	3.0	21	Piano mm 2.0	205
527 D-200	0032730	3	200	7	35	13	3.0	3.0	29.5	2.5	320

2686

END CUTTING PLIERS



- ISO 5748
- Finish: Nickel and chrome plated, anti-corrosion treated, fine-polished
- Material: Vanadium-extra, handles of orange PVC

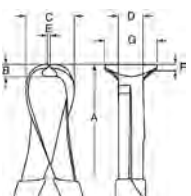

			A mm	B mm	C mm	D mm	E mm	F mm	G mm		
2686	731415 1066598	1	160	13	20	11	2.0	2.0	28	Piano mm 2.0	185



2628G

ergo®

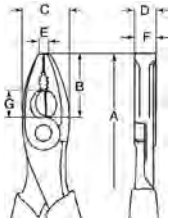

COMBINATION PLIERS

- Combination pliers developed according to the scientific ERGO™ process
- ISO 5746
- Finish: Black finish, anti-corrosion treated
- Material: High performance alloy steel
- ERGO™ handles with 2-component combination, thermoplastic surface on tough polypropylene which gives superior grip
- Edges specially designed to cut harder material such as piano wire and spring steel wire
- Gripping surfaces particularly suited for gripping round and flat material
- Round shaped jaws give improved accessibility in confined spaces
- The distance from the joint to the centre of the cutting edges is reduced: giving leverage and increased cutting capacity
- Equipped with a return spring featuring an on/off function
- IP: Industrial packed

			A mm	B mm	C mm	D mm	E mm	F mm	G mm			
2628 G-160	0042999	5	160	33	23	10.5	3.5	10.5	12	2.0	1.8	190
2628 G-180	0042678	5	180	36	25	11.0	4.0	11.0	14	2.5	2.0	240
2628 G-200	0103539	5	200	39	27	12.0	4.5	12.0	16	3.0	2.5	300
2628 G-160IP	0055357	5	160	33	23	10.5	3.5	10.5	12	2.0	1.8	190
2628 G-180IP	0044030	5	180	36	25	11.0	4.0	11.0	14	2.5	2.0	240
2628G-200IP	0101085	5	200	39	27	12.0	4.5	12.0	16	3.0	2.5	300

2628GC

ergo®

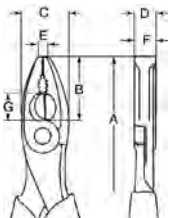

COMBINATION PLIERS

- Combination pliers developed according to the scientific ERGO™ process
- ISO 5746
- Finish: Chrome plated, anti-corrosion treated
- Material: High performance alloy steel
- ERGO™ handles with 2-component combination, thermoplastic surface on tough polypropylene which gives superior grip
- Edges specially designed to cut harder material such as piano wire and spring steel wire
- Gripping surfaces particularly suited for gripping round and flat material
- Round shaped jaws give improved accessibility in confined spaces
- The distance from the joint to the centre of the cutting edges is reduced: giving leverage and increased cutting capacity
- Equipped with a return spring featuring an on/off function
- IP: Industrial packed

			A mm	B mm	C mm	D mm	E mm	F mm	G mm			
2628 GC-160IP	0101863	5	160	33	23	10.5	3.5	10.5	12	2.0	1.8	190
2628 GC-180IP	0101870	5	180	36	25	11.0	4.0	11.0	14	2.5	2.0	240
2628 GC-200IP	0101887	5	200	39	27	12.0	4.5	12.0	16	3.0	2.5	300



COMBINATION PLIERS

2628D

COMBINATION PLIERS

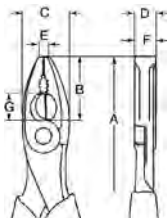

- ISO 5746
- Finish: Black finish, anti-corrosion treated
- Material: High performance alloy steel, PVC coated handles
- Edges specially designed to cut harder material such as piano wire and spring steel wire
- Gripping surfaces particularly suited for gripping round and flat material
- Round shaped jaws give improved accessibility in confined spaces
- The distance from the joint to the centre of the cutting edges is reduced, giving greater leverage and increased cutting capacity

	 731415		A mm	B mm	C mm	D mm	E mm	F mm	G mm	 Fe+ mm	 Piano mm	 g
2628 D-160	0123193	5	160	33	23	11	3.5	10.5	12	2.0	1.8	190
2628 D-180	0042661	5	180	36	25	11	4	11	14	2.5	2.0	240
2628 D-200	0123315	5	200	41	29	12	4.5	12.0	16	3.0	2.5	290

2628S

COMBINATION PLIERS



IEC 60900 1000V

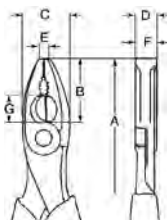

- Insulated combination pliers
- ISO 5746, IEC 60900
- Finish: Black finish, anti-corrosion treated
- Material: High performance alloy steel, plastic injected handles
- Edges specially designed to cut harder material such as piano wire and spring steel wire
- Gripping surfaces particularly suited for gripping round and flat material
- Round shaped jaws give improved accessibility in confined spaces
- The distance from the joint to the centre of the cutting edges is reduced: giving greater leverage and increased cutting capacity

	 731415		A mm	B mm	C mm	D mm	E mm	F mm	G mm	 Fe+ mm	 Piano mm	 g
2628 S-180	0044054	3	180	36	25	11	4.0	11	14	2.5	2.0	240
2628 S-200	0043002	3	200	39	27	12	4.5	12	16	3.0	2.5	300



2630GC

ergo®

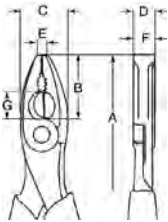

COMBINATION PLIERS

- Combination pliers developed according to the scientific ERGO™ process
- ISO 5746
- Finish: Chrome plated, anti-corrosion treated
- Material: High performance alloy steel
- ERGO™ handles with 2-component combination, thermoplastic surface on tough polypropylene which gives superior grip
- Reinforced cutting edges specially designed to cut harder material such as piano wire and spring steel wire
- Gripping surfaces particularly suited for gripping round and flat material
- Round shaped jaws give improved accessibility in confined spaces
- The distance from the joint to the centre of the cutting edges is reduced: greater leverage and increased cutting capacity
- Equipped with a return spring featuring an on/off function
- IP: Industrial packed

			A mm	B mm	C mm	D mm	E mm	F mm	G mm			
2630GC-160IP	0180165	1	160	33	23	11.5	3.5	10.5	12	2.0	1.8	190
2630GC-180IP	0180172	1	180	36	25	11.0	4.0	12.0	14	2.5	2.0	240
2630GC-200IP	0180189	1	200	39	27	13.0	4.5	12.0	16	3.0	2.5	300

2630D

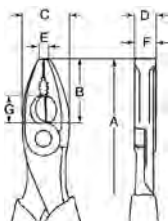
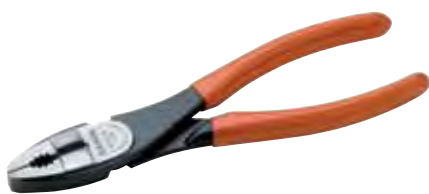

COMBINATION PLIERS

- ISO 5746
- Finish: Black finish, anti-corrosion treated
- Material: High performance alloy steel, PVC coated handles
- Reinforced cutting edges specially designed to cut harder material such as piano wire and spring steel wire
- Gripping surfaces particularly suited to gripping round and flat material
- Round shaped jaws give improved accessibility in confined spaces
- The distance from the joint to the centre of the cutting edges is reduced, giving greater leverage and increased cutting capacity

			A mm	B mm	C mm	D mm	E mm	F mm	G mm			
2630D-160	0123612	5	160	33	23	11.5	3.5	10.5	12	2.0	1.8	190
2630D-180	0123681	5	180	36	25	12.0	4.0	11.0	14	2.5	2.0	240
2630D-200	0123728	5	200	39	27	13.0	4.5	12.0	16	3.0	2.5	300



COMBINATION PLIERS

2688D

COMBINATION PLIERS



- Finish: Black finish, anti-corrosion treated
- Material: High performance alloy steel, PVC coated handles
- Application: Crimping die behind hinge for superior leverage when crimping
- The edges designed to cut medium hard wire
- Gripping surfaces particularly suited to flat material

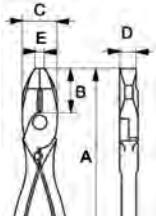

			A mm	B mm	C mm	D mm	E mm	
2688D-250	731415	1	250	41	32	16	8	480

2640D

COMBINATION PLIERS



- ISO 5746
- Finish: Black finish, anti-corrosion treated
- Material: High performance alloy steel, PVC coated handles
- Traditional linesmen pliers, edges designed to cut medium hard wire
- Gripping surfaces particularly suited to flat material

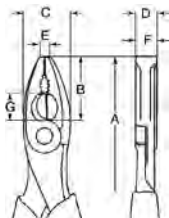

			A mm	B mm	C mm	D mm	E mm	F mm	G mm				
2640D-160	731415	10	160	26	22	10	6	10	13	3.0	2.7	2.5	160
2640D-180	0123773	5	180	30	25	12	7	12	16	3.0	2.7	2.5	240
2640D-200	0123797	5	200	34	27	14	7	14	18	3.5	3.0	2.5	330

2665B

COMBINATION PLIERS



- ISO 5746
- Finish: Nickel and chrome plated, fine-polished
- Material: Vanadium-extra, handles are orange, transparent cellulose acetate
- "Open" joint, in which the distance from the joint centre to the cutting edges is reduced, results in greater leverage and increased cutting capacity
- Round shaped jaws give improved accessibility in confined spaces
- Edges specially designed to cut harder material such as piano wire and spring steel wire
- Gripping surfaces particularly suited for gripping round and flat material

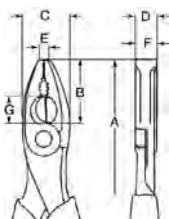

			A mm	B mm	C mm	D mm	E mm	F mm	G mm			
2665 B-160	731415	1	160	33	23	10.0	3	10.0	12	2.0	1.8	190
2665 B-180	1066017	1	180	36	25	10.5	4	10.5	14	2.5	2.0	240
2665 B-200	1066024	1	200	38	25	11.0	4	11.0	15	3.0	2.5	300



2665VDE

COMBINATION PLIERS

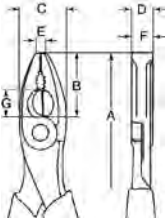

- Insulated combination pliers
- ISO 5746, IEC 60900
- Finish: Nickel-chrome plated, fine-polished, anti-corrosion treated
- Material: Vanadium-extra, handles are red, transparent cellulose acetate
- “Open” joint, in which the distance from the joint centre to the cutting edges is reduced, results in greater leverage and increased cutting capacity
- Round shaped jaws give improved accessibility in confined spaces
- Edges specially designed to cut harder material such as piano wire and spring steel wire
- Gripping surfaces particularly suited for gripping round and flat material

			A mm	B mm	C mm	D mm	E mm	F mm	G mm			
2665 VDE-160	731415 1542023	1	160	33	23	10.0	3	10.0	12	2.0	1.8	190
2665 VDE-180	1498610	1	180	36	25	10.5	4	10.5	14	2.5	2.0	240
2665 VDE-200	1498887	1	200	38	25	11.0	4	11.0	15	3.0	2.5	300

2678G

COMBINATION PLIERS

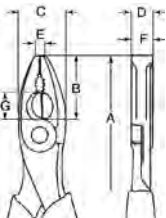

- ISO 5746
- Finish: Polished and lacquered for extra rust protection
- Material: High performance alloy steel, 2-component handles

			A mm	B mm	C mm	D mm	E mm	F mm	G mm			
2678 G-160	731415 0116157	5	160	35	24	10	6	10	35	1.7	1.3	195
2678 G-180	0116164	5	180	38	27	11	7	11	38	2.0	1.4	2.25
2678 G-200	0116171	5	205	43	30	12	7	12	43	2.5	1.5	300



SNIPE NOSE PLIERS

2430G

SNIPE NOSE PLIERS

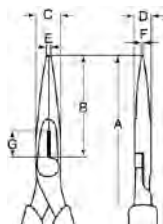

- Snipe nose pliers developed according to the scientific ERGO™ process
- ISO 5745
- Finish: Black finish, anti-corrosion treated
- Material: High performance alloy steel
- ERGO™ handles with 2-component combination, thermoplastic surface on tough polypropylene which gives superior grip
- Slim semicircular shaped and serrated jaws
- Sharp edges for cutting softer material such as copper and plastic insulated wire
- Tips give a good grip and improved accessibility in confined spaces
- Equipped with a return spring featuring an on/off function
- IP: Industrial packed

			A mm	B mm	C mm	D mm	E mm	F mm	G mm				
	731415												
2430 G-140	0102563	5	140	39	15	8	2.5	2.0	12	2.5	1.8	1.4	120
2430 G-160	0024070	5	160	49	16	8	3.0	2.5	12	3.0	1.8	1.6	160
2430 G-200	0100422	5	200	72	17	9	4.0	2.5	12	3.0	1.8	1.6	170
2430 G-140 IP	0102143	5	140	39	15	8	2.5	2.0	12	2.5	1.8	1.4	120
2430 G-160 IP	0100811	5	160	49	16	8	3.0	2.5	12	3.0	1.8	1.6	160
2430 G-200 IP	0100835	5	200	72	17	9	4.0	2.5	12	3.0	1.8	1.6	170

2430GC

SNIPE NOSE PLIERS

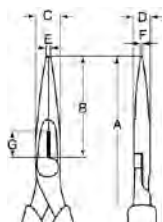

- Snipe nose pliers developed according to the scientific ERGO™ process
- ISO 5745
- Finish: Chrome plated, anti-corrosion treated
- Material: High performance alloy steel
- ERGO™ handles with 2-component combination, thermoplastic surface on tough polypropylene which gives superior grip
- Slim semicircular shaped and serrated jaws
- Sharp edges for cutting softer material such as copper and plastic insulated wire
- Tips give a good grip and improved accessibility in confined spaces
- Equipped with a return spring featuring an on/off function
- IP: Industrial packed

			A mm	B mm	C mm	D mm	E mm	F mm	G mm				
	731415												
2430 GC-140 IP	0102150	5	140	39	15	8	2.5	2.0	12	2.5	1.8	1.4	120
2430 GC-160 IP	0102167	5	160	49	16	8	3.0	2.5	12	3.0	1.8	1.6	160
2430 GC-200 IP	0102174	5	200	72	17	9	4.0	2.5	12	3.0	1.8	1.6	170



2430G-HD

SNIPE NOSE PLIERS

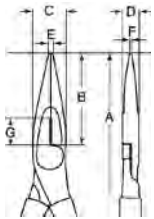

- Heavy-duty snipe nose pliers developed according to the scientific ERGO™ process
- ISO 5745
- Finish: Black finish, anti-corrosion treated
- Material: High performance alloy steel
- ERGO™ handles with 2-component combination, thermoplastic surface on tough polypropylene which gives superior grip
- Withstands 50% higher torque compared to regular snipe nose
- Sharp edges for cutting softer material such as copper and plastic insulated wire
- Tips give a good grip and improved accessibility in confined spaces
- Equipped with a return spring featuring an on/off function

			A mm	B mm	C mm	D mm	E mm	F mm	G mm				
2430 G-190HD	731151	5	190	62	17	9	3.0	2.5	12	3.0	1.8	1.6	170
2430 G-210HD	8259952	5	210	60	23	12	3.8	3.1	16	4.0	2.5	2.0	270

2430D

SNIPE NOSE PLIERS

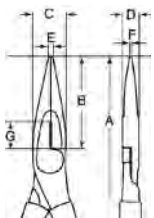

- ISO 5745
- Finish: Black finish, anti-corrosion treated
- Material: High performance alloy steel, PVC coated handles
- Slim semicircular shaped and serrated jaws
- Sharp edges for cutting softer material such as copper and plastic insulated wire
- Tips give a good grip and improved accessibility in confined spaces
- IP: Industrial packed

			A mm	B mm	C mm	D mm	E mm	F mm	G mm				
2430 D-140	0032853	5	140	39	15	8	2.5	2.0	12	2.5	1.8	1.4	120
2430 D-160	0032860	5	160	49	16	8	3.0	2.5	12	3.0	1.8	1.6	160
2430 D-200	0032884	5	200	72	17	9	4.0	2.5	12	3.0	1.8	1.6	170
2430 D-140 IP	0100774	5	140	39	15	8	2.5	2.0	12	2.5	1.8	1.4	120
2430 D-160 IP	0100781	5	160	49	16	8	3.0	2.5	12	3.0	1.8	1.6	160
2430 D-200 IP	0100804	5	200	72	17	9	4.0	2.5	12	3.0	1.8	1.6	170



SNIPE NOSE PLIERS

2430S

SNIPE NOSE PLIERS



- Insulated snipe nose pliers
- ISO 5745, IEC 60900
- Finish: Black finish, anti-corrosion treated
- Material: High performance alloy steel, plastic injected handles
- Slim semicircular shaped and serrated jaws
- Sharp edges for cutting softer material such as copper and plastic insulated wire
- Tips give a good grip and improved accessibility in confined spaces

IEC 60900 1000V

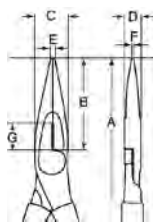

	731415		A mm	B mm	C mm	D mm	E mm	F mm	G mm				
2430 S-200	0033010	3	200	72	17	9	4	2.5	12	3.0	1.8	1.6	170

2719SB/2457B/2456AB

SNIPE NOSE PLIERS



- ISO 5745
- Finish: Nickel-chrome plated, fine-polished, anti-corrosion treated
- Material: Vanadium-extra, handles are orange, transparent cellulose acetate
- Serrated jaws

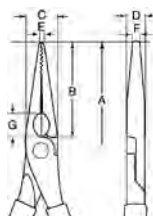

	731415		A mm	B mm	C mm	D mm	E mm	F mm	G mm		
2719 SB	1381189	1	140	38.5	15.0	8	3	1.5	12	1.25	125
2457 B	1063221	1	160	49.0	16.0	8	3	2.0	12	1.5	125
2456 AB	1063122	1	200	71.5	16.5	9	3	2.5	12	2.0	180

2457/2456A

SNIPE NOSE PLIERS



- ISO 5745
- Finish: Nickel-chrome plated, fine-polished, anti-corrosion treated
- Material: Vanadium-extra, PVC coated handles
- Serrated jaws

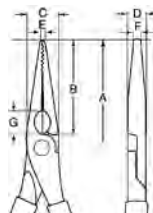

	731415		A mm	B mm	C mm	D mm	E mm	F mm	G mm		
2457	1063214	1	160	50.0	16	8	3	1.5	12.5	1.5	105
2456 A	1063115	1	200	74.5	17	9	3	2.5	14.0	2.0	150



2457VDE/2456AVDE

SNIPE NOSE PLIERS



- Insulated snipe nose pliers
- ISO 5745, IEC 60900
- Finish: Nickel and chrome plated, fine-polished
- Material: Vanadium-extra
- Handles are red cellulose acetate
- Serrated jaws

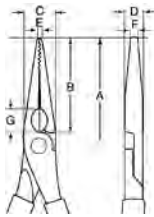

	 731415		A mm	B mm	C mm	D mm	E mm	F mm	G mm	 Fe mm	 g
2457 VDE	1498375	1	160	49	15.5	8	4	2.0	12	2.0	130
2456 AVDE	1598082	1	200	76	17.5	9	3	2.5	14	2.0	180

2470G

SNIPE NOSE PLIERS



- ISO 5745
- Finish: Polished and lacquered for extra rust protection
- Material: High performance alloy steel, 2-component handles

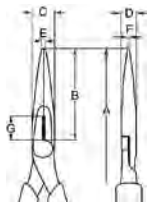

	 731415		A mm	B mm	C mm	D mm	E mm	F mm	G mm	 Cu mm	 Fe mm	 Fe+ mm	 g
2470 G-160	0116188	5	165	48	18	9	3	2	48	3.0	1.5	1.0	160
2470 G-200	0116195	5	210	71	22	11	4	3	71	3.0	1.5	1.0	190

158-N

SNIPE NOSE PLIER, LONG



- Finish: Fine-polished, anti-corrosion treated
- Material: High performance alloy steel, PVC coated handles
- Extra long slim shaped serrated jaws
- Accurately machined jaws provide a sure grip on the work piece
- Tips give good grip and improved accessibility in confined spaces

	 731151		 L mm	 g
158-N	8277239	12	280	265



SNIPE NOSE PLIERS, BENT TIP

2427G

SNIPE NOSE PLIERS, 60°

ergo®

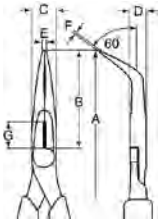

- Snipe nose pliers with bent tips angled at 60° developed according to the scientific ERGO™ process
- ISO 5745
- Finish: Black finish, anti-corrosion treated
- Material: High performance alloy steel
- ERGO™ handles with 2-component combination, thermoplastic surface on tough polypropylene which gives superior grip
- Slim semicircular shaped and serrated jaws
- Sharp edges for cutting softer material such as copper and plastic insulated wire
- Tips give a good grip and improved accessibility in confined spaces
- Equipped with a return spring featuring an on/off function
- IP: Industrial packed

			A mm	B mm	C mm	D mm	E mm	F mm	G mm				
2427 G-160	0100408	5	160	46	17	9	2	2	12	3.0	1.8	1.6	160
2427 G-200	0100415	5	200	70	17	9	2	2	12	3.0	1.8	1.6	170
2427 G-160 IP	0100743	5	160	46	17	9	2	2	12	3.0	1.8	1.6	160
2427 G-200 IP	0100750	5	200	70	17	9	2	2	12	3.0	1.8	1.6	170

2427GC

SNIPE NOSE PLIERS, 60°

ergo®

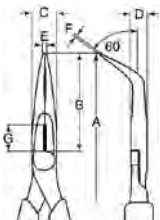

- Snipe nose pliers with bent tips angled at 60° developed according to the scientific ERGO™ process
- ISO 5745
- Finish: Chrome plated, anti-corrosion treated
- Material: High performance alloy steel
- ERGO™ handles with 2-component combination, thermoplastic surface on tough polypropylene which gives superior grip
- Slim semicircular shaped and serrated jaws
- Sharp edges for cutting softer material such as copper and plastic insulated wire
- Tips give a good grip and improved accessibility in confined spaces
- Equipped with a return spring featuring an on/off function
- IP: Industrial packed

			A mm	B mm	C mm	D mm	E mm	F mm	G mm				
2427 GC-160IP	0102051	5	160	46	17	9	2	2	12	3.0	1.8	1.6	160
2427 GC-200IP	0102075	5	200	70	17	9	2	2	12	3.0	1.8	1.6	170



2427D

SNIPE NOSE PLIERS, 60°



- ISO 5745
- Finish: Black finish, anti-corrosion treated
- Material: High performance alloy steel, PVC coated handles
- Slim semicircular shaped and serrated jaws
- Sharp edges for cutting softer material such as copper and plastic insulated wire
- Tips bent at 60° that give a good grip and improved accessibility in confined spaces

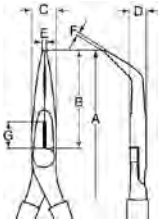

			A mm	B mm	C mm	D mm	E mm	F mm	G mm				
2427 D-160	0032846	5	160	46	17	9	2	2	12	3.0	1.8	1.6	160
2427 D-200	0169030	5	200	10	17	9	2	2	12	3.0	1.8	1.6	170

2427S

SNIPE NOSE PLIERS, 60°



- Insulated snipe nose pliers with a tip angled at 60°
- ISO 5745, IEC 60900
- Finish: Black finish, anti-corrosion treated
- Material: High performance alloy steel, plastic injected handles
- Sharp edges for cutting softer material such as copper and plastic insulated wire
- Equipped with a return spring featuring an on/off function

IEC 60900 1000V

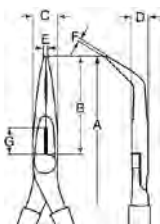

			A mm	B mm	C mm	D mm	E mm	F mm	G mm				
2427 S-200	0033027	3	200	70	17	9	2	2	12	3.0	1.8	1.6	170

2477G-200

SNIPE NOSE PLIERS, 60°



- ISO 5745
- Finish: Lacquered and polished for extra rust protection
- Material: High performance alloy steel, 2-component handles

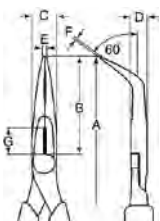

			A mm	B mm	C mm	D mm	E mm	F mm	G mm				
2477 G-200	0116201	5	210	70	22	11	4	3	70	3.0	1.5	1.0	185



SNIPE NOSE PLIERS, BENT TIP

2456BB

SNIPE NOSE PLIERS, 45°



- ISO 5745
- Finish: Nickel-chrome plated, fine-polished, anti-corrosion treated
- Material: Vanadium-extra, handles are orange, transparent cellulose acetate
- Serrated jaws bent at 45°

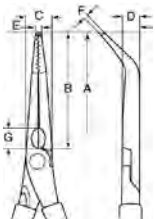

			A mm	B mm	C mm	D mm	E mm	F mm	G mm		
2456 BB	1063160 731415	1	195	69	17.5	9	3	2.5	13	Fe+ mm 2.0	180 g

2456B

SNIPE NOSE PLIERS, 45°



- ISO 5745
- Finish: Nickel-chrome plated, fine-polished, anti-corrosion treated
- Material: Vanadium-extra, PVC coated handles
- Serrated jaws bent at 45°

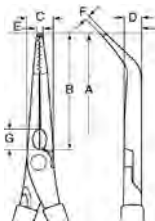

			A mm	B mm	C mm	D mm	E mm	F mm	G mm		
2456 B	1063153 731415	1	200	71	17.5	9	3	2.5	13	Fe+ mm 2.0	150 g

2456BVDE

SNIPE NOSE PLIERS, 45°



- Insulated snipe nose pliers with tips bent at 45°
- ISO 5745, IEC 60900
- Finish: Nickel and chrome plated, fine-polished
- Material: Vanadium-extra
- Handles are red cellulose acetate
- Serrated jaws

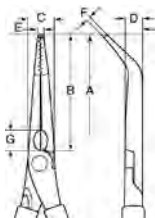

			A mm	B mm	C mm	D mm	E mm	F mm	G mm		
2456 BVDE	1598167 731415	1	210	69	17.5	9	3	2.5	13	Fe+ mm 2.0	210 g



158-NB

SNIPE NOSE PLIERS LONG, BENT TIP, 35°



- Finish: Fine-polished, anti-corrosion treated
- Material: High performance alloy steel, PVC coated handles
- Extra long slim shaped tips bent at 35° with serrated jaws
- Accurately machined jaws provide a sure grip on the work piece
- Tips give good grip and improved accessibility in confined spaces

158-NB	731151 8277246	12	L mm 270	g 265

MACHINISTS PLIERS



2477AB

MACHINISTS PLIERS

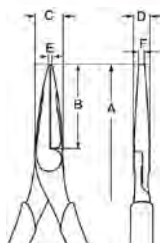

- ISO 5745
- Finish: Nickel and chrome plated, fine-polished
- Material: Vanadium-extra, handles with cellulose acetate coating
- Straight, pointed serrated jaws
- Tips give good grip and improved accessibility in confined spaces
- Particularly suited to precision work

			A mm	B mm	C mm	D mm	E mm	F mm	
2477 AB	731415 1063825	1	200	78	18	9	2.5	2.5	180

2477BB

MACHINISTS PLIERS

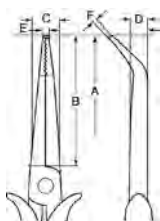

- ISO 5745
- Finish: Nickel and chrome plated, fine-polished
- Material: Vanadium-extra, handles with cellulose acetate coating
- Pointed serrated jaws bent at 45°
- Tips give good grip and improved accessibility in confined spaces
- Particularly suited to precision work

			A mm	B mm	C mm	D mm	E mm	F mm	
2477 BB	731415 1063849	1	195	73.5	16.5	9	3	2.5	190



FLAT NOSE PLIERS

2420G

FLAT NOSE PLIERS

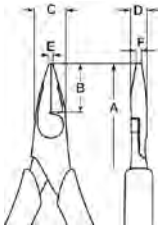

- Short flat nose pliers developed according to the scientific ERGO™ process
- ISO 5745
- Finish: Black finish, anti-corrosion treated
- Material: High performance alloy steel
- ERGO™ handles with 2-component combination, thermoplastic surface on tough polypropylene which gives superior grip
- Tips give a good grip and improved accessibility in confined spaces
- Particularly suited for gripping flat material
- Equipped with a return spring featuring an on/off function

			A mm	B mm	C mm	D mm	E mm	F mm	
2420 G-125	731415	5	125	23	16	7	2	4	120

2421G

FLAT NOSE PLIERS

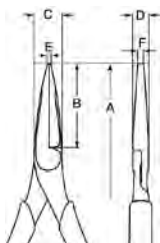

- Long flat nose pliers developed according to the scientific ERGO™ process
- ISO 5745
- Finish: Black finish, anti-corrosion treated
- Material: High performance alloy steel
- ERGO™ handles with 2-component combination, thermoplastic surface on tough polypropylene which gives superior grip
- Tips give a good grip and improved accessibility in confined spaces
- Particularly suited for gripping flat material
- Equipped with a return spring featuring an on/off function
- IP: Industrial packed

			A mm	B mm	C mm	D mm	E mm	F mm	
2421 G-140	731415	5	140	39	14.5	8.0	2	4.0	120
2421 G-160	0102549	5	160	49	16.5	8.5	3	5.0	170
2421 G-180	0102556	5	180	64	17.0	8.5	3	6.5	180
2421 G-140IP	0102006	5	140	39	14.5	8.0	2	4.0	120
2421 G-160 IP	0100576	5	160	49	16.5	8.5	3	5.0	170
2421 G-180 IP	0100583	5	180	64	17.0	8.5	3	6.5	180



2421GC

ergo®

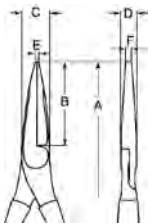

FLAT NOSE PLIERS

- Long flat nose pliers developed according to the scientific ERGO™ process
- ISO 5745
- Finish: Black finish, anti-corrosion treated
- Material: High performance alloy steel
- ERGO™ handles with 2-component combination, thermoplastic surface on tough polypropylene which gives superior grip
- Tips give a good grip and improved accessibility in confined spaces
- Particularly suited for gripping flat material
- Equipped with a return spring featuring an on/off function

			A mm	B mm	C mm	D mm	E mm	F mm	
2421GC-160	0123902	5	160	49	16.5	8.5	3	5.0	170

2421D

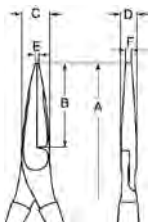

FLAT NOSE PLIERS

- ISO 5745
- Finish: Black finish, anti-corrosion treated
- Material: High performance alloy steel, PVC coated handles
- Tips give a good grip and improved accessibility in confined spaces
- Particularly suited for gripping flat material
- IP: Industrial packed

			A mm	B mm	C mm	D mm	E mm	F mm	
2421 D-160	0032594	5	160	49	16.5	8.5	3	5.0	150
2421 D-140IP	0101979	5	140	39	14.5	8.0	2	4.0	120
2421 D-160IP	0101986	5	160	49	16.5	8.5	3	5.0	150
2421 D-180IP	0101993	5	180	64	17.0	8.5	3	6.5	160

2718B/2458B

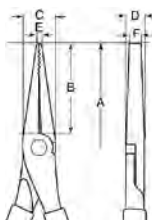

FLAT NOSE PLIERS

- ISO 5745
- Finish: Nickel-chrome plated, fine-polished, anti-corrosion treated
- Material: Vanadium-extra, handles are orange, transparent cellulose acetate
- Serrated jaws

			A mm	B mm	C mm	D mm	E mm	F mm	
2718 B	1067380	1	140	40	13.0	7.5	2.5	4	95
2458 B	1063269	1	180	62	17.5	9.0	3.5	6	170



FLAT NOSE PLIERS

2724B/2694B

FLAT NOSE PLIERS



- ISO 5745
- Finish: Nickel-chrome plated, fine-polished, anti-corrosion treated
- Material: Vanadium-extra, handles are orange, transparent cellulose acetate
- Serrated short jaws

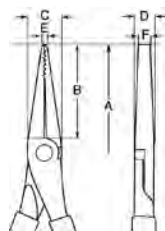

	 731415		A mm	B mm	C mm	D mm	E mm	F mm	 g
2724 B	1067601	1	125	22.0	14	7.5	2	4	120
2694 B	1066826	1	160	41.5	13	9.0	4	7	160

2718

FLAT NOSE PLIERS



- ISO 5745
- Finish: Nickel-chrome plated, fine-polished, anti-corrosion treated
- Material: Vanadium-extra, PVC coated handles
- Serrated jaws

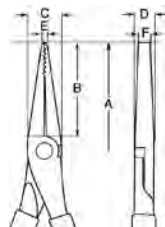

	 731415		A mm	B mm	C mm	D mm	E mm	F mm	 g
2718	1067359	1	140	40	13.5	7.5	3.5	5	80

2694VDE/2458VDE

FLAT NOSE PLIERS



- Insulated flat nose pliers
- ISO 5745, IEC 60900
- Finish: Nickel-chrome plated, fine-polished, anti-corrosion treated
- Material: Vanadium-extra, handles are red, transparent cellulose acetate
- Serrated jaws

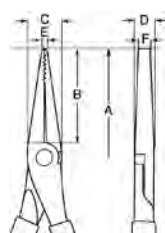

	 731415		A mm	B mm	C mm	D mm	E mm	F mm	 g
2694 VDE	1498023	1	160	49	17	9	3.5	6	165
2458 VDE	1586829	1	180	64	17.5	9	3.5	6	175



2471G

FLAT NOSE PLIERS



- ISO 5745
- Finish: Lacquered and polished for extra rust protection
- Material: High performance alloy steel 2-component handles

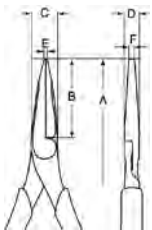

	 731415		A mm	B mm	C mm	D mm	E mm	F mm	 g
2471 G-160	0116225	5	165	50	18	9	3	9	160

7835G

CONNECTOR PLIER

ergo®



- Connector pliers developed according to the scientific ERGO™ process
- Finish: Black finish, anti-corrosion treated
- Material: High performance alloy steel
- ERGO™ handles with 2-component combination, thermoplastic surface on tough polypropylene which gives superior grip
- Sharp edges for cutting softer material such as copper and plastic insulated wire
- Equipped with a return spring featuring an on/off function
- To assemble connectors within the telecommunication field

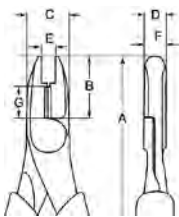

	 731415		A mm	B mm	C mm	D mm	E mm	F mm	G mm	 Cu mm	 Fe mm	 Fe+ mm	 g
7835 G-160	0050253	10	160	20	16.5	8.5	12	8	6<1/4	3.0	1.8	1.6	160

2713A

ADJUSTING PLIERS



- DIN 5235
- Finish: Nickel-chrome plated, fine-polished, anti-corrosion treated
- Material: Vanadium-extra, PVC coated handles
- Smooth extra thin jaws for bending contact and relay springs

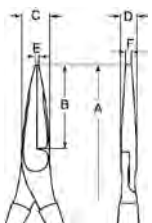

	 731415		A mm	B mm	C mm	D mm	E mm	F mm	 g
2713 A	1067069	1	140	33	14	7.5	1	4	100



FLAT NOSE PLIERS

2979D

NUT PLIER

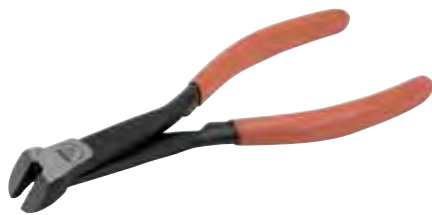

- Finish: Black finish, anti-corrosion treated
- Material: High performance alloy steel, PVC coated handles
- Service pliers for nut and bolt dimensions with 3-13 mm across-flat widths
- Shape: The design of the handles ensures good access in confined spaces
- Serrated and slightly conical gripping surfaces for good grip round the hexagon
- Gripping capacity: 3-13 mm

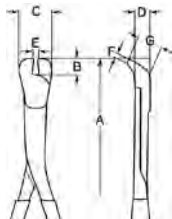

			A mm	B mm	C mm	D mm	E mm	F mm	G mm	
2979 D-180	731415	5	180	12	23	11.5	5	3	17	200



ROUND NOSE PLIERS

2521G

ROUND NOSE PLIERS



- Round nose pliers developed according to the scientific ERGO™ process
- ISO 5745
- Finish: Black finish, anti-corrosion treated
- Material: High performance alloy steel
- ERGO™ handles with 2-component combination, thermoplastic surface on tough polypropylene which gives superior grip
- Particularly suited to wire bending work
- Equipped with a return spring featuring an on/off function
- IP: Industrial packed

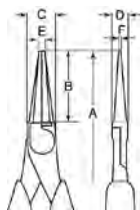

			A mm	B mm	C mm	D mm	E mm	F mm	
2521 G-140	731415	5	140	37	16	7	3.0	1.5	115
2521 G-160 IP	0100620	5	160	42	16	7	3.0	1.5	120

2521GC

ROUND NOSE PLIERS

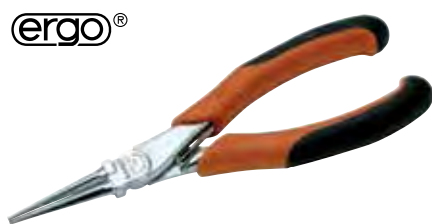

- Round nose pliers developed according to the scientific ERGO™ process
- ISO/DIN 5745
- Finish: Chrome plated, anti-corrosion treated
- Material: Chrome-vanadium. ERGO™ handles with 2-component combination, thermoplastic surface on tough polypropylene which gives superior grip
- Particularly suited to wire bending work
- Equipped with a return spring featuring an on/off function

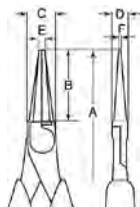

			A mm	B mm	C mm	D mm	E mm	F mm	
2521GC-160	731415	5	160	42	16	7	3.0	1.5	410



2521D

ROUND NOSE PLIERS



- ISO 5745
- Finish: Black finish, anti-corrosion treated
- Material: High performance alloy steel, PVC coated handles
- Particularly suited to wire bending work

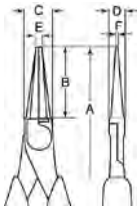

	 731415		A mm	B mm	C mm	D mm	E mm	F mm	 g
2521 D-140	0032907	5	140	37	16	7	3.0	1.5	100
2521D-160	0127139	5	160	42	16	7	3.0	1.5	120

2727B/2698B

ROUND NOSE PLIERS



- Finish: Nickel-chrome plated, anti-corrosion treated, fine-polished
- Material: Vanadium-extra, handles are cellulose acetate
- Particularly suited to wire bending work
- 2698B with short tips

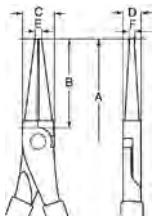

	 731415		A mm	B mm	C mm	D mm	E mm	F mm	 g
2727 B	1067731	1	140	38	15	8	4	2	120
2698 B	1066888	1	160	30	15	8	4	2	150

2727

ROUND NOSE PLIERS



- ISO 5745
- Finish: Nickel-chrome plated, anti-corrosion treated, fine-polished
- Material: Vanadium-extra, PVC coated handles
- Particularly suited to wire bending work
- With short tips

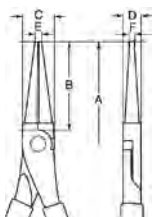

	 731415		A mm	B mm	C mm	D mm	E mm	F mm	 g
2727	1067700	1	140	28	15	8	4.5	2	90



ROUND NOSE PLIERS

2698VDE

ROUND NOSE PLIERS



- Insulated round nose pliers
- ISO 5745, IEC 60900
- Finish: Nickel-chrome plated, anti-corrosion treated, fine-polished
- Material: Vanadium-extra, handles are red cellulose acetate
- Particularly suited to wire bending

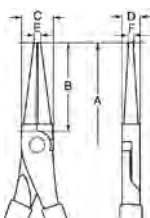

			A mm	B mm	C mm	D mm	E mm	F mm	
2698 VDE	1498290	1	160	30	15	8	4	2	150



WIRE STRIPPERS

2223G

WIRE STRIPPERS

ergo®



- Wire stripping pliers developed according to the scientific ERGO™ process
- For stripping copper cables up to 5 mm
- Finish: Black finish, anti-corrosion treated
- Material: High performance alloy steel, ERGO™ handles with 2-component combination, thermoplastic surface on tough polypropylene which gives superior grip
- Equipped with a return spring featuring an on/off function

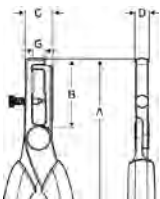

			A mm	B mm	C mm	D mm	G mm		AWG	
2223 G-150	0113651	5	167	46	15	8	8	0.5-5 mm	4-23	170

2223GC

WIRE STRIPPERS

ergo®



- Wire stripping pliers developed according to the scientific ERGO™ process
- For stripping copper cables up to 5 mm
- Finish: Chrome plated, anti-corrosion treated
- Material: High performance alloy steel
- ERGO™ handles with 2-component combination, thermoplastic surface on tough polypropylene which gives superior grip
- Equipped with a return spring featuring an on/off function

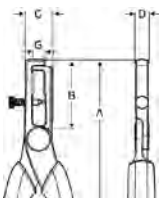

			A mm	B mm	C mm	D mm	G mm		AWG	
2223GC-150	0123919	5	167	146	15	8	8	0.5-5 mm	4-23	170



2223D

WIRE STRIPPERS



- For stripping copper cables up to 5 mm
- Finish: Black finish, anti-corrosion treated
- Material: High performance alloy steel, PVC coated handles

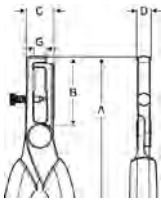

	 731415		A mm	B mm	C mm	D mm	G mm	 mm	AWG	 g
2223 D-150	0033591	5	160	46	15	8	8	0.5-5	4-23	140

2223S

WIRE STRIPPERS



- Insulated wire stripping pliers, for copper cables up to 5 mm
- IEC 60900
- Finish: Black finish, anti-corrosion treated
- Material: High performance alloy steel, plastic injected handles

IEC 60900 1000V

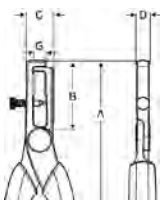

	 731415		A mm	B mm	C mm	D mm	G mm	 mm	AWG	 g
2223 S-150	0032983	3	167	46	15	8	8	0.5-5	4-23	170

3417NFB

WIRE STRIPPERS



- Finish: Nickel-chrome plated, anti-corrosion treated, fine-polished
- Material: Vanadium-extra, handles are orange cellulose acetate

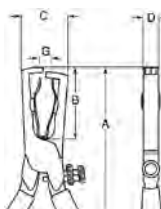

	 731415		A mm	B mm	C mm	D mm	G mm	 mm	AWG	 g
3417 NF B	1072216	1	160	38	15	9	6.0	0.5-5	4-23	160



WIRE STRIPPERS

3417NF

WIRE STRIPPERS



- Finish: Nickel-chrome plated, anti-corrosion treated, fine-polished
- Material: Vanadium-extra, PVC coated handles

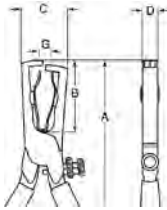

			A mm	B mm	C mm	D mm	G mm		AWG	
3417 NF	1072209	1	160	38	15	9	6.0	0.5-5	4-23	150

3417NFVDE

WIRE STRIPPERS



- Insulated wire stripping pliers
- IEC 60900
- Finish: Nickel-chrome plated, anti-corrosion treated, fine-polished
- Material: Vanadium-extra, handles of red cellulose acetate

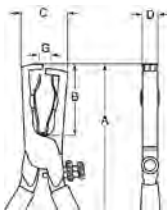

			A mm	B mm	C mm	D mm	G mm		AWG	
3417 NF VDE	1498450	1	160	38	15	9	6.0	0.5-5	4-23	180

3419A

AUTOMATIC WIRE-STRIPPING PLIERS



- For conductors with PVC insulation of all degrees
- Precise stripping without damaging the cables, even in confined spaces where the conductors are difficult to reach
- The blades automatically adjust to the respective conductor cross section - from 0.08 to 1.00 mm² (AWG 28-17)
- Built-in wire cutter for conductors up to 1.00 mm², safe, with hand protection
- Adjustable stripping length from 2.5 to 7.0 mm

3419 A	1812409	1	110



3419B

ELECTRICIAN'S WIRE-STRIPPING PLIERS



- For stripping and cutting of wire and cable 0.1 - 6.0 mm, such as:- PVC thick insulation of all hardness- Stranded wires, for thin flat ribbon cables also multiple wires in one operation- Double insulated cable, in two steps without adjustment
- Adjustment of the insulation strip length from 3 - 16 mm (0.12 - 0.65 inches)
- Light, almost unbreakable casing made of fibreglass reinforced polyamide, resistant to chemicals and corrosion
- The wire cutter should be used only for copper and aluminium wire
- No. 3419EB Replacement blade

	 731415		 g
3419 B	1812416	1	145
3419 EB	1812621	1	6

FINE MECHANICAL CUTTERS AND PLIERS



4130, 4131

SIDE CUTTERS

ergo®



- Compact side cutting pliers developed according to the scientific ERGO™ process
- ISO 5749
- Finish: Black finish, anti-corrosion treated
- Material: High performance alloy steel
- ERGO™ handles with 2-component combination, thermoplastic surface on tough polypropylene which gives superior grip
- CNC machine grinding guarantees edge angle accuracy
- Equipped with a return spring
- For fine mechanical, telecommunication and electronics industry

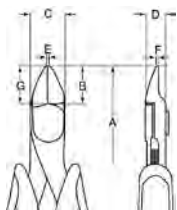

	 731415		A mm	B mm	C mm	D mm	E mm	F mm	G mm	 Cu mm		 g
4130	0100019	3	120	9	11	6.8	0.5	0.9	10	0.3-1.5	Micro	60
4131	0100026	3	120	9	11	6.8	0.5	0.9	10	0.3-1.5	Flush	60



FINE MECHANICAL CUTTERS AND PLIERS

4231

OBLIQUE CUTTERS

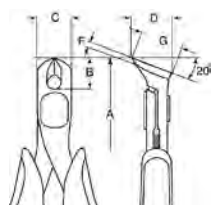

- Compact oblique cutting pliers developed according to the scientific ERGO™ process
- ISO 5748
- Finish: Black finish, anti-corrosion treated
- Material: High performance alloy steel
- ERGO™ handles with 2-component combination, thermoplastic surface on tough polypropylene which gives superior grip
- CNC machine grinding guarantees edge angle accuracy
- 20° cutting angle
- Equipped with a return spring
- For fine mechanical, telecommunication and electronics industry

			A	B	C	D	F	G			
4231	0100033	3	119	9	13	15	0.5	15	0.3-1.25	Flush	55

4239

OBLIQUE CUTTERS

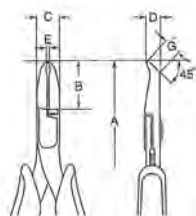

- Compact oblique cutting pliers developed according to the scientific ERGO™ process
- ISO 5748
- Finish: Black finish, anti-corrosion treated
- Material: High performance alloy steel
- ERGO™ handles with 2-component combination, thermoplastic surface on tough polypropylene which gives superior grip
- CNC machine grinding guarantees edge angle accuracy
- 45° cutting angle
- Equipped with a return spring
- For fine mechanical, telecommunication and electronics industry

			A	B	C	D	E	F	G			
4239	0100088	3	129	19	9	7	3.0	1.5	5.5	0.3-1.0	Flush	60

4430

FLAT NOSE PLIERS

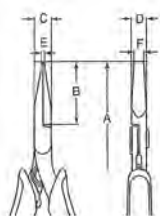

- Compact flat nose pliers developed according to the scientific ERGO™ process
- ISO 5745
- Finish: Black finish, anti-corrosion treated
- Material: High performance alloy steel
- ERGO™ handles with 2-component combination, thermoplastic surface on tough polypropylene which gives superior grip
- CNC machine grinding guarantees accuracy
- Equipped with a return spring
- For fine mechanical, telecommunication and electronics industry
- Smooth jaws

			A	B	C	D	E	F	
4430	0100040	3	135	26	9	7	1.0	4.0	65



4830, 4831

SNIPE NOSE PLIERS

ergo®

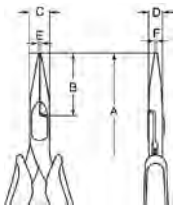

- Compact snipe nose pliers developed according to the scientific ERGO™ process
- ISO 5745
- Finish: Black finish, anti-corrosion treated
- Material: High performance alloy steel
- ERGO™ handles with 2-component combination, thermoplastic surface on tough polypropylene which gives superior grip
- CNC machine grinding guarantees accuracy
- Equipped with a return spring
- For fine mechanical, telecommunication and electronics industry
- 4830: Smooth jaws
- 4831: Serrated jaws

			A mm	B mm	C mm	D mm	E mm	F mm	
4830	0100057 731415	3	135	25	9	7	1.0	1.0	60
4831	0103393	3	135	25	9	7	1.0	1.0	60

4833

SNIPE NOSE PLIERS, BENT TIP 60°

ergo®

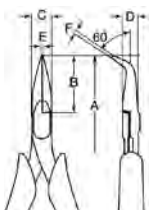

- Compact snipe nose pliers with bent tip developed according to the scientific ERGO™ process
- ISO 5745
- Finish: Black finish, anti-corrosion treated
- Material: High performance alloy steel
- ERGO™ handles with 2-component combination, thermoplastic surface on tough polypropylene which gives superior grip
- CNC machine grinding guarantees accuracy
- Equipped with a return spring
- Tip bent at 60°
- For fine mechanical, telecommunication and electronics industry
- Smooth jaws

			A mm	B mm	C mm	D mm	E mm	F mm	
4833	0100064 731415	3	130	23	9	7	1.0	1.0	60



FINE MECHANICAL CUTTERS AND PLIERS

4530

ROUND NOSE PLIERS

ergo®

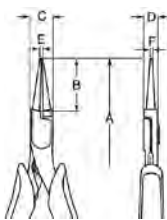

- Compact round nose pliers developed according to the scientific ERGO™ process
- ISO 5745
- Finish: Black finish, anti-corrosion treated
- Material: High performance alloy steel
- ERGO™ handles with 2-component combination, thermoplastic surface on tough polypropylene which gives superior grip
- CNC machine grinding guarantees accuracy
- Equipped with a return spring
- For fine mechanical, telecommunication and electronics industry

			A	B	C	D	E	F	
4530	0100095	3	mm	mm	mm	mm	mm	mm	g
			135	22	9	7	1.6	0.8	60

9733

FINE MECHANICAL CUTTERS AND PLIERS SET

ergo®



- Set of fine mechanical cutters and pliers packed in a wallet

9733	0103256	1	215x215x30	680

4130/4131 120 mm Micro/Flush		4231 119 mm	
4239 129 mm		4430 135 mm	
4830 135 mm		4833 130 mm, 60°	
4530 135 mm			



2646M - 2649

DIAGONAL CUTTERS OVAL HEAD

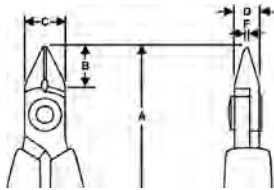

- Material: High performance alloy steel
- Mirror polished
- Numerically controlled machine grinding guarantees edge angle accuracy and contact; increases reliability and consistency
- Precision induction hardened edges 63-65 HRC
- Screw joint that minimizes friction and maximizes alignment of cutting edges
- Handles in synthetic material with return spring
- The cutting capacity that is given is for copper wire
- 2646RK with lead catcher

	 731415		A mm	B mm	C mm	D mm	F mm	 mm		 g
2646 M	1487928	1	108.0	8.0	8.0	5	0.8	0.1-0.8	Ultra	44
2646 R	1304706	1	110.0	10.0	10.0	6	0.8	0.2-1.25	Micro	46
2646 RK	1496678	1	110.0	10.0	10.0	6	0.8	0.2-1.25	Micro	46
2646 RA	1834838	1	110.0	10.0	10.0	6	0.8	0.1-1.0	Ultra	46
2666	0058006	1	112.5	12.5	12.5	6	1.2	0.3-1.6	Micro	50
2649	0058013	1	125.0	16.0	16.0	8	1.6	0.4-2.0	Micro	88

2646 - 2648A

DIAGONAL CUTTERS TAPERED HEAD

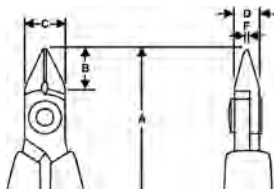

- Material: High performance alloy steel
- Mirror polished
- Numerically controlled machine grinding guarantees edge angle accuracy and contact; increases the tools reliability and consistency
- Precision induction hardened edges 63-65 HRC
- Screw joint that minimizes friction and maximizes alignment of cutting edges
- Handles in synthetic material with return spring
- The cutting capacity that is given is for copper wire
- 2646K, 2646AK, 2666FKK with lead catcher

	 731415		A mm	B mm	C mm	D mm	F mm	 mm		 g
2646	1304638	1	110.0	10.0	10.0	6	0.8	0.2-1.25	Micro	46
2646 K	1495862	1	110.0	10.0	10.0	6	0.8	0.2-1.25	Micro	46
2646 A	1304645	1	110.0	10.0	10.0	6	0.8	0.1-1.0	Ultra	46
2646 AK	1396619	1	110.0	10.0	10.0	6	0.8	0.1-1.0	Ultra	46
2666 FK	1066079	1	112.5	12.5	12.5	6	1.2	0.2-1.25	Ultra	49
2666 FKK	1496593	1	112.5	12.5	12.5	6	1.2	0.2-1.25	Ultra	49
2648	1304713	1	125.0	16.0	16.0	8	1.6	0.4-2.0	Micro	88
2648 A	1304720	1	125.0	16.0	16.0	8	1.6	0.3-1.6	Ultra	88



2787F

OBLIQUE CUTTER 45° LONG HEAD

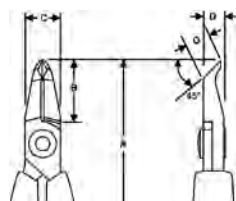

- Material: High performance alloy steel
- Mirror polished
- Numerically controlled machine grinding guarantees edge angle accuracy and contact; increases reliability and consistency
- Precision induction hardened edges 63-65 HRC
- Screw joint that minimizes friction and maximizes alignment of cutting edges
- Handles in synthetic material with return spring
- Ideal for rework and close assembly needs
- The cutting capacity given is for copper wire

			A mm	B mm	C mm	D mm	G mm			
2787 F	1474270	1	117.5	18	10	6	6.7	0.2-1.0	Flush	51

2787G

OBLIQUE CUTTER 45° LONG HEAD RELIEVED

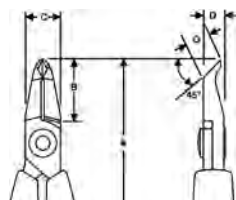

- Material: High performance alloy steel
- Mirror polished
- Numerically controlled machine grinding guarantees edge angle accuracy and contact; increases reliability and consistency
- Precision induction hardened edges 63-65 HRC
- Screw joint that minimizes friction and maximizes alignment of cutting edges
- Handles in synthetic material with return spring
- Ideal for rework and close assembly needs
- The cutting capacity given is for copper wire

			A mm	B mm	C mm	D mm	G mm			
2787 G	0058020	1	117.5	18	10	6	6.7	0.2-0.8	Flush	51

2656/2656A

END CUTTERS

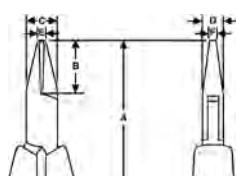

- Material: High performance alloy steel
- Mirror polished
- Numerically controlled machine grinding guarantees edge angle accuracy and contact; increases reliability and consistency
- Precision induction hardened edges 58-60 HRC
- Screw joint that minimizes friction and maximizes alignment of cutting edges
- Handles in synthetic material with return spring
- Miniature end cutter for use in confined spaces
- The cutting capacity given is for copper wire

			A mm	B mm	C mm	D mm	E mm	F mm			
2656	1304737	1	115	15	9	6	3.2	4	0.35 - 0.8	Micro	54
2656 A	1304744	1	115	15	9	6	3.2	4	0.35 - 0.8	Flush	54



2646MF

FLAT NOSE PLIERS

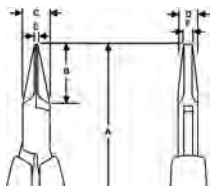

- Material: High performance alloy steel
- Mirror polished
- Numerically controlled machine grinding guarantees edge angle accuracy and contact; increases reliability and consistency
- Screw joint that minimizes friction and maximizes alignment of the jaws
- Handles in synthetic material with return spring
- 20 mm smooth gripping surface with rounded edges

			A mm	B mm	C mm	D mm	E mm	F mm	
2646 MF	1573683	1	120	20	9	6	1.2	3.2	53

2646MT

ROUND NOSE PLIERS

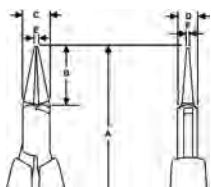

- Material: High performance alloy steel
- Mirror polished
- Numerically controlled machine grinding guarantees edge angle accuracy and contact; increases reliability and consistency
- Screw joint that minimizes friction and maximizes alignment of the jaws
- Handles in synthetic material with return spring
- Round jaws with no sharp edges

			A mm	B mm	C mm	D mm	E mm	F mm	
2646 MT	0058037	1	120	20	9	6	1.8	0.9	54

2646MS

CHAIN NOSE PLIERS

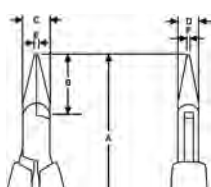

- Material: High performance alloy steel
- Mirror polished
- Numerically controlled machine grinding guarantees edge angle accuracy and contact; increases reliability and consistency
- Screw joint that minimizes friction and maximizes alignment of the jaws
- Handles in synthetic material with return spring
- 20 mm smooth gripping surface with rounded edges

			A mm	B mm	C mm	D mm	E mm	F mm	
2646 MS	1573768	1	120	20	9	6	1.2	0.8	56



2656S

SNIPE NOSE PLIERS

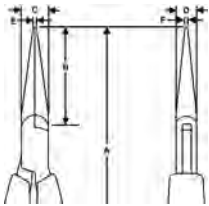

- Material: High performance alloy steel
- Mirror polished
- Numerically controlled machine grinding guarantees edge angle accuracy and contact; increases reliability and consistency
- Screw joint that minimizes friction and maximizes alignment of the jaws
- Handles in synthetic material with return spring
- 32 mm smooth gripping surface with rounded edges

			A mm	B mm	C mm	D mm	E mm	F mm	
2656 S	0058044	1	132	32	9	6	1.2	0.8	60

2656R

SNIPE NOSE PLIERS, BENT TIP

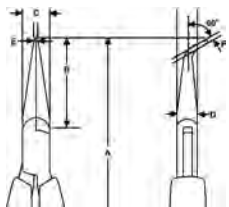

- Material: High performance alloy steel
- Mirror polished
- Numerically controlled machine grinding guarantees edge angle accuracy and contact; increases reliability and consistency
- Screw joint that minimizes friction and maximizes alignment of the jaws
- Handles in synthetic material with return spring
- 29 mm smooth gripping surface angled at 60° with rounded edges

			A mm	B mm	C mm	D mm	E mm	F mm	
2656 R	1473976	1	129	29	9	6	1.2	0.8	59



2800

CIRCLIPS PLIERS INTERNAL



- Pliers without return spring for handling of internal circlips
- DIN 5256
- Black finish, anti-corrosion treated
- Material: High performance alloy steel, PVC coated handles
- Straight jaws, forged tips

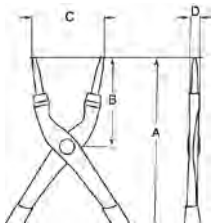

	 731415		A mm	B mm	C mm	D mm	 mm	 mm	 g
2800-140	0121632	3	140	38	18	0.8	8-13	1.2	80
2800-150	0034567	3	150	38	20	10	12-25	1.3	120
2800-180	0034581	3	180	57	23	10	19-60	1.7	185
2800-225	0034604	3	225	69	28	12	40-100	2.2	280
2800-300	0122622	1	310	95	33	14	85-165	3.1	490

2890

CIRCLIPS PLIERS INTERNAL



- Pliers without return spring for handling of internal circlips
- DIN 5256
- Black-finish, anti-corrosion treated
- Material: High performance alloy steel, PVC coated handles
- Shape: With 90° offset jaws, forged tips

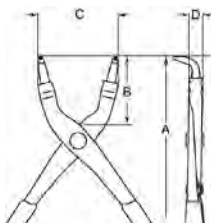

	 731415		A mm	B mm	C mm	D mm	 mm	 mm	 g
2890-125	0122639	3	127	38	17	9	8-15	0.8	80
2890-140	0034550	3	140	38	19	10	12-25	1.3	120
2890-180	0034574	3	180	57	23	12	19-60	1.8	185
2890-210	0034598	3	210	59	27	14	40-100	2.3	280
2890-300	0122646	1	289	95	33	14	85-165	3.1	490

2900

CIRCLIPS PLIERS EXTERNAL



- Pliers with return spring for handling of external circlips
- DIN 5256
- Black finish, anti-corrosion treated
- Material: High performance alloy steel, PVC coated handles
- Straight jaws, forged tips

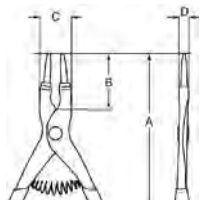

	 731415		A mm	B mm	C mm	D mm	 mm	 mm	 g
2900-140	0121045	3	140	38	18	9	3-10	0.8	80
2900-150	0034499	3	150	38	20	10	10-25	1.3	120
2900-180	0034512	3	180	57	23	11	19-60	1.8	185
2900-215	0034536	3	215	69	31	12	40-100	2.3	280
2900-300	0121076	1	295	95	35	14	85-165	3.1	490



CIRCLIP PLIERS

2990

CIRCLIPS PLIERS EXTERNAL

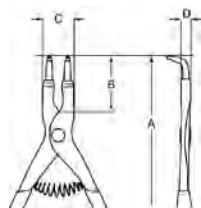

- Pliers with return spring for handling of external circlips
- DIN 5256
- Black finish, anti-corrosion treated
- Material: High performance alloy steel, PVC coated handles
- Shape: 90° offset jaws, forged tips

	 731415		A mm	B mm	C mm	D mm	 mm	 mm	 g
2990-125	0121250	3	127	38	18	9	3-10	0.8	80
2990-140	0034482	3	140	38	20	10	10-25	1.3	120
2990-180	0034505	3	180	57	22	10	19-60	1.8	185
2990-200	0034529	3	200	69	27	14	40-100	2.3	280
2990-300	0121267	1	289	95	35	11	85-165	3.1	490

28-29/S4

CIRCLIPS PLIERS EXTERNAL



- Circlip pliers set in a cardboard box
 - 2800-180: Internal straight tip, Ø 19-60 mm
 - 2890-180: Internal bent tip, Ø 19-60 mm
 - 2900-180: External straight tip, Ø 19-60 mm
 - 2990-180: External bent tip, Ø 19-60 mm

	 731415		 g
28-29/S4	0179688	1	740

2900-180



2800-180



2990-180



2890-180



2928

RESETTABLE PLIERS FOR BOTH INTERNAL AND EXTERNAL CIRCLIPS









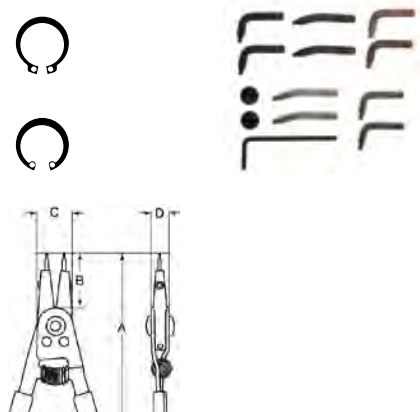

2928-160



2928-250



- Adjustable pliers that complete the range of existing conventional circlip pliers
- Patented pliers are equipped with interchangeable tips (straight, 15° and 90°) which can easily be adapted for use with internal or external circlips as required
- 5 pairs of tips are supplied with the -160 & -200 and 6 pairs with the -250
- For internal circlips from 8 to 100 mm diameter and for external circlips from 3 to 100 mm
- The 2928-160 covers a range of applications normally requiring up to ten pliers
- Stop mechanism (automatic on the 2928-250 model) for easier use and prevention of damage to circlips from excessive force







	 731415		A mm	B mm	C mm	D mm	 mm	 mm	 mm 0°	 mm 15°	 mm 90°	 g
2928-160	0056514	1	160	23.5	21.5	17	7-26	3-26	0.6 0.9 1.2	–	0.9 1.2	120
2928-200	0056521	1	200	32.0	23.5	20	10-51	7-51	0.9 1.2 1.8	–	0.9 1.2	230
2928-250	0056538	1	250	36.0	30.0	22	46-102	32-102	–	2.3 2.7 3.0	2.3 2.7 3.0	505

9938

CIRCLIP PLIERS, SET



- Set of three adjustable pliers for both internal and external circlips from the 2928 series: 160 mm, 200 mm and 250 mm
- Patented pliers that are equipped with interchangeable tips (straight, 15° and 90°) which can easily be adapted for use with internal or external circlips as required
- 5 pairs of tips are supplied with the -160 & -200 and 6 pairs with the -250
- The pliers can be used for internal circlips from 8 to 100 mm diameter and for external circlips from 3 to 100 mm
- This set covers a range of applications previously requiring up to ten conventional pliers
- Stop mechanism (automatic on the 2928-250 model) for easier use and prevention of damage to circlips from excessive force

	 731415		 g
9938	0056491	1	1640
2928-160 8-25, 3-25		2928-200 10-48, 10-48	
2928-250 31-100, 31-100			



CIRCLIP PLIERS

2928-1 - 4

SPARE TIPS



- Spare tips for the 2928 series of resettable circlip pliers

	731415			mm 0°	mm 15°	mm 90°	g
2928-1	0056583	1	2928-160	0.6 0.9 1.2		0.9 1.2	10
2928-2	0056590	1	2928-200	0.9 1.2 1.8		0.9 1.2	15
2928-3	0056606	1	2928-250		2.3 2.7 3.0		45
2928-4	0056613	1	2928-250			2.3 2.7 3.0	60

2461

CIRCLIP PLIERS INTERNAL



- Circlip pliers internal
- ISO 5256
- Chrome plated, fine-polished, black finished tips
- Material: High performance alloy steel
- Straight jaws, for internal circlips

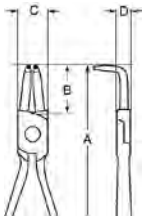

			A mm	B mm	C mm	D mm			
	731415						mm	mm	g
2461 C8	1063481	1	140	31.5	18.5	8.0	8-25	1.0-2.0	85
2461 C19	1063498	1	180	40.0	21.5	9.5	19-60	2.0-2.5	140
2461 C40	1063504	1	255	55.0	22.0	11.0	40-100	2.5-3.5	230

2463

CIRCLIP PLIERS INTERNAL



- Circlip pliers internal
- ISO 5256
- Finish: Chrome plated, fine-polished, black finish tips
- Material: High performance alloy steel
- 90° offset jaws for internal circlips

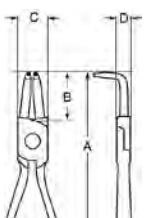

			A mm	B mm	C mm	D mm			
	731415						mm	mm	g
2463 D8	1588878	1	130	20.0	15.0	8.0	8-25	1.0-2.0	85
2463 D19	1063511	1	170	27.5	21.5	9.5	19-60	2.0-2.5	150
2463 D40	1063528	1	210	40.0	22.0	11.0	40-100	2.5-3.5	240



2464

CIRCLIP PLIERS EXTERNAL



- Circlip pliers for external circlips
- ISO 5254
- Finish: Chrome plated, fine-polished; black finish tips
- Material: High performance alloy steel
- Straight jaws
- Stop screw and opening spring

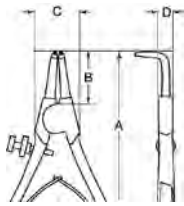

			A mm	B mm	C mm	D mm			
2464 A3	1406516	1	120	32	20.0	8.0	3-10	1.0-1.5	95
2464 A10	1063535	1	120	32	20.0	8.0	10-25	1.5-2.0	95
2464 A19	1063542	1	180	40	21.5	9.5	19-60	2.0-2.5	140
2464 A40	1063559	1	210	60	29.5	10.5	40-100	2.5-3.0	260

2466

CIRCLIP PLIERS EXTERNAL



- Circlip pliers external
- ISO: 5254
- Finish: Chrome plated, fine-polished; black finish tips
- Material: High performance alloy steel
- Shape: With 90° offset jaws
- Stop screw and opening spring

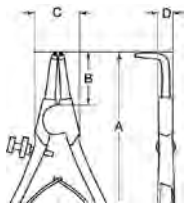

			A mm	B mm	C mm	D mm			
2466 B3	1406868	1	130	20	20	8	3-10	1.0-1.5	100
2466 B10	1063573	1	130	20	20	8	10-25	1.5-2.0	110
2466 B19	1063580	1	165	32	25	9	19-60	2.0-2.5	150
2466 B40	1063597	1	190	44	30	11	40-100	2.5-3.0	250

2460

CIRCLIPS PLIERS SPECIAL



- Pliers for external horseshoe circlips on shafts
- Finish: Chrome plated, fine-polished
- Material: High performance alloy steel
- Opening spring

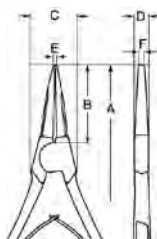

			A mm	B mm	C mm	D mm	E mm	F mm	
2460	1063467	1	175	48	22	9.5	3	7	160



CIRCLIP PLIERS

2465D

CIRCLIPS PLIERS SPECIAL



- Material: High performance alloy steel
- Finish: Nickel and chrome plated surface
- Shape: With jaw for horseshoe circlips on shafts and external snap-rings
- With opening spring

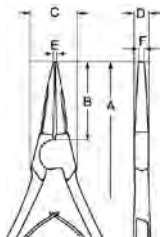

			L mm	A mm	B mm	D mm	
2465D-200	731415	1	200	30	55	2.4	200



CABLE CUTTERS

2233D

CABLE CUTTERS



- Wire cutting and stripping pliers for copper and aluminium
- Finish: Forged surfaces are black finished and mirror polished
- Material: Carbon steel, PVC coated handles
- IP: Industrial packed

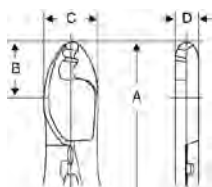

			A mm	B mm	C mm	D mm			
2233 D-160	0114023	5	160	25	25	10	50/35	10	160
2233 D-200	0114030	5	200	28	30	12	70/50	13	280
2233 D-240	0114047	5	240	37	35	14	95/70	16	340
2233D-160IP	0114054	10	160	25	25	10	50/35	10	160
2233D-200IP	0114061	5	200	28	30	12	70/50	13	280
2233D-240IP	0114078	5	240	37	35	14	95/70	16	340

2800N-2801N

CABLE CUTTERS



- Large cutting capacity cable cutter with return spring
- Finish: Nickel and chrome plated, anti-corrosion treated, fine-polished
- Material: Vanadium-extra, PVC coated handles
- Specially designed for cutting multi-wire and other flexible conductors
- Not for use with solid conductors
- Cutting capacity: Plastic insulated copper wire

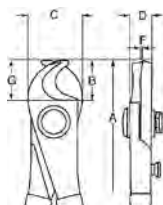

			A mm	B mm	C mm	D mm	F mm	G mm		
2800 N	1318338	1	170	17	28	10	9.0	18	0-10	210
2801 N	1318352	1	230	22	35	13	12.0	27	0-15	425



2520

CABLE CUTTERS

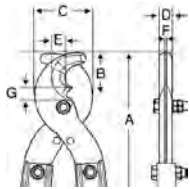

- Cable cutter to cut aluminium or copper cables with or without messenger wire
- Finish: Black finish, handles epoxy painted
- Material: Alloy steel
- For maximum service life only the notched part of blade to be used for ferrous material
- Cutting capacity: 30 mm diameter of Al/Cu with a messenger wire of hard steel of maximum 6 mm diameter
- 2520-SH: Spare blades, screws and nut

			A mm	B mm	C mm	D mm	E mm	F mm	G mm	
2520	0023752	1	550	54	69,5	15	16	8	13	1730
2520-SH	8197506	1	220	54	69.5	15	16	8	13	800

2620-80

CABLE CUTTERS

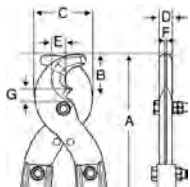

- Cable cutter to cut aluminium or copper cables
- Finish: Black finish, handles epoxy painted
- Material: Alloy steel
- For maximum service life only the notched part of blade to be used for cutting
- Cutting capacity: 42 mm diameter of Al/Cu

			A mm	B mm	C mm	D mm	E mm	F mm	G mm	
2620-80	8200947	1	800	72	80	16	22	8	72	3700

2804-2805

CABLE CUTTERS

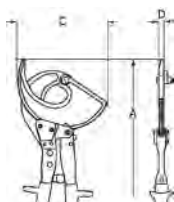

- Gradual cutting of cables with an optimum leverage due to a ratcheting mechanism
- Finish: Chrome plated fine-polished, cutting part black finish with red handles
- Material: Special steel, PVC handles
- Excellent handling during cutting, can be unclamped in any cutting position
- Does not cut cables with steel core or steel-armoured cables
- Multiple cables: 2804 up to 240 mm² Cu, 2805 up to 400 mm² Cu
- Cutting capacity:
 - 1 copper wire
 - 2 plastic coated copper or aluminium cables

			A mm	C mm	D mm			
2804	1692698	1	250	50	15	16	32	645
2805-280	1826123	1	280	77	15	-	52	800



CABLE CUTTERS

2804CC



CABLE CUTTERS

- Effortless cutting of single and multi-wire copper/aluminium cable diameters
- Finish: Black finish, black polypropylene handles
- Material: Carbursed alloy steel
- Pliers will be engaged gradually during cutting due to ratcheting mechanism
- Cutting capacity Cu/Al:
 - CC62 up to diameter 62 mm
 - CC80 up to diameter 80 mm

	 731415		 L mm	 g
2804CC62	0122080	1	440	2200
2804CC80	0122097	2	560	3000

2720

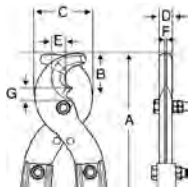

CABLE CUTTERS

- Cutting capacity: 42 mm diameter of aluminium and copper
- Cable cutter to cut steel cables
- Finish: Black finish, handles epoxy painted
- Material: Alloy steel
 - Steel wire 100 kg/mm²: Ø 12 mm
 - Steel wire 150 kg/mm²: Ø 10 mm
 - Solid steel wire 80 kg/mm²: Ø 8 mm
- Spare parts: Blades 2720-SH

	 731415		A mm	B mm	C mm	D mm	E mm	F mm	G mm	 g
2720	0179701	1	600	38	71	17	9	0	8	2800
2720-SH	0179718	1	163	38	71	17	9	0	8	760

2235-160

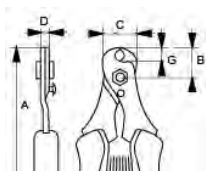

CABLE CUTTERS

- Lightweight tool designed for cutting solid materials and multi-wire cables
- Finish: Black finish
- Material: Alloy steel, elastomer handles for comfort
- Spring and locking mechanism
- Medium hard wire: Ø 5 mm
- Piano wire: Ø 1.5 mm
- Low carbon steel wire: Ø 4 mm

	 731415		A mm	B mm	C mm	D mm	G mm	 g
2235-160	0179695	1	7	21	12	8	165	165



4559

BOLT CUTTERS



- Material: High performance alloy steel
- Wide range of bolt cutters with cutting capacity up to 15 mm concrete reinforcing rod or 9 mm valve spring steel
- Black finish, anti-corrosion treated
- Forged from precision high-grade steel
- High cutting power even at the start of the cut
- Comfortable handles
- Good accessibility in confined spaces

	 731415		 L mm	 Ø mm	 Ø Fe mm	 Ø Piano mm	 g
4559-12	0113132	1	320	6	5	4	900
4559-18	0024513	8	430	8	7	6	1990
4559-24	0024520	1	600	10	9	8	2860
4559-30	0024537	5	750	13	10	9	3670
4559-36	0024544	1	900	15	12	11	5980
4559-42	0024551	1	1060	15	12	11	8510

4559 JC

BOLT CUTTERS



- Complete spare cutting head for the 4559 range of bolt cutters

	 731415		 g
4559-12B JC	0113613	1	285
4559-18B JC	0113880	1	600
4559-24B JC	0113897	1	930
4559-30B JC	0113903	1	1260
4559-36B JC	0113910	1	2180
4559-42B JC	0113620	1	3025

4560-210

BOLT CUTTERS



- Material: High performance alloy steel
- Black finish
- Application: Cable cutter to cut steel cables
- Recommended maximum capacity: Steel wire 130 kg/mm²: Ø 1.5 mm
- Cuts rivets, nails, bits, screws, etc

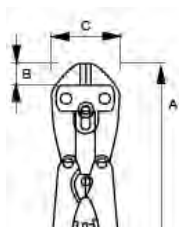

	 731415		A mm	B mm	C mm	 g
4560-210	0178995	1	210	20	75	280



GRIP AND WELDING PLIERS

2951

GRIP

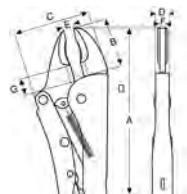

- Finish: Chrome plated for good rust protection
- Shape: Curved jaws for general purpose. Thin, neat jaws for good accessibility
- Application: General puprose. Also good for plumbing and heating work. The cutting edges are good for cutting welding leads etc.
- With cutter

	 731415		A mm	B mm	C mm	D mm	E mm	F mm	G mm	 Fe+ mm	 max mm	 g
2951-140	0124084	1	140	22	47	6,5	4	7.0	4	1.2	30	180
2951-180	0102204	1	180	30	43	10.0	5	10.0	7	2	42	355
2951-250	0102211	1	250	35	54	11.0	6	11.0	11	3	63	540
2951-300	0102228	1	300	46	67	13.5	7	13.5	14	4	75	890

2968

GRIP

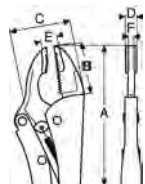

- Finish: Chrome plated for good rust protection
- Benefits: Clamps flat work pieces with maximum contact. Allows more space for work pieces
- Applications: Ideal for holding L, U & T sections in maintenance work
- Features: Broad surface of both jaws. Convex shape of lower jaw

	 731415		A mm	B mm	C mm	D mm	E mm	F mm	 max mm	 g
2968-190	0124091	1	190	50	58	10	13	6	35	370
2968-235	0103850	1	235	53	56	15	6	12	43	590

2952

GRIP

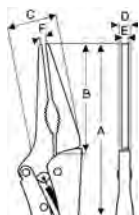

- Finish: Chrome plated for good rust protection
- Features: Long slim jaw design. Curved section
- Benefits: Enables pliers to reach deep into recess areas. Also be used to can hold rounded objects
- Applications: Provides aid when holding, placing or extracting pieces in awkward areas, engines etc.

	 731415		A mm	B mm	C mm	D mm	E mm	F mm	 max mm	 g
2952-165	0103836	1	165	62	27	11	5	4	55	190
2952-235	0103843	1	235	81	41	14	7	5	70	400



2950

PARALLEL GRIP PLIER, SELF ADJUSTING



- Finish: Chrome plated for good rust protection
- Shape: Narrow jaw profile, fits in areas where C-Clamps cannot
- Application: Self adjusting parallel grip with swivel pads to grip firmly on any flat or tapered surface

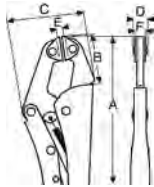

	 731415		A mm	B mm	C mm	D mm	E mm	F mm		
2950-250	0124039	1	235	43	73	16	5	6	35	690

2953

SELF GRIP PLIER, CURVED JAWS WITHOUT CUTTER



- Finish: Chrome plated for good rust protection
- Shape: Slim design with large opening curved jaws to allow firm hold on all round shapes
- Application: Multipurpose grip for workshops, garages and general maintenance

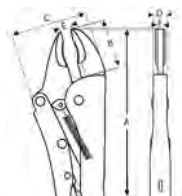

	 731415		A mm	B mm	C mm	D mm	E mm	F mm	
2953-140	0124046	1	140	22	47	6.5	4	7.0	190
2953-200	0124053	1	190	30	43	10.0	5	10.0	390
2953-250	0124060	1	235	35	54	11.0	6	11.0	672
2953-300	0124077	1	300	46	67	13.5	7	13.5	910

2955

PARALLEL PLUS GRIP



- Finish: Chrome plated for good rust protection
- Shape: Parallel jaws with one swivel jaw
- Application: Enables parallel clamping to any size within its capacity
- Fully flat contact makes it perfect for maintenance and repair work. The extra inner jaws also make it possible to grip round work pieces

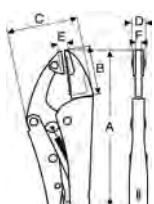

	 731415		A mm	B mm	C mm	D mm	E mm	F mm		
2955-250	0102235	1	250	53	59	12	7	12	45	590



GRIP AND WELDING PLIERS

2957

IDEAL GRIP

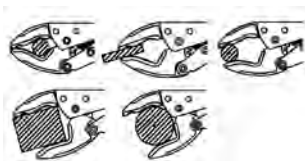
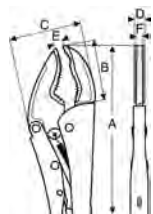

- Finish: Chrome plated for good rust protection
- Shape: Jaws designed for multipurpose
- Application: The configuration of the jaws is ideal for gripping round, flat and square shaped work pieces
- Suitable for plumbers, welders and general mechanics

	 731415		A mm	B mm	C mm	D mm	E mm	F mm		
2957-250	0102259	1	250	46	56	11	10	11	63	550
2957-300	0124251	1	300	73	60	12.5	10	11	63	880

2958

GRIP WITH STRAIGHT JAWS

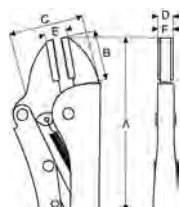

- Finish: Chrome plated for good rust protection
- Shape: Parallel jaws for general purpose. Thin, neat jaws for good accessibility
- Application: General purpose applications

	 731415		A mm	B mm	C mm	D mm	E mm	F mm		
2958-140	0124107	1	135	45	30	9,5	10	6	30	190
2958-200	0124114	1	190	45	58	13	10	6	42	390
2958-250	0102242	1	250	45	73	16	14	12	63	530
2958-300	0124121	1	300	45	79	20	14	12	75	910

2965

WELDING GRIP

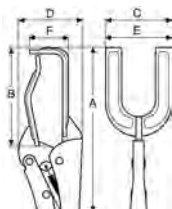

- Finish: Chrome plated for good rust protection
- Shape: U-shaped locking clamp
- Application: Gives powerful grip on two work pieces
- Ideal for assembly and welding work, car repair etc

	 731415		A mm	B mm	C mm	D mm	E mm	F mm		
2965-200	0124152	1	228	67	70	78	70	48	60	960
2965-280	0102266	1	290	87	70	88	70	60	90	950



2966

GRIP FOR TUBE

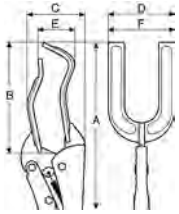

- Finish: Chrome plated body for good rust protection
- Shape: U-shaped locking clamp for pipes and tubes
- Application: Jaws designed to fit on pipes or other round material. Can hold two pipes aligned for obtaining accurate welding
- Ideal for plumbing and general pipe and tube work

			A mm	B mm	C mm	D mm	E mm	F mm		
2966-280	0102273	1	280	97	67	50	64	46	100	930

2963

C-CLAMP

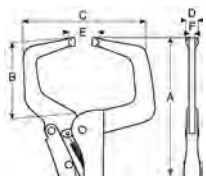

- Finish: Chrome plated body for good rust protection
- Shape: C-shaped locking clamp
- Application: Holds two work pieces together for welding, soldering, gluing, marking off etc

			A mm	B mm	C mm	D mm	E mm	F mm	
2963-280	0102280	1	280	100	148	12	890	6	700
2963-450	0124138	1	460	265	160	12	165	7	1440
2963-630	0124145	1	580	470	245	13	55	8	3850

2964

PARALLEL C-CLAMP

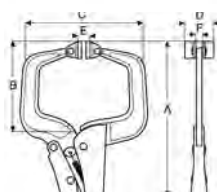

- Finish: Chrome plated surface for good rust protection
- Shape: C-shaped locking clamp with swivel pads which adjust themselves in parallel to the work piece
- Application: Clamps metal, wood and plastic in a secure way

			A mm	B mm	C mm	D mm	E mm	F mm		
2964-160	0124183	1	160	57	85	18	4	4	50	270
2964-280	0102297	1	280	113	137	32	6	6	80	770
2964-450	0124190	1	436	249	156	32	6	6	240	970
2964-600	0124206	1	630	430	152	32	6	6	400	1740



GRIP AND WELDING PLIERS

2967

GRIP FOR SHEET METAL



- Finish: Chrome plated body for good rust protection
- Shape: Clamp for sheet metal
- Application: Gives a secure lock onto sheet metal when forming, bending, crimping and manipulating

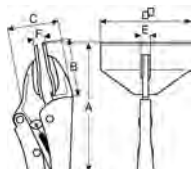

	 731415		A mm	B mm	C mm	D mm	E mm	F mm		
2967-180	0102396	1	180	46	45	80	10	6	45	470

2999

LOCKING PLIER



- Finish: Chrome plated for good rust protection
- Shape: Wraps around and holds irregular objects quickly and easily
- Application: Adjusts quickly around any shaped object, even in awkward areas

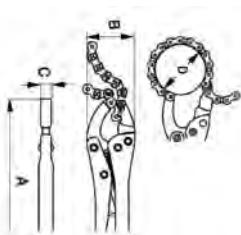

	 731415		A mm	B mm	C mm	D mm	
2999-250	0124169	1	250	75	19	160	900
2999-300	0124176	1	300	80	19	160	1140

2998

CHAIN PIPE CUTTER



- Finish: Chrome plated for good rust protection
- Shape: Perfect for inaccessible areas
- Application: Cuts thin wall pipes (stainless steel, copper, PVC etc.) up to 2.6 mm
- Both cutters have a capacity of cutting pipes between \varnothing 15-75 mm

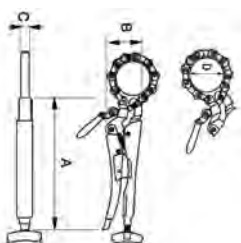

	 731415		A mm	B mm	C mm	D mm	
2998-250	0124213	1	250	70	28	75	800
2998-300	0124220	1	300	70	28	75	1020



2997

UNIVERSAL GRIP PLIER

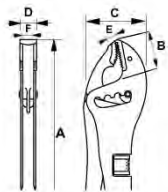

- Short jaws
- Finish: Chrome plated for good rust protection
- Shape: With flat and convex jaws that can be adjusted in 4 different positions for an increased gripping capacity
- Application: Holds most L, T & U profiles

			A	B	C	D	E	F	
2997-250	0124237	1	mm	mm	mm	mm	mm	mm	g
			235	38	58	17	14	15	550

2997

UNIVERSAL GRIP PLIER

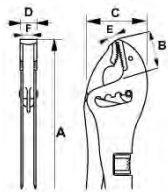

- Extra long jaws with twice as large gripping capacity compared to standard model
- Finish: Chrome plated for good rust protection
- Shape: With flat and convex jaws that can be adjusted in 4 different positions for an increased gripping capacity
- Application: Holds most L, T & U profiles

			A	B	C	D	E	F	
2997-300	0124244	1	mm	mm	mm	mm	mm	mm	g
			255	68	64	17	15	15	700

2949

AUTOMATIC HAND VICES

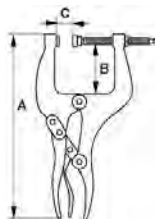

- Finish: Black finish
- Shape: Locking clamp with movable jaw for increased flexibility
- Application: For production or maintenance applications and general purpose work

			A	B	C	
2949-190IP	0123926	1	mm	mm	mm	g
2949-200IP	0123940	1	193	30	32	690
2949-240IP	0123957	1	196	30	70	765
2949-250IP	0123971	1	240	62	70	935
			240	62	150	1180



FENCING PLIERS

2339D

END CUTTER/ FENCING PLIERS



- Finish: Black epoxy powder coated, anti-corrosion treated
- Material: High performance alloy steel, PVC coated handles
- With high leverage design
- For wire twisting and cutting at construction sites (armouring) and to cut medium hard wire used in this application
- IP = Industrial Packed

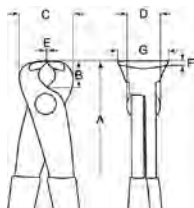

			A mm	B mm	C mm	D mm	E mm	F mm	G mm		
2339 D	0032792	3	220	16	28	21	1.0	3.0	21	2.5	320
2339 DIP	0103508	5	220	16	28	22	1.0	3.0	22	2.5	320

2339

END CUTTER/ FENCING PLIERS



- Finish: Black epoxy powder coated, anti-corrosion treated
- Material: High performance alloy steel
- With high leverage design
- For wire twisting and cutting at construction sites (armouring) and to cut medium hard wire used in this application
- 300 mm size designed for greater leverage
- IP = Industrial Packed

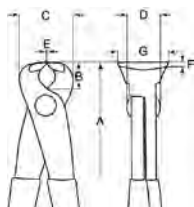

			A mm	B mm	C mm	D mm	E mm	F mm	G mm		
2339-220IP	0101061	5	220	16	28	22	1.0	3.0	22	2.0	205
2339-250IP	0101078	5	250	16	33	23	1.0	4.0	23	2.5	360
2339-280IP	0101948	5	280	18	33	23	1.5	4.0	23	3.0	420
2339-300IP	0123865	5	300	12	36	21	6	2	6	4.5	465

541D

PINCERS



- Finish: Black epoxy powder coated, anti-corrosion treated
- Material: High performance alloy steel, handles plastic coated
- Edges are induction hardened and annealed withstand the high breaking stresses from pulling nails etc

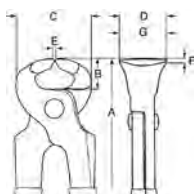

			A mm	B mm	C mm	D mm	E mm	F mm	G mm		
541 D-150	0032754	5	150	16	45	20.5	1.5	7.0	20.5	2.0	230
541D-180	0127160	5	180	21	52	21.5	2.0	8.0	21.5	2.0	265
541 D-200	0032761	5	200	24	53	23.0	1.5	9.0	23.0	2.5	385
541D-225	0127290	5	225	27	58	26.0	2.0	12.0	26.0	2.5	484
541 D-250	0032778	5	250	20	55	29.0	2.0	12.0	29.0	2.5	630



38

NAIL PULLER

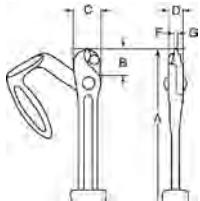

- A robust tool for fast easy removal of nails in crates etc
- Finish: Black finish, anti-corrosion treated
- Material: High performance alloy steel
- Comfortable handle of malleable cast iron, other parts forged, specially hardened jaws

			A mm	B mm	C mm	D mm	F mm	G mm	
38	0021734 731415	1	450	23	36	18	4.5	4.5	2300

1519D

END CUTTER/ FENCING PLIERS

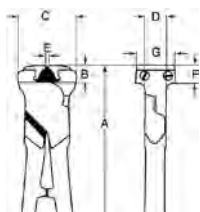

- Finish: Black finish
- Material: High performance alloy steel
- Extra long handles for high leverage and cutting capacity
- 1519-9 : Spare jaws 2 pcs jaws and screws

			A mm	B mm	C mm	D mm	E mm	F mm	G mm		
1519 D	0032747 731415	3	230	10.5	37	13.5	2.5	11.5	25	2.5 Piano mm	450
1519-9	0026074	1									



SLIP JOINT PLIERS

8223 - 8226

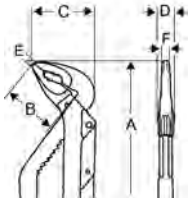

SLIP JOINT PLIERS

- Slip joint pliers developed according to the scientific ERGO™ process
- ISO 8976
- Finish: Black finish, anti-corrosion treated
- Material: High performance alloy steel
- ERGO™ handles in 2-component combination, thermoplastic surface, for comfortable grip, on tough polypropylene core for rigidity
- Hardened jaws
- Teeth designed to ensure grip
- Jaws for flat and pipe shape gripping
- Single thumb button adjustment
- IP: Industrial Packed

	 731415		A mm	B mm	C mm	D mm	E mm	F mm		
8223	0112685	5	210	35	46	7.0	5	7.0	37	270
8224	0000012	5	250	40	51	8.0	6	8.0	45	350
8225	0000029	5	315	52	63	9.5	7	9.5	55	550
8226	0115853	1	400	60	77	13.0	7	13.0	67	670
8223 IP	0113149	5	210	35	46	7.0	5	7.0	37	270
8224 IP	0101757	5	250	40	51	8.0	6	8.0	45	350
8225 IP	0101764	5	315	52	63	9.5	7	9.5	55	550

8224/8225C

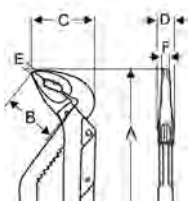

SLIP JOINT PLIERS

- Slip joint pliers developed according to the scientific ERGO™ process
- ISO 8976
- Finish: Chrome plated, anti-corrosion treated
- Material: High performance alloy steel
- ERGO™ handles in 2-component combination, thermoplastic surface, for comfortable grip, on tough polypropylene core for rigidity
- Hardened jaws
- Teeth designed to ensure grip
- Jaws for flat and pipe shape gripping
- Single thumb button adjustment
- Industrial packed

	 731415		A mm	B mm	C mm	D mm	E mm	F mm		
8224CIP	0103607	5	250	40	51	8.0	6	8.0	45	350
8225CIP	0103614	5	315	52	48	9.5	7	9.5	55	550





8231

SLIP JOINT PLIERS

ergo®

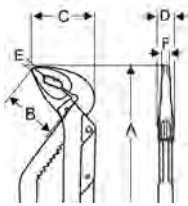

- Slip joint pliers developed according to the scientific ERGO™ process
- ISO 8976
- Finish: Black finish, anti-corrosion treated
- Material: High performance alloy steel
- ERGO™ handles in 2-component combination, thermoplastic surface, for comfortable grip, on tough polypropylene core for rigidity
- Hardened jaws
- Teeth designed to ensure grip
- Jaws for flat and pipe shape gripping
- Extra wide jaw opening combined with a short handle
- Perfect for plumbers and other tradesmen which carry their tools with them
- Single thumb button adjustment
- IP: Industrial Packed

			A mm	B mm	C mm	D mm	E mm	F mm		
8231	731151 8266509	5	225	52	63	9.5	7	9.5	51	340
8231 IP	8270285	5	225	52	63	9.5	7	9.5	51	340

7224

SLIP JOINT PLIERS

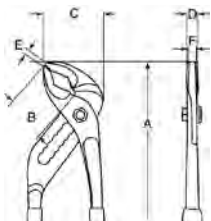

- ISO 8976
- Finish: Black, anti-corrosion treated
- Material: High performance alloy steel, 2-component handles for maximum grip comfort
- Heat treated jaws
- 8 position settings
- Slim jaws provide good accessibility
- Flat and round grip shape with auto-tightening device

			A mm	B mm	C mm	D mm	E mm	F mm		
7224	731151 8274733	5	250	43	49	16	4	3.9	69 / 71	285



SLIP JOINT PLIERS

2619LS

SLIP JOINT PLIERS

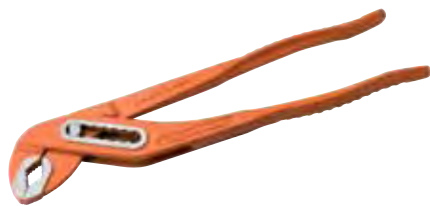

- ISO 8976
- Finish: Orange laquered
- Material: High performance alloy steel
- Shape: With ground jaw faces, teeth induction hardened
- Box joint

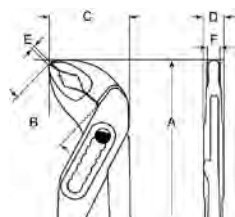

	 731415		A mm	B mm	C mm	D mm	E mm	F mm		 g
2619 LS-175	1809188	5	175	30	27	45	6.5	6	30	154
2619 LS-250	1809195	5	240	32	40	14.5	4.0	7.0	39	330
2619 LS-300	1809201	5	300	40	50	15.0	5.5	9.0	39	480

2971G

SLIP JOINT PLIERS



- ISO 8976
- Black finish, lacquered and polished, anti-corrosion treated
- High performance alloy steel, 2-component handles for comfort
- Box joint

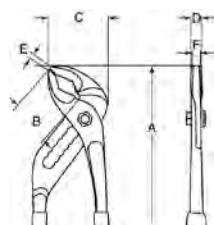

	 731415		A mm	B mm	C mm	D mm	E mm	F mm		 g
2971G-250	0117154	5	250	40	40	13	4	8	35	360

6224DC

SLIP JOINT PLIERS



- ISO 8976
- Finish: Chrome plated, anti-corrosion treated
- High performance alloy steel, PVC coated handles
- Slim head for good accessibility
- Machined groove joint for greater stability

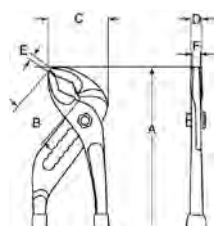

	 731415		A mm	B mm	C mm	D mm	E mm	F mm		 g
6224 DC	0120307	5	250	35	46	10	7	10	32	385



6224GC

SLIP JOINT PLIERS



- ISO 8976
- Material: High performance alloy steel, bi-material handles for better gripping comfort
- Finish: Chrome plated
- Slim head for good accessibility and with machined groove joint for high stability

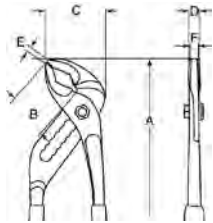

	 731415		A mm	B mm	C mm	D mm	E mm	F mm	max mm	 g
6224 GC	0120314	5	250	35	46	10	7	10	32	385

5223 - 5226 DC

SLIP JOINT PLIERS



- ISO 8976
- Finish: Chrome plated, anti-corrosion treated
- High performance alloy steel, PVC coated handles
- Machined groove joint for greater stability

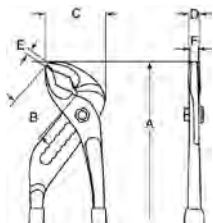

	 731415		A mm	B mm	C mm	D mm	E mm	F mm	max mm	 g
5223 DC	0120321	5	190	25	41	8	3	8	30	195
5224 DC	0120338	5	250	32	51	11	5.5	11	39	345
5225 DC	0120345	2	300	42	61	12	7	12	54	705
5226 DC	0120352	1	400	55	81	13	8	13	105	1130

221 D - 225 D

SLIP JOINT PLIERS



- ISO 8976
- Black finish, anti-rust protected, PVC coated handles for better gripping comfort
- High performance alloy steel
- Jaws grip parallel in all positions up to maximum jaw opening

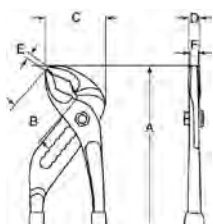

	 731415		A mm	B mm	C mm	D mm	E mm	F mm	max mm	 g
221 D	0037070	5	117	16	18.0	5.0	3.0	5.0	18	60
222 D	0037087	5	150	22	23.5	6.5	4.0	6.5	23	100
223 D	0037094	5	192	25	28.0	7.5	4.5	7.5	32	185
224 D	0037100	5	240	30	35.0	9.5	5.5	9.5	45	345
225 D	0037117	3	305	38	42.0	11.5	4.5	11.5	58	535



SLIP JOINT PLIERS

2650

CONNECTOR PLIER

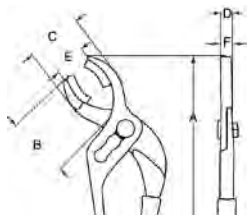

- Chrome plated, fine-polished, anti-corrosion treated
- High performance alloy steel, PVC coated handles
- For specific use in the aviation industry
- With interchangeable nylon inserts and slip joint
- 3 positions
- Slim jaws permit work in very confined spaces
- Designed for adjusting connectors on engines, for plumbing and work with light metals and threaded pipe joints where surfaces must not be damaged
- 2650B: Spare pair of nylon inserts

			A mm	B mm	C mm	D mm	E mm		
2650	1065829	1	235	65	38	88	-	65	275
2650B	1065843	1							3



PLIER SETS

9873

PLUMBER'S SET

ergo®



- Adjustable wrench 9072P and slip joint plier 8224
- Packed in environmentally friendly corrugated cardboard
- Attractive packaging design for both wall and shelf display

9873	0058082	1	280x190x25	900
9072P 250 mm		8224 250 mm		



9853

ALL ROUND SET

ergo®



- Adjustable wrench, slip joint pliers and side cutting pliers
- Packed in environmentally friendly corrugated cardboard
- Attractive packaging design for both wall and shelf display

	 731415			 g
9853	0103287	1	292x252x25	730
9071 200 mm / 8"		8224 250 mm		
2101G 160 mm				

9897

ALL ROUND SET

ergo®



- Slip joint pliers, combination pliers, side cutting pliers and snipe nose pliers
- Packed in environmentally friendly corrugated cardboard
- Attractive packaging design for both wall and shelf display

	 731415		 g
9897	0058068	1	1030
8224 250 mm		2628G 180 mm	
2101G 160 mm		2430G 160 mm	

9860S

ALL ROUND SET



- IEC 60900
- Set of 3 insulated pliers: Side cutting, combination and snipe nose
- Packed in environmentally friendly corrugated cardboard
- Attractive packaging design for both wall and shelf display

IEC 60900 1000V

	 731415		 g
9860S	0140732	1	840
2101S-160		2628S-180	
2430S-200			



WIRE TWISTING PLIERS

2855

WIRE TWISTING PLIERS

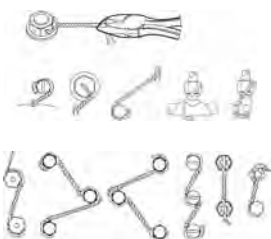
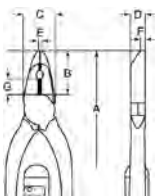

- Black finish, anti-corrosion treated
- High performance alloy steel
- Extremely fast and time-saving with, consistent twisting
- Can be used for any wire length and any twist length
- When the pliers grip the wire, any number of twists can be made by pulling out and pushing in the spinner knob
- The reversible models eliminate the need of a second tool just a simple twist of the patented reversing sleeve gives right or left hand capability
- The smaller model might be easier to use in narrow areas
- This is a tool to secure, with wire, all critical places which are exposed to vibration
- Jaws angled at 30° and serrated, with cutter
- Capacity: Wires up to Ø 1.04 mm for the 2855 and Ø 1.6 mm for the 2855 D, also suitable

			A mm	B mm	C mm	D mm	E mm	F mm	G mm	
2855	1825805	1	224	22	14.5	9.5	3	2.5	8	240
2855D	1822569	1	282	29	20	10.5	5	4	10	525



RIVETING TOOLS

2681

HAND RIVETER



- Swivel head rivet tool
- Head swivels 360° to rivet at any angle
- Suitable for metal, leather, canvas and vinyl, using 2.4, 3.2, 4.0 or 4.8 mm rivets
- Three interchangeable nosepieces can be stored in handle, when not in use

2681	731151	12	285	740



1467-250

HAND RIVETER

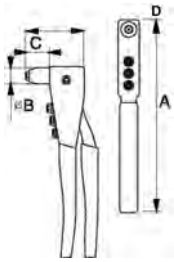

- General duty riveter with four different exchangeable heads for rivet capacities of 2.4 mm; 3.2 mm; 4.0 mm and 4.8 mm
- Includes a wrench for changing heads

	 731415		A mm	B mm	C mm	D mm	 g
1467-250	0124268	1	250	22	34	75	500

1467-520

LONG ARM RIVETER

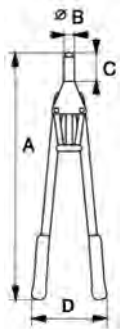
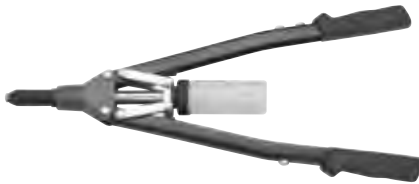

- Expert quality riveter with long handles for greater leverage
- To be used with aluminium, steel and stainless steel rivets with rivet capacities of 3.2 mm; 4.0 mm; 4.8 mm; 6.0 mm and 6.8 mm
- The transparent tube collects snapped off rivet tails

	 731415		A mm	B mm	C mm	D mm	 g
1467-520	0124275	1	520	22	58	160	1800

1467-320-850

EXTENDIBLE RIVETER



- Extendible riveter with noses of \varnothing 3.80 - 4.00 mm, \varnothing 4.80 - 5 mm and \varnothing 6.00 - 6.50 mm
- Variable length goes from 350 mm to 840 mm
- Riveting capacity (for all noses): Aluminium, copper and stainless steel
- Spares available

	 731415		 mm	 g
1467-320-850	0178636	1	320-850	1750

PIPE WRENCHES & PIPE TOOLS

In 1888 the Swedish inventor and creative craftsman Johan Petter Johansson got his first patent for 'The Iron Hand', better known as the pipe wrench. JP Johansson's idea was to replace fixed spanners with a single tool that, just like the human hand, would be capable of gripping different size nuts and bolts. This was the beginning of the product innovation and design that prevails within the company today.



Chapter Index

PIPE WRENCHES	606-609
TUBE BENDERS AND SPARE PARTS	610
TUBE CUTTERS AND SPARE PARTS	612-613
PLASTIC CUTTERS	613
TUBE REAMERS AND DEBURRER TOOLS	614-615
SPECIAL PIPE WRENCHES	615-616
FLARING TOOLS AND SETS	617
WAD PUNCHES	618-620

PIPE WRENCH

The original 'Iron Hand' has laid the foundation for the high quality, ergonomic pipe wrench that Bahco produces today. It is a universal tool designed for a wide range of applications with maximum power and minimum effort.

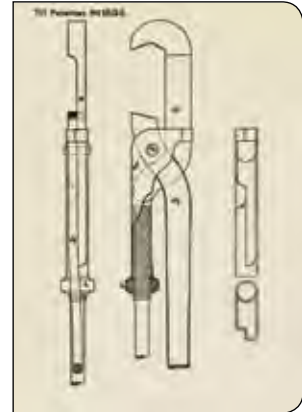

ERGONOMIC GRIP

Bi-component grip of TPE for perfect handheld grip



Outer shape made out of durable sheet metal covered with TPE for a soft, warm, anti-slip, ergonomic grip.

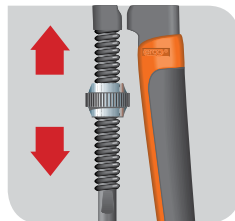

The wrench can easily be locked into the desired position with the adjusting screw. The jaw's grip increases as pressure is put on the handle.



Safety stop prevents threading-off.

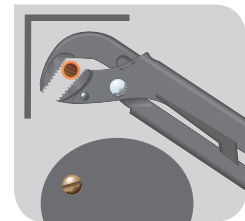

Slim design of the head allows excellent accessibility in confined spaces compared to many other types of pipe wrenches.

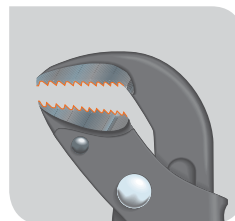

Specially-hardened jaws, with teeth that have been angled to obtain the strongest possible grip on the material.

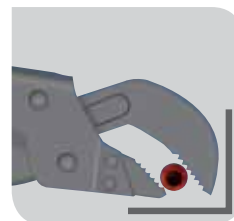

Corner pipe wrench 45°, designed specifically for work in confined spaces.



The combination pipe wrench can grip both round objects and nuts in confined spaces.

600 RANGE TUBE BENDER



Simplified mounting in jaw's bench vice with a specially designed mounting area



Less bending-force needed because of the increased length of handles and low-friction shoe

Scale is embossed and coloured for easier reading

Replaceable shoe made of soft polymer material for non-scratch bends

Light-weight

Less bending force needed because of increased length of handles and low friction shoe

Comfortable non-slip grip. Ergonomically designed with TPE grips, great diameter and bent shape

Flexible cord at the end of the grip simplifies transportation and storage





PIPE WRENCHES

1410/1420

UNIVERSAL WRENCHES

ergo®

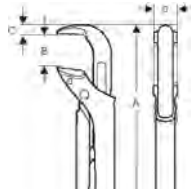

- Pipe wrench developed according to the scientific ERGO™ process
- True ergonomic design for optimal comfort and increased productivity
- Gripping capacity up to 38 mm (1 1/2") and a jaw opening up to 66 mm (2 2/3")
- Optimized design with narrower jaws gives better accessibility
- Patented progressive teeth for better grip
- Anti-rust treated high-alloy steel with induction hardened teeth
- Comfortable 2-component handle
- DIN 5234

	 731415		A mm	B mm	C mm	D mm	 max	 g
1410	0106332	1	320	45	11.7	18.8	1	610
1420	0103744	1	430	65	15.0	20.0	1 1/2	1105

1175

UNIVERSAL WRENCHES

ergo®

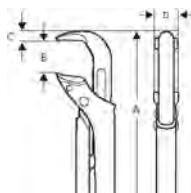

- Pipe wrench developed according to the scientific ERGO™ process
- True ergonomic design for optimal comfort and increased productivity
- Gripping capacity up to 38 mm (1 1/2") and a jaw opening up to 66 mm (2 2/3")
- Optimized design with narrower jaws gives better accessibility
- Patented progressive teeth for better grip
- Chrome plated anti-rust treated high-alloy steel with induction hardened teeth
- Comfortable 2-component handle
- DIN 5234

	 731415		A mm	B mm	C mm	D mm	 max	 g
1175-1	0106943	1	320	45	11.7	18.8	1	610
1175-11/2	0103768	1	430	65	15.0	20.0	1 1/2	1105



140-147

UNIVERSAL WRENCHES

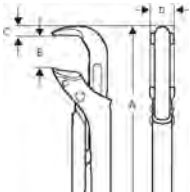

- Gripping capacity up to 127 mm (5") and a jaw opening up to 160 mm (6 1/3")
- Optimized design with narrower jaws gives better accessibility
- Patented progressive teeth for better grip
- Anti-rust treated high-alloy steel with induction hardened teeth
- DIN 5234

			A mm	B mm	C mm	D mm		
	731415							
140	0008797	1	210	33	9.3	15.7	3/4	375
141	0008827	1	320	45	11.7	18.8	1	575
142	0008841	1	426	65	14.9	20.8	1 1/2	1150
143	0008872	1	557	90	19.8	26.7	2 1/2	2865
144	0008902	1	722	110	24.9	33.7	3 1/2	5390
147	0008933	1	1060	160	38.0	35.0	5	7210

442 B-444 B

CORNER WRENCHES

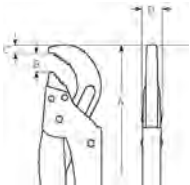

- Gripping capacity up to 36.5 mm (2 1/2") and a jaw opening up to 78 mm (3 1/10")
- Optimized design with narrower jaws, with angle of 45°, gives better accessibility especially in corners
- Patented progressive teeth for better grip
- Anti-rust treated high-alloy steel with induction hardened teeth
- DIN 5234

			A mm	B mm	C mm	D mm		
	731415							
442 B	0008957	1	320	40	20	9.5	1	800
443 B	0008971	1	430	65	22	10.5	2	1400
444 B	0009008	1	535	78	24	12.0	2 1/2	2000

341-343

COMBINATION PIPE MODEL



- Gripping capacity up to 51 mm (2") and a jaw opening up to 67 mm (2 2/3")
- Can grip both round and hexagonal (nuts) objects in confined spaces
- Patented progressive teeth for better grip
- Anti-rust treated high-alloy steel with induction hardened teeth
- DIN 5234

			A mm	B mm	C mm	D mm		
	731415							
341	0113729	1	230	25	15	8.5	1/2	350
342	0113736	1	330	40	18	13.5	1	750
343	0113743	1	420	55	24	14.5	1 1/2	1350



PIPE WRENCHES

DOW177

COMBINATION PIPE MODEL



- Gripping capacity up to 51 mm (2") and a jaw opening up to 67 mm (2 2/3")
- Can grip both round and hexagonal (nuts) objects in confined spaces
- Drop forged steel with induction hardened teeth
- Green powder coating
- DIN 5234

	 731415		A mm	B mm	C mm	D mm		 g
DOW 177-1/2-1	2816383	1	330	40	18	13.0	1	750
DOW 177-11/2	2816468	1	420	55	24	14.5	1 1/2	1350
DOW 177-2	2816543	1	530	67	28	15.5	2	2300

DOW175

PIPE WRENCHES UNIVERSAL MODEL



- Gripping capacity up to 76 mm (3") and a jaw opening up to 103 mm (4 1/10")
- Drop forged steel with induction hardened teeth
- Green powder coating
- DIN 5234

	 731415		A mm	B mm	C mm	D mm		 g
DOW 175-1	2202728	1	310	40	18	15.5	1	750
DOW 175-11/2	2202995	1	420	55	20	17.0	1 1/2	1350
DOW 175-2	2203022	1	560	67	25	19.0	2	2300
DOW 175-3	2203299	1	620	103	30	28.0	3	2950

DOW176

CORNER PIPE MODEL



- Gripping capacity up to 51 mm (2") and a jaw opening up to 67 mm (2 2/3")
- Angled jaws of 45°
- Drop forged steel with induction hardened teeth
- Green powder coating
- DIN 5234

	 731415		A mm	B mm	C mm	D mm		 g
DOW 176-1	2206047	1	320	40	22.0	13.0	1	750
DOW 176-11/2	2206122	1	420	55	24.0	14.5	1 1/2	1350
DOW 176-2	2206399	1	530	67	31.0	15.5	2	2300



380

ALUMINIUM PIPE WRENCH

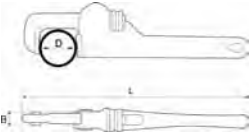

- Self clamping one-hand use multipurpose pipe wrench
- Lightweight
- Body in high strength aluminium alloy, anti-corrosion treated
- Jaws in forged special steel
- US Norm GGG-W-651, Type I Class B
- UNE 16554

	 731151		L mm	L inch	D mm	D inch	B mm	 g
380-10	0133178	1	253	10	49	1.1/2	17	430
380-14	0133185	1	354	14	60	2	21	950
380-18	0133192	1	455	18	76	2.1/2	26	1650
380-24	0133208	1	607	24	89	3	28	2500
380-36	0133215	1	910	36	140	5	32	5200
380-48	0133222	1	1210	58	166	6	36	8400

361

STILLSON PIPE WRENCH

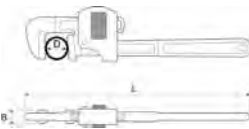

- Self clamping one-hand traditional Stillson wrench
- Spring loaded for ratchet-like use
- Body in traditional forged steel, anti-corrosion treated
- Induction hardened jaws
- US Norm GGG-W-651, Type I Class B
- UNE 16554

	 731151		L mm	L inch	D mm	D inch	B mm	 g
361-8	8295196	1	200	8	25	1	11	290
361-10	8295202	1	250	10	35	1 3/8	15	620
361-12	8295219	1	300	12	44	1 3/4	17	800
361-14	8295226	1	350	14	50	2	19	1120
361-18	8295233	1	450	18	60	2 3/8	23	1890
361-24	8295240	1	600	24	76	3	26	3200
361-36	8295257	1	900	36	102	4	30	6100



TUBE BENDERS AND SPARE PARTS

600

TUBE BENDERS

ergo®

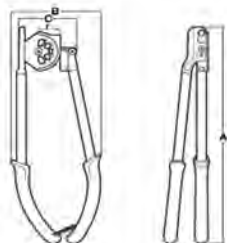

- Tube bender developed according to the scientific ERGO™ process
- True ergonomic design for optimal comfort and increased productivity
- Tube capacity from 10 mm (2/5") to 15 mm (19/32")
- High precision bending of steel, stainless steel, soft and hard copper tubes
- Hard tubes must be annealed before bending to avoid cracks in the tubes
- Allows bending up to 180°
- Less bending force needed, up to 20% less compared to traditional tube bender
- Non scratched bends thanks to low friction shoe
- Detailed and easy readable scale improves accurate bends
- Allows vice clamping
- Comfortable curve shaped handles for non slip grip

	 731151		A mm	B mm	C mm	r mm	Ø mm	 g
600-10	8293642	1	460	185	125	42	10	1758
600-12	8293659	1	460	185	125	42	12	1758
600-15	8293666	1	640	230	150	55	15	2368

600-x-95

TUBE BENDER SPARE PARTS



- Spare shoe for 600-series tube bender

	 731151		Ø mm	 g
600-10-95	8295158	1	10	15
600-12-95	8295165	1	12	15
600-15-95	8295172	1	15	15

1084

TUBE BENDER

- Multipurpose tube bender, bends up to a 90° angle
- For 1/4", 5/16" and 3/8" (6, 8 and 10 mm) aluminium, copper and stainless steel tubing
- Detailed and easy readable scale improves accurate bends

	 731151		A mm	B mm	 L mm	 g
1084	8277291	5	95	125	250	360







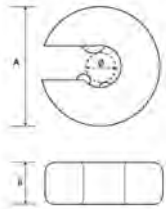

306

TUBE CUTTERS AND SPARE PARTS



- For tubes between 10 - 22 mm
- For copper and other soft material tubes
- Automatic tube cutter, no manual adjustment needed when cutting off the tube
- Spare wheel available

	 731415		A mm	B mm	Ø mm	 g
306-10	0120246	1	48	26	10	124
306-12	0120253	1	52	26	12	146
306-15	8297107	1	56	27	15	175
306-22	8297114	1	68	27	22	215

306-15-95

TUBE CUTTERS AND SPARE PARTS



- Spare cutting wheel
- Fits all sizes for tube cutters in 306-series



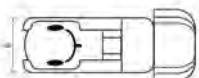
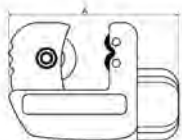

	 731151		 g
306-15-95	8297329	1	10

301-22

TUBE CUTTERS AND SPARE PARTS



- Tube cutter for 3 to 22 mm pipes
- For copper, bronze, aluminium, and steel tubes
- Compact round design gives good accessibility
- Spare wheel available, code 301-22-95

	 731151		A mm	B mm	Ø mm	 g
301-22	8293673	10	62	20	3-22	160
301-22-95	8295189	10	-	-	-	5



TUBE CUTTERS AND SPARE PARTS

302-35

TUBE CUTTERS AND SPARE PARTS



- Tube cutter for 8 to 35 mm pipes
- For copper, bronze, aluminium, and steel tubes
- Comfortable TPE covered knob with an extra spare wheel attached
- Heavy knob allow fast adjustment
- Spare wheel available, code 302-35-95

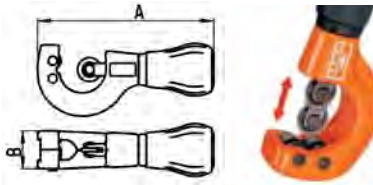

	 731151		A mm	B mm	Ø mm	 g
302-35	8293680	4	140	30	8-35	302
302-35-95	0188338	10	-	-	-	5

302-76

TUBE CUTTERS AND SPARE PARTS



- Tube cutter for 35 to 76 mm pipes
- For copper, bronze, aluminium, and steel tubes
- Comfortable TPE covered knob with an extra spare wheel attached
- Heavy knob allows fast adjustment
- Spare wheel available, code 302-76-95

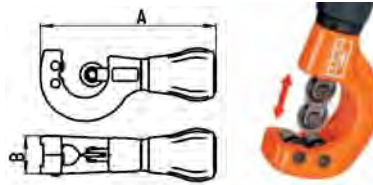

	 731151		A mm	B mm	Ø mm	 g
302-76	8293697	4	210	32	35-76	570
302-76-95	0188345	10	-	-	-	5



311-32

PLASTIC CUTTERS



- For plastic tubes up to 32 mm
- Cuts PVC, PEX, PP, PB and PE
- PA body reinforced with fibreglass with a comfortable bi-material handle for a soft and firm grip

	 731415		A mm	B mm	Ø mm	 g
311-32	0120215	6	83	26	32	210

311-42

PLASTIC CUTTERS



- For plastic tubes up to 42 mm
- Cuts PVC, PEX, PP, PB, PVDF and PE
- Less force needed with gearing function
- Body in cast aluminium
- Exchangeable cutting blade, code 311-42-95

	 731151		A mm	B mm	Ø mm	 g
311-42	8295523	1	94	22	0-42	347
311-42-95	8295554	1	-	-	-	69

312-42

PLASTIC CUTTERS



- For plastic tubes up to 42 mm
- Cuts PVC, PEX, PP, PB, PVDF and PE
- Less force needed with gearing function
- Body in cast aluminium
- Exchangeable cutting blade, code 312-42-95

	 731415		A mm	B mm	Ø mm	 g
312-42	0120222	1	84	26	0-(26)-42	769
312-42-95	0120239	1	-	-	-	57



TUBE REAMERS AND DEBURRER TOOLS

316-1

TUBE REAMERS



- Pen reamer for deburring tubes
- Aluminium body with HSS-blade



	 731151		A mm	B mm	 g
316-1	8296216	1	143	10	21

316-2

TUBE REAMERS



- Pen reamer for deburring tubes
- Plastic body with an extra HSS-blade inside
- Spare blade available, code 316-2-95



	 731151		A mm	B mm	 g
316-2	8296223	12	150	22	31

316-2-95

TUBE REAMERS



- Spare blade for 316-2

	 731151		 g
316-2-95	8296278	1	3

318

TUBE REAMERS



- For deburring copper, steel and stainless steel tubes
- Aluminium body with blades in high performance alloy steel
- Deburrs both internally and externally



	 731151		A mm	B mm	C mm	 g
318-38	8296247	1	60	8-38	49	208
318-54	8296254	1	85	12-54	68	483



317

TUBE REAMERS



- For deburring soft material tubes such as copper and aluminium
- Plastic body with carbon steel blades
- Deburrs both internally and externally

	 731151		A mm	B mm	C mm	 g
317-40	8296230	1	50	3-40	50	35

SPECIAL PIPE WRENCHES



363

PLUMBING WRENCHES



- For 10 - 32 mm wide nuts
- Basin wrench with spring loaded jaws and flexible head for optimal accessibility in narrow spaces
- Telescopic wrench with four positionings

	 731151		A mm	B mm	C mm	D mm	E mm	F mm	Ø mm	 g
363-32	8295578	1	230	150	19	9,7	19	60	12	790

375

PLUMBING WRENCHES



- Optimized for oil filter and tubes up to 220 mm in diameter
- Nylon strap to avoid damage to the work piece
- Designed to operate in narrow spaces
- High performance alloy steel

	 731151		A mm	B mm	C mm	D mm	 g
375-8	8296209	1	305	220	26	44	339



SPECIAL PIPE WRENCHES

370

PLUMBING WRENCHES

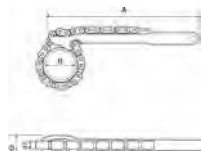

- Capacity up to 110 mm in diameter
- The special jaw design allows the wrench to operate in two directions
- Designed to operate in narrow spaces
- High performance alloy steel with induction hardened jaw

			A	B	B	C	D	
	731151		mm	mm	inch	mm	mm	g
370-4	8296193	1	300	110	4	19	22	793

372

CHAIN PIPE WRENCH

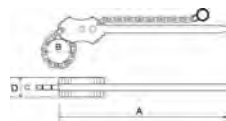

- Maximal tube capacity up from 38 mm (1 1/2") to 305 mm (12")
- Suitable for most jobs on metallic tubes
- Double sided tooth system for ratchet-like use
- Self locking function in both directions
- Strong chain made of tempered special steel
- Jaws and body in forged hardened steel
- US Norm GGG-W-651, Type I Class BUNE 16555

			A	B	B	C	D	
	731415		mm	mm	inch	mm	mm	g
372-1.1/2	0133239	1	350	49	1.1/2	8	38	1400
372-2.1/2	0133246	1	685	76	2.1/2	9	49	3500
372-4	0133253	1	940	115	4	13	60	6700
372-6	0133260	1	1122	166	6	20	75	12600
372-8	0133277	1	1278	220	8	20	79	17000
372-12	0133284	1	1625	324	12	20	82	24200



4480M

TUBE FLARING TOOL



- For flaring brass, aluminium and soft copper tubes
- Clamping action of jaws prevents tube sliding with a self-centring pressure piece
- Hardened flaring core for 45° flares

4480M	731415 1080433	1	45	4 4.75 6 8 10 12 14 mm	950 g

4480/

TUBE FLARING TOOL, SET



- For double or single flares on soft steel, brass or aluminium tubes
- Set includes tube cutter, flaring bar, rod handle, yoke and adaptors
- Double flaring adapter: 3/16", 1/4", 5/16", 3/8" and 1/2"

4480/2-ZD	731151 8276911	1	330x140x45 mm	1700 g



WAD PUNCHES

400.003.020

WAD PUNCHES



- Interchangeable wad punch set of 11 pieces, allowing cutting of foam, leather, cardboard, rubber, fibre, plastic and lead
- Packed in a resistant plastic case
- Noses are easily placed and blocked with a slight spin
- Nose diameters:
3 mm, 4 mm, 6 mm, 8 mm, 10 mm, 12 mm, 14 mm, 16 mm, 18 mm and 20 mm

	 841281		\varnothing mm	 g
400.003.020	4403205	1	3-20	594

400.003.030

WAD PUNCHES



- Interchangeable wad punch set of 16 pieces allowing cutting of foam, leather, cardboard, rubber, fibre, plastic and lead
- Packed in a resistant plastic case
- Noses are easily placed and blocked with a slight spin
- Nose diameters:
3 mm, 4 mm, 6 mm, 8 mm, 10 mm, 12 mm, 14 mm, 16 mm, 18 mm, 20 mm, 22 mm, 24 mm, 26 mm, 28 mm and 30 mm

	 841281		\varnothing mm	 g
400.003.030	4403304	1	3-30	1115







B400

WAD PUNCHES



- Wad punches made of high-resistant steel
- Suitable to cut foam, leather, cardboard, rubber, fibre, plastic and lead

	 841281		\varnothing mm	 g
B400.002	4119441	1	2	10
B400.003	4119458	1	3	10
B400.004	4119465	1	4	10
B400.005	4119472	1	5	10
B400.006	4119489	1	6	10
B400.007	4119496	1	7	10
B400.008	4119502	1	8	10
B400.009	4119519	1	9	10
B400.010	4119526	1	10	10
B400.011	4119533	1	11	10
B400.012	4119540	1	12	10
B400.013	4119557	1	13	10
B400.014	4119564	1	14	10
B400.015	4119571	1	15	10
B400.016	4119588	1	16	10
B400.017	4119595	1	17	10
B400.018	4119601	1	18	10
B400.019	4119618	1	19	10
B400.020	4119625	1	20	10
B400.021	4119632	1	21	10
B400.022	4119649	1	22	10
B400.023	4119656	1	23	10
B400.024	4119663	1	24	10
B400.025	4119670	1	25	10
B400.026	4119687	1	26	10
B400.027	4119694	1	27	10
B400.028	4119700	1	28	10
B400.029	4119717	1	29	10
B400.030	4119724	1	30	10
B400.031	4119731	1	31	10
B400.032	4119748	1	32	10
B400.033	4119755	1	33	10
B400.034	4119762	1	34	10
B400.035	4119779	1	35	10
B400.036	4119786	1	36	10
B400.037	4119793	1	37	10
B400.038	4119809	1	38	10
B400.039	4119816	1	39	10
B400.040	4119823	1	40	10
B400.041	4119830	1	41	10
B400.042	4119847	1	42	10
B400.043	4119854	1	43	10
B400.044	4119861	1	44	10
B400.045	4119878	1	45	10
B400.046	4119885	1	46	10
B400.047	4119892	1	47	10
B400.048	4119908	1	18	10
B400.049	4119915	1	49	10
B400.050	4119922	1	50	10







WAD PUNCHES

2635

REVOLVING PUNCH



- For punching round holes in leather, rubber, plastic, canvas, gaskets and other similar materials
- Six punch sizes 2.0/2.5/3.0/3.5/4.0/4.5 mm included in the tool
- Easily selected and viewed hole diameter
- Unique design reduces cutting power needed by 70%

	 731151		 L mm	 g
2635	8276348	1	260	410



AIR TOOLS

Silent yet Powerful
Powerful yet Lightweight
Lightweight yet Durable

Bahco offers a wide range of air tools designed and developed to meet the very highest standards. Each item in the range incorporates Bahco's spirit of innovation and unrelenting quality. They are equally suitable for the toughest and the most accurate precision jobs, working on the smallest car as readily as the largest truck.

In other words a comprehensive range of professional air tools for everyday use.



Chapter Index

IMPACT WRENCHES	630-634
RATCHETS	635-636
GRINDERS	637-640
CUT OFF TOOLS	641
RECIPROCATING SAWS	641
DRILLS	642
RIVETERS	643
HAMMERS	643
HAMMER CHISELS	644-645
PNEUMATIC MARKERS	646
CARTRIDGE APPLICATOR	646
SURFACE CLEANER	646
SANDERS	647-649
WINDSCREEN REMOVER	649
BLADES & SCRAPERS	649-650
PAINT GUN	651
PNEUMATIC ACCESSORIES	652-654
AIR GUNS	655
BLOW GUNS	655

ICON INDEX



Drive OUT
inches



Maximum
Service
Pressure
MPa

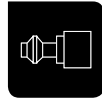

Air Inlet
inches



Min. Hose
Diameter
mm

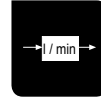

Air
Consumption
l/min



Torque
Range
Nm



Maximum
Torque in
Reverse Mode
Nm



Speed
Revolutions
Per Minute



Sound
Pressure
dBA



Vibration
Level
m/s²



Engine
Output
watt



Diameter
mm



Disc / Belt
Diameter
mm

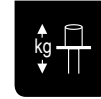

Traction
Power
kg

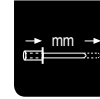

Stroke
mm

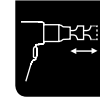

Air hammer
distance



Air Hammer
force



Blows
Per Minute



Hex



Rivet



Extension



Velcro®



Rotating
Exhaust

BP814 MERELY 1,2 KG
STRIKING A MAXIMUM
TORQUE OF 410 NM
IN REVERSE



SPECIAL FEATURES

FAST AND EASY



ONE HAND DIRECTION AND POWER CONTROL KNOB

- Easy to change direction with one hand
- Easy to change power output with one hand

	BPM916	Impact wrench 3/8"		BPM914	Mini impact wrench 1/2"		BPM915	Impact wrench 1/2"
--	--------	--------------------	--	--------	-------------------------	--	--------	--------------------

DURABLE AND LIGHTWEIGHT

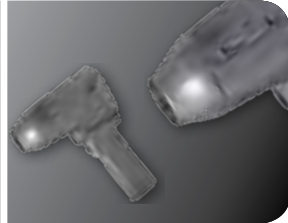

ONE PIECE MAGNESIUM HOUSING

- Lower weight
- Increased durability

	BPM916	Impact wrench 3/8"		BPM914	Mini impact wrench 1/2"		BPM915	Impact wrench 1/2"
--	--------	--------------------	--	--------	-------------------------	--	--------	--------------------

SILENT AND LIGHTWEIGHT



COMPOSITE HOUSING AND HEXAGONAL RUBBER SLEEVE

- Lower weight
- Lower sound pressure
- Lower vibration levels
- Great insulation against cold air
- User friendly grip

	BP816	Impact wrench 3/8"		BP824	Reciprocating saw		BP825	Reversible drill 13 mm
	BP815	Impact wrench 1/2"		BP601	Random orbital sander 5 mm		BP820	Ratchet 3/8"
	BP817	Impact wrench 3/4"		BP610	Random orbital sander 2.5 mm		BP821	Ratchet 1/2"
	BP823	5" Disc grinder		BP826	Reversible screwdriver 1.800 RPM		BP822	Mini grinder
	BP110	Cut-off tool		BP827	Reversible screwdriver 800 RPM		BP115	Angle grinder
	BP814	Impact wrench 1/2"		BP117	Low Revolution Grinder		BP822E	Extended die grinder

POWERFUL DURABILITY



TWIN HAMMER MECHANISM

- Reliable system for continuous torque increase with two hammers
- Resilient to air pressure fluctuations
- Consisting of very few parts
- Easy lubrication from the outside without dismantling the housing

	BP814	Impact wrench 1/2"		BPM916	Impact wrench 3/8"		BPM914	Mini impact wrench 1/2"
	BP816	Impact wrench 3/8"		BP817	Impact wrench 3/4"		BP900L	Long anvil impact wrench 1"
	BP815	Impact wrench 1/2"		BP900	Impact wrench 1"		BPM915	Impact wrench 1/2"

EXTRA POWERFUL & SILENT or EXTRA SILENT & POWERFUL



EXCHANGEABLE MUFFLER SYSTEM

- Adapt the performance of the tool to meet your demand
- Attach either one or two of the included optional mufflers for a remarkable decrease in sound level with just a nominal power loss

	BP921	Ratchet 1/2"		BPM914	Mini impact wrench 1/2"		BPM915	Impact wrench 1/2"
	BP816	Impact wrench 3/8"		BPM916	Impact wrench 3/8"		BPM914	Mini impact wrench 1/2"

SMOOTH OPERATION

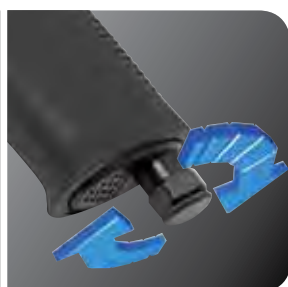

SWIVEL CONNECTION

- Allows the air hose to follow the tool naturally
- Higher operational comfort

	BP816	Impact wrench 3/8"		BP820	Ratchet 3/8"		BP115	Angle grinder
	BP815	Impact wrench 1/2"		BP822	Mini grinder		BP824	Reciprocating saw
	BP814	Impact wrench 1/2"		BP110	Cut-off tool		BP822E	Extended die grinder
	BP821	Ratchet 1/2"		BP117	Low Revolution Grinder		BP822E	Extended die grinder

IMPACT WRENCH

The eight vanes twin hammer mechanism delivers maximum power at minimum air consumption



Flat rubber covered top ensures a stable grip. Supplied with a black vinyl protection boot

Well balanced one piece magnesium housing ensures extreme durability



Oil bath lubrication system with high grade synthetic racing oil to ensure a maintenance free tool with a long lifetime



Change direction and power output in 1 SECOND with one hand



System with optional mufflers allows you to adapt the tool to your needs. With no muffler the power is maximized, with two mufflers the sound is minimized



MINI IMPACT WRENCH 1/2"

Muffler	MAX Nm	% Nm	dB(A)	%
0	440 Nm		96,6 dBA	
1	414 Nm	-6%	90,3 dBA	-275 %



IMPACT WRENCH 1/2"

Muffler	MAX Nm	% Nm	dB(A)	%
0	1098 Nm		102,5 dBA	
1	1015 Nm	-7,6%	92,5 dBA	-316 %
2	935 Nm	-14,8%	86,6 dBA	-623 %



IMPACT WRENCH 3/8"

Muffler	MAX Nm	% Nm	dB(A)	%
0	440 Nm		99,1 dBA	
1	414 Nm	-6%	90,3 dBA	-275 %

RATCHET

The 'stop lock' pins prevent ratchet pawl lock up and assures longer durability

Balanced lightweight house for superior control and comfortable usage

Soft-grip handle with increased comfort, reduced vibration, and increased insulation against cold



The muffler bypass system gives you the choice to adapt the tool to your needs

Muffler	MAX Nm	% Nm	dB	%
	95 Nm		94,9 dBA	
	67 Nm	-30%	87,9 dBA	-224%

308 MM LONG &
95 NM STRONG



DRILLS



TOP MOUNTED
FORWARD / REVERSE
SWITCH:
BP925 & BP926



AIR HAMMER

The chuck makes changing the chisel quick and easy



The 76 mm long stroke of the heavy hard steel piston ensures high striking power

Supplied in a robust plastic case, with five chisels for numerous applications

Built from heavy duty materials, solid, high-grade steel barrel, Kevlar reinforced flutter disc and inbuilt air filter

Built-in, four-position air regulator and direct multi-port frontal exhaust for comfort



The vibration is only 1.5m/s² as a result of the dual elastomer cushions that absorb almost all vibration



BP909K

Accessory chisels - Suitable for BP909

	Type	Shank	Included in BP909K
BP909TF	Turning, flat	Round 10,2 mm	Yes
BP909TWF	Turning, wide flat	Round 10,2 mm	Yes
BP909TTP	Turning, tapered punch	Round 10,2 mm	Yes
BP909TE	Turning, edge claw	Round 10,2 mm	Yes
BP909TH	Turning, hammer	Round 10,2 mm	
BP909TSP	Turning, straight punch	Round 10,2 mm	Yes
BP909NF	Non - turning, flat	Round 10,2 mm	
BP909NE	Non - turning edge claw	Round 10,2 mm	





IMPACT WRENCHES

BPM916

IMPACT WRENCH 3/8"



- Impact wrench 3/8"
- Magnesium housing
- Twin hammer mechanism
- Rubber grip
- One-hand operation power regulator
- Fast forward/reverse valve
- Eight vanes rotor
- Air exhaust in handle
- Rubber boot included
- Muffler kit included to choose the preferred power and sound combination

BPM916	0184187	1	3/8"	6.2	1/4"	10	68	300	440	10,700	1,400	99.1	4.5	155	1.3

BP816

IMPACT WRENCH 3/8"



- Impact wrench 3/8"
- Composite housing
- Twin hammer mechanism
- Power regulator
- Swivel connection
- Air exhaust in handle

BP816	0134427	1	3/8"	6.3	1/4"	10	85	220-360	410	10,000	1,400	88	6.53	163	1.20

BP816K1

IMPACT WRENCH 3/8"



- Impact wrench kit 3/8"
- Delivered in a robust plastic case
- Foam inlay fits into Bahco T-module system T12
- Contains:
 - 1 pc BP816
 - Impact sockets: 10, 11, 12, 13, 14, 15, 17, 19, 21, 22, and 24 mm
 - 1/4" threaded male connector

BP816K1	0182008	1	3/8"	6.3	1/4"	10	85	220-360	410	10,000	1,400	88	6.53	163	1.20



BPM915



IMPACT WRENCH 1/2"

- Impact wrench 1/2"
- Magnesium housing
- Twin hammer mechanism
- Rubber grip
- One-hand operation power regulator
- Fast forward/reverse valve
- Eight vanes rotor
- Air exhaust in handle
- Rubber boot included
- Muffler kit included to choose the preferred power and sound combination

BPM915	0184194	1	1/2"	6.2	1/4"	10	178	813	1,098	9,800	1,270	102.5	5.1	194	2.2

BP815



IMPACT WRENCH 1/2"

- Impact wrench 1/2"
- Composite housing
- Twin hammer mechanism
- Power regulator
- Swivel connection
- Air exhaust in handle

BP815	0134311	1	1/2"	6.3	1/4"	10	130	320-620	825	7,000	1,150	84	5.00	192	1.95

BPM914



IMPACT WRENCH 1/2"

- Impact wrench 1/2"
- Magnesium housing
- Twin hammer mechanism
- Rubber grip
- One-hand operation power regulator
- Fast forward/reverse valve
- Eight vanes rotor
- Air exhaust in handle
- Rubber boot included
- Muffler kit included to choose the preferred power and sound combination

BPM914	0184170	1	1/2"	6.2	1/4"	10	68	300	440	10,700	1,400	96.6	4.54	155	1.3



IMPACT WRENCHES

BP814

IMPACT WRENCH 1/2"



- Impact wrench 1/2"
- Composite housing
- Twin hammer mechanism
- Power regulator
- Swivel connection
- Air exhaust in handle

				BAR											
BP814	0184262	10	1/2"	6.3	1/4"	10	85	220-360	410	10,000	1,400	88	6.53	163	1.20

BP815K1

IMPACT WRENCH 1/2"



- Impact wrench kit 1/2"
- Supplied in a robust plastic case
- Foam inlay fits into Bahco T-module system T12
- Contains:
 - 1 pc BP815 1/2" Impact wrench
 - Impact sockets: 10, 11, 12, 13, 14, 15, 17, 19, 21, 22, and 24 mm
 - 1/4" threaded male connector

				BAR											
BP815K1	0181957	1	1/2"	6.3	1/4"	10	130	320-620	825	7,000	1,150	84	5	192	1.95

BP815K2

IMPACT WRENCH 1/2"



- Impact wrench kit 1/2"
- Contains:
 - 1 pc BP815 1/2" Impact wrench
 - 1 pc BP500 Magnetic holder
 - 1 pc BWSS12P Wheel socket set 17, 19, 21 mm in a case

				BAR											
BP815K2	0181964	1	1/2"	6.3	1/4"	10	130	320-620	825	7,000	1,150	84	5	192	1.95



BP817

IMPACT WRENCH 3/4"



- Impact wrench 3/4"
- Composite housing
- Twin hammer mechanism
- Power regulator
- Swivel connection
- Air exhaust in handle

				BAR											
BP817	0134106	1	3/4"	6.3	3/8"	10	190	340-950	1,800	4,500	970	88	4.30	245	3.95

BP900

IMPACT WRENCH 1"



- Impact wrench 1"
- Twin hammer mechanism
- Power regulator
- Support handle included
- 6" anvil (BP900L)

				BAR											
BP900	0134328	2	1"	6.3	1/2"	13	1,840	1,200-2,700	2,800	3,900	700	99	11.6	510	12

BP900L

IMPACT WRENCH 1"



- Impact wrench 1" long anvil
- Twin hammer mechanism
- Power regulator
- Support handle included
- 6" anvil (BP900L)

				BAR											
BP900L	0134335	1	1"	6.3	1/2"	13	1,840	1,200-2,700	2,800	3,900	700	99	11.6	610	12.5



IMPACT WRENCHES

BP405

IMPACT WRENCH 1"



- Impact wrench 1"
- Power regulator
- Support handle included
- Air exhaust in handle
- Pin clutch mechanism

BP405	0134373	1	1"	6.3	1/2"	13	235	813-1,898	3,796	4,000	500	92.00	5.10	302	11.80

BPM91B

IMPACT WRENCH ACCESSORIES



- Impact wrench boot
- BPM91BS to be used with BPM914 and BPM916
- BPM91BL to be used with BPM915

BPM91BL	0186891	1	185x70x65	100
BPM91BS	0186907	1	140x65x50	70

BPM91MK

IMPACT WRENCH ACCESSORIES



- Impact wrench muffler kits
- BPM91MK1 to be used with BPM914 and BPM916
- BPM91MK2 to be used with BPM915













BPM91MK1	0186938	1	25x25x30	5
BPM91MK2	0186945	1	50x25x30	10

BP919



RATCHET 1/4"

- Ratchet 1/4"
- Rubber grip
- Rubber boot included
- Balanced lightweight housing
- All ball bearing construction and high strength alloy steel gear system
- Hard coated motor plates













	 731415			BAR	 inch	 mm	 U/min	 Nm	 min-1	 dBA	 m/sec ²	 mm	 kg
BP919	0184200	1	1/4"	6.2	1/4"	10	40	0-47	235	84	2.5	198	0.59

BP700



RATCHET 1/4"

- 1/4" Mini ratchet
- Composite housing
- Power regulator













	 731415			BAR	 inch	 mm	 U/min	 Nm	 min-1	 dBA	 m/sec ²	 mm	 kg
BP700	0134458	1	1/4"	6.3	1/4"	10	65	0-30	300	94	3.60	133	0.50

BP920



RATCHET 3/8"

- Ratchet 3/8"
- Rubber grip
- Rubber boot included
- Balanced lightweight housing
- All ball bearing construction and high strength alloy steel gear system
- Hard coated motor plates

	 731415			BAR	 inch	 mm	 U/min	 Nm	 min-1	 dBA	 m/sec ²	 mm	 kg
BP920	0184217	1	3/8"	6.2	1/4"	10	40	0-47	235	84	2.5	198	0.59



RATCHETS

BP820

RATCHET 3/8"



- Ratchet 3/8"
- Rubber grip
- Power regulator
- Swivel connection
- Swivelling air exhaust

				BAR									
BP820	0134465	1	3/8"	6.3	1/4"	10	120	0-67	270	80	2.6	256	1.20

BP921

RATCHET 1/2"



- Ratchet 1/2"
- Rubber grip
- Rubber boot included
- Magnesium housing
- Power regulator with muffler bypass system to choose the preferred power and sound combination

				BAR									
BP921	0184224	1	1/2"	6.2	1/4"	10	127	7-95	200	94.9	5.2	308	1.35

BP821

RATCHET 1/2"



- Ratchet 1/2"
- Rubber grip
- Power regulator
- Swivel connection
- Swivelling air exhaust

				BAR									
BP821	0134472	1	1/2"	6.3	1/4"	10	120	0-67	150	80	2.60	256	1.20

BP91B

AIR RATCHET ACCESSORIES



- Air ratchet boots
- BP91BS to be used with BP919 and BP920
- BP91BL to be used with BP921













	731415		mm	
BP91BL	0192779	1	60x40x35	12
BP91BS	0192786	1	45x30x30	6

BP822

DIE GRINDER 6 MM



- Die grinder 6 mm
- Includes 3 mm collet
- Rubber grip
- Swivel connector
- Swivelling air exhaust
- 3 and 6 mm collets included













	 731415		BAR									
BP822	0134984	1	6.3	1/4"	10	170	25,000	85	4.53	250	165	0.50

BP822E

EXTENDED DIE GRINDER 6 MM



- Die grinder 6 mm
- Includes 3 mm collet
- Rubber grip
- Swivel connector
- Swivelling air exhaust
- 3 and 6 mm collets included













	 731415		BAR									
BP822E	0184279	10	6.3	1/4"	10	113	25000	76	4.53	200	258	0.80

BP115

ANGLE DIE GRINDER 6 MM



- Angle die grinder 6 mm
- Rubber grip
- Swivel connector
- Swivelling air exhaust
- 3 and 6 mm collets included

	 731415		BAR									
BP115	0134991	1	6.3	1/4"	10	113	20,000	79	< 2.5	164	170	0.60



GRINDERS

BP823

DISC GRINDER 5"



- Disc grinder 5"
- Composite housing
- Rubber grip
- Safety trigger
- Support handle included
- Tool free disc change

			BAR								
BP823	0135004	1	6.3	1/4"	10	340	10,000	83	< 2.50	250	1.80 2.22

BP420M

ABRASIVE WHEEL



- 6 mm abrasive wheel
- 2 units in a blister

BP420M	0134618	1	67	25	55

BP421M

ABRASIVE WHEEL



- 6mm abrasive wheel
- 2 units in a blister

BP421M	0134625	1	53	14	35

BP422M

ABRASIVE WHEEL



- 6 mm abrasive wheels
- 2 in a blister







BP422M	0134632	1	46	26	60

BP423M

ABRASIVE WHEEL



- 6 mm abrasive wheels
- 2 in a blister

	 731415		 mm	 mm	 g
BP423M	0134649	1	53	25	60

BP424M

ABRASIVE WHEEL



- 6 mm abrasive wheels
- 2 in a blister





	 731415		 mm	 mm	 g
BP424M	0134656	1	57	19	45

BP430M

ABRASIVE WHEEL



- 3 mm abrasive wheels
- 2 in a blister





	 731415		 mm	 mm	 g
BP430M	0134663	1	55	12	15

BP431M

ABRASIVE WHEEL



- 3 mm abrasive wheels
- 2 in a blister

	 731415		 mm	 mm	 g
BP431M	0134670	1	48	13	10

BP432M

ABRASIVE WHEEL



- 3 mm abrasive wheels
- 2 in a blister

	 731415		 mm	 mm	 g
BP432M	0134687	1	44	15	15



GRINDERS

BP433M

ABRASIVE WHEEL



- 3 mm abrasive wheels
- 2 in a blister

BP433M	731415 0134694	1	43	14	15

BP434M

ABRASIVE WHEEL



- 3 mm abrasive wheels
- 2 in a blister

BP434M	731415 0135837	1	42	13	15

BP117

LOW REVOLUTION GRINDER/TYRE BUFFER



- Tyre buffer
- Rubber grip
- Power regulator
- Safety trigger

				BAR									
BP117	731415 0184309	1	7/16"	6.3	1/4"	10	113	2500	80	1.68	373	246	1

BP117EH

LOW REVOLUTION GRINDER/TYRE BUFFER



- Tyre buffer exhaust hose
- To be used with BP117

BP117EH	731415 0184316	1	50x100x50	1



BP110

CUT OFF TOOL 3"



- Reversible cut off tool 3"/75 mm
- Rubber grip
- Power regulator
- Safety trigger
- Swivel connection

	 731415			BAR	 inch	 mm	 mm	 min ⁻¹	 dBA	 m/sec ²	 mm	 kg
BP110	0135011	1	75	6.3	1/4"	10	113	18,000	98	< 2.5	195	0.9

RECIPROCATING SAWS



BP824

RECIPROCATING SAW



- Reciprocating saw
- Composite housing
- Safety trigger
- Swivel connection
- 3 car body saws included

	 731415		BAR	 inch	 mm	 mm	 min ⁻¹	 dBA	 m/sec ²	 W	 mm	 kg
BP824	0134489	1	6.3	1/4"	10	160	10,000	85	3.70	260	0.51	0.905



DRILLS

BP825

DRILLS 13 MM



- Reversible drill 13 mm
- Composite housing
- Rubber grip
- Fast forward/reverse lever
- Air exhaust in handle
- Quick chuck
- Support handle included

			BAR									
BP825	0134496	1	6.3	1/4"	10	105	450	88	<2.50	220	1.35	1.53

BP926

DRILLS 13 MM



- Drill 13 mm
- Rubber grip
- Variable speed trigger
- Fast forward/reverse lever
- 0.0635 mm chuck runout
- Support handle included

				BAR									
BP926	0184248	1	13 mm	6.2	1/4"	10	108	0-34	450	80	< 2.5	222	1.3

BP925

DRILLS 10 MM



- Drill 10 mm
- Rubber grip
- Variable speed trigger
- Fast forward/reverse lever
- 0.0635 mm chuck runout

				BAR									
BP925	0184231	1	10 mm	6.2	1/4"	10	108	0-6	2500	80	< 2.5	178	1



BP125



RIVETERS

- Air riveter
- Composite handle
- Rubber grip

	 731415			BAR	 inch	 kg	 mm	 mm	 kg
BP125	0184323	1	3.2-6.4	6.3	1/4"	1330	19	290	2

HAMMERS



BP909



HAMMERS

- Hammer
- Rubber grip
- Power regulator
- Air exhaust in handle
- Kevlar flutter disc
- Quick chuck

	 731415		 mm	BAR	 inch	 mm	 mm	 mm	 (min-1)	 dB(A)	 m/sec ²	 mm	 kg
BP909	0184255	1	10.2	6.3	1/4"	10	76	1817	2500	94	< 2.5	230	2.1

BP909K



HAMMERS

- Hammer set
- Rubber grip
- Power regulator
- Air exhaust in handle
- Kevlar flutter disc
- Quick chuck
- Inlay fits into Bahco T-module system T12

	 731415		 mm	BAR	 inch	 mm	 mm	 mm	 (min-1)	 dB(A)	 m/sec ²	 mm	 kg
BP909K	0187898	1	10.2	6.3	1/4"	10	76	1817	2500	94	< 2.5	230	2.1



HAMMER CHISELS

BP909TF

HAMMER CHISELS



- Rotating 10.2 mm flat chisel

	 731151		A mm	B mm	 g
BP909TF	0187911	1	19	165	160

BP909TWF

HAMMER CHISELS



- Rotating 10.2 mm wide flat chisel

	 731151		A mm	B mm	 g
BP909TWF	0187928	1	38	165	180

BP909TTP

HAMMER CHISELS



- Rotating 10.2 mm tapered punch chisel

	 731151		A mm	B mm	 g
BP909TTP	0187935	1	-	165	140

BP909TE

HAMMER CHISELS



- Rotating 10.2 mm edging chisel

	 731151		A mm	B mm	 g
BP909TE	0187942	1	-	139	140

BP909TH

HAMMER CHISELS



- Rotating 10.2 mm hammer chisel

	 731151		A mm	B mm	 g
BP909TH	0187959	1	25	108	140



BP909TSP

HAMMER CHISELS



- Rotating 10.2 mm straight punch chisel

	731151		A mm	B mm	g
BP909TSP	0187966	1	13	165	140

BP909NF

HAMMER CHISELS



- Non rotating 10.2 mm flat chisel

	731151		A mm	B mm	g
BP909NF	0187973	1	19	190.5	230

BP909NE

HAMMER CHISELS



- Non rotating 10.2 mm edging chisel

	731151		A mm	B mm	g
BP909NE	0187980	1	-	178	180



PNEUMATIC MARKERS

BP799

PNEUMATIC MARKER



- Pneumatic engraving pen
- For fast and secure marking
- Low vibration
- Low air consumption

	 731415		BAR	 inch	 mm	 min-1	 dBA	 m/sec ²	 mm	 kg
BP799	0134502	1	6.3	1/4"	10	13,000	78	< 2.0	140	0.22

BP79912

CARBIDE TIP



- Pneumatic engraving pen consumable

	 731415		 g
BP79912	0134717	1	10



CARTRIDGE APPLICATOR

BP215

CARTRIDGE APPLICATOR



- Cartridge applicator 310 ml

	 731415		BAR	 inch	 mm	 mm	 kg
BP215	0134519	1	2.5-5.2	1/4"	10	210	1



SURFACE CLEANER

BP127

SURFACE CLEANER



- Surface cleaner
- 19 needles 3x180 mm















	 731415		BAR	 inch	 mm	 min-1	 dBA	 m/sec ²	 mm	 kg
BP127	0137565	1	6.3	1/4"	10	n/a	97	8.7	375	2.6

BP601

ORBITAL SANDER



- 5 mm Palm orbital sander
- Composite housing
- Can be used with central vacuum systems
- Velcro® pad included















	 731415		 mm	 velcro®	BAR	 inch	 mm	 l/min		 min-1	 dBA	 m/sec ²	 W	 mm	 kg
BP601	0134526	1	152	X	6.3	1/4"	10	255	yes	11,000	80	< 2.5	224	195	0.8

BP610

ORBITAL SANDER



- 2.5 mm Palm orbital sander
- Composite housing
- Can be used with central vacuum systems
- Velcro® pad included

	 731415		 mm	 velcro®	BAR	 inch	 mm	 l/min		 min-1	 dBA	 m/sec ²	 W	 mm	 kg
BP610	0134595	1	152	X	6.3	1/4"	10	255	yes	11,000	80	< 2.5	224	195	0.8

BP51137

ORBITAL SANDER PAD



- Orbital sander pad
- Velcro® pad included











	 731415		 mm	 velcro®	 g
BP51137	0134724	1	152	X	130

BP212

BELT SANDERS



- 10 mm Belt sander
- Quick belt release button

	 731415		BAR	 inch	 mm	 min-1	 dBA	 m/sec ²	 mm	 kg
BP212	0134601	1	6.3	1/4"	10	16,000	83	< 2.5	260	0.8



SANDERS

BP222

BELT SANDERS



- 20 mm Belt sander
- Quick belt release button

			BAR							
BP222	0137572	1	6.3	1/4"	10	16,000	85.5	3.2	360	1.1

BPN22201/21201

BELT SANDERS



- Pack of 25 sander belts

BPN21201	0134731	1	10	75
BPN22201	0138074	1	20	330

BP204K

PISTOL GRIP SANDERS



- Pistol grip sander set
- Includes:
 - 1 pc BP204
 - 25 pcs sanding discs 180 grit
 - 25 pcs sanding discs 220 grit
 - 10 pcs sanding discs 320 grit
 - 10 pcs sanding discs 800 grit

					BAR										
BP204K	0184293	1	77	-	6.3	1/4"	10	170	-	15000	85	4.53	168	132	2.5

BP204

PISTOL GRIP SANDERS



- Pistol grip sander
- Rubber grip
- Top mounted speed change switch
- Air exhaust in handle
- Velcro® pad included

					BAR										
BP204	0184286	1	77	-	6.3	1/4"	10	70	-	15000	85	11.48	250	132	0.5



BP204PAD

PISTOL GRIP SANDERS PAD



- Sanding pad
- To be used with BP204

BP204PAD	731415 0185917	1	77 mm	- velcro	30 kg

WINDSCREEN REMOVER



BP233

WINDSCREEN REMOVER



- Windscreen remover
- Pipe away exhaust
- Low vibration <2.2 m/s²
- Noise reducing hose

			BAR								
BP233	731415 0134748	1	6.3	1/4"	10 mm	260	20,000 (min-1)	80.5 dBA	< 2.2 m/sec ²	200 mm	1.2 kg

BLADES & SCRAPERS



BPBU

U SHAPED BLADES



- "U" Shaped blades
- 2 in a blister

BPBU18	731415 0134755	1	18 mm	50 g
BPBU24	0134762	1	24	50
BPBU36	0134779	1	36	55
BPBU60	0134786	1	60	60
BPBU90	0134793	1	90	90



BLADES & SCRAPERS

BPBSC

SCRAPERS



- Scraper
- 2 units in a blister

	 731415		 mm	 g
BPBSC156	0134816	1	15	70

BPBG

STRAIGHT BLADES



- Straight blades
- A: Flat shape
- B: Jagged shape

	 731415		 mm	A mm	B mm	 g
BPBG3515	0134823	1	15	X		40
BPBG3525A	0134830	1	25	X		30
BPBG3525B	0134847	1	25		X	30

BPBK

COMA SHAPED BLADES



- Offset coma blades
- 2 in a blister

	 731415		 mm	 g
BPBK30	0134854	1	30	55

BPBG5725/9057

STRAIGHT OFFSET BLADES



- Offset 13 mm blades
- 2 in a blister

	 731415		 mm	 g
BPBG5725	0134861	1	57	65
BPBG9057	0134878	1	90	85

BPHVLP01

HVLP PAINT GUN



- HVLP Paint spray gun
- Spare nozzle sets included: 1.0 mm, 1.2 mm, 1.4 mm, 1.7 mm and 2.0 mm





	 731415		BAR	 inch	 mm	 l/min	 mm	 kg
BPHVLP01	0138937	1	2-2.8	1/4"	10	250	185	0.7

BPHVLP

NOZZLE SETS



- Nozzle sets
- To be used with BPHVLP01

	 731415		\varnothing mm	 kg
BPHVLP0110	0165865	1	1.0	0.1
BPHVLP0112	0165872	1	1.2	0.1
BPHVLP0114	0165889	1	1.4	0.1
BPHVLP0117	0165896	1	1.7	0.1
BPHVLP0120	0165902	1	2.0	0.1



BP500

MAGNETIC HOLDER



- Magnetic holder for impact wrenches
- Includes 2 powerful magnets and supports:
 - 1 impact wrench
 - 4 sockets
 - 1 torque wrench
 - Coated in special paint to avoid scratches and damage to the tools

	 731415		
BP500	0137992	1	0.380

BPN251

LUBRICATOR



- In line lubricator 1/4"
- Lubricates the air to ensure correct operation and longer lifetime of the air tools

	 731415			
BPN251	0137589	1	1/4"	0.100

BP254

FILTER-REGULATOR



- Filter regulator unit 1/2"
- Bowl capacity: 200 cc
- T° range: -5°C -60°C
- Filters the air to avoid damage caused by dust
- Regulates desired pressure between 1 and 8.5 bar

	 731415		BAR			
BP254	0137633	1	1-8.5	1/2"	max 3800 L/min	0.8



BP255

FILTER/REGULATOR/LUBRICATOR



- Filter regulator lubricator unit 1/2"
- Bowl capacity: 200 cc
- T° range: -5°C -60°C
- Filters the air to avoid damages caused by dust
- Regulates desired pressure between 1 and 8.5 bar
- Automatically lubricates the air to ensure correct operation and longer lifetime of the air tools

	 731415		BAR	 inch	 l/min	 kg
BP255	0137640	1	1-8.5	1/2"	max 3,800	0.8

BPHR1020/1315

HOSE REELS



- Air hose reels
- 180° swivel bracket
- Detachable pin
- Polypropylene housing
- Durable corrosion and rough environment resistant polypropylene housing
- Latching system which automatically locks the hose at desired length for increased functionality and comfort

	 731415		BAR	 inch	 mm	 mm	 kg
BPHR1020	0138616	1	20	3/8"-3/8"	20	10	9.7
BPHR1315	0138593	1	12	1/2"-1/2"	15	13	9.7

BPHRS1315

HOSE REELS



- Air hose reel
- 110° Swivel base
- Adjustable double guide arm
- Strengthened frame steel housing
- Corrosion resistant
- Ball bearing swivel
- Latching system which automatically locks the hose at desired length for increased comfort and functionality

	 731415		BAR	 inch	 mm	 mm	 kg
BPHRS1315	0138609	1	20	1/2"-1/2"	15	13	24



BPH1010

SPIRAL HOSES



- 10 mm air spiral hose
- Polyurethane hose with fixed threaded connector at both ends

	 731415		 mm	 m	 inch	 kg
BPH1010	0138890	12	10	10	1/4"-1/4"	0.855

BPH1310

SPIRAL HOSES



- 13 mm air spiral hose
- Polyurethane hose with fixed threaded connector at both ends

	 731415		 mm	 m	 inch	 kg
BPH1310	0138883	2	13	10	1/2"-1/2"	1;66

BPQCF14

QUICK CONNECTORS



- Air connector 1/4" Female
- Fast and safe operation system
- Max pressure 14 bar
- Air flow 1600 L/min at 6 bar
- Plug diameter 6 mm
- Works with 4 standard male connector profiles
- Security lock enabling the operator to turn on and off the air flow, providing a safer and more simplified operation
- Steel construction with composite coating, making it extremely durable

	 731415		 inch	 g
BPQCF14	0138920	1	1/4"	95



BP826

AIR GUN 1/4", 1800 RPM



- Air driver 1800 RPM 1/4"
- External adjustable clutch

				BAR									
BP826	0137459	1	1/4"	6.3	1/4"	10	113	1-10	1800	83	< 2.5	196	1.2

BP827

AIR GUN 1/4", 800 RPM



- Air driver 800 RPM 1/4"
- External adjustable clutch

				BAR									
BP827	0137442	1	1/4"	6.3	1/4"	10	113	1-12	800	83	< 2.5	214	1.4



BP218

OSHA BLOW GUN



- Air blow gun
- Meets OSHA requirements
- Brass inlet

			BAR					
BP218	0170272	1	6.3 bar	1/4"	158	>80 dBA	210	0.15

AUTOMOTIVE SPECIALITY TOOLS & EQUIPMENT

Bahco offers a comprehensive range of tools and equipment for the maintenance and repair of passenger cars and heavy vehicles.

In this section you will find a core product range as well as application specific tools and equipment including boosters, battery tools, hydraulic equipment and OEM engine tools.

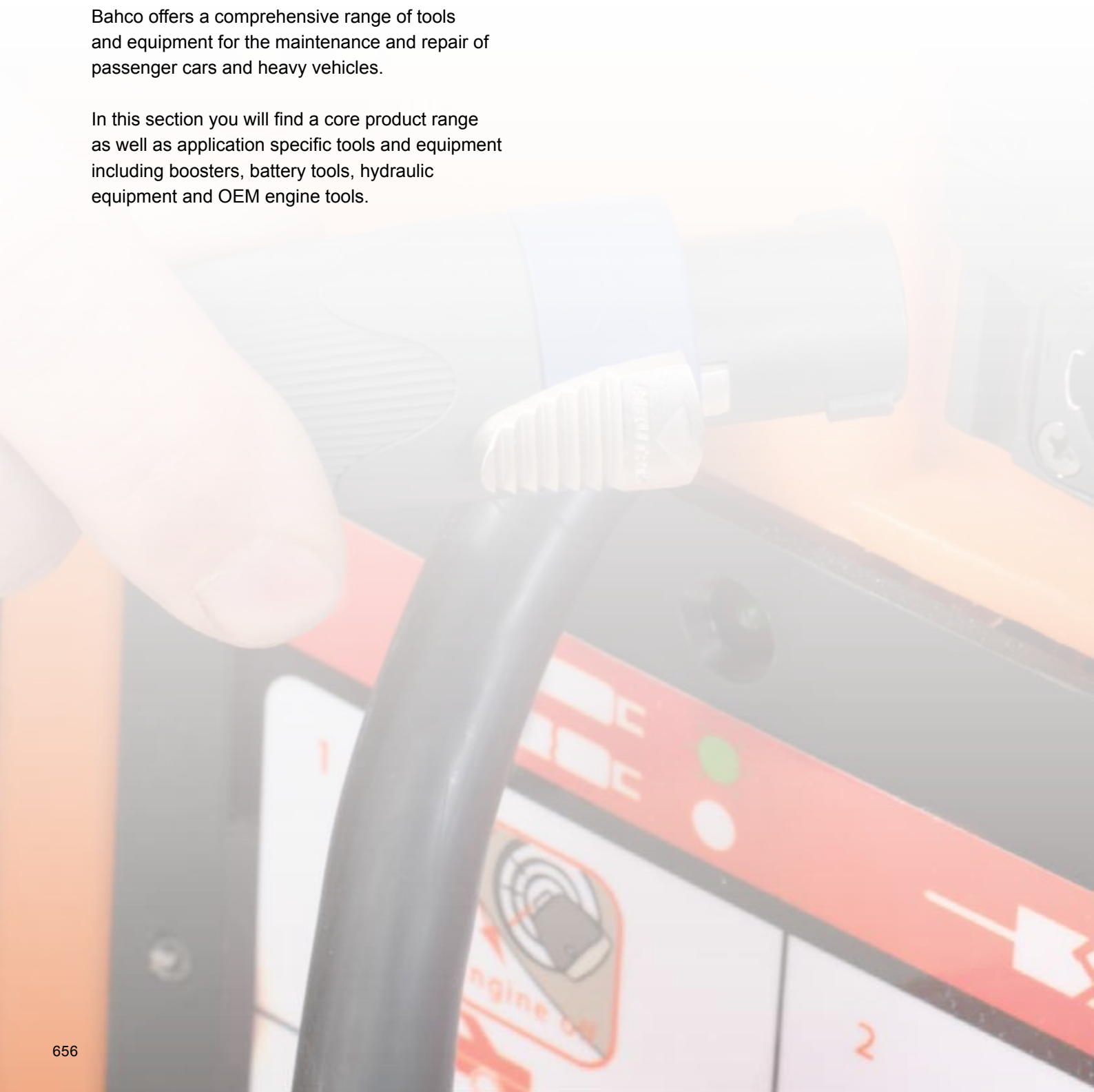

Chapter Index

ENGINE TOOLS AND EQUIPMENT	662-682
OIL SERVICE TOOLS AND EQUIPMENT	683-687
BRAKE SYSTEM TOOLS AND EQUIPMENT	687-688
TRANSMISSION AND WHEEL TOOLS	689-694
SUSPENSION TOOLS AND EQUIPMENT	694-695
AUTO ELECTRIC TOOLS AND EQUIPMENT	696-703
GARAGE EQUIPMENT	703-706
BODY SHOP TOOLS AND EQUIPMENT	707-708

ICON INDEX

	Manufacturer		Outer Diameter		Cable Inner Section
	Bit Size mm		Diameter		Cable Length
	Axle Capacity		Inner Diameter		Cable Working T °C
	Length mm		Weight g		Charger Amps
	Diameter mm		Weight kg		Clamps Length
	Capacity Litres		Air Inlet		Clamps Opening
	Package Dimensions		Maximum Torque in Reverse Mode Nm		Fuse Amps
	Drive mm		Clamping spring		Reverser polarity Alarms
	Drive inch		Voltage		On/Off Poka Yoke Switch
	Socket Size mm		Cranking Amps		Blade Length
	Tamper Torx		Peak Amps		Handle dimensions
	Hexagonal male		Output Amps		Total Length
	Star Diameter		Charging Time		
	Drive Out		Battery Amps Hour		



BAHCO AUTOMOTIVE TOOLS



ENGINE TOOLS

Essential tools for engine and plug repair including brand specific timing tool kits, spark and glow plug tools, piston ring tools and exhaust tools, special bits and sockets and other specific engine tools.



BATTERY BOOSTERS

A full range of premium boosters designed for both passenger cars and heavy vehicles, with even the most challenged batteries.



TRANSMISSION AND WHEEL TOOLS

Specific impact sockets for cars and heavy vehicles; torsion bars for the correct torque application; wheel wrenches and tools for tyre removal.



BATTERY TESTERS

Testers with or without printer, applicable for 6V and 12V batteries.



OIL SERVICE TOOLS

Oil drainers, oil pans and tanks as well as a variety of cups and wrenches for removal of oil filters.



ELECTRIC TESTERS

A comprehensive range of testers for passenger cars and heavy vehicles with a wide variety of different plugs, a memory saver, a peak protector as well as testers of the lambda sensor and remote key controls.



BRAKE SYSTEM TOOLS

Including pneumatic brake caliper tool and a set for change of brake pads, as well as equipment for testing and bleeding the brake liquid.



BODY REPAIR TOOLS

Tools for body repair, including windscreen work and removal of car body objects.



GARAGE EQUIPMENT

Including a headlight tester, a pneumatic vacuum cleaner and other essential items.



SUSPENSION TOOLS

Includes spring compressors and accessories, as well as a universal McPherson shock absorber set.

BAHCO BOOSTERS

2-COMPONENT HANDLE

Allows easy and comfortable handling

ULTRA RESISTANT HOUSING

The one-piece, 5 mm thick roto moulded PE housing ensures durability and withstands the toughest environments and most chemicals used in the garage

ELECTRONIC FUSE CHECK SYSTEM

Easy control for the internal fuse via push button and LED indicator system. Simple, visual and fast. No need for external testing devices



REINFORCED CONNECTION

Reinforcement between clamp and cable prevents copper shearing

AGM HIGH PERFORMANCE BATTERIES

Absorption Glass Mat (AGM) batteries ideal for jump starts with high-delivery rates of amperage and quick recovery capacity. Completely sealed, leakage and maintenance-free design for carefree storage and handling

LONG AND THICK GAUGE CABLES

Double insulated welding cables prevent injuries, guarantee long tool life and flexibility under the most extreme conditions. Extra long and thick cables ensure flexible usage, great accessibility and efficient conductivity



ELECTRONIC CHARGE

All Bahco Boosters are provided with an intelligent electronic charger. It is recommended that the boosters are left on charge when not in use.

POKA-YOKE ON/OFF SYSTEM

The dual function ON/OFF feature ensures high safety and elimination of uncontrolled current. No current in the clamps when set in OFF mode and no possibility to charge in ON mode (not applicable for model BB1224-1200)

ILLUMINATED VOLTMETER

Multi function voltmeter allows testing vehicle's alternator, or indicates booster's battery status and charging process



DUAL FUNCTION POLARITY – INVERSION WARNING SYSTEM

Both visual and audio polarity reverse alarm, to warn the operator if the clamps are connected in reverse

VOLTAGE OUTLET

12 V outlet with 16 A internal quick fuse to run smaller devices. 24 V outlet with 16 A internal quick fuse to run smaller devices in the BB24-1200 unit



1.000 A CLAMPS

Large professional clamps with wide opening, full insulation, efficient conductivity due to the bronze embraced jaws and angled, smooth design for great accessibility. Fully-insulated solid copper bridge between the jaws prevents copper shearing and ensures high conductivity



BE1P

SPARK AND GLOW PLUG TOOLS



- Spark plug pliers
- To pull out spark plug caps without damaging the cables

	 731415		 mm	 mm	 g
BE1P	0170067	1	290	30x310x56	310

7406ZZ

SPARK AND GLOW PLUG TOOLS

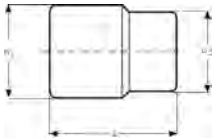

- Spark plug socket, 3/8" square drive
- Hex profile, metric/inch sizes
- Internal magnetic collar retaining system
- Not suitable for machine operation
- High polished finish
- Knurled

	 731415		 mm	 "	L mm	D1 mm	D2 mm	 g
7406ZZ-16	3011992	1	16	5/8	65	19	21	95
7406ZZ-21	3012005	1	21	13/16	65	28	21	105

7805ZZ

SPARK AND GLOW PLUG TOOLS

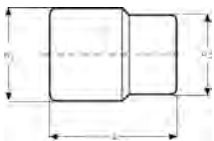

- Spark plug socket, 1/2" square drive
- Hex profile, metric sizes
- Internal rubber collar retaining system
- Hole for manipulating with a bar
- Not suitable for machine operation
- High polished finish
- Knurled

	 731415		 mm	 "	L mm	D1 mm	D2 mm	 g
7805ZZ-16	1822767	1	16	5/8	69	21.8	21.8	100
7805ZZ-21	1347338	1	21	13/16	73	28.3	24.3	173



SBS71

SPARK AND GLOW PLUG TOOLS



- Spark plug socket, 3/8" square drive
- Hex profile, metric sizes
- Internal rubber collar retaining system
- Not suitable for machine operation
- Matt finish

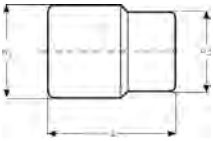

	 731415		 mm	 "	L mm	D1 mm	D2 mm	 g
SBS71-16	0127245	1	16	5/8	62	21.8	19.2	90
SBS71-21	0127252	1	21	13/16	65	28	21.8	130

BE1SP14L

SPARK AND GLOW PLUG TOOLS



- Spark plug socket bi-hex 14 mm - 3/8"
- L: 250 mm
- Rubber retaining system

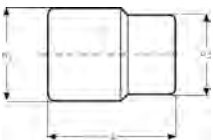

	 731415		 3/8"	 mm	 "	L mm	D1 mm	D2 mm	 g
BE1SP14L	0170074	1	3/8"	14	9/16	250	18	18	430

BE1T14/BE1T16/BE1T21

SPARK AND GLOW PLUG TOOLS



- Cardan spark plug wrenches
- Long reach T-handle
- Rubber retaining system

	 731415		 mm	 "	 mm	 kg
BE1T14	0167630	1	6	14	65/300	0.5
BE1T16	0167647	1	6	16	63/450	0.56
BE1T21	0167654	1	6	21	64/450	0.65



BE1GP5

SPARK AND GLOW PLUG TOOLS



- Universal glow plug bi-hex socket set
- 1/4" drive
- Retaining ring system
- Cardan system allows access to difficult-to-reach places and ensures flexibility
- Dimensions:
 - L1 is 52 mm for all 5 sockets
 - L is 70 mm for all 5 sockets
- Ideal to be used with BE1GP5-T T-handle

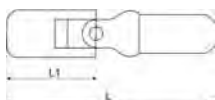

BE1GP5	0170043	1	1/4"	8, 9, 10, 12, 14	70	52	40x240x110	0.46

BE1GP5-T

SPARK AND GLOW PLUG TOOLS



- 1/4" extra long T-handle
- Ideal to be used with BE1GP5 glow plug socket set

BE1GP5-T	0170050	10	1/4"	400	10x500x170	400

BE100

SPARK AND GLOW PLUG TOOLS



- Glow plug tester
- An easy and quick way to check glow plugs are functioning correctly
- Protected against polarity inversion

BE100	0177912	1	60x155x68	0.37



7807

SPARK AND GLOW PLUG TOOLS

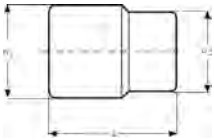

- Special socket for diesel injection, 27 mm - 1/2"
- Not suitable for machine operation
- High performance alloy steel
- High polished finish
- ISO 1174
- DIN 3120

	 731415		 mm	L mm	D1 mm	D2 mm	 g
7807	3012029	1	27	83	29	29	145

7806

SPARK AND GLOW PLUG TOOLS

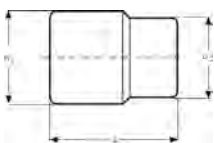

- Special socket for Lambda sensor service, 22 mm - 1/2"
- Not suitable for machine operation
- High performance alloy steel
- High polished finish
- ISO 1174
- DIN 3120

	 731415		 mm	L mm	D1 mm	D2 mm	 g
7806	3012012	1	22	87	36	36	265

BE74-55100/BE74-80120

PISTON AND PISTON RING TOOLS



- Piston ring tongs
- Enables piston rings to be removed or installed quickly and easily without a risk of breaking or damaging them

	 731415		 mm	 mm	 g
BE74-55100	0169733	1	55-100	85x220x125	320
BE74-80120	0169740	1	80-120	20x220x145	290



BE74-57125/BE74-90175

PISTON AND PISTON RING TOOLS



- Piston ring tighteners
- Enables piston rings to be removed or installed quickly and easily without a risk of breaking or damaging them
- Facility to lock the piston ring in desired position

	 731415		 mm	 mm	 mm	 g
BE74-57125	0169511	1	80	57-125	70x110x75	0.28
BE74-90175	0169528	1	165	90-175	80x205x110	0.58
BE74-57125L	0169535	1	80	57-125	75x110x75	0.33

BUC50

EXHAUST SYSTEM TOOLS



- Universal exhaust clamp pliers
- Max opening 65 mm

	 731415		 mm	 mm	 mm	 kg
BUC50	0182329	1	65	300	25x310x70	0.41

BUC100

EXHAUST SYSTEM TOOLS



- Universal exhaust puller
- Allows easy disassembly of the exhaust systems without cutting
- Two adaptors included to enable tightening of small diameters
- Carbon steel jaws

	 731415		 mm	 mm	 kg
BUC100	0169962	1	34-54	95x325x240	4.65



BE523110B

ENGINE SETTING TOOLS (TIMING)



- Camshaft locking tool for Alfa Romeo
- 1.8/2.0 Twin Spark, GTV 1.8/2.0 Twin Spark, GTV 2.0 16v (1996-...)
- Alfa Romeo: 145, 146, 155, 156, Spider
- OEM Reference No 1 825 041 000

	 731415		 mm	 kg
BE523110B	0178377	1	179x50x50	0.276

BE523110C

ENGINE SETTING TOOLS (TIMING)



- Camshaft locking tool for Alfa Romeo
- 1.4/1.6 Twin Spark (1996-...)
- Alfa Romeo: 145, 146, 155, 156
- OEM Reference No 1 825 042 000

	 731415		 mm	 kg
BE523110C	0178384	1	179x50x50	0.276

BE523076

ENGINE SETTING TOOLS (TIMING)



- Timing tool for Bosch VE type fuel pumps
- Also suitable for compatible pumps manufactured by Kikki and Nippon Denso
- Dial Test Indicator 41 x 8 mm
- Threaded sizes M8, M10, M12

	 731415		 mm	 kg
BE523076	0178407	1	185x137x48	0.800

BE52306100

ENGINE SETTING TOOLS (TIMING)



- Engine timing tool set Citroen, Peugeot (PSA Group)
- This comprehensive set of tools enables the correct engine timing to be set when replacing the timing belt
- Suitable for use on the most recent engines with either HPi (Petrol) or HDi (Diesel) engines
- Full application list and OEM codes are included

	 731415		 mm	 kg
BE52306100	0178001	1	185x410x48	2.366



BE52306170

ENGINE SETTING TOOLS (TIMING)



- Petrol timing tool set Citroen, Peugeot (PSA Group)- EW engines (1998- 2007)
- 1.8 16v, 2.0 16v, 2.0HPI, 2.2 16v
- Citroën: Xsara, Picasso, C5, C4, Evasion, Synergie, C8, Jumpy, Dispatch
- Peugeot: 206, 307, 406 Coupe, 607, 806, 807, Expert

	 731415		 mm	 kg
BE52306170	0178032	1	185x275x48	1.258

BE523055

ENGINE SETTING TOOLS (TIMING)



- Petrol engines timing kit for Citroen, Peugeot (PSA Group)
- Crankshaft & camshaft pins and tensioning tools
- Suitable for 1.0, 1.1, 1.4, 1.6 and 1.9 engines (1982- 1997)

	 731415		 mm	 kg
BE523055	0178018	1	50x105x105	0.235

BE52311102

ENGINE SETTING TOOLS (TIMING)



- Flywheel locking tool for Citroen, Peugeot (PSA Group) and Fiat Group
- 2.5 and 2.8 diesel engines
- OEM Ref 01534A | 6012T | 9765.54

	 731415		 mm	 kg
BE52311102	0178117	1	93x50x50	0.135

BE523171

ENGINE SETTING TOOLS (TIMING)



- Petrol engine timing tool set Fiat Group 1.2 16v
- Fiat: Bravo, Brava, Punto, Grande Punto, Marea, Marea Weekend, Palio, Stilo, 500 (1993- 2007)
- Lancia: Ypsilon (1996- 2003)

	 731415		 mm	 kg
BE523171	0178346	1	185x275x48	0.989



BE523158

ENGINE SETTING TOOLS (TIMING)



- Diesel timing tool set for Citroën, Peugeot (PSA Group) and Fiat Group (using PSA Group origin engines)
- 1.9D/TD, 2.1TD, 2.1D Turbo, 2.2D, 2.2TD and 2.4D Turbo
- Includes cranked setting bar, flywheel locking tool, crankshaft timing tool and timing pump locking pin

	 731415		 mm	 kg
BE523158	0178353	1	205x163x50	1.248

BE523156

ENGINE SETTING TOOLS (TIMING)



- Petrol engine timing tool set for Fiat Group 1.6 16V
- Brava, Bravo, Coupe, Marea, Marea Weekend, Tipo, Stilo

	 731415		 mm	 kg
BE523156	0178360	1	205x163x50	1.869

BE523160

ENGINE SETTING TOOLS (TIMING)



- Petrol and diesel timing tool set Ford
- Covers most engines in the Ford range pre 2007 including Zetec engines

	 731415		 mm	 kg
BE523160	0178254	1	185x275x48	1.483

BE523175

ENGINE SETTING TOOLS (TIMING)



- Diesel timing tool set Ford and PSA Group
- Ford Duratorq 1.4, 1.6, 2.0, 2.2 and 2.4 TDCI Fiesta, Fusion, Mondeo, Transit
- PSA 1.4 1.6 HDI C3, 206, 307

	 731415		 mm	 kg
BE523175	0178292	1	185x275x48	0.956



BE523360

ENGINE SETTING TOOLS (TIMING)



- Engine timing tool set for Ford
- Use on 1.6 Ri VCT
- Focus and C Max (03-) Fiesta Fusion 1.4 1.6 TDCi
- Mondeo, S Max, Transit Connect and Tourneo Connect 1.8 Tddi/TDCi and 2.0 TDCi

	 731415		 mm	 kg
BE523360	0178278	1	185x410x48	4.36

BE52305450

ENGINE SETTING TOOLS (TIMING)



- Petrol timing tool set Ford Zetec 1.25, 1.4, 1.6, 1.7, 1.8, 2.0 16v (1991- 2007)
- Ford: Escort, Orion, Fiesta, Puma, Fusion, Focus, C Max, Mondeo
- Mazda: 121
- Volvo: 1.8 & 2.0

	 731415		 mm	 kg
BE52305450	0178322	1	179x50x50	0.291

BE52306900

ENGINE SETTING TOOLS (TIMING)



- Petrol and diesel engine timing tool set Renault
- Also suitable for Laguna 2.2D TD, Safrane 2.2TD, Espace 2.2 TD, Trafic 2.5D, Master 2.5D TD
- Originally specified for engines designed before 2003 but some components are used on engines up to 2010

	 731415		 mm	 kg
BE52306900	0178148	1	370x410x48	4.01

BE52306950

ENGINE SETTING TOOLS (TIMING)



- Petrol engine timing tool set for Renault, Nissan Twin CAM 16V
- Suitable for 1.4, 1.6, 1.8 and 2.0 engines (1998- 2003)

	 731415		 mm	 kg
BE52306950	0178124	1	205x163x50	1.772



BE52317301

ENGINE SETTING TOOLS (TIMING)



- Engine timing tool set for Renault DCI
- Applications CD included

	 731415		 mm	 kg
BE52317301	0178131	1	185x410x48 mm	2.229

BE52306929

ENGINE SETTING TOOLS (TIMING)



- Diesel timing pins Renault, Nissan 1.5 1.9 DCI
- Renault 1.5 and 1.9 DCi engines fitted to Laguna, Kangoo and Clio (2002- 2010)
- Nissan Almera, Kubistar, Micra 1.5 Dci engines (2002- 2010)

	 731415		 mm	 kg
BE52306929	0178315	1	93x50x50	0.222

BE523047

ENGINE SETTING TOOLS (TIMING)



- Engine timing tool set for Opel, Vauxhall, Saab V6
- V6 belt driven engine on 2.5, 2.6, 3.0

	 731415		 mm	 kg
BE523047	0177950	1	460X140X52	2.4

BE523166

ENGINE SETTING TOOLS (TIMING)



- Petrol engine timing tool set for Opel, Vauxhall
- Suitable for 1.0, 1.2 and 1.4 (1997- 2010)
- Agila, Astra G/H, Combo-C, Corsa-B,C,D, Meriva-A, Tigra-B

	 731415		 mm	 kg
BE523166	0178308	1	185x137x48	0.912



BE523167

ENGINE SETTING TOOLS (TIMING)



- Diesel engine timing tool set for Opel, Vauxhall, Saab
- Ecotec 2.0DTI D and 2.2DTI D (1998-2005)
- Opel/Vauxhall: Astra-G, Vectra-B/C, Sintra, Zafira A, Frontera-B, Omega-B models
- Saab: 9-3, 9-5 with 2.2D Turbo

BE523167	731415 0177998	1	185x275x48 mm	1.355 kg

BE523174

ENGINE SETTING TOOLS (TIMING)



- Engine timing tool set Opel, Vauxhall, Saab
- Opel, Vauxhall: 1.3 1.9 CDTi Corsa, Astra, Combo, Meriva, Signum, Tigra, Vectra, Zafira
- Saab: 1.9 Tdi fitted to Saab 9-3 (2004- 2009) and 9-5 (2003- 2010)

BE523174	731415 0178261	1	185x275x48 mm	2.1 kg

BE52305801

ENGINE SETTING TOOLS (TIMING)



- Twin camshaft locking tool for Opel/Vauxhall/Saab (1998- 2010)
- Opel/Vauxhall 1.4/1.6/1.8 16v Ecotec engines
- Saab 9-3 1.8 petrol engines: Z18XE (2003- 2010)
- OEM Ref: KM 852

BE52305801	731415 0177967	1	93x50x50 mm	0.186 kg

BE52305802

ENGINE SETTING TOOLS (TIMING)



- Twin camshaft sprocket tool for Opel, Vauxhall
- 2.0, 2.2 16v Eco-Tec engine
- OEM Ref: KM 853

BE52305802	731415 0178285	1	93x50x50 mm	0.143 kg



BE523161

ENGINE SETTING TOOLS (TIMING)



- Universal timing tool set for Audi-Volkswagen Group
- Essential tools for VAG petrol and diesel engines fitted to Ford Galaxy etc from 1996 - 2004
- The kit also includes tools suitable for older models with 1.9 diesel engine

	 731415		 mm	 kg
BE523161	0178193	1	179x275x48	0.451

BE52316190

ENGINE SETTING TOOLS (TIMING)



- Petrol timing tool set Audi-Volkswagen Group 2.0 FSI TFSI (2003-...)
- Audi: A3, A4, A6, S3, TT 2.0 (2003- 2010)
- Volkswagen: Passat, Touran

	 731415		 mm	 kg
BE52316190	0178179	1	185x275x48	1.351

BE523176

ENGINE SETTING TOOLS (TIMING)



- Petrol timing tool set Audi-Volkswagen Group 1.2- 3 Cyl. 6v & 12v (2002-...)
- Seat: Ibiza, Cordoba (2002- 2009)
- Skoda: Fabia, Roomster (2002- 2010)
- Volkswagen: Lupo, Polo (2002-...)

	 731415		 mm	 kg
BE523176	0178155	1	185x137x48	1.01

BE52316230

ENGINE SETTING TOOLS (TIMING)



- Petrol timing tool set Audi-Volkswagen 1.4TSI & 1.6FSI
- Audi A3
- Skoda: Fabia II, Octavia II & Roomster
- Volkswagen: Polo, Golf, Golf Estate, Golf Plus, Jetta, Passat, Eos, Tiguan & Touran

	 731415		 mm	 kg
BE52316230	0178186	1	185x275x48	2.229



BE52305650

ENGINE SETTING TOOLS (TIMING)



- Timing tool kit Audi/Volkswagen Group
- Specifically for the 2.5 V6 TDI (98-08) engines and Audi A4, S4 Turbo, A6, S6 V8, A8, Allroad and Volkswagen Passat and Sharan Tdi

	 731415		 mm	 kg
BE52305650	0178216	1	179x50x50	0.056

BE52316150

ENGINE SETTING TOOLS (TIMING)



- Diesel timing tool set Audi-Volkswagen Group 2.0TDI PO DOCH (2002- 2009)
- Audi: A3, A4, A5, A6
- Skoda: Octavia II
- Volkswagen: Golf, Golf Plus, Jetta and Touran
- Ford: Galaxy Tdi PD

	 731415		 mm	 kg
BE52316150	0178209	1	179x275x48	0.451

BE523161B

ENGINE SETTING TOOLS (TIMING)



- Camshaft setting bracket for Audi-Volkswagen Group
- Suitable for 1.9TDI engines
- OEM Ref: 2065A

	 731415		 mm	 kg
BE523161B	0178230	1	179x50x50	0.309

BE52306120

ENGINE SETTING TOOLS (TIMING)



- Diesel timing kit for Audi, Volkswagen Group 1991- 2004
- Also used in some Volvo and Ford engines
- Suitable for 1.7Sdi, 1.7/1.9SDI, 1.9D, 1.9TD, 1.9TDI, 2.4D, 2.5TDI
- Set includes setting spigot OEM 2064
- Setting bracket OEM 2065A

	 731415		 mm	 kg
BE52306120	0178223	1	93x50x50	0.251



BE52316197

ENGINE SETTING TOOLS (TIMING)



- Petrol and diesel engines tensioner pins Audi-Volkswagen Group and Ford
- 1.4, 1.9, 2.5 Tdi PD/TFSi
- Cam belt and serpentine (auxiliary) belt tension holder in VAG engines

	 731415		 mm	 kg
BE52316197	0178247	1	93x50x50	0.039

BE52306912

ENGINE SETTING TOOLS (TIMING)



- Tensioner locking tool for Volkswagen-Audi Group
- OEM Ref: T10008

	 731415		 mm	 kg
BE52306912	0178339	1	93x50x50	0.024

BE52304405

ENGINE SETTING TOOLS (TIMING)



- Multi positional pulley tensioner Audi, Volkswagen Group
- Five adjustable positions for when access is difficult
- OEM Ref: T10020/Matra V159

	 731415		 mm	 kg
BE52304405	0178162	1	179x50x50	0.227

BE52306920

ENGINE SETTING TOOLS (TIMING)



- Petrol timing tool set Volvo 1.6 16v, 1.6 1.8 2.0 Turbo (1996-2008)
- C30, S30, S40, V40, S70, C70, S80

	 731415		 mm	 kg
BE52306920	0177981	1	185x275x48	2.1



BE523106

ENGINE SETTING TOOLS (TIMING)



- Universal sprocket camshaft holding wrench
- Holds the sprocket whilst releasing the fastener
- Reduces damage to camshaft



BE523106



0178391



1



0.41



91

BE52306110

ENGINE SETTING TOOLS (TIMING)



- Engine timing set for diesel Citroën, Peugeot (PSA Group) and Fiat Group
- For setting and locking the camshaft and diesel pump
- Suitable for non-common rail diesel engines 1.7D, 1.8D, 1.9D, 1.9TD, 2.1TD, 2.2TD, 2.5TD (1982- 2002)
- OEM reference included with the kit



BE52306110



0178025



1



0.2



276

BE52316404

ENGINE SETTING TOOLS (TIMING)



- Flywheel locking tool Opel, Vauxhall, Saab
- Opel, Vauxhall: Astra, Astra-G, Astra-H, Barina, Combo, Combo-C, Meriva, Meriva-A, Signum, Tigra, Tigra-B, Vectra-B, Vectra-C, Vivaro, Zafira-A, Zafira-B
- Saab: 9-3
- OEM Ref: KM911



BE52316404



0177974



1



0.135



8



BE230

ENGINE SETTING TOOLS (TIMING)



- Universal stretch belt installation & removal set
- Pulley diameter range: 80-350 mm
- Approved by several manufacturers of belts
- Enables safe and easy assembly and removal of stretchy belts
- Stretch belts cannot be fitted manually

BE230	731415 0182633	1	120x30x25 mm	0.25 kg

BE500P24

ENGINE SETTING TOOLS (TIMING)



- Universal alternator extractor set. 24 pcs
- Covering the majority of the European vehicle fleet

BE500P24	731415 0169955	1	44x260x150 mm	1.24 kg

BE300

CLUTCH TOOLS



- SAC - Self adjustable clutch remover & installer universal tool set
- Ensures an accurate disassembly and assembly of clutches
- For 3 and 4 hole pitch SAC
- Applicable for Renault, BMW, Mercedes, VW Group, Volvo, etc

BE300	731415 0182312	1	86x193x173 mm	8 kg



BE255

COOLING SYSTEM TOOLS



- Universal flexible hose clamp pliers
- Applicable for all standard hose clamps
- One hand operation ratcheting type holding mechanism
- Exchangable cable set screw
- Soft grip handle

BE255	731415	1	18-54 mm	560 mm	30x450x220 mm	790 g

BE250

COOLING SYSTEM TOOLS



- 45° angled hose clamp plier
- Angled head and rotating jaws

BE250	731415	1	280 mm	250 g

2468

COOLING SYSTEM TOOLS



- Universal hose cutting pliers
- Multi cutter, ideal for cutting heater hoses, fuel line hoses, copper wiring, PVC pipes, wiper hoses and air brake hoses, plus any resilient or semi-resilient material
- Cutting capacity: 6-35 mm diameter

2468	731151	10	255 mm	405 g



3046-REF



COOLING SYSTEM TOOLS

- Refractometer
- Indicates the freezing point of propylene and ethylene glycol-based antifreeze solution
- Gives indication of the charge level in battery acid
- Includes steel and glass constructed head and prism, rubber finger grip, and focusing eyepiece with eyecup
- Specification range: -45°C to 0°C propylene glycol and -50°C to 0°C ethylene glycol

	 731151		 mm	 g
3046-REF	8276966	25	200	435

BE5049



10 MM BITS SET

- 10 mm bit set: 49 pcs
- Complete set of sockets and various bits for the automotive segment developed together with professional technicians
- In total including 49 pcs in various profiles and sizes

Part no.	Adaptor	Part no.	100-200 mm Hex bits	Part no.	30 mm bits	Part no.	75 mm bits
BE504901	Socket 1/2-1/2"	BE5049T30HXL	Bits TORX® TR30 200 mm	BE5049H4	HEX 04 – 30 mm	BE5049H4L	HEX 04 – 75 mm
BE504902	Socket 1/2-3/8"	BE5049T40HXL	Bits TORX® TR40 200 mm	BE5049H5	HEX 05 – 30 mm	BE5049H5L	HEX 05 – 75 mm
		BE5049T45HXL	Bits TORX® TR45 200 mm	BE5049H6	HEX 06 – 30 mm	BE5049H6L	HEX 06 – 75 mm
		BE5049T70HL	Bits TORX® TR70 100 mm	BE5049H7	HEX 07 – 30 mm	BE5049H7L	HEX 07 – 75 mm
		BE5049T80HL	Bits TORX® TR80 100 mm	BE5049H8	HEX 08 – 30 mm	BE5049H8L	HEX 08 – 75 mm
				BE5049H10	HEX 10 – 30 mm	BE5049H10L	HEX 10 – 75 mm
				BE5049H12	HEX 12 – 30 mm	BE5049H12L	HEX 12 – 75 mm
				BE5049M5	XZN M5 – 30 mm	BE5049M5L	XZN M5 – 75 mm
				BE5049M6	XZN M6 – 30 mm	BE5049M6L	XZN M6 – 75 mm
				BE5049M8	XZN M8 – 30 mm	BE5049M8L	XZN M8 – 75 mm
				BE5049M10	XZN M10 – 30 mm	BE5049M10L	XZN M10 – 75 mm
				BE5049M12	XZN M12 – 30 mm	BE5049M12L	XZN M12 – 75 mm
				BE5049T20H	TORX® TR20-30 mm	BE5049T20HL	TORX® TR20 – 75 mm
				BE5049T25H	TORX® TR25 30 mm	BE5049T25HL	TORX® TR25 – 75 mm
				BE5049T27H	TORX® TR27-30 mm	BE5049T27HL	TORX® TR27 – 75 mm
				BE5049T30H	TORX® TR30-30 mm	BE5049T30HL	TORX® TR30 – 75 mm
				BE5049T40H	TORX® TR40-30 mm	BE5049T40HL	TORX® TR40 – 75 mm
				BE5049T45H	TORX® TR45-30 mm	BE5049T45HL	TORX® TR45 – 75 mm
				BE5049T50H	TORX® TR50-30 mm	BE5049T50HL	TORX® TR50 – 75 mm
				BE5049T55H	TORX® TR55-30 mm	BE5049T55HL	TORX® TR55 – 75 mm
				BE5049T60H	TORX® TR60-30 mm	BE5049T60HL	TORX® TR60 – 75 mm

	 731415		 mm	 kg
BE5049	0169931	1	60x325x195	3.66



BE5049H

HEXAGONAL BITS 10 MM



- Drive: 10 mm
- Finish: Steel-grey, greased
- Material: High performance alloy steel

	 731415		 mm	 mm	 g
BE5049H4	0184590	5	4	30	5
BE5049H5	0184613	5	5	30	6.5
BE5049H6	0184637	5	6	30	7
BE5049H7	0184668	5	7	30	7
BE5049H8	0184682	5	8	30	7
BE5049H10	0184705	5	10	30	7
BE5049H12	0184729	5	12	30	12

BE5049H_L

HEXAGONAL BITS 10 MM



- Drive: 10 mm
- Finish: Steel-grey, greased
- Material: High performance alloy steel

	 731415		 mm	 mm	 g
BE5049H4L	0184606	5	4	75	20
BE5049H5L	0184620	5	5	75	20
BE5049H6L	0184651	5	6	75	20
BE5049H7L	0184675	5	7	75	20
BE5049H8L	0184699	5	8	75	20
BE5049H10L	0184712	5	10	75	20
BE5049H12L	0184736	5	12	75	20



BE5049T_H

TORX® TAMPER BITS 10 MM



- Drive: 10 mm
- Finish: Steel-grey, greased
- Material: High performance alloy steel

	 731415			 D mm	 L mm	 g
BE5049T20H	0184842	5	TR20	3.86	30	6.5
BE5049T25H	0184866	5	TR25	4.43	30	6.5
BE5049T27H	0184880	5	TR27	4.99	30	6.5
BE5049T30H	0184903	5	TR30	5.52	30	6.5
BE5049T40H	0184934	5	TR40	6.65	30	6.5
BE5049T45H	0184958	5	TR45	7.82	30	6.5
BE5049T50H	0184989	5	TR50	8.83	30	6.5
BE5049T55H	0185009	5	TR55	11.22	30	6.5
BE5049T60H	0185023	5	TR60	-	30	6.5

BE5049T_HL

TORX® TAMPER BITS 10 MM



- Drive: 10 mm
- Finish: Steel-grey, greased
- Material: High performance alloy steel

	 731415			 D mm	 L mm	 g
BE5049T20HL	0184859	5	TR20	3.86	75	20
BE5049T25HL	0184873	5	TR25	4.43	75	20
BE5049T27HL	0184897	5	TR27	4.99	75	20
BE5049T30HL	0184910	5	TR30	5.52	75	20
BE5049T40HL	0184941	5	TR40	6.65	75	20
BE5049T45HL	0184965	5	TR45	7.82	75	20
BE5049T50HL	0184996	5	TR50	8.83	75	20
BE5049T55HL	0185016	5	TR55	11.22	75	20
BE5049T60HL	0185030	5	TR60	-	75	20

BE5049M

XZN BITS 10 MM



- Drive: 10 mm
- Finish: Steel-grey, greased
- Material: High performance alloy steel

	 731415			 L mm	 g
BE5049M5	0184743	5	M5	30	6.5
BE5049M6	0184767	5	M6	30	7
BE5049M8	0184781	5	M8	30	7
BE5049M10	0184804	5	M10	30	8.5
BE5049M12	0184828	5	M12	30	10



BE5049M_L

XZN BITS 10 MM



- Drive: 10 mm
- Finish: Steel-grey, greased
- Material: High performance alloy steel

	 731415			 L mm	 g
BE5049M5L	0184750	5	M5	75	15
BE5049M6L	0184774	5	M6	75	15
BE5049M8L	0184798	5	M8	75	15
BE5049M10L	0184811	5	M10	75	15
BE5049M12L	0184835	5	M12	75	15

BE504901

ADAPTORS 10 MM

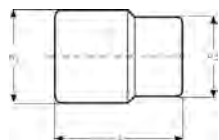
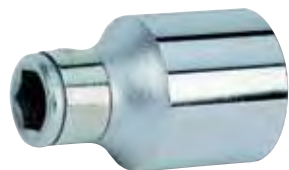

- 1/2" adaptor for 10 mm bits
- High performance alloy steel
- High polished finish
- ISO 1174
- DIN 3121, UNE 16503

	 731415		 mm	L mm	D1 mm	D2 mm	 g
BE504901	0184576	1	10	36	17	22	55

BE504902

ADAPTORS 10 MM

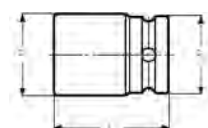

- 3/8" adaptor for 10 mm bits
- Finish: High polished finish
- Material: High performance alloy steel
- ISO 1174
- DIN 3121, UNE 16503

	 731415		 mm	L mm	D1 mm	D2 mm	 g
BE504902	0184583	1	10	35	15	10	32



BOD8902

DRAINING & REFILLING EQUIPMENT



- Air oil drainer
- Drain by both gravity and the suction mechanism
- Included probes:
 - Flexible nylon: 5 x 700 mm, 6 x 700 mm, 7 x 1000 mm, 8 x 700 mm
 - Rigid copper: 5 x 700 mm, 6 x 700 mm
 - Adaptors: BMW, VAG Group
- Reinforced connection between tank and oil tube to minimize the risk of leaks
- Swivel offset designed funnel ensures high flexibility and capacity
- Metal reinforced hoses
- Liquid level gauge
- Tank pressure gauge
- Useful plastic tray for screws, tools etc
- Foam protected handle
- One swivel wheel with brake for safety

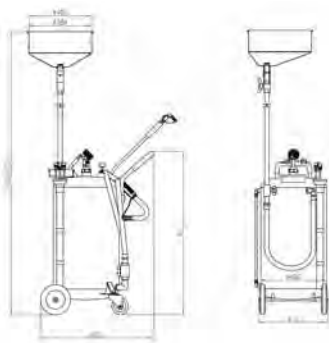

BOD8902	731415 0169023	1	90	480x440x1000 mm	35 kg

BOD8901

DRAINING & REFILLING EQUIPMENT



- Gravity oil drainer
- Drain waste oil from engines, gearboxes and differentials of all different types of vehicles by gravity
- Reinforced connection between tank and oil tube to minimize the risk of leaks
- Swivel offset designed funnel ensures high flexibility and capacity
- Metal reinforced hoses
- Liquid level gauge
- Useful plastic tray for screws, tools etc
- Foam protected handle
- One swivel wheel with brake for safety

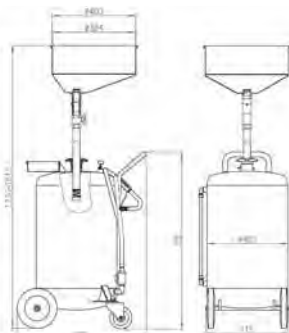

BOD8901	731415 0169016	1	90	480x440x1000 mm	35 kg



BOD8901AC1

DRAINING & REFILLING EQUIPMENT



- Extension funnel
- To be used with oil drainers: BOD8901, BOD8902 and BOD8903

BOD8901AC1	731415 0178490	1	mm 400/600	mm 150x620x620	kg 2.5

BOD1016

DRAINING & REFILLING EQUIPMENT



- Oil drain pan 16 l
- Withstands the most commonly used chemicals in a garage
- Several handles to aid manoeuvrability

BOD1016	731415 0169979	1	mm 570x150x445	kg 1.24

BOD2008

DRAINING & REFILLING EQUIPMENT



- Oil drain tank 8 l
- Withstands the most commonly used chemicals in a garage
- Several handles to aid manoeuvrability

BOD2008	731415 0169986	1	mm 330x595x120	kg 1.24

BOD301200

DRAINING & REFILLING EQUIPMENT



- Oil funnel 1.2 l
- Flow regulator
- Withstands the most commonly used chemicals in a garage

BOD301200	731415 0169993	1	mm 160x225x160	kg 1.24



BE6217

DRAINING & REFILLING EQUIPMENT



- Oil drain plug sockets set, 17 pcs
- Set of 17 assorted units 3/8" square drive bit sockets, supplied in a plastic box
- High performance alloy steel
- Chrome plated
- Includes XZN M16 tapered suitable for VAG gear boxes

	 731415		 60x260x120 mm	 kg
BE6217	0169702	1	60x260x120	1.07

BE630

FILTER TOOLS



- Universal oil filter cup set, 30 pcs
- Containing 28 oil filter cups, a 1/2" - 3/8" adaptor and a 3 flat legged oil filter wrench
- Covers the vast majority of the European vehicle fleet
- Application chart included

	 731415		 90x600x500 mm	 kg
BE630	0169580	1	90x600x500	7.15

BE6302/BE6303/BE6306

FILTER TOOLS



- Oil filter cups
- Additional loose cups to the extended BE630 set to cover the complete market demand
- Applications:
 - BE630246F Mercedes, Smart...
 - BE630276F Opel, Mercedes
 - BE630326F Mercedes, BMW, VAG, Mini
 - BE630366F Opel, Ford
 - BE630386F Opel
 - BE63066514F Peugeot, Mitsubishi

	 731415			 mm		 mm	 kg
BE630246F	0169597	1	6	24	Mercedes, Smart...	55x93x10	0.06
BE630276F	0169603	1	6	27	Opel, Mercedes	35x90x50	0.07
BE630326F	0169610	1	6	32	Mercedes, BMW, VAG, Mini	10x93x55	0.08
BE630366F	0169627	1	6	36	Opel, Ford	55x95x10	0.09
BE630386F	0169634	1	6	38	Opel	55x95x19	0.09
BE63066514F	0169641	1	14	66.5	Peugeot, Mitsubishi	80x83x10	0.14



BE65R

FILTER TOOLS



BE65R65120

BE65R80120



BE65R106160

- Magnetic 3 round legged oil filter wrenches
- Rifled legs for increased grip
- 1/2" to 3/8" adaptor included in BE65R65120/80120

	 731415			 mm	 mm	 mm	
BE65R65120	0170012	1	3/8-1/2"	55-72	21	57x85x85	0.73
BE65R80120	0170029	1	3/8-1/2"	68-110	21	71x86x86	0.73
BE65R106160	0170036	1	1/2"	110-142	-	130x180x125	1.84

BE65F65120

FILTER TOOLS



- 3 flat legged oil filter wrench
- Flat legs to ensure a stable grip of all different kind of oil filters
- 1/2" to 3/8" adaptor included

	 731415			 mm	 mm	
BE65F65120	0169658	1	3/8"	65-120	70x80x70	0.4

BE64520/BE64350

FILTER TOOLS



- Universal chain oil filter wrenches
- PVC handle for a more comfortable grip and insulation
- Articulated handle enables work in all directions and increases accessibility
- Spare chains
 - 350 mm: BE645350CH
 - 520 mm: BE64520CH

	 731415		 mm	 mm	 mm	
BE64350	0169672	1	350	60-105	25x300x80	760
BE64350CH	0169696	1	350	60-105	30x100x80	270
BE64520	0169665	1	520	60-160	75x320x100	890
BE64520CH	0169689	1	520	60-160	30x100x80	400







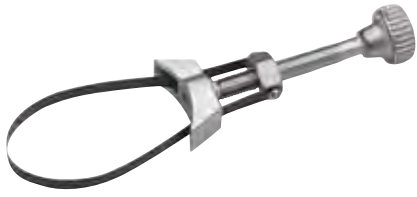

BE611

FILTER TOOLS



- Oil filter strap wrenches
- Spare straps available:
 - BE61110-1
 - BE61155-1

	 731415		 mm	 mm	 g
BE61110	0167449	1	65-110	60x248x74	490
BE61110-1	0167463	1	65-110	3x380x12	30
BE61155	0167456	1	100-155	60x355x90	520
BE61155-1	0167470	1	100-155	12x420x180	30

BRAKE SYSTEM TOOLS AND EQUIPMENT



BBR300P43

BRAKE PISTON TOOLS



- Universal brake caliper set, 43 pcs
- Tool for right and left threaded brake pistons
- 3/8" square drive
- Covers the majority of the European cars fleet
- Calipers can be used with caliper air pistol BBR320
- Application chart included



	 731415		 mm	 kg
BBR300P43	0169894	4	90x380x310	4.57



BBR320

BRAKE PISTON TOOLS



- Brake caliper wind back air tool
- Works in both directions: Left and right
- 3/8" square drive
- Includes a universal adaptor with magnet for keeping the calipers while approaching
- To be used with brake caliper set BBR300P43

	 731415		 3/8"	 1/4"	 44x260x150 mm	 1.2 kg
BBR320	0169887	1				

BBR110

BRAKE FLUID EQUIPMENT



- Brake fluid tester
- Indicates in a visual 10 led lamps scale, the humidity level by measuring conductivity
- CAN bus compatible
- Compatible with:
 - DOT 3
 - DOT 4
 - DOT 5
 - DOT 5.1

	 731415		 100x220x320 mm	 1.15 kg
BBR110	0170562	1		

BBR350

BRAKE FLUID EQUIPMENT



- Brake fluid bleeder
- Vacuum system
- 1.5 l polyurethane (PU) container
- 0.6 l polyurethane (PU) re-filler reservoir
- Quick release locking trigger
- Includes a universal rubber bleed nipple suitable for any brake system
- 2 m long bleeder hose
- Can be used for other purposes such as gear box, clutch, engine, etc draining and refilling

	 731415		 1/4"	 261x300x160 mm	 1.28 kg
BBR350	0169900	1			



BHVIS12 / BHVIS06

AUTO SPECIFIC SOCKETS

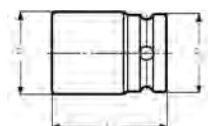

- Extra thin walls impact sockets
- Drive: 1" DIN 3121-H 25 ISO 1174
- Finish: Black
- Material: High performance alloy steel
- To be used with machines
- For maximum safety reasons, always use clamping springs (1" 19-70 mm ref. K560F-7, 1" 75-80 mm ref. K560F-8, 1" 95-120 mm ref. K560F-9)

	 731415		 mm	 mm	D1 mm	D2 mm	L mm	
BHVIS1265	0167685	1	12	65	87	54	92	2
BHVIS0670	0167692	1	6	70	96	54	96	2.2
BHVIS0677	0167708	1	6	77	105	60	102	2.3
BHVIS0680	0167715	1	6	80	108.5	60	102	2.5
BHVIS0685	0167722	1	6	85	115	86	106	2.6
BHVIS0690	0167739	1	6	90	121	86	108	3
BHVIS0695	0167746	1	6	95	127	86	110	4.5
BHVIS06100	0167753	1	6	100	134	95	115	5.3
BHVIS06105	0167760	1	6	105	140	95	117	6

BHVIS08

AUTO SPECIFIC SOCKETS

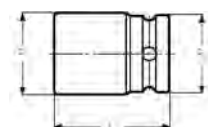

- 8 pts impact sockets 3/4"
- Special impact sockets for heavy vehicle wheels
 - Used in Scania trucks
 - Rear BHVIS08100
 - Front BHVIS0895
 - Used in Volvo trucks
 - BHVIS08115

	 731415		 mm	 mm	D1 mm	D2 mm	L mm	
BHVIS0895	0165704	1	8	95	118	55	81	4.5
BHVIS08100	0165711	1	8	100	123	60	84	5.25
BHVIS08115	0165728	1	8	115	138	55	81	4.65



BHVISxxBPW

AUTO SPECIFIC SOCKETS



BHVIS111BPW12

- Impact sockets BPW
- Special impact sockets for BPW axles
- Special shaped output with different sizes per axle capacity



BHVIS80BPW12

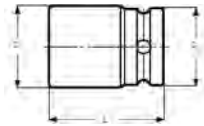

	 731415				D1 mm	D2 mm	L mm		
	0165759	1	1"	109	129	47	94	12	4.65
	0165735	1	1"	111	132	47	94	12	4.65
	0165742	1	1"	120	143	47	94	12	4.65
	0165766	1	3/4"	80	108	45	65	12	4.65

BWSS

AUTO SPECIFIC SOCKETS



BWSS12P3

- Wheel socket sets
- Plastic protection on socket walls to ensure protection of the rims
- Plastic protection inside the socket to ensure protection of wheel nuts



BWSS12P5

	 731415				
	0170128	1	17, 19, 21	45x150x130	0.8
	0170135	1	17, 19, 21, 22, 24	50x240x175	1.47



BWTSP

AUTO SPECIFIC SOCKETS



BWTSP16



BWTSP7

- Twist socket sets
- For unfastening damaged nuts and screws and especially for locking wheel nuts
- The special rounded profile of the inner side enables the socket to get a strong grip to unfasten any damaged bolt
- BWTSP16: 16 pcs
 - 3/8": 8, 10, 11, 12, 13, 14, 16, 17, 18, 19 mm
 - 1/2": 21, 22, 24, 27 mm
 - Adaptor: 1/2" female to 3/8" male
 - Puncher
- BWTSP7: 7 pcs
 - 1/2": 22, 24, 27, 32 mm
 - 3/4": 36, 41 mm
 - Puncher
- Not suitable for machine operation

	 731415		 mm	 kg
BWTSP16	0170296	1	50x245x120	1.75
BWTSP7	0170302	1	62x230x120	1

BZWTB

TORSION BARS

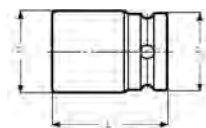

- Impact torsion bars, 1"
- For controlling the torque applied to wheels and other parts
- For quickly reaching the desired torque
- Always use a torque wrench after using a torsion bar

	 731415		 mm	 L mm	 D1 mm	 D2 mm	 MAX Nm		 g
BZWTB0132450	0165674	1	32	300	51.5	54	450	K560F-7	1540
BZWTB0132600	0165681	1	32	300	51.5	54	600	K560F-7	1576
BZWTB0133600	0165698	1	33	300	52.8	54	600	K560F-7	1607



BWTB

TORSION BARS



- Torsion bar set, 10 pcs
- For controlling the torque applied to wheels and other parts
- For quickly reaching the desired torque
- Always use a torque wrench after using a torsion bar
- 10 different bars ranging from 75 – 240 Nm

Colour	Torque Nm
Red	75
Yellow	90
Green	110
Pink	120
Light blue	135
Navy blue	150
White	160
Black	190
Gray	205
Orange	240

BWTB12P10	731415 0170142	1	1/2"	275x360x80 mm	3.5 kg

29-B/BWXW1/BWXW2

4-WAY WHEEL WRENCHES



- Heavy duty 4-way wheel wrench

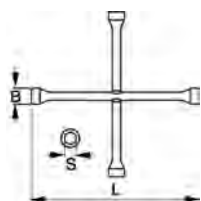

29-B	8277703 731415	1	S mm	B mm	L mm	1/2"	30x405x405 mm	1.32 kg
BWXW1	0167661	1	17,19,21	25, 27, 32	381	1/2"	30x380x380	1.27
BWXW2	0167678	1	17,19,22	26,29,33	375	1/2"	45x700x700	4.63



BWB14

WHEEL BEARING TOOLS



- Universal wheel bearing tool set, 14 pcs
- Set including:
 - 9 adaptors Ø 55.5 to 84 mm
 - 1 cage – lining 76 mm
 - 2 cages, 86 and 91 mm
 - 1 puller, 38 mm
 - 1 centre axis, screw, pin

	 731415		 mm	 kg
BWB14	0170166	1	85x525x310	7.82

BS50

AXLE JOINT TOOLS



- Axle joint tool
- Install and remove steering knuckles ranging from Ø 35 to 45 mm
- The rotation of the tool causes the self-locking of the runners between the body and the knuckle to tighten or untighten

	 731415		 mm	 kg
BS50	0178858	1	80x460x80	2.02

BWP150

MISCELLANEOUS



- Wheel balancing pliers
- For easy fitting and removing of wheel weights
- Soft grip and insulation sleeves

	 731415		 mm	 kg
BWP150	0170159	1	65x270x80	0.41



TRANSMISSION AND WHEEL TOOLS

38-8 - 38-24

TYRE LEVERS



- Tyre lever
- Finish: Nickel and chrome plated
- Material: High performance alloy steel

	 731415		 mm	 g
38-8	1831257	5	200	90
38-12	1831264	5	300	240
38-16	1831271	5	400	375
38-20	1831288	2	500	610
38-24	1831295	1	600	850

39-24

TYRE LEVERS



- Special bent form for lorries and trucks
- Finish: Lacquered
- Material: High performance alloy steel

	 731415		 mm	 g
39-24	1831301	1	600	1360



SUSPENSION TOOLS AND EQUIPMENT

BS10/BS10AC1

STRUT SPRING COMPRESSORS



BS10

BS10AC1

- Universal air spring compressor
- Security cage for increased safety
- Independent jaw settings
 - Maximum jaw separation 380 mm
- Quick and safe to use
- Working pressure: 5-10 bar
- Working capacity: 500 kg up to 2.000 kg
 - 670 kg capacity at 6 bar
- Optional moving stand BS10AC1
- Optional plate/adaptor for sport car shock absorbers with regulation ring BS10AC2

	 731415		 mm	 kg
BS10	0178827	1	1150x470x450	50
BS10AC1	0178841	1	370x600x520	7.6







BS10MEC



STRUT SPRING COMPRESSORS

- Universal mechanical spring compressor
- Security cage for increased safety
- Independent jaw settings
 - Maximum jaw separation 380 mm
- Quick and safe to use
 - Not to be used with air impact wrench
 - Use a 1/2" square drive hand ratchet
- Optional moving stand BS10AC1
- Optional plate/adaptor for sport car shock absorbers with regulation ring BS10AC2

	 731415		 mm	 kg
BS10MEC	0178834	1	80x370x255	65.5

BS10AC2



STRUT SPRING COMPRESSORS

- Plate/adaptor for sport car shock absorbers with regulation ring BS10AC2
- Universal adaptor to be used with BS10 and BS10MEC





	 731415		 mm	 kg
BS10AC2	0182343	1	200x400x400	1

BS1000



MISCELLANEOUS

- Universal turnbuckle shock absorber servicing set, 39 pcs
- Suitable for MacPherson shock absorbers
- Covers the majority of the European cars fleet

	 731415		 mm	 kg
BS1000	0170081	1	80x580x400	6.36



BB12-760

BATTERY BOOSTERS



- Booster 12 V 760 CA
- To start diesel engines up to 250 HP as start assistance and 125 HP without battery
- Instant response: 760 CA
- Peak current: 2250 A
- 25 mm² copper area in cables ensures high conductivity
- Internal fuse 300 A
- Electronic fuse check system
- Automatic electronic charger with 3 colour LED indicator
 - 4 A
 - 4 h charging time
- 12 V output with 16 A internal fuse to run smaller devices

BB12-760	0169269	1	12	760	2250 A	12 V	4	22 Ah	25 mm ²	1.85 m

BB12-760	-25<°C<70	4 A	200 mm	97 mm	300 A	x	x	445x144x377	23

BB12-1200

BATTERY BOOSTERS



- Booster 12 V 1200 CA
- To start diesel engines up to 350 HP as start assistance and 175 HP without battery
- Instant response: 1200 CA
- Peak current: 3100 A
- 35 mm² copper area in cables ensures high conductivity
- Internal fuse 500 A
- Electronic fuse check system
- Automatic electronic charger with 3 colour LED indicator
 - 4 A
 - 5 h charging time
- 12 V output with 16 A internal fuse to run smaller devices

BB12-1200	0169276	1	12	1200	3100 A	12V	5	28	35 mm ²	1.85 m

BB12-1200	-25<°C<70	4	200	97 mm	500 A	x	x	445x144x377	23



BB1224-760

BATTERY BOOSTERS



- Booster 12/24 V, 1520/760 CA
- To start diesel engines up to 500 HP as start assistance and 250 HP without battery at 24V
- Instant response: at 12 V 1520 CA at 24 V 760 CA
- Peak current: at 12 V 4500 A at 24 V 2250 A
- 35 mm² copper area in cables ensures high conductivity
- Internal fuse 500 A
- Electronic fuse check system
- Automatic electronic charger with 3 colour LED indicator
 - 4 A
 - 7 h charging time
- 12 V output with 16 A internal fuse to run smaller devices

	 731415		V	CA	PA					
BB1224-760	0169283	1	12/24	1520/760	4500/2250 A	12 V	7	22 Ah	35 mm ²	1.85 m

BB1224-760	-25<°C<70	4 A	200 mm	97 mm	500 A	x	x	445x208x447	23

BB1224-1200

BATTERY BOOSTERS



- Booster 12/24 V, 2400/1200 CA
- To start diesel engines up to 480 HP without battery at 12V and up to impressive 1500 HP diesel engines without battery at 24V
- Instant response: At 12 V 2400 CA at 24 V 1200 CA
- Peak current: At 12 V 6200 A at 24 V 3100 A
- Quick voltage selector
- 50 mm² copper area in cables ensures high conductivity
- Internal fuse 500 A
- Electronic fuse check system
- Automatic electronic charger with 3 colour LED indicator
 - 4 A
 - 10 h charging time
- 12 V output with 16 A internal fuse to run smaller devices

	 731415		V	CA	PA					
BB1224-1200	0169290	1	12/24	2400/1200	6200/3100 A	12 V	10	28 Ah	50 mm ²	1.85 m

BB1224-1200	-25<°C<70	4	200 mm	97 mm	500 A	x	x	445x208x447	24



BB24-1200

BATTERY BOOSTERS



- Booster 24V, 1200 CA
- To start diesel engines up to impressive 1500 HP diesel engines without battery at 24V
- Instant response: 1200 CA
- Peak current: 3100 A
- 35 mm² copper area in cables ensures high conductivity
- Internal fuse 500 A
- Electronic fuse check system
- Automatic electronic charger with 3 colour LED indicator
 - 2 A
 - 14 h charging time
- 12 V output with 16 A internal fuse to run smaller device

	 731415		V	CA	PA					
BB24-1200	0169306	1	24	1200	3100 A	12 V	14	28 Ah	35 mm ²	1.85 m

BB24-1200	-25<C<70	2 A	200 mm	97 mm	500 A	x	x	445x208x447	24

BBBC

BATTERY BOOSTERS



- Booster automatic electronic chargers
- BBBC2A : 2 Ah to be used with BB24-1200
- BBBC4A: 4 Ah to be used with BB12-760, BB12-1200, BB1224-760 and BB1224-1200

	 731415			
BBBC2A	0181520	1	215x130x60	0.63
BBBC4A	0181537	1	215x130x60	0.63

BBBCAB

BATTERY BOOSTERS



- Booster charger cables spares
- For Australia, continental Europe and UK

	 731415			
BBBCAB-AUZ	0183944	1	50x125x50	0.13
BBBCAB-EU	0186648	1	50x125x50	0.13
BBBCAB-UK	0183937	1	50x125x50	0.13



BBT30

BATTERY TESTERS



- 6 & 12 V digital battery tester
- LED display
- Indicates battery status in 5 different categories:
 - GOOD & PASS
 - GOOD & RECHARGE
 - RECHARGE & RETEST
 - BAD & REPLACE
 - BAD CELL & REPLACED ERROR
- Capacity:
 - 6 and 12 V batteries
 - 12 and 24 V alternator and charging systems
 - Traditional liquid and VRLA (AGM and GEL) batteries
 - Working range 25-2000 CC
 - Comply with battery rating system SAE-DIN-EN, IEC and JIS
- Menu in English, German, French, Dutch, Spanish and Swedish



BBT30



731415

0164981



12



80x370x255



1.92

BBT40

BATTERY TESTERS



- 6 & 12 V digital battery tester with printer
- LED display built in printer with automatic date and time
- Indicates battery status in 6 different categories:
 - GOOD & PASS
 - GOOD & RECHARGE
 - RECHARGE & RETEST
 - BAD & REPLACE
 - BAD CELL & REPLACE
 - LOAD ERROR
- Capacity:
 - 6 and 12 V batteries
 - 12 and 24 V alternator and charging systems
 - Traditional liquid and VRLA (AGM and GEL) batteries
 - Working range 25 - 2000 CCA
 - Comply with battery rating system SAE-DIN-EN, IEC and JIS
- Menu in English, German, French, Dutch, Spanish and Swedish



BBT40



731415

0164974



6



80x370x255



1.92



BELS12



SOCKET/PLUG TESTERS

- Memory saver 12 V
- Saves the memory during battery change or any other kind of repair that could affect the memory
- User friendly and very quick
- Cigarette plug and external battery indicator assures that connections are correct and that operations are carried out safely

BELS12	731415 0170579	1	60x650x160 mm	0.29 kg

BELT247N



SOCKET/PLUG TESTERS

- Socket/plug tester 24V - 7 pin
- User friendly and very quick
- 4 m long cable allows one person to do the test
- Applicable for 24N sockets
- CAN bus compatible

BELT247N	731415 0170586	1	105x260x210 mm	1.44 kg

BELT247S



SOCKET/PLUG TESTERS

- Socket/plug tester 24V - 7 pin
- User friendly and very quick
- 4 m long cable allows one person to do the test
- Applicable for 24S sockets
- CAN bus compatible

BELT247S	731415 0170593	1	105x260x210 mm	1.44 kg



BELT2415

SOCKET/PLUG TESTERS



- Socket/plug tester 24V - 15 pin
- User friendly and very quick
- 4 m long cable allows one person to do the test
- CAN bus compatible

BELT2415	731415 0170609	1	105x260x210 mm	1.44 kg

BELT1213

SOCKET/PLUG TESTERS



- Socket/plug tester with simulator 12V - 13 pin
- User friendly and very quick
- Simulation mode for easy detection of damaged components
- 4 m long cable allows one person to do the test
- CAN bus compatible

BELT1213	731415 0170616	1	60x650x160 mm	0.71 kg

BELT127

SOCKET/PLUG TESTERS



- Socket/plug tester 12V - 7 pin
- User friendly and very quick
- 4 m long cable allows one person to do the test
- CAN bus compatible

BELT127	731415 0177899	1	60x650x160 mm	0.38 kg



BELT10



MISCELLANEOUS

- Lambda sensor tester
- Measures the functionality of the lambda sensor, allowing to test Zirconia lambda probes (0-1 V) and Titania (0-5 V)
- Simulates the lambda probe signal to verify the functionality of the ECU
- Fully protected against polarity inversion
- CAN bus compatible



BELT10



0170623



1



60x650x160



0.71

BELTKEY



MISCELLANEOUS

- Infrared (IR) & radio frequency (RF) remote key tester
- Works with 433 MHz and 868 MHz
- User friendly, by pushing the button the device will show if the key works properly or not



BELTKEY



0177875



1



280x170x50



0.71

BELP1224



MISCELLANEOUS

- 12 V & 24 V peak protector
- Protects the vehicle from any electric peak generated in the car while welding, battery charging, etc
- User friendly, works connected to any polarity of the battery



BELP1224



0177882



1



60x650x160



0.215



BELTRP16

MISCELLANEOUS



- Universal terminal tool set, 16 pcs
- The set covers the majority of the European cars fleet

BELTRP16	731415 0169917	1	265x60x215 mm	0.9 kg

GARAGE EQUIPMENT



BLE200

LIGHT GARAGE EQUIPMENT



- Air vacuum cleaner
- Suitable for liquids and dust
- 2 engines
- Absorbing capacity: 5.6 m³/min
- 2 300 W
- Includes FRL
- 80 l tank
- 2 x 4.2 m hoses included
- Sanders are not included

BLE200	731415 0169573	1	230-240 V	1/2" inch	865x610x960 mm	75 kg



BLBT100

LIGHT GARAGE EQUIPMENT



- Dual laser head light tester
- Laser alignment visor & pointer
- Standard and XENON headlights
- Digital luxometer
- Anti tilting robust base with 4 wheels for easy manoeuvring
- Height setting easy mechanism with block
- Working range:
 - Min. height: 240 mm
 - Max height : 1 400 mm
- Swivel bar allows 360° rotation of the body of the headlight over the axis of the bar which makes very appropriate for mounting over rail tracks
- Optional rail track BLBT100AC1
- CE and NFR63-801 approved

	 731415			
BLBT100	0179015	1	330x1700x630	40.5

1419-MD

LIGHT GARAGE EQUIPMENT



- Magnetic dish 150 mm
- For easy storage of bolts, nuts and tools whilst working
- Magnetic rubber protected base will attach to any magnetic surface

	 731415				
1419-MD	8277352	36	150	150	300

2535F

LIGHT GARAGE EQUIPMENT



- Handle developed according to the scientific ERGO™ process
- Handle: 3-component handle, for maximum comfort and force transmission
- Blade finish: Chrome plated and polished
- 2535F1: Neodym magnet Ø 10 mm, capacity 1 kg/35 oz
- 2535F3: Neodym magnet Ø 17 mm, capacity 3 kg/106 oz

	 731415						
2535F1	1064495	1	10	413	36x122	535	150
2535F3	0180233	1	17	413	36x122	535	170



BOD70

GREASE/LUBRICATION TOOLS & EQUIPMENT



- Rotary barrel pump
- For transfer of diesel and non corrosive petroleum based fluids of low to medium viscosity with stable flow
- For 50 to 205 l barrels with 1" thread
- Reversible
- Capacity: 250 ml/turn





	 731415		 mm	 kg
BOD70	0169498	4	1330x250x230	6.740

BOD60

GREASE/LUBRICATION TOOLS & EQUIPMENT



- Level barrel pump
- For light and heavy oils and other non corrosive fluids
- For 50 to 205 l barrels with 1/2" and 2" threads
- Capacity: 300 ml/stroke





	 731415		 mm	 kg
BOD60	0169481	1	55x165x650	2.24

BOD5HD400

GREASE/LUBRICATION TOOLS & EQUIPMENT



- Heavy duty universal grease pump
- Supplied with
 - Fixed metal extension of 150 mm
 - Flexible extension of 300 mm
 - Coupler of 4 jaws and 38 mm
- Capacity: 400 g cartridges
- Suitable for manual, cartridge and bulk fitting loading
- Pressure: 690 bar

	 731415		 mm	 kg
BOD5HD400	0169467	1	66x390x100	1.594



BOD5400/BOD5450

GREASE/LUBRICATION TOOLS & EQUIPMENT



BOD5400



BOD5450

- Universal grease pumps
- Supplied with
 - Fixed metal extension of 150 mm
 - Flexible extension of 300 mm
 - Coupler of 4 jaws and 38 mm
- Capacity:
 - BOD5400: 400 g cartridges
 - BOD5450: 450 g cartridges
- Suitable for manual, cartridge and bulk fitting loading
- Pressure: 413 bar

	 731415		 mm	 kg
BOD5400	0169450	1	57x385x120	1.415
BOD5450	0169474	1	61x425x135	1.415

BOD4200/BOD4500

GREASE/LUBRICATION TOOLS & EQUIPMENT



- Oil cans
- Brass pump
- Two steel valves
- Flexible and rigid spout included

	 731415			 mm	 kg
BOD4200	0169436	1	0.2	63x127x111	0.23
BOD4500	0169443	1	0.5	90x200x130	0.27



BBS150

WINDSCREEN TOOLS



- Double suction cups and belt set
- Cups:
 - 2 double suction cups of 120 mm diameter each
 - Total length 385 mm
 - Capacity: 150 kg
- 1 belt of 5 m x 25 mm



BBS150	731415 0169849	1	120 mm	400 mm	120x435x170 mm	1.845 kg

BBS160

WINDSCREEN TOOLS



- Universal windscreen wiper puller
- Extra thin grip forks
- Working dimension: 18 mm

BBS160	731415 0182305	1	30x65x30 mm	0.14 kg

BBS50

MISCELLANEOUS



- Car panel protector
- With magnets and suction cups ideal to use on aluminium as well as steel

BBS50	731415 0169863	1	900x580 mm	0.62 kg

BBS20P12

MISCELLANEOUS



- Universal trim removal set, 12 pcs
- Material: Nylon & fibreglass which makes them flexible but strong
- Multiple profiles for work on form and surface or shape

BBS20P12	731415 0169856	1	18x290x165 mm	0.150 kg



BBS100

MISCELLANEOUS



- Universal air bag removal tool set, 12 pcs
- The profile of the tools make easy and safe removal of airbags
- Suitable for the majority of the European cars fleet

	 731415		 mm	 kg
BBS100	0169870	1	44x260x150	1.240

2220

MISCELLANEOUS



- Body work scrapers set, 4 pcs
- Dimensions:
 - 90 x 50 mm
 - 120 x 80 mm
 - 120 x 105 mm
 - 120 x 120 mm

	 841334		 g
22209004B	5401333	1	125



16A

DC VOLTS

HYDRAULIC & LIFTING EQUIPMENT

Bahco has a wide range of lifting and hydraulic equipment for all types of vehicles, engines and heavy parts. The range includes a foldable crane with numerous accessories, transmission jacks for the easy handling of engine and transmission boxes, and other important equipment such as hydraulic wheel-dolly and ram sets. There are also trolley jacks and air hydraulic jacks for quick lifting, and jack stands for holding cars and heavy vehicles once elevated.



Chapter Index

CRANES & ACCESSORIES	714
JACKS & ACCESSORIES	715-723

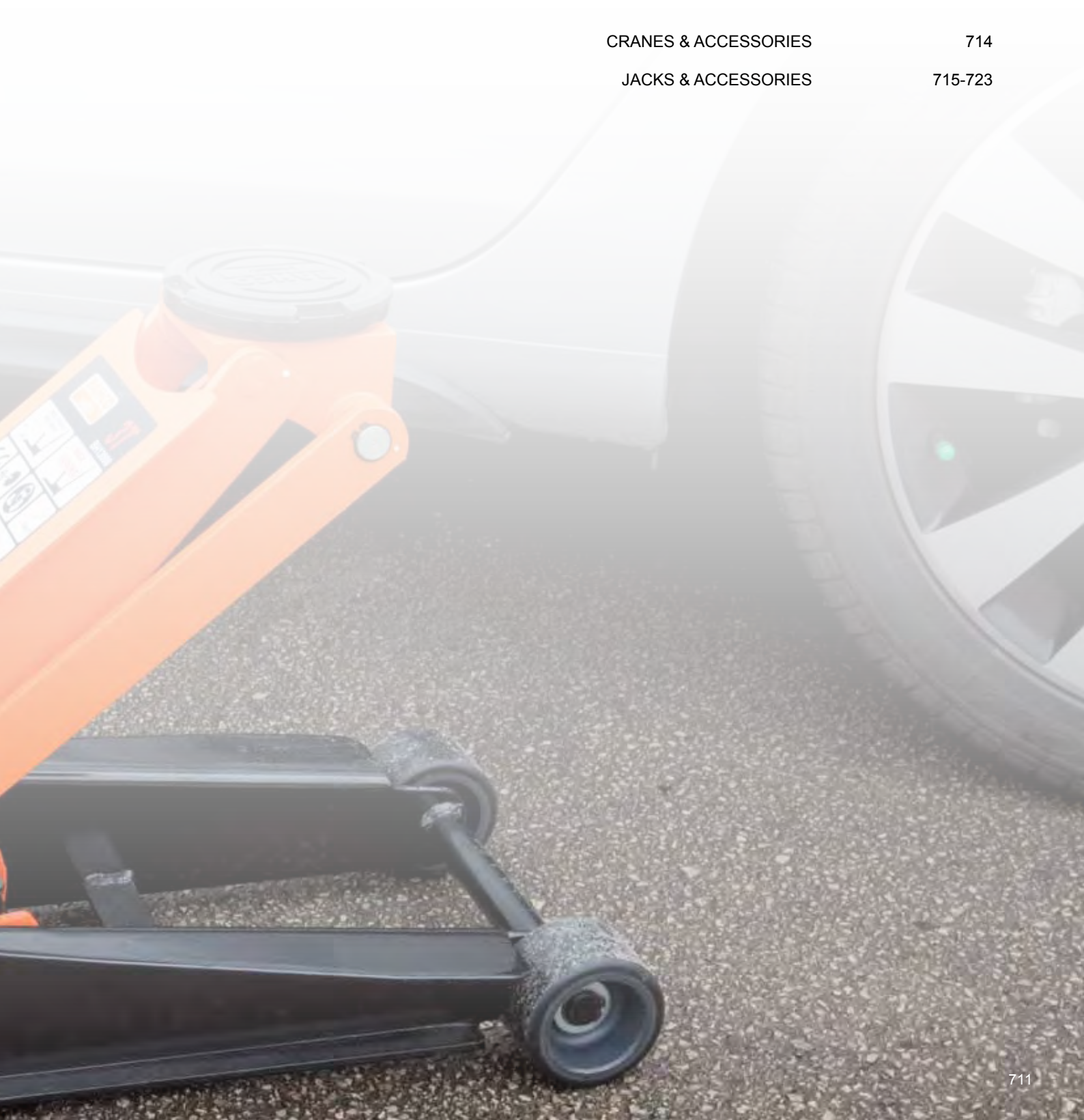

ICON INDEX



Capacity
kg



Capacity
ton



Minimum
Entry Level
mm



Maximum
Height
mm



Minimum
Height
mm

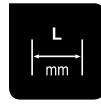

Length
mm

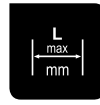

Maximum
Length
mm



CE
Certified



TUV
Certified

TROLLEY JACKS



AIR JACKS



AIR JACKS

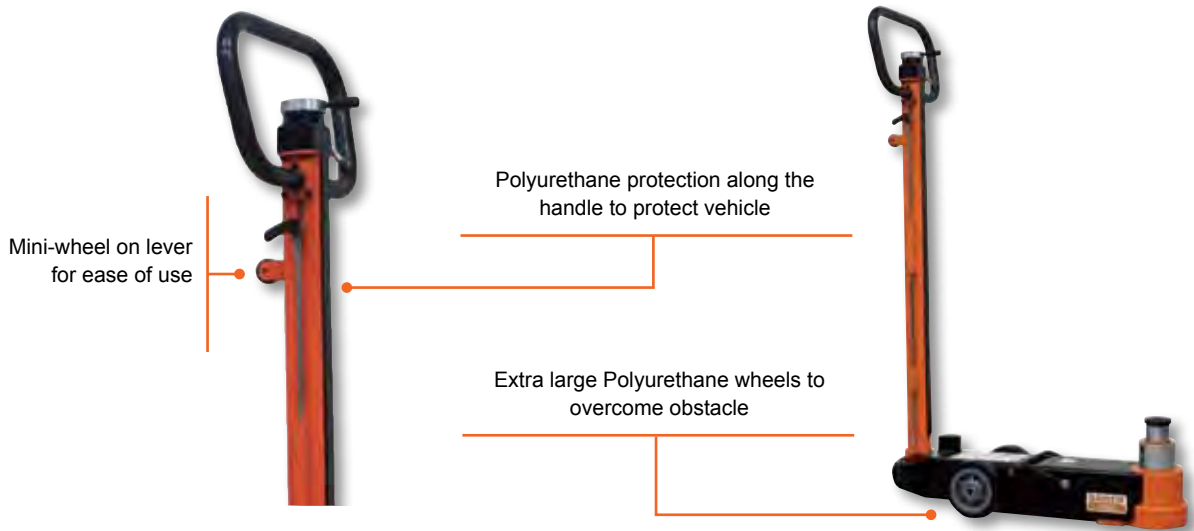

JACK STANDS



CRANE

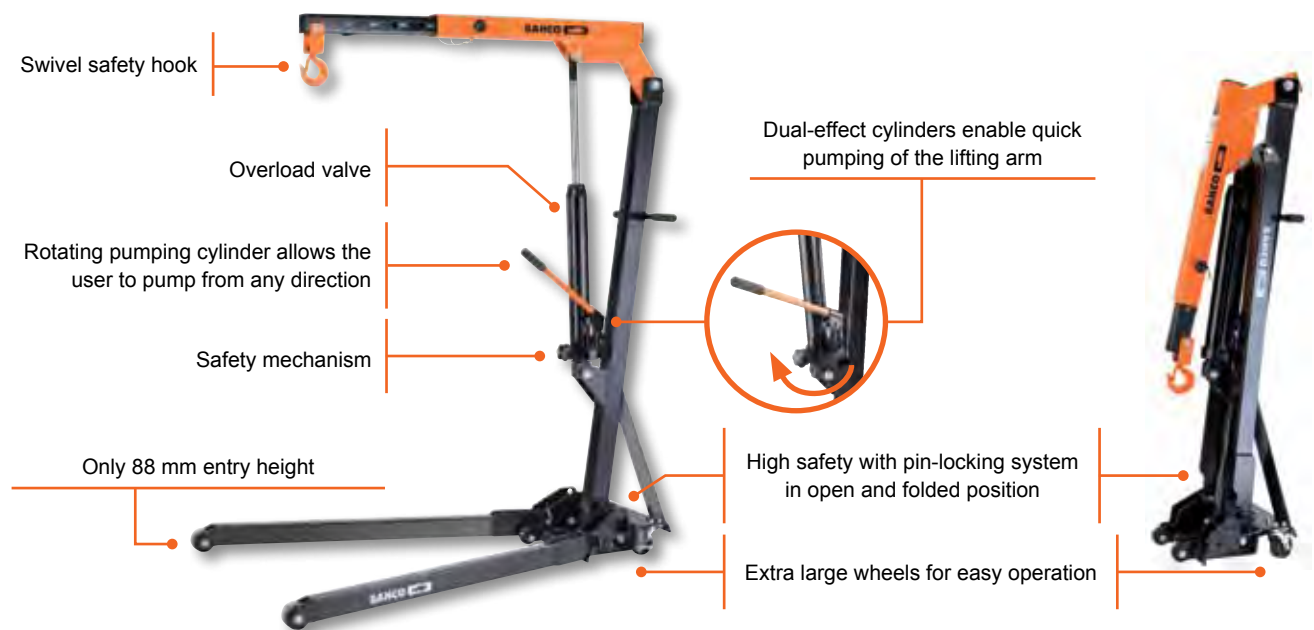



BH6FC1000

CRANES



- 1 T foldable crane
- Foldable body and 4 fixed positions of the lifting arm: 1000, 750, 500 and 250 kg
- Dual effect cylinder which decreases the number of pump strokes by 50%
- Min entry height: 88 mm
- Max hook height: 2000 mm
- Swivelling lever for easy and comfortable pumping from all positions
- "Dead man" safety mechanism
- Overload valve
- Swivel safety hook



BH6FC1000	0178650	1	1000	750	500	250	88 mm	± 39	410x1.670x500	75

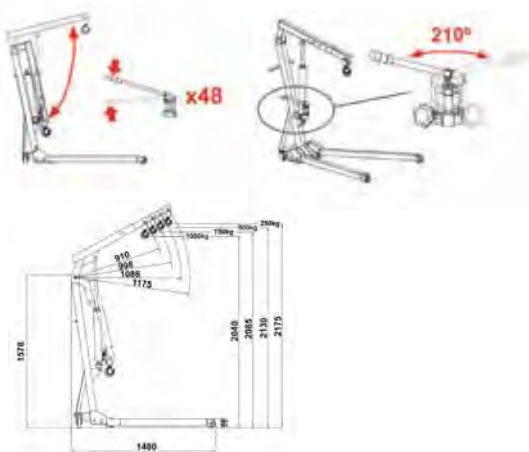

BH6AC1-680

CRANES' ACCESSORIES



- Adjustable engine sling
- Capacity: 680 kg
- Extra long
- Rapid angle adjustment
- Heavy duty welded sling chain & solid mounting plates
- Suitable accessory for BH6FC1000

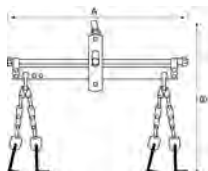

			A	B		
BH6AC1-680	0178667	1	640	543	70x680x220	6.7



BH4

BOTTLE JACKS



- Bottle jacks
- Welded housing
- Working conditions: -20 to 70°C

	731415		kg	mm	mm	mm	kg
BH42	0178698	1	2000	172	372	185x130x110	3.95
BH45	0178704	1	5000	212	468	225x135x120	5.05
BH410	0178711	1	10000	220	483	230x150x145	7.56
BH415	0178728	1	15000	231	498	240x165x150	10.12
BH420	0178735	1	20000	241	521	250x180x170	13.32
BH430	0178780	1	30000	244	492	270x195x185	16.11

BH5SP300/BH5SP500

TRANSMISSION JACKS



- Transmission jacks
- Single piston
- "Dead man" safety mechanism

	731415		kg	mm	mm	mm	kg
BH5SP300	0170425	1	300	1160	1960	270x1080x255	31
BH5SP500	0170432	1	500	1160	1960	280x1080x255	37

BH5US500

SADDLES



- Universal swivel saddle
- Capacity: 500 kg
- Heavy duty welded sling chains & solid mounting plates
- Suitable accessory for BH5SP300/BH5SP500

	731415		mm	mm	mm	kg
BH5US500	0170449	1	305-365 mm	480-585 mm	240x960x340	14



BH11500

TROLLEY JACKS



- 1.5 T low entrance trolley jack
- Extra large rounded foot pedal for ease of use in any position
- Dual pistons which decreases the number of pump strokes by 50%
- Piston dust cover
- Polyurethane steel covered wheels
- Rubber saddle
- Storage tray
- Safety pressure valve
- Safety lowering valve



	 731415		 t	 MIN mm	 MAX mm	 mm	 mm	 Ø mm	 X	 mm	 kg
BH11500	0178797	1	1.5	70	610	945	± 10	119	X	190x940x415	51

BH12000

TROLLEY JACKS



- 2 T low entrance trolley jack
- Extra large rounded foot pedal for ease of use in any position
- Dual pistons which decreases the number of pump strokes by 50%
- Piston dust cover
- Polyurethane steel covered wheels
- Rubber saddle
- Storage tray
- Safety pressure valve
- Safety lowering valve



	 731415		 t	 MIN mm	 MAX mm	 mm	 mm	 Ø mm	 X	 mm	 kg
BH12000	0178803	1	2	70	490	790	± 10	119	X	180x790x400	44.6



BH1A2500

TROLLEY JACKS



- 2.5 T aluminium trolley jack
- 100 % aluminium body and lifting arm
- Storage tray
- Detachable handle
- Safety pressure valve
- Safety lowering valve

BH1A2500	0170555	1	2.5	95	485	740	6	120	X	800x370x200	25

BH13000

TROLLEY JACKS



- 3 T compact trolley jack
- Extra large rounded foot pedal for ease of use in any position
- Dual pistons which decreases the number of pump strokes by 50%
- Piston dust cover
- Polyurethane steel covered wheels
- Rubber saddle
- Storage tray
- Safety pressure valve
- Safety lowering valve

BH13000	0178810	1	3	90	552	820	± 10	119	x	200x710x390	50.5



JACKS & ACCESSORIES

BH15000

TROLLEY JACKS

- 5 T extra long trolley jack
- 3 fixed lever positions
- Safety pressure valve
- Safety lowering valve



BH15000	0170531	1	5	150	680	1505	50	130	X	330x1530x410	115

BH110000

TROLLEY JACKS

- 10 T extra long trolley jack
- 3 fixed lever positions
- Safety pressure valve
- Safety lowering valve



BH110000	0170548	1	10	160	685	1637	105	150	X	355x1660x510	170



BH23015C

AIR HYDRAULIC JACKS



- 30/15 T air hydraulic compact jack
- Detachable handle
- Extra large polyurethane wheels
- Two saddle adaptors included
 - 45 mm
 - 75 mm
- Product weight: 33 kg
- Safety pressure valve

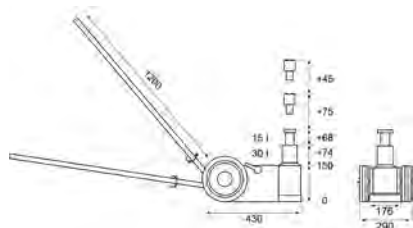

BH23015C	0178742	1	30	150	292	224 mm/30 T	292 mm/15 T	-	280x700x360	35

BH23015

AIR HYDRAULIC JACKS



- 30/15 T air hydraulic jack
- Extra large polyurethane wheels
- Two saddle adaptors included
 - 45 mm
 - 75 mm
- Product weight: 46 kg
- Safety pressure valve

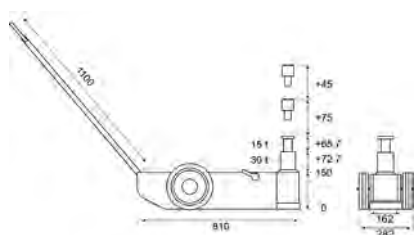

BH23015	0178759	1	30	150	289	223 mm/30 T	289 mm/15 T	-	280x700x360	75



BH2402010

AIR HYDRAULIC JACKS



- 40/20/10 T air hydraulic jack
- Extra large polyurethane wheels
- Two saddle adaptors included
 - 45 mm
 - 75 mm
- Product weight: 44 kg
- Safety pressure valve

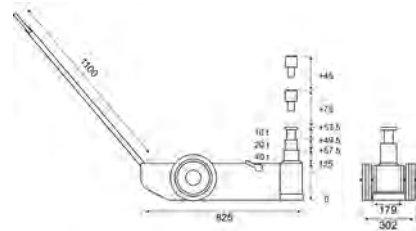

BH2402010 0178766 1 40 125 399 183 mm/40 T 233 mm/20 T 287 mm/10 T 300x1350x290 52

BH2604020

AIR HYDRAULIC JACKS



- 60/40/20 T air hydraulic compact jack
- Extra large polyurethane wheels
- Two saddle adaptors included
 - 45 mm
 - 75 mm
- Product weight: 69 kg
- Safety pressure valve

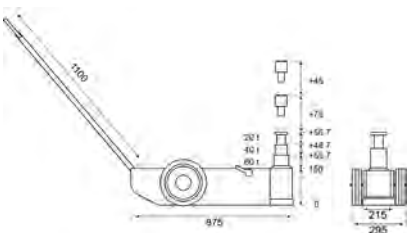

BH2604020 0178773 1 60 150 312 206 mm/60 T 255 mm/40 T 312 mm/20 T 300x1350x290 76



BH2AC60

AIR HYDRAULIC JACKS



- Universal saddles
- Heavy duty
- Machined



BH2AC60-140

BH2AC60V110

	 731415					
BH2AC60V110	0178933	1	X		100x150x150	1
BH2AC60-140	0168958	1		X	100x150x150	1

BH33000/BH36000

JACK STANDS



- Jack stand pair
- Click positioning system
- Safety pin
- Extra large feet

	 731415						
BH33000	0178674	1	3000	288	425	360x225x205	7
BH36000	0178681	1	6000	395	605	460x310x265	13.2

BH3HD

JACK STANDS



BH3HD8000

- Jack stands
- Safety pin (BH3HD1200 is equipped with a knob bearing system)



BH3HD12000

BH3HD16000

BH3HD20000

	 731415						
BH3HD8000	0170494	2	8000	385	600	435x442x44	9.4
BH3HD12000	0170500	2	12000	345	515	305x370x340	12.38
BH3HD16000	0170524	2	16000	480	720	440x500x450	18.85
BH3HD20000	0170517	1	20000	745	1200	470x800x470	35.5



JACKS & ACCESSORIES

BH8AC1-500

MISCELLANEOUS

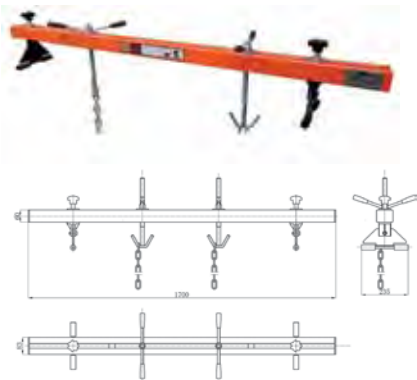

- Engine support bar
- Capacity: 500 kg
- Features 2 adjustable heavy duty hooks
- Tilting mechanism
- Suitable accessory for BH6FC1000

BH8AC1-500	731415 0170463	1	1700	70x680x220	6.7

BH8AC2-450

MISCELLANEOUS



- Geared engine stand
- Capacity: 450 kg
- Features a unique 63: 1 gear ratio
- Foldable
- Adjustable engine locking pins
- Swivel wheels with brakes

				A	B	C	D		
BH8AC2-450	731415 0170470	1	450	mm 926	mm 910	mm 945	mm 510	mm 240x960x340	kg 41.5

BH8AC3-500

MISCELLANEOUS



- Hydraulic wheel dolly
- Capacity:
 - 500 kg
 - Entry height: 80 – 615 mm
 - Opening width: 201 – 602 mm
- Quick lift ram to raise wheel and to enable quick assembly
- Foot pedal raise, "dead man" release valve
- Number of strokes: 37

			A	B	C	D	E		
BH8AC3-500	731415 0170487	1	mm 80-615	mm 201-602	mm 495	mm 80	mm 120	mm 1000x1008x995	kg 88.5



BH8PR

MISCELLANEOUS



BH8PR4000







BH8PR10000



BH8PR10000

- Portable ram sets
- Quick click assembling system for easier and faster operation
- Includes:
 - Hand pump
 - Hose
 - Cylinder ram
 - Spreader ram
 - Rubber head
 - Rubber faced flat base
 - 90° V-base
 - Serrated saddle
 - Male thread adaptor
 - A wide selection of extension tubes
- 10 T version cases equipped with wheels
- Capacity:
 - BH8PR10000: 10 T
 - BH8PR4000: 4 T

	 731415		 mm	 kg
BH8PR10000	0178957	1	180x590x370	20
BH8PR4000	0178940	1	215x1030x500	38.5

LIGHTING

Bahco lighting offers powerful, professional lamps for use in various operations to provide the appropriate lighting wherever you work. We supply a wide range, from small, lightweight cordless handlamps that can be used almost anywhere, to specialist lamps for use in under-bonnet service and task lamps to light larger work areas.



Chapter Index

CORDLESS LIGHTING & ACCESSORIES	728-730
CORDED LIGHTING & ACCESSORIES	730-731



CORDLESS HAND LAMPS

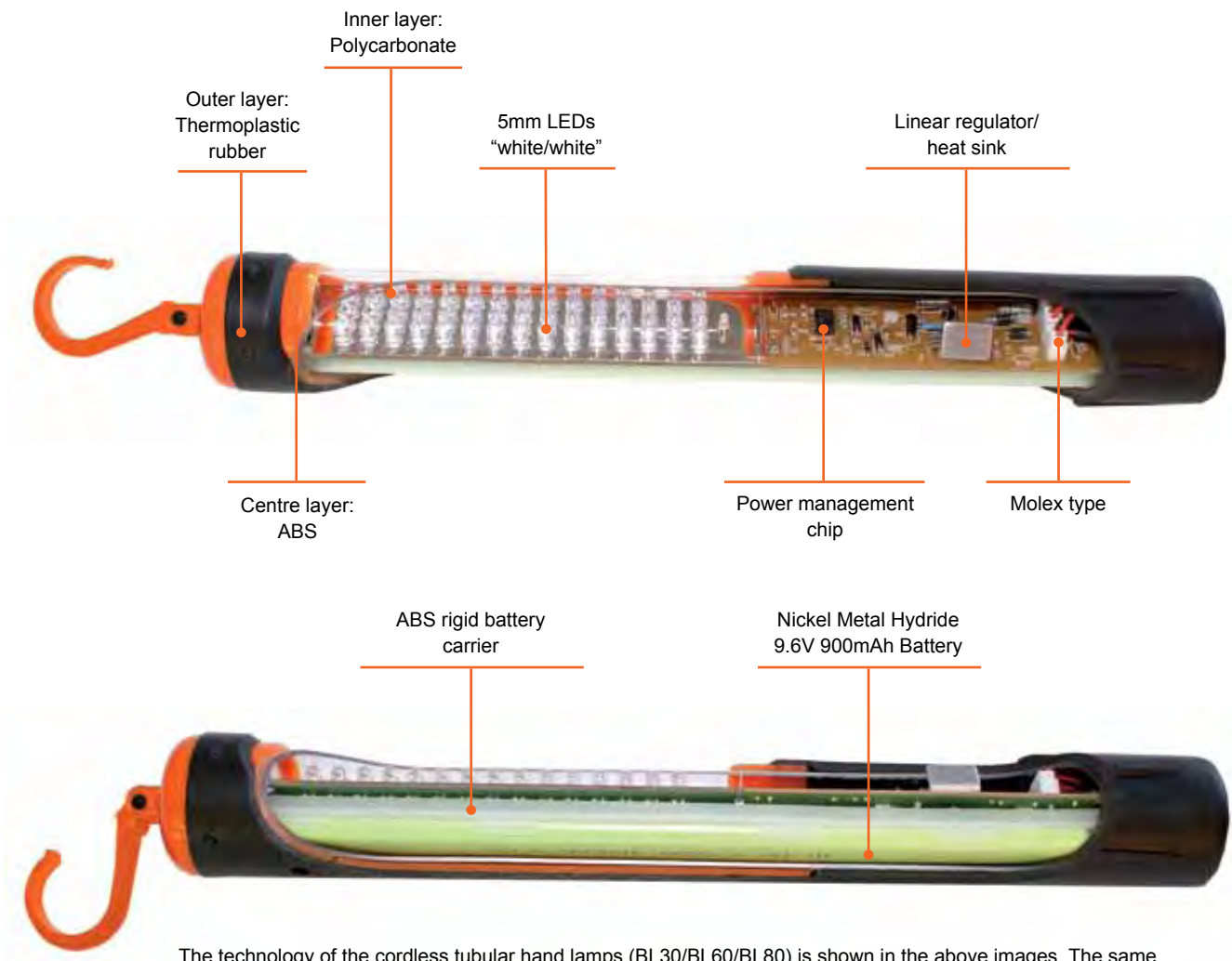

The technology of the cordless tubular hand lamps (BL30/BL60/BL80) is shown in the above images. The same electronic design and specifications also apply to the compact cordless hand lamp (BL15).

CONSTRUCTION

- 3 layers; Polycarbonate tube with moulded in PCB slide mounting, ABS centre and TPR outer

ELECTRONICS

- Digital Power Management driving super white phosphor LEDs for longer life span of the lamp

CABLE MANAGEMENT

- Solder-free Molex connection for impact resistant operation

BATTERY TECHNOLOGY

- 8 x 1.2V battery cells are sealed and encased in a rigid battery carrier clipped to the PCB secured in the tube
- The Metal Nickel battery is managed by the power chip driving the LEDs at peak efficiency in all conditions
- The power chip device ensures the LEDs are not overdriven regardless of the battery status
- Maintains a universal light output in all conditions and extends the life of the lamp

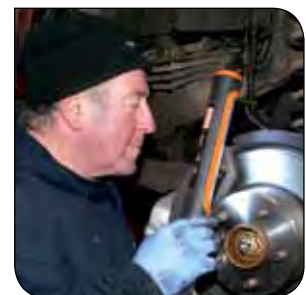

BL15 COMPACT CORDLESS HAND LAMP 15 LEDs

For even the most confined areas

- Compact and lightweight
- Strap, magnet, clip and charger base
- Bright light of 1000 LUX



BLW84W CORDED TASK LAMP 84W

Powerful both indoors and outdoors

- Equipped with an ON/OFF switch and a positional mounting arm
- Practical with easy access to the bulbs and fully replaceable parts
- Powerful yet safe with high IP-rating [IP54]



BLX120 CORDLESS UNDER BONNET LIGHT, 120 LEDs

Ideal for mechanics

- Cordless for flexible usage
- 120 powerful white LEDs
- Strong PC tube and with PVC in handle end cap





BL30/BL60/BL80



LAMPS

- Cordless tubular LED lamps
- Triple layer construction
- Temperature and chemical resistant
- Operating time; 4 hours (BL30 & BL60) and 3.5 hours (BL80)
- Charging time: 1.5h (Ni-Mh)
- LUX output:
 - BL30: 1.200 LUX
 - BL60: 1.700 LUX
 - BL80: 2.000 LUX
- IP Rating: 54

	 731415		 mm	 mm	 kg
BL30	0164349	1	60x351x110	351	0.35
BL60	0164356	1	60x395x120	395	0.42
BL80	0164363	1	60x437x120	437	0.48

BL15



LAMPS

- 15 LED cordless compact lamp
- Dual layer construction
- Temperature and chemical resistant
- Operating time: 6 hours
- Charging time: 3 hours (Ni-Mh)
- LUX output: 1.000
- IP-Rating: 65
- Holder magnet included

	 731415		 mm	 mm	 kg
BL15	0164332	1	75x355x85	181	0.175

BLX120



LAMPS

- 120 LED cordless under bonnet lamp
- Operating time: 3 h
- Charging time: 2.5 h (Ni-Mh)
- LUX output: 500
- IP Rating: 54
- Telescopic system with hook on one side
 - Min length: 1260 mm
 - Max length: 2030 mm

	 731415		 mm	 kg
BLX120	0164400	1	90x1185x185	2.6







BL30/60/80 WC



ACCESSORIES

- Universal wall charger for BL30, BL60 and BL80





	 731415		 mm	 kg
BL30WC	0185672	1	80x70	0.14
BL60/80WC	0185696	1	80x70	0.14

BL30/60/80CLC



ACCESSORIES

- 12 V Outlet for BL30, BL60 and BL80

	 731415		 mm	 kg
BL30/60/80CLC	0185689	1	90x35	0.04

BL15WC



ACCESSORIES

- Wall charger for BL15

	 731415		 mm	 kg
BL15WC	0185634	1	80x70	0.12

BL15CLC



ACCESSORIES

- 12/24 V Cigarette lighter charger for BL15

	 731415		 mm	 kg
BL15CLC	0185641	1	90x35	0.04

BL15MAG



ACCESSORIES

- Magnet for BL15

	 731415		 mm	 kg
BL15MAG	0185658	1	18x29	0.02



CORDLESS LIGHTING & ACCESSORIES

BL15BASE

ACCESSORIES



- Charging dock for BL15

	 731415		 mm	 kg
BL15BASE	0185665	5	65x75x85	0.10

BLX120WC

ACCESSORIES



- Universal wall charger for BLX120

	 731415		 mm	 kg
BLX120WC	0169054	1	50x265x55	0.215



CORDED LIGHTING & ACCESSORIES

BLW42W/BLW84W

LAMPS



- Corded task lamps
- Shock proof ABS body housing
- Compact fluorescent bulbs
- 26W, 32W, 42W bulb capability
- Bulb base fitting: GX24q-4 (BLW42W) and GX24q-5 (BLW84W)
- BLW42W supplied with 1 x 42 W bulbs
- BLW84W supplied with 2 x 42 W bulbs
- 5 m cable type (replaceable)
- LUX Rating:
 - BLW42W: 685
 - BLW84W: 1200
- IP Rating: 54
- 230 V output

	 731415		 V	 mm	 kg
BLW42W	0164387	1	230	370x270x200	3.7
BLW84W	0164394	1	230	370x270x200	3.8



BL11W

LAMPS



- Corded hand lamp 11 W, 230 V
- LUX output: 600
- IP Rating: 54
- Chemical resistant
- 5 m cable
- Anti-roll proof

	 731415		V	 mm	 kg
BL11W	0164370	1	230	55x448x120	0.72

INSPECTION TOOLS

Bahco has developed a range of inspection tools for the professionals who need to see into the most narrow and remote places and even in the roughest working conditions. They help you to see everything, everywhere.

One device - numerous applications

Bahco inspection tools can be used in various application areas. Such as:

Automotive

Engine, body, dash board, transmission, fuel system, tank, etc.

Aviation

Engine, turbine, interior, fuel tank, etc.

Heating, Ventilation and Sanitary

Air condition systems, ventilation systems, sewage systems, fireplaces, ovens, etc.

Hydraulic

Leakages, etc.

Law enforcement

Customs, drugs, house searches, espionage, contraband, intelligence, etc.

Pest control

Wasp nests, bird nests, parasite attacks, etc.

Piping

Leakages, foreign objects identification, welding seams, etc.



Chapter Index

ENDOSCOPES & ACCESSORIES	736-737
STETHOSCOPE	738



BORESCOPE

Hand-held is designed for inspection of pipes, engines, ventilation systems and other hard to reach areas.



VIDEOSCOPE

Bahco BE210 hand-held videoscope can be used for the documentation of any kind of inspection job. The narrow camera lens cable gives access to almost all hard-to-reach areas.









ENDOSCOPES & ACCESSORIES

BE210

ENDOSCOPES



- Videoscope
- Take snapshots and record videos all at the same time. Pictures can be mirrored and reflected directly in the device
- Digital zoom
- Export pictures and videos easily to a PC or TV
- 3.5" colour TFT LCD screen with 3200 x 240 pixels
- 60° field-of-view (FOV), 1-5.5 cm depth-of-view (DOV)
- Multilingual software is available in 21 languages
- The robust plastic case includes:
 - One videoscope device
 - 1 m, Ø 5.8 mm semi-rigid cable
 - 1 GB memory card
 - Mirror modules 35°, 45°, 55° and one magnet module
 - Anti-slip rubber protector
 - Screen cleaner
 - Mini USB cable
 - Charger
 - Spare parts: Battery (ZHVIDEOBAT), charger (ZHVIDEOCHA)





	 731415		 mm	 kg
BE210	0165155	1	120x410x335	2.7
ZHVIDEOBAT	9180244	1	42x76x70	0.2
ZHVIDEOCHA	9180237	1	42x76x70	0.25

BE200

ENDOSCOPES



- Endoscope
- 2.5" colour TFT LCD screen with 320 x 240 pixels
- Includes:
 - 1 m long, Ø 8 mm semi-rigid cable
 - Mirror modules, 35°, 45°, 55° and one magnet module
 - Anti-slip rubber protector
 - Screen cleaner
 - 4 AA batteries

	 731415		 mm	 kg
BE200	0165148	1	120x410x335	2.3



BE200C

FIBRE OPTIC CABLES



BE200CAB250SH



- Lens cables
- Suitable for BE200 and BE210
- Material:
 - a = semi rigid
 - b = flexible
 - c = plumbing spring cable

	 731415		\varnothing mm	L mm		
BE200CAB250SH10	0165452	1	25	10	c	3.30
BE200CAB250SH25	0165469	1	25	25	c	3.76
BE200CAB250SH3	0165445	1	25	3	c	2.85
BE200CAB40F1	0165391	1	4	1	b	1.23
BE200CAB55F1	0165407	1	5.5	1	b	1.27
BE200CAB55F3	0165414	1	5.5	3	b	1.49
BE200CAB58SR1	0165421	1	5.8	1	a	1.31
BE200CAB58SR3	0165438	1	5.8	3	a	1.59
BE200CAB80SR1	0165384	1	8	1	a	1.40
BE200CAB80SR3	0165476	1	8	3	a	1.65

BE200M

ENDOSCOPE ACCESSORIES



- Mirrors and magnetic tips

	 731415		\angle	\varnothing mm		
BE200MAG55	0165513	1	-	5.5, 5.8	x	100
BE200MAG80	0165551	1	-	8	x	100
BE200MIR5535	0165483	1	35°	5.5, 5.8	-	100
BE200MIR5545	0165490	1	45°	5.5, 5.8	-	100
BE200MIR5555	0165506	1	55°	5.5, 5.8	-	100
BE200MIR8035	0165520	1	35°	8	-	150
BE200MIR8045	0165537	1	45°	8	-	100
BE200MIR8055	0165544	1	55°	8	-	100



STETHOSCOPE

BE220

STETHOSCOPE



- Electronic stethoscope
- Includes:
 - Head phones
 - 6 sensors and cables
 - Direct hand bore
 - 2 batteries 9 V

	 731415		 mm	 kg
BE220	0170005	1	135x350x260	2.96

5050

STETHOSCOPE



- Stethoscope
- Steel probe

	 731415		 mm	 g
5050	1083359	1	1000	155



BAHCO



EXTRACTORS & PULLERS

Bahco offers a range of pullers and extractors for a wide variety of applications. Made of special steel with a galvanized finish, they allow the quick, easy, non-damaging removal of pulleys, gears, ball bearings etc. The standard two-, three- and multi-arm pullers are ideal for both internal and external jobs, with features such as flat legs and bodies for work in confined spaces.

The range includes hydraulic pullers and rams, ball-joint pullers, stud extractors, hub pullers, pullers for separators, nut splitters and extractors for specialist operations.

Bahco also offers sets developed for car maintenance, including special pry bars for cylinder heads and gears, and for loosening rust-bound parts and ball bearings.

More pullers and extractors can be found in the chapter on Automotive Speciality Tools and Equipment.



Chapter Index

EXTRACTORS	742-761
PRY BARS	762-763





4532

UNIVERSAL 2 ARM PULLERS

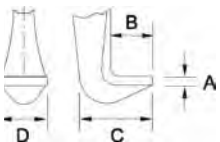
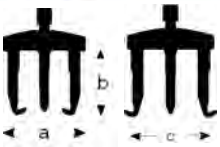

- Extractor: 2 arms
- Finish: Galvanised, with induction hardened spindle from 4532-C, D, E, F, G and H
- Arms and yokes are drop-forged
- Material: Special steel
- By reversing the arms, the extractor can be used as internal or external
- The large claw surfaces offer many advantages for careful and quick removal of pulleys, gears, ball bearings etc.
- Arms always grip parallel to each other
- Arm tip is flat and leg body is narrow

			a	b	c	max	max	max	A	B	C	D			
	731415		mm	mm	mm	Nm	Tn	KN	mm	mm	mm	mm	mm	mm	g
4532-A	1082109	1	25-80	100	70-130	80	4.5	45	3	13	25	20	M14x1.5x135	17	1000
4532-B	1082116	1	25-130	100	80-180	80	4.5	45	3	13	25	20	M14x1.5x135	17	1200
4532-C	1082123	1	50-160	150	105-220	190	6.5	65	4	16	35	25	R1/2"x14Gg.x210	22	3000
4532-D	1082130	1	60-200	150	120-270	190	6.5	65	4	16	35	25	R1/2"x14Gg.x210	22	3200
4532-E	1082147	1	80-250	200	160-330	360	11.0	110	5	25	54	35	R3/4"x14Gg.x265	27	7000
4532-F	1082154	1	80-350	200	160-420	360	11.0	110	5	25	54	35	R3/4"x14Gg.x265	27	8000
4532-G	1082161	1	110-520	200	195-600	360	13.0	130	5	25	54	35	R3/4"x14Gg.x265	27	14000
4532-H	1719999	1	170-640	225	260-715	400	18.0	180	10	33	55	50	R1"x11Gg.x305	36	23000

4532-0

UNIVERSAL 2 ARM PULLERS

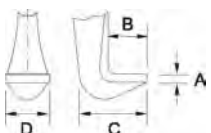
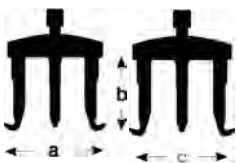

- Extractor: 2 arms
- Finish: Galvanised
- Arms and yokes are drop-forged. Leg tips in gunmetal finish
- Material: Special steel
- By reversing the arms, the extractor can be used as internal or external
- The claw is milled to a slender and pointed form for easy access in confined spaces, for use in the automotive industry
- Legs always grip parallel to each other
- Leg tip is flat, leg body is narrow





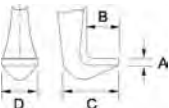

			a	b	c	max	max	max	A	B	C	D			
	731415		mm	mm	mm	Nm	Tn	KN	mm	mm	mm	mm	mm	mm	g
4532-0	1719722	1	20-90	100	70-130	80	4.5	45	3.6	6	13	27	M14x1.5x135	17	1000

4532K0

UNIVERSAL 2 ARM PULLERS



- Pair of spare arms in standard length 4532 series
- Finish: Galvanised, leg tips in gunmetal finish
- Material: Special steel





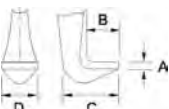

	 731415			 L mm	A mm	B mm	C mm	D mm	 g
4532K0	1720063	1	4532-0	100	3.6	6	13	27	500

4532K

PAIR OF SPARE ARMS IN STANDARD LENGTHS



- Pair of spare arms in standard length 4532 series
- Finish: Galvanised, leg tips in gunmetal finish
- Material: Special steel





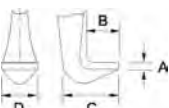

	 731415			 L mm	A mm	B mm	C mm	D mm	 g
4532K1	1082185	1	4532-A-B	100	3	13	25	20	500
4532K2	1082192	1	4532-C-D	150	4	16	35	25	1300
4532K3	1082208	1	4532-E-G	200	5	25	54	35	3200
4532K4	1720148	1	4532-H	225	10	33	55	50	4300

4532LK

PAIR OF SPARE ARMS IN SPECIAL LENGTHS



- Pair of spare arms in special lengths 4532 series
- Finish: Galvanised, leg tips in gunmetal finish
- Material: Special steel







	 731415			 L mm	A mm	B mm	C mm	D mm	 g
4532LK1	1082215	1	4532-A-B	200	3	13	25	20	1000
4532LK2	1082222	1	4532-C-D	300	4	16	35	25	2400
4532LK3	1082239	1	4532-E-G	300	5	25	54	35	4500
4532LK4	1082246	1	4532-E-G	400	5	25	54	35	5400
4532LK5	1720223	1	4532-E-G	500	5	25	54	35	7000

4532/S

SPARE SPINDLES



- Spare spindle, with round steel ball
- Finish: Gunmetal finish, induction hardened and wear resistant spindle on 4532-CD/S 4532-EFG/S and 4532-H/S

	 731415			 mm	 mm	 g
4532-OAB/S	1818050	1	4532-O,-A,-B,4537-1,4528-M1 4541-A,4542-A,4552-1	M14 x 1,5 x 135	17	175
4532-CD/S	1818067	1	4532-C,-D,4552-2,4552-3	G 1/2"x14 Gg.x210	22	575
4532-EFG/S	1838386	1	4532-E,-F,-G	G 3/4"x14 Gg.x280	27	1275
4532-H/S	1838393	1	4532-H	G 1"x 11 Gg.x310	36	2230



4532ST/5

2 ARM PULLER SET SALES DISPLAY



- 5 set display of 2 arm pullers
- Finish: Galvanised
- Material: Special steel
- 4532-A to -E

	 731415		 g
4532ST/5	1720490	1	16700

4533

3 AND MULTI-ARM PULLER



- Extractors: 3 legs and multi-arms
 - To be used a 2, 3 or 4 arm puller due to moveable and interchangeable yoke arms
 - The arms can be moved radially on the yoke and can be fixed at the desired span
 - As the arms can be reversed, the puller can be used both for internal and external jobs
- 4533HP** hydraulic system
- spindle male thread: G1" x 11 x 365
- 4533M** mechanical system with induction hardened and wear resistant spindle
- spindle male thread: G1" x 11 x 365



	 731415		a mm	b mm	 max Nm	 max Tn	 max KN	 g
4533HP	1793043	1	150-700	185	70	15	150	47100
4533M	1793050	1	150-700	200	400	15	150	42500

4529

HYDRAULIC RAMS



- Hydraulic rams
- Finish: Galvanised
- Material: Special steel
- Increases the forward thrust in combination with mechanical pullers, especially suited for tightly jammed parts
- Operation: For hydraulic ram between working piece and puller spindle with spindle drawn back
- Hydraulic system works by tightening spindle
- If piston stroke is insufficient, release spindle and tighten same; Continue to operate spindle as described before







	 731415		Max Tn	Max KN	 mm	 max Nm	 H mm	 g
4529-8	1719562	1	8	80	8	60	51	800
4529-15	1719647	1	15	150	12	70	75	1800

4541

2 ARM PULLERS



- Extractor: 2 arms
- Finish: Galvanised
- Material: Special steel
- Double sided arms, one end broad and the other end narrow

	 731415		a mm	b mm	 max Nm	 MAXI Tn	 MAXI KN	 g
4541-A	1082413	1	20-150	85	50	3,5	35	900
4541-B	1082420	1	40-220	130	60	4	40	2200

4537

2 ARM PULLERS









1 - 2



3 - 4



- Extractor: 2 arms - heavy duty
- Finish: Galvanised
- Material: Special steel
- Especially suited for pulling ball bearings, pulleys, gears, etc.







	 731415		a mm	b mm	 max Nm	 MAXI Tn	 MAXI KN	 g
4537-1	1720650	1	20-170	130	50	3,5	40	1000
4537-2	1720735	1	20-230	200	60	4	40	2300
4537-3	1720810	1	50-300	250	120	6	60	5400
4537-4	1721039	1	50-350	350	120	6	60	6100

4542

3 ARM PULLERS



- Extractor: 3 arm
- Finish: Galvanised
- Material: Special steel
- Especially suited for pulling ball bearings, pulleys, gears, etc
- Double sided arms, one end broad, other end narrow

	 731415		a mm	b mm	 max Nm	 MAXI Tn	 MAXI KN	 g
4542-A	1082451	1	20-150	85	60	4.0	40	1200
4542-B	1082468	1	40-220	130	70	4.5	45	2900



4528M

3 ARM PULLERS



M1 - M2

M3 - M5



- Extractor: 3 arms - heavy duty
- Finished: Galvanised
- Material: Special steel
- Especially suited for pulling ball bearings, pulleys, gears, etc.

	 731415		a mm	b mm	 max Nm	 max Tn	 max KN	 g
4528M1	1718916	1	20-170	130	60	4.0	40	1300
4528M2	1719050	1	20-230	200	70	4,5	45	3100
4528M3	1719135	1	50-300	250	220	10	100	7000
4528M4	1719210	1	50-350	350	220	10	100	8300
4528M5	1719487	1	50-400	400	220	12	120	8800

4528

HYDRAULIC 3 ARM PULLERS



- Extractor: 3 arm hydraulic - heavy duty
- Due to a hydraulic cylinder, this puller reaches a pulling force of 15 t with a stroke of approx 12 mm
- Hydraulic spindle male thread: R1" x 11
- K1-K5 = Spare arms

	 731415		a mm	b mm	 max Nm	 max Tn	 max KN	 g
4528-1	1718671	1	50-350	135	70	15	150	12500
4528K1	1837662	1	50-300	135	-	15	150	3700
4528K2	1837679	1	50-350	235	-	15	150	5000
4528K3	1837686	1	50-400	285	-	15	150	5500
4528K4	1837693	1	50-450	335	-	15	150	6000
4528K5	1837709	1	50-500	385	-	15	150	6500

4543

2 AND 3 ARM PULLERS



4543-1

4543-10



- Extractor: 2 and 3 arms
- Finish: Galvanised
- Material: Special steel
- Handy puller for light duty work, such as on terminals, gears, ball bearings, pulleys etc
- 4543-10 to -30 with 3 arms
- 4543-1 to -3 with 2 arms







	 731415		a mm	b mm	 max Nm	 max Tn	 max KN	 g
4543-1	1082499	1	10-60	40	18	1.0	10	160
4543-2	1082505	1	10-70	74	20	1.2	12	200
4543-3	1721381	1	10-90	84	24	2.0	20	300
4543-10	1721466	1	10-60	40	20	1.2	12	200
4543-20	1721541	1	10-70	74	21	1.3	13	300
4543-30	1721626	1	10-90	84	40	2.5	25	500

4543/S

SPINDLE



- Spare spindle with round steel ball
- Finish: Gunmetal finish







	 731415			 mm	 g
4543-1/S	1818623	1	4543-1 /-10,	10	35
4543-2/S	1818661	1	4543-2-20	10	35
4543-3/S	1818708	1	4543-3 /-30, 4614-1	12	65

4544

2 AND 3 ARM PULLERS



- Extractor: 2 and 3 arm
- Finish: Galvanised
- Material: Special steel
- Solid extractor transmission and self-centring arms
- 4544-1 - 4544-4 with 2 arms
- 4544-10 - 4544-40 with 3 arms







	 731415		a mm	b mm	 max Nm	 max Tn	 max KN	 g
4544-1	1844004	1	10-100	80	25	2.5	25	680
4544-2	1844011	1	10-120	120	35	3.0	30	1140
4544-3	1844028	1	20-160	160	45	3.5	35	2000
4544-4	1844035	1	20-200	200	50	4.0	40	3500
4544-10	1844042	1	10-100	80	25	2.5	25	910
4544-20	1844059	1	10-120	120	35	3.0	30	1450
4544-30	1844066	1	20-160	160	45	3.5	35	2500

4518

UNIVERSAL HUB PULLER



- Universal hub extractor
- Finish: Galvanised
- Material: Special steel
- Sturdy construction for heavy duty work on car and truck hubs
 - 4518-3 3 arms
 - 4518-4 4 arms
 - 4518-5 5 arms

	 731415		a mm	b mm	 max Nm	 max Tn	 max KN	 g
4518-3	1716547	1	225	140	280	14	140	3800
4518-4	1716622	1	225	140	280	14	140	4300
4518-5	1716899	1	225	140	280	14	140	4900



4545

BALL JOINT PULLERS

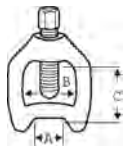

- Ball joint extractor
- Finish: Galvanised
- For removing ball joints during dismantling of ball joints on tie-rods etc
- Non-damaging and easy operation

	 731415		A mm	B mm	C mm	 max Nm	 g
4545-1	1082543	1	18	40	40	50	300
4545-2	1082550	1	25	50	50	120	700
4545-3	1082567	1	29	60	60	160	1000
4545-4	1722272	1	40	80	80	280	2100
4545-5	1722357	1	45	90	100	400	2800

4545-N

UNIVERSAL BALL JOINT PULLERS



4545-N1



4545-N2

- Universal ball joint extractor
- Material: Special steel
- Finish: Galvanised
- A special tool for removing ball pins during dismantling of ball joints on tie-rods etc
- Gripping capacity
- 4545-N1 adjustable up to 50 mm (2") with an opening of 18-22 mm (23/32-7/8")
- 4545-N2 two steps up to 50 mm (2") with an opening of 24 mm (30/32")

	 731415		 g
4545-N1	1722432	1	800
4545-N2	1804947	1	1300

4551

SEPARATORS



- Separator
- Finish: Galvanised
- Material: Special steel









	 731415		 mm		 g
4551-A	1082628	1	10-60	4552-1	400
4551-B	1722784	1	15-75	4552-1	700
4551-C	1082642	1	35-115	4552-2	1900
4551-D	1082659	1	40-150	4552-3	4200

4552

PULLERS FOR SEPARATORS



- Extractor for separator
- Operation: The sharp tapered cutting edges of separator No. 4551 are pressed behind the part to be removed when tightening the stud nuts
- Use puller No. 4552 to withdraw separator and part from the shaft by tightening the rod nuts
- Opening capacity/span depth in mm:
 - 4552-1: 45-140/150
 - 4552-2: 55-200/210
 - 4552-3: 90-260/315

	 731415		 max Nm	 MAX Tn	 MAX KN		 g
4552-1	1722944	1	40	2.5	25	4551-A-B	1100
4552-2	1723088	1	70	4	40	4551-C	2700
4552-3	1723163	1	90	5	50	4551-D	5200





4540

MULTIPLE EXTRACTORS

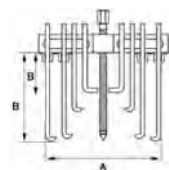

- Multiple extractor
- Can be used as internal or external puller
- Hooks can be bolted to get extended reach



	 731415		A mm	B mm	 g
4540-17	0125005	1	30-170	65-140	2630
4540-25	0125012	1	75-250	77-180	5800



4521N



BALL BEARING INTERNAL EXTRACTORS

- Ball bearing internal extractors
- Finish: Gunmetal finish
- Material: Special steel
- The extractor shank has multiple slots (1-4) which allows uniform spreading on the periphery and safe removal of the ball bearing
- For extracting ball bearings from housings, ball bearing outer races, bushings and oil seals

	 731415		 mm	 ↑	 mm		 g
4521N-00	1837716	1	5-7	1	30	4522-1	50
4521N-0	1837723	1	7-9	1	30	4522-1	50
4521N-A	1837730	1	9-12	1	30	4522-1	60
4521N-B	1837747	1	10-13	4	30	4522-1	60
4521N-C	1837754	1	13-17	4	50	4522-1	80
4521N-D	1837761	1	14-19	4	60	4522-1	90
4521N-E	1837778	1	16-21	4	60	4522-1	90
4521N-F	1837785	1	18-23	4	60	4522-1	110
4521N-G	1837792	1	20-25	4	60	4522-1	110
4521N-H	1837808	1	25-30	4	60	4522-1	120
4521N-I	1837815	1	30-37	4	70	4522-1	280
4521N-K	1837822	1	35-42	4	70	4522-1	280
4521N-L	1837839	1	38-45	4	70	4522-1	290
4521N-M	1837846	1	43-50	4	70	4522-1	310
4521N-S	1839789	1	40-75	3	100	4522-2	760
4521N-T	1839796	1	70-115	3	130	4522-2	1400

4522



COUNTER STAY DEVICES

- Extractor: 2 arms
- To be used with 4521
- Finish: Galvanised
- 4522-1 fits 4521N-00 to -M
- 4522-2 fits 4521N-S and -T

	 731415		 g
4522-1	1081591	1	700
4522-2	1081614	1	1500

4521N/7

COMPLETE WORKSHOP PULLER ASSORTMENT



- Extractor set 9 pcs
- Finish: Galvanised and gunmetal finish
- Material: Special steel
- Metallic box: Size 400 x 310 x 70 mm

	 731415		
4521N/7	1839802	1	6800

4521N-B
4521N-D, 4521N-G, 4521N-H, 4521N-I, 421N-L, 4521N-S



4522-1, 4522-2



4523G

SLIDING HAMMER PULLING BAR



- Sliding hammer
- Finish: Gunmetal finish
- Material: Special steel
- To be used with 4521N-00 to E





	 731415		 mm	
4523G	1846695	1	Ø10x170	400

4524G

SLIDING HAMMER PULLING BAR



- Sliding hammer 1.3 kg
- Finish: Galvanised
- Material: Special steel
- To be used with 4521N-F up to -M

	 731415		 mm	
4524G	1718596	1	Ø16 x 250	1300



4581N-4583N

BALL BEARING PULLERS WITHOUT ARMS



- Ball bearing extractor without arms
- Finish: Galvanised
- Material: Special steel
- This puller removes ball bearings that are inside a housing and mounted on a shaft

	 731415			 g
4581N-1	1724139	1	4581NA, 4581NB	300
4582N-1	1724214	1	4581NB2, 4581NC, 4582NA	400
4582N-2	1724481	1	4581NC, 4582NA, 4582NB	500
4583N-1	1724566	1	4582NA, 4583NA, 4583NB	900
4583N-2	1724641	1	4582NA, 4582NB, 4583NB	1200

4581NA-4583NB

SPARE ARMS



- Extractor spare arms - set of 4 pcs
- Finish: Galvanised
- Material: Special steel

	 731415		 mm		 g
4581NA	1301200	1	120	4581N-1	100
4581NB	1301217	1	120	4581N-1	100
4581NB2	1724726	1	130	4582N-1	200
4581NC	1301224	1	130	4582N-1, 4582N-2	200
4582NA	1301248	1	150	4582N-1, 4583N-2	300
4582NB	1301255	1	150	4582N-2, 4583N-2	400
4583NA	1301279	1	190	4583N-1	600
4583NB	1301286	1	190	4583N-1, 4583N-2	800

4580N/7

SET OF BALL BEARING PULLERS



- Ball bearing extractor set
- Finish: Galvanised
- Material: Special steel
- For ball bearings 6000-6012, 6200-6212, 6300-6311, 6403-6406
- Pullers No. 4581NB-1, 4582N-1, 4582N-2, 4583N-1, 4583N-2
- 8 arm set, 4 pcs each No. 4581NA through 4583NB





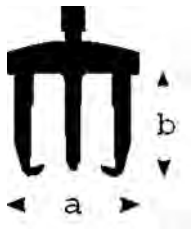

	 731415		 mm	 g
4580N/7	1301361	1	287x192x66	8000

4614

2 ARMS PULLERS



- Extractor: Scissor type
- Finish: Galvanised, induction hardened and wear-resistant spindle
- Material: Special steel
- Application: Due to the shearing action, the arm's clamping force is increased when pulling; The claws are pointed at one end which makes this puller well suited for work in confined spaces
- 4614-1 particularly suited for armature bearings on 3-phase current generators





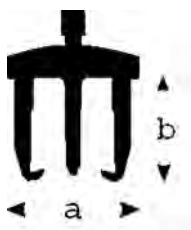

	 731415		a mm	b mm	 max	 max Tn	 max KN	 g
4614-1	1725457	1	6-100	70-85	25	1.5	15	400
4614-2	1725532	1	10-140	85-120	60	3.5	35	900

4519

PULLERS WITH CLAMP



- Extractor: 2 arms with clamp
- Finish: Galvanised
- To remove axle bearings, ball bearing races, pinions etc
- Double-side use of arms
- Both claws are slim which makes the tool ideal for work in confined spaces







	 731415		a mm	b mm	 max	 max Tn	 max KN	 g
4519-1	1716974	1	20-110	80-170	120	5	50	2300
4519-2	1717193	1	40-150	90-270	120	6	60	4100
4519-3	1717278	1	40-150	90-330	150	8	80	4500

4519/S

SPARE SPINDLES



- Spare spindle, with round steel ball
- Finish: Gunmetal finish

	 731415			 mm	 g
4519-1/S	1843762	1	4519-1, 4542-B, 4583N-1 4537-2, 4528M2, 4541-B	19	48
4519-2/S	1843977	1	4519-2, 4519-3, 4528M3, 4528M4 4528M5, 4537-3, 4537-4	22	73



EXTRACTORS

4610

NUT SPLITTERS HYDRAULIC



- Hydraulic nut splitter
- Finish: Galvanised and gunmetal finish
- Material: Special steel
- For nuts up to type 10
- For removing jammed nuts without damaging the stud thread
- The double swan-neck tool permits working in confined spaces
- Due to a hydraulic system, a minimum of effort is required for the operation
- The chisel will not retract automatically after use
- Max load 50 KN

4610-1	731415 1724993	1	M4-M14	7-22 mm	45 Nm	800 g

4611

NUT SPLITTERS MECHANICAL



- Mechanical nut splitter
- Finish: Galvanised and gunmetal finish
- Material: Special steel
- For nuts up to type 6
- For removing jammed nuts without damaging the stud thread

4611-3	731415 0125043	1	M16-M24	6-36 mm	300 g

4553

STUD REMOVERS



- Stud remover
- Finish: Galvanised
- Material: Vanadium-extra
- Head thickness 10 mm

4553	731415 1830649	1	315 mm	5-20 mm	390 g



4591-4593

STUD REMOVERS



- For tightening and loosening left and right-hand threaded studs
- Finish: Galvanised and gunmetal finish
- Due to the eccentric and knurled clamping disc, short studs can be removed
- Drive SW 19 mm

	 731415		 mm	 max Nm	 g
4591	1804039	1	5-15	120	360
4592	1804046	1	10-19	120	400
4593	1804053	1	18-28	120	450

4574

SET OF PULLER AND SEPARATOR ASSORTMENT



- Extractors and separators set
- Finish: Galvanised
- Material: Special steel

	 731415		 mm	 g
4574	1799014	1	360x300x105	16000

4532
4532-A, -C



4551-C



4532LK
4532LK1, & LK2



4529-15





4577

SET OF PULLERS FOR CAR MAINTENANCE

- Extractor set for car maintenance
- Finish: Galvanised
- Material: Special steel



	 731415		 mm	 9
4577	1838348	1	440x400x90	10500

4565N



4545-N2



4532-B



4614-1



4521N
4521N-B, 4521N-D,
4521N-G 4521N-H,
4521N-I, 4521N-L



4523G



4522-1









1420-1424

STUD EXTRACTORS FOR BROKEN-OFF SCREWS, BOLTS AND STUDS



- Stud extractors for broken-off screws, bolts and studs
- Finish: Blasted
- Material: Chrome-vanadium



	 731415		\varnothing mm	 mm	 mm		
1420-1.4	1696337	1	1.4-3.6	50	1.8	M 3-6	3
1421-2.1	1696412	1	2.1-4.9	57	2.6	M 6-8	7
1422-3.1	1696689	1	3.1-6.5	65	3.7	M 8-11	15
1423-4.8	1696764	1	4.8-8.8	70	5.5	M11-14	25
1424-6.2	1696849	1	6.2-11.0	80	7.0	M14-18	45

1435/5

STUD EXTRACTOR SET



- Stud extractors set 5 pcs
- Finish: Blasted
- Material: Chrome-vanadium
- Covers screws M3 to M18

	 731415		
1435/5	1040734	1	145

1420 1421 1422 1423 1424







1435/8

STUD EXTRACTOR SET



- Set with 8 stud extractors
- Finish: Blasted
- Material: Chrome-vanadium
- For screws M3 to M45

	 731415		
1435/8	1040741	1	740

1420, 1421, 1422, 1423, 1424, 1425, 1426, 1427





1411-1415

STUD EXTRACTORS



- Finish: Black finish
- Material: Vanadium-extra

	 731415		 mm	 mm	 mm	 mm		 g
1411-3.2	1040437	1	10	60	3.2	1/8	M5-M6	12
1412-4.8	1040444	1	11	70	4.8	3/16	M8	20
1413-6.4	1040451	1	13	80	6.4	1/4	M10	32
1414-8	1040468	1	14	85	8.0	5/16	M12	45
1415-8.7	1040475	1	17	95	8.7	11/32	M14-M16	65

1418S

SET OF STUD EXTRACTORS FOR BROKEN-OFF SCREWS, BOLTS AND STUDS



- Set of stud extractors for broken-off screws, bolts and studs
- Finish: Black finish
- Material: Vanadium-extra
- In a plastic case

	 731415		 g
1418S	1040604	1	620

1411 1412 1413 1414 1415



G220 HSS-M
3.2, 4.8, 6.4, 8, 8.7 mm DIN 338 RN



1418
A, B, C, D, E, F, G, H, I, K



1418A-K

SET OF STUD EXTRACTORS FOR BROKEN-OFF SCREWS, BOLTS AND STUDS



- Guide bushes
- Finish: Black finish
- Material: Vanadium-extra

	 731415		 g
1418A	1040505	1	4
1418B	1040512	1	7
1418C	1040529	1	11
1418D	1040536	1	14
1418E	1040543	1	14
1418F	1040550	1	13
1418G	1040567	1	17
1418H	1040574	1	22
1418I	1040581	1	15
1418K	1040598	1	20



1419/4



SET OF STUD EXTRACTORS FOR BROKEN-OFF SCREWS, BOLTS AND STUDS

- Set of stud extractors for broken-off screws, bolts and studs including 4 sizes: M5-M10; M8-M14; M12-M20; extractors M16-M24

	 731151		
1419/4	0125036	1	300

1460M/1



SETS OF THREAD-CUTTING TOOLS

- Finish: Polished, taps with ground flanks, in lacquered metal box and with wooden insert
- Material: Taps and dies of HSS
- Taps DIN 352/ISO 6H, dies DIN 223/ISO 6 g, adjustable tap wrench DIN 1814, 4-9, die stocks DIN 225
 - For metric ISO standard threads M 5 6 7 8 9 10 11 12
- Contents: 37 pcs
 - 24 taps = 8 sets of 3 taps (taper, plug, bottoming)
 - 8 round dies, pre-slotted
 - 1 adjustable tap wrench, size 2
 - 4 die stocks, 20 x 7, 25 x 9, 30 x 11, 38 x 14

	 731415		
1460M/1	1041090	1	5000

1460M/2



SETS OF THREAD-CUTTING TOOLS

- Finish: Polished, taps with ground flanks, in lacquered metal box and with wooden insert
- Material: Taps and dies of HSS
- Taps DIN 352/ISO 6H, dies DIN 223/ISO 6 g, adjustable tap wrench DIN 1814, 4-9, die stocks DIN 225
 - For metric ISO standard threads, M 5 6 7 8 9 10 11 12 14 16 18 20
- Contents: 55 pcs
 - 36 taps = 12 sets of 3 taps (taper, plug, bottoming)
 - 12 round dies, pre-slotted
 - 2 adjustable tap wrenches, size 1, DIN 1814, 2-6,3 size 3, DIN 1814, 4,9-12
 - 5 die stocks, 20 x 7, 25 x 9, 30 x 11, 38 x 14, 45 x 18

	 731415		
1460M/2	1041106	1	8100



1460Z/2



SETS OF THREAD-CUTTING TOOLS

- Finish: Polished, taps with ground flanks
- Material: Taps and dies of HSS
- Taps DIN 352/ISO 6H, dies DIN 223/ISO 6 g, adjustable tap wrench DIN 1814,4-9, die stocks DIN 225
- For American threads:
 - **N.F.** (S.A.E.) 1/4 5/16 3/8 7/16 1/2 9/16 5/8 3/4 in.
 - 28 24 24 20 20 18 18 16 threads per inch
 - **N.C.** (U.S.S.) 1/4 5/16 3/8 7/16 1/2 9/16 5/8 3/4 in.
 - 20 18 16 14 13 12 11 10 threads per inch
- Contents: 54 pcs
 - 32 taps = 8 sets of 2 N.F. taps (taper, bottoming) = 8 sets of 2 N.C. taps (taper, bottoming)
 - 16 round dies, pre-slotted
 - 1 adjustable tap wrench, size 3 DIN 1814, 9-12
 - 5 die stocks, 20 x 7, 25 x 9, 30 x 11, 38 x 14, 45 x 18

1460Z/2	731415 1041120	1	10500

600



TAP WRENCH

- With reversible ratchet: Forward-reverse-locked
- Parallel clamping action
- Hardened jaws
- Sliding handle
- Chrome plated steel

600.003.010	841281 4600000	1	mm 3-10	mm 85	g 195
600.005.012	4600017	1	5-12	110	329



1450D-ISO

DOUBLE THREAD RESTORERS, METRIC



- Double thread restorers for internal and external threads, Metric
- Finish: Galvanised
- Pitch Metric thread

mm	mm
0.80	5
1.00	6 and 7
1.25	8 and 9
1.50	10 and 11
1.75	12
2.00	14 and 16
2.50	18, 20, 22
3.00	24 and 27

	 731415		 mm	 g
1450D-ISO	1040970	1	230	117





1450D-WW

DOUBLE THREAD RESTORERS, INCH



- Double thread restorers for internal and external threads, Inch
- Finish: Galvanised
- Whitworth

Threads/inch	BSF thread	BSW thread
24	3/16	-
20	1/4	3/8
18	5/16	7/16
16	3/8	1/2 and 9/16
14	7/16	5/8
12	1/2 and 9/16	3/4
11	5/8	7/8
10	3/4	1

	 731415		 mm	 g
1450D-WW	1040987	1	230	117

1450D/2

SET



- Double thread restorers set
- In wooden box
- With thread table

	 731415		 g
1450D/2	1040963	1	300

1450D-ISO



1450D-WW





PRY BARS

2632 COMBINATION COTTER PIN EXTRACTOR AND SPREADER



- Finish: Working surfaces fine-polished, made of 8 mm hexagon stock
- Material: Vanadium-extra

2632	731415 1065706	1	L mm 170	g 55

3680 SPECIAL PRY BAR



- For prying of cylinder heads and gears, loosening rust-bound parts, seating and deseating ball bearings

3680	731415 1075835	1	L mm 400	g 500

3683 SPECIAL PRY BAR



- 90° special lever
- With convex 90° offset head, suitable for work in confined spaces such as behind gears

3683	731415 1075866	1	L mm 400	g 410

3681 SPECIAL PRY BAR

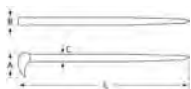

- With a long tapered end for alignments and a rolling head for prying
- Finish: Black phosphated with polished head
- Material: Hardened special alloy steel





			A mm	B mm	C mm		
3681-11	731415 0132980	1	35	13	11	L mm 304	g 230
3681-16	0132997	1	44	14	14	406	450
3681-20	0133000	1	58	17.5	17	508	835

3684

SPECIAL PRY BAR



- With long-tapered end for alignments and a flat end used for lifting and bending heavy parts
- Finish: Manganese phosphated
- Material: Hardened chrome-vanadium steel
- Shape: Hexagon shank



	 731415		A mm	B mm	C mm	 L mm	 g
3684-16	0133017	1	21	19	12.7	406	360
3684-18	0133024	1	29	22.5	15.8	457	625
3684-24	0133031	1	37	26	19	609	1250
3684-30	0133048	1	38	32	22.2	762	2140

2484/S4

PRY BAR, SETS



- Set of pry bars for easy prying and bending
- Plastic handles with lightweight design offers a comfortable grip as well as powerful leverage potential
- L: 200, 300, 450 and 600 mm

	 731151		 mm	 g
2484/S4	8276553	10	640x115x35	1500

TOOL STORAGE

High quality tools deserve high quality storage, which is why Bahco has developed a range of durable tool storage suitable for most application areas. They are designed to ensure your tools are readily accessible when in use and stored in a safe, secured and protected environment at all other times.

Chapter Index

TOOL HOLDERS COLLECTION	770-781
TOOL STORAGE	782-843
SETS	844-846



TOP LINE TOOL STORAGE

1475K SERIES

Strong, reliable and meticulously designed

Bahco's broad and now improved range of heavy-duty trolleys have been designed to meet a wide variety of user needs. They are available in different sizes, with different numbers of drawers, top materials and colours.

LOCK & GO!

The Lock & Go system secures the drawers automatically when closing



T-MODULE SYSTEM

Allows users to create the trolley that suits their precise preferences by choosing modules adapted to their specific, individual needs

ALUMINIUM BRUSHED HANDLES

Easy to clean, light-weight handles

DRAWERS

Ball bearing slides. Full opening drawers. A load capacity of 45 kg per drawer



DOUBLE WALL FRAME

Drawers and slides function normally even if the frame gets damaged

ENHANCED PRECISION WHEELS

Robust 125 x 50 mm wheels, two fixed and two swivelling with brakes. Good stability, easy to move and secure with non marking rubber

SUPERIOR QUALITY PAINT

Shiny, scratch-resistant paint

ICON INDEX



Drawer load capacity



Trolley load capacity

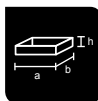

Drawer dimensions



Wheel dimensions



Trolley dimensions

TOP LINE TOOL STORAGE

1475K SERIES



SIZE 40"
12 DRAWER TROLLEY
 Stainless steel top

SIZE 40"
7-DRAWER TROLLEY
 Standard top



SIZE 40"
7-DRAWER TROLLEY
 Wooden top



SIZE 40"
6-DRAWER TROLLEY
 Standard top



SIZE 26"
8-DRAWER TROLLEY
 Standard top



COLOURFUL TROLLEYS



- | | |
|------------------|-------------------|
| ■ Västerås Black | ■ Göteborg Blue |
| ■ Stockholm Blue | ■ Malmö Violet |
| ■ Bahco Orange | ■ Lidköping Green |
| ■ Enköping Red | ■ Bollnäs Green |



1470K SERIES TOOL TROLLEYS & TOP CHEST

The 1470K Series Tool Trolleys & Top Chest are specially designed to meet the most demanding professional tool storage requirements. Robust construction means the tool trolleys can withstand heavy loads and high volume storage.



One of the highest volume capacities of its class:
0,157 m³

One of the highest drawer load capacities in its class:
30 kg

One of the highest static load capacities in its class:
600 kg



TOOL MODULES FOR 1475K AND 1470K SERIES

Our tool modules bring order and organisation to the workplace. Adapted foam inlays ensure that all drawers are kept neat and tidy. They fit all Bahco Tool Trolleys and are available with or without tools.



Special Features

- Modular system
- Environmentally friendly foam, complying with EU requirements
- Resistant to skydrol, petrol, diesel and water
- Soft material that does not fracture
- UV stability
- Noise damping material
- Tool control and missing item identification through the use of two-coloured foam



T-Module System offers numerous advantages:

- Maximum storage capacity
- Large number of storage trays per drawer
- Multiple possibilities for tool storage
- Maximum use of storage tray surface area

Modules can be selected from a wide range of T-Modules, to suit user preferences and special requirements, then combined in various ways in the drawers of the Bahco tool trolleys.

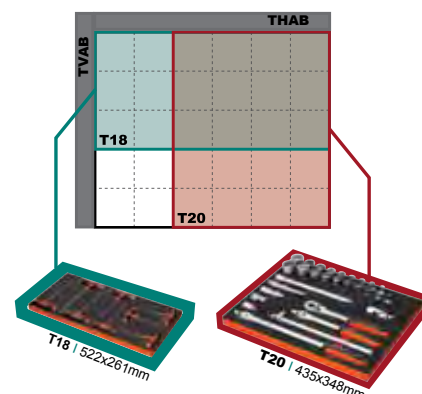
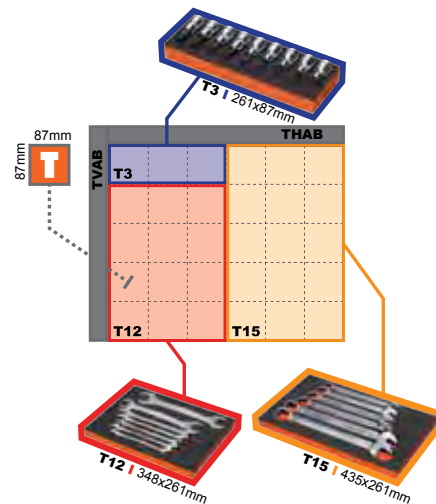
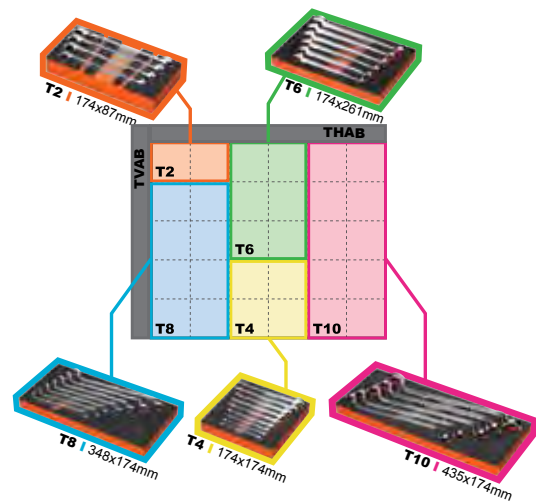

T-MODULES

T size	Dimensions (mm)
T2	174 x 87
T3	261 x 87
T4	174 x 174
T6	174 x 261
T8	348 x 174
T10	435 x 174
T12	348 x 261
T15	435 x 261
T18	522 x 261
T20	435 x 348

Adaptors	Dimensions (mm)
TVAB	444 x 21
THAB	519 x 9



TOOL HOLDERS COLLECTION

4750-HDBS-1

HEAVY DUTY BELT SET



- Heavy duty belt set
- Made from tough lightweight nylon with leather lining
- Heavy padded belt for superior comfort when fully loaded



4750-HDBS-1



731415
3015259



1



400x140x1390



1950

4750-3PB

3 POUCH BELT SET



- 3 pouch belt set
- Fits waist up to 48"
- Made from tough, lightweight nylon
- Plenty of riveting for real strength
- Rust proofed fittings, including tape clip



4750-3PB-1



731415
3014719



1



690x110x270



900

4750-JU3PB

JUNIOR POUCH BELT



- Junior 3 pouch belt set
- Made from tough lightweight nylon
- Plenty of riveting for real strength
- Rust proof fittings including tape clip



4750-JU3PB-1



731415
3015747



1



430x60x150



375





4750-UP

UNIVERSAL POUCH



- Universal pouch
- Carries all the essentials
- Rust proofed fittings
- Strong industrial stitching





	 731415		 mm	 g
4750-UP-1	3014795	1	290x110x310	430

4750-2PP

2 POCKET FIXINGS POUCH



- 2 pocket fixings pouch
- Extra strong 600D polyester
- Leather sleeve for your knife
- Handy extra pocket

	 731415		 mm	 g
4750-2PP-1	3014733	1	240x120x290	360

4750-EP

ELECTRICIANS' POUCH



- Electricians' pouch
- Generous pouch space
- Rust-proof fittings
- Riveted for extra strength

	 731415		 mm	 g
4750-EP-1	3014726	1	320x120x250	500



TOOL HOLDERS COLLECTION

4750-DHOP-1

DRILL HOLSTER & POUCH



- Pouch for fixings storage
- Holds a cordless drill
- Includes a measuring tape clip



4750-DHOP-1



731415
3018816



1



340x300x100



700

4750-DHO

DRILL HOLSTER



- Drill holster
- Ergonomically designed
- Rust proof fittings
- Riveted reinforcement



4750-DHO-1



731415
3014740



1



330x40x210



180

4750-HHO

HAMMER HOLDER



- Hammer holder
- Holds any claw hammer at a comfortable angle
- Rust proof holder



4750-HHO-2



731415
3014863



1



180x70x110



150





4750-MTHO-1

MEASURING TAPE HOLDER



- Fits on any belt
- For measuring tape 5-10 m long
- Size: 11 x 14 cm





	 731415		 mm	 g
4750-MTHO-1	3015846	1	110x60x140	100

4750-KNHO-1

KNIFE HOLDER



- Knife holder
- Riveted reinforcement
- Rust proofed fittings

	 731415		 mm	 g
4750-KNHO-1	3015839	1	90x30x160	63

4750-GNP-1

GUN NAILS POUCH



- Fits on any belt
- Plastic reinforcement inside
- Industrial strength stitching
- Takes up to seven strips of 91 mm nails
- Size: 10 x 26 cm

	 731415		 mm	 g
4750-GNP-1	3018786	1	100x60x260	100



4750-VMPH-1

VERTICAL MOBILE PHONE HOLDER



- Vertical mobile phone holder
- Velcro® loops fits any belt
- Made from strong nylon

	 731415		 75x60x150 mm	 g
4750-VMPH-1	3014818	1	75x60x150	70

4750-HMPH-1

HORIZONTAL MOBILE PHONE HOLDER



- Horizontal mobile phone holder that fits most common models
- Protection for your mobile phone

	 731415		 130x50x80 mm	 g
4750-HMPH-1	3014801	1	130x50x80	40

4750-VMPH-2

VERTICAL SMALL MOBILE PHONE HOLDER



- Modern design
- Belt loop
- Useful hanger

	 731415		 60x30x120 mm	 g
4750-VMPH-2	3017475	1	60x30x120	40





4750-HMPH-2

HORIZONTAL SMALL MOBILE PHONE HOLDER



- Horizontal mobile phone holder
- Belt loop





	 731415		 mm	 g
4750-HMPH-2	3016010	1	125x60x40	40

4750-HDB-1

HEAVY DUTY LEATHER BELT WITH CUSHION



- Heavy duty leather belt with cushion
- Made from high grade leather
- Heavily padded for extra comfort





	 731415		 mm	 g
4750-HDB-1	3014955	1	510x50x50	300

4750-HDLB

HEAVY DUTY LEATHER BELT



- Heavy duty leather belt
- Made from extra strong leather

	 731415		 mm	 g
4750-HDLB-1	3014757	1	1330x40x50	250



4750-QRLB

QUICK RELEASE BELT



- Quick release belt
- Fits waist size 28" to 54"
- Quick release buckle
- Extra strong nylon and 600D polyester toolbelt

	 731415		 mm	 g
4750-QRLB-1	3014764	1	1430x20x60	180

4750-LBBLM/LBLL-1

LEATHER BELT BLACK



- Made from high quality leather
- M = 77 cm - 95 cm, L= 93 cm - 115 cm
- Width 4 cm

	 731415		 mm	 g
4750-LBLL-1	3018830	1	40x130x5	200
4750-LBBLM-1	3018823	1	40x110x5	180

4750-LBBRM/LBBRL-1

LEATHER BELT BROWN



- Made from high quality leather
- M = 77 cm - 95 cm, L= 93 cm - 115 cm
- Width 4 cm

	 731415		 mm	 g
4750-LBBRL-1	3018854	1	130x40x5	200
4750-LBBRM-1	3018847	1	130x40x5	180



4750-BWC-1

BRACES WITH CLIPS



- Universal size with adjustable straps
- Made from strong and durable material
- 43 mm width elastic rubber
- Size: Universal

	 731415		 430x20x800 mm	 g
4750-BWC-1	3018809	1	430x20x800	190

4750-KP

KNEE PADS



- Knee pads
- Hook and loop fastening, soft "bear" lining
- Made from strong synthetic leather with rubber

	 731415		 1250x30x90 mm	 g
4750-KP-1	3014771	1	1250x30x90	350

4750-FOLTC-1

TOOL CASE/BAG



- Front opening leather tool case

	 731415		 440x160x270 mm	 g
4750-FOLTC-1	3019271	1	440x160x270	3095



TOOL HOLDERS COLLECTION

4750-TOCSAE-1



TOOL CASE/BAG

- Tool case with strong aluminium edges
- Shoulder strap included
- Riveted reinforcement



4750-TOCSAE-1



731415

3015297



1



260x490x250



3200

4750-TOCSSL-1



TOOL CASE/BAG

- Tool case with spirit level holder
- Shoulder strap included
- Pocket on the front for documents



4750-TOCSSL-1



731415

3016232



1



490x250x260



3100

9508



TOOL CASE/BAG

- Plumber's leather tool case
- Shoulder belt included
- Reinforced corners and base



950800000



841334

5107129



1



430x180x180



10750







4750-TOCS-1

TOOL CASE/BAG



- Small tool case
- Shoulder strap included





	 731415		 mm	 g
4750-TOCS-1	3015280	1	270x410x190	1900

4750-SLTC-1

TOOL CASE/BAG



- Synthetic leather tool case





	 731415		 mm	 g
4750-SLTC-1	3019264	1	410x160x270	1700

4750-TOCST-1

TOOL CASE/BAG



- Tool case tube
- Shoulder strap included
- 2 leather fastening straps

	 731415		 mm	 g
4750-TOCST-1	3018779	1	510x170x180	1700



TOOL HOLDERS COLLECTION

4750-ROCO-1



TOOL CASE/BAG

- Roll cover for tools

	 731415		 mm	 g
4750-ROCO-1	3015273	1	340x40x320	450

3100TB



TOOL CASE/BAG

- Open top tool bag for easy access and use
- Comfortable padded carry strap and handle
- 10 internal, 11 external pockets, tape measure clip and spirit level straps
- Waterproof base

	 731415		 mm	 g
3100TB	0125364	1	600x400x400	1200

4750-TOBA-1



TOOL CASE/BAG

- Tool bag
- Reinforced floor
- Pocket with easy Velcro® fastening strap

	 731415		 mm	 g
4750-TOBA-1	3015303	1	270x350x540	1400

4750-BAPA-1



TOOL CASE/BAG

- Back pack
- Industrial stitching

	 731415		 mm	 g
4750-BAPA-1	3015310	1	350x150x420	600





4750-BAPA-2

TOOL CASE/BAG



- Back pack
- Adjustable shoulder straps
- Industrial stitching





	 731415		 mm	 g
4750-BAPA-2	3015327	1	320x50x420	600

4750-MOSBA-1

TOOL CASE/BAG



- Mono shoulder bag
- Adjustable shoulder strap
- Extra pockets
- Industrial stitching





	 731415		 mm	 g
4750-MOSBA-1	3015334	1	390x40x490	430

4750-LUBA-1

TOOL CASE/BAG



- Lunch bag
- Shoulder strap included
- Tough lightweight nylon with thermal-insulating foil lining

	 731415		 mm	 g
4750-LUBA-1	3015266	1	300x330x180	500



1475K8

TOOL TROLLEYS



- 8 drawer trolley
- Lock & Go! latching system prevents drawers opening when moving the trolley
- Long ball bearing slides with 100% opening drawers
- Scratch resistant paint
- Available in different colours
- Big capacity heavy duty construction trolley
- Double wall frame protects the slides and drawers from shocks/crashes
- Reinforced areas to reduce stress in specific points of the trolley
- Strong and secure round type key and central locking mechanism
- Wheels of 125 x 50 mm with ball bearings and non-marking rubber surface
 - 2 fixed
 - 2 swivel with brake
- Drawers internal dimensions:
 - (6 x) 543 x 445 x 53 mm
 - (1 x) 543 x 445 x 118 mm
 - (1 x) 543 x 445 x 184 mm



	 731415		 mm	 Kg	 mm	 Kg	 mm	 kg
1475K8PC	0182923	2	677x501x955	1.100	543x445xh	45	50x125	80
1475K8PCM	0182930	2	677x501x955	1.100	543x445xh	45	50x125	80
1475K8PDG	0183302	2	677x501x955	1.100	543x445xh	45	50x125	80
1475K8PEV	0182947	2	677x501x955	1.100	543x445xh	45	50x125	80
1475K8PSP	0183357	2	677x501x955	1.100	543x445xh	45	50x125	80
1475K8PJJ	0182961	2	677x501x955	1.100	543x445xh	45	50x125	80
1475K8PAW	0182978	2	677x501x955	1.100	543x445xh	45	50x125	80
1475K8PSV	0186952	1	677x501x955	1.100	543x445xh	45	50x125	80



1475KXL6

TOOL TROLLEYS



- 6 drawer extra large capacity trolley
- Lock & Go! latching system prevents drawers opening when moving the trolley
- Long ball bearing slides with 100% opening drawers
- Scratch resistant paint
- Available in different colours
- Extra large capacity heavy duty construction trolley
- Double wall frame protects the slides and drawers from shocks/crashes
- Reinforced areas to reduce stress in specific points of the trolley
- Strong and secure round type key and central locking mechanism
- Wheels of 150 x 50 mm with ball bearings and non-marking rubber surface
 - 2 fixed
 - 2 swivel with brake
- Drawers internal dimensions:
 - (2 x) 881 x 445 x 53 mm
 - (3 x) 881 x 445 x 118 mm
 - (1 x) 881 x 445 x 184 mm

	731415		mm	Kg	mm	Kg	mm	kg
1475KXL6PC	0182701	1	1.016x501x985	1.100	881x445xh	45	50x150	133
1475KXL6PCM	0182718	1	1.016x501x985	1.100	881x445xh	45	50x150	133
1475KXL6PDG	0183319	1	1.016x501x985	1.100	881x445xh	45	50x150	133
1475KXL6PEV	0182725	1	1.016x501x985	1.100	881x445xh	45	50x150	133
1475KXL6PSP	0183364	1	1.016x501x985	1.100	881x445xh	45	50x150	133
1475KXL6PJJ	0182749	1	1.016x501x985	1.100	881x445xh	45	50x150	133
1475KXL6PAW	0182756	1	1.016x501x985	1.100	881x445xh	45	50x150	133
1475KXL6PSV	0186969	1	1.016x501x985	1.100	881x445xh	45	50x150	133



1475KXL7

TOOL TROLLEYS



- 7 drawer extra large capacity trolley
- Lock & Go! latching system prevents drawers opening when moving the trolley
- Long ball bearing slides with 100% opening drawers
- Scratch resistant paint
- Available in different colours
- Extra large capacity heavy duty construction trolley
- Double wall frame protects the slides and drawers from shocks/crashes
- Reinforced areas to reduce stress in specific points of the trolley
- Strong and secure round type key and central locking mechanism
- Wheels of 150 x 50 mm with ball bearings and non-marking rubber surface
 - 2 fixed
 - 2 swivel with brake
- Drawers internal dimensions:
 - (3 x) 881 x 445 x 53 mm
 - (4 x) 881 x 445 x 118 mm



	731415		mm	Kg	mm	Kg	mm	kg
1475KXL7PC	0182763	1	1.016x501x985	1.100	881x445xh	45	50x150	137
1475KXL7PCM	0182770	1	1.016x501x985	1.100	881x445xh	45	50x150	137
1475KXL7PDG	0183326	1	1.016x501x985	1.100	881x445xh	45	50x150	137
1475KXL7PEV	0182787	1	1.016x501x985	1.100	881x445xh	45	50x150	137
1475KXL7PSP	0183371	1	1.016x501x985	1.100	881x445xh	45	50x150	137
1475KXL7PJJ	0182800	1	1.016x501x985	1.100	881x445xh	45	50x150	137
1475KXL7PAW	0182817	1	1.016x501x985	1.100	881x445xh	45	50x150	137
1475KXL7PSV	0186976	1	1.016x501x985	1.100	881x445xh	45	50x150	137



1475KXL7TW

TOOL TROLLEYS



- 7 drawer extra large capacity trolley with wooden top
- Lock & Go! latching system prevents drawers opening when moving the trolley
- Long ball bearing slides with 100% opening drawers
- Scratch resistant paint
- Available in different colours
- Extra large capacity heavy duty construction trolley
- Double wall frame protects the slides and drawers from shocks/crashes
- Reinforced areas to reduce stress in specific points of the trolley
- Strong and secure round type key and central locking mechanism
- Wheels of 150 x 50 mm with ball bearings and non-marking rubber surface
 - 2 fixed
 - 2 swivel with brake
- Drawers internal dimensions:
 - (3 x) 881 x 445 x 53 mm
 - (4 x) 881 x 445 x 118 mm



	 731415		 mm	 Kg	 mm	 Kg	 mm	 kg
1475KXL7PCTW	0182824	1	1.016x501x1.020	1.100	881x445xh	45	50x150	143
1475KXL7PCMTW	0182831	1	1.016x501x1.020	1.100	881x445xh	45	50x150	143
1475KXL7PDGTW	0183333	1	1.016x501x1.020	1.100	881x445xh	45	50x150	143
1475KXL7PEVTW	0182848	1	1.016x501x1.020	1.100	881x445xh	45	50x150	143
1475KXL7PSPTW	0183388	1	1.016x501x1.020	1.100	881x445xh	45	50x150	143
1475KXL7PJJWT	0182862	1	1.016x501x1.020	1.100	881x445xh	45	50x150	143
1475KXL7PSVTW	0186983	1	1.016x501x1.020	1.100	881x445xh	45	50x150	143



1475KXL12TSS

TOOL TROLLEYS



- 12 drawer extra large capacity trolley with stainless steel top
- Lock & Go! latching system prevents drawers opening when moving the trolley
- Long ball bearing slides with 100% opening drawers
- Scratch resistant paint
- Extra large capacity heavy duty construction trolley
- Double wall frame protects the slides and drawers from shocks/crashes
- Reinforced areas to reduce stress in specific points of the trolley
- Strong and secure round type key and central locking mechanism
- Wheels of 150 x 50 mm with ball bearings and non-marking rubber surface
 - 2 fixed
 - 2 swivel with brake
- Drawers internal dimensions:
 - (1 x) 881 x 445 x 53 mm
- Left side drawers:
 - (4 x) 284 x 445 x 53 mm
 - (1 x) 284 x 445 x 118 mm
 - (1 x) 284 x 445 x 184 mm
- Right side drawers:
 - (2 x) 540 x 445 x 53 mm
 - (2 x) 540 x 445 x 118 mm
 - (1 x) 540 x 445 x 184 mm

	731415		mm	Kg	mm	Kg	mm	kg
1475KXL12PCMTSS	0182886	1	1.016x501x1.020	1.100	-	45	50x150	148
1475KXL12PCTSS	0182879	1	1.016x501x1.020	1.100	-	45	50x150	148
1475KXL12PDGTSS	0183340	1	1.016x501x1.020	1.100	-	45	50x150	148
1475KXL12PEVTSS	0182893	1	1.016x501x1.020	1.100	-	45	50x150	148
1475KXL12PJJTSS	0182916	1	1.016x501x1.020	1.100	-	45	50x150	148
1475KXL12PSPTSS	0183395	1	1.016x501x1.020	1.100	-	45	50x150	148
1475KXL12PSVTSS	0186990	1	1.016x501x1.020	1.100	-	45	50x150	148



1470K5

TOOL TROLLEYS



- 5 drawer trolley
- Large capacity heavy duty construction trolley
- Double wall frame protects the slides and drawers from shocks/crashes
- Reinforced areas to reduce stress in specific points of the trolley
- Long ball bearing slides with 100% opening drawers
- Click/detent closing system of drawers
- Strong and secure round type key and central locking mechanism
- Wheels of 125 x 30 mm with ball bearings and non-marking rubber surface
 - 2 fixed
 - 2 swivel with brake
- Drawers internal dimensions:
 - (1 x) 543 x 445 x 53 mm
 - (2 x) 543 x 445 x 118 mm
 - (2 x) 543 x 445 x 184 mm



1470K5	731415	1	677x 501 x 950 mm	600 Kg	543 x 445 x h mm	30 Kg	30 x 125 mm	62 kg



1470K6

TOOL TROLLEYS



- 6 drawer trolley
- Large capacity heavy duty construction trolley
- Double wall frame protects the slides and drawers from shocks/crashes
- Reinforced areas to reduce stress in specific points of the trolley
- Long ball bearing slides with 100% opening drawers
- Click/detent closing system of drawers
- Strong and secure round type key and central locking mechanism
- Wheels of 125 x 30 mm with ball bearings and non-marking rubber surface
 - 2 fixed
 - 2 swivel with brake
- Drawers internal dimensions:
 - (3 x) 543 x 445 x 53 mm
 - (2 x) 543 x 445 x 118 mm
 - (1 x) 543 x 445 x 249 mm



1470K6	731415	1	677 x 501 x 950 mm	600 Kg	543 x 445 x h mm	30 Kg	30 x 125 mm	66 kg



1470K7

TOOL TROLLEYS



- 7 drawer trolley
- Large capacity heavy duty construction trolley
- Double wall frame protects the slides and drawers from shocks/crashes
- Reinforced areas to reduce stress in specific points of the trolley
- Long ball bearing slides with 100% opening drawers
- Click/detent closing system of drawers
- Strong and secure round type key and central locking mechanism
- Wheels of 125 x 30 mm with ball bearings and non-marking rubber surface
 - 2 fixed
 - 2 swivel with brake
- Drawers internal dimensions:
 - (5 x) 543 x 445 x 53 mm
 - (1 x) 543 x 445 x 118 mm
 - (1 x) 543 x 445 x 249 mm



1470K7	731415	1	677x 501 x 950 mm	600 Kg	543 x 445 mm	30 Kg	30x125 mm	68 kg



1480K4

TOOL TROLLEYS



- 4 drawer top chest
- Large capacity heavy duty construction top chest
- Double wall frame protects the slides and drawers from shocks/crashes
- Reinforced areas to reduce stress in specific points of the top chest
- Long ball bearing slides with 100% opening drawers
- Click/detent closing system of drawers
- Strong and secure round type key and central locking mechanism
- Drawers internal dimensions:
 - (3 x) 543 x 445 x 53 mm
 - (1 x) 543 x 445 x 118 mm

1480K4	0136155	1	677 x 501 x 420	300	543 x 445 x h	30	-	40

3395L

TOOL TROLLEYS



- 8 drawer trolley
- Finish: Baked enamel
- Reinforced areas to reduce stress in specific points of the trolley
- Collapsible side table with rubber cover as additional storage surface as well as working area
- Long ball bearing slides with 100% opening drawers
- Click/detent closing system of drawers
- Strong and secure key and central locking mechanism
- Wheels of 100 x 25 mm with ball bearings and non-marking rubber outsurface
 - 2 fixed
 - 2 swivel with brake
- Drawers internal dimensions (not modular)
 - (6 x) 570 x 400 x 60 mm
 - (2 x) 570 x 400 x 133 mm

3395L	1810023	1	674x450x975	600	570 x 400 x h	30	25x100	64







6M/T3/5

TOOL MODULES



- Fit all Bahco tool trolleys
- Modular system: T3
- Environmentally friendly foams, complying with EU requirements
- Resistant to skydrol, petrol, diesel and water
- 2 colour tool control system helps to identify missing items
- /E: Empty inlay

	 731415		 mm	 g
6M/T3/5	0136384	1	261x87	350
6M-SBS10/T3/E	0136919	1	261x87	18

6M
6-7 8-9 10-11 12-13 14-15 mm







6M/T12/7

TOOL MODULES



- Fit all Bahco tool trolleys
- Modular system: T12
- Environmentally friendly foams, complying with EU requirements
- Resistant to skydrol, petrol, diesel and water
- 2 colour tool control system helps to identify missing items
- /E: Empty inlay

	 731415		 mm	 g
6M/T12/7	0136391	1	348x261	2260
6M/T12/E	0136926	1	348x261	72

6M
16-17 18-19 20-22 21-23 24-27 25-28 30-32 mm





SBS10/T3/5



TOOL MODULES

- Fit all Bahco tool trolleys
- Modular system: T3
- Environmentally friendly foams, complying with EU requirements
- Resistant to skydrol, petrol, diesel and water
- 2 colour tool control system helps to identify missing items
- /E: Empty inlay

	 731415		 mm	 g
SBS10/T3/5	0136407	1	261x87	385
6M-SBS10/T3/E	0136919	1	261x87	18

SBS10
6-7 8-9 10-11 12-13 14-15 mm



SBS10/T12/6



TOOL MODULES

- Fit all Bahco tool trolleys
- Modular system: T12
- Environmentally friendly foams, complying with EU requirements
- Resistant to skydrol, petrol, diesel and water
- 2 colour tool control system helps to identify missing items
- /E: Empty inlay

	 731415		 mm	 g
SBS10/T12/6	0136414	1	348x261	1880
SBS10/T12/E	0136933	1	348x261	72

SBS10
16-17 18-19 20-22 21-23 24-27 30-32 mm





111M/T4/8

TOOL MODULES



- Fit all Bahco tool trolleys
- Modular system: T4
- Environmentally friendly foams, complying with EU requirements
- Resistant to skydrol, petrol, diesel and water
- 2 colour tool control system helps to identify missing items
- /E: Empty inlay

	 731415		 mm	 g
111M/T4/8	0190287	1	174x174	445
111M-S20/T4/E	0190225	1	174x174	25

111M
6, 7, 8, 9, 10, 11, 12, 13 mm



111M/T6/7

TOOL MODULES



- Fit all Bahco tool trolleys
- Modular system: T6
- Environmentally friendly foams, complying with EU requirements
- Resistant to skydrol, petrol, diesel and water
- 2 colour tool control system helps to identify missing items
- /E: Empty inlay

	 731415		 mm	 g
111M/T6/7	0190270	1	174x261	1165

111M
14, 15, 16, 17, 18, 19, 20 mm





111M/T15/6

TOOL MODULES



- Fit all Bahco tool trolleys
- Modular system: T15
- Environmentally friendly foams, complying with EU requirements
- Resistant to skydrol, petrol, diesel and water
- 2 colour tool control system helps to identify missing items
- /E: Empty inlay

	 731415		 mm	 g
111M/T15/6	0136445	1	435x261	2715
111M-S20/T15/E	0190249	1	435x261	90

111M
21, 22, 24, 27, 30, 32 mm



SBS20/T4/8

TOOL MODULES



- Fit all Bahco tool trolleys
- Modular system: T4
- Environmentally friendly foams, complying with EU requirements
- Resistant to skydrol, petrol, diesel and water
- 2 colour tool control system helps to identify missing items
- /E: empty inlay

	 731415		 mm	 g
SBS20/T4/8	0190294	1	174x174	445
111M-S20/T4/E	0190225	1	174x174	25

SBS20
6, 7, 8, 9, 10, 11, 12, 13 mm









SBS20/T6/7

TOOL MODULES



- Fit all Bahco tool trolleys
- Modular system: T6
- Environmentally friendly foams, complying with EU requirements
- Resistant to skydrol, petrol, diesel and water
- 2 colour tool control system helps to identify missing items
- /E: Empty inlay

	 731415		 mm	 g
SBS20/T6/7	0190300	1	174x261	1165
111M-S20/T6/E	0190232	1	174x261	35

SBS20
14, 15, 16, 17, 18, 19, 20 mm







SBS20/T15/6

TOOL MODULES



- Fit all Bahco tool trolleys
- Modular system: T15
- Environmentally friendly foams, complying with EU requirements
- Resistant to skydrol, petrol, diesel and water
- 2 colour tool control system helps to identify missing items
- /E: Empty inlay

	 731415		 mm	 g
SBS20/T15/6	0136476	1	435x261	2815
111M-S20/T15/E	0190249	1	435x261	90

SBS20
21, 22, 24, 27, 30, 32 mm





1RM/T2/4



TOOL MODULES

- Fit all Bahco tool trolleys
- Modular system: T2
- Environmentally friendly foams, complying with EU requirements
- Resistant to skydrol, petrol, diesel and water
- 2 colour tool control system helps to identify missing items
- /E: Empty inlay

	 731415		 mm	 g
1RM/T2/4	0136513	1	174x87	255
1RM/T2/E	0136971	1	147x87	12

1RM
8, 9, 10, 11 mm



1RM/T6/8



TOOL MODULES

- Fit all Bahco tool trolleys
- Modular system: T6
- Environmentally friendly foams, complying with EU requirements
- Resistant to skydrol, petrol, diesel and water
- 2 colour tool control system helps to identify missing items
- /E: Empty inlay

	 731415		 mm	 g
1RM/T6/8	0136520	1	174x261	1285
1RM/T6/E	0136988	1	174x261	35

1RM
12, 13, 14, 15, 16, 17, 18, 19 mm









2M/T8/7



TOOL MODULES

- Fit all Bahco tool trolleys
- Modular system: T8
- Environmentally friendly foams, complying with EU requirements
- Resistant to skydrol, petrol, diesel and water
- 2 colour tool control system helps to identify missing items
- /E: Empty inlay

	 731415		 mm	 g
2M/T8/7	0136537	1	348x174	1110
2M-SBS30/T8/E	0136995	1	348x174	48

2M
6-7 8-9 10-11 12-13 14-15 16-17 18-19 mm







2M/T10/5



TOOL MODULES

- Fit all Bahco tool trolleys
- Modular system: T10
- Environmentally friendly foams, complying with EU requirements
- Resistant to skydrol, petrol, diesel and water
- 2 colour tool control system helps to identify missing items
- /E: Empty inlay

	 731415		 mm	 g
2M/T10/5	0136544	1	435x174	2520
2M/T10/E	0137008	1	435x174	60

2M
20-22 21-23 24-27 25-28 30-32 mm





SBS30/T8/7

TOOL MODULES



- Fit all Bahco tool trolleys
- Modular system: T8
- Environmentally friendly foams, complying with EU requirements
- Resistant to skydrol, petrol, diesel and water
- 2 colour tool control system helps to identify missing items
- /E: Empty inlay

	 731415		 mm	 g
SBS30/T8/7	0136551	1	348x174	1095
2M-SBS30/T8/E	0136995	1	348x174	48

SBS30
6-7 8-9 10-11 12-13 14-15 16-17 18-19 mm



SBS30/T10/4

TOOL MODULES



- Fit all Bahco tool trolleys
- Modular system: T10
- Environmentally friendly foams, complying with EU requirements
- Resistant to skydrol, petrol, diesel and water
- 2 colour tool control system helps to identify missing items
- /E: Empty inlay

	 731415		 mm	 g
SBS30/T10/4	0136568	1	435x174	2055
SBS30/T10/E	0137015	1	435x174	60

SBS30
20-22 21-23 24-27 30-32 mm





28M/T15/13

TOOL MODULES



- Fit all Bahco tool trolleys
- Modular system: T15
- Environmentally friendly foams, complying with EU requirements
- Resistant to skydrol, petrol, diesel and water
- 2 colour tool control system helps to identify missing items
- /E: Empty inlay

	 731415		 mm	 g
28M/T15/13	0178537	1	435x261	2500
28M/T15/E	0178513	1	435x261	90

28M
7, 8, 9, 10, 11, 12, 13, 14, 15, 16, 17, 18, 19 mm



28M/T20/6

TOOL MODULES



- Fit all Bahco tool trolleys
- Modular system: T20
- Environmentally friendly foams, complying with EU requirements
- Resistant to skydrol, petrol, diesel and water
- 2 colour tool control system helps to identify missing items
- /E: Empty inlay

	 731415		 mm	 g
28M/T20/6	0178544	1	435x348	5200
28M/T20/E	0178520	1	435x348	120

28M
22, 23, 24, 27, 30, 32 mm





29M/T15/13

TOOL MODULES



- Fit all Bahco tool trolleys
- Modular system: T15
- Environmentally friendly foams, complying with EU requirements
- Resistant to skydrol, petrol, diesel and water
- 2 colour tool control system helps to identify missing items
- /E: Empty inlay

	 731415		 mm	 g
29M/T15/13	0178551	1	435x261	2500
28M/T15/E	0178513	1	435x261	90

29M
7, 8, 9, 10, 11, 12, 13, 14, 15, 16, 17, 18, 19 mm



29M/T20/6

TOOL MODULES



- Fit all Bahco tool trolleys
- Modular system: T20
- Environmentally friendly foams, complying with EU requirements
- Resistant to skydrol, petrol, diesel and water
- 2 colour tool control system helps to identify missing items
- /E: Empty inlay

	 731415		 mm	 g
29M/T20/6	0178568	1	435x348	5200
28M/T20/E	0178520	1	435x348	120

29M
22, 23, 24, 27, 30, 32 mm





4040M/T12/8

TOOL MODULES



- Fit all Bahco tool trolleys
- Modular system: T12
- Environmentally friendly foams, complying with EU requirements
- Resistant to skydrol, petrol, diesel and water
- 2 colour tool control system helps to identify missing items
- /E: Empty inlay

	 731415		 mm	 g
4040M/T12/8	0136575	1	348x261	2195
4040M-SBS50/T12/E	0137022	1	348x261	72

4040M
8-9 10-11 12-13 14-15 16-17 18-19 20-22 21-23 mm



SBS50/T12/8

TOOL MODULES



- Fit all Bahco tool trolleys
- Modular system: T12
- Environmentally friendly foams, complying with EU requirements
- Resistant to skydrol, petrol, diesel and water
- 2 colour tool control system helps to identify missing items
- /E: Empty inlay

	 731415		 mm	 g
SBS50/T12/8	0136582	1	348x261	2245
4040M-SBS50/T12/E	0137022	1	348x261	72

SBS50
8-9 10-11 12-13 14-15 16-17 18-19 20-22 21-23 mm





7800SM/T12/26



TOOL MODULES

- Fit all Bahco tool trolleys
- Modular system: T12
- Environmentally friendly foams, complying with EU requirements
- Resistant to skydrol, petrol, diesel and water
- 2 colour tool control system helps to identify missing items
- /E: Empty inlay

	 731415		 mm	 g
7800SM/T12/26	0136599	1	348x261	2220
7800SM/T12/E	0137039	1	348x261	72

7800SM

8, 9, 10, 11, 12, 13, 14, 15,
16, 17, 18, 19, 21, 22, 23,
24, 26, 27, 28, 30, 32 mm



8154-1/2
283 mm



8155-1/2



8166-1/2



8160-1/2 & 8162-1/2
125 mm & 250 mm



7800DM/T12/27



TOOL MODULES

- Fit all Bahco tool trolleys
- Modular system: T12
- Environmentally friendly foams, complying with EU requirements
- Resistant to skydrol, petrol, diesel and water
- 2 colour tool control system helps to identify missing items
- /E: Empty inlay

	 731415		 mm	 g
7800DM/T12/27	0136605	1	348x261	4280
7800DM/T12/E	0137046	1	348x261	72

7800DM

8, 9, 10, 12, 13, 14, 15, 16,
17, 18, 19, 20, 21, 22, 23, 24,
26, 27, 28, 30, 31, 32 mm



8154-1/2
283 mm



8155-1/2



8166-1/2



8160-1/2 & 8162-1/2
125 mm & 250 mm





SBS80/T20/29



TOOL MODULES

- Fit all Bahco tool trolleys
- Modular system: T20
- Environmentally friendly foams, complying with EU requirements
- Resistant to skydrol, petrol, diesel and water
- 2 colour tool control system helps to identify missing items
- /E: Empty inlay

	 731415		 mm	 g
SBS80/T20/29	0136612	1	435x348	5585
SBS80/T20/E	0137053	1	435x348	120

SBS80
8, 9, 10, 12, 13, 14, 15, 16,
17, 18, 19, 21, 22, 23, 24,
25, 26, 27, 30, 32 mm



SBS85
1/2"



SBS81
1/2"



SBS87S & SBS87
257 mm & 390 mm



SBS83
3 (75 mm), 5 (125 mm),
10 (250 mm)



SBS88 & SBS89
1/2"-3/8" & 1/2"-3/4"



SBS86
1/2" - 283 mm



7805DM/T6/6



TOOL MODULES

- Fit all Bahco tool trolleys
- Modular system: T6
- Environmentally friendly foams, complying with EU requirements
- Resistant to skydrol, petrol, diesel and water
- 2 colour tool control system helps to identify missing items
- /E: Empty inlay

	 731415		 mm	 g
7805DM/T6/6	0165995	1	174x261	1010
7805DM/T6/6/E	0166008	1	174x261	35

7805DM
10, 12, 13, 17, 19 mm



1419-MD
150 mm





TOOL STORAGE

6700SM/T4/19

TOOL MODULES



- Fit all Bahco tool trolleys
- Modular system: T4
- Environmentally friendly foams, complying with EU requirements
- Resistant to skydrol, petrol, diesel and water
- 2 colour tool control system helps to identify missing items
- /E: Empty inlay

	 731415		 mm	 g
6700SM/T4/19	0136629	1	174x174	665
6700SM/T4/E	0137060	1	174x174	25
6700SM 4, 4.5, 5, 5.5, 6, 7, 8, 9, 10, 11, 12, 13, 14 mm			6954 1/4" - 115 mm	
6950 1/4"			6966 1/4"	
6960 & 6962 50 mm & 150 mm			6956 1/4"	

SBS60/T4/21

TOOL MODULES



- Fit all Bahco tool trolleys
- Modular system: T4
- Environmentally friendly foams, complying with EU requirements
- Resistant to skydrol, petrol, diesel and water
- 2 colour tool control system helps to identify missing items
- /E: Empty inlay

	 731415		 mm	 g
SBS60/T4/21	0136636	1	174x174	790
SBS60/T4/E	0137077	1	174x174	25
SBS60 4, 4.5, 5, 5.5, 6, 7, 8, 9, 10, 11, 12, 13, 14 mm			SBS65 1/4"	
SBS61 1/4"			SBS63-2 & SBS63-4 & SBS63-6 50 mm & 100 mm & 150 mm	
SBS67 1/4"			SBS69 1/4" - 3/8"	
SBS64 1/4" - 125 mm				



7400SM/T8/23



TOOL MODULES

- Fit all Bahco tool trolleys
- Modular system: T8
- Environmentally friendly foams, complying with EU requirements
- Resistant to skydrol, petrol, diesel and water
- 2 colour tool control system helps to identify missing items
- /E: Empty inlay

	 731415		 mm	 g
7400SM/T8/23	0136643	1	348x174	1700
7400SM/T8/E	0137084	1	348x174	48

7400SM 6, 7, 8, 9, 10, 12, 13, 14, 15, 16, 17, 18, 19, 20, 21, 22 mm		7760 & 7761 & 7762 75 mm & 125 mm & 250 mm	
7755-3/8		7754 3/8" - 160 mm	
7766 3/8"			

SBSF/T8/23



TOOL MODULES

- Fit all Bahco tool trolleys
- Modular system: T8
- Environmentally friendly foams, complying with EU requirements
- Resistant to skydrol, petrol, diesel and water
- 2 colour tool control system helps to identify missing items
- /E: Empty inlay

	 731415		 mm	 g
SBSF/T8/23	0136650	1	348x174	1865
SBSF/T8/E	0137091	1	348x174	48

SBSF 6, 7, 8, 9, 10, 11, 12, 13, 14, 15, 16, 17, 18, 19 mm		SBS775 3/8"	
SBS750 3/8"		SBS723 & SBS724 3/8"-1/4" & 3/8"-1/2"	
SBS760 & SBS761 & SBS762 75 mm & 125 mm & 250 mm		SBS705 3/8"	
SBS755 3/8" - 160 mm			



TOOL STORAGE

BE009/T10/9



TOOL MODULES

- Fit all Bahco tool trolleys
- Modular system: T10
- Environmentally friendly foams, complying with EU requirements
- Resistant to skydrol, petrol, diesel and water
- 2 colour tool control system helps to identify missing items
- /E: Empty inlay

	 731415		 mm	 g
BE009/T10/9	0136667	1	435x174	820
BE009/T10/E	0137107	1	435x174	60

BE-8020L & BE-8040 &
BE-8150 & BE-8255 &
BE-8256
3x75 mm & 4x100 mm &
5.5x100 mm & 6.5x150 mm
& 8x150 mm



BE-8610 & BE-8620
PH 1x75 mm &
PH 2x100 mm



BE-8340
4x25 mm



BE-8601
PH 1x25 mm



800S/T10/9



TOOL MODULES

- Fit all Bahco tool trolleys
- Modular system: T10
- Environmentally friendly foams, complying with EU requirements
- Resistant to skydrol, petrol, diesel and water
- 2 colour tool control system helps to identify missing items
- /E: Empty inlay

	 731415		 mm	 g
800S/T10/9	0136674	1	435x174	820
800S/T10/E	0137114	1	435x174	60

811-5.5-100 & 811-6.5-125 &
811-8-150
5.5x150 mm & 6.5x125 mm &
8x150 mm



815-1-25
PH 1x25 mm



813-3-75 & 813-4-100
3.0x75 mm & 4.0x100 mm



811-5.5-25
5.5x25 mm



815-1-100 & 811-2-125
PH 1x100 mm & PH 2x125 mm





600S/T10/9



TOOL MODULES

- Fit all Bahco tool trolleys
- Modular system: T10
- Environmentally friendly foams, complying with EU requirements
- Resistant to skydrol, petrol, diesel and water
- 2 colour tool control system helps to identify missing items
- /E: Empty inlay

	 731415		 mm	 g
600S/T10/9	0136681	1	435x174	815
600S/T10/E	0137121	1	435x174	60

613-3-75
3x75 mm



611-4-100 & 611-5.5-100 & 611-6.5-150 & 611-8-150
4x100 mm & 5.5x100 mm & 6.5x150 mm & 8x150 mm



611-6.5-25
6.5x25 mm



615-1-100 & 615-2-125
PH 1x100 mm & PH 2x125 mm



615-2-25
PH 2x25 mm



BE009/T6/7



TOOL MODULES

- Fit all Bahco tool trolleys
- Modular system: T6
- Environmentally friendly foams, complying with EU requirements
- Resistant to skydrol, petrol, diesel and water
- 2 colour tool control system helps to identify missing items
- /E: Empty inlay

	 731415		 mm	 g
BE009/T6/7	0136698	1	174x261	430
BE009/T6/E	0137138	1	174x261	35

BE-8906 & BE-8907 & BE-8908 & BE-8909 &
BE-8910 & BE-8915 & BE-8920
T-6x75 mm & T-7x75 mm & T-8x75 mm & T-9x75 mm &
T-10x75 mm & T-15x100 mm & T-20x100 mm





BE009/T8/5

TOOL MODULES



- Fit all Bahco tool trolleys
- Modular system: T8
- Environmentally friendly foams, complying with EU requirements
- Resistant to skydrol, petrol, diesel and water
- 2 colour tool control system helps to identify missing items
- /E: Empty inlay

	 731415		 mm	 g
BE009/T8/5	0136704	1	348x174	790
BE009/T8/E	0137145	1	348x174	48

BE-8925 & BE-8927 & BE-8930 & BE-8940 & BE-8945
T-25x125 mm & T-27x125 mm & T-30x150 mm & T-40x150 mm & T-45x150 mm



800S/T8/9

TOOL MODULES



- Fit all Bahco tool trolleys
- Modular system: T8
- Environmentally friendly foams, complying with EU requirements
- Resistant to skydrol, petrol, diesel and water
- 2 colour tool control system helps to identify missing items
- /E: Empty inlay

	 731415		 mm	 g
800S/T8/9	0136711	1	348x174	645
800S/T8/E	0137152	1	348x174	48

818-6-75 & 818-7-75 & 818-8-75 & 818-9-75 & 818-10-75 & 818-15-100 & 818-20-100 & 818-25-125 & 818-30-150
T-6x75 mm & T-7x75 mm & T-8x75 mm & T-9x75 mm & T-10x75 mm & T-15x100 mm & T-20x100 mm & T-25x125 mm & T-30x150 mm





BE009/T12/8

TOOL MODULES



- Fit all Bahco tool trolleys
- Modular system: T12
- Environmentally friendly foams, complying with EU requirements
- Resistant to skydrol, petrol, diesel and water
- 2 colour tool control system helps to identify missing items
- /E: Empty inlay

	 731415		 mm	 g
BE009/T12/8	0136728	1	348x261	1140
BE009/T12/E	0137169	1	348x261	72

BE-8702 & BE-8703 & BE-8704 & BE-8705 & BE-8706 & BE-8708 & BE-8710 & BE-8725
 2x100 mm, 3x100 mm, 4x100 mm, 5x100 mm, 6x125 mm, 8x150 mm, 10x150 mm, 2.5x100 mm



BE78/T10/8

TOOL MODULES



- Fit all Bahco tool trolleys
- Modular system: T10
- Environmentally friendly foams, complying with EU requirements
- Resistant to skydrol, petrol, diesel and water
- 2 colour tool control system helps to identify missing items
- /E: Empty inlay

	 731415		 mm	 g
BE78/T10/8	0136834	1	435x174	985
BE78/T10/E	0137251	1	435x174	60

BE-7845 & BE-7805 & BE-7855 & BE-7806 & BE-7807 & BE-7808 & BE-7809 & BE-7810
 4.5 mm & 5 mm & 5.5 mm & 6 mm & 7 mm & 8 mm & 9 mm & 10 mm





900T/T18/8

TOOL MODULES



- Fit all Bahco tool trolleys
- Modular system: T18
- Environmentally friendly foams, complying with EU requirements
- Resistant to skydrol, petrol, diesel and water
- 2 colour tool control system helps to identify missing items
- /E: Empty inlay

	 731415		 mm	 g
900T/T18/8	0136735	1	522x261	960
900T/T18/E	0137176	1	522x261	108

900T
2x100 mm & 2.5x100 mm & 3x100 mm & 4x150 mm &
5x150 mm & 6x200 mm & 8x200 mm & 10x200 mm



901T/T18/7

TOOL MODULES



- Fit all Bahco tool trolleys
- Modular system: T18
- Environmentally friendly foams, complying with EU requirements
- Resistant to skydrol, petrol, diesel and water
- 2 colour tool control system helps to identify missing items
- /E: Empty inlay

	 731415		 mm	 g
901T/T18/7	0136742	1	522x261	960
901T/T18/E	0137183	1	522x261	108

901T
T-10x100 mm, T-15x150 mm, T-20x150 mm, T-25x150 mm,
T-27x150 mm, T-30x200 mm, T-40x200 mm





EPCP/T8/4

TOOL MODULES

ergo®



- Fit all Bahco tool trolleys
- Modular system: T8
- Environmentally friendly foams, complying with EU requirements
- Resistant to skydrol, petrol, diesel and water
- 2 colour tool control system helps to identify missing items
- /E: Empty inlay

	 731415		 mm	 g
EPCP/T8/4	0136759	1	348x174	1110
EPCP-P/T8/E	0137190	1	348x174	48

2101GC
160 mm



2430GC
160 mm



2628GC
180 mm



8224C
250 mm



EPP/T8/4

TOOL MODULES

ergo®



- Fit all Bahco tool trolleys
- Modular system: T8
- Environmentally friendly foams, complying with EU requirements
- Resistant to skydrol, petrol, diesel and water
- 2 colour tool control system helps to identify missing items
- /E: Empty inlay

	 731415		 mm	 g
EPP/T8/4	0136766	1	348x174	1135
EPCP-P/T8/E	0137190	1	348x174	48

2101G
160 mm



2430G
160 mm



2628G
180 mm



8224
250 mm





2800-2900/T8/4



TOOL MODULES

- Fit all Bahco tool trolleys
- Modular system: T8
- Environmentally friendly foams, complying with EU requirements
- Resistant to skydrol, petrol, diesel and water
- 2 colour tool control system helps to identify missing items
- /E: Empty inlay

	 731415		 mm	 g
2800-2900/T8/4	0136780	1	348x174	875
2800-2900/T8/E	0137206	1	348x174	48

2800-180
19-60 mm



2900-180
19-60 mm



2890-180
19-60 mm



2990-180
19-60 mm



9938/T8/6



TOOL MODULES

- Fit all Bahco tool trolleys
- Modular system: T8
- Environmentally friendly foams, complying with EU requirements
- Resistant to skydrol, petrol, diesel and water
- 2 colour tool control system helps to identify missing items
- /E: Empty inlay

	 731415		 mm	 g
9938/T8/6	0167296	1	348x174	920
9938/T8/E	0167302	1	348x174	48

2928
160, 200, 250 mm





7809T-2/T2/6

TOOL MODULES



- Fit all Bahco tool trolleys
- Modular system: T2
- Environmentally friendly foams, complying with EU requirements
- Resistant to skydrol, petrol, diesel and water
- 2 colour tool control system helps to identify missing items
- /E: Empty inlay

	 731415		 mm	 g
7809T-2/T2/6	0165971	1	174x87	450
7809T-2/T2/6/E	0165988	1	174x87	12

7809TORX
T-25, T-30, T-40, T-45, T-50, T-55



7809T/T3/9

TOOL MODULES



- Fit all Bahco tool trolleys
- Modular system: T3
- Environmentally friendly foams, complying with EU requirements
- Resistant to skydrol, petrol, diesel and water
- 2 colour tool control system helps to identify missing items
- /E: Empty inlay

	 731415		 mm	 g
7809T/T3/9	0136797	1	261x87	765
7809T/T3/E	0137213	1	261x87	18

7809TORX
T-20, T-25, T-27, T-30, T-40, T-45, T-50, T-55, T-60





7809M/T8/15



TOOL MODULES

- Fit all Bahco tool trolleys
- Modular system: T8
- Environmentally friendly foams, complying with EU requirements
- Resistant to skydrol, petrol, diesel and water
- 2 colour tool control system helps to identify missing items
- /E: Empty inlay

	 731415		 mm	 g
7809M/T8/15	0136803	1	348x174	1735
7809M/T8/E	0137220	1	348x174	48
7809M 5,5L, 6,6L, 7,7L, 8,8L, 9, 10, 10L, 12, 14, 17, 19 mm				

EF-1/T8/5



TOOL MODULES

- Fit all Bahco tool trolleys
- Modular system: T8
- Environmentally friendly foams, complying with EU requirements
- Resistant to skydrol, petrol, diesel and water
- 2 colour tool control system helps to identify missing items
- /E: Empty inlay

	 731415		 mm	 g
EF-1/T8/5	0136810	1	348x174	1030
EF-1/T8/E	0137237	1	348x174	48

1-100-08-1-2			1-230-08-1-2		
1-160-08-1-2			1-170-08-2-2		
1-210-08-1-2					



MIX-H/T15/10



TOOL MODULES

- Fit all Bahco tool trolleys
- Modular system: T15
- Environmentally friendly foams, complying with EU requirements
- Resistant to skydrol, petrol, diesel and water
- 2 colour tool control system helps to identify missing items
- /E: Empty inlay

	 731415		 mm	 g
MIX-H/T15/10	0136827	1	435x261	2065
MIX-H/T15/E	0137244	1	435x261	90

481-400		3734 2, 3, 4, 5, 6, 8 mm x 150 mm	
3625N-35		3735-5-120 5 mm	
		3740-175 175 mm	

ADJP/T10/4



TOOL MODULES

- Fit all Bahco tool trolleys
- Modular system: T10
- Environmentally friendly foams, complying with EU requirements
- Resistant to skydrol, petrol, diesel and water
- 2 colour tool control system helps to identify missing items
- /E: Empty inlay

	 731415		 mm	 g
ADJP/T10/4	0165926	1	435x174	1590
ADJP/T10/4/E	0165933	1	435x174	60

141 280 mm		9031 218x38 mm	
8070 155x20 mm		9072P 257x33 mm	



8224-9072P/T6/2



TOOL MODULES

- Fit all Bahco tool trolleys
- Modular system: T6
- Environmentally friendly foams, complying with EU requirements
- Resistant to skydrol, petrol, diesel and water
- 2 colour tool control system helps to identify missing items
- /E: Empty inlay

	 731415		 mm	 g
8224-9072P/T6/2	0136841	1	174x261	990
8224-9072/T6/E	0137268	1	174x261	48

8224
250 mm



9072P
257x33 mm



8224C-9072C/T6/2



TOOL MODULES

- Fit all Bahco tool trolleys
- Modular system: T6
- Environmentally friendly foams, complying with EU requirements
- Resistant to skydrol, petrol, diesel and water
- 2 colour tool control system helps to identify missing items
- /E: Empty inlay

	 731415		 mm	 g
8224C-9072C/T6/2	0136858	1	174x261	800
8224-9072/T6/E	0137268	1	174x261	48

8224C
250 mm



9072C
257x31 mm





2951/T8/3

TOOL MODULES



- Fit all Bahco tool trolleys
- Modular system: T8
- Environmentally friendly foams, complying with EU requirements
- Resistant to skydrol, petrol, diesel and water
- 2 colour tool control system helps to identify missing items
- /E: Empty inlay

	 731415		 mm	 g
2951/T8/3	0136865	1	348x174	1660
2951/T8/E	0137275	1	348x174	48

3625N-35



2951-180 & 2951-250



MSR/T6/4

TOOL MODULES



- Fit all Bahco tool trolleys
- Modular system: T6
- Environmentally friendly foams, complying with EU requirements
- Resistant to skydrol, petrol, diesel and water
- 2 colour tool control system helps to identify missing items
- /E: Empty inlay

	 731415		 mm	 g
MSR/T6/4	0136872	1	174x261	745
MSR/T6/E	0137282	1	174x261	35

MTB-5-25
5 m x 25 mm



1547
0.05-1.0



1150D



8045LVDE
0.5x3.5x42 mm





2681-2635/T8/2



TOOL MODULES

- Fit all Bahco tool trolleys
- Modular system: T8
- Environmentally friendly foams, complying with EU requirements
- Resistant to skydrol, petrol, diesel and water
- 2 colour tool control system helps to identify missing items
- /E: Empty inlay

	 731415		 mm	 g
2681-2635/T8/2	0136889	1	348x174	1400
2681-2635/T8/E	0137299	1	348x174	48

2681
285 mm



2635
260 mm



CTTG/T15/5



TOOL MODULES

- Fit all Bahco tool trolleys
- Modular system: T15
- Environmentally friendly foams, complying with EU requirements
- Resistant to skydrol, petrol, diesel and water
- 2 colour tool control system helps to identify missing items
- /E: Empty inlay

	 731415		 mm	 g
CTTG/T15/5	0136896	1	435x261	1460
CTTG/T15/E	0137305	1	435x261	90

SQZ15003



319
300 mm



SQZ150003-SBL
10 pcs



208
250 mm



FS-8
166 mm





MIX-C/T20/8

TOOL MODULES



- Fit all Bahco tool trolleys
- Modular system: T20
- Environmentally friendly foams, complying with EU requirements
- Resistant to skydrol, petrol, diesel and water
- 2 colour tool control system helps to identify missing items
- /E: Empty inlay

	 731415		 mm	 g
MIX-C/T20/8	0166701	1	435x348	1620
MIX-C/T20/8/E	0166718	1	435x348	120

MTB-5-25		2744	
2444		5515T	
2509		208	
268		319	

808050/T6/41

TOOL MODULES



- Fit all Bahco tool trolleys
- Modular system: T6
- Environmentally friendly foams, complying with EU requirements
- Resistant to skydrol, petrol, diesel and water
- 2 colour tool control system helps to identify missing items
- /E: Empty inlay

	 731415		 mm	 g
808050/T6/41	0136902	1	174x261	1025
808050/T6/E	0137312	1	174x261	35

808050 1/4"			
BE-9678 9 pcs		59/S31 31 pcs	



TOOL STORAGE

T2/E

TOOL MODULES



- Fit all Bahco tool trolleys
- Modular system: T2
- Environmentally friendly foams, complying with EU requirements
- Resistant to skydrol, petrol, diesel and water
- 1 compartment

	 731415		 mm	 g
T2/E	0137329	1	174x87	10

T3/E

TOOL MODULES



- Fit all Bahco tool trolleys
- Modular system: T3
- Environmentally friendly foams, complying with EU requirements
- Resistant to skydrol, petrol, diesel and water
- 7 compartments

	 731415		 mm	 g
T3/E	0137336	1	261x87	18

T4/E

TOOL MODULES



- Fit all Bahco tool trolleys
- Modular system: T4
- Environmentally friendly foams, complying with EU requirements
- Resistant to skydrol, petrol, diesel and water
- 3 compartments

	 731415		 mm	 g
T4/E	0137343	1	174x174	15



T6/E

TOOL MODULES



- Fit all Bahco tool trolleys
- Modular system: T6
- Environmentally friendly foams, complying with EU requirements
- Resistant to skydrol, petrol, diesel and water
- 3 compartments

	 731415		 mm	 g
T6/E	0137350	1	174x261	20

T8/E

TOOL MODULES



- Fit all Bahco tool trolleys
- Modular system: T8
- Environmentally friendly foams, complying with EU requirements
- Resistant to skydrol, petrol, diesel and water
- 2 compartments

	 731415		 mm	 g
T8/E	0137367	1	348x174	25

T10/E

TOOL MODULES



- Fit all Bahco tool trolleys
- Modular system: T10
- Environmentally friendly foams, complying with EU requirements
- Resistant to skydrol, petrol, diesel and water
- 7 compartments

	 731415		 mm	 g
T10/E	0137374	1	435x174	10

TVAB/THAB

TOOL MODULES



- Space adaptors for Bahco 1470K/75K/80K series tool trolleys
- TVAB: Vertical and THAB: horizontal
- Environmentally friendly foams, complying with EU requirements
- Resistant to skydrol, petrol, diesel and water

	 731415		 mm	 g
THAB	0137398	1	519x9	5
TVAB	0137381	1	444x21	10



FCT71

TOOL MODULES



- Fit all Bahco tool trolleys
- Environmentally friendly foams, complying with EU requirements
- Resistant to skydrol, petrol, diesel and water
- 2 colour tool control system helps to identify missing items
- Includes empty modules; T2/E (2 pcs), adaptors; TVAB (3 pcs), THAB (3 pcs)

	 731415		 mm	 g
FCT71	0138821	1	250x800x600	20500

SBS20/T4/9 - SBS20/T6/6 - EPP/T8/4 - 2951/T8/3
T2/E (2x) - TVAB - THAB



SBS20/T15/6 - CTTG/T15/5
TVAB - THAB



800S/T10/9 - SBS80/T20/29
TVAB - THAB







FCT128

TOOL MODULES



- Fit all Bahco tool trolleys
- Environmentally friendly foams, complying with EU requirements
- Resistant to skydrol, petrol, diesel and water
- 2 colour tool control system helps to identify missing items
- Includes empty modules; T2/E (2 pcs) T3/E (1 pc), adaptors; TVAB (4 pcs), THAB (4 pcs)

	 731415		 mm	 g
FCT128	0138838	1	250x1200x800	25500

SBS20/T4/9 - SBS20/T6/6 - SBS80/T20/29
TVAB - THAB



SBS20/T15/6 - MSR/T6/4 - 808050/T6/41
T3/E - TVAB - THAB



CTTG/T15/5 - MIX-H/T15/10
TVAB - THAB



600S/T10/9 - EF-1/T8/5 - EPP/T8/4
T2/E (2x) - TVAB - THAB





FCT169

TOOL MODULES



- Fit all Bahco tool trolleys
- Environmentally friendly foams, complying with EU requirements
- Resistant to skydrol, petrol, diesel and water
- 2 colour tool control system helps to identify missing items
- Includes empty modules; T2/E (3 pcs), adaptors; TVAB (5 pcs), THAB (5 pcs)

	 731415		 mm	 g
FCT169	0138845	1	250x1200x800	35500

SBS20/T15/6 - SBS50/T12/8 - 7809T/T3/9
TVAB - THAB



808050/T6/41 - 2800-2900/T8/4 - EPP/T8/4 -
T2/E (2x) - TVAB - THAB



CTTG/T15/5 - MIX-H/T15/10
TVAB - THAB



SBS20/T4/9-SBS20/T6/6-SBS80/T2
TVAB - THAB



900T/T18/8 - 800S/T8/9
T2/E - TVAB - THAB







FCT238

TOOL MODULES



- Fit all Bahco tool trolleys
- Environmentally friendly foams, complying with EU requirements
- Resistant to skydrol, petrol, diesel and water
- 2 colour tool control system helps to identify missing items
- Includes empty modules; T2/E (1 pc), T3/E (1 pc), adaptors; TVAB (7 pcs), THAB (7 pcs)

	 731415		 mm	 g
FCT238	0138852	1	250x1200x800	35500

SBS20/T4/9 - SBS20/T6/6 - SBS80/T20/29
TVAB - THAB



CTTG/T15/5 - MIX-H/T15/10
TVAB - THAB



EF-1/T8/5 - 2681-2635/T8/2 - MSR/T6/4 - 808050/T6/41
T2/E - TVAB - THAB



900T/T18/8 - 800S/T8/9 - SBS60/T4/21
TVAB - THAB



SBS20/T15/6 - SBS10/T3/5 - SBS10/T12/6
TVAB - THAB



800S/T10/9 - SBS50/T12/8 - SBSF/T8/23
TVAB - THAB

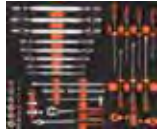

2800-2900/T8/4 - EPP/T8/4 - 7809M/T8/15 - 7809T/T3/9
T3/E - TVAB - THAB





1450L-SP/1450-L

MOBILE WORKBENCH



1450L-SP



1450L

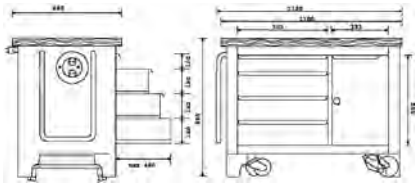

- 4 drawer and large cabinet mobile workbench with top wooden
- Working wooden top area 1100 x 660 mm
- Extra large capacity heavy duty construction mobile workbench
- Reinforced areas to reduce stress in specific points of the trolley
- 10 m cable reel with four side mounted Schuko plug sockets
- Long ball bearing slides with 100% opening drawers
- Strong and secure flat type key and central locking mechanism
- The foldable handle is part of the patented lifting mechanism for the wheel gear
- Retractable wheels of ball bearings and non-marking rubber surface
 - 2 fixed 125 x 35 mm
 - 2 swivel 100 x 35 mm
- Drawers internal dimensions:
 - (1 x) 495 x 570 x 90 mm
 - (3 x) 495 x 570 x 140 mm
- Cabinet internal dimensions: 450 x 570 x 640 mm
- Internal shelf 3-position height adjustment

	731415	1	mm	Kg	mm	Kg	mm	kg
1450L-SP	1847128	1	1100x660x830	2000	495x570xh	50	35x100 & 35x125	118
1450L	2001666	1	1100x660x830	2000	495x570xh	50	35x100 & 35x125	118







W120SL1

WORKBENCHES



- Workbench 1.20 m for all applications
- 1 drawer, 2 shelves
- Supplied as a kit and is quick and easy to assemble
- Material: Sheet metal
- Finish: All painted steel components (carcass and fronts) have been powder-coated with polyester epoxy resin
- Black panel, drawer trays and shelves are made of hot-dip galvanised sheet steel
- 2 sides, back panel, base, front and rear grid rails
- Drawer on roller guides (pull out 4/5)
- Worktop 1200 x 600 x 35 mm, high-strength beech multiplex board
- 15-ply laminated wood
- 2 keys, master key system

	 731415		 mm	 g
W120SL1	3013637	1	1200x800x525	42000

W120SL1-D1

WORKBENCHES



- Workbench 1.20 m for all applications
- 1 drawer, 1 hinged door, 2 shelves
- Supplied as a kit and is quick and easy to assemble
- Material: Sheet metal
- Finish: All painted steel components (carcass and fronts) have been powder-coated with polyester epoxy resin
- Black panel, drawer trays and shelves are made of hot-dip galvanised sheet steel
- Worktop: 1200 x 600 x 35 mm, high strength beech multiplex board
- 15-ply laminated wood
- 2 keys, master key system

	 731415		 mm	 g
W120SL1-D1	3013644	1	1200x800x525	44000



W120SL2-D2



WORKBENCHES

- Workbench 1.20 m for all applications
- 2 drawers 2 hinged door 2 shelves
- Supplied as a kit and is quick and easy to assemble
- Material: Sheet metal
- Finish: All painted steel components (carcass and fronts) have been powder-coated with polyester epoxy resin
- Black panel, drawer trays and shelves are made of hot-dip galvanised sheet steel
- Worktop: 1200 x 600 x 35 mm, high strength beech multiplex board
- 15-ply laminated wood
- 2 keys, master key system

	 731415		 mm	 g
W120SL2-D2	3013651	1	1200x800x525	49000

W180SL3



WORKBENCHES

- Workbench 1.80 m for all applications
- 3 drawers, 2 shelves
- Supplied as a kit and is quick and easy to assemble
- Material: All painted steel components (carcass and fronts) hve been powder-coated with polyester epoxy resin
- Black panel, drawer trays and sheves are made of hot-dip galvanised sheet steel
- Worktop 1800 x 600 x 35 mm, high strength beech multiplex board
- 15-ply laminated wood
- 2 keys, master key system

	 731415		 mm	 g
W180SL3	3013668	1	1800x800x600	65000





W180SL3-D1

WORKBENCHES



- Workbench 1.80 m for all applications
- 3 drawers 1 hinged door 2 shelves
- Supplied as a kit and is quick and easy to assemble
- Material: Sheet metal
- Finish: All painted steel components (carcass and fronts) have been powder-coated with polyester epoxy resin
- Black panel, drawer trays and shelves are made of hot-dip galvanised sheet steel
- Worktop 1800 x 600 x 35 mm, high strength beech multiplex board
- 15-ply laminated wood
- 2 keys, master key system

	 731415		 mm	 g
W180SL3-D1	3013675	1	1800x800x525	67000

W180SL2-D2

WORKBENCHES



- Workbench 1.80 m for all applications
- 2 drawers 2 hinged door 2 shelves
- Supplied as a kit and is quick and easy to assemble
- Material: Sheet metal
- Finish: All painted steel components (carcass and fronts) have been powder-coated with polyester epoxy resin
- Black panel, drawer trays and shelves are made of hot-dip galvanised sheet steel
- Worktop 1800 x 600 x 35 mm, high strength beech multiplex board
- 15-ply laminated wood
- 2 keys, master key system

	 731415		 mm	 g
W180SL2-D2	3013682	1	1800x800x525	64000



TOOL STORAGE

9854

WORKBENCHES



- Metal workbench
- The 1.500 model has one drawer, the 1.850 model has two drawers
- Key locks in drawers
- Sturdy design

	 841334		 mm	 g
985415000	5023436	1	1500x800x880	105500
985418500	5023443	1	1850x800x880	128500

9853

WORKBENCHES



- Metal tool cabinet
- Includes hooks
- Vertical blinder with lock

	 841334		 mm	 g
985315000	5023412	1	1500x900x170	40300
985318500	5023429	1	1850x900x170	50200

9853ALU

WORKBENCHES



- New housing cabinet with a very light aluminium shutter
- Punched holes in back side for easy and safe hanging
- Complete set of 25 tool holders
- Safety locking system with 2 keys



	 841334		 mm	 g
985315000ALU	5136143	1	1500x915x155	40000
985318500ALU	5136150	1	1850x915x155	43000



98520000

CABINETS



- 2 door tool cabinet with hooks

985200000	841334	1	1020x600x220	10000

3365NM

TOOL ASSORTMENT, 86 PCS



- Complete tool cabinet with 86 pcs, in metric dimensions

3365NM	731415	1	800x650x270	38000

3365NL		2047-1.2-8 8x150 mm	
7800DM 10, 11, 12, 13, 14, 15, 16, 17, 18, 19, 20, 21, 22, 23, 24, 25, 26, 27, 28, 30 mm		2665B 180 mm	
7805DM 21, 26 mm		2676B 160 mm	
8150-1/2		2457 160 mm	
8159-1/2 50 mm		221MP 175 mm	
8160-1/2 125 mm		2565NB 250 mm	
8162-1/2 250 mm		208	
8154-1/2		481 500 g	
8158-1/2		3625N Ø 32 mm	
6M 6x7, 8x9, 10x11, 12x13, 14x15, 16x17, 18x19, 20x22, 21x23, 24x27, 25x28, 30x32 mm		1450D-ISO	
2M 6x7, 8x9, 10x11, 12x13, 14x15, 16x17, 18x19, 20x22, 21x23, 24x27, 25x28, 30x32 mm		1450D-WW	
3280M		3654R	
BE-8020, BE-8150, BE-8257, BE-8258 0.5x3x60, 1x5.5x100, 1.6x8x175, 1.6x10x200		1435/8	
BE-8610, BE-8620, BE-8623 PH1, PH2, PH3			



3370M

TOOL ASSORTMENT, 173 PCS

- Complete tool cabinet with 173 pcs, in metric dimensions
- 3370MW has the same tools as 3370M but without the cabinet 3365NL



3370M

	 731415		 mm	 g
3370M	1071646	1	800x650x270	47500
3370MW	1298623	1	800x200x180	26000
3365NL			1943M 14x16, 15x17, 19x22 mm	
6720NM			2665B 180 mm	
7800DM 10, 11, 12, 13, 14, 15, 16, 17, 18, 19, 20, 21, 22, 23, 24, 25, 26, 27, 28, 29, 30, 32, 36 mm			2674NB 140 mm	
7805DM 21 26 mm			2456A 200 mm	
8150-1/2			2688 200 mm	
8151-1/2			2461-C19 180 mm	
8160-1/2 125 mm			2464-A19 180 mm	
8162-1/2 250 mm			8224CIP 250 mm	
8154-1/2			2565NB	
8166-1/2			BE-8040, BE-8150, BE-8260, BE-8870 0.8x4.0x100, 1.0x5.5x100, 1.2x8.0x175, 1.6x10x175 mm	
8158-1/2			BE-8350 1x5.5x25 mm	
8152-1/2			BE-8610, BE-8620, BE-8630 PH 1, 2, 3	
7754			2047-1.2-8 8x150 mm	
7760 75 mm			1997M/7T 2, 3, 4, 5, 6, 7, 8 mm	
7409H			319	
7409KML 4, 5, 6, 8, 10, 12, 14, 17 mm			208	
7408H			1450D/2	
70MH 1x6, 1.2x8, 2x12 mm			481 100, 500 g	
72 PH 1, 2, 3, 4			3625N Ø 40 mm	
9070C 6" 160 mm			3654R	
9071C 8" 200 mm			1435/8	
6M/12T 6x7, 8x9, 10x11, 12x13, 14x15, 16x17, 18x19, 20x22, 21x23, 24x27, 25x28, 30x32 mm			4592	
1952M 10, 11, 13, 17, 19, 22 mm			4360 50 cm³	
2M/12T 6x7, 8x9, 10x11, 12x13, 14x15, 16x17, 18x19, 20x22, 21x23, 24x27, 25x28, 30x32 mm			4366 250 cm³	
4M 6x7 8x9 10x11 12x13 mm				



A3362L/A3364L

MECHANIC'S TOOL BOXES







A3362L



A3364L

- Tool box with portable tray and carrying handle
- Finish: Baked enamel box
- Material: Tool steel
- On precision slide rails with fully extractable drawers, easy non-jamming drawer slide
- Automatic safety locking of all drawers when closing top cover; cylinder lock
 - A3362L 1 small drawer, separately lockable, 2 medium sized drawers, 5 large drawers
 - A3364L 1 small drawer, separately lockable, 2 medium sized drawers, 3 large drawers

	 731415		 mm	 g
A3362L	1804978	1	500x660x305	30000
A3364L	1804992	1	390x660x305	24500

3126N/3128N

MECHANIC'S TOOL BOXES



3126N



3128N

- Mechanic's tool box
- Finish: Red hammertone baked enamel
 - 3126N with three drawers, one tray and carrying handle
 - 3128N with two drawers

	 731415		 mm	 g
3126N	1831684	1	520x300x215	9000
3128N	1831691	1	470x240x215	6100



9600

MECHANIC'S TOOL BOXES



- Side handles for transportation
- Can be locked
- 960000040 and 960000050 are elevated to avoid rusting
- 960000050 includes a portable tray

	 841334		 mm	 kg
960000010	5005968	1	535x210x250	5
960000020	5005975	1	530x290x290	8
960000030	5005982	1	685x330x330	14
960000040	5005999	1	835x370x370	19.8
960000050	5028738	1	1000x500x500	23.3

3140N/3141N/3149

TOOL BOXES



- Finish: Red hammertone baked enamel
- Material: Tool steel
- By pulling the handle the box opens up easily and gives immediate access to all tool compartments
 - 3140N with 3 compartments
 - 3141N with 5 compartments
 - 3149 with 5 compartments

	 731415		 mm	 g
3140N	1070892	1	470x200x150	4500
3141N	1070908	1	470x200x200	6400
3149	1070922	1	530x200x200	6800

9601

TOOL BOXES



- 960100010, 960100020 and 960100030 has 3 compartments, 960100050 and 960100060 has 5 compartments
- Complete with locking capability

	 841334		 mm	 g
960100010	5031073	1	300x210x190	2830
960100020	5031080	1	400x210x190	3420
960100030	5031097	1	500x210x190	4100
960100050	5031103	1	400x210x250	4580
960100060	5031110	1	500x210x250	5420



PTB201390/PTB201420

PLASTIC TOOLBOXES



- Composite virgin polypropylene
- Portable tote tray
- ABS and brass closures
- Padlock option
- Contents not included



	 731415		 mm	 g
PTB201390	0140794	4	190x390x210	1000
PTB201420	0140800	4	230x420x230	1400

PTB202510/PTB202660

PLASTIC TOOLBOXES



- Composite virgin polypropylene
- Portable tote tray
- ABS and brass closures
- Padlock option
- Non-slip handle
- Contents not included



	 731415		 mm	 g
PTB202510	0140817	4	290x510x280	2300
PTB202660	0140831	2	290x660x270	3200



TOOL STORAGE

PTB2025102/PTB2026602

PLASTIC TOOLBOXES



- Composite virgin polypropylene
- Cover with two removable organisers
- Padlock option
- Non-slip handle
- Contents not included

	 731415		 mm	 g
PTB2025102	0140824	4	290x510x280	2300
PTB2026602	0140848	2	290x660x270	3200

PTB252560

PLASTIC TOOLBOXES



- Composite virgin polypropylene
- Spacious lower compartment
- Side-grips
- Portable tote tray
- Padlock option
- Non-slip handle
- Contents not included

	 731415		 mm	 g
PTB252560	0140855	2	340x560x340	3100



PTB253580

PLASTIC TOOLBOXES



- Composite virgin polypropylene
- Adjustable shoulder strap
- Cover with 4 to 12 modular compartments
- Practically designed to carry tool box over shoulder
- Non-slip handle
- Contents not included

	 731415		 mm	 g
PTB253580	0140862	2	310x580x340	3000

PTB303440

PLASTIC TOOLBOXES



- Composite virgin polypropylene
- Upper compartment for tools
- Drawers for smaller tools and accessories
- Secure latch door
- Stainless steel closures
- 16 to 32 modular compartments
- Padlock option
- Non-slip handle
- Contents not included

	 731415		 mm	 g
PTB303440	0140879	3	330x440x250	3000



PTB101440

PLASTIC TOOLBOXES



- Composite virgin polypropylene
- Organiser tote
- 6-14 modular compartments
- Side-locks
- Contents not included



	 731415		 mm	 g
PTB101440	0140749	4	260x440x260	2000

PTB105490/PTB105550

PLASTIC TOOLBOXES



- Composite virgin polypropylene
- Portable tote-tray
- Side-locks
- PTB105550 has a black bottom with orange top
- Contents not included



	 731415		 mm	 g
PTB105490	0167579	4	220x490x230	1840
PTB105550	0140787	2	260x550x270	2500



PTB102390

PLASTIC TOOLBOXES



- Composite virgin polypropylene
- Twin professional utility organiser
- 32 compartments
- Transparent covers
- Contents not included



	 731415		 mm	 g
PTB102390	0140756	1	360x390x140	1800

PTB103390

PLASTIC TOOLBOXES



- Composite virgin polypropylene
- Compartment for power tools with protective foam inlay
- 16 compartments
- Inside utility organiser, transparent cover
- Contents not included



	 731415		 mm	 g
PTB103390	0140763	4	360x390x150	1600







PTB402105

ORGANISERS



- Box with 4 organizers model PTB402275
- Stackable
- Contents not included

	 731415		 mm	 g
PTB402105	0167548	4	330x280x250	2300







PTB401165-6

ORGANISERS

- Transparent polypropylene
- 6 compartments
- Contents not included



	 731415		 mm	 g
PTB401165-6	0154630	24	35x165x120	90



PTB402210-6

ORGANISERS



- Transparent polypropylene
- 6 compartments
- Fits onto PTB2025102 and PTB2026602 models cover
- Contents not included

	 731415		 mm	 g
PTB402210-6	0154647	24	35x210x12	140

PTB402220-6

ORGANISERS



- Transparent polypropylene
- 6 compartments
- Contents not included

	 731415		 mm	 g
PTB402220-6	0167500	24	35x220x130	140

PTB402280-6

ORGANISERS



- Transparent polypropylene
- 6 compartments
- Contents not included

	 731415		 mm	 g
PTB402280-6	0167531	12	40x280x180	340



PTB402380-12

ORGANISERS



- Transparent polypropylene
- 12 compartments
- Contents not included

	 731415		 mm	 g
PTB402380-12	0167524	12	40x280x180	340

PTB402280-18

ORGANISERS



- Transparent polypropylene
- 18 compartments
- Contents not included

	 731415		 mm	 g
PTB402280-18	0167517	12	280x180x40	340

PTB402275-19

ORGANISERS



- Transparent polypropylene
- 4 to 19 modular compartments
- Resistant coloured latches
- Handle in transparent polypropylene
- Contents not included

	 731415		 mm	 g
PTB402275-19	0154654	12	40x275x180	350



PTB402355-24

ORGANISERS



- Transparent polypropylene
- 4 to 24 modular compartments
- Resistant coloured latches
- Handles in transparent polypropylene
- Contents not included

	 731415		 mm	 g
PTB402355-24	0154661	8	50x355x23	520

PTB402355-30

ORGANISERS



- Transparent polypropylene
- 4 to 30 modular compartments
- Resistant coloured latches
- Handle in transparent polypropylene
- Space for small hand tools
- Contents not included

	 731415		 mm	 g
PTB402355-30	0154678	8	50x355x220	400



9850

TOOL KITS



- 66 premium quality tools for discerning mechanical and service engineers
- High strength low weight aluminium and laminated construction
- Unique modular tool holders allows tools to be added or arranged to suit special requirements
- Adjustable compartment in the base
- With U.K. plug

	 731415		 mm	 g
9850	0111343	1	490x390x120	13500
8070 155 mm		700-701-703 1.5, 2.5, 3.5, PH0, PH1, T6, T8		
9072 P 254 mm		8045LVDE 135 mm		
BE-9770		5552 205 mm		
1933M/6T 100 mm		2-470-14-2-0 140 mm		
7291 108 mm		268 150 mm		
7891 132		208 250 mm		
8160 125 mm		1-100 1-210 1-230 200 mm		
8140 110 mm		TL 475-SA 140 mm		
2628G-180 180 mm		TL 648-SA 150 mm		
2101G-160 160 mm		5515L 175 mm		
2430G-160 160 mm		2509 525 mm		
2223D-150 150 mm		479-08 305 mm		
2800N 170 mm		2744 190 mm		
BE-8220, BE-8040 0.5x3.0, 0.8x4.0 mm		1162N-1/2 3m 118"		
BE-8150, BE-8155 1.0x5.5, 1.2x6.5 mm		326000300 UK 25 W		
BE-8800, BE-8810, BE-8820 PZ 0, PZ 1, PZ 2		328000000		
2047PR-1-2 PH 1 2		2816		

9841

TOOL KITS

- High quality service kit
- Supplied in a zipper wallet



	 731415		 mm	 g
9841	0107445	1	40x240x155	220

7190
109 mm



7890
132 mm



TL AA-SA-SL
130 mm



BE-8020, BE-8040
0.5x3.0, 0.8x4.0 mm



BE-8610
PH 1



8070
155 mm



9845

TOOL KITS

- High quality service kit
- Supplied in a zipper wallet



	 731415		 mm	 g
9845	0107476	1	310x220x40	1295

2430G-160
160 mm



2101G-160
160 mm



2628G-160
160 mm



9070 P
155 mm



BE-8020, BE-8040
0.5x3.0, 0.8x4.0 mm



BE-8150
1.0x5.5 mm



BE-8610, BE-8620
PH 1, PH 2





9848

TOOL KITS



- High quality service kit
- Supplied in a zipper wallet

	 731415		 mm	 g
9848	0111015	1	40x240x150	380
8160 125 mm		BE-8020 , BE-8040 0.5x3.0, 0.8x4.0 mm		
7890 132 mm		BE-8610 PH 1		
8070 155 mm		TL AA-SA-SL 130 mm		
BE-8020				

9852

TOOL KITS



- High quality service kit
- Supplied in a zipper wallet

	 731415		 mm	 g
9852	0114092	1	40x310x220	1985
8070 155 mm		BE-8210, BE-8040 0.4x2.5, 0.8x4.0 mm		
7890 132 mm		BE-8150, BE-8155 1.0x5.5, 1.2x6.5 mm		
8160 125 mm		BE-8600, BE-8610, BE-8620 PH 0, PH 1, PH 2		
TL AA-SA-SL 130 mm		8045 LVDE 150-250V		
2421G-160 160 mm		TM3M 3 m		
2101G-160 160 mm		K-AP-1		
2628G-180 180 mm				



PERSONAL PROTECTIVE EQUIPMENT

Bahco's Protective Equipment range consists of essential gloves and eyewear designed for optimal personal protection in your working environment. The focus is on protecting hands and eyes as they are usually at the greatest risk of damage with serious consequences if not adequately protected. Within the Bahco range of eyewear and safety gloves, there are variations developed to suit different working environments, applications and sizes. Products are developed through a close working relationship with professional users to make sure we add features that contribute to improved safety and comfort at work.

Chapter Index

















EYEWEAR	852
GLOVES	852-853



EYEWEAR

The Bahco protective eyewear gives an excellent level of safety and comfort. The lightweight design with large lenses offers complete protection for the eyes. Our entire range of glasses has UV protection and anti-scratch treated glass that resists low energy impact. The additional features

are shown in the icons below - all designed to better suit professional needs and avoid any kind of eye injuries. They are highly recommended when working with power tools, drilling, grinding, milling, cutting or even garden work among many other applications.

											
 3870-SG11			●				●			●	
 3870-SG12			●					●		●	
 3870-SG22		●	●					●		●	
 3870-SG13			●		●	●	●		●	●	●
 3870-SG31	●	●	●	●			●			●	
 3870-SG32	●	●	●	●				●		●	

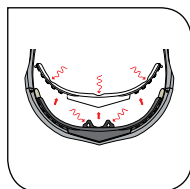

SCRATCH RESISTANT
Designed to resist scratches from low energy impact.



HIGH VISIBILITY
Will enhance light and contrasts in dark environments.

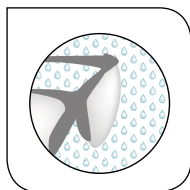

ANTI FOG
Resists fogging and improves vision in high humidity environments. Also helps resist dust and particles.

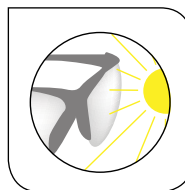

SUN PROTECTION
Darker lenses for outdoor usage, to help to avoid fatigue caused by sunlight.

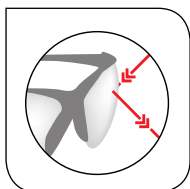

UV PROTECTION
Protects your eyes from dangerous UV radiation.

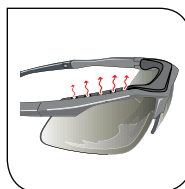

IMPACT PROTECTION
Protects your forehead from impact, protection is removable.

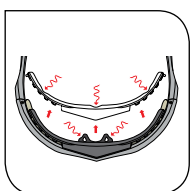

VENTILATION
To avoid mist.



SOFT NOSE PIECE
For higher comfort.

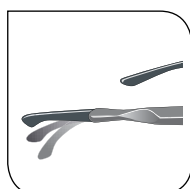

FLEXIBLE EAR PIECE
For higher comfort to fit different shapes of ears.

GLOVES

With 27 bones, an extraordinary capability for positioning, and an astonishing sensitivity through its many nerves, the hand is one of the most important tools a professional has on the job.

In recognition of this, Bahco has created a range to help protect these vital tools.

The Bahco range offers hard-wearing and comfortable gloves for carpenters, mechanics or any professional craftsman looking to protect their hands.

Bahco gloves feature spandex material for better comfort and fit, a cotton brow wipe, and breathable material between the fingers on our padded gloves.

The Bahco working gloves GL008, GL010 and GL012 all follow EN420:2003, EN388:2003 and 2002/61/CE.





EYEWEAR

3870

EYEWEAR



- 99.9% UV protection
- Flexible ear pieces for better fit and comfort
- Polycarbonate material
- AS - Anti scratch
- HV - High visibility
- SP - Sun protection
- UV - UV Protection
- AF - Anti mist

	 731415			
3870-SG11	0178865	6	UV, AS	63
3870-SG12	0178872	6	UV, SP	63
3870-SG13	0178902	6	UV, AS, HV	63
3870-SG22	0178889	6	UV, SP	70
3870-SG31	0178919	6	UV, AF, AS	78
3870-SG32	0178926	6	UV, SP	78



GLOVES

3870

GLOVES



- General purpose work glove





	 731151			
3870-GLOVE	8285531	12	8	223

GL008

GLOVES



- A thin PU material gives user better touch and feel
- Absorption pad on thumb





	 731415			 g
GL008-10	0167050	6	10	72
GL008-8	0167043	6	8	69

GL010

GLOVES



- Anti-vibration pads on fingers and palms
- Reflective strip across the back
- Absorption patch on the thumb





	 731415			 g
GL010-10	0167098	6	10	140
GL010-8	0167081	6	8	137

GL012

GLOVES



- Reinforced grip pads on fingers and palm
- Missing ends on thumb, index and middle fingers
- Absorption pad on thumb

	 731415			 g
GL012-10	0167104	6	10	91
GL012-8	0167111	6	8	87

INSULATED TOOLS

For work on live equipment up to 1000 volts, Bahco offers a wide range of insulated safety tools consisting of more than 250 products.

All Bahco insulated tools are manufactured according to the International Standard IEC60900 for working with live systems up to 1000 V AC and 1500 V DC. They follow strict quality controls and all tools are subjected to the most stringent, individual tests.

We recommend following the safety instructions very closely when working with any live systems.

Chapter Index

ERGO™ SCREWDRIVERS	858-862
TEKNO+ SCREWDRIVERS	863-866
800 SERIES SCREWDRIVERS	867-869
PREMIUM SCREWDRIVERS	870-873
600 SERIES SCREWDRIVERS	874
PLIERS	875-884
WRENCHES	885-888
SOCKETS & ACCESSORIES	889-890
OTHER INSULATED TOOLS	891-893
PROTECTIVE EQUIPMENT	894-895
TOOLS SETS	896-897

ROUTINE TESTS IN ACCORDANCE TO IEC609000 SPECIFICATION

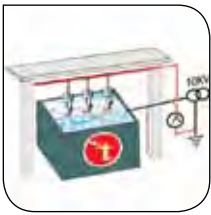

Dielectric test

The tools are immersed in water for 24 hours. A voltage of 10kV is then continuously applied for 3 minutes. The test is considered successful if no electrical puncture, spark over, or flashover occurs during the test period. Leakage limits must not be exceeded.



Retaining force test

This test is applied to tools that can be assembled. A force is applied to the assembled parts in an effort to separate them. If, after a minute, the parts remain assembled, the test is passed.



Impact test

The tools are cooled to -25°C for 2 hours. Then, a special hammer is used with some force on the insulating layer. The test is considered successful if the insulating material shows no breaks and passes the dielectric test.



Permanent marking durability

The markings are rubbed for 15 seconds with a rag soaked in water, and then for 15 seconds with a rag soaked in isopropanol. The test is passed if, after this process, the markings are still legible.



Insulation adhesion test

The tools are stored at a temperature of 70°C for 168 hours. Then, a force of 490 N is applied in the direction of the line dividing the insulating material from the conductive part for 3 minutes. During this test the insulation material must stay firmly attached to the tools.



Penetration test

The insulated surfaces of the tools are pressed with a special device. A voltage of 5000 V is then applied to the tool for 3 minutes. The test is considered successful if no electrical puncture, spark-over, or flash-over occurs during the test period.



Flame test

When placed over a fire, where the height of the flames on the tools does not exceed 120 mm, if the insulation material does not melt or leak, then the test is passed.



Visual and dimensional

The tools, and in particular the insulation, are visually controlled and have to be free from external defects. The markings have to be perfectly legible and the dimensions have to be in accordance with the standard.



SAFETY COLOUR CODE

All Bahco insulated tools have a colour-coded, three-layer insulation coating. This provides protection as well as creating a visual warning system. If the outer insulation layer gets

damaged, the lighter colour underneath will become visible and warn the user. This makes it easier to detect damage to the insulation.



SAFETY INSTRUCTIONS FOR WORKING WITH LIVE SYSTEMS

- Always transport your insulated tools carefully to avoid damage
- Examine each tool for damage before every use. If the insulation is damaged, the tools should not be used
- Keep all tools in good condition with regular maintenance. The insulated tools should be kept clean and dry
- Protective glasses should be worn when working with cutting pliers or above your head
- Work space should be kept clean, dry and tidy to prevent accidents when working with live voltage
- Make sure you use the tools for their intended purposes and always use the right tool size
- Always wear the proper personal protective equipment required for the job. Protect your eyes, hands, ears and other body parts
- Make sure that loose and cut-off parts of cables do not fall onto live components



BE-8010S - BE-8065S

ERGO™ SLOTTED SCREWDRIVERS



- Insulated screwdriver for slotted head screws developed according to the scientific ERGO™ process
- For work on live equipment up to 1000 volts
- ISO 2380, IEC 60900, VDE certified
- 3-component handle, for maximum user comfort and force transmission
- High performance alloy steel blade
- Colour-coded handle with the screw type symbol on the domed end

	731415		mm	mm	mm	mm	mm	mm	g
BE-8010S	0033058	5	0.4	2.5	75	20x122	197	30	
BE-8220S	0048243	5	0.5	3.0	100	20x122	222	33	
BE-8230S	0048250	5	0.6	3.5	100	20x122	222	33	
BE-8040S	0033089	5	0.8	4.0	100	20x122	222	33	
BE-8050S	0033096	5	1.0	5.5	125	27x122	247	62	
BE-8255S	0048281	5	1.2	6.5	150	36x122	272	105	
BE-8065S	0033119	5	1.2	8.0	175	36x122	297	127	

BE-8600S - BE-8640S

ERGO™ PHILLIPS SCREWDRIVERS



- Insulated screwdriver for Phillips head screws developed according to the scientific ERGO™ process
- For work on live equipment up to 1000 volts
- ISO 8764, IEC 60900, VDE certified
- 3-component handle, for maximum user comfort and force transmission
- High performance alloy steel blade
- Colour-coded handle with the screw type symbol on the domed end

	731415			mm	mm	mm	mm	g
BE-8600S	0033126	5	PH 0	75	20x122	197	31	
BE-8610S	0033133	5	PH 1	80	27x122	202	64	
BE-8620S	0033140	5	PH 2	100	36x122	222	108	
BE-8630S	0033157	5	PH 3	150	36x122	272	159	
BE-8640S	0033164	5	PH 4	200	36x165	365	268	



BE-8800S - BE-8840S

ERGO™ POZIDRIV SCREWDRIVERS



IEC 60900 1000V D'E GS

- Insulated screwdriver for Pozidriv head screws developed according to the scientific ERGO™ process
- For work on live equipment up to 1000 volts
- ISO 8764, IEC 60900, VDE certified
- 3-component handle, for maximum user comfort and force transmission
- High performance alloy steel blade
- Colour-coded handle with the screw type symbol on the domed end

	 731415			 mm	 mm	 mm	 g
BE-8800S	1839055	5	PZ 0	75	20x122	197	31
BE-8810S	0048298	5	PZ 1	80	27x122	202	64
BE-8820S	0048304	5	PZ 2	100	36x122	222	110
BE-8830S	0048311	5	PZ 3	150	36x122	272	159
BE-8840S	1839062	5	PZ 4	200	36x161	365	268

BE-8725S - BE-8708S

ERGO™ HEXAGON HEAD SCREWDRIVERS



IEC 60900 1000V D'E GS

- Insulated screwdriver for hexagon head screws developed according to the scientific ERGO™ process
- For work on live equipment up to 1000 volts
- IEC 60900, VDE certified
- 3-component handle, for maximum user comfort and force transmission
- High performance alloy steel blade
- Colour-coded handle with the screw type symbol on the domed end

	 731415		 mm	 mm	 mm	 mm	 g
BE-8725S	1839123	5	2.5	75	20x122	197	33
BE-8703S	1839130	5	3	75	20x122	197	62
BE-8704S	1839147	5	4	75	20x122	197	78
BE-8705S	1839154	5	5	175	27x122	297	128
BE-8706S	1839161	5	6	200	27x122	322	159
BE-8708S	1839178	5	8	200	36x122	322	235



BE-8910S - BE-8930S

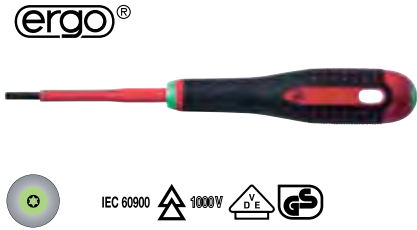

ERGO™ TORX® HEAD SCREWDRIVERS

- Insulated screwdriver for TORX® head screws developed according to the scientific ERGO™ process
- For work on live equipment up to 1000 volts
- IEC 60900, VDE certified
- 3-component handle, for maximum user comfort and force transmission
- High performance alloy steel blade
- Colour-coded handle with the screw type symbol on the domed end

	 731415			 D mm	 mm	 mm	 mm	 g
BE-8910S	1839079	5	T 10	2.72	100	20x122	222	33
BE-8915S	1839086	5	T 15	3.26	125	27x122	247	62
BE-8920S	1839093	5	T 20	3.84	125	27x122	247	62
BE-8925S	1839109	5	T 25	4.40	150	27x122	272	77
BE-8930S	1839116	5	T 30	5.49	175	36x122	297	129

BE-8510S - BE-8520S



ERGO™ COMBI TIPS PHILLIPS/SLOTTED SCREWDRIVERS

- Insulated combination screwdriver for slotted and Phillips head screws developed according to the scientific ERGO™ process
- For work on live equipment up to 1000 volts
- IEC 60900, VDE certified
- 3-component handle, for maximum user comfort and force transmission
- High performance alloy steel blade
- Colour-coded handle with the screw type symbol on the domed end

	 731415					 mm	 mm	 mm	 g
BE-8510S	0126507	5	5	-	1	80	27x122	202	60
BE-8520S	0126514	5	6	-	2	100	36x122	222	100

BE-8710S - BE-8720S



ERGO™ COMBI TIPS POZIDRIV/SLOTTED SCREWDRIVERS

- Insulated combination screwdriver for slotted and Pozidriv head screws developed according to the scientific ERGO™ process
- For work on live equipment up to 1000 volts
- IEC 60900, VDE certified
- 3-component handle, for maximum user comfort and force transmission
- High performance alloy steel blade
- Colour-coded handle with the screw type symbol on the domed end

	 731415					 mm	 mm	 mm	 g
BE-8710S	0126521	5	5	1	-	80	27x122	202	60
BE-8720S	0126538	5	6	2	-	100	36x122	222	100



BE-9881S

ERGO™ SCREWDRIVERS SETS



- ERGO™ insulated screwdriver set for slotted and Phillips head screws, 5 pcs
- For work on live equipment up to 1000 volts
- In cardboard box

	731415		9
BE-9881S	1839307	1	450
BE-8220S, BE-8040S, BE-8050S 0.5x3x100, 0.8x4x100, 1x5.5x125 mm			
BE-8610S, BE-8620S PH1x80, PH2x100			

BE-9882S

ERGO™ SCREWDRIVERS SETS



- ERGO™ insulated screwdriver set for slotted and Pozidriv head screws, 5 pcs
- For work on live equipment up to 1000 volts
- In cardboard box

	731415		9
BE-9882S	1839314	1	450
BE-8220S, BE-8040S, BE-8050S 0.5x3x100, 0.8x4x100, 1x5.5x125			
BE-8810S, BE-8820S PZ1x80, PZ2x100			



BE-9888S

ERGO™ SCREWDRIVERS SETS



IEC 60900

- ERGO™ insulated screwdriver set for slotted and Pozidriv head screws, 7 pcs
- For work on live equipment up to 1000 volts
- In cardboard box

BE-9888S	731415	1	530
BE-8010S, BE-8220S, BE-8040S, BE-8050S 0.4x2.5x75, 0.5x3.0x100, 0.8x4.0x100, 1.0x5.5x125			
BE-8800S, BE-8800S, BE-8830S PZ0x75, PZ2x100, PZ3x150			

BE-9885S

ERGO™ COMBI TIP SCREWDRIVERS SET



IEC 60900

- ERGO™ insulated screwdriver set for slotted, Phillips and Pozidriv head screws, 4 pcs (8 different tips)
- For work on live equipment up to 1000 volts
- In cardboard box

BE-9885S	731151	1	445
806-1-1 0.6x3x65			
BE-8510S, BE8520S 5/PH1, 6/PH2			
BE-8710S, BE-8720S 5/PZ1, 6/PZ2			



033

TEKNO+ SLOTTED SCREWDRIVERS



- Insulated screwdriver for slotted head screws
- For work on live equipment up to 1000 volts
- ISO 2380, IEC 60900, VDE certified
- High performance alloy steel blade
- Double shape handle allows optimum grip and maximum torque power
- Hole in the handle permits the insertion of a T-bar for added turning force
- Colour-coded handle for quick identification of the tip

	 841281		 mm	 mm	 mm	 mm	 g
033.030.100	4033310	10	3.0	0.5	100	100	42
033.035.100	4033327	10	3.5	0.6	100	100	42
033.040.100	4033419	10	4.0	0.8	100	100	42
033.055.125	4033518	10	5.5	1.0	125	115	75
033.065.150	4033617	10	6.5	1.2	175	130	135
033.080.175	4033815	10	8.0	1.2	175	130	135
033.100.200	4033112	10	10.0	1.6	200	145	227

034

TEKNO+ PHILLIPS SCREWDRIVERS



- Insulated screwdriver for Phillips head screws
- For work on live equipment up to 1000 volts
- ISO 8764, IEC 60900, VDE certified
- High performance alloy steel blade
- Double shape handle allows optimum grip and maximum torque power
- Hole in the handle permits the insertion of a T-bar for added turning force
- Colour-coded handle for quick identification of the tip

	 841281			 mm	 mm	 g
034.000.100	4034010	10	PH 0	100	100	42
034.001.150	4034119	10	PH 1	150	115	91
034.002.175	4034218	10	PH 2	175	130	141
034.003.200	4034317	10	PH 3	200	145	228



035

TEKNO+ POZIDRIV SCREWDRIVERS



- Insulated screwdriver for Pozidriv head screws
- For work on live equipment up to 1000 volts
- ISO 8764, IEC 60900, VDE certified
- High performance alloy steel blade
- Double shape handle allows optimum grip and maximum torque power
- Hole in the handle permits the insertion of a T-bar for added turning force
- Colour-coded handle for quick identification of the tip

035.000.100	4035017	10	PZ 0	100	100	40

036

TEKNO+ HEXAGONAL NUT DRIVER



- Insulated hexagonal nut driver
- For work on live equipment up to 1000 volts
- IEC 60900, VDE certified
- High performance alloy steel blade
- Double shape handle allows optimum grip and maximum torque power.
- Hole in the handle permits the insertion of a T-bar for added turning force
- Colour-coded handle for quick identification of the tip

	841281		mm	mm	mm	g
036.055.125	4036519	5	5.5	125	115	103
036.060.125	4036618	5	6.0	125	115	105
036.070.125	4036717	5	7.0	125	130	151
036.080.125	4036816	5	8.0	125	130	155
036.100.125	4036106	5	10.0	125	130	157
036.130.125	4036137	5	13.0	125	145	222



202.030

TEKNO+ SCREWDRIVERS SET



- Insulated screwdriver set for slotted and Phillips head screws, 7 pcs
- For work on live equipment up to 1000 volts
- In cardboard box



	 841281		 g
202.030	4202303	1	722

033
3x100, 4x100, 5.5x125, 6.5x150

034
PH0x100, PH1x150, PH2x175

202.031

TEKNO+ SCREWDRIVERS SET



- Insulated screwdriver set for slotted and Pozidriv head screws, 7 pcs
- For work on live equipment up to 1000 volts
- In cardboard box



	 841281		 g
202.031	4202310	1	722

033
3x100, 4x100, 5.5x125, 6.5x150

035
PZ0x100, PZ1x150, PZ2x175

202.035

TEKNO+ SCREWDRIVERS SET



- Insulated screwdriver set for slotted and Phillips head screws, 6 pcs + voltage tester
- For work on live equipment up to 1000 volts
- In cardboard box



	 841281		 g
202.035	4108742	1	675

033
3x100, 4x100, 5.5x125

034
PH0x100, PH1x150, PH2x175

806-1-2



202.033

TEKNO+ SCREWDRIVERS SET IN ZIP CASE



- Insulated screwdriver set for slotted and Phillips head screws, 7 pcs
- For work on live equipment up to 1000 volts
- In cardboard box and zip case



202.033	841281 4121376	1	g 1.000

033
3x100, 4x100, 5.5x125, 6.5x150



034
PH0x100, PH1x150, PH2x175



202.032

TEKNO+ SCREWDRIVERS SET IN ZIP CASE



- Insulated screwdriver set for slotted and Pozidriv head screws, 7 pcs
- For work on live equipment up to 1000 volts
- In cardboard box and zip case



202.032	841281 4119298	1	g 1.000

033
3x100, 4x100, 5.5x125, 6.5x150



035
PZ0x100, PZ1x150, PZ2x175





813VDE

800 SERIES SLOTTED SCREWDRIVERS



- Insulated screwdriver for slotted head screws
- For work on live equipment up to 1000 volts
- ISO 2380, IEC 60900, VDE certified
- High performance alloy steel blade
- 2-component handle, with hanging hole and anti-roll design
- Symbol-coded handle for quick identification of the tip
- SB: Retail packed

	 731415		 mm	 mm	 mm	 mm	 mm	 mm	 g
813VDE-3-100	1846176	10	0.5	3.0	100	27x90	190	40	
813VDE-3,5-100	1846183	10	0.6	3.5	100	27x90	190	40	
813VDE-4-100	1846190	10	0.8	4.0	100	27x90	190	40	
813VDE-5,5-125	1846206	10	1.0	5.5	125	30x100	225	60	
813VDE-6,5-150	1846213	10	1.2	6.5	150	33x110	260	90	
813VDE-8-175	1846220	10	1.2	8.0	175	33x110	285	110	
813VDE-10-200	1846237	10	1.6	10.0	200	36x120	320	175	
813VDE-12-200	1846244	10	2.0	12.0	200	36x120	320	205	
SB813VDE-3-100	3001627	1	0.5	3.0	100	27x90	190	44	
SB813VDE-3,5-100	3001634	1	0.6	3.5	100	27x90	190	44	
SB813VDE-4-100	3001641	1	0.8	4.0	100	27x90	190	44	
SB813VDE-5,5-125	3001658	1	1.0	5.5	125	30x100	225	64	
SB813VDE-6,5-150	3001665	1	1.2	6.5	150	33x110	260	94	
SB813VDE-8-175	3001672	1	1.2	8.0	175	33x110	285	114	

815VDE

800 SERIES PHILLIPS SCREWDRIVERS



- Insulated screwdriver for Phillips head screws
- For work on live equipment up to 1000 volts
- ISO 8764, IEC 60900, VDE certified
- High performance alloy steel blade
- 2-component handle, with hanging hole and anti-roll design
- Symbol-coded handle for quick identification of the tip
- SB: Retail packed

	 731415			 mm	 mm	 mm	 g
815VDE-0-100	1846251	10	PH 0	100	27x90	190	40
815VDE-1-150	1846268	10	PH 1	150	30x110	250	75
815VDE-2-175	1846275	10	PH 2	175	33x110	285	110
815VDE-3-200	1846282	10	PH 3	200	36x120	320	175
815VDE-4-200	1846299	10	PH 4	200	36x120	320	205
SB815VDE-0-100	3001702	1	PH 0	100	27x90	190	64
SB815VDE-1-150	3001719	1	PH 1	150	30x110	250	79
SB815VDE-2-175	3001726	1	PH 2	175	33x110	285	114
SB815VDE-3-200	3001733	1	PH 3	200	36x120	320	179



800 SERIES SCREWDRIVERS

816VDE

800 SERIES POZIDRIV SCREWDRIVERS



IEC 60900



1000V



VDE



- Insulated screwdriver for Pozidriv head screws
- For work on live equipment up to 1000 volts
- ISO 8764, IEC 60900, VDE certified
- High performance alloy steel blade
- 2-component handle, with hanging hole and anti-roll design
- Symbol-coded handle for quick identification of the tip
- SB: Retail packed

816VDE-0-100	731415	10	PZ 0	100	27x90	190	40

817V

800 SERIES HEXAGONAL NUT DRIVER



IEC 60900



1000V

- Insulated hexagonal nut driver
- For work on live equipment up to 1000 volts
- ISO 691, IEC 60900
- High performance alloy steel blade
- 2-component handle, with hanging hole and anti-roll design
- Symbol-coded handle for quick identification of the tip
- SB: Retail packed

	731415		mm	mm	mm	mm	g
817V-6	0128976	5	6	125	30x100	225	85
817V-7	0128983	5	7	125	33x110	235	120
817V-8	0128990	5	8	125	33x110	235	120
817V-10	0129003	5	10	125	36x120	245	145
817V-13	0129010	5	13	125	36x120	245	170



822VDE-5

800 SERIES SCREWDRIVERS SET



- Insulated screwdriver set for slotted and Phillips head screws, 5 pcs
- For work on live equipment up to 1000 volts
- In cardboard box

	 731415		 mm	 g
822VDE-5	3002365	1	335x192	360

813VDE
3x100, 4x100, 5.5x125 mm



815VDE
PH1x150, PH2x175



820VDE-5

800 SERIES SCREWDRIVERS SET



- Insulated screwdriver set for slotted and Pozidriv head screws, 5 pcs
- For work on live equipment up to 1000 volts
- In cardboard box

	 731415		 mm	 g
820VDE-5	3001146	1	335x192	360

813VDE
3.5x100, 4x100, 6.5x150 mm



816VDE
PZ1X150, PZ2X175





196

PREMIUM SLOTTED SCREWDRIVERS



IEC 60900



- Insulated screwdriver for slotted head screws
- For work on live equipment up to 1000 volts
- ISO 2380, IEC 60900, VDE certified
- High performance alloy steel blade
- Triangle shaped 2-component handle with hanging hole

	 731415		 mm	 mm	 mm	 mm	 g
196.025.100	4107516	10	2.5	0.4	100	75	28
196.030.100	4196312	10	3.0	0.5	100	75	31
196.035.100	4196329	10	3.5	0.6	100	75	31
196.040.100	4196411	10	4.0	0.8	100	88	43
196.055.125	4196510	10	5.5	1.0	125	100	68
196.065.150	4196619	10	6.5	1.2	150	110	100
196.080.175	4196817	10	8.0	1.2	175	110	118
196.100.200	4196114	10	10.0	1.6	200	120	191
196.120.200	4196121	10	12.0	2.0	200	120	217

197

PREMIUM PHILLIPS SCREWDRIVERS



IEC 60900



- Insulated screwdriver for Phillips head screws
- For work on live equipment up to 1000 volts
- ISO 8764, IEC 60900, VDE certified
- High performance alloy steel blade
- Triangle shaped 2-component handle with hanging hole

	 841281			 mm	 mm	 g
197.000.100	4197005	10	PH 0	100	75	31
197.001.150	4197012	10	PH 1	150	100	84
197.002.175	4197029	10	PH 2	175	110	121
197.003.200	4197036	10	PH 3	200	120	190
197.004.200	4197043	10	PH 4	200	120	218



142

PREMIUM POZIDRIV SCREWDRIVERS



IEC 60900

- Insulated screwdriver for Pozidriv head screws
- For work on live equipment up to 1000 volts
- ISO 8764, IEC 60900, VDE certified
- High performance alloy steel blade
- Triangle shaped 2-component handle with hanging hole

	 841281			 mm	 mm	 g
142.000.100	4142098	10	PZ 0	100	75	31
142.001.150	4142012	10	PZ 1	150	100	84
142.002.175	4142029	10	PZ 2	175	110	122
142.003.200	4142036	10	PZ 3	200	120	190

199

PREMIUM HEXAGONAL NUT DRIVER



IEC 60900

- Insulated hexagonal nut driver
- For work on live equipment up to 1000 volts
- IEC 60900, VDE certified
- High performance alloy steel blade
- Triangle shaped 2-component handle with hanging hole

	 841281		 mm	 mm	 mm	 g
199.050.125	4108759	5	5,0	125	100	101
199.055.125	4199511	5	5.5	125	100	101
199.060.125	4199610	5	6.0	125	100	127
199.070.125	4199719	5	7.0	125	110	151
199.080.125	4199818	5	8.0	125	110	142
199.090.125	4199917	5	9.0	125	110	142
199.100.125	4199108	5	10.0	125	110	142
199.110.125	4199115	5	11.0	125	120	181
199.120.125	4199122	5	12.0	125	120	183
199.130.125	4199139	5	13.0	125	120	188



219.600

PREMIUM SCREWDRIVER SETS

- Insulated screwdriver set for slotted and Phillips head screws, 7 pcs
- For work on live equipment up to 1000 volts
- In cardboard box

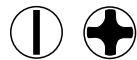

219.600	841281 4219608	1	g 717

196
3x100, 4x100, 5.5x125, 6.5x150



197
PH0x100, PH1x150, PH2x175



219.605

PREMIUM SCREWDRIVER SETS

- Insulated screwdriver set for slotted and Pozidriv head screws, 7 pcs
- For work on live equipment up to 1000 volts
- In cardboard box



219.605	841281 4219653	1	g 717

196
3x100, 4x100, 5.5x125, 6.5x150



142
PZ0x100, PZ1x150, PZ2x175





219.601

PREMIUM SCREWDRIVER SETS



- Insulated screwdriver set for slotted and Phillips head screws, 6 pcs + voltage tester
- For work on live equipment up to 1000 volts
- In cardboard box



	 841281		 g
219.601	4107820	1	638
196 3x100, 4x100, 5.5x125			
197 PH0x100, PH1x150, PH2x175			
806-1-1			

219.602

PREMIUM SET IN ZIP CASE



- Insulated screwdriver set for slotted and Pozidriv head screws, 7 pcs
- For work on live equipment up to 1000 volts
- In cardboard box and zip case for a clean and easy storage



	 841281		 g
219.602	4119304	1	900
196 3x100, 4x100, 5.5x125, 6.5x150			
142 PZ0x100, PZ1x150, PZ2x175			



600 SERIES SCREWDRIVERS

623

600 SERIES SLOTTED SCREWDRIVERS



- Insulated screwdriver for slotted head screws
- For work on live equipment up to 1000 volts
- ISO 2380, IEC 60900
- High quality steel
- 2-component handle with hanging hole

	 731415		 mm	 mm	 mm	 mm	 mm	 g
623-3-100	0128518	10	0.5	3.0	100	80	180	32
623-3.5-100	0128525	10	0.6	3.5	100	80	180	32
623-4-100	0128532	10	0.8	4.0	100	80	180	33
623-5.5-125	0128549	10	1.0	5.5	125	97	223	61
623-6.5-150	0128556	10	1.2	6.5	150	100	250	94

625

600 SERIES PHILLIPS SCREWDRIVERS



- Insulated screwdriver for Phillips head screws
- For work on live equipment up to 1000 volts
- ISO 8764, IEC 60900
- High quality steel
- 2-component handle with hanging hole

	 731415			 mm	 mm	 mm	 g
625-0-100	0128563	10	PH 0	100	80	180	32
625-1-150	0128570	10	PH 1	150	97	247	68
625-2-175	0128587	10	PH 2	175	110	285	116

620-6

600 SERIES SCREWDRIVER SET SLOTTED/PHILLIPS



- Insulated screwdriver set for slotted and Phillips head screws, 6 pcs
- For work on live equipment up to 1000 volts
- In clamshell packaging

	 731415		 g
620-6	0128594	1	465

623
3x100, 4x100, 5.5x125, 6.5x150



625
PH-1, PH-2







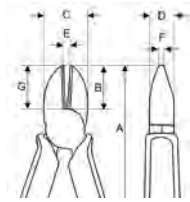

2171V

SIDE CUTTERS



- Insulated side cutting pliers
- For work on live equipment up to 1000 volts
- ISO 5749, IEC 60900, VDE certified
- Chrome plated and anti-corrosion treated finish
- High performance alloy steel
- Induction hardened cutting edges
- 3 layer colour insulation coating



	 731415		A mm	B mm	C mm	D mm	E mm	F mm	G mm	 Cu mm	 Fe+ mm	 Piano mm	 g
2171V-160	0126798	2	160	20	25	12	3	2	20	2.7	2.5	1.6	221
2171V-180	0126804	2	180	22	24	12	2.0	2	22	2.8	2.5	2.0	267





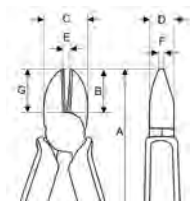

2191V

SIDE CUTTERS



- Insulated heavy duty side cutting pliers
- For work on live equipment up to 1000 volts
- ISO 5749, IEC 60900, VDE certified
- Chrome plated and anti-corrosion treated finish
- High performance alloy steel Induction hardened cutting edges
- 3 layer colour insulation coating



	 731415		A mm	B mm	C mm	D mm	E mm	F mm	G mm	 Cu mm	 Fe+ mm	 Piano mm	 g
2191V-180	0128716	2	180	20	25	12	29	15	20	3.0	2.5	2.0	348
2191V-200	0128723	2	200	21	26	12	2.5	33	21	4.0	3.0	2.5	375



2101S

SIDE CUTTERS



IEC 60900 1000V

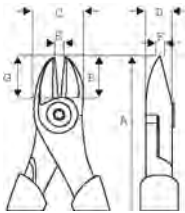

- Insulated side cutting pliers
- For work on live equipment up to 1000 volts
- ISO 5749, IEC 60900
- Black oxidized and anti-corrosion treated finish
- High performance alloy steel
- Induction hardened cutting edges
- Plastic injected handles
- Progressive edges: The cutting radius progresses along the edge in order to cut hard material like piano wire close to the joint and soft materials like copper and plastic insulated wire at the tip
- Screw joint that provides excellent running and accurate alignment of the cutting edges
- Reduced distance from the joint to the centre of the cutting edges give increased leverage and cutting capacity
- Round shaped jaws give improved accessibility in confined spaces

	731415		A mm	B mm	C mm	D mm	E mm	F mm	G mm	Cu mm	Fe+ mm	Piano mm	g
2101S-140	0106592	3	140	16	19.5	9	1.5	1.3	16	3.7	2.0	1.8	126
2101S-160	0106608	3	160	18	21.5	10	2.0	1.5	18	3.8	2.5	2.0	162
2101S-180	0106615	3	180	20	23.5	11	2.5	1.5	20	4.0	2.7	2.3	245
2101S-200	0106622	3	200	22	25.5	11	2.5	1.5	22	4.5	3.0	2.5	304

527V

END CUTTER



IEC 60900



- Insulated end cutting pliers
- For work on live equipment up to 1000 volts
- ISO 5748, IEC 60900, VDE certified
- Chrome plated and anti-corrosion treated finish
- High performance alloy steel
- 3 layer colour insulation coating

	731415		A mm	B mm	C mm	D mm	E mm	F mm	G mm	Piano mm	g
527V-160	0126811	2	160	7	26.5	11	3.0	3.0	21	2.0	270
527V-200	0126828	2	200	7	35	35.0	13	3.0	30	2.5	320

2678V

COMBINATION PLIERS



- Insulated combination pliers
- For work on live equipment up to 1000 volts
- ISO 5749, IEC 60900, VDE certified
- Chrome plated and anti-corrosion treated finish
- High performance alloy steel
- 3 layer colour insulation coating

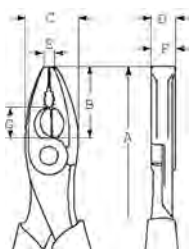

	 731415		A mm	B mm	C mm	D mm	E mm	F mm	G mm	 Cu mm	 Fe+ mm	 Piano mm	 g
2678V-160	0126835	2	160	33	23	11	6	11.0	12	2.7	2.0	1.8	255
2678V-180	0126842	2	180	36	26	13	8	11.5	13	3.0	2.5	2.0	348
2678V-200	0126859	2	200	39	28	12	9	12.0	14	4.0	3.0	2.5	350





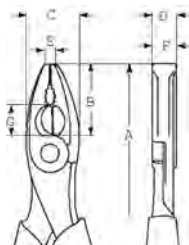

2628S

COMBINATION PLIERS



- Insulated combination pliers
- For work on live equipment up to 1000 volts
- ISO 5746, IEC 60900
- Black oxidized and anti-corrosion treated finish
- High performance alloy steel
- Plastic injected handles
- Edges specially designed to cut harder material such as piano wire and spring steel wire
- Gripping surfaces particularly suited for gripping round and flat material
- Round shaped jaws give improved accessibility in confined spaces
- Reduced distance from the joint to the centre of the cutting edges give increased leverage and cutting capacity



	 731415		A mm	B mm	C mm	D mm	E mm	F mm	G mm	 Fe+ mm	 Piano mm	 g
2628 S-180	0044054	3	180	36	25	11	4.0	11	14	2.5	2.0	240
2628 S-200	0043002	3	200	39	27	12	4.5	12	16	3.0	2.5	300



2430V

SNIPE NOSE PLIERS



- Insulated snipe nose pliers
- For work on live equipment up to 1000 volts
- ISO 5745, IEC 60900, VDE certified
- Chrome plated and anti-corrosion treated finish
- High performance alloy steel
- 3 layer colour insulation coating
- Sharp edges for cutting softer material such as copper and plastic insulated wire
- Tips give a good grip and improved accessibility in confined spaces

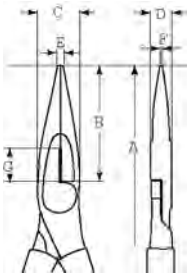

			A	B	C	D	E	F	G				
	731415		mm	mm	mm	mm	mm	mm	mm	mm	mm	mm	
2430V-160	0126880	2	160	49	16	8	3.0	2.5	12	3.0	1.8	1.6	160
2430V-200	0126897	2	200	72	17	9	4.0	2.5	12	3.0	1.8	1.6	170

2430S

SNIPE NOSE PLIERS



- Insulated snipe nose pliers
- For work on live equipment up to 1000 volts
- ISO 5745, IEC 60900
- Chrome plated and anti-corrosion treated finish
- High performance alloy steel
- Plastic injected handles
- Sharp edges for cutting softer material such as copper and plastic insulated wire
- Tips give a good grip and improved accessibility in confined spaces

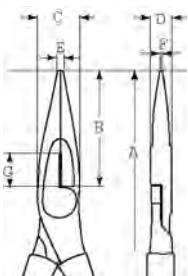

			A	B	C	D	E	F	G				
	731415		mm	mm	mm	mm	mm	mm	mm	mm	mm	mm	
2430 S-200	0033010	3	200	72	17	9	4	2.5	12	3.0	1.8	1.6	170

2427V

SNIPE NOSE PLIERS



- Insulated snipe nose pliers with tip angled at 60°
- For work on live equipment up to 1000 volts
- ISO 5745, IEC 60900, VDE certified
- Chrome plated and anti-corrosion treated finish
- High performance alloy steel
- 3 layer colour insulation coating
- Sharp edges for cutting softer material such as copper and plastic insulated wire

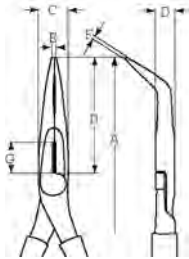

			A	B	C	D	E	F	G				
2427V-200	0126903	2	mm	mm	mm	mm	mm	mm	mm	Cu mm	Fe mm	Fe+ mm	g
			200	70	17	9	2	2	12	3.0	1.8	1.6	170





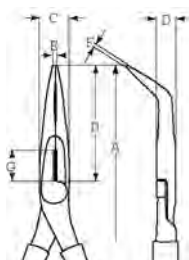

2427S

SNIPE NOSE PLIERS



- Insulated snipe nose pliers with tip angled at 60°
- For work on live equipment up to 1000 volts
- ISO 5745, IEC 60900
- Black oxidized and anti-corrosion treated finish
- High performance alloy steel
- Plastic injected handles
- Sharp edges for cutting softer material such as copper and plastic insulated wire
- Tips give a good grip and improved accessibility in confined spaces



			A	B	C	D	E	F	G				
2427 S-200	0033027	3	mm	mm	mm	mm	mm	mm	mm	Cu mm	Fe mm	Fe+ mm	g
			200	70	17	9	2	2	12	3.0	1.8	1.6	170



2421V

FLAT NOSE PLIERS

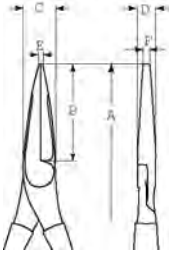

- Insulated long flat nose pliers
- For work on live equipment up to 1000 volts
- ISO 5745, IEC 60900, VDE certified
- Chrome plated and anti-corrosion treated finish
- High performance alloy steel
- 3 layer colour insulation coating
- Tips give a good grip and improved accessibility in confined spaces
- Particularly suited for gripping flat material

			A mm	B mm	C mm	D mm	E mm	F mm	
2421V-160	0126774	2	160	49	16.5	8.5	3	5.0	205

2521V

ROUND NOSE PLIERS

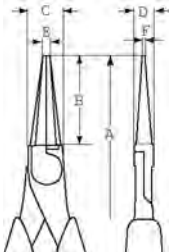

- Insulated round nose pliers
- For work on live equipment up to 1000 volts
- ISO 5745, IEC 60900, VDE certified
- Chrome plated and anti-corrosion treated finish
- High performance alloy steel
- 3 layer colour insulation coating
- Suited for wire-bending work

			A mm	B mm	C mm	D mm	E mm	F mm	
2521V-160	0126781	2	160	42	16	7	3.0	1.5	120

2223V

WIRE STRIPPING PLIERS

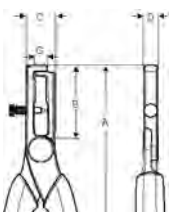

- Insulated wire stripping pliers, for stripping copper cables up to 5 mm
- For work on live equipment up to 1000 volts
- IEC 60900, VDE certified
- Chrome plated and anti-corrosion treated finish
- High performance alloy steel
- 3 layer colour insulation coating

			A mm	B mm	C mm	D mm	G mm		AWG	
2223V-160	0134113	2	160	46	15	8	8	0.5-5	4-23	205

2223S

WIRE STRIPPING PLIERS



- Insulated wire stripping pliers, for stripping copper cables up to 5 mm
- For work on live equipment up to 1000 volts
- IEC 60900
- Black oxidized and anti-corrosion treated finish
- High performance alloy steel
- Plastic injected handles

IEC 60900  1000V

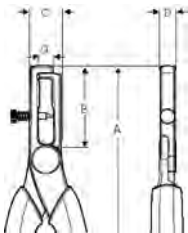

	 731415		A mm	B mm	C mm	D mm	G mm	 mm	AWG	 g
2223 S-150	0032983	3	167	46	15	8	8	0.5-5	4-23	170

2806







CABLE CUTTERS

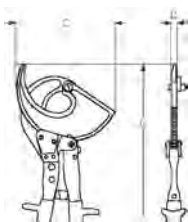

- Insulated cable cutters
- For work on live equipment up to 1000 volts
- IEC 60900
- 3 layer colour insulation coating
- For cutting copper and aluminium cables
- Not suitable for hard copper, steel cables or internal steel wire cables
- Single hand operation, easy release of the moving jaw
- Clean and smooth cut without distortion
- Cutting capacity
 - 1 Copper
 - 2 Aluminium

IEC 60900  1000V



	 731415		A mm	C mm	D mm	 1 mm	 2 mm	 g
2806-35V	0122103	2	255	106	16.5	35	35	800
2806-52V	0122110	1	340	141	17.5	52	52	900



2250V

CABLE CUTTERS



- Insulated cable cutters
- For work on live equipment up to 1000 volts
- IEC 60900, VDE certified
- Chrome plated and anti-corrosion treated finish
- High performance alloy steel
- 3 layer colour insulation coating
- The 170 mm version has a maximum opening of 15 mm and the 230 mm version has a maximum opening of 22 mm

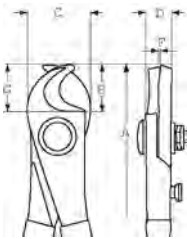

	 731415		A mm	B mm	C mm	D mm	F mm	G mm	 mm	 g
2250V-170	0128730	2	170	17	28	10	9.0	18	0-10	210
2250V-230	0128747	2	230	22	35	13	12.0	27	0-15	425

2260V

CABLE CUTTERS



- Insulated cable cutters
- For work on live equipment up to 1000 volts
- IEC 60900, VDE certified
- Black oxidized and anti-corrosion treated finish
- High performance alloy steel
- 3 layer colour insulation coating
- Maximum opening: 25 mm
- Cutting capacity: 18 mm Cu/Al
- Not suitable for steel cables

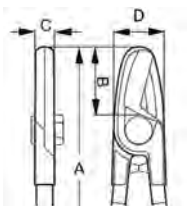

	 731415		A mm	B mm	C mm	D mm	 g
2260V-210	0128754	2	210	30	11	32	375

2520S





CABLE CUTTERS

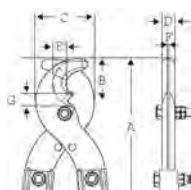

IEC 60900  1000V



- Insulated cable cutters
- For work on live equipment up to 1000 volts
- IEC 60900
- Black oxidized and anti-corrosion treated finish
- High performance alloy steel
- 3 layer colour insulation coating
- For aluminium or copper cables
- For a maximum service life, ferrous metal should only be cut with the noched part of the blades
- Cutting capacity: 30 mm diameter of Al/Cu with a messenger wire of hard steel of maximum 6 mm diameter
- 2520-SH: spare blades, screws and nut

	 731415		A mm	B mm	C mm	D mm	E mm	F mm	G mm	 g
2520 S	0033041	1	552	54	69.5	16	15	8	13	2200
2520-SH	8197506	1	220	54	69.5	15	16	8	13	800

2820VBC

BOLT CUTTER



IEC 60900  1000V

- Insulated bolt cutters
- For work on live equipment up to 1000 volts
- IEC 60900
- Induction hardened cutting edges
- 3 layer colour insulation coating
- Long arms with lever action head allow cutting hard wires with less effort
- For 80 kg/mm² a wire type Ø of 9 mm², for 120 kg/mm² a wire type Ø of 8 mm and for 160 kg/mm²; a wire type Ø of 7 mm

	 731415		 L mm	 g
2820VBC	0121915	1	630	3100



6224V

SLIP JOINT PLIERS



- Insulated slip joint pliers
- For work on live equipment up to 1000 volts
- ISO 8976, IEC 60900
- Chrome plated and anti-corrosion treated finish
- High performance alloy steel
- 3 layer colour insulation coating
- Slim head for good accessibility
- Machined groove joint for higher stability

IEC 60900 1000V

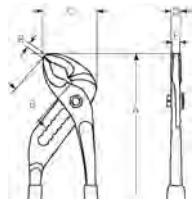

	731415		A mm	B mm	C mm	D mm	E mm	F mm	mm	g
6224V	0128761	2	250	35	46	10	7	10	32	445

2619V

SLIP JOINT PLIERS



- Insulated box joint slip joint pliers
- For work on live equipment up to 1000 volts
- ISO 8976, IEC 60900
- Black finish and anti-corrosion treated
- High performance alloy steel
- 3 layer colour insulation coating

IEC 60900 1000V

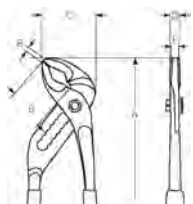

	731415		A mm	B mm	C mm	D mm	E mm	F mm	mm	g
2619V-250	0128778	2	250	32	40	14.5	4.0	7.0	30	463
2619V-300	0128853	2	300	40	50	15.0	5.5	9.0	39	635





8070V - 8074V

ADJUSTABLE WRENCH

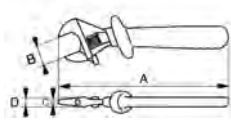

- Insulated adjustable wrench
- For work on live equipment up to 1000 volts
- ISO 6787, IEC 60900, VDE certified
- High performance alloy steel
- Chrome plated and anti-corrosion treated finish
- 3 layer colour insulation coating
- The moveable jaw slides easily by operating the thumb screw



	 731415		A mm	B mm	C mm	D mm	 g
8070V	0121519	2	165	20	5.5	12	175
8071V	0121526	2	205	24	7.5	13.5	250
8072V	0121533	2	260	29	9	16	405
8073V	0121540	2	310	36	11	19	650
8074V	0121557	2	390	43	13	24	1350





8071VLT - 8073VLT

ADJUSTABLE WRENCH

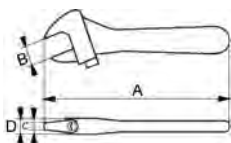

- Insulated adjustable wrench
- For work on live equipment up to 1000 volts
- IEC 60900
- High performance alloy steel
- Chrome plated and anti-corrosion treated finish
- 3 layer colour insulation coating
- The moveable jaw slides easily by operating the side screw



	 731415		A mm	B mm	C mm	D mm	 g
8071VLT	0121564	1	205	29	8	14	330
8072VLT	0121571	1	255	34	9	17	650
8073VLT	0121588	1	305	39	10	20	1000



6MV

OPEN END WRENCHES



- Insulated open end wrenches
- For work on live equipment up to 1000 volts
- IEC 60900, opening tolerance according to ISO 691, VDE certified
- High performance alloy steel
- 2 layer colour insulation coating 6-16 mm wrenches
- 3 layer colour insulation coating 17-32 mm wrenches

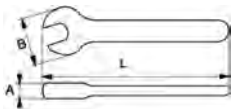

	 731415		 mm	L mm	A mm	B mm	 g
6MV-6	0120833	5	6	92	3.7	15.0	25
6MV-7	0120840	5	7	92	3.7	17.5	30
6MV-8	0120857	5	8	92	4.0	18.0	40
6MV-9	0120864	5	9	98	4.0	21.0	45
6MV-10	0120871	5	10	108	5.0	24.0	55
6MV-11	0120888	5	11	116	5.0	26.0	60
6MV-12	0120895	5	12	125	5.5	28.0	70
6MV-13	0120901	5	13	135	5.5	31.0	75
6MV-14	0120918	5	14	140	6.0	31.0	85
6MV-15	0120925	5	15	150	6.0	33.0	90
6MV-16	0120932	5	16	157	6.5	34.0	105
6MV-17	0120949	3	17	162	6.5	37.0	120
6MV-18	0120956	3	18	170	7.0	39.0	145
6MV-19	0120963	3	19	175	7.0	42.0	150
6MV-20	0120970	3	20	180	7.5	43.0	170
6MV-21	0120987	3	21	184	7.5	46.0	190
6MV-22	0120994	3	22	193	7.5	47.0	190
6MV-23	0121007	3	23	203	8.0	49.0	220
6MV-24	0121014	3	24	210	8.5	51.0	275
6MV-27	0121021	2	27	225	9.5	59.0	370
6MV-30	0121038	2	30	240	10.0	63.0	470
6MV-32	0121052	2	32	250	10.0	68.0	530

6MV/

OPEN END WRENCHES



- Insulated open end wrenches, 8 pcs
- For work on live equipment up to 1000 volts
- In black plastic pouch

	 731415			 g
6MV/8T	0122141	1	8	880



6MV
10 11 12 13 14 17 18 19 mm







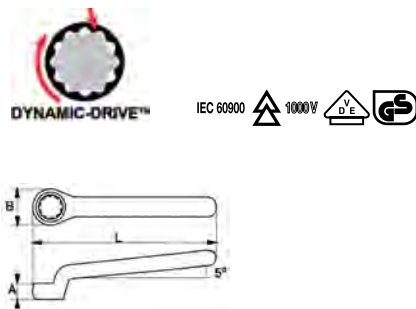

2MV

OFFSET RING WRENCHES



- Insulated offset ring wrenches
- For work on live equipment up to 1000 volts
- IEC 60900, opening tolerance according to ISO 691, VDE certified
- High performance alloy steel
- 3 layer colour insulation coating
- 12 point Dynamic-Drive Profile



	 731415		 mm	L mm	A mm	B mm	 g
2MV-6	0121069	5	6.0	140	5.0	10.5	50
2MV-7	0121083	5	7.0	145	6.0	12.0	55
2MV-8	0121090	5	8.0	150	6.0	13.0	70
2MV-9	0121106	5	9.0	155	6.5	14.5	75
2MV-10	0121113	5	10.0	160	7.0	16.0	80
2MV-11	0121120	5	11.0	170	7.5	18.0	90
2MV-12	0121137	5	12.0	180	8.0	18.5	100
2MV-13	0121144	5	13.0	180	8.5	20.5	105
2MV-14	0121151	5	14.0	190	8.5	22.0	130
2MV-15	0121168	5	15.0	195	9.5	24.0	140
2MV-16	0121175	5	16.0	200	9.5	24.5	150
2MV-17	0121182	3	17.0	205	10.0	26.5	160
2MV-18	0121199	3	18.0	215	10.5	27.0	210
2MV-19	0121205	3	19.0	225	11.0	29.0	230
2MV-21	0121212	3	21.0	235	12.0	32.0	280
2MV-22	0121229	3	22.0	245	12.0	33.0	300
2MV-23	0121236	3	23.0	255	13.0	35.0	320
2MV-24	0121243	3	24.0	265	13.0	35.0	350





28MV

T-HANDLE

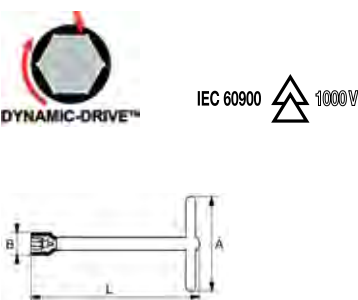

- Insulated T-handle
- For work on live equipment up to 1000 volts
- IEC 60900, opening tolerance according to ISO 691
- High performance alloy steel
- 3 layer colour insulation coating
- 6 point Dynamic-Drive Profile



	 731415		 mm	L mm	A mm	B mm	 g
28MV-8	0121274	2	8.0	200	130	16.5	101
28MV-9	0121281	2	9.0	200	130	18.0	143
28MV-10	0121298	2	10.0	200	130	19.5	150
28MV-11	0121304	2	11.0	200	130	20.5	159
28MV-12	0121311	2	12.0	200	140	22.0	216
28MV-13	0121328	2	13.0	200	140	23.0	260
28MV-14	0121335	2	14.0	200	140	24.5	272
28MV-15	0121342	2	15.0	200	140	25.5	312
28MV-16	0121359	2	16.0	200	140	27.0	322
28MV-17	0121366	2	17.0	200	140	28.0	331
28MV-18	0121373	2	18.0	200	140	29.5	421
28MV-19	0121380	2	19.0	200	140	30.5	435
28MV-20	0121397	2	20.0	200	140	32.5	515
28MV-21	0121403	2	21.0	200	140	33.0	531
28MV-22	0121410	2	22.0	200	140	34.5	579



2820V

CROSS RIM WRENCHES



- Insulated cross rim wrenches
- For work on live equipment up to 1000 volts
- IEC 60900, opening tolerance according to ISO 691
- High performance alloy steel
- 2 layer colour insulation coating
- 6 point opening

IEC 60900 1000V

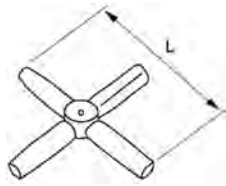

	 731415		 mm	L mm	 g
2820V13	0121823	1	7x9x11x13	210	420
2820V17	0121830	1	8x10x13x17	210	420

1999MV

HEXAGONAL KEY WRENCH



- Insulated hexagonal key wrench
- For work on live equipment up to 1000 volts
- IEC 60900
- High performance alloy steel
- 3 layer colour insulation coating

IEC 60900 1000V

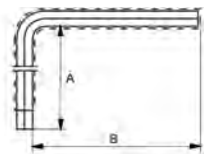

	 731415		 mm	A mm	B mm	 g
1999MV-3	0121427	5	3	118.5	78.5	25
1999MV-4	0121434	5	4	118	78	35
1999MV-5	0121441	5	5	117.5	77.5	50
1999MV-6	0121458	5	6	117	87	75
1999MV-7	0121465	5	7	116.5	91.5	100
1999MV-8	0121472	5	8	116	100	145
1999MV-9	0121489	5	9	115.5	100	170
1999MV-10	0121496	3	10	115	110	210
1999MV-12	0121502	3	12	114	124	300



7800DMV

SOCKETS 1/2"



- Insulated 1/2" socket
- For work on live equipment up to 1000 volts
- ISO 2725, IEC 60900, VDE certified
- High performance alloy steel
- 2 layer colour insulation coating
- 12 point Dynamic-Drive Profile
- Not suitable for machine operation

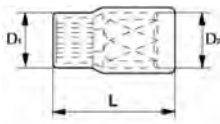

	 731415		 mm	L mm	D1 mm	D2 mm	 g
7800DMV-8	0121649	10	8	50	17	22	80
7800DMV-10	0121656	10	10	50	19.5	22	82
7800DMV-11	0121663	10	11	50	20.5	22	84
7800DMV-12	0121670	10	12	50	22	22	86
7800DMV-13	0121687	10	13	50	23.2	22	88
7800DMV-14	0121694	10	14	50	24.5	22	90
7800DMV-15	0121700	10	15	50	25.5	23	92
7800DMV-16	0121717	10	16	50	27	23	95
7800DMV-17	0121724	10	17	50	28.2	24	98
7800DMV-18	0121731	10	18	50	29.5	25	105
7800DMV-19	0121748	10	19	50	30.5	27	115
7800DMV-20	0121755	10	20	50	32	28	125
7800DMV-21	0121762	10	21	50	33.2	29	135
7800DMV-22	0121779	10	22	52	34.5	30	140
7800DMV-24	0121786	5	24	52	37	33	155
7800DMV-27	0121793	5	27	54	40.5	37	195
7800DMV-30	0121809	5	30	56	44.5	40	210
7800DMV-32	0121816	5	32	58	47	43	225

8150-1/2V

RATCHET 1/2"



- Insulated 1/2" ratchet
- For work on live equipment up to 1000 volts
- ISO 3315/1174-2, IEC 60900, VDE certified
- High performance alloy steel
- 3 layer colour insulation coating
- 28 teeth ratchet to operate at a 13° angle
- One button changes the ratchet direction and the other button locks or releases the socket to the male square drive

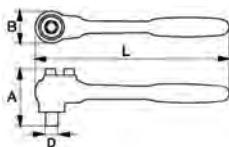

	 731415		L mm	A mm	B mm	D mm	 g
8150-1/2V	0121601	1	270	77	50	12.5	735



8154-1/2V

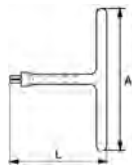

T-HANDLE 1/2"

- Insulated 1/2" T-handle
- For work on live equipment up to 1000 volts
- ISO 3315/1174-2, IEC 60900, VDE certified
- High performance alloy steel
- 2 layer colour insulation coating
- The male square drive has a slotted screw to move the ball outwards or inwards and lock or unlock the socket

	 731415		L mm	A mm	 g
8154-1/2V	0121595	1	200	190	520

8160-1/2V - 8162-1/2V

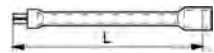

EXTENSION 1/2"

- Insulated 1/2" extension
- For work on live equipment up to 1000 volts
- ISO 3316/1174-2, IEC 60900, VDE certified
- High performance alloy steel
- 2 layer colour insulation coating
- The male square drive has a slotted screw to move the ball outwards or inwards and lock or unlock the socket

	 731151		 L mm	 g
8160-1/2V	0121618	1	125	230
8162-1/2V	0121625	1	250	390

7811DMV



SOCKET SETS 1/2"

- Insulated 1/2" socket set, 11 pcs
- For work on live equipment up to 1000 volts
- Shock resistant plastic case

	 731415		 mm	 g
7811DMV	0122134	1	320x300x100	2800

7800DMV
10, 11, 13, 17, 19, 20, 22 mm



8150-1/2V
270 mm



8154-1/2V
200 mm



8160-1/2V
125 mm



813VDE-5.5-125
1.0x5,5x125





SC127V

SCISSORS



- Insulated scissors
- For work on live equipment up to 1000 volts
- IEC 60900
- 1 layer colour insulation coating
- Small groove in the blade for stripping cables

IEC 60900  1000V

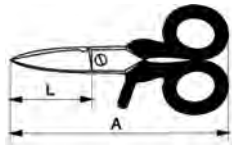

	 731415		L mm	A mm	 g
SC127V	0121847	5	50	130	100

SC150NGV

SCISSORS



- Insulated scissors
- For work on live equipment up to 1000 volts
- IEC 60900
- 2 layer colour insulation coating

IEC 60900  1000V

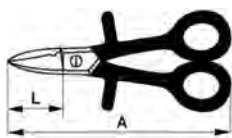

	 731415		L mm	A mm	 g
SC150NGV	0121854	5	38	150	170

2820HSV1





METAL CUTTING SAWS

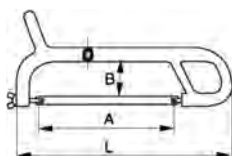

- Insulated hacksaw
- For work on live equipment up to 1000 volts
- IEC 60900
- 3 layer colour insulation coating
- Supplied with reliable and shatterproof Sandflex® bi-metal blade 18TPI with excellent cutting performance and wear resistance

IEC 60900  1000V



	 731415		A mm	B mm	L mm	 g
2820HSV1	0121878	1	300	70	450	1100



OTHER INSULATED TOOLS

2820HSV2

METAL CUTTING SAWS



- Insulated hacksaw
- For work on live equipment up to 1000 volts
- IEC 60900
- 3 layer colour insulation coating
- Supplied with reliable and shatterproof Sandflex® bi-metal blade 18TPI with excellent cutting performance and wear resistance
- Hand guard for ultimate protection

IEC 60900 1000V

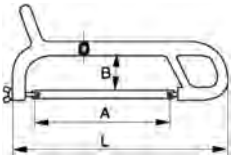

	731415		A mm	B mm	L mm	g
2820HSV2	0121861	1	300	70	450	1360

2820VP

STRAIGHT KNIFE



- Insulated knife
- For work on live equipment up to 1000 volts
- IEC 60900, VDE certified
- 3 layer colour insulation coating

IEC 60900 1000V

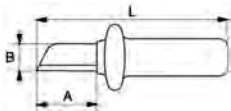

	731415		A mm	B mm	L mm	g
2820VP	0121885	2	50	22	180	130

2820VPC

CURVED KNIFE



- Insulated knife
- For work on live equipment up to 1000 volts
- IEC 60900, VDE certified
- 3 layer colour insulation coating

IEC 60900 1000V

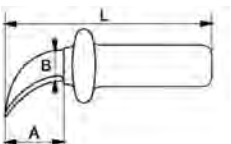

	731415		A mm	B mm	L mm	g
2820VPC	0121892	2	50	23	180	170



2820VHELP





CURVED KNIFE WITH GUIDE

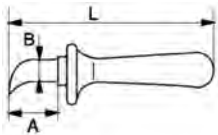

- Insulated knife with guide
- For work on live equipment up to 1000 volts
- IEC 60900
- 1 layer injection moulded insulation

IEC 60900  1000V



	 731415		A mm	B mm	L mm	 g
2820VHELP	0121908	1	38	20	180	70



2820VDE

CABLE KNIFE WITH PLASTIC PROTECTIVE CAP



- Insulated cable knife
- For work on live equipment up to 1000 volts
- IEC 60900
- 1 layer injection moulded insulation

IEC 60900  1000V

	 731415		 L mm	 g
2820VDE	1605476	1	180	95

2820VTEE

TWEEZERS



- Insulated tweezers
- For work on live equipment up to 1000 volts
- IEC 60900
- 2 layer colour insulation coating

IEC 60900  1000V

	 731151		 L mm	 g
2820VTEE	0121939	1	150	50



2820VFP

FUSE PULLER



IEC 60900  1000V

- Insulated fuse puller glove to hold NH fuses, sizes 00-3
- For work on live equipment up to 1000 volts
- IEC 60269-2-1 ed. 04.2002, DIN VDE 0636-201 ed.02.2003, DIN 57680-4 ed.11.1980, VDE certified
- Is operated from the inside by a locking and unlocking system
- Anti-slide protection and unlocking button

	 731415		 g
2820VFP	0121922	1	458

2820VM

INSULATING MAT



- Insulating mat
- For work on live equipment up to 5000 volts AC
- IEC60900, DIN VDE 0680 part 1: 1990-05, VDE certified
- Earth connection when operating live systems is avoided by standing on an insulated mat

	 731415		 mm	 g
2820VM	0121946	1	1000 x 1000	5555







2820VG

INSULATING GLOVES



- Insulated gloves
- 2820VG05 for work on live equipment up to 500 V AC and 750 V DC, material thickness 0.5 mm
- 2820VG10 for work on live equipment up to 1000 V AC and 1500 V DC, material thickness 1.0 mm
- IEC 61482-1, EN 60903
- Offers protection against electric arcs according to CENELEC ENV 50354 class 2 and IEC 61482-1
- Made of natural latex for anatomical fit, flexibility and dexterity
- Temperature resistant from -40°C to 90°C
- Size 10



	 731415		 g
2820VG05	0121953	1	235
2820VG10	0121960	1	240

2820VGCOT

COTTON GLOVES



- Cotton gloves to be used underneath insulated gloves
- THIS ITEM IS NOT INSULATED AND HAS TO BE USED WITH INSULATED GLOVES
- One size

	 731415		 g
2820VGCOT	0121977	1	30



3045/1VDE

ELECTRICIAN'S TOOL SET



- Tool set with a basic assortment of insulated tools, 10 pcs
- For work on live equipment up to 1000 volts
- In foldable case



	 731415		 g
3045/1VDE	1783815	1	1700

BE-8220S, BE-8230S, BE-8240S, BE-8250S, BE-8255S, BE-8065S
0.5x3x100, 0.6x3.5x100, 0.8x4x100, 1.0x5.5x125, 1.2x6.5x150, 1.2x8x175 mm



BE-8620S
PH-2



2665VDE
180 mm



2457VDE
160 mm



2674NVDE
160 mm



3045V-1

INSULATED TOOLS SET



- Tool set with a basic assortment of insulated tools, 10 pcs
- For work on live equipment up to 1000 volts
- In leather briefcase with metallic reinforcements



	 731415		 mm	 g
3045V-1	0128785	1	330x240x60	2000

2171V
160 mm



2678V
180 mm



2223V



BE-8220S, BE-8040S, BE-8050S
3x100, 4x100, 5,5x125



BE-8610S, BE-8620S
PH1x80, PH2x100



2820VP



SC127V



3045V-2

INSULATED TOOLS SET



- Tool set with a basic assortment of insulated tools, 19 pcs
- For work on live equipment up to 1000 volts
- In leather briefcase with metal reinforcements



	 731415		 mm	 g
3045V-2	0128792	1	430x260x160	5500

2171V
160 mm



2678V
180 mm



2430V
160 mm



2223V



BE-8220S BE-8040S BE-8050S BE-8255S
3x100, 4x100, 5,5x125, 6,5x150



BE-8610S BE-8620S
PH1x80, PH2x100



6MV
10, 11, 12, 13, 14, 17, 19



2820VP



SC150NGV



TWEEZERS & ELECTRONICS SPECIALITY TOOLS

Bahco offers a wide range of tweezers and speciality tools for electronics such as soldering irons, all designed for the most demanding jobs where precision is of the utmost importance. Our tweezers have perfect balance, with tip alignment and symmetry to meet the most sophisticated and demanding requirements. Our soldering range gives all you need for soft soldering - a method of producing reliable electrical connections.



Chapter Index

TWEEZERS, BELZER	900-914
SOLDERING	915-919
FINE MECHANICAL	919-928





5468

GENERAL PURPOSE TWEEZERS

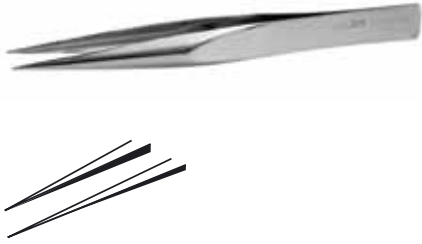

- General purpose tweezer
- Material: Hardened steel
- Finish: Polished
- Serrated tips

	 731415			 L mm	 g
5468-112	1085247	5	BB-Ni	112	12

5469

GENERAL PURPOSE TWEEZERS

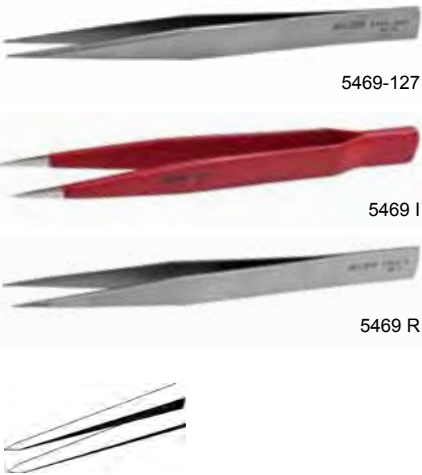

- General purpose tweezer
- Material:
 - 5469-127 & 5469 I: Hardened steel
 - 5469 R: Stainless steel, anti-magnetic
- Finish:
 - 5469-127 & 5469 R: Polished
 - 5469 I: PVC coated

	 731415			 L mm	 g
5469-127	1085285	5	AA-Ni	127	20
5469 R	1085421	5	AA-SA	127	20
5469 I	1085407	5	AA-I	127	20

5469B

GENERAL PURPOSE TWEEZERS

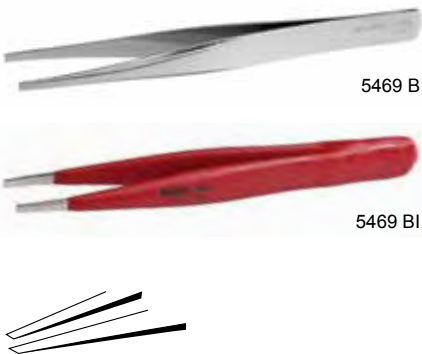

- General purpose tweezer
- Material:
 - 5469 B & 5469 BI: Hardened steel
 - 5469 BR: Stainless steel, anti-magnetic, anti-acid
- Finish:
 - 5469 B & 5469 BR: Polished
 - 5469 BI: PVC coated
- Tips 2 mm wide

	 731415			 L mm	 g
5469 B	1085322	5		120	17
5469 BI	1085346	5		120	23
5469 BR	1085384	5		120	18



5471F

GENERAL PURPOSE TWEEZERS



5471 F



5471 FI



- General purpose tweezer
- Material:
 - 5471 F & 5471 FI: Hardened steel
 - 5471 FR: Stainless steel, anti-magnetic
- Finish:
 - 5471 F: Polished and nickel plated
 - 5471 FI: PVC coated
 - 5471 FR: Polished
- Rounded and finely serrated jaws

	 731415		 L mm	 g
5471 F-120	1085681	5	120	22
5471 F-145	1085704	5	145	25
5471 F-200	1085728	5	200	35
5471 F-250	1085742	5	250	40
5471 F-300	1085766	5	300	45
5471 FI-120	1085780	5	120	22
5471 FI-145	1085803	5	145	25
5471 FI-200	1085827	5	200	35
5471 FR-120	1085889	5	120	22
5471 FR-145	1085902	5	145	25

5475R/5475K

GENERAL PURPOSE TWEEZERS



5475 R

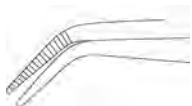

- General purpose tweezers with offset, finely serrated tips
- Material:
 - 5475 R: Stainless steel, anti-magnetic, anti-acid with hardened jaws
 - 5475 K: Special steel with hardened jaws
- Finish:
 - 5475 R: Polished
 - 5475 K: Polished, nickel plated

	 731415		 L mm	 g
5475 R	1086268	5	150	27
5475 K	1086244	5	100	10



5516

GENERAL PURPOSE TWEEZERS



- General purpose tweezers
- Material: Special hardened steel
- Finish:
 - 5516: Polished and nickel plated
 - 5516 I: PVC coated

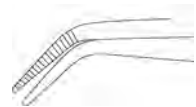

	 731415		 L mm	 g
5516	1086992	5	150	22
5516 I	1087029	5	150	30

5540AM

SMD TWEEZERS



- Tweezer for handling and positioning SOT packages
- Material: Stainless steel, anti-magnetic, anti-acid
- Finish: Anti-glare micro-matt finish

	 731415			 L mm	 g
5540 AM	1821319	5	SM104-SA	120	14

5541AM

SMD TWEEZERS



- Tweezer for positioning all SOT packages vertically
- Material: Stainless steel, anti-magnetic, anti-acid
- Finish: Anti-glare micro-matt finish

	 731415			 L mm	 g
5541 AM	1821326	5	SM105-SA	120	14



5543AM

SMD TWEEZERS



- Tweezer for positioning SOT devices at 30° angle
- Material: Stainless steel, anti-magnetic, anti-acid
- Finish: Anti-glare micro-matt finish

	 731415			 L mm	 g
5543 AM	1821340	5	SM117-SA	120	14

5544AM

SMD TWEEZERS



- Tweezer for handling and positioning 2 and 3 lead SOT packages at 45° angle
- Material: Stainless steel, anti-magnetic, anti-acid
- Finish: Anti-glare micro-matt finish

	 731415			 L mm	 g
5544 AM	1821357	5	SM103-SA	115	15

5545AM

SMD TWEEZERS



- Tweezer for positioning flat devices at 60° angle
- Material: Stainless steel, anti-magnetic, anti-acid
- Finish: Anti-glare micro-matt finish

	 731415			 L mm	 g
5545 AM	1821364	5	SM107-SA	120	14

5546AM

SMD TWEEZERS



- Tweezer with grooved tips for positioning and soldering 1 mm components
- Material: Stainless steel, anti-magnetic, anti-acid
- Finish: Anti-glare micro-matt finish

	 731415			 L mm	 g
5546 AM	1821371	5	SM108-SA	120	14



TWEEZERS, BELZER

5547AM

SMD TWEEZERS



- Tweezer with grooved tips for positioning and soldering 1 mm components at 45° angle
- Material: Stainless steel, anti-magnetic, anti-acid
- Finish: Anti-glare micro-matt finish

	 731415			 L mm	 g
5547 AM	1821388	5	SM109-SA	120	14

5549AM

SMD TWEEZERS



- Tweezer with grooved tips for positioning 5 mm monolithic chip capacitors
- Material: Stainless steel, anti-magnetic, anti-acid
- Finish: Anti-glare micro-matt finish

	 731415			 L mm	 g
5549 AM	1821401	5	SM111-SA	120	14

5583AM

SMD TWEEZERS



- Tweezer with reverse action for soldering and de-soldering 8, 14, 16 lead SMDs
- Material: Stainless steel, anti-magnetic, anti-acid
- Finish: Anti-glare micro-matt finish

	 731415			 L mm	 g
5583 AM	1821296	5	SM101-SA	115	12

5584AM

SMD TWEEZERS



- Tweezer with reverse action, for soldering and de-soldering 20, 28, 44, 68 LCCC and PCCC pad devices
- Material: Stainless steel, anti-magnetic, anti-acid
- Finish: Anti-glare micro-matt finish

	 731415			 L mm	 g
5584 AM	1821302	5	SM102-SA	115	12



5586AM

SMD TWEEZERS



- Tweezer with reverse action, for handling SMDs
- Material: Stainless steel, anti-magnetic, anti-acid
- Finish: Anti-glare micro-matt finish

	 731415			 L mm	 g
5586 AM	1821289	5	SM100-SA	115	13

5587GAM

SMD TWEEZERS



- Tweezer with 3 mm long tips, bent at 60° angle
- Material: Stainless steel, anti-magnetic, anti-acid
- Finish: Anti-glare micro-matt finish

	 731415			 L mm	 g
5587 GAM	1821425	5	SM113-SA	120	14

5588AM

SMD TWEEZERS



- Tweezer with grooved tips for positioning 5 mm monolithic chip at 60° angle
- Material: Stainless steel, anti-magnetic, anti-acid
- Finish: Anti-glare micro-matt finish

	 731415			 L mm	 g
5588 AM	1821432	5	SM112-SA	120	13

5589AM

SMD TWEEZERS



- Tweezer with grooved tips, 30° angle
- Material: Stainless steel, anti-magnetic, anti-acid
- Finish: Anti-glare micro-matt finish

	 731415			 L mm	 g
5589 AM	1821449	5	SM115-SA	120	13



5590AM

SMD TWEEZERS

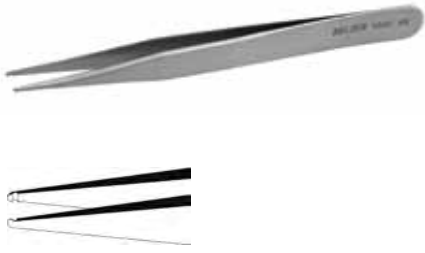

- Tweezer with grooved tips for vertical positioning of cylindrical devices \varnothing 1 mm or more
- Material: Stainless steel, anti-magnetic, anti-acid
- Finish: Anti-glare micro-matt finish

	 731415			 L mm	 g
5590 AM	1821456	5	SM116-SA	120	14

5463AMT

TITANIUM TWEEZERS



- Precision tweezers for fine and ultra-fine assembly work
- Material: Titanium, anti-magnetic, high corrosion resistance
- Finish: Polished
- Anti-glare, extremely light and without sharp edges
- Micro-fine tips

	 731415			 L mm	 g
5463 AMT	1085025	5	3-TA	120	9

5465AMT

TITANIUM TWEEZERS

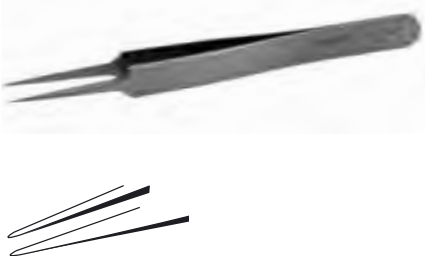

- Precision tweezers for fine and ultra-fine assembly work
- Material: Titanium, anti-magnetic, high corrosion resistance
- Finish: Polished
- Anti-glare, extremely light and without sharp edges
- Micro-fine tips

	 731415			 L mm	 g
5465 AMT	1085148	5	5-TA	110	7

5469AMT

TITANIUM TWEEZERS

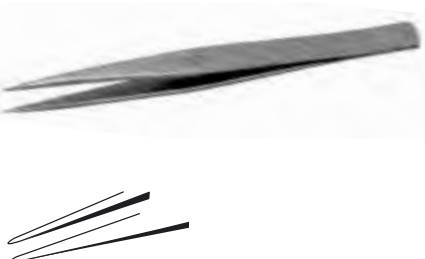

- Precision tweezers for fine and ultra-fine assembly work
- Material: Titanium, anti-magnetic, high corrosion resistance
- Finish: Polished
- Anti-glare and extremely light
- No sharp edges
- Micro-fine tips

	 731415			 L mm	 g
5469 AMT	1085308	5	AA-TA	125	10



5467AM

ANTI-MAGNETIC TWEEZERS



- Tweezers for fine and ultra-fine assembly work
- Material: Stainless steel, anti-magnetic, anti-acid
- Finish: Polished

	 731415			 L mm	 g
5467 AM	1085209	5	7-SA	115	13

5469AMI

ANTI-MAGNETIC TWEEZERS



- Tweezers for fine and ultra-fine assembly work
- Material: Stainless steel, anti-magnetic, anti-acid
- Finish: PVC coated

	 731415			 L mm	 g
5469 AMI	1337803	5	AA-SA	130	17

5463

WATCHMAKER'S TWEEZERS

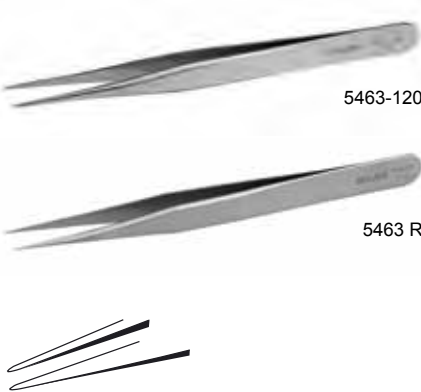

- Watchmaker's tweezers
- Material:
 - 5463-120: Special hardened steel, anti-magnetic
 - 5463 R: Stainless steel, anti-magnetic, anti-acid
- Finish: Polished

	 731415			 L mm	 g
5463-120	1085001	5	3-Ni	120	13
5463 R	1085063	5	3-SA	120	13

5464

WATCHMAKER'S TWEEZERS



- Watchmaker's tweezers
- Material:
 - 5464-105: Special hardened steel, anti-magnetic
 - 5464 R: Stainless steel, anti-magnetic, anti-acid
- Finish: Polished

	 731415			 L mm	 g
5464-105	1085087	5	4-Ni	110	11
5464 R	1085100	5	4-SA	110	11



TWEEZERS, BELZER

5465

WATCHMAKER'S TWEEZERS



- Watchmaker's tweezers
- Material: Stainless steel, anti-magnetic, anti-acid
- Finish: Polished

	 731415			 L mm	 g
5465 R	1085162	5	5-SA	105	11

5467

WATCHMAKER'S TWEEZERS



- Watchmaker's tweezers
- Material: Hardened stainless steel, anti-magnetic, anti-acid
- Finish: Polished

	 731415			 L mm	 g
5467 R	1085223	5		105	11

5470

JEWELLER'S TWEEZERS



5470 R



5470 I



- Tweezers with rounded tips, jaws finely serrated
- Material:
 - 5470 & 5470 I: Special hardened steel
 - 5470 R: Stainless steel, anti-magnetic, anti-acid
- Finish:
 - 5470 & 5470 R: Polished, nickel plated
 - 5470 I: PVC coated

	 731415			 L mm	 g
5470-120	1085452	5		120	17
5470-140	1085445	5		140	20
5470-160	1085469	5		160	25
5470 R-140	1085568	5		140	20
5470 R-160	1085582	5		160	25
5470 I-140	1085506	5		140	20
5470 I-160	1085520	5		160	25

5473

NIPPING TWEEZERS



- Tweezers for nipping off thin wire
- Material: Special steel, hardened cutting edge
- Finish: Polished and nickel plated

	 731415			 L mm	 g
5473-90	1086183	5	D	90	22



5479

POINTED TWEEZERS



- Pointed tweezers
- Material: Special hardened steel
- Finish: Polished and nickel plated

	 731415		 mm	 g
5479-130	1086398	5	130	20

5517

POINTED TWEEZERS



5517



5517 I

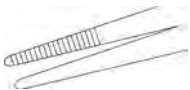

- Tweezers with straight finely forged tips
- Material: Special hardened steel
- Finish:
 - 5517: Polished and nickel plated
 - 5517 I: PVC coated

	 731415		 mm	 g
5517	1573843	5	155	22
5517 I	1573928	5	155	30

5518

REVERSE ACTION TWEEZERS



- Reverse action tweezers
- Material: Special hardened steel
- Finish: Polished and nickel plated

	 731415		 mm	 g
5518	1087043	5	155	32

5476H

SOLDERING TWEEZERS



- Soldering tweezers
- Material: Special hardened steel
- Finish: Polished, vulcanised fibre hand protection

	 731415			 mm	 g
5476 H	1086305	5	30-S	160	35



TWEEZERS, BELZER

5484R

BALL GRIPPING TWEEZERS



- Tweezers with perforated tips for gripping, holding and picking up balls
- Material: Hardened stainless steel, anti-magnetic
- Finish: Polished
- Hole diameter 1.5 mm for balls of 2 to 2.5 mm diameter

	 731415		 L mm	 g
5484 R	1086633	5	145	25

5571

ASSEMBLY TWEEZERS



- Tweezers for inserting and de-soldering vertical components
- Material: Stainless steel, anti-magnetic, anti-acid
- Finish: Polished
- Smooth jaws to protect components
- Fitting components of 2.5 mm to 5 mm diameter

	 731415			 L mm	 g
5571-145	1472818	5	571-SA	145	25

5572

ASSEMBLY TWEEZERS

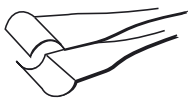

- Tweezers for inserting and de-soldering vertical components
- Material: Stainless steel, anti-magnetic, anti-acid
- Finish: Polished
- Smooth jaws to protect components
- Fitting components of 2.5 to 5 mm diameter, jaw width 6 mm

	 731415			 L mm	 g
5572-145	1473037	5	572-SA	145	26

5573

ASSEMBLY TWEEZERS

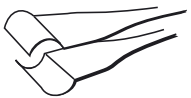

- Tweezers for diagonal inserting and de-soldering between several circuit board levels
- Material: Stainless steel, anti-magnetic, anti-acid
- Finish: Polished
- Fitting components of 2.5 to 5 mm diameter, jaw width 6 mm

	 731415			 L mm	 g
5573-145	1473112	5	573-SA	145	25



5578

ASSEMBLY TWEEZERS



- Tweezers for inserting and de-soldering horizontal components
- Material: Stainless steel, anti-magnetic, anti-acid
- Finish: Polished
- For fitting components up to 2 mm diameter, jaw width 4 mm

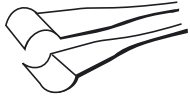

	 731415			 L mm	 g
5578-115	1547769	5	578-SA	122	12

5579

ASSEMBLY TWEEZERS



- Tweezers for inserting and de-soldering horizontal components
- Material: Stainless steel, anti-magnetic, anti-acid
- Finish: Polished
- For fitting components up to 2 mm diameter

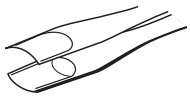

	 731415			 L mm	 g
5579-115	1547844	5	579-SA	115	12

5574

DE-SOLDERING TWEEZERS



- Tweezers with grippers for removing firmly seated round or cubic components
- Material: Stainless steel, anti-magnetic, anti-acid
- For fitting components up to 10 mm diameter, jaw width 6 mm



	 731415			 L mm	 g
5574-145	1473389	5	574B-SA	145	25

5575

GRIPPING TWEEZERS



- Tweezers for flat components such as small plate capacitors etc
- Material: Stainless steel, anti-magnetic
- Finish: Polished
- Jaw width 6 mm



	 731415			 L mm	 g
5575-145	1473464	5	574-SA	145	25



TWEEZERS, BELZER

5576

GRIPPING TWEEZERS

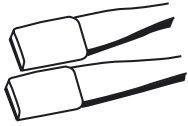

- Tweezers with smooth jaws to protect components
- Material: Stainless steel, anti-magnetic, anti-acid
- Finish: Polished, jaws hardened
- Soft-coated gripping tweezers for gripping ceramic components
- The coating is resistant to contact with soldering-iron tips of a temperature up to 350°C
- 5576-145R: Retail pack

	 731415			 L mm	 g
5576-145	1473549	5	574-SA	145	25
5576-145R	0115686	5	574-SA	145	25

5577

HEAT ABSORBING TWEEZERS

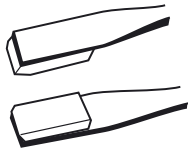

- Tweezers for soldering on semi-conductors, the copper-cooling jaws absorb the heat ahead of the component
- Material: Stainless steel, anti-magnetic, anti-acid
- Finish: Polished
- Jaw width 4 mm

	 731415			 L mm	 g
5577-145	1574062	5	574-SA	145	30

5570/7

SETS OF TWEEZERS

- For electronics engineers in manufacture and servicing jobs, in leatherette wallet



	 731415		 mm	 g
5570/7	1473891	1	115x245	255

5571



5575



5572



5576



5573



5577



5574





5488AM

ELECTRONICS TWEEZERS



- Tweezers with very fine points for holding the smallest of components
- Material: Stainless steel, anti-magnetic, anti-acid
- Finish: Anti-glare micro-matt finish



	 731415			 L mm	 g
5488 AM	1821166	5	5A-SA	115	15

5489AM

ELECTRONICS TWEEZERS



- Tweezers with very fine bent tips, for picking up flat lying components
- Material: Stainless steel, anti-magnetic, anti-acid
- Finish: Anti-glare micro-matt finish



	 731415			 L mm	 g
5489 AM	1821173	5	5C-SA	115	15

5490AM

ELECTRONICS TWEEZERS



- Tweezers with superfine points, for easy manipulation of components in confined areas
- Material: Stainless steel, anti-magnetic, anti-acid
- Finish: Polished



	 731415			 L mm	 g
5490 AM	1821180	5	7-SA	115	16

5491AM

ELECTRONICS TWEEZERS



- Very fine bent tips, for handling of miniature components
- Material: Stainless steel, anti-magnetic, anti-acid
- Finish: Polished



	 731415			 L mm	 g
5491 AM	1821197	5	65A-SA	140	13



TWEEZERS, BELZER

5492AM

ELECTRONICS TWEEZERS



- Reverse action tweezers for handling 14 - 16 pin IC's at 45° angle
- Material: Stainless steel, anti-magnetic, anti-acid
- Finish: Polished
- Gripping capacity: 40 mm

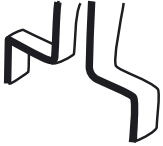

5492 AM	731415 1821227	5	29D-SA	155 mm	32 g

5493

CUTTING TWEEZERS



- Tweezers for clean cutting of copper wire
- Material: Stainless steel, anti-magnetic, anti-acid
- Finish: Polished

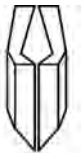

5493-115	731415 1821234	5	15AGW	115 mm	28 g

5568/5

SET OF SMD TWEEZERS



- Tweezers for universal application
- Material: Stainless steel, anti-magnetic, anti-acid
- Finish: Anti-glare micro-matt finish
- Size of plastic box 160 x 80 x 20 mm

5568/5	731415 1821210	1	100 g

5489AM



5583AM



5589AM



5584AM



5546AM





3250

SOLDERING GUN



- Instant heat double insulated soldering gun
- The tip reaches full working temperature in just seconds
- Its lightweight and balanced, pistol grip design is suitable for fast soldering jobs
- The plastic housing is 100% impact resistant
- Built-in light, perfect for confined spaces with little visibility
- Euro plug
- VDE certified



	 841334		V	W		 °C	 mm	 g
325001000	5000505	1	230	100	6"	400	210x165	640

3260

ELECTRONIC SOLDERING IRON



- Light compact and well balanced soldering iron
- Euro plug with earth connection

	 841334		V	W		 °C	 mm	 g
326000200	5000529	1	230	18	120"	390	182	150
326000300	5012881	1	230	25	120"	420	200	150

3260

ELECTRONIC SOLDERING IRON



- Spare tips for soldering gun:
 - 326010200: Ø 3.0 mm, valid for 326000200 and 327020400
 - 326020200: Ø 3.0 mm, valid for 326000300
 - 326030200: Ø 3.0 mm, valid for 326000200 and 327020400

	 841334		 g
326010200	5016100	1	5
326020200	5016117	1	5
326030200	5016124	1	5



SOLDERING

3295

ELECTRONIC SOLDERING IRON



- Sturdy and long lasting soldering iron
- It can be used in a variety of ways for soldering tasks in handicrafts, service and hobbies
- Heat resistant cable
- Delivery includes a practical, easily mounted rubber stick-on support disk
- Euro plug with earth connection
- VDE certified

	 731415		V	W		 °C	 L mm	 g
329500300	0181001	1	230	30	120"	380	250	190
329500400	0181018	1	230	40	120"	420	250	190

3295

ELECTRONIC SOLDERING IRON



- Spare tips for 329500300 and 329500400
- Both tips fit in both soldering irons:
 - 329500350: Chisel shaped
 - 329500450: Pencil shaped

	 731415		 g
329500350	0181049	1	5
329500450	0181056	1	5

3225

HEAVY DUTY SOLDERING IRON



- Heavy duty soldering iron ideal for industrial repairs and electrical work where a large tip mass is required
- Includes a soldering stand
- Euro plug with earth connection
- VDE certified

	 841334		V	W		 °C	 L mm	 g
322500300	5012829	1	230	30	180"	370	230	215
322500500	5012836	1	230	40	180"	375	582	235
322500800	5012843	1	230	80	180"	380	270	245



3225

HEAVY DUTY SOLDERING IRON



- Spare tips for heavy duty soldering iron 3225, straight and angled version:
 - 322510300: Straight tip for 322500300
 - 322510400: Angled tip for 322500300
 - 322510500: Straight tip for 322500500
 - 322510600: Angled tip for 322500500
 - 322510700: Angled tip for 322500800
 - 322510800: Straight tip for 322500800

	 841334		 g
322510300	5015899	1	10
322510400	5137386	1	10
322510500	5015905	1	10
322510600	5137393	1	10
322510700	5137409	1	10
322510800	5015912	1	10

3296

HEAVY DUTY SOLDERING IRON



- Designed for soldering operations with a greater heat requirements as, for example, on copper conductors with a cross section of 2.5 mm² (50 W), 4 mm² (80 W) or soldering thin metal sheets
- The soldering iron is supplied with an angled soldering tip
- Protective coating: Giving tips longer service life
- Includes a stand
- Euro plug with earth connection
- VDE certified

	 731415		V	W		 °C	 L mm	 g
329600500	0181025	1	230	50	180"	400	280	275
329600800	0181032	1	230	80	180"	410	330	345

3296

HEAVY DUTY SOLDERING IRON



- Spare tips for heavy duty soldering iron
 - 329600100 for soldering iron 329600500
 - 329600200 for soldering iron 329600800
- Protective coating: Giving tips longer service life

	 731415		 g
329600100	0181063	1	10
329600200	0181070	1	10



3270

TEMPERATURE CONTROLLED SOLDERING IRON



- The temperature can be easily adjusted with a screwdriver in order to achieve the required solder melting point
- Working temperature goes from 200 °C to 450 °C in steps of 50 °C
- Includes a soldering iron stand
- Euro plug with earth connection

	 841334		V	W		°C	mm	g
327020400	5012898	1	230	50	30"	200-450	280	180

3260

TEMPERATURE CONTROLLED SOLDERING IRON



- Spare tips for soldering iron:
 - 326010200: Ø3.0 mm, valid for 326000200 and 327020400
 - 326030200: Ø3.0 mm, valid for 326000200 and 327020400

	 841334		g
326010200	5016100	1	5
326030200	5016124	1	5

3280

DESOLDERING PUMP



- ESD safe desoldering pump made in plastic material for lightness

	 841334		g
328000000	5000734	1	58

3290

SOLDER



- A 0.8 mm lead-free solder ideal for use on micro electronics, fine wires and most of other electrical and electronic soldering applications
- Tin - lead has a melting point of 217 °C
- The tin - silver - copper solder provides a lower melting point, 207 °C, and a low resistance solder joint

	 841334		%	mm	g
329000330	5000741	1	0.75Cu 99.25 Sn	2	10
329000500	5000758	1	0.75 Cu 99.25 Sn	4	15
329000600	5000765	1	0.5Cu,2.5Ag,97.0Sn	2	10



3291

FLUX



- Alloy tin-copper, mixed with sand, flux and organic acids
- Cleans the surface in order to attain the best possible contact between the solder and the metal
- It is active with temperature and does not corrode when cooled down



329100540



841334

5000772



1



15

FINE MECHANICAL



BE-3529

O-RING LEVER

ergo®



- Handle developed according to the scientific ERGO™ process
- O-ring lever for de-soldering
- Finish: Steel grey, greased blade



BE-3529



731415

1847845



5



175



18

5418

DOUBLE END WIRE AND SPRING HOOK



- For gripping and adjusting wire connections
- For attaching and unhooking tension springs
- Finish: Chrome plated, with knurled hexagon handle
- Material: Stainless steel
- Hook internal diameter 1.5 mm



5418



731415

1084370



1



165



18



2633/

HOOKS AND PICKING TOOLS



- Miniature awls, hooks and picks
- For scribing, alignment, O-ring removal, piercing holes in leather or fabrics
- For cleaning in confined spaces
- Plastic handles with stainless steel blades
- 2633/S4 total length 130 mm
- 2633L/S4 total length 250 mm

	 731151		 mm	 g
2633/S4	8276942	12	150x80x17	80
2633L/S4	8276959	12	250x80x17	120

5419/6T

HOOK SET



- 5 different hooks which can be screwed in a handle
- 1 PVC insulated handle with female thread
- Plastic wallet
- Finish: Nickel plated

	 731415		 L mm	 g
5419/6T	1821562	1	200	45

5550

ADJUSTING SCREWDRIVER WITH GUIDE SLEEVE

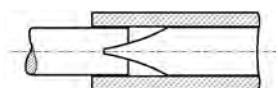

- For reliable adjusting of screw-type resistors and miniature potentiometers with slotted blades
- Blade length 75 mm
- Material: Blade of vanadium-extra
- Finish: Chrome plated, with plastic handle
- 5550-3.2 for slotted blades up to \varnothing 3.2 mm
- 5550-4.5 for slotted blades up to \varnothing 4.5 mm

	 731415		 L mm	 g
5550-3.2	1475673	5	140	14
5550-4.5	1475758	5	140	18



5551-5554

TUNING AND TRIMMING TOOLS



- Tuning and trimming tool
- Material: Plastic grip, moulded-in blades of resin acetate. For all tuning work on coil slugs and trimmers
- Blades:
 - 5551 0.3 x 2.5 & 0.5 x 3 mm
 - 5552 0.6 x 1.2 & 0.8 x 2 mm
 - 5553 slots 0.8 & 1.3 mm
 - 5554 0.3 x 2 & square 3 mm

	 731415		 L mm	 g
5551	1378479	1	220	5
5552	1378554	1	205	5
5553	1378639	1	195	5
5554	1378714	1	180	5

5600/4

SET OF TUNING AND TRIMMING TOOLS



- For all tuning work on radios and TV sets
- Plastic wallet 60 x 230 mm, with press-button fastener

	 731415		 g
5600/4	1436773	1	75

5551 0.3x2.5, 0.5x3 mm	
5552 0.6x1.2, 0.8x2 mm	
5553 0.8, 1.3 mm	
5554 0.3x2, 3 mm	

5423

DOUBLE END LAMP EXTRACTOR



- For jack lamps in telecommunications and processing equipment
- Fitting lamps with cap sizes T5.5 - T5.5K - T6.8 - B7s as per DIN 49838 and types SKANDIA, FRANCE and BPO-2
- Finish: Nickel plated spring sleeve with plastic centre piece

	 731415		 L mm	 g
5423	1509088	1	102	10



3524

THREE SQUARE SCRAPER



- Adjustable for very fine work
- Length: Blade 85 mm, holder 95 mm
- Finish: Fine-polished, handle nickel plated, blade forged
- 3524L-K: Blade only

	 731415		 g
3524	1073336	1	24
3524L-K	1339807	1	5

3525HB

THREE SQUARE MACHINIST'S SCRAPER



- With hollow blade, plastic handle and hand protection
- For very fine work
- Blade length 80 mm
- Finish: Polished, sheathed down to the tip
- Material: Vanadium-extra

	 731415		 L mm	 g
3525HB	1073350	5	165	40

2530

LACQUER STRIPPING TWEEZERS



- Finish: Black finish, with milled blades
- Material: Spring steel. Plastic coated grips
- 2530-40 with 40 ribs/inch and for wire 0.5 - 0.6 mm
- 2530-32 with 32 ribs/inch and for wire 0.7 - 1.0 mm

	 731415		 L mm	 g
2530-40	1317294	5	130	30
2530-32	1317300	5	130	30

2487

CARBON SCRAPER



- Rigid carbon scraper for gasket removal
- Durable plastic handle with carbon steel blade
- Blade 20 mm wide

	 731151		 L mm	 g
2487	8276058	12	210	125



2509

FLEXIBLE PICK-UP TOOL



- For gripping very small parts
- Maximum opening 14 mm
- Flexible shaft with steel core
- Finish: Chrome plated



2509



731415

1064280



1



525



10

2510

FLEXIBLE WORKSHOP MIRROR



- The desired mirror position can be adjusted at the handle
- Mirror size: 50 x 70 mm. Handle length: 435 mm
- Mirror casing natural finish, chromed flexible shaft
- Aluminium mirror casing, flexible brass shaft



2510



731415

1064297



1



50x70



505



280

5515L

SMALL MIRROR



- Mirror Ø 21 mm
- Total length 160 mm
- Plastic handle and stainless mirror frame with blue pouch cover
- For work on circuit boards



5515L



731415

1481568



5



21



160



15

5515M

REPAIR MIRROR, WITH METAL HANDLE



- Mirror Ø 30 mm
- Total length 210 mm
- Solid stainless handle and stainless mirror frame with blue pouch cover



5515M



731415

1086985



1



30



210



20



5515B

PLASTIC REPAIR MIRROR



- Mirror Ø 28.5 mm
- Total length 220 mm, handle 195 mm
- Two piece fibreglass handle
- Detachable handle
- For all applications on electronics equipment

5515B	731415 1086978	5	28.5 mm	220 mm	15 g

5515GV

SWIVEL HEAD MIRROR



- Mirror Ø 30 mm, type x9 magnifier
- Total length 215 mm
- Stainless mirror frame with blue pouch cover and steel shaft with orange hand protection
- Swivel head adjustable in all directions

5515GV	731415 1481483	1	30 mm	215 mm	42 g

5515T

POCKET TELESCOPIC MIRROR



- Glass mirror Ø 30 mm, type x9 magnifier
- Length: Extended 690 mm, retracted and folded 180 mm
- Stainless mirror frame with blue pouch cover
- Swivel head adjustable in all directions
- Seven sections, telescopic shaft

5515T	731415 1589172	1	30 mm	180-690 mm	45 g

5515T-52

TELESCOPIC SWIVEL HEAD MIRROR



- Mirror Ø 50 mm
- Length: Extended 450 mm, retracted and folded 290 mm
- Stainless mirror frame and steel shaft with orange hand protection
- Swivel head adjustable in all directions
- Two sections telescopic shaft

5515T-52	731415 3021939	1	50 mm	290-450 mm	65 g



3046-OP

MAGNIFIER



- 10x Optical magnifier with built in LED light for easy inspections
- 40000 Hours of life under normal usage
- 3AAA Batteries required, 40-50 hours of life under continuous use

3046-OP	731151	12	30 mm	90 mm	100 g

6330M

ELECTRONICS SOCKET SET, 28 TOOLS



- 5/32" D4 conforms to DIN 3126/ISO 1173
- Skydrol-resistant baked enamelled metal box, insert of elastic plastic material to hold the tools
- Material: Vanadium-extra

6330M	731415	1	220x110x35 mm	530 g



6300M 2.5, 3, 3.5, 4, 4.5, 5, 5.5, 6, 7 mm		6306-5/32	
40MH 0.5x3, 0.6x3.5, 0.6x4, 0.6x4.5, 0.8x4, 0.8x5.5, 1x5.5 mm		42H PH 0, 1, 2	
41PZD/SDVH PZ 1, 2		45M 1.5, 2, 2.5, 3 mm	
6361		6366	



3049-2

ELECTRICIAN'S TOOL BAG, 28 TOOLS



- Electrician's tool bag, 28 pcs
- Set of assorted tools for installation and maintenance work
- Sturdy imitation leather bag with metal edge protection strip, metal base plate and flexible push-fit system
- Quick access through a side section that folds open

	 731415		 mm	 g
3049-2	1848118	1	290x450x180	5300
BE-80xxS BE-82xxS 0.5x3, 0.8x4, 1x5.5, 1.2x8.5		BE-86xxS PH1x80, PH2x100		
BE-8820S PZ2x100		8045LVDE 0.5x3.5x42 mm		
817-100		BE-9765 1.5, 2, 2, 5, 3, 4, 5 mm		
2101 160 mm		2427S 200 mm		
2628S 180 mm		2744 190 mm		
9072 P 250 mm		111m 7, 8, 10, 13 mm		
481-300 300 g		5470-140 140 mm		
2705R		268		



2010

SPECIAL TOOL SET, ELECTRONICS SERVICE CASE, 109 TOOLS



- For all service work in the fields of office equipment, data processing and computer technology
- The moulded case is equipped with black panels, one carrying tools on both sides, two carrying tools on one side
- All three panels are removable
- Finish: Dustproof, hardwearing, acid and scratch resistant
- Material: Case made of highly impact resistant Royalite, with DUR aluminium frame

	 731415		 mm	 g
2010	1584610	1	480x330x180	8100
1952M 6, 7, 8, 9, 10, 11, 12, 13, 14 mm		1952Z 1/4, 3/8, 1/2"		
4020LM 3, 3.2, 3.5, 4, 4.5, 5.5 mm		BE-86xx PH0x75, PH1x80, PH2x100		
BE-83xx 0.8x4x25, 1x5.5x25, 1.2x6.5x25		BE-78xx 4, 4.5, 5, 5.5, 6, 7 mm		
700 1x50, 1.2x50, 1.5x50, 1.8x50		701 PH00, PH0		
3659/8T 0.9, 1.4, 1.8, 2.4, 2.8, 3.4, 3.9, 6 mm		1995M/8T 2, 2.5, 3, 4, 5, 6, 7, 8 mm		
1996M 1.5, 2, 2.5, 3, 4 mm		9070C 160 mm		
5550 3.2 mm		5550 4.5 mm		
BE-8220S 0.5x3x100		BE-8040S 0.8x4x100		
BE-8050S 1x5.5x125		BE-8260 1.2x8x175		
5516I 150 mm		8045LVDE 0.6x3.5x42 mm		
5577-145 145 mm		5574-145		
2530-32 130 mm		2-470 6 x 2-470-16-1-0		
5418 165 mm		5515GV 215 mm		
2535L		5423 85 mm		
3524		2713A 140 mm		
2477AB 200 mm		2665B 160 mm		
2648 125 mm		2656 R 135 mm		
3417NFVDE 160 mm		2707 115 mm		
1150 1/2H/P 120 mm		326000300 25 w		
2950 1 mm - 100 g		328000000		
2010-5		2010-L		



2010-L

EMPTY TOOL CASE



- The case is equipped with black plastic panels, one carrying tools on both sides, two carrying tools on one side
- All three panels are removable
- In addition there is one pocket for technical drawings etc.
- Panels have flexible organisation system
- Finish: Dustproof, hardwearing, acid and scratch resistant, washable
- Material: Case made of highly impact resistant Royalite, with DUR aluminium frame



2010-L



731415

1584535



1



480x330x180



4100



MEASURING TOOLS

Whatever your trade, you will need to measure accurately, simply and comfortably. With short and long tapes, a measuring wheel, metric and imperial versions and numerous levels, the Bahco measuring range provides measuring tools for all applications.



Chapter Index

TAPES	936-938
MEASURING WHEELS	939
RULES	939
LEVELS	940-941
CHALK LINE AND CHALK	942
BEVELS	943
SQUARE	944-945
PENCIL AND SCRIBERS	945-946
PRECISION MEASURING	947

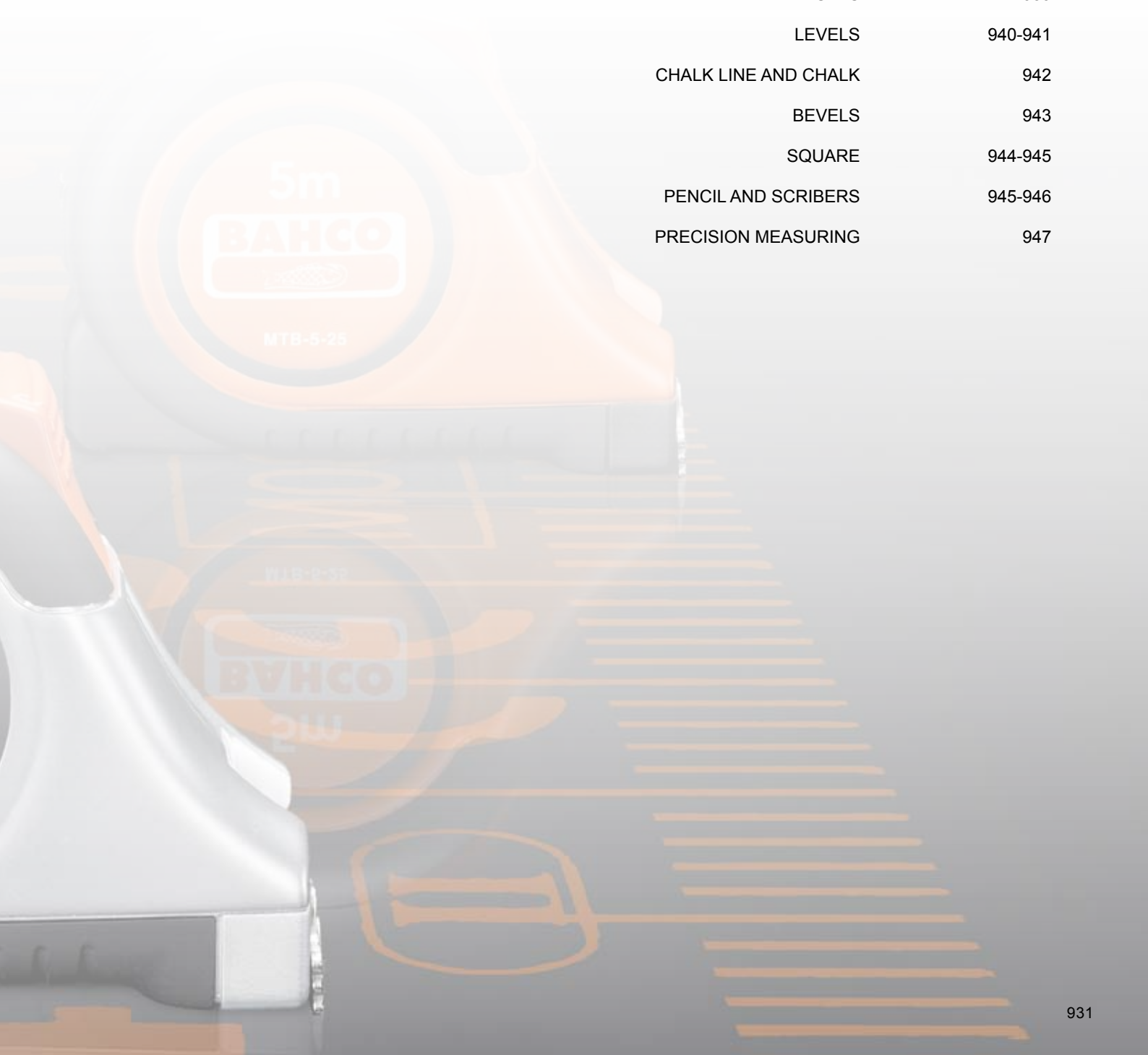

MEASURING TAPE MTS

LOCKING SYSTEM

Manual locking simply by pushing a button to lock or unlock the blade. Automatic locking requires pushing to retract the blade. Patented

RESISTANT

Impact absorbing rubber



CLIP

Integrated belt- and button-clip



MAGNETIC TIPS

Ideal for the building and construction trade. Great for hanging tapes from a ceiling. The tape graduations can be used to set up a rotary laser and make simple measurements at any place in a room. Magnetic tapes can also be used as a pick-up tool

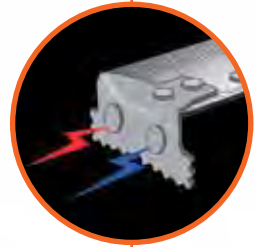

EVEN BODY LENGTH

(90mm/100mm) for easy internal measurements



STAINLESS STEEL

Cleaning the tape surface prolongs the lifespan. Thanks to stainless steel blades and internal parts, these tapes are washable. Stainless tapes can be used in even the harshest conditions



DOUBLE SIDED PRINTING

For extra precise marking and line drawing. Making it easier to measure tall walls and ceilings



STAINLESS STEEL BLADE

De-burred edges, high-contrast, permanent, clearly-printed graduations. Non-reflective, double-baked nylon-coated 'diamond pattern'

ACCURACY

Measuring devices are classified by three standards of accuracy: Class I (the most accurate), Class II and Class III (wooden rules). The accuracy class is permanently marked on the blade. Class I tapes are manufactured for very specific, high-accuracy applications and when official regulations require precision and certification.



Class	Length / Tolerance				
	1m	2m	3m	5m	8m
I	0.2 mm	0.3 mm	0.4 mm	0.6 mm	0.9 mm
II	0.5 mm	0.7 mm	0.9 mm	1.3 mm	1.9 mm
III	1.0 mm	1.4 mm	1.8 mm	2.6 mm	3.8 mm

AVERAGE STANDOUT STANDARDS

Blade width	Horizontal stand-out	Vertical stand-out	Vertical stand-out (back-reading)
13 mm	1.17 m	1.70 m	
16 mm	1.55 m	2.20 m	
19 mm	1.85 m	2.90 m	3.60 m
25 mm	2.40 m	4.30 m	6.00 m

BLADE FEATURES

CARBON STEEL

1. High-grade carbon-steel blade
2. De-burred edges
3. High-contrast, baked-paint background
4. Permanent clearly-printed graduations
5. Non-reflective, nylon-coated 'diamond pattern'

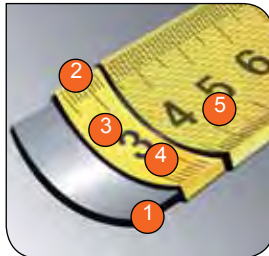

DOUBLE-SIDED PRINTING

- For precise marking and line drawing
- Easier to measure tall walls and ceilings



LONG TAPES

ACCURACY

Class	Length / Tolerance				
	10m	20m	30m	50m	100m
II	2.3 mm	4.3 mm	6.3 mm	10.3 mm	20.3 mm
III	4.6 mm	8.6 mm	12.6 mm	20.6 mm	40.6 mm

TIP TYPE



BLADE STRUCTURES

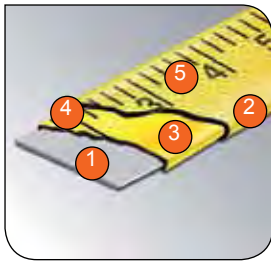

CARBON STEEL

1. High-grade carbon steel blade
2. De-burred edges
3. High-contrast baked-paint background
4. Permanent, clearly-printed graduations
5. Clear nylon coating

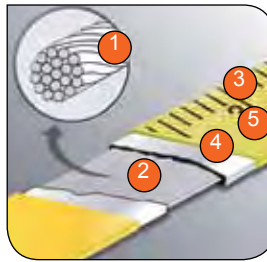

FIBREGLASS

1. 16,000 glass-fibre strands
2. Permanent bonding
3. Permanent clearly-printed graduations
4. Double nylon coating
5. Non-glare finish



TUBULAR SPIRIT LEVELS

Bahco offers a range of spirit levels from 250 mm to 2000 mm in length. They meet the permanent accuracy precision standards (0,5mm/1m), and are both comfortable and easy to use.

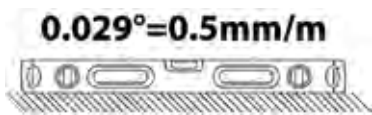

Machined surface with a thick, shaped profile

Large vials allow ease of reading even in low light areas. The laser marked measuring scale makes marking out easier

Hand holes for ease of use - to carry and to place accurately on the surface to be measured

Shock-absorbing end caps withstand a 10m drop test. V-groove base

Magnetic base available on the -M mm models for strong gripping

Box section anodized finish aluminium level with lineal scale



TAPES

MTS



POCKET TAPES

- MTS - Available in metric only or metric/imperial (-E for M/I)
- Stainless steel blade with rust resistance coating
- Easy to read nylon coated blade with reverse blade printing
- Automatic blade lock
- Magnetic tip

	 731415		 L m	 mm	 g
MTS-5-25	0119233	6	5	25	300
MTS-5-25-E	0119271	6	5	25	300
MTS-8-25	0119257	6	8	25	470
MTS-8-25-E	0119295	6	8	25	470

MTB



POCKET TAPES

- MTB - Available in metric or metric/imperial (-E for M/I)
- Tapes are Class II except MTB-5-25-C1 which is Class I
- Automatic blade lock
- Nylon coated easy to read blade with reverse blade printing only on the magnetic models
- Belt clip





	 731415		 L m	 mm	 g
MTB-3-16	0119066	6	3	16	155
MTB-3-16-E	0119134	6	3	16	155
MTB-3-16-M	0119073	6	3	16	155
MTB-3-16-M-E	0119141	6	3	16	155
MTB-5-25	0119080	6	5	25	300
MTB-5-25-E	0119172	6	5	25	300
MTB-5-25-M	0119097	6	5	25	300
MTB-5-25-M-E	0119158	6	5	25	300
MTB-8-25	0125418	6	8	25	470
MTB-8-25-E	0119202	6	8	25	470
MTB-8-25-M	0127078	6	8	25	470
MTB-5-25-C1	0119127	6	5	25	290

MTG



POCKET TAPES

- MTG - Tape measures are available in metric or metric/imperial (-E for M/I) Easy to read blade
- Tapes are Class II
- Belt clip
- Positive locking button

	 731415		 m	 mm	 g
MTG-3-16	0118984	12	3	16	155
MTG-3-16-E	0119028	12	3	16	155
MTG-5-19	0118991	12	5	19	300
MTG-5-19-E	0119035	12	5	19	300

1162N



MEASURING TAPE

- Measuring tape with flexible steel pull-push blade, 2 m
- 13 mm wide, metric and inch graduations on both sides
- For external and internal measurements







	 731415		 m	 mm	 g
1162N-1/2	1847241	1	2	13	4.7

LTS



LONG TAPES

- LTS - Long tape available with metric or metric/imperial blade (-E for M/I)
- Tapes are Class II
- Strong fibreglass tape bonded with over 16,000 strands to withstand a pulling force of near 500 kg
- Double nylon blade coating for extra wear resistance

	 731415		 m	 mm	 g
LTS-30	0120109	5	30	16	830
LTS-30-E	0120116	5	30	16	830
LTS-50	0120123	5	50	16	1220
LTS-50-E	0120130	5	50	16	1220
LTS-100	0120147	5	100	16	1795
LTS-100-E	0120154	5	100	16	1795



TAPES

LTB

LONG TAPES



- LTB - Available with metric or metric/imperial (-E for M/I)
- Tapes are Class II
- Strong fibreglass tape bonded with over 16,000 strands to withstand a pulling force of up to 500 kg
- Double nylon blade coating for extra wear resistance
- Case can be simply opened and washed out for maintenance

	 731415		 m	 mm	 g
LTB-10	0120048	6	10	13	282
LTB-10-E	0120055	6	10	13	282
LTB-20	0120062	6	20	13	412
LTB-20-E	0120079	6	20	13	412
LTB-30	0120086	6	30	13	588
LTB-30-E	0120093	6	30	13	588

LTG

LONG TAPES



- LTG - Long tapes available with metric or metric/imperial tape (-E for M/I)
- Tapes are Class II
- Steel tape
- Easy rewind
- Belt clip

	 731415		 m	 mm	 g
LTG-10	0119981	6	10	13	200
LTG-10-E	0119998	6	10	13	200
LTG-20	0120000	6	20	13	333
LTG-20-E	0120017	6	20	13	333
LTG-30	0120024	6	30	13	463
LTG-30-E	0120031	6	30	13	463







MW-150

MEASURING WHEEL



- Measuring wheel
- 150 mm diameter rubber coated wheel
- Measures up to 9999.9 m
- Push button reset





	 731415		 L m	 g
MW-150	0125685	2	150	695

MW-250

MEASURING WHEEL



- Measuring wheel
- 250 mm diameter rubber coated measuring wheel
- Adjustable handle height
- Fold down kickstand
- Measures up to 9999.9 m
- Push button reset

	 731415		 L m	 g
MW-250	0125678	2	250	1334

RULES



1179-FLX

STAINLESS STEEL RULE



- Flexible stainless steel ruler with pocket clip
- Both inch and metric measurement scales

	 731151		 L mm	 g
1179-FLX	8276997	100	160	9



LEVELS

426

SPIRIT LEVEL



- Professional spirit level in a rigid, rectangular aluminium profile
- High, permanent precision ± 0.5 mm per metre
- Thick plastic end caps to protect against shocks and scratches
- Barrel-shaped vials made of acrylic glass are virtually unbreakable and leak proof during normal use
- Hardened and grey lacquered

	 731151		 mm			 g
426-400	8004255	1	400	1	1	350
426-600	8004279	1	600	1	1	550
426-600-3	8004286	1	600	1	2	550
426-800	8004293	1	800	1	2	750
426-1000	8004309	1	1000	1	2	950
426-1200	8004316	1	1200	1	2	1150

426TOR9

SPIRIT LEVEL



- Solid aircraft grade aluminium
- 3 vials, plumb, horizontal and 45°
- V Groove base for use on pipes
- Rare earth magnets on base
- Accurate to 0.5 mm/m

	 731415		 mm			 g
426TOR9	0125319	12	230	1	2	200

446

SPIRIT LEVEL



- Professional spirit level in rigid, rectangular aluminium profile
- Permanent precision ± 1.0 mm per metre
- Thick plastic end caps to protect against shocks and scratches
- Barrel-shaped vials made of acrylic glass are virtually unbreakable and leak proof during normal use
- Hardened and grey lacquered







	 731151		 mm			 g
446-400	8001803	1	400	1	1	350
446-600	8001810	1	600	1	1	550
446-800	8001827	1	800	1	1	750
446-1000	8001834	1	1000	1	1	950

466-250

SPIRIT LEVEL



- Solid anodized aluminium scaffold level
- 250 mm long with 45° and 30° preset for quick angle setting
- High precision ±0.5 mm per metre accuracy
- Rare earth magnetic base and machined surfaces
- Open frame design, that makes handling easier







	 731415		 mm			 g
466-250	0128655	10	250	1	1	280

466

SPIRIT LEVEL



- Box section anodized finish aluminium level
- Shock absorbing end caps
- Permanent precision ±0.5 mm per metre
- Machined surfaces and "V" groove base
- Thick shaped profile
- Large vials for ease of view
- Laser marked measuring scale (for indication purposes only)
- Magnetic versions are available in 400 mm, 600 mm, 800 mm, 1000 mm and 1200 mm (-M)

	 731415		 mm			 g
466-1000-M	0186105	4	1000	1	2	1100
466-1200-M	0186129	4	1200	1	2	1320
466-400	0128297	4	400	1	1	520
466-800-M	0186082	4	800	1	2	930
466-400-M	0128358	4	400	1	1	545
466-600	0128303	4	600	1	2	715
466-600-M	0128365	4	600	1	2	765
466-800	0128310	4	800	1	2	875
466-1000	0128327	4	1000	1	2	1075
466-1200	0128334	4	1200	1	2	1290
466-1800	0128341	4	1800	1	2	1660
466-2000	0129836	4	2000	1	2	1870



CHALK LINE AND CHALK

CL-1221



CHALK LINE

- Chalk line with 30 m of mixed orange nylon and cotton line
- Breaking strain of 16 kg and high chalk retention in the cotton
- 3 times rewind speed
- Claw and hook end, with an integrated belt clip
- Can also be used as a plumb bob
- It can hold 50 g of chalk, allowing a long-life between refills



CL-1221



731415

0127122



6



180

CHALK



CHALK

- Chalk for use with CL-1221 chalk line and other makes
- Available in blue, red, white and yellow
- The chalk bottles have a scale for water resistance



CHALK-BLUE



731415

0128686



6



227



260

CHALK-WHITE

0179671

6

227

260

CHALK-RED

0128709

6

227

260

CHALK-YELLOW

0128693

6

227

260

316107000



PLUMB BOB

- Plumb bob with 5 m cord
- Magnetic fastening



316107000



841334

5088404



1



5







700

9572

SLIDING BEVEL



- For transferring a measured angle to a work piece for cutting or machining
- Blade of cold-rolled strip steel, hardened and tempered, locked in the cast by a screw. Stock of pressurised zinc alloy





	 731151		 L mm	 g
9572-200	8004231	6	200	140
9572-250	8004248	6	250	175

9574

SLIDING BEVEL



- For transferring a measured angle to a work piece for cutting or machining
- The blade can be tightened with the wing screw at the end, this also doubles as a hanging hole in storage

	 731415		 L mm	 g
9574-200	0138197	10	200	165
9574-250	0138203	10	250	175
9574-300	0180356	10	300	185

9575

SLIDING BEVEL



- Bevels are used to transfer a measured angle to a work piece for cutting or machining
- This bevel has a 45° and 135° fixed angle
- Stainless steel blade and hanging hole

	 731415		 L mm	 g
9575-250	0185894	6	250	322



SQUARE

9045-B

SQUARE



- Punched out of quality steel in a single piece for true 90° precision, may be used for accurate marking of 45° and 90° angles
- Remains well balanced and stable when placed on the surface
- Easy-to-read scale appears on both sides
- Black finish, covered by rust-preventing lacquer

	 731151			
9045-B-200	8012175	6	200	140
9045-B-250	8012182	6	250	200
9045-B-300	8012199	6	300	225
9045-B-400	8178123	1	400	245

9048

SQUARE



- Carpenters square with the addition of a sliding marker over the measuring scale for ease of marking repetitive measurements
- Accuracy 1 mm/1 m
- A moving pin that allows you to place the square on the work piece edge without it dropping down, this makes single handed work much easier

	 731415			
9048-200	0138159	10	200	230
9048-250	0138166	10	250	260
9048-300	0138173	10	300	290
9048-350	0180349	10	350	310
9048-400	0138180	10	400	325

3085

SQUARE



- Construction square for layout and setting up

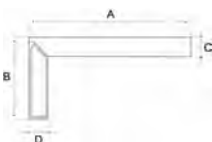





	 841334		A mm	B mm	C mm	D mm	
308504000	5035156	1	400	200	30	30	670
308505000	5035194	1	500	250	30	30	855
308506000	5035163	1	600	300	30	30	1020
308508000	5035170	1	800	400	30	30	1370
308510000	5035187	1	1000	500	30	30	1720

CS

COMBINATION SQUARE



- Sliding combination square, metric and imperial marking on ruler
- Can mark 90° and 45°
- Adjustable depth for repetition marking and scribing
- Built in level bubble for approximate marking and a metal scriber contained in the end

	 731415		 L mm	 g
CS150	0125241	12	150	175
CS300	0125258	12	300	375
CS400	0125265	12	400	410







PENCIL AND SCRIBERS

P-HB

PENCIL



- HB grade pencil
- Rectangular shape with chamfered edges
- P-HB is a box of 25 pencils
- PENCIL-200-DISP is a wire cage of 200 pencils

	 731415		 L mm		 g
P-HB	0125272	25	180	25	10
PENCIL-200-DISP	0125227	1	180	200	2890

1177-SCRIBE

SCRIBERS



- Chrome-vanadium steel
- 70° offset scriber

	 731415		 g
1177-SCRIBE	0120550	5	20



PENCIL AND SCRIBERS

1178-SCRIBE

SCRIBERS



- Tungsten carbide fixed point scriber
- With pocket clip

	 731415		 g
1178-SCRIBE	0120567	5	30

1179-SCRIBE

SCRIBERS



- Scriber with interchangeable carbide point
- Tip diameter 2.5 mm
- Body diameter 8 mm
- Overall length 150 mm
- Comes with pocket clip
- Spare tips - 1179-TIPS

	 731415		 g
1179-SCRIBE	0120574	5	20
1179-TIPS	0120581	1	5



1150D

CALIPERS



- Digital caliper of stainless steel with mm and inch range from 0 - 150 mm in 0.01 mm increments
- Depth gauge including limit and peak measurements
- Comes in protective box

	 731151		 mm	 g
1150D	8276614	1	250x90x25	290

1150

CALIPERS



- 150 mm caliper
- Self locking sliding mechanism
- Can measure internal, external and depth

	 731415		 mm	 g
1150-1/2H/P	0129263	10	235x75x9	185

1544

FEELER GAUGES



- Professional feeler gauges
- Includes 26 blades 0.03 mm to 0.1 mm in 0.01 mm increments and 0.10 mm to 1.0 mm in 0.05 mm increments

	 731151		 mm	 g
1544	8276560	1	76	77

1547

FEELER GAUGES



- Professional feeler gauges
- Includes 20 blades in sizes 0.05 mm to 1.00 mm

	 731151		 mm	 g
1547	8276577	1	100	93

DECORATING TOOLS

Bahco decorating tools have been designed to be easy to use, but tough enough for any application.

Scrapers, trowels, plasterer's rails, rasps, setting tools, trim cutters, punching tools and lifters all combine to achieve the best professional results.

The Bahco ERGO™ scrapers are ideal for all kinds of materials, from soft wood to hard steel or concrete.

Even the toughest task is not a problem as the blades are made from one of the hardest materials on earth: cemented carbide.



Chapter Index

SCRAPERS	952-955
CABINET SCRAPERS	955
RASPS	956
DRYWALL TOOLS	956-964
MASONRY TROWELS	965-968
PLASTERER'S RAILS	969
SETTING TOOLS	970
TRIM CUTTERS	970
PUNCHING TOOLS	971



SCRAPERS



Easily exchangeable blades. Both 50 mm and 65 mm blades can be used.



Convex shape reduces the risk of scratching the surface.

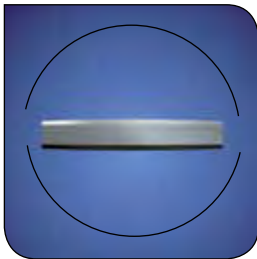

The blade is easily turnable.



The triangular blade has a convex shape which reduces the risk of scratching the surface.



The triangular blade is easily turnable to give three edges.



The slim front end allows the scraper to be used in narrow spaces.



BAHCO 665 with a two-handed grip for heavy duty scraping. The ergonomic two-handed grip has ample space for all your fingers and provides excellent working comfort regardless of how the scraper is turned during use.



BAHCO 650 for universal use.

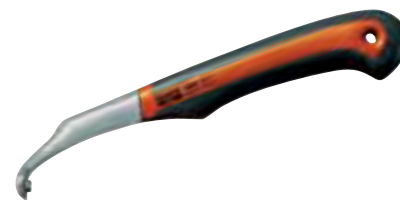

BAHCO 625 with a precision handle and a thumb grip, this scraper is very easy and comfortable to use for detailed and demanding tasks. Bahco 625 comes with a practical holster, so it is always to hand.

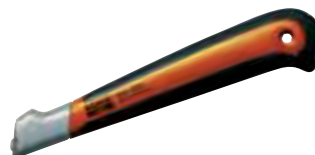

Cemented carbide is one of the hardest and most wear resistant materials on earth, topped only by diamond and ceramic. Cemented carbide is 2.5 times harder than hardened steel and much more resistant to wear. Bahco cemented carbide blades last at least 50 times longer than conventional steel blades.

Cemented carbide blades work beautifully on simple jobs such as scraping paint off a wood surface, but the hard cemented carbide blades can also easily handle the tougher jobs where steel scraper would not be effective, like scraping rust off fence posts.

Cemented carbide blades do not need to be sharpened.

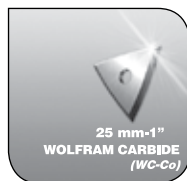

The wave-shaped blade with its patented design is capable of scraping up to 10 times more paint than a conventional blade and is therefore ideal for jobs like scraping thick layers of paint. This blade will also keep its sharpness up to 50 times longer than a conventional blade and can be used effectively on wood, metal and concrete surfaces. To be used with scrapers 650 and 665.

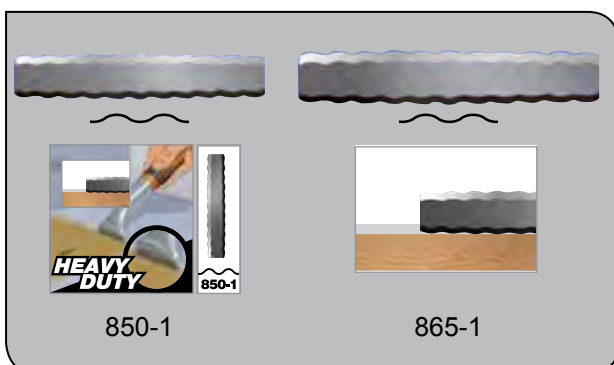

449



625-ROUND



625-PEAR



625-DROP

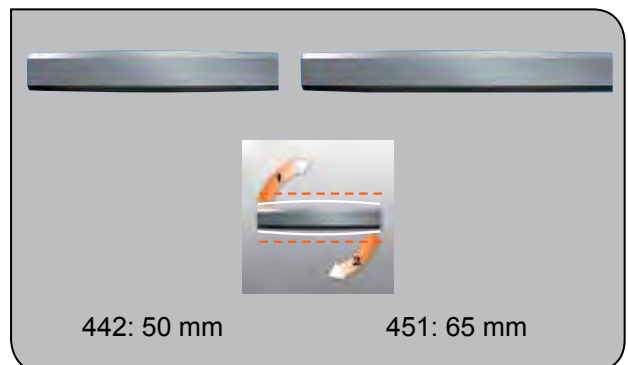



SCRAPERS

625

SCRAPERS



- Paint scraper developed according to the scientific ERGO™ process
- Specially designed for precision work such as scraping windows, moulding and narrow corners
- Carbide blades suitable for scraping paint, glue, varnish and rust off wood, metal, concrete etc.
- 2-component handle for better grip and comfort
- Can be fitted with profile blades 625-ROUND, 625-DROP and 625-PEAR
- Fitted with triangular 449 blade with holster
- Designed for convenient storage in a pocket or on a belt
- Narrow front with precision thumb grip

	 731151		 mm	 g
625	8221614	5	25	107

650

SCRAPERS



- Paint scraper developed according to the scientific ERGO™ process
- Developed and designed for universal use
- Carbide blades suitable for scraping paint, glue, varnish and rust off wood, metal, concrete etc
- 2-component handle for better grip and comfort
- Fitted with 442 blade
- Slim scraper head for better access in confined spaces

	 731151		 mm	 g
650	8221591	5	50	158

665

SCRAPERS



- Paint scraper developed according to the scientific ERGO™ process
- Heavy duty scraper
- The two hand grip makes it a powerful choice for scraping large areas
- Carbide blades suitable for scraping paint, glue, varnish and rust off wood metal concrete etc.
- 2-component handle for better grip and comfort
- Fitted with 451 blade
- Slim scraper head for better access in confined spaces

	 731151		 mm	 g
665	8221607	5	65	193



850 / 865

SCRAPER BLADES



- For scraping on wood, metal and concrete
- Paint scraper blade with patented wave shaped edges
- With this edge design the scraper can remove up to 10 x more paint, compared to a straight blade
- Perfect for rough removal
- The cemented-carbide blade stays sharp and productive up to 50 x longer than a conventional steel blade
- The blades are double edged and fit the scrapers 650 and 665

	 731151		 mm	 g
850-1	8292737	10	50	6
865-1	8292744	10	65	8

449/442/451

SCRAPER BLADES



- For scraping on wood, metal and concrete
- The cemented-carbide blade stays sharp and productive up to 50 x longer than a conventional steel blade
- The blades are precision-ground to a slightly convex shape that prevents the blade corners from scratching the work surface
- 442: double edged 50 mm for scrapers 650 and 440
- 451: double edged 65 mm for scrapers 665 and 450
- 449: triangular 25 mm for scrapers 625 and 448

	 731151		 mm	 g
449	8005337	10	25	6
442	8002848	10	50	6
451	8014506	10	65	10

625-

SCRAPER BLADES



- For scraping on windows, frames and mouldings with different inverted radii
- Made of cemented carbide with superior sharpness, for scraping on wood, metal or concrete
- Can be turned 360° in the handle to find different radii or sharp points
- Outer diameter on round section is 17mm/2/3"
- Profile blades for scraper 625

	 731151		 g
625-DROP	8221638	10	3
625-PEAR	8221621	10	3
625-ROUND	8221645	10	3



SCRAPERS

SCRAPER-SET2



SCRAPER SET

- Paint scraper developed according to the scientific ERGO™ process
- Specially designed for precision work such as scraping windows, moulding and narrow corners
- Carbide blades suitable for scraping paint, glue, varnish and rust off wood, metal, concrete etc.
- 2-component handle for better grip and comfort
- Including the profile blades 625-ROUND, 625-DROP and 625-PEAR
- The 625, with its thin front and precision thumb grip, comes with 449 blade with holster
- The 650 comes with a 442 blade

	 731151		 mm	 g
SCRAPER-SET2	8228613	1	265x145x50	400

625



650



625-DROP, 625-ROUND, 625-PEAR



2488

KNIFE



- Ideal for many automotive/industrial applications like cutting textiles, fascia, headliner, carpet, rubber, plastics and cardboard
- 2-component handle for better grip
- Full length stainless steel blade for long lasting use
- Hook knife with 2-component handle for better grip
- Re-sharpen periodically with water stone. Easy to clean and resistant to most solvents

	 731151		 mm	 g
2488	8276072	12	190	80



2489

OTHER SCRAPERS



- For the application and smoothing of adhesives, putties and body dent fillers
- 2-component handle for better grip
- Putty knife with hardened stainless steel blade that extends through the handle

	 731151		 mm	 L mm	 g
2489	8276065	12	27	235	160

2491

OTHER SCRAPERS



- Ideal for many automotive and industrial applications like cutting textiles, fascia, headliner, carpet, rubber, plastics and cardboard
- 2-component handle for better grip
- Single edge blade knife
- Easy to clean and resistant to most solvents
- Full length stainless steel blade for long lasting use
- Re-sharpen periodically with water stone

	 731151		 L mm	 g
2491	8276096	12	210	60

CABINET SCRAPERS



474

CABINET SCRAPER



- Cabinet scraper for carpentry work such as smoothing wood surfaces and removing old paint
- Blade of cold-rolled, hardened and tempered chrome-nickel steel
- White plastic edge protector

	 731151		 mm	 g
474-125-0.60	8029050	10	125x0.60	55
474-125-0.80	8029869	10	125x0.80	70
474-150-0.60	8029876	10	150x0.60	70
474-150-0.80	8029883	10	150x0.80	80



RASPS

250600010

RASPS



- Dry wall plane for plasterboard edge preparation
- 250600010 spare blade

	 841334		 mm	 g
250602550	5130301	1	0.255	345
250600010	5130318	5	0.255	40

250703000

RASPS



- Plasterboard edge chamfer plane

	 841334		 mm	 g
250703000	5129008	1	0.3	740



DRYWALL TOOLS

2155

PAINT SCRAPERS



- Wooden handle
- Flexible carbon steel blade

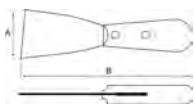

	 841334		A mm	B mm	 g
215500400	5122627	10	40	210	65
215500500	5122641	10	50	215	75
215500600	5122665	10	60	220	76
215500700	5122689	10	70	230	87
215500800	5122702	10	80	235	90
215501000	5122726	10	100	245	95





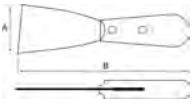

2156

PAINT SCRAPERS



- Wooden handle
- Flexible stainless steel blade



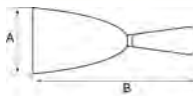

	 841334		A mm	B mm	 g
215600400	5122740	10	40	210	70
215600600	5122764	10	60	220	80
215600800	5122788	10	80	235	100
215601000	5122801	10	100	245	110

2165

PAINT SCRAPERS



- Plastic handle scraper
- Rigid blade



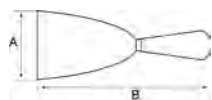

	 841334		A mm	B mm	 g
216500300	5407274	10	30	185	85
216500500	5407281	10	50	185	90
216500750	5407298	10	75	205	110
216501000	5407304	10	100	205	125

216

PAINT SCRAPERS



- Plastic handle scraper
- Flexible carbon steel blade

	 841334		A mm	B mm	 g
216000300	5403658	10	30	220	50
216000400	5403665	10	40	220	60
216000500	5403672	10	50	220	65
216000600	5403689	10	60	220	70
216000700	5403696	10	70	220	75
216000800	5403702	10	80	220	80
216000900	5403719	10	90	220	85
216001000	5403726	10	100	220	90
216001200	5403740	10	120	220	100



DRYWALL TOOLS

2150

PAINT SCRAPERS

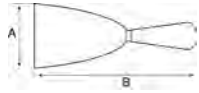

- 2-component handle
- Flexible carbon steel blade

	 841334		A mm	B mm	 g
215000030	5131971	10	30	220	60
215000040	5131988	10	40	220	60
215000050	5131995	10	50	220	65
215000060	3557944	10	60	220	65
215000070	5132008	10	70	220	70
215000080	5132015	10	80	220	70
215000090	5132022	10	90	220	80
215000100	5132039	10	100	220	80
215000120	5132046	10	120	220	85

2161

PAINT SCRAPERS

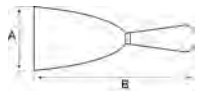

- 2-component handle
- Flexible stainless steel blade

	 841334		A mm	B mm	 g
216100040	5132053	10	40	220	70
216100060	5132091	10	60	220	77
216100080	5132060	10	80	220	91
216100100	5132077	10	100	220	94
216100120	5132084	10	120	220	99

219

FILLING SCRAPERS

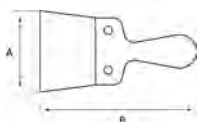

- Wooden handle
- Tempered steel blade

	 841334		A mm	B mm	 g
219001000	5029865	5	100	235	125
219001200	5029872	5	120	235	156
219001400	5029889	5	140	235	208
219001600	5029896	5	160	235	208
219002000	5029902	5	200	235	210



2192

FILLING SCRAPERS

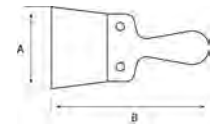

- Wooden handle
- Stainless steel blade

	 841334		A mm	B mm	 g
219201000	5029667	5	100	235	134
219201200	5029674	5	120	235	152
219201400	5029681	5	140	235	176
219201600	5029698	5	160	235	200
219202000	5029704	5	200	235	250

2193

FILLING SCRAPERS

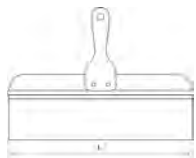

- Wooden handle
- Stainless steel sheet blade

	 841334		 L mm	 g
219302500	5129466	1	250	240
219303000	5129473	1	300	270
219303500	5129480	1	350	305

2212

GLUE COMB SCRAPERS

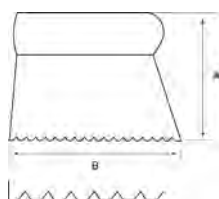

- Wooden handle
- Triangular toothting

	 841334		A mm	B mm	 g
221201200	5029711	5	130	120	106
221202000	5029728	5	130	200	164
221203000	5029735	5	130	300	195



2213

GLUE COMB SCRAPERS

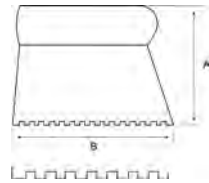

- Wooden handle
- Square tothing

	 841334		A mm	B mm	 g
221301200	5029742	5	130	120	100
221302000	5029759	5	130	200	140
221303000	5029766	5	130	300	195

202

TROWELS



- Wooden handle
- Flat trowel

	 841334		 mm	 g
202030180	5400770	5	300x180	425

204

TROWELS



- Wooden handle
- Rectangular shape

	 841334		 mm	 g
204030150	5400855	5	300x150	402
204030160	5400862	5	300x160	436
204030180	5400879	5	300x180	470
204050130	5097970	6	500x130	740

209

TROWELS



- Wooden handle
- Serrated teeth on two edges

	 841334		 mm	 g
209027040	5400947	5	270x115	400





2092

TROWELS



- Wooden handle
- Serrated teeth on two edges

	 841334		 mm	A mm	B mm	 g
209227060	5400961	5	275x115	6	6	350
209228100	5099233	5	280x130	10	10	440
209250100	5099585	6	500x130	10	10	620

2045

TROWELS



- Wooden handles
- Particularly suitable for plastering

	 841334		 mm	 g
204530140	5097918	5	300x140	365
204550130	5097956	6	500x130	690

2094

TROWELS



- 2-component handle
- Open and welded handle
- 209428100: Inox

	 841334		 mm	 g
209428000	5122450	6	280x120	365
209428100	5122474	6	280x120	406

211

TROWELS



- Flat plastic trowel
- Polystyrene handle

	 841334		 mm	 g
211035180	5000147	5	350x180	416
211042210	5000154	5	420x210	652
211050230	5000161	5	500x230	796



2120

TROWELS



- Polystyrene trowel with hanging clip

	 841334		 mm	 g
212027180	5000178	5	270x180	270
212033220	5129435	8	330x220	423

213

TROWELS



- Polystyrene trowel with a pointed tip

	 841334		A mm	B mm	 g
213026140	5000185	5	265	140	223

2122

TROWELS



- Grout trowel
- Rubber base
- Handle is made of an anti-shock polystyrene
- 10 mm thick base aids the removal of excess grout between joints

	 841334		 mm	 g
212202500	5110266	6	250x110	346

2123

TROWELS



- Foam base trowel
- Synthetic sponge base
- 30 mm thick base

	 841334		 mm	 g
212302900	5110280	6	290x150	233



2125

TROWELS



- Hard rubber grout float
- The polyurethane handle is attached to an aluminium plate holding the rubber base

212502150	841334	6	215x135	318

2126

TROWELS



- Soft rubber grout float
- A polyurethane handle

212602150	841334	6	215x135	287
212602800	5129404	6	280x140	328

2127

SCRIBE



- Aluminium plastering scribe

212704350	841334	6	435x90x17	990

2504

LIFTERS



- Plaster board lifter
- Uploading weight 65 kg
- Uploading height 3.3 m
- Folding tripod base

250400000	841334	1	15000x15000x9000	37



DRYWALL TOOLS

2500

LIFTERS



- Plaster board transporter
- Iron construction

	 841334		 L mm	 g
250005000	5129381	1	500	1780

2501

LIFTERS



- Plaster board lifter
- Iron construction
- Special design allows small height adjustments of board

	 841334		 L mm	 g
250103000	5129398	1	300	935

2502

LIFTERS

- Iron crib lock

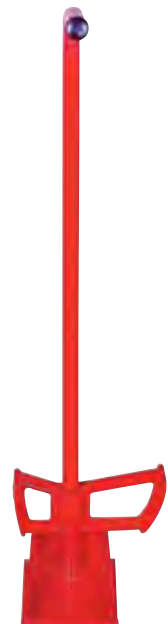

	 841334		 L mm	 g
250207980	5129367	1	798	2105



2301

MASONRY TROWELS



- Forged in one piece
- Tempered
- Catalan model





	 841334		 mm	 g
2301A0000	5091282	6	145x110	416
2301B0000	5091305	6	160x115	432
2301C0000	5091329	6	175x125	523

2301MB

MASONRY TROWELS



- 2-component handle
- Forged in one piece
- Catalan model





	 841334		 mm	 g
2301AMB00	5118101	6	145x110	423
2301BMB00	5118125	6	160x115	465
2301CMB00	5118149	6	175x125	546

2302

MASONRY TROWELS



- Forged in one piece
- Tempered
- Northern model

	 841334		 mm	 g
2302A0000	5091343	6	180x110	370
2302B0000	5091367	6	180x115	375
2302C0000	5091381	6	190x125	393







MASONRY TROWELS

2302MB



MASONRY TROWELS

- 2-component handle
- Forged in one piece
- Tempered
- Northern model





	 841334		 mm	 g
2302AMB00	5118163	6	180x110	391
2302BMB00	5118187	6	180x125	456
2302CMB00	5118200	6	190x115	406

2303



MASONRY TROWELS

- Forged in one piece
- Tempered
- Madrid model





	 841334		 mm	 g
2303B0000	5091404	6	110x68	120
2303D0000	5091428	6	135x78	184
2303F0000	5091442	6	165x93	265
2303H0000	5091466	6	190x103	318
2303J0000	5091480	6	215x113	377
2303K0000	5091503	6	228x117	415
2303L0000	5091527	6	240x122	428

2303MB



MASONRY TROWELS

- 2-component handle
- Forged in one piece
- Tempered
- Madrid model

	 841334		 mm	 g
2303FMB00	5118040	6	165x93	300
2303HMB00	5118064	6	190x103	348
2303JMB00	5118088	6	215x113	400

2304



MASONRY TROWELS

- Forged in one piece
- Tempered
- Sevilla model

	 841334		 mm	 g
2304A0000	5091541	6	180x110	351
2304C0000	5091565	6	200x118	423



2304MB

MASONRY TROWELS



- 2-component handle
- Forged in one piece
- Tempered
- Sevilla model

2304CMB00	841334	6	200x118	463

2307

MASONRY TROWELS



- Forged in one piece
- Tempered bay leaf blade

230713500	5091589	6	135x60	135

2307MB

MASONRY TROWELS



- 2-component handle
- Forged in one piece
- Tempered bay leaf blade

2307135MB	5118248	6	135x60	193

2308

MASONRY TROWELS



- Forged in one piece
- Tempered sharp tipped blade

2308A0000	5091602	6	120x70	170
2308B0000	5091626	6	150x100	185



MASONRY TROWELS

2309

MASONRY TROWELS



- Forged in one piece
- Tempered round pointed blade

	 841334		 mm	 g
230912500	5091640	6	125x75	176

2309MB

MASONRY TROWELS



- 2-component handle
- Forged in one piece
- Tempered round pointed blade

	 841334		 mm	 g
2309125MB	5118224	6	125x75	186

2360

MASONRY TROWELS



- Stainless steel trowel
- Ideal for outside corners
- For finishing and retouching in plaster
- A riveted wooden handle

	 841334		 mm	 g
236001200	5129077	6	120x97x97	220

2361

MASONRY TROWELS



- Stainless steel trowel
- Ideal for inside corners
- Riveted wooden handle

	 841334		 mm	 g
236101200	5129060	6	120x97x97	220







2145xxxD



PLASTERER'S RAILS

- Plasterer's rail
- Wooden handle
- Flat and serrated





	 841334		 mm	 g
2145020D0	5097994	1	275x35x20	170
2145025D0	5098007	1	275x35x25	215
2145030D0	5098014	1	275x35x30	240
2145035D0	5098021	1	275x35x35	270

2145xxxL



PLASTERER'S RAILS

- Plasterer's rail
- Wooden handle
- Flat





	 841334		 mm	 g
2145020L0	5098045	1	275x35x20	170
2145025L0	5098052	1	275x35x25	200
2145030L0	5098069	1	275x35x30	240
2145035L0	5098076	1	275x35x35	268

2145xxxC



PLASTERER'S RAILS

- Plasterer's rail
- Wooden handle
- Curved

	 841334		 mm	 g
2145025C0	5098083	1	225x35x20	165
2145039C0	5098090	1	210x35x39	220



SETTING TOOLS

250501800

SETTING TOOLS



- For setting fixings into hollow walls

	 841334		 mm	 g
250501800	5128964	1	180	765

250502450

SETTING TOOLS



- For setting fixings into hollow walls

	 841334		 mm	 g
250502450	5128957	1	245	780



TRIM CUTTERS

8640

TRIM CUTTERS



- Variable angle trim cutter

	 841334		 mm	 g
864002450	5129022	1	245	400

8641

TRIM CUTTERS



- Adjustable trim cutter
- Replacable blade

	 841334		 mm	 g
864102400	5129015	1	245	355







671002600

PUNCHING TOOLS



- Punching tools for joining together dry lining walls
- Dipped handle for comfort





	 841334		 L mm	 g
671002600	5128971	1	260	735

671002850

PUNCHING TOOLS



- Punching tools for joining together dry lining walls
- Dipped handle for comfort

	 841334		 L mm	 g
671002850	5128988	1	285	680

HAND ACTUATED SAWS

Bahco's wide range of handsaws, bowsaws, and special saws covers all applications and meets users' every need.

Sawing has never been the same since Bahco introduced the innovative Handsaw System. It is a revolutionary and professional approach to using a saw - the comfortable Bahco ERGO™ handle combined with numerous interchangeable Bahco saw blades create a flexible system.

In 1969 Bahco pioneered a new technique for cutting metal, combining the characteristics of spring steel with wear-resistant, high-speed steel. The two materials are welded together in a high vacuum environment, the teeth are then milled from the high-speed steel, with the support of the tough and very flexible spring steel on the back.

The same technique is applied to Sandflex® bandsaw blades, power and hand hacksaw blades, holesaws and reciprocating sawblades.

Chapter Index

HAND HACKSAW FRAMES	982-985
HAND HACKSAW BLADES	986-988
HANSAW WITH INTERCHANGEABLE BLADES	989-993
SUPERIOR™ HANDSAWS	993-995
PROFCUT™ HANDSAWS	996-1003
PRIZECUT™ HANDSAWS	1004-1005
OTHER HANDSAWS	1006-1007
MITRE BOX	1008
COPING SAWS	1009
FRET SAWS AND BLADES	1010-1011
BOWSAWS	1012-1014
BOWSAW BLADES	1015



HAND HACKSAW BLADES

Bahco was the first to introduce bi-metal hacksaw blades using the Sandflex® technology. For decades, people around the world have been choosing Sandflex® hacksaw blades for their superior performance, their fast cut and their increased longevity.

Practically shatterproof, the Sandflex® hacksaw blade is continually improved to make it cut even quicker and last even longer, so that users get the most out of every blade, everyday.



THICKER BLADE

Blade thickness has been increased by 3.5% providing 11% additional stability in the cut for the user. This means increased comfort and makes it easier to cut, achieving better performance under low tension.



WELL RECOGNISED LAYOUT

Our end users clearly identify the Sandflex® layout as a guarantee of quality. The improved layout easily indicates that you now have the latest, thicker Sandflex® hacksaw blade.



COUNTERFEIT PROTECTION

All genuine Sandflex® hacksaw blades carry an embossed fish & hook on each blade. Placed every 20 cm, some blades can carry two embossed stamps.



HAND HACKSAW FRAMES



A professional hacksaw frame ergonomically designed with very high blade tension for straight, accurate and exact kerfs. Centred blade for correct balance and spring tensioned blade loading mechanism for quick blade changes. Alternative 55°

blade mounting for flush cutting. Supplied with the reliable and shatterproof Sandflex® 3906 bi-metal blade 24 TPI (teeth per inch) with excellent cutting performance.



Bahco has a wide range of hacksaw frames for all blades and any job, for both conventional and mini hacksaws. A hacksaw frame must be as rigid as possible to ensure the blade is tensioned sufficiently to deliver a straight cut.

BOWSAWS

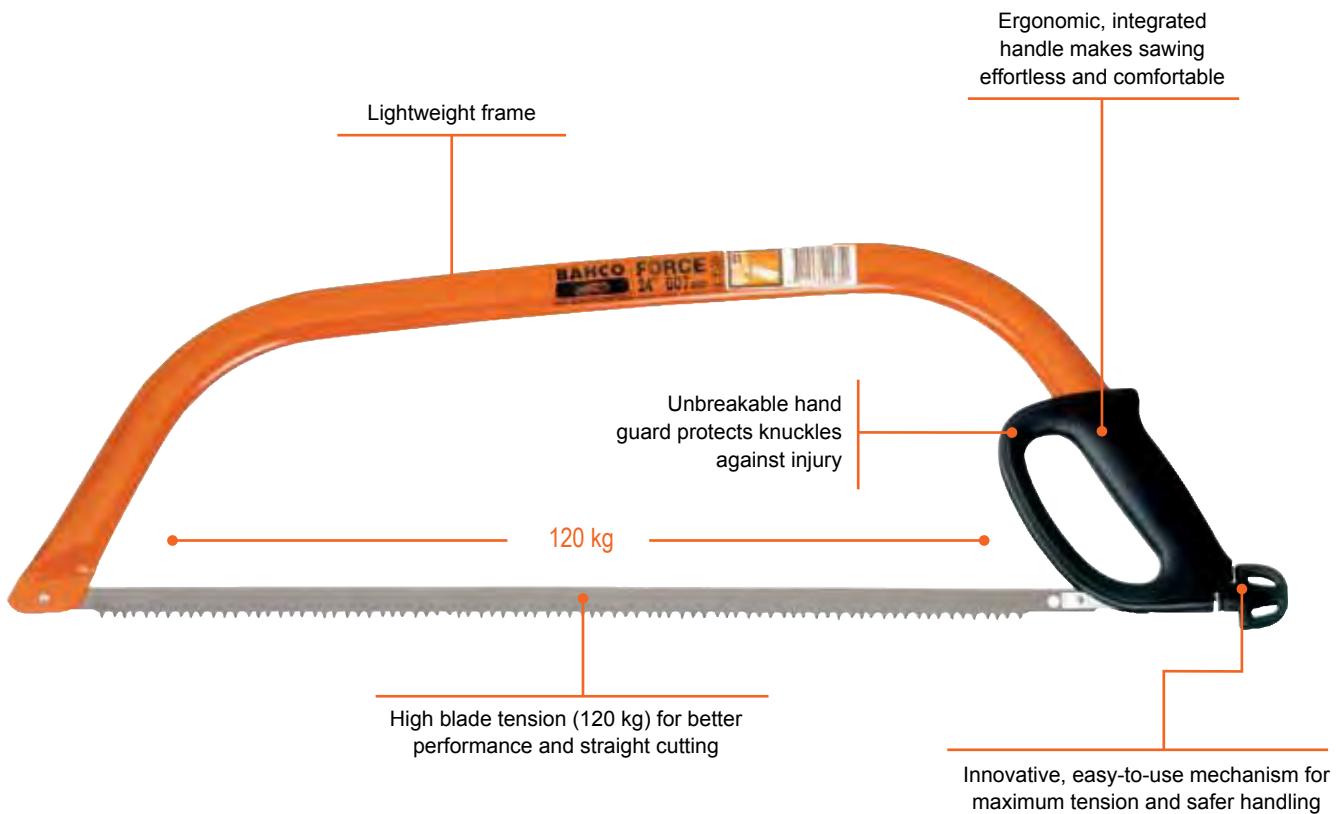

TWO DIFFERENT TOOTHINGS ACCORDING TO THE APPLICATION

51: PEG TOOTHING FOR MATURE AND DRY WOOD



- Triangular set teeth, tips pointing downwards
- Bevel-filed and high-frequency hardened with sharp edges on both sides
- Hardpoint
- Every third gullet extended for high chip removal
- Cuts on both push and pull stroke
- Specifically designed for fast and effective cutting of mature and dry wood



23: RAKER TOOTHING FOR LIVE AND GREEN WOOD



- Triangular set teeth, tips pointing downwards
- Bevel-filed and high-frequency hardened with sharp edges on both sides
- Hardpoint
- Every fifth tooth is raker and unset, functioning like a chisel to remove the chips
- Cuts on both push and pull stroke

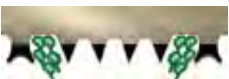

THE INSULATION SAW

PC-22-INS 22"/550 mm handsaw with waved tothing

The ProfCut™ Insulation handsaw is the ultimate way to cut all sorts of insulation materials.

Blade-thickness

0.83 mm thick, giving the same kind of stability as other saws in the ProfCut™ and PrizeCut™ ranges



Re-sharpenable

with any regular knife sharpener

WT-tothing

Especially designed for cutting insulation material. Each wave has a length of 15 mm



Mineral wool or Glass wool



EPS Expanded Polystyrene



Stone wool or Rock wool



XPS Extruded polystyrene

BAHCO HANDSAW SYSTEM



A revolutionary and professional approach to sawing

The comfortable Bahco ERGO™ handle with a wide range of interchangeable Bahco Superior™ saw blades to create a flexible system for all professional handsaw users.

The Bahco ERGO™ Process brings together R&D teams, ergonomists, industrial designers and professional hand tool users, to ensure the best possible user comfort.

ERGO™ HANDSAW HANDLE

Asymmetric handle design with no pressure points to stop the hand sliding on the handle. Thermoplastic elastomer (TPE) for optimum friction and a warm feel, the position of the handle in relation to the blade teeth reduces sawing forces and increases efficiency.

Available for left or right-handed users
in two sizes* to suit your hand - medium and large.
*Left-handed handle available only in medium size.

PATENTED LOCKING

Easy access to lever through opening in handle end.
Long lever for easy locking and release of the saw blade.
Security spring locks the lever



INTERCHANGEABLE BLADE SYSTEM

Ten different blades in the famous Bahco Superior™ quality range.
Covers all common applications.
XT toothing and low-friction coating.

COMFORT AND STABILITY

High-quality aluminium body provides rigidity as well as retaining and protecting the locking mechanism.
Soft shapes and materials ensure comfortable use.
High-quality blade locking system prevents play between handle and blade when assembled.
Extended index finger support increases precision



BAHCO HANDSAW SYSTEM



EASY TO USE

Change the blade in a couple of seconds



Hold the handle horizontally and pull the lever.



First, connect the base of the blade to the base of the handle, then attach the rest of the blade.



Push the lever back until you hear a click. Secure the lever with the security spring. The blade is now safely in position.

DIFFERENT HANDLES FOR DIFFERENT HANDS

EX-RM
EX-RL
EX-LL

Right-handed Medium
Right-handed Large
Left-handed Large

SUPERIOR

	①	②	③	④	⑤	⑥
EX-24-XT7-C	X					
EX-22-XT7-C	X					
EX-22-XT9-C		X				
EX-19-XT9-C		X				
EX-20-XT11-C			X			
EX-20-LAM-C				X		
EX16-GNP-C						X
EX-14-TEN-C			X			
EX-14-VEN-C			X			

OTHER BLADES

EX-22-PLS-C					X	
EX-NPP-22		X				
EX-22-U7		X				
EX-244P-22		X				



① Timber, wet and tanned wood.



② Dry wood, medium cutting.



③ Fine cutting in hard wood.



④ Laminate and wooden floors.



⑤ Plaster and particle boards.



⑥ General purpose.

TOOTHING AND BLADES



XT-toothings. A mix of tooth-geometry and grinding angles, along with our hardening process, make the unique XT-toothings the ultimate choice for efficient and comfortable sawing.



Hardpoint
Longer lasting.



GT-toothings. The supersharp GT-toothings is specially developed for high-performance cutting. The 3-sided ground-tooth form gives excellent results in all types of wood.



Low friction rust
protective coating.



UT-toothings. The universal toothings is strong and hard-wearing, suitable for both rip and cross cutting in all types of wood.



Thicker blade gives
more stability and
precision.

HANDSAWS



CHOOSE THE RIGHT SAW FOR THE JOB

The material to cut. The choice of saw depends on the size, hardness and structure of the material that is to be cut.

The quality of the cut. When sawing to measure for a furniture repair job, you should choose a precision saw with small teeth. But for more rough-and-ready sawing, a longer saw with bigger teeth will give the best results.

The length of the saw. A saw with bigger teeth is required for tackling heavy material properly. It is best to make proper use of the cutting capacity of the teeth by sawing in long, vigorous strokes. A saw with big teeth ought to be fairly long, 550-650 mm

or 22-26 inches. A saw with medium-coarse teeth should also be long, for vigorous strokes; 450-550 mm or 18-22 inches is usual. For more precision work and saws with smaller teeth, the length of the saw makes little difference.

The selection table is helpful for choosing the correct saw for the job. It gives information on materials and features of saw blades and handles.



A COMPLETE RANGE OF PROFESSIONAL HANDSAWS

Superior™

The Superior™ handsaw cuts through almost anything made of wood and will stay sharp after years of use. This is due to the unique Hardpoint, XT-toothing, low-friction coating, extra thick blade for added stability and precision, and the ERGO™ handle.

ProfCut™

Aimed at professional users, the ProfCut™ and ProfCut™+ handsaws feature the super-sharp Hardpoint GT-toothing. The low friction-coated ProfCut™+ handsaw makes sawing even easier. There is also a wide variety of ProfCut™ application handsaws ideal for cutting plywood, laminates, timber, plastics, plaster and concrete.

PrizeCut™

PrizeCut™ is a robust and affordable handsaw with Hardpoint UT-toothing for cutting all types of wood. The single component solid handle is designed for long lasting use.

HANDSAW SELECTION TABLE

There are a few things to consider when selecting the right saw for the job. The following steps and the table below will help you make the right choice.

Step 1. Select saw model: Superior™, ProfCut™ or PrizeCut™
 Step 2. Select saw according to column 1 – Type of saw/material.
 Step 3. Select saw according to application – see column 5 and column 6 (length).

- Precision work: Use fine cut saws with small teeth from 9/10 to 15/16 teeth/points per inch. The length of the saw makes little difference.
- General work: Use medium cut saws with medium size teeth from 7/8 to 9/10 teeth/points per inch. The length should be 18-22 inches for vigorous, thrusting strokes.
- Rough work: Use coarse cut saws with large teeth with 7/8 teeth/points per inch. The length should be 22-26 inches for long, vigorous strokes.

Superior™

GENERAL			BLADE						HANDLE	
Type of saw/material	Art.Code	EAN-code	Pack Qty	Application	Length inch/mm	Toothing/ TPI	Low friction coating	Thickness of blade	Type	
COARSE	2700-22-XT7-HP	7311518191672	4	Timber, wet and tanalised wood	22/550	XT/7	Yes	1.03 mm	ERGO™, 2-component	
COARSE	2700-22-XT7-HP	7311518191672	4	Timber, wet and tanalised wood	22/550	XT/7	Yes	1.03 mm	ERGO™, 2-component	
MEDIUM	2600-22-XT-HP	7311518160777	4	Medium cutting	22/550	XT/9	Yes	1.03 mm	ERGO™, 2-component	
MEDIUM	2600-19-XT-HP	7311518160760	4	Medium cutting	19/475	XT/9	Yes	1.03 mm	ERGO™, 2-component	
Toolbox saw										
FINE	2600-16-XT11-HP	7311518239527	4	Toolbox	16/400	XT/11	Yes	1.03 mm	ERGO™, 2-component	
Laminate saw										
LAMINATOR™	SUP-20-LAM	7311518258351	4	Laminate and wood floors	20/500	XT/11	Yes	0.93 mm	ERGO™, 2-component	
Small saws										
Tenon	3180-14-XT11-HP	7311518181390	4	Tenon saw	14/360	XT/11	Yes	0.75 mm	ERGO™, 2-component	
Veneer	3240-14-XT11-HP	7311518243005	4	Veneer saw	14/360	XT/11	Yes	0.75 mm	ERGO™, 2-component	
Compass	3150-12-XT9-HP	7311518181406	4	Compass saw	12/300	XT/9	Yes	1.03 mm	ERGO™, 2-component	

ProfCut™

GENERAL			BLADE						HANDLE	
Type of saw/material	Art.Code	EAN-code	Pack Qty	Application	Length inch/mm	Toothing/ TPI	Low friction coating	Thickness of blade	Type	
ProfCut™+ base assortment										
MEDIUM	PCP-22-GT7	7311518263331	4	Medium cutting	22/550	GT/7	Yes	0.83 mm	2-component	
MEDIUM	PCP-19-GT7	7311518263317	4	Medium cutting	19/475	GT/7	Yes	0.83 mm	2-component	
FINE	PCP-22-GT9	7311518263348	4	Fine cutting	22/550	GT/9	Yes	0.83 mm	2-component	
FINE	PCP-19-GT9	7311518263324	4	Fine cutting	19/475	GT/9	Yes	0.83 mm	2-component	
ProfCut™ base assortment										
MEDIUM	PC-22-GT7	7311518263393	4	Medium cutting	22/550	GT/7	No	0.83 mm	2-component	
MEDIUM	PC-19-GT7	7311518263362	4	Medium cutting	19/475	GT/7	No	0.83 mm	2-component	
FINE	PC-22-GT9	7311518263409	4	Fine cutting	22/550	GT/9	No	0.83 mm	2-component	
FINE	PC-19-GT9	7311518263379	4	Fine cutting	19/475	GT/9	No	0.83 mm	2-component	
Toolbox saw										
FINE	PC-15-TBX	7311518263423	4	Fine cutting/toolbox	15/380	GT/11	No	0.75 mm	2-component	
Small saw										
TENON	PC-12-TEN	7311518263447	4	Tenon saw	12/300	UT/11	No	0.75 mm	2-component	
VENEER	PC-12-VEN	7311518263430	4	Veneer saw	12/300	UT/11	No	0.75 mm	2-component	
COMPASS	PC-12-COM	7311518263454	4	Compass saw	12/300	XT/9	No	1.03 mm	2-component	
Fileable saws										
MEDIUM	PC-16-FILE-U7	7311518263461	4	Medium cutting/fileable	16/400	UT/7 Fileable	No	0.83 mm	2-component	
MEDIUM	PC-19-FILE-U7	7311518263478	4	Medium cutting/fileable	19/475	UT/7 Fileable	No	0.83 mm	2-component	
MEDIUM	PC-22-FILE-U7	7311518263485	4	Medium cutting/fileable	22/550	UT/7 Fileable	No	0.83 mm	2-component	
MEDIUM	PC-24-FILE-U7	7311518263492	4	Medium cutting/fileable	24/600	UT/7 Fileable	No	0.83 mm	2-component	
Dove tail saws										
DOVE TAIL	PC-10-DTR	7311518263546	10	Dovetail, right	10/250	FT/15	No	0.50 mm	Wood	
DOVE TAIL	PC-10-DTL	7311518263553	10	Dovetail, left	10/250	FT/15	No	0.50 mm	Wood	
DOVE TAIL	PC-10-DTF	7311518263560	10	Dovetail, flex	10/250	FT/15	No	0.50 mm	Wood	
Special application saws										
Laminate saw										
LAMINATOR™	PC-20-LAM	7311518258290	4	Laminate and wooden floors	20/500	XT/11	No	0.93 mm	2-component	
Precision saw										
PRECISION	PC-20-PRC	7311518264291	4	Mitre/Precision/Fine	20/500	UT/9	No	0.93 mm	2-component	
Timber saw										
TIMBER	PC-24-TIM	7311518263515	4	Coarse cutting/fileable	24/600	FT/3.5 Fileable	No	0.93 mm	2-component	
Plaster saw										
PLASTER	PC-24-PLS	7311518263508	4	Plaster	24/600	GT/7	No	0.93 mm	2-component	
General purpose saw										
GEN. PURPOSE	PC-15-GNP	7311518264307	4	General purpose	15/380	FT/15	No	0.75 mm	2-component	
Polystyrene, foam saw										
DECOR	PC-16-DECO	7311518264987	4	Polystyrene, foam saw	16/400	Special	No	0.75 mm	2-component	
Concrete saw										
255		7311518007843	1	Concrete/Carbide tip	30/750	30 Carbide tips	No	1.6 mm	2-component	
255-15/29		7311518007850	1	Concrete/Carbide tip	30/750	15 Carbide tips	No	1.6 mm	2-component	
Light Concrete saw										
256-26		7311518000080	4	Lightweight concrete	26/650	Non-Carbide	No	1.15 mm	2-component	
Insulation saw										
INSULATION	PC-22-INS	7314150154500	4	Insulation	22/550	Special	No	0.83 mm	2-component	

PrizeCut™

GENERAL			BLADE						HANDLE	
Type of saw/material	Art. code	EAN-code	Pack/ Qty	Application	Length inch/mm	Toothing/ TPI	Low friction coating	Thickness of blade	Type	
UNIVERSAL	NP-22-U7/8-HP	7311518034399	10	Universal	22/550	UT/7	No	0.83 mm	single-component	
UNIVERSAL	NP-16-U7/8-HP	7311518241452	10	Universal	19/475	UT/7	No	0.83 mm	single-component	
UNIVERSAL	NP-16-U7/8-HP	7311518241773	4	Universal	16/400	UT/7	No	0.83 mm	single-component	
Small saws										
TENON	NP-12-TEN	7311518263959	10	Tenon saw	12/300	UT/13	No	0.75 mm	single-component	
VENEER	NP-12-VEN	7311518264260	4	Veneer saw	12/300	UT/13	No	0.75 mm	single-component	
COMPASS	NP-12-COM	7311518264277	4	Compass saw	12/300	UT/7	No	1.20 mm	single-component	
General purpose										
FINE	300-14-F15/16-HP	7311518005955	4	General purpose	14/360	FT/15	No	0.75 mm	single-component	
Concrete saws										
NP-CONC		7311518264918	4	Concrete/Carbide tip	25/620	34 Carbide tips	No	2.00 mm	Wood	
NP-CONC-17/34		7311518264925	4	Concrete/Carbide tip	25/620	17 Carbide tips	No	2.00 mm	Wood	



HAND HACKSAW FRAMES

325

HAND HACKSAW FRAME

ergo®



- Hacksaw frame developed according to the scientific ERGO™ process
- Professional hacksaw frame with unique design
- Ergonomically designed soft grip handles
- Solid aluminium frame that allows very high blade tension for straight and accurate cuts
- Centred blade for balance and precision
- Quick-change blade tensioning mechanism with blade retaining spring for quick and easy blade change
- Alternative 55° blade mounting for flush cutting
- Supplied with the 300 mm (12") reliable and shatterproof Sandflex® bi-metal blade 24 TPI for excellent cutting performance

325	8214852	5	300	720

225-PLUS

HAND HACKSAW FRAME



- A professional and strong hacksaw frame
- Very high blade tension for straight and accurate cuts
- Blade tensioning mechanism with blade retaining spring for easy blade change
- Strong rectangular back section for blade storage, can also be used as a compass saw
- Alternative 55° blade mounting for flush cutting
- Supplied with the 300 mm (12") reliable and shatterproof Sandflex® bi-metal blade 24 TPI for excellent cutting performance

225-PLUS	8029708	5	300	700

319

HAND HACKSAW FRAME



- A professional hacksaw frame
- Comfortable soft grip handles
- Steel tube core with plastic covering allows high blade tension for straight and accurate cuts
- Alternative 55° blade mounting for flush cutting
- Supplied with the 300 mm (12") reliable and shatterproof Sandflex® bi-metal blade 24 TPI for excellent cutting performance

319	8240943	5	300	510



317

HAND HACKSAW FRAME



- A comfortable hacksaw frame for all-round use, slim design improves access in confined spaces and makes storage easy
- Special grip at the front provides good support for the guiding hand for superb performance
- Alternative 90° blade mounting for flush cutting
- Supplied with the 300 mm (12") reliable and shatterproof Sandflex® bi-metal blade 24 TPI for excellent cutting performance

	 731151		 L mm	 g
317	8240936	10	432	470

306

HAND HACKSAW FRAME



- A lightweight hacksaw frame for DIY use
- Alternative 90° blade mounting for flush cutting
- Supplied with the 300 mm (12") reliable and shatterproof Sandflex® bi-metal blade 24 TPI for excellent cutting performance

	 731151		 L mm	 g
306	8265540	10	470	325

320

HAND HACKSAW FRAME



- A top-of-the-line traditional hacksaw frame with comfortable soft grip handle and extra depth allowing thicker materials to be cut
- Special grip at the front provides good support for the guiding hand for superb performance
- Alternative 90° blade mounting for flush cutting
- Supplied with the 300 mm (12") reliable and shatterproof Sandflex® bi-metal blade 24 TPI for excellent cutting performance

	 731151		 L mm	 g
320	8265557	10	504	820

304

HAND HACKSAW FRAME



- A traditional designed, easy to use hacksaw frame
- Alternative 90° blade mounting for flush cutting
- Supplied with the 300 mm (12") reliable and shatterproof Sandflex® bi-metal blade 24 TPI for excellent cutting performance

	 731151		 L mm	 g
304	8265533	10	517	500



HAND HACKSAW FRAMES

321

COMPASS SAW



- An easy-to-handle compass saw
- The interchangeable blade can be positioned at eight different angles by turning the screw in the handle
- The 321 is supplied with a Sandflex® bi-metal blade, 310 mm (12 1/4"), 24 TPI
- Interchangeable blades: 321-7-SB: A special tooth hardened carbon sawblade 7 TPI for cutting in plastics, fibres and wood
- 321-18-SB: A Sandflex® bi-metal blade 18 TPI for thicker metal cutting
- 321-24-SB: A Sandflex® bi-metal blade 24 TPI for thinner metal cutting



321



731151

8001841



5



330

268

JUNIOR HACKSAWS



- Junior hacksaw with zinc plated solid steel profile frame
- Fibreglass reinforced handle for comfortable grip
- Practical and simple blade tensioning device
- Complete with 150 mm (6") 32 TPI metal cutting blade



268



731151

8017538



5



150



180

239

JUNIOR HACKSAWS



- Junior hacksaw with orange powder coated steel wire frame
- Complete with 150 mm (6") 32 TPI metal cutting blade



239



731151

8010874



5



290



120

238

JUNIOR HACKSAWS



- Junior hacksaw with zinc plated solid steel profile frame
- Wooden handle with simple and quick twist-action blade tensioning
- Complete with 150 mm (6") 32 TPI metal cutting blade



238



731151

8011314



5



150



195







228

JUNIOR HACKSAWS



- Junior hacksaw with zinc plated solid steel profile frame
- Wooden handle with simple and quick twist-action blade tensoning
- Complete with 150 mm (6") 32 TPI metal cutting blade
- 228 is packed in a protective sleeve



	 731151		 L mm	 g
228	8014995	5	150	180
228-BULK	8009069	5	150	180

219

JUNIOR HACKSAWS



- Junior hacksaw with zinc plated solid steel wire frame
- Wooden handle
- Complete with 150 mm (6") 32 TPI metal cutting blade





	 731151		 L mm	 g
219	8140953	5	291	100

218

JUNIOR HACKSAWS



- Junior hacksaw with zinc plated steel wire frame
- Complete with 150 mm (6") 32 TPI metal cutting blade
- 218 is packed in protective sleeve

	 731151		 L mm	 g
218	8017521	10	235	87
218-BULK	8140946	1	240	80

208

MINI HACKSAW



- A useful mini-hacksaw for difficult-to-reach positions
- Easy to handle
- Supplied with the 250 mm (10") reliable and shatterproof Sandflex® bi-metal blade 24 TPI for excellent cutting performance

	 731151		 L mm	 g
208	8017545	5	330	149



HAND HACKSAW BLADES

3906

SANDFLEX® BI-METAL



- The virtually unbreakable and shatterproof bi-metal blade with precision teeth for all kinds of metal sawing
- With a blade back of strong, flexible spring steel and a tooth line in high-alloyed super high speed steel, this blade is guaranteed to keep its sharpness for a long time
- The Sandflex® blade combines extreme cutting performance and wear resistance with a high degree of flexibility and is vastly superior to all-hard high speed blades or conventional, flexible blades
- Packaging:
 - -100 : 10 bundles of 10 blades in black, plastic box with transparent cover
 - -10P: 10 blades in a special package with hanging loop
 - -5P: 5 blades in a special package with hanging loop
 - -3P: 3 blades, 1 each of 18, 24 and 32 TPI, in plastic pouch, box of 10 packs
 - -2P: 2 carded blades, box of 10 packs

	 731151		L x W x T mm	 TPI	 g
3906-250-18-100	8250997	100	250x13x0.65	18	15
3906-250-24-100	8251000	100	250x13x0.65	24	15
3906-250-32-100	8251017	100	250x13x0.65	32	15
3906-300-14-100	8233563	100	300x13x0.65	14	17
3906-300-18-100	8233570	100	300x13x0.65	18	17
3906-300-24-100	8233587	100	300x13x0.65	24	17
3906-300-32-100	8233594	100	300x13x0.65	32	17
3906-300-18-2P	8233617	10	300x13x0.65	18	48
3906-300-24-2P	8233624	10	300x13x0.65	24	48
3906-300-32-2P	8233631	10	300x13x0.65	32	48
3906-300-3P	8233754	10	300x13x0.65	18/24/32	74
3906-300-24-5P	8237417	10	300x13x0.65	24	84
3906-300-32-5P	8237424	10	300x13x0.65	32	84
3906-300-18-10P	8233723	10	300x13x0.65	18	182
3906-300-24-10P	8233730	10	300x13x0.65	24	182
3906-300-32-10P	8233747	10	300x13x0.65	32	182

3905

SANDCUT



- Blade in fully hardened high speed steel
- Suitable for all kinds of sawing, even in hard-to-cut materials
- Recommended for use with a screw vice
- Blue rust-protective coating
- Packaging:
 - -100: 10 bundles of 10 blades in black, plastic box with transparent cover
 - -2P: 2 carded blades, box of 10 packs

	 731151		L x W x T mm	 TPI	 g
3905-250-24-100	8299255	100	250x13x0.65	24	15
3905-300-14-100	8292201	100	300x13x0.65	14	18,3
3905-300-18-100	8292218	100	300x13x0.65	18	18,6
3905-300-24-2P	8299248	10	300x13x0.65	24	48
3905-300-24-100	8292225	100	300x13x0.65	24	18,7
3905-300-32-100	8292232	100	300x13x0.65	32	17



215

ROD SAWBLADE



- Metal sawblade coated with a composite alloy with particles of cemented carbide
- Suitable for cutting glass, ceramics, porcelain and steel
- Fits junior hacksaw frames with 150 mm blade

	 731151		 L mm	 T ₁₂	 g
215-150	8017576	5	150	110	11

216

ROD SAWBLADE



- Metal sawblade coated with a composite alloy with particles of cemented carbide
- Suitable for cutting glass, ceramics, porcelain and steel
- 150 mm blade fits 301 coping saw, 300 mm blade fits all 300 mm/12" metal saw frames

	 731151		 L mm	 T ₁₂	 g
216-150-R	8017583	5	150	20	12
216-300-R	8017798	5	300	20	20

228-P

JUNIOR HACKSAW BLADE



- Spare blade for junior hacksaw frames
- Made of hardened and tempered carbon steel, teeth milled and set
- For cutting of metal: 12 teeth/cm, 32 teeth/inch
- For cutting of wood: 6 teeth/cm, 15 teeth/inch
- -100: 10 bundles of 10 blades, in box
- -10P: 10 blades in a special package with hanging loop
- -5P: 5 blades in a special package with hanging loop

	 731151		 L mm	 T ₁₂	 g
228-15-5P	8031442	10	150	15	26
228-32-5P	8031459	10	150	32	26
228-32-10P	8010867	10	150	32	36
228-32-100P	8150990	1	150	32	360



HAND HACKSAW BLADES

3816

TUNGSTEN CARBIDE TOOTHING



- An anti-corrosion treated, carbon steel blade
- Tooting with tungsten carbide contents
- Fits all 300 mm/12" metal saw frames

	 731151		 L mm	 TPI	 g
3816-300	8015749	5	300	12	60

3810

SPIRO BLADE



- An anti-corrosion treated, carbon steel blade
- Fine tooting
- For sawing of ventilation tubes, thin-walled steel tubes and reinforcement tubing

	 731151		 L mm	 TPI	 g
3810-600-32	8002886	10	610	32	55

3806-SPIRO

SANDFLEX® BI-METAL SPIRO BLADE



- A shatterproof, Sandflex® bi-metal hacksaw blade for use with 14-24 bowsaw and for cutting sheet metal tubing, reinforcement bars
- Fine tooting, 32 TPI
- Superior cutting performance and wear resistance as compared to carbon steel blades

	 731151		L x W x T mm	 TPI	 g
3806-600-32	8018092	10	600x13x0.65	32	90

321-SB

COMPASS SAWBLADE



- Interchangeable Sandflex® blades for compass saw
- 321321-7-SB: For sawing of ferrous and non-ferrous metals, plastics, fibres and wood
- 321-18-SB: For sawing of metal
- 321-24-SB: For sawing of thin metal
- Blister packed

	 731151		 L mm	 TPI	 g
321-7-SB	8129149	10	310	7	70
321-18-SB	8129125	10	310	18	70
321-24-SB	8129132	10	310	24	70



EX-

HANDLE

ergo®



- Handsaw handle developed according to the scientific ERGO™ process
- Asymmetrical handle in different sizes for right handed as well as left handed users
- The asymmetrical shape and the extended support wing spreads the pressure on the hand to the entire palm (conventional handles tend to concentrate the pressure to a line in the centre of the hand)
- For right handed, large and medium sizes are available, and for left handed large size is available
- The handles can be used with all EX-saw blades
- Quick and easy saw blade change using the patented click system

	 731151		 mm	 g
EX-LL	8298494	4	60x330x120	450
EX-RM	8298470	4	60x330x120	450
EX-RL	8298487	4	60x330x120	450

EX-XT7

SUPERIOR™ BLADES



- Saw blade for coarse and thick materials
- Unique XT-toothing, hardpoint teeth for long lasting sharpness
- Thicker blade for high precision and straight cutting with exceptionally good stability and comfort
- Low friction rust protective coating
- To be used together with the Bahco Handsaw System handles, EX-RL, EX-RM or EX-LL
- Quick and easy attachment of the blade to the handle using the patented click system

	 731151		 mm	 mm	 T ₁₂ P ₁₂	 g
EX-22-XT7-C	8298289	10	550	22	7/8	375
EX-24-XT7-C	8298272	10	600	24	7/8	410



HANDSAW WITH INTERCHANGEABLE BLADES

EX-XT9



SUPERIOR™ BLADES

- Saw blade for medium to thick materials
- Unique XT-toothing, hardpoint teeth for long lasting sharpness
- Thicker blade for high precision and straight cutting with exceptionally good stability and comfort
- Low friction rust protective coating
- To be used together with the Bahco Handsaw System handles, EX-RL, EX-RM or EX-LL. Quick and easy attachment of the blade to the handle using the patented click system

	 731151		 mm	 "	 T/P P/1"	 g
EX-19-XT9-C	8298302	10	475	19	9/10	325
EX-22-XT9-C	8298296	10	550	22	9/10	380

EX-20-XT11-C



SUPERIOR™ BLADES

- Saw blade for medium to fine materials
- Unique XT-toothing, hardpoint teeth for long lasting sharpness
- Thicker blade for high precision and straight cutting with exceptionally good stability and comfort
- Low friction rust protective coating
- To be used together with the Bahco Handsaw System handles, EX-RL, EX-RM or EX-LL. Quick and easy attachment of the blade to the handle using the patented click system

	 731151		 mm	 "	 T/P P/1"	 g
EX-20-XT11-C	8298319	10	500	20	11/12	360

EX-20-LAM-C



SUPERIOR™ BLADES

- Saw blade for cutting laminate and wooden floors
- Unique XT-toothing, hardpoint teeth for long lasting sharpness
- Thicker blade for high precision and straight cutting with exceptionally good stability and comfort
- Low friction rust protective coating
- To be used together with the Bahco Handsaw System handles, EX-RL, EX-RM or EX-LL. Quick and easy attachment of the blade to the handle using the patented click system

	 731151		 mm	 "	 T/P P/1"	 g
EX-20-LAM-C	8298326	10	500	20	11/12	365



EX-22-PLS-C

SUPERIOR™ BLADES



- Saw blade for cutting plaster and boards of wood based material
- Specially developed toothing with super sharp GT-toothing for the first 100 mm (at the tip), followed by groups of four teeth with extra large gullet between groups for greater efficiency and minimised clogging. Thicker blade for high precision and straight cutting with exceptionally good stability and comfort
- Low friction rust protective coating
- To be used together with the Bahco Handsaw System handles, EX-RL, EX-RM or EX-LL. Quick and easy attachment of the blade to the handle using the patented click system

EX-22-PLS-C	731151	10	550	22	7/8	400

EX-16-GNP-C

SUPERIOR™ BLADES



- Saw blade for cutting plastics, laminates, wood & soft metals like aluminium
- Fleam toothing, hardpoint teeth for long lasting sharpness
- Thicker blade for high precision and straight cutting with exceptionally good stability and comfort
- Low friction rust protective coating
- Toolbox sized for easy storage
- To be used together with the Bahco Handsaw System handles, EX-RL, EX-RM or EX-LL. Quick and easy attachment of the blade to the handle using the patented click system

EX-16-GNP-C	731151	10	400	16	15/16	214

EX-14-TEN-C

SUPERIOR™ BLADES



- Saw blade for cutting fine to medium thick materials
- Unique XT-toothing, hardpoint teeth for long lasting sharpness
- Thicker blade for high precision and straight cutting with exceptionally good stability and comfort
- Low friction rust protective coating
- To be used together with the Bahco Handsaw System handles, EX-RL, EX-RM or EX-LL. Quick and easy attachment of the blade to the handle using the patented click system

EX-14-TEN-C	731151	10	350	14	11/12	430



HANDSAW WITH INTERCHANGEABLE BLADES

EX-14-VEN-C

SUPERIOR™ BLADES



- Saw blade for cutting fine to medium thick materials such as plywood, laminates & plastics
- Unique XT-toothing, hardpoint teeth for long lasting sharpness
- Curved, toothed nose for starting cuts in the middle of the surface of the workpiece
- Thicker blade for high precision and straight cutting with exceptionally good stability and comfort
- Low friction rust protective coating
- To be used together with the Bahco Handsaw System handles, EX-RL, EX-RM or EX-LL. Quick and easy attachment of the blade to the handle using the patented click system

EX-14-VEN-C	731151 8298340	10	350 mm	14 "	11/12 T/P P/1"	245 g

EX-244P-22

OTHER BLADES



- Saw blade for cutting medium to thick materials
- Universal toothing, hardpoint teeth for long lasting sharpness
- Thicker blade for high precision and straight cutting with exceptionally good stability and comfort
- To be used together with the Bahco Handsaw System handles, EX-RL, EX-RM or EX-LL. Quick and easy attachment of the blade to the handle using the patented click system

EX-244P-22	731151 8298456	10	550 mm	22 "	7/8 T/P P/1"	380 g

EX-NPP-22

OTHER BLADES



- Saw blade for cutting medium to thick materials
- Universal toothing, hardpoint teeth for long lasting sharpness
- Thicker blade for high precision and straight cutting with exceptionally good stability and comfort
- To be used together with the Bahco Handsaw System handles, EX-RL, EX-RM or EX-LL. Quick and easy attachment of the blade to the handle using the patented click system

EX-NPP-22	731151 8324162	10	550 mm	22 "	7/8 T/P P/1"	380 g

HANDSAW WITH INTERCHANGEABLE BLADES



EX-22-U7



OTHER BLADES

- Saw blade for cutting all types of wood
- Universal tothing, hardpoint teeth for long lasting sharpness
- To be used together with the Bahco Handsaw System handles, EX-RL, EX-RM or EX-LL. Quick and easy attachment of the blade to the handle using the patented click system

EX-22-U7	731151	10	550	22	7/8	380

SUPERIOR™ HANDSAWS



2600

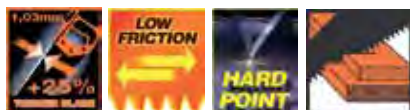

HANDSAWS

- Handsaw developed according to the scientific ERGO™ process
- Handsaw for cutting medium thick wood materials
- Unique XT-tothing and hardpoint teeth for long lasting sharpness
- Thicker blade for increased stability and precision
- Low-friction, rust-protective coating
- Screwed 2-component handle can be used for approximate 45° and 90° marking guide

2600-19-XT-HP	731151	4	475	19	9/10	490
2600-22-XT-HP	8160777	4	550	22	9/10	540

2700

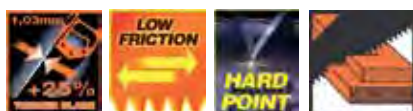

HANDSAWS

- Handsaw developed according to the scientific ERGO™ process
- Ergonomic product designed to fit perfectly in the hand
- Handsaw for cutting coarse or thick wood materials
- Unique XT-tothing and hardpoint teeth for long lasting sharpness
- Thicker blade for increased stability and precision
- Low-friction, rust-protective coating
- Screwed 2-component handle can be used for approximate 45° and 90° marking guide

2700-22-XT7-HP	731151	4	550	22	7/8	490
2700-24-XT7-HP	8191665	4	600	24	7/8	540



SUPERIOR™ HANDSAWS

3090

HANDSAWS

ergo®



- Handsaw developed according to the scientific ERGO™ process
- Handsaw for cutting fine & medium thick wood materials, laminate floors & plastic tubes
- Unique XT-toothing and hardpoint teeth for long lasting sharpness
- Thicker blade for increased stability and precision
- Low-friction, rust-protective coating
- Screwed 2-component handle can be used for approximate 45° and 90° marking guide

3090-20-XT11-HP	8181369	4	500	20	11/12	480

2600-16

TOOLBOX SAW

ergo®

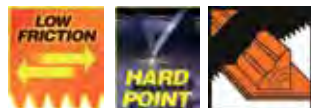

- Handsaw developed according to the scientific ERGO™ process
- Handsaw for cutting medium to fine wood materials
- Unique XT-toothing and hardpoint teeth for long lasting sharpness
- Thicker blade for increased stability and precision
- Low-friction, rust-protective coating
- Screwed 2-component handle can be used for approximate 45° and 90° marking guide

2600-16-XT11-HP	8239527	4	400	16	11/12	450

3180

TENON SAW

ergo®

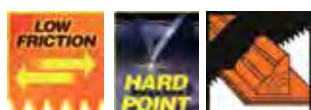

- Handsaw developed according to the scientific ERGO™ process
- Handsaw for cutting fine to medium thick wood materials
- Unique XT-toothing and hardpoint teeth for long lasting sharpness
- Thicker blade for increased stability and precision
- Low-friction, rust-protective coating
- Screwed 2-component handle can be used for approximate 45° and 90° marking guide

3180-14-XT11-HP	8181390	4	350	14	11/12	515



3240

VENEER SAW



- Developed according to the scientific ERGO™ process
- Handsaw for cutting fine & medium thick materials such as plywood, laminates & plastics
- Unique XT-toothing and hardpoint teeth for long lasting sharpness
- Thicker blade for increased stability and precision
- Low-friction, rust-protective coating
- Screwed 2-component handle can be used for approximate 45° and 90° marking guide

	731151	4	350 mm	14 mm	11/12 P/12	360 g
3240-14-XT11-HP	8243005	4	350	14	11/12	360

3150

COMPASS SAW

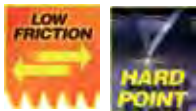

- Handsaw for cutting wood & plastic materials such as plywood, laminates & plastics
- Unique XT-toothing and hardpoint teeth for long lasting sharpness
- Thicker blade for increased stability and precision
- Low-friction, rust-protective coating
- Screwed 2-component handle

	731151	4	300 mm	12 mm	9/10 P/10	120 g
3150-12-XT9-HP	8181406	4	300	12	9/10	120

SUP-LAM

LAMINATOR SAW

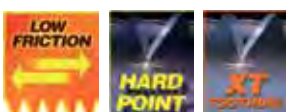

- Handsaw developed according to the scientific ERGO™ process
- Handsaw for cutting laminate & wooden flooring
- Unique XT-toothing and hardpoint teeth for long lasting sharpness
- Thicker blade for increased stability and precision
- Low-friction, rust-protective coating
- Screwed 2-component handle can be used for approximate 45° and 90° marking guide

	731151	4	500 mm	20 mm	11/12 P/12	480 g
SUP-20-LAM	8258351	4	500	20	11/12	480



PROFCUT™ HANDSAWS

PCP-GT7



HANDSAWS

- Saw blade for cutting medium thick materials
- Three sided ground, super sharp GT-toothing, hardpoint teeth for long lasting sharpness
- Low friction rust protective coating
- Screwed 2-component handle can be used for approximate 45° and 90° marking guide

	 731151		 mm	 "	 T/P P/"	 g
PCP-19-GT7	8263317	4	475	19	7/8	370
PCP-22-GT7	8263331	4	550	22	7/8	420

PCP-GT9



HANDSAWS

- Saw blade for cutting small and/or hard wood
- Three sided ground, super sharp GT-toothing, hardpoint teeth for long lasting sharpness
- Low friction rust protective coating
- Screwed 2-component handle can be used for approximate 45° and 90° marking guide

	 731151		 mm	 "	 T/P P/"	 g
PCP-19-GT9	8263324	4	475	19	9/10	370
PCP-22-GT9	8263348	4	550	22	7/8	420

PC-GT7

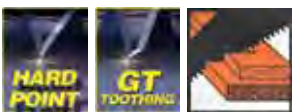

HANDSAWS

- Saw blade for cutting medium thick materials
- Three sided ground, super sharp GT-toothing, hardpoint teeth for long lasting sharpness
- Screwed 2-component handle can be used for approximate 45° and 90° marking guide

	 731151		 mm	 "	 T/P P/"	 g
PC-19-GT7	8263362	4	475	19	7/8	370
PC-22-GT7	8263393	4	550	22	7/8	420



PC-GT9

HANDSAWS



- Saw blade for cutting fine to medium thick materials
- Three sided ground, super sharp GT-toothing, hardpoint teeth for long lasting sharpness
- Screwed 2-component handle can be used for approximate 45° and 90° marking guide



	 731151					
PC-19-GT9	8263379	4	475	19	9/10	370
PC-22-GT9	8263409	4	550	22	7/8	420

PC-FILE

HANDSAWS



- Saw blade for cutting medium thick materials
- Universal toothing, non-hardpoint teeth that can be sharpened using a 186 file
- Screwed 2-component handle can be used for approximate 45° and 90° marking guide



	 731151					
PC-16-FILE-U7	8263461	4	400	16	7/8	310
PC-19-FILE-U7	8263478	4	475	19	7/8	370
PC-22-FILE-U7	8263485	4	550	22	7/8	420
PC-24-FILE-U7	8263492	4	600	24	7/8	500

PC-TBX

TOOLBOX SAW



- Saw blade for cutting fine to medium thick materials
- Three sided ground, super sharp GT-toothing, hardpoint teeth for long lasting sharpness
- Screwed 2-component handle can be used for approximate 45° and 90° marking guide

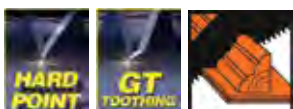

	 731151					
PC-15-TBX	8263423	4	375	15	11/12	240



PROFCUT™ HANDSAWS

PC-TEN

TENON SAW



- Saw blade for cutting medium thick materials, specially adapted for cutting of small-diameter timber and mitre guide sawing
- Heavy steel back for rigidity and accurate cutting
- Universal tothing, hardpoint teeth for long lasting sharpness
- Screwed 2-component handle can be used for approximate 45° and 90° marking guide

PC-12-TEN	731151	4	300	12	11/12	450

PC-VEN

VENEER SAW



- Saw blade for fine and medium thick materials, such as plywood, laminates and plastics
- Universal tothing, hardpoint teeth for long lasting sharpness
- Curved, toothed nose for starting cuts in the middle of the surface of the workpiece
- Screwed 2-component handle can be used for approximate 45° and 90° marking guide

PC-12-VEN	731151	4	300	12	11/12	250

PC-COM

COMPASS SAW



- Saw blade for all kinds of wood & plastic material
- Unique XT-tothing, hardpoint teeth for long lasting sharpness
- Screwed 2-component handle

PC-12-COM	731151	4	300	12	9/10	120



PC-DTR

DOVETAIL SAW



- Saw blade for cutting wood & plastic materials
- Universal tothing, hardpoint teeth for long lasting sharpness
- Light steel back for rigidity
- Wooden handle

PC-10-DTR	731151	10	250	10	13/14	190

PC-DTL

DOVETAIL SAW



- Saw blade for cutting wood & plastic materials
- Universal tothing, hardpoint teeth for long lasting sharpness
- Light steel back for rigidity
- Angled wooden handle to allow flush cutting

PC-10-DTL	731151	10	250	10	13/14	240

PC-DTF

DOVETAIL SAW



- Saw blade for cutting wood & plastic materials
- Universal tothing, hardpoint teeth for long lasting sharpness
- Light steel back for rigidity
- Angled wooden handle to allow flush cutting
- Handle swings to allow both left and right hand sawing where access is restricted

PC-10-DTF	731151	10	250	10	15/16	240



PC-LAM

LAMINATOR SAW



- Handsaw for cutting laminate & wooden flooring
- Three sided ground, super sharp GT-toothing, hardpoint teeth for long lasting sharpness
- Screwed 2-component handle can be used for approximate 45° and 90° marking guide

PC-20-LAM	731151	4	500	20	11/12	480	

PC-PRC

PRECISION SAW



- Saw blade for cutting fine & medium thick materials, specially adapted for mitre guide sawing
- Universal-toothing, hardpoint teeth for long lasting sharpness
- The shape of the blade provides good rigidity, combining in this saw the properties of a tenon saw and a conventional handsaw
- Screwed 2-component handle can be used for approximate 45° and 90° marking guide

PC-20-PRC	731151	4	500	20	9/10	480

PC-12-PS

PULL-SAW



- General carpentry pull-saw for fine, cross and angled cuts
- The pull action allows for a thin blade (0.60 mm), creating a minimum of removal (kerf 0.90 mm) and therefore requiring less force
- Hardpoint, triple edge JT tooth design
- The flexibility of the blade makes it possible to perform excellent cuts close to another surface
- 2-component plastic handle ensures a comfortable and safe grip
- PC-12-14-PS-B = Replacement blade

PC-12-14-PS	8285562	4	305	12	13.5	265
PC-12-14-PS-B	8285579	10	305	12	13.5	130



PC-11-PS

PULL-SAW



- Pull-saw for extra fine, precision, cross and angled cuts
- The pull action and spine blade-support allows for an extremely thin blade (0.30 mm), creating a minimum of removal (kerf 0.40 mm) and therefore also requiring less force.
- Hardpoint, triple edge JT tooth design, makes the blade perform a perfect fine cut in wood as well as in e.g. plastic tubes
- 2-component plastic handle ensures a comfortable and safe grip
- PC-11-19-PS-B = Replacement blade

PC-11-19-PS	8285548	4	270	10 5/8	18.5	225
PC-11-19-PS-B	8285555	10	270	10 5/8	18.5	65

PC-9-PS

PULL-SAW



- Double edge fine cut Pull-saw for fine, cross, angle and rip cut
- The pull action allows for a thin blade (0.50 mm), creating a minimum of removal (kerf 0.75 mm) and therefore requiring less force
- Extra fine hard point JT toothing on one side of the blade is perfect for fine, angled and cross cut in wood as well as in e.g. plastic tubes. On the other side of the blade a progressive rip cut toothing of a more coarse type is designed to perform excellently when cutting along the wood fibres
- The flexibility of the blade makes it possible to perform excellent cuts close to another surface
- 2-component plastic handle ensures a comfortable and safe grip
- PC-9-9/17-PS-B = Replacement blade

PC-9-9/17-PS	8285586	4	240	9 1/2	6-8.5 / 17	270
PC-9-9/17-PS-B	8285593	10	240	9 1/2	6-8.5 / 17	115

PC-6-DRY

DRYWALL SAW



- Special compass saw for cutting holes in drywalls
- The sturdy blade, with triple-edge teeth, ends in a sharp point which, together with the comfortable 2-component handle, makes it perfect to use for the penetration
- Thereafter the cutting can be continued to create the desired shape of the hole in the plasterboard

PC-6-DRY	8282004	6	160	6 1/4	8	120



PROFCUT™ HANDSAWS

PC-TIM

TIMBER SAW



- Handsaw for coarse cutting
- Fleam-toothed, non-hardpoint. Can be re-sharpened by using the file 272
- Effective on the push as well as on the pull stroke
- Screwed, 2-component handle

	 731151		 mm	 "	 T ₁ P ₁ "/	 g
PC-24-TIM	8263515	4	600	24	3.5/4.5	540

PC-PLS

PLASTER SAW



- Handsaw for cutting plaster and boards of wood based material
- Specially developed toothing with new super sharp GT-toothing for the first 100 mm (at the tip), followed by groups of four teeth with extra large gullet between groups for greater efficiency and minimised clogging
- Screwed, 2-component handle

	 731151		 mm	 "	 T ₁ P ₁ "/	 g
PC-24-PLS	8263508	4	600	24	7/8	550

PC-GNP

GENERAL PURPOSE SAW



- Saw blade for cutting plastics, laminates, wood & soft metals like aluminium
- Fleam toothing, hardpoint teeth for long lasting sharpness
- Thicker blade for high precision and straight cutting with exceptionally good stability and comfort
- Toolbox sized for easy storage

	 731151		 mm	 "	 T ₁ P ₁ "/	 g
PC-15-GNP	8264307	4	375	15	15/16	225

PC-DECO

POLYSTYRENE FOAM SAW



- Handsaw for cutting polystyrene foam, often used for isolation and stucco
- Specially developed toothing with very fine ground teeth and gullets designed to combine excellent finish with minimized clogging
- Screwed 2-component handle can be used for approximate 45° and 90° marking guide

	 731151		 mm	 "	 T ₁ P ₁ "/	 g
PC-16-DECO	8264987	4	400	16	18/19	300



255

CONCRETE SAW



- Handsaw for sawing lightweight cellular concrete blocks
- 625 mm extra long blade, equipped with cemented carbide tipped tothing
- Screwed, 2-component plastic handle

255	731151	1	625	25	1.2	1040

255-15/29

CONCRETE SAW



- Handsaw for sawing lightweight cellular concrete blocks
- 625 mm extra long blade, equipped with cemented carbide tipped tothing with a carbide tip on every second tooth
- Screwed, 2-component plastic handle

255-15/29	8007850	1	625	25	0.6	1040

256

LIGHT CONCRETE SAW



- 650 mm extra large handsaw for sawing lightweight cellular concrete blocks
- Hardpoint teeth
- Screwed, 2-component plastic handle

256-26	8000080	4	650	26	2	850

PC-22-INS

INSULATION SAW



- Specially developed for cutting insulation material
- Mineral wool
- EPS - Expanded Polystyrene, cellular plastic up to 75 mm
- XPS - Extruded Polystyrene, for example Styrofoam up to 75 mm
- The hand saw has a wave formed sharpened edge (WT tothing) that allows it to slice through the material creating minimal waste
- Should be stored in sleeve for rust protection

PC-22-INS	0154500	4	550	22	WT	420



PRIZECUT™ HANDSAWS

NP

HANDSAWS



- Handsaw for cutting all types of wood
- Universal toothing with hardpoint teeth for long lasting sharpness
- Screwed 1-piece plastic handle

	 731151		 mm	 "	 T/P P/P"	 g
NP-16-U7/8-HP	8241773	4	400	16	7/8	310
NP-19-U7/8-HP	8241452	10	475	19	7/8	370
NP-22-U7/8-HP	8034399	10	550	22	7/8	420

NP-TEN

TENON SAW



- Tenon saw for fine and medium thick materials, specially adapted for cutting of small-diameter timber and mitre guide sawing
- Hardpoint universal teeth for long lasting sharpness
- Heavy steel back for rigidity and accurate cutting
- Screwed, 1-piece, plastic handle

	 731151		 mm	 "	 T/P P/P"	 g
NP-12-TEN	8263959	10	300	12	13/14	450

NP-VEN

VENEER SAW



- Veneer saw for fine and medium thick materials, such as plywood, laminates and plastics
- Hardpoint universal teeth for long lasting sharpness
- Curved, toothed nose for starting cuts in the middle of the surface of the work piece
- Screwed, 1-piece, plastic handle

	 731151		 mm	 "	 T/P P/P"	 g
NP-12-VEN	8264260	10	300	12	13/14	240



NP-COM

COMPASS SAW



- Compass saw for all kinds of wood and plastic material
- Hardpoint universal teeth for long lasting sharpness
- Screwed, 1-piece, plastic handle

NP-12-COM	731151 8264277	4	300 mm	12 "	7/8 P/"	120 g

300

GENERAL PURPOSE SAW



- General purpose saw with fine teeth for smooth sawing in a wide variety of materials, including aluminium, plastics, laminates, wood and chipboard
- Fleam-toothing
- Toolbox size
- Screwed 1-piece plastic handle

300-14-F15/16-HP	731151 8005955	4	350 mm	14 "	15/16 P/"	225 g

NP-CONC

CONCRETE SAW



- Sawing lightweight cellular concrete blocks
- 625 mm extra long blade, equipped with cemented carbide tipped teeth
- Screwed wooden handle
- NP-CONC with 34 carbide tips
- NP-CONC-17/34 with 17 carbide tips

NP-CONC	731151 8264918	2	625 mm	25 "	1.2 P/"	1040 g
NP-CONC-17/34	8264925	2	625	25	1.2	1040



OTHER HANDSAWS

2500 XT



HANDSAWS

- Saw blade for cutting medium thick materials such as plywood, ordinary wood, fibre and chipboard or plastics
- Unique XT-toothing, hardpoint teeth for long lasting sharpness
- Screwed 2-component handle can be used for approximate 45° and 90° marking guide

	 731151					
2500-16-XT-HP	8160159	4	400	16	11/12	390
2500-19-XT-HP	8160722	4	475	19	9/10	450
2500-22-XT-HP	8140922	4	550	22	9/10	490
2500-24-XT7-HP	8181338	4	600	24	7/8	540

244



HANDSAWS

- Saw blade for cutting medium thick materials
- Universal toothing, hardpoint teeth for long lasting sharpness
- Screwed 1-component handle can be used for approximate 45° and 90° marking guide

	 731151					
244-20-U7/8-HP	8012519	10	500	20	7/8	400
244-22-U7/8-HP	8012526	10	550	22	7/8	475

244P



HANDSAWS

- Saw blade for cutting medium thick materials
- Universal toothing, hardpoint teeth for long lasting sharpness
- Thicker blade for increased stability and precision
- Screwed 2-component handle can be used for approximate 45° and 90° marking guide

	 731151					
244P-20-U7-HP	8235499	4	500	20	7/8	490
244P-22-U7-HP	8235482	10	550	22	7/8	510



369

MULTI UTILITY SAW



369-BLADE



- For a variety of materials such as wood, plywood, plastics, aluminium and thin metal
- Hardpoint teeth for long lasting sharpness. Made of 1.1 mm thick steel and with black colour coating for improved rust protection
- Equipped with interchangeable blade, which can be positioned at five different angles
- 369-BLADE spare blade

	 731151		 mm	 "	 P.T.I.	 g
369	8016524	4	360	14 1/2	13/14	440
369-BLADE	8016531	20	360	14 1/2	13/14	140

296

MUSICAL SAW



- Musical saw with polished blade & a flat back
- Punched teeth not filed
- Total length including handle is 870 mm
- Traditional wooden handle

	 731151		 mm	 "	 g
296	8034146	1	750	30	1050

396-LAP

FOLDING SAW

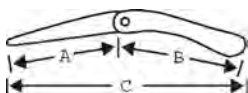

- General-purpose folding saw for cutting both green and dry wood, plastic, bone etc
- Specially designed for wildlife enthusiasts, hunters and campers
- XT hardpoint tothing, 7 TPI. Blade specially coated for rust protection and low friction
- 2-component plastic handle for perfect grip, with leather strap. Safety lock, locked also when folded

	 731151		A mm	B mm	C mm	 g
396-LAP	8172367	10	190	230	405	200
396-BLADE	8299057	1	190	-	-	44



MITRE BOX

233

MITRE BOX



- Traditional mitre box made of laminated wood for left or right hand sawing at 45°, 90° and 135° angles
- 233-300-A with side-wall extended below bottom part for improved fixation of box

	 731151		 mm	 g
233-300	8044015	5	300x104x50	600
233-400	8044022	5	400x104x50	700
233-300-A	8044039	5	300x104x50	600

234-A

MITRE BOX



- Aluminium mitre box with bottom of hard particle board
- For left or right hand sawing at 45°, 90° and 135° angles

	 731151		 mm	 g
234-A1	8013653	1	245x60x45	300
234-A2	8013660	1	245x100x30	500

234-W

MITRE BOX



- Mitre box made of laminated wood for strength and stability
- For left or right hand sawing at 45°, 90° and 135° angles

	 731151		 mm	 g
234-W1	8013608	10	245x53x40	300
234-W2	8013615	10	300x70x50	400
234-W3	8013622	10	300x70x65	500



301

COPING SAW



- Fine-precision work and sawing wood and plastics
- Nickel-plated steel frame
- Orange-lacquered, wooden beech handle
- Interchangeable blade fitted on retaining pins, turnable 360°
- Blade of hardened and tempered carbon steel, teeth milled and set, 14 TPI



301

731151
8001384

5



165



260

303

BLADES FOR COPING SAW



- Spare blade for saw 301
- Made of hardened and tempered carbon steel, teeth milled and set, 14 TPI



303-5P

731151
8031435

10



165



25



FRET SAWS AND BLADES

302

FRET SAW



- Fret saw with frame made of flat, plated steel. Wooden beech handle, orange lacquered. Fitted with a blade for wood working. Cutting depth: 300 mm/12"
- Spare blades are available-
- Nos. 302-51W, 302-53W, 302-55W, 302-57W, 302-81S, 302-83S, for wood and plastic-
- Nos. 302-71M, 302-73M, 302-75M, for metal..

302	8013349	5	130	370

502

FRET SAW



- Fret saw with frame made of 12 mm steel tube
- Cutting depth: 300 mm/12"
- Wooden handle

502	8130589	5	130	250

502/

FRET SAW SET



- Fret saw sets, with 2 pieces for 502-SET2 and 6 pcs for 502-SET6

502-SET2	8130664	5	130
502-SET6	8130633	5	500

302-6X4P

FRET SAW BLADES



- Assortment of blades for fret saws 302 and 502
- Four blades each of: 51W, 53W, 55W, 57W, 73M and 83S

302-6X4P	8017590	1	130	20









302M

FRET SAW BLADES



- Spare blade for fret saws 302 and 502, for metal
- Types of tooth: 1: Fine, 3-5: Medium, 7: Coarse







	 731151			 mm	 g
302-71M-12P	8013394	1	1	130	50
302-73M-12P	8013400	1	3	130	50
302-75M-12P	8013417	1	5	130	50
302-77M-12P	8207793	1	7	130	50

302S

FRET SAW BLADES



- Spiral spare blade for fret saws 302 and 502, for wood and plastics
- Types of tooth: 1: Fine, 3: Medium, 5: Coarse







	 731151			 mm	 g
302-81S-12P	8013677	1	1	130	50
302-83S-12P	8013684	1	3	130	50
302-85S-12P	8207809	1	5	130	50

302W

FRET SAW BLADES



- Spare blade for fret saws 302 and 502, for wood and plastic
- Types of tooth: 1-3: Fine, 5-7: Medium, 9-11: Coarse

	 731151			 mm	 g
302-51W-12P	8013356	1	1	130	50
302-53W-12P	8013363	1	3	130	50
302-55W-12P	8013370	1	5	130	50
302-57W-12P	8013387	1	7	130	50
302-59W-12P	8207779	1	9	130	50
302-511W-12P	8207786	1	11	130	50



BOWSAWS

10

ERGO™ BOWSAWS



- Bowsaw frame developed according to the scientific ERGO™ process
- ERGO™ handle with knuckle protector gives ergonomic comfort and safety
- Heavy duty bowsaw
- Made from high-quality steel and protected from rust and corrosion by a coating of high-impact enamel paint
- Design for demanding applications and tough environments as construction sites
- Lightweight tubing, 24" - 750 g, for easy handling
- Innovative tensioning mechanism for high blade tension (up to 120 kp) and straight cutting
- Better and stronger blade fitting for easy and safe blade change

	 731151		 mm	 "		 g
10-21-51	8229344	5	530	21	51	680
10-24-23	8229368	5	604	24	23	743
10-24-51	8229351	5	604	24	51	743
10-30-23	8229382	5	760	30	23	865
10-30-51	8229375	5	760	30	51	865

332

ERGO™ BOWSAWS



- Bowsaw frame developed according to the scientific ERGO™ process
- Lightweight, heavy-duty saw with high blade tension for straight cutting
- Pointed nose for better access in tight areas, such as roofing and gardening
- Made from high-quality steel and protected from rust and corrosion by a coating of high-impact enamel paint
- Innovative easy-to-use mechanism allows for maximum tension and safe handling
- Integrated knuckle protector for protection of the hand

	 731151		 mm	 "		 g
332-21-51	8229337	5	530	21	51	663

2-21-51

BOWSAW



- General-purpose 21" bowsaw with reversible blade
- Fitted with a type 51 blade for dry wood

	 731596		 mm	 "		 g
2-21-51	2500011	5	530	21	51	620





3-24-51

BOWSAW



- General-purpose 24" bowsaw with reversible blade
- Fitted with a type 51 blade for dry wood

	 731596		 607	 24		 9
3-24-51	2500028	5	607	24	51	740

331

BOWSAW



- A small handy 21" bowsaw for all-round use
- The pointed nose makes the saw ideal for use in tight spaces and it is well suited for pruning & roofing work
- Supplied with a 51 series blade for cutting dry wood

	 731151		 530	 21		 9
331-21-51-KP	8003814	5	530	21	51	615

SE -15/-16

BOWSAW



SE-15



SE-16-21

- Professional bowsaw for all types of work, especially in building, gardening, farming and forestry applications
- Complete saw with a peg toothed blade, type 51, for cutting dry wood
- Powder painted steel tube for excellent rust protection
- Teeth points high-frequency, heat-induction hardened for long lasting performance
- The knuckle protector gives comfort and safety
- SE-16-21 with pointed nose for better access in tight areas
- 23 raker toothed blade for pruning and gardening (wet wood)

	 731151		 mm	 "		 g
SE-16-21	8029807	5	530	21	51	570
SE-16-21-23	8273934	5	530	21	23	570
SE-15-24	8029838	5	610	24	51	675
SE-15-30	8029821	5	760	30	51	800
SE-15-30-23	8029845	5	760	30	23	800
SE-15-32	8249168	5	810	32	51	840
SE-15-36	8141202	5	910	36	51	920
SE-15-36-23	8258276	5	910	36	23	920



BOWSAWS

333

BOWSAW



- A general-purpose bow saw for gardening and home repairs
- The steel frame has special blade holders with an extra strong blade attachment mechanism
- Reversible blade, hardened for durability, which can be rotated around its long axis

	 731151		 mm	 mm		 g
333	8005832	5	350	14	333-5	615

14-24

BOWSAW



- A spiro frame well suited for building and construction jobs for the professional worker as well as the serious hobbyist
- Equipped with 3810 blade for cutting ventilation tubes, thin-walled steel tubes, soft metal reinforcement bars and aluminium joists and beams
- Made of strong, cold-drawn steel tubing

	 731151		 mm	 mm	 g
14-24-3810	8002879	5	610	24	1100

9-12

BOWSAW



- Toolbox-sized mini bow saw, ideal for plumbers and electricians
- Easily stored
- With a 300 mm (12") type 51 blade for wood cutting and including a Sandflex® bi-metal hacksaw blade 3906
- Blade protector for safety and metal hand guard to prevent knuckle injuries

	 731151		 mm	 mm	 g
9-12-51/3806-KP	8044558	5	300	12	520



51

BOWSAW BLADES



- For cutting dry, seasoned wood, as well as for cross-cutting fresh, green wood
- Peg toothing
- Hardened and tempered high-quality steel
- Tooth points high-frequency, heat-induction hardened for long lasting performance
- Rust-prevention treated and packed in individual sleeve printed with graphically illustrated text for correct blade selection





	 731151		 L mm	 g
51-12	8044565	10	320	30
51-21	8003906	10	530	50
51-24	8003913	10	607	65
51-30	8003920	10	759	80
51-32	8003937	10	810	90
51-36	8003944	10	912	100

23

BOWSAW BLADES



- Suitable for sawing in green wood
- Raker toothing
- Hardened and tempered high-quality steel
- Tooth points high-frequency, heat-induction hardened for long lasting performance
- Rust-prevention treated and packed in individual sleeve printed with graphically illustrated text for correct blade selection

	 731151		 L mm	 g
23-15	8274665	10	380	33
23-21	8012274	10	530	45
23-24	8003852	10	607	60
23-30	8003869	10	759	75
23-32	8003876	10	810	85

333-5

BOWSAW BLADES



- For sawing in green wood, this is the only blade for the 333 general-purpose saw
- Fine peg toothing
- Hardened and tempered high-quality steel
- Tooth points high-frequency, heat-induction hardened for long lasting performance
- Rust-prevention treated and packed in individual sleeve

	 731151		 L mm	 g
333-5	8005849	10	350	30

WOOD CHISELS & ACCESORIES

These precision instruments are ideal for a wide range of applications; from shaping the most delicate joints, to rugged construction-site work. Their precision-ground blades guarantee a super sharp bite. Available in various sizes, Bahco chisels offer a choice of handles carefully engineered to satisfy any requirements.



Chapter Index

WOOD CHISELS	1020-1026
GRINDING STONES	1027



434 ERGO™ SPLITPROOF CHISEL



Specially designed 2-component, splitproof ERGO™ handle maximizes control and comfort.

- Precision ground blade for maximum sharpness
- Hardened and tempered for long lasting performance
- Honed and ready to use. Polished blade for rust resistance
- Safety guard with rounded shoulders
- Protective holster included
- Size range: 4–40 mm



HAMMER IMPACT RESISTANT

Bahco 434 has a splitproof polyamide handle that absorbs repeated hammer blows. Developed by following Bahco ERGO™ Process and in close collaboration with professionals, it is tailored for more demanding carpentry and construction jobs. The 2-component handle fits the hand comfortably and provides a non-slip grip. The specially-designed safety guard has rounded shoulders.



WRECKING KNIFE 2448

The Bahco wrecking knife is a heavy-duty product made of impact resistant PPE with a blade hardened to 58-61Hrc for a long, sharp life. It features a curved knuckle protector and therefore can be used as a lever for hard work.

The back edge of the tool can be struck with a hammer to work faster.

The wrecking knife can be used for making mortise joints in doors, splitting wood, etc.

CURVED KNUCKLE GUARD

Protects fingers and stops them slipping onto the blade. Also can be used as a lever for fast work

HOLSTER WITH BUTTON CLIP

Compatible with workwear



SPLITPROOF

Hammer impact resistant

100 mm LONG BLADE
Increased striking area



BACK EDGE

Can be struck with a hammer

4 mm THICK BLADE
Heavy duty use

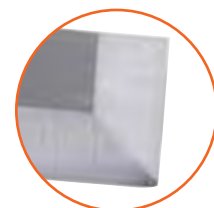

WARNING

This product is very sharp and care should be taken during use to avoid injuries, e.g. cutting fingers



WOOD CHISELS

434

CHISELS

ergo®



- Chisel developed according to the scientific ERGO™ process
- Splitproof 2-component handle allows the use of a hammer
- Safety guard and rounded shoulders for added security
- Precision ground blade for maximum sharpness
- Hardened and tempered for long lasting performance
- Honed and ready to use
- Polished blade for increased rust resistance
- Protective holster included
- Size range: 6 to 38 mm (1/4 to 1 1/2")

	 731151		A mm	B mm	 g
434-6	8238483	4	6	140	200
434-8	8238490	4	8	140	206
434-10	8238506	4	10	140	213
434-12	8238513	4	12	140	220
434-14	8238520	4	14	140	228
434-15	8238537	4	15	140	232
434-16	8238544	4	16	140	241
434-18	8238551	4	18	140	245
434-20	8238568	4	20	140	256
434-22	8238575	4	22	140	268
434-25	8238582	4	25	140	284
434-28	8238599	4	28	140	299
434-30	8238605	4	30	140	309
434-32	8238612	4	32	140	319
434-35	8238629	4	35	140	333
434-38	8238636	4	38	140	348

434-S3-EUR

CHISELS

ergo®



- Chisel developed according to the scientific ERGO™ process
- Splitproof 2-component handle allows the use of a hammer
- Safety guard and rounded shoulders for added security
- Precision ground blade for maximum sharpness
- Hardened and tempered for long lasting performance
- Honed and ready to use
- Polished blade for increased rust resistance
- Set with individual holsters

	 731151		 g
434-S3-EUR	8249212	1	819

434-S3-EUR

12, 18, 25 mm





434-S6-EUR

ergo®



CHISELS

- Chisel developed according to the scientific ERGO™ process
- Splitproof 2-component handle allows the use of a hammer
- Safety guard and rounded shoulders for added security
- Precision ground blade for maximum sharpness
- Hardened and tempered for long lasting performance
- Honed and ready to use
- Polished blade for increased rust resistance
- 6 piece set with tip protector
- In an exclusive wooden box

	 731151		 g
434-S6-EUR	8267544	1	1600
434-S6-EUR		6, 10, 12, 18, 25, 32 mm	



424P

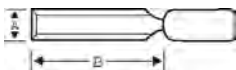

CHISELS

- Specially designed 2-component handle maximizes control and comfort
- Precision ground blade for maximum sharpness
- Hardened and tempered for long lasting performance
- Honed and ready to use
- Protective holster included
- Size range: 4 to 40 mm (5/32 to 1 9/16")

	 731151		A mm	B mm	 g
424P-4	8238285	4	4	140	195
424P-6	8238292	4	6	140	201
424P-8	8238308	4	8	140	207
424P-10	8238315	4	10	140	214
424P-12	8238322	4	12	140	221
424P-14	8238339	4	14	140	229
424P-15	8238346	4	15	140	233
424P-16	8238353	4	16	140	242
424P-18	8238360	4	18	140	246
424P-20	8238377	4	20	140	257
424P-22	8238384	4	22	140	269
424P-24	8238391	4	24	140	280
424P-25	8238407	4	25	140	285
424P-26	8238414	4	26	140	290
424P-28	8238421	4	28	140	300
424P-30	8238438	4	30	140	310
424P-32	8238445	4	32	140	320
424P-35	8238452	4	35	140	334
424P-38	8238469	4	38	140	349
424P-40	8238476	4	40	140	358



WOOD CHISELS

424P-S3-EUR



CHISELS

- Specially designed 2-component handle maximizes control and comfort
- Precision ground blade for maximum sharpness
- Hardened and tempered for long lasting performance
- Honed and ready to use
- The set comes with individual holsters

	 731151		 g
424P-S3-EUR	8249199	1	825
424P-S3-EUR		12, 18, 25 mm	

424P-S6/S8



CHISELS

- Specially designed 2-component handle maximizes control and comfort
- Precision ground blade for maximum sharpness
- Hardened and tempered for long lasting performance
- Honed and ready to use
- Set has tip protectors
- Comes in an exclusive wooden box

	 731151		 g
424P-S6-EUR	8269968	1	1385
424P-S8-EUR	8276393	1	2240
424P-S6-EUR		6, 10, 12, 18, 25, 32 mm	
424P-S8-EUR		6, 10, 12, 16, 18, 25, 32 38 mm	

414



CHISELS

- 1-component polypropylene handle
- Precision ground blade for maximum sharpness
- Hardened and tempered for long lasting performance
- Protective holster included
- Size range: 6 to 38 mm (1/4 to 1 1/2")

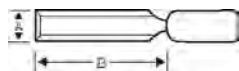

	 731151		A mm	B mm	 g
414-6	8238117	4	6	140	176
414-8	8238131	4	8	140	188
414-12	8238155	4	12	140	202
414-14	8238162	4	14	140	210
414-15	8238179	4	15	140	214
414-16	8238186	4	16	140	223
414-18	8238193	4	18	140	227
414-20	8238209	4	20	140	238
414-25	8238223	4	25	140	266
414-28	8238230	4	28	140	281
414-30	8238247	4	30	140	291
414-32	8238254	4	32	140	301
414-35	8238261	4	35	140	315
414-38	8238278	4	38	140	330



414-S

CHISELS



- 1-component polypropylene handle
- Precision ground blade for maximum sharpness
- Hardened and tempered for long lasting performance
- Set comes with individual holsters

	 731151		 g
414-S3-EUR	8249205	1	766
414-S3-EUR		12, 18, 25 mm	



425

CHISELS

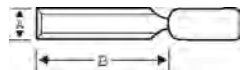

- Handle of red beech wood, with nickel plated steel ferrule to prevent it from splitting when struck
- Blades of high-quality tool steel with tapered neck
- Chisels have a full bevel pattern, which means the sides of the blades have been bevelled down to approximately half the blade thickness
- Ground and ready for use
- One flat side prevents the chisel from rolling off the work bench
- Fitted with a tip protector

	 731151		A mm	B mm	 g
425-4	8030810	4	4	140	80
425-6	8004590	4	6	140	98
425-8	8004606	4	8	140	100
425-10	8004613	4	10	140	114
425-12	8004620	4	12	140	114
425-14	8004637	4	14	140	140
425-15	8017767	4	15	140	140
425-16	8004644	4	16	140	140
425-18	8004651	4	18	140	136
425-20	8004668	4	20	140	170
425-22	8004675	4	22	140	170
425-24	8005993	4	24	140	200
425-25	8004682	4	25	140	200
425-26	8006006	4	26	140	200
425-28	8004699	4	28	140	250
425-30	8004705	4	30	140	250
425-32	8004712	4	32	140	250
425-35	8017774	4	35	140	300
425-38	8004729	4	38	140	310
425-40	8017781	4	40	140	330



WOOD CHISELS

425-081/082



CHISELS

- Handle of red beech wood, with nickel plated steel ferrule to prevent it from splitting when struck
- Blades of high-quality tool steel with tapered neck
- Chisels and gouges have a full bevel pattern, which means the sides of the blades have been bevelled down to approximately half the blade thickness
- Ground and ready for use
- One flat side prevents the chisel from rolling off the work bench
- Fitted with a tip protector

	 731151		 g
425-081	8010669	1	560
425-082	8010676	1	780
425-081 12, 18, 25 mm		425-082 6, 10, 12, 18, 25 mm	

425-083



CHISELS

- Handle of red beech wood, with nickel plated steel ferrule to prevent it from splitting when struck
- Blades of high-quality tool steel with tapered neck
- Chisels have a full bevel pattern, which means the sides of the blades have been bevelled down to approximately half the blade thickness
- Ground and ready for use
- One flat side prevents the chisel from rolling off the work bench
- Fitted with a tip protector
- Comes in wooden box

	 731151		 g
425-083	8010683	1	1600
425-083	6, 10, 12, 18, 25, 32 mm		



1031

CHISELS

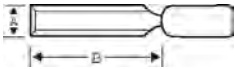

- Handle of very tough red plastic compound
- Use club or hammer with care
- All chisels have blades of high-quality tool steel with tapered neck
- Chisels and gouges have a full bevel pattern, which means the sides of the blades have been bevelled down to approximately half the blade thickness
- Ground, honed and ready for use

	 731151		A mm	B mm	 g
1031-4	0025411	5	4	140	100
1031-6	0025428	5	6	140	100
1031-8	0025435	5	8	140	110
1031-10	0025442	5	10	140	115
1031-12	0025459	5	12	140	115
1031-14	0025466	5	14	140	135
1031-16	0025473	5	16	140	140
1031-18	0025480	5	18	140	155
1031-20	0025497	5	20	140	160
1031-22	0025503	5	22	140	170
1031-25	0025510	5	25	140	200
1031-28	0025527	5	28	140	210
1031-30	0025534	5	30	140	220
1031-32	0025541	5	32	140	230
1031-40	0025558	5	40	140	305

9883

CHISELS



- Handle of very tough red plastic compound
- Use club or hammer with care
- All chisels have blades of high-quality tool steel with tapered neck
- Chisels and gouges have a full bevel pattern, which means the sides of the blades have been bevelled down to approximately half the blade thickness
- Ground, honed and ready for use

	 731415		 g
9883	0043293	1	700
1031			
6, 12, 16, 20, 25 mm			





WOOD CHISELS

956

SPARE HANDLE



- Spare handle for 1031 chisels

	 731415		 g
956	0025190	1	50

422P

GOUGE

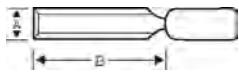

- Specially designed 2-component handle maximizes control and comfort
- Curved for cutting shallow indentations or curved grooves
- Precision ground blade for maximum sharpness
- Hardened and tempered for long lasting performance
- Honed and ready to use
- Protective holster included

	 731151		A mm	B mm	 g
422P-6	8248352	4	6	158	180
422P-10	8248369	4	10	158	190
422P-12	8248376	4	12	158	200
422P-16	8248383	4	16	158	215
422P-20	8248390	4	20	158	220
422P-25	8248406	4	25	158	250

2448

WRECKING KNIFE

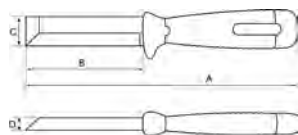

- Heavy duty product made from impact resistant PPE with a blade hardened to 58-61 Hrc for a long lasting edge
- Curved knuckle protector can be used as a lever for hard work
- The back edge of the tool can be struck with a hammer to make working faster
- Uses are for making mortise joints in doors, splitting wood, amongst other uses
- 4 mm thick blade for heavy duty use
- 100 mm long blade which increases the striking area



2448

	 731415		A mm	B mm	C mm	D mm	 g
2448	0136049	12	231	100	25	4	200
SB-2448	0136056	10	231	100	25	4	260



528-700

GRINDING STONE



- Natural stone with approx. 700 grains/cm² to achieve a razor-sharp cutting edge on chisels, plane irons and other tools
- A pre-condition is that the tools have no dents or rough cutting surface, otherwise they have to be treated with the rough side of combination stone 528-COM first
- Dents and rough surfaces might damage the surface of this stone by making grooves

528-700	731151 8188993	1	150 mm	420 g

528-COM

GRINDING STONE



- Artificial combination stone with two grains for restoring and sharpening the cutting edge of chisels, plane irons etc
- Side A - rough side with 120 grains/cm², suitable for removal of dents in the cutting edge, to even or straighten out cutting surface, following the original pattern of the tool
- Side B - fine side with 400 grains/cm², suitable for sharpening of cutting edges and smoothing of cutting surfaces

528-COM	731151 8188986	1	150 mm	340 g

SCISSORS & KNIVES

In use for centuries, scissors and knives have been continually improved and adapted for all kinds of purposes.

Some Bahco scissors and knives have been designed to cut all types of materials, while others are suited to specific applications such as roofing paper and electrical wiring.

The Bahco range includes specialist products such as aviation snips and metal shears for cutting tough material, as well as electrician knives and scissors for a wide range of high-voltage applications.

There are also more multipurpose tools such as utility knives, multitools, carpenter and pruning knives.

They all provide the professional user with the essential products they rely on every day.



Chapter Index

METAL SHEARS	1032-1041
SCISSORS	1042-1043
KNIVES	1044-1048



METAL SHEARS

The Bahco metal shear range helps you use the right shear to get your job done more efficiently. Whether working in heavy industry or doing lighter

metal-cutting jobs, you will find shears that are fit for purpose. The tables below will help you find the right tool for the job.

Recommendations may vary slightly for harder and extreme gauges.

Shears	Industrial branch							
	HV/ AC installation	Dry-wall installation	Ceiling installation	Roofing	Tech. insulation	Heavy industry	Warehouse strap-cutting	Discerning private usage
MA225	●●●	●●●						
MA225R	●●	●●	●●	●●	●●		●	
MA225L	●●	●●	●●	●●	●●		●	
MA321	●●	●●	●●	●●	●●		●	
MA311	●●	●●	●●	●●	●●		●	
MA325	●			●	●		●●●	
MA361	●			●	●		●●●	
MA351	●			●	●		●●●	
MA431		●	●					●●
MA421		●	●				●	●●
MA401		●	●				●	●●
MA411		●	●				●	●●
MR126		●●	●●				●●	●
MR227R	●●			●●	●●		●	●
MR227L	●●			●●	●●		●	●
MR340	●●			●●●	●●			●●
MR726		●	●					●
M126		●●	●●				●●	
M227R	●●			●●	●●		●	
M227L	●●			●●	●●		●	
M330	●●			●●				
M526		●	●	●				
M722		●	●	●				
M726		●	●	●				
M730		●	●	●				
8691				●	●			
583D	●●●			●●●	●●●			●●●
584D	●●●			●●●	●●●			●●●
585D	●●●			●●●	●●●			●●●
586D	●●●			●●●	●●●			●●●
M926	●●			●●	●●			
M676						●●●		
M6376						●●●		

highly recommended: ●●● / recommended: ●● / useful: ●

Shears	Type of cut							
	Corner-snipping	Notching	Sharving	Left-cut	Right-cut	Straight through cut	Left hole-cut	Right hole-cut
MA225	●●●	●●●	●●●					
MA225R	●●	●●	●●		●●			●
MA225L	●●	●●	●●	●●			●	
MA321	●●	●●	●●		●●			●
MA311	●●	●●	●●	●●			●	
MA325	●●	●●	●●			●●		
MA361	●●	●●	●●		●●			
MA351	●●	●●	●●	●●				
MA431	●●	●●	●●			●		
MA421	●●	●●	●●			●●		
MA401	●●	●●	●●	●				
MA411	●●	●●	●●		●			
MR126	●●●	●●●	●●●					
MR227R	●●	●●	●●		●●			●
MR227L	●●	●●	●●	●●			●	
MR340	●●	●●	●●			●●●		
MR726	●●●	●●●	●●●					
M126	●●●	●●●	●●●					
M227R	●●	●●	●●		●●			●
M227L	●●	●●	●●	●●			●	
M330	●●	●●	●●			●●●		
M526	●●●	●●●	●●●					
M722	●●●	●●●	●●●					
M726	●●●	●●●	●●●					
M730	●●●	●●●	●●●					
8691	●●	●●	●		●●			
583D	●●●	●●	●●●	●●●		●●●	●●●	
584D	●●●	●●	●●●		●●●	●●●		●●●
585D	●●●	●●	●●●	●●●		●●●	●●●	
586D	●●●	●●	●●●		●●●	●●●		●●●
M926				●	●	●●		
M676	●●●	●●	●					
M6376	●●●	●●	●			●●●		

highly recommended: ●●● / recommended: ●● / useful: ●



METAL SHEARS

MA225

AVIATION/COMPOUND SHEARS



- Aviation shears for straight cutting of hard and difficult-to-cut steel plate
- With lever action for highest efficiency
- Forged blades, made of specially hardened tool steel
- Blade angles sharpened for long and consistent performance
- Strong handles of fibreglass and nylon for safe and comfortable grip
- Single hand operated safety lock
- Packaging: On informative card
- Cutting capacity: 1 - Stainless steel, 2 - Cold rolled steel

	 731151		 mm	 1 mm	 2 mm	 g
MA225	8161057	4	250	0.8	1.2	420

MA225L

AVIATION/COMPOUND SHEARS



- Aviation shears for straight and left cutting of hard and difficult-to-cut steel plate
- With lever system for highest efficiency
- Forged blades, made of specially hardened tool steel
- Blade angles sharpened for long and consistent performance
- Strong handles of fibreglass and nylon for safe and comfortable grip
- Single hand operated safety lock
- Packaging: On informative card
- Cutting capacity: 1 - Stainless steel, 2 - Cold rolled steel

	 731151		 mm	 1 mm	 2 mm	 g
MA225L	8161033	4	250	0.8	1.2	420

MA225R

AVIATION/COMPOUND SHEARS



- Aviation shears for straight and right cutting of hard and difficult-to-cut steel plate
- With lever system for highest efficiency
- Forged blades, made of specially hardened tool steel
- Blade angles sharpened for long and consistent performance
- Strong handles of fibreglass and nylon for safe and comfortable grip
- Single hand operated safety lock
- Packaging: On informative card
- Cutting capacity: 1 - Stainless steel, 2 - Cold rolled steel

	 731151		 mm	 1 mm	 2 mm	 g
MA225R	8161040	4	250	0.8	1.2	420



MA401

AVIATION/COMPOUND SHEARS



- Metal shears designed for occasional use by craftsmen and home use
- Cut sheet metal up to 1.5 mm
- Forged from steel containing chromium and molybdenum for good resistance
- Milled cutting edges, serrated and induction hardened to 60-62 HRC
- Lever system increases efficiency
- Handles with soft grip part and return spring to enhance the working comfort
- Red handle = left cut
- Cutting capacity: 1 - Stainless steel, 2 - Cold rolled steel

MA401	731415 0167593	4	250 mm	0.7 mm	1.2 mm	390 g

MA411

AVIATION/COMPOUND SHEARS



- Metal shears designed for occasional use by craftsmen and home use
- Cut sheet metal up to 1.5 mm
- Forged from steel containing chromium and molybdenum for good resistance
- Milled cutting edges, serrated and induction hardened to 60-62 HRC
- Lever system increases efficiency
- Handles with soft grip part and return spring to enhance the working comfort
- Green handles = right cut
- Cutting capacity: 1 - Stainless steel, 2 - Cold rolled steel

MA411	731415 0167609	4	250 mm	0.7 mm	1.2 mm	395 g

MA421

AVIATION/COMPOUND SHEARS



- Metal shears designed for occasional use by craftsmen and home use
- Cut sheet metal up to 1.5 mm
- Forged from steel containing chromium and molybdenum for good resistance
- Milled cutting edges, serrated and induction hardened to 60-62 HRC
- Lever system increases efficiency
- Handles with soft grip part and return spring to enhance the working comfort
- Yellow handles = straight cut
- Cutting capacity: 1 - Stainless steel, 2 - Cold rolled steel

MA421	731415 0167616	4	250 mm	0.7 mm	1.2 mm	405 g



METAL SHEARS

MA431



AVIATION/COMPOUND SHEARS

- Multipurpose metal shears designed for occasional use by craftsmen, and home use
- Cut sheet metal up to 1.1 mm and the length of the cut is 75 mm
- Forged from a steel alloy containing chromium and molybdenum for good resistance
- Milled cutting edges, serrated and induction hardened to 58-60 HRC
- Lever system increases efficiency
- Handles with soft grip part and return spring to enhance the working comfort
- Orange handles = long, straight cut
- Cutting capacity: 1 - Stainless steel, 2 - Cold rolled steel

	 731415		 L mm	 1 mm	 2 mm	 g
MA431	0181544	1	290	0.53	0.94	465

MA311



AVIATION/COMPOUND SHEARS

- Metal shears designed for professional use
- Cutting capacity up to 1.8 mm of sheet metal
- Forged from a steel alloy containing chromium and molybdenum for high resistance
- Milled cutting edges, serrated and induction hardened to 60-62 HRC
- Lever system increases efficiency
- Handles with soft grip part and return spring to enhance the working comfort
- Red handles = left cut
- Cutting capacity: 1 - Stainless steel, 2 - Cold rolled steel

	 731415		 L mm	 1 mm	 2 mm	 g
MA311	0181568	1	260	0.9	1.5	490

MA321



AVIATION/COMPOUND SHEARS

- Metal shears designed for professional use
- Cutting capacity up to 1.8 mm of sheet metal
- Forged from a steel alloy containing chromium and molybdenum for high resistance
- Milled cutting edges, serrated and induction hardened to 60-62 HRC
- Lever system increases efficiency
- Handles with soft grip and return spring to enhance working comfort
- Green handles = right cut
- Cutting capacity: 1 - Stainless steel, 2 - Cold rolled steel

	 731415		 L mm	 1 mm	 2 mm	 g
MA321	0181551	1	260	0.9	1.5	490



MA325

PASS-THROUGH/ COMPOUND SHEARS



- Compound shears with lever action
- For straight cutting and passing through cuts in hard and difficult-to-cut steel plate
- Forged blades, made of specially hardened tool steel
- Blade angles sharpened for long and consistent performance
- Strong handles of fibreglass and nylon for safe and comfortable grip
- Single hand operated safety lock
- Packaging: On informative card
- Cutting capacity: 1 - Stainless steel, 2 - Cold rolled steel

MA325	731151 8161064	4	250 mm	1 mm	2 mm	430 g

MA361

PASS-THROUGH/ COMPOUND SHEARS



- Metal shears designed for professional use
- Cutting capacity up to 1.8 mm of sheet metal
- Cutting head particularly adapted for long cuts in confined spaces, allows hands to be kept above the work piece
- Jaws forged from steel alloy containing chromium and molybdenum for high resistance
- Milled cutting edges, serrated and induction hardened to 60-62 HRC
- Lever system increases efficiency
- Handles with soft grip part and return spring to enhance working comfort
- Green handles = right cut
- Cutting capacity: 1 - Stainless steel, 2 - Cold rolled steel

MA361	731415 0181575	1	250 mm	1 mm	1.5 mm	550 g

MA351

PASS-THROUGH/ COMPOUND SHEARS



- Metal shears designed for professional use and for cutting very hard and thick tin
- Cutting capacity up to 1.8 mm of sheet metal
- Cutting head particularly adapted for making long cuts in confined spaces, allows hands to be kept above the work pieces
- Jaws forged of a steel alloy containing chromium and molybdenum for high resistance
- Milled cutting edges, serrated and induction hardened to 60-62 HRC
- Lever system increases efficiency
- Handles with soft grip and return spring to enhance working comfort
- Red handles = left cut
- Cutting capacity: 1 - Stainless steel, 2 - Cold rolled steel

MA351	731415 0181582	1	250 mm	1 mm	1.5 mm	550 g



METAL SHEARS

M126

TRADITIONAL/INDUSTRIAL SHEARS



- Straight cutting metal shears with 2 thin blades
- For corner snipping, shaving, notching works when work-space is limited
- Forged blades, made of specially hardened tool steel
- Blade angles sharpened for long and consistent performance
- Industrial packaging
- Cutting capacity: 1 - Stainless steel, 2 - Cold rolled steel

	 731151					
M126	8160920	4	260	0.6	1.2	500

M330

TRADITIONAL/INDUSTRIAL SHEARS



- Pass-through cutting metal shear
- For long straight cuts through the sheet metal
- Forged blades, made of specially hardened tool steel
- Blade angles sharpened for long and consistent performance
- Industrial packaging
- Cutting capacity: 1 - Stainless steel, 2 - Cold rolled steel

	 731151					
M330	8160906	4	11 3/4	0.9	1.5	790

M730

TRADITIONAL/INDUSTRIAL SHEARS



- Straight cutting metal shears with 1 thin/1 thick blade
- Also called "Universal straight metal shears"
- For corner snipping, shaving, notching works
- Cutting capacity: 1 - Stainless steel, 2 - Cold rolled steel

	 731151					
M722	8160937	4	220	0.4	1.0	360
M726	8160944	4	260	0.6	1.2	500
M730	8160968	2	300	0.6	1.2	700



8691

TRADITIONAL/INDUSTRIAL SHEARS

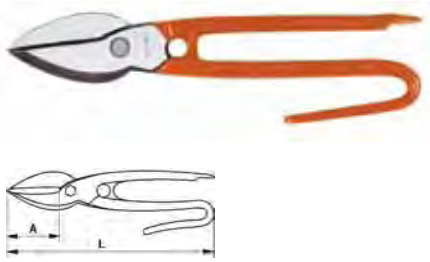

- Right cutting metal shears, Spanish type, called model Madrid
- Hardness in the cutting edge 53-57 HRC

	 841334		A mm	L mm	 g
869102000	5083645	6	38	200	350
869102500	5083669	6	44	250	525
869103000	5116640	6	50	300	730

MR126

TRADITIONAL/RETAIL SHEARS



- Straight cutting metal shears with 2 thin blades
- For corner snipping, shaving works when work-space is limited
- Forged blades, made of specially hardened tool steel
- Blade angles sharpened for long and consistent performance
- Strong handles with plastic sleeves for comfortable grip, with removable return spring
- Packaging: Informative retail card
- Cutting capacity: 1 - Stainless steel, 2 - Cold rolled steel

	 731151		 L mm	 1 mm	 2 mm	 g
MR126	8161019	4	260	0.6	1.2	510

MR227L

TRADITIONAL/RETAIL SHEARS



- Left and straight cutting metal shears with 2 thin blades
- For cutting arcs to the left, for trimming and notching works when work-space is limited
- Forged blades, made of specially hardened tool steel
- Blade angles sharpened for long and consistent performance
- Strong handles with plastic sleeves for comfortable grip and removable return spring
- Cutting capacity: 1 - Stainless steel, 2 - Cold rolled steel

	 731151		 L mm	 1 mm	 2 mm	 g
MR227L	8161002	4	270	0.6	1.2	570



METAL SHEARS

MR227R



TRADITIONAL/RETAIL SHEARS

- Right and straight cutting metal shears with 2 thin blades
- For cutting arcs to the right, for trimming and notching work when work-space is limited
- Forged blades, made of specially hardened tool steel
- Blade angles sharpened for long and consistent performance
- Strong handles with plastic sleeves for comfortable grip and removable return spring
- Cutting capacity: 1 - Stainless steel, 2 - Cold rolled steel

	 731151		 L mm	 1 mm	 2 mm	 g
MR227R	8160999	4	270	0.6	1.2	570

MR726



TRADITIONAL/RETAIL SHEARS

- Straight cutting metal shear with 1 thin/1 thick blade
- Also called "Universal straight metal shear"
- For corner snipping, shaving, notching works
- Forged blades made of specially hardened tool steel
- Blade angles sharpened for long and consistent performance
- Strong handles with plastic sleeves for comfortable grip and removable return spring
- Cutting capacity: 1 - Stainless steel, 2 - Cold rolled steel

	 731151		 L mm	 1 mm	 2 mm	 g
MR726	8161026	4	260	0.6	1.2	510

MR340



M330

MR340

PASS-THROUGH SHEARS

- "Pelican shear", designed to cut straight and pass-through the sheet metal
- Length of cut: 70 mm
- Forged blades, made of specially hardened tool steel
- Strong handles with plastic sleeves for comfortable grip
- Blade angles sharpened for long and consistent performance
- Packaging: Informative retail card
- Cutting capacity: 1 - Stainless steel, 2 - Cold rolled steel

	 731151		 L mm	 1 mm	 2 mm	 g
M330	8160906	4	300	0.9	1.5	790
MR340	8197537	2	350	0.4	1.2	800



583D

OFFSET RIGHT METAL SHEARS



- Offset metal shears designed to cut straight, curves (holes) to the right and pass-through the sheet metal
- Serration on the upper blade to avoid sliding with hard material when notching or trimming
- For cutting of medium to hard materials
- PVC sleeved handles
- Cutting capacity: 1 - Stainless steel, 2 - Cold rolled steel

	 731415		 mm	 1 mm	 2 mm	 g
583D	0023721	4	280	0.6	1.2	670

585D

OFFSET RIGHT METAL SHEARS



- Offset metal shears, designed to cut straight, curves (holes) to the right and pass-through the sheet metal
- For cutting of soft/medium materials
- PVC sleeved handles
- Cutting capacity: 1 - Stainless steel, 2 - Cold rolled steel

	 731415		 mm	 1 mm	 2 mm	 g
585D	0104185	4	280	0.6	1.2	670

584D

OFFSET LEFT METAL SHEARS



- Offset metal shears designed to cut straight, curves (holes) to the left and pass-through the sheet metal
- Serration on the upper blade to avoid sliding with hard material when notching or trimming
- For cutting of medium/hard materials
- PVC sleeved handles
- Cutting capacity: 1 - Stainless steel, 2 - Cold rolled steel

	 731415		 mm	 1 mm	 2 mm	 g
584D	0023745	4	280	0.6	1.2	670



METAL SHEARS

586D

OFFSET LEFT METAL SHEARS



- Offset metal shears designed to cut straight, curves (holes) to the left and pass-through the sheet metal
- For cutting of soft/medium materials
- PVC dipped handles
- Cutting capacity: 1 - Stainless steel, 2 - Cold rolled steel

	 731415		 L mm	 1 mm	 2 mm	 g
586D	0104208	4	280	0.6	1.2	625

M6376

TWO-HAND COMPOUND SHEARS



- A two handed tool designed to cut straight, and to pass-through sheet metal
- For heavy industrial work, such as steel stock holders when cutting bundles of steel tubes
- Forged blades, made of specially hardened tool steel
- Blade angles sharpened for long and consistent performance
- Plastic coated handles of hardened steel tubes for added strength in cutting difficult-to-work materials
- Cutting capacity: Cold rolled steel
- Spare parts M6376-SH: Blades, screw and nut

	 731151		 L mm	 1 mm	 g
M6376	8196486	1	760	2.5	2400
M6376-SH	8199296	1	-	-	1000

M676

TWO-HAND COMPOUND SHEARS



- For heavy industrial work, such as steel stock holders when cutting bundles of steel tubes
- Forged blades, made of specially hardened tool steel
- Blade angles sharpened for long and consistent performance
- Plastic coated handles of hardened steel tubes for added strength in cutting difficult-to-work materials
- Cutting capacity: Cold rolled steel
- Spare parts M676-SH: Blades, screws and nuts

	 731151		 L mm	 1 mm	 g
M676	8161088	1	760	2.5	2100
M676-SH	8211875	1	-	-	790



M926

NIBBLER



- For cutting flat sheet, square or cylindrical tubing
- Snips off the waste curl when closing the handles and leave a clean, square cut
- Special protection to prevent curls flying into eyes
- Blades of special steel
- Strong handles with plastic sleeves for comfortable grip
- Small distance between handles allows for easy cutting
- Simple operational safety lever
- Cutting capacity: 1 - Stainless steel, 2 - Cold rolled steel
- Spare blades M926-SH

	 731151					
M926	8161071	1	250	0.8	1.2	500
M926-SH	0107537	1	-	-	-	23

2744

MULTIPURPOSE SNIP



- Light, strong, heavy duty universal snip
- For cutting light metal plate, leather, wire, plastic, wood etc
- Stamped, fully hardened steel blades
- Serrated blade to prevent material from sliding
- Comfortable handles made of composite material, equipped with a push button as locking mechanism
- Packaging: On informative card

	 731415			
2744	1809096	6	190	130



SCISSORS

SC127/SC127S

ELECTRICIAN SCISSORS



- Electrician scissors with plastic coated finger loops
- Small groove in the blade for stripping cables
- 45 mm cutting length
- Suffix S = serrated blade version

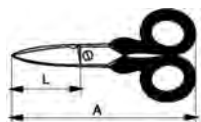

	 731415		L mm	A mm	 g
SC127	0121984	10	45	127	80
SC127S	0121991	10	45	127	80

SC140/SC140C

ELECTRICIAN SCISSORS



- Electrician scissors with plastic coated finger loops
- Small groove in the blade for stripping cables
- 48 mm cutting length

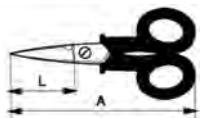

	 731415		L mm	A mm	 g
SC140	0122004	10	48	140	90
SC140C	0122011	10	48	140	90

SC150NG

ELECTRICIAN SCISSORS



- Electrician scissors with longer handles, plastic coated loops
- Requiring less cutting force
- Better access to confined spaces
- 38 mm cutting length

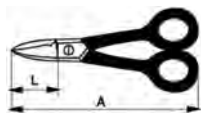

	 731415		L mm	A mm	 g
SC150NG	0122028	10	38	152	130



2702

SPECIAL TIN SCISSORS



- With short cutting jaws and big, handy finger loops
- Straight cutting jaws
- Cutting capacity: Sheet steel and steel wire up to 0.4 mm
- Finish: Nickel and chrome plated, fine-polished
- Material: High performance steel
- 2702A with one cutting edge serrated

	 731415		 L mm	 g
2702	1066932	1	110	45
2702A	1066949	1	110	45

2704

SPECIAL TIN SCISSORS



- Tin scissors with curved cutting jaws
- Finish: Nickel and chrome plated, fine-polished
- Material: High performance steel
- Cutting capacity for sheet steel and steel wire up to 0.4 mm
- 2704A with one cutting edge serrated

	 731415		 L mm	 g
2704	1066956	1	110	45
2704A	1066963	1	110	45

2707

SPECIAL TIN SCISSORS



- With pointed cutting edges, one cutting edge serrated
- For severing components and wires as well as for cutting twines in cable forming
- Finish: Nickel and chrome plated, fine-polished
- Material: High performance steel
- Cutting edge length 18 mm
- Cutting capacity: Copper wire 1 mm, sheet metal 0.4 mm

	 731415		 L mm	 g
2707	1066994	1	115	45

2705R

SPECIAL TIN SCISSORS



- For general applications and holding small components and wires
- With clamping mechanism, jaws finely serrated
- Finish: Nickel and chrome plated, fine-polished
- Material: Special steel, stainless

	 731415		 L mm	 g
2705R	1821470	1	160	40



SQZ150003



RETRACTABLE KNIVES

- Squeeze knife with quick change blade feature
- 6 spare blades stored in the handle

	 731415		 g
SQZ150003	3013477	6	35

2816



RETRACTABLE KNIVES

- Retractable utility knife
- The two handle sections are held together by a countersunk screw
- After loosening the screw, the blade can be adjusted or the spare blades can be taken from the inside of the handle sections
- Ideal for floor covering, rubber, cardboard, leather, wood etc
- Suspension hole and four standard blades in the handle
- *Fully extended blade

	 731415		 mm	 g
2816	1345501	1	* 160	67

2817



FIXED BLADE KNIVES

- Fixed blade knife
- The two handle sections are held together by a countersunk screw
- After loosening the screw, the blade can be adjusted or the spare blades can be taken from the inside of the handle sections
- Ideal for floor covering, rubber, cardboard, leather, wood etc

	 731415		 mm	 g
2817	1068776	1	140	75

SQZ150003-SBL

KNIFE BLADES



- Utility knife blades
- Safe plastic dispenser containing 12 blades

	 731415		 L mm	 g
SQZ150003-SBL	3015372	1	60	63

SQZ150003-HSBL

KNIFE BLADES



- Hooked utility knife blades
- Safe plastic dispenser containing 12 blades





	 731415		 L mm	 g
SQZ150003-HSBL	3015389	1	51	63

2817K

KNIFE BLADES



- Utility knife blades
- Packed in sets of 10 pcs
- 2817K = standard blade
- 2817KH = curved blade

	 731415		 L mm	 g
2817K	1068813	10	53.0	3
2817KH	1068820	10	50.5	3





2819

ELECTRICIAN'S KNIFE

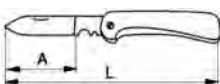

- Folding electrician's knife
- Extra large, strong stainless blade with black plastic handle



	 731415		L mm	A mm	 g
2819	1068844	5	200	110	80



KNIVES

2820EK

ELECTRICIAN'S KNIFE



- Electrician's knife with stainless steel blade and with plastic handle

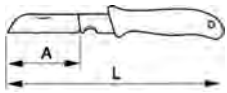

	 731415		L mm	A mm	 g
2820EK	0122035	10	200	70	50

2820EF1

ELECTRICIAN'S KNIFE



- Electrician's pocket folding knife
- Wire stripping shape with wooden handle



	 731415		L mm	A mm	 g
2820EF1	0122042	12	200	60	90

2820EF2

ELECTRICIAN'S KNIFE



- Electrician's pocket folding knife
- Stainless steel blade with plastic handle
- Wire stripping shape

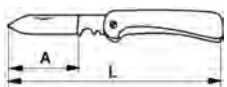

	 731415		L mm	A mm	 g
2820EF2	0122059	12	200	65	70

2820EF3

ELECTRICIAN'S KNIFE



- Pocket folding knife
- Special steel
- Plastic handle

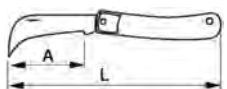

	 731415		L mm	A mm	 g
2820EF3	0122066	1	170	70	60

2820EF4

ELECTRICIAN'S KNIFE



- Electrician's pocket folding knife
- Double blade with plastic handle

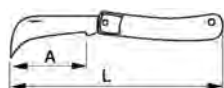

	 731415		L mm	A mm	 g
2820EF4	0122073	1	180	70/80	90

2444

TRADESMEN KNIVES



- Robust knife with a solid stainless steel blade for multipurpose use
- 2-component handle for comfort in use and a safe grip
- Overall product length 220 mm, blade length 102 mm
- Supplied with a practical sheath for belt carrying
- Available in a 15 pce counter display

	 731151		 g
2444	8286750	15	100

SB-2444

TRADESMEN KNIVES



- Robust knife with a solid stainless steel blade for multipurpose use
- 2-component handle for comfort in use and a safe grip
- Overall product length 220 mm, blade length 102 mm
- Supplied with a practical sheath for belt carrying
- Packaging: On a retail display card

	 731151		 g
SB-2444	0189250	1	100



MTT151



MULTITOOLS

- Heavy duty aluminium body
- Anodized finish in orange
- 18 versatile functions
- Rust resistant stainless steel blades
- Hard durable canvas storage pouch with belt loop

	 731151		 L mm	 g
MTT151	0120703	6	150	320

K-AP-1



TRADITION PRUNING KNIFE

- For all gardening work such as pruning, flower cutting and cutting of strings, plastics and paper material
- Very flat design to fit into the pocket
- Stainless steel, bow-shaped folding blade

	 731151		 L mm	 g
K-AP-1	8030117	10	180	90

K-GP-1



TRADITION PRUNING KNIFE

- For all gardening and pruning work such as flower cutting and cutting of twigs and young stems
- Very flat design to fit into the pocket
- Stainless steel, hook-shaped folding blade

	 731151		 L mm	 g
K-GP-1	8030131	10	170	90



DRILLS

Bahco provides a wide range of professional, high-quality drills for use in most applications, and in almost any conditions. The drill you use depends on the material you are working with. The following will help you select the right drill for the job.

Drills for wood

Flat drill bits

Both the short and long versions are ideal for fast, effective drilling in all grains, in soft and hardwood end-grained timber. The long model is suitable for the drilling of deep holes or when the access is too limited for a shorter flat bit.

Auger drill bits

Used to drill a splinter-free hole of high precision in all kinds of grained timber. The tip is formed like a self tapping screw to generate a pulling making drilling easier with less manual power required. Long auger bits are suitable when drilling deep holes or when the access is too limited for a short auger bit.

Twist drills/Centre point drill bits

Are recommended for drilling in solid wood, chip-boards and wooden fibre boards.

Expansive drill bits

Add an extra dimension to the drilling operation both for hand braces and power tools. They are suitable for drilling in solid wood, chip-board and wooden fibre board, but not in materials less than 9mm thick or in hardwood.

Extension shafts

lengthen short flat and auger bits .Only used with hand braces.

Masonry and HSS drills

Masonry drills

The tungsten carbide tip makes this drill suitable for rotary drilling in concrete, lightweight concrete, brick, stone, hollow block, ceramics, marble etc.

HSS drills

High Speed Steel drills are suitable for drilling holes in brass, bronze, carbon steel, cast iron, steel alloys and stainless steels.

Step drills

Designed for drilling thinner metal sheet, the Bahco step drills with their titanium-nitride surface last four to five times longer than ordinary step drills.

Chapter index

DRILLS FOR WOOD	1052-1055
MASONRY DRILLS	1056-1058
MASONRY DRILLS AND HSS DRILLS	1058
HSS DRILLS	1059-1061
STEP DRILLS	1061-1062



9529

FLAT BIT



- Flat bit drill for drilling in wood
- Flat bit with positive cutting angle for faster drilling than with conventional bits
- High-carbon steel, heat treated all over. Hardened blade forged directly from the round shaft
- Flat bit part and shaft are ground
- Shank size 6 mm
- Size range 6 to 40 mm
- Lacquered for rust protection

	 731151		A mm	B mm	 g
9529-6	8043308	10	6.0	156	50
9529-8	8045746	10	8.0	156	60
9529-10	8045753	10	10.0	156	66
9529-12	8045760	10	12.0	156	67
9529-13	8045777	10	13.0	156	68
9529-14	8045784	10	14.0	156	68
9529-16	8045791	10	16.0	156	70
9529-17	8045807	10	17.0	156	71
9529-18	8045814	10	18.0	156	72
9529-19	8045821	10	19.0	156	73
9529-20	8045838	10	20.0	156	73
9529-22	8046590	10	22.0	156	75
9529-24	8046606	10	24.0	156	75
9529-25	8046613	10	25.0	156	75
9529-26	8046620	10	26.0	156	75
9529-28	8046637	10	28.0	171	85
9529-30	8046644	10	30.0	171	86
9529-32	8046651	10	32.0	171	90
9529-35	8046668	10	35.0	171	90
9529-38	8046675	10	38.0	171	95
9529-40	8046682	10	40.0	171	95

9531

FLAT BIT, LONG

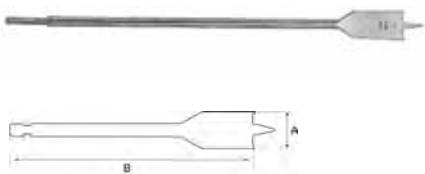

- Extra long flat bit drill for drilling in wood
- Flat bit with positive cutting angle for faster drilling than with conventional bits
- High-carbon steel, heat treated all over. Hardened blade forged directly from the round shaft
- Flat bit part and shaft are ground
- Shank size 6 mm
- Size range 6 to 38 mm with an overall length of 400 mm
- Lacquered for rust protection

	 731151		A mm	B mm	 g
9531-6-CA	8045371	10	6	400	105
9531-8-CA	8045388	10	8	400	140
9531-10-CA	8045395	10	10	400	158
9531-12-CA	8045401	10	12	400	160
9531-13-CA	8045418	10	13	400	160
9531-14-CA	8045425	10	14	400	162
9531-16-CA	8045432	10	16	400	190
9531-18-CA	8045449	10	18	400	192
9531-19-CA	8045456	10	19	400	193
9531-20-CA	8045463	10	20	400	195
9531-22-CA	8045470	10	22	400	260
9531-24-CA	8045487	10	24	400	265
9531-25-CA	8045494	10	25	400	265
9531-28-CA	8045500	10	28	400	270
9531-30-CA	8045517	10	30	400	270
9531-32-CA	8045524	10	32	400	270
9531-35-CA	8013035	10	35	400	275
9531-38-CA	8013042	10	38	400	280



9525

EXTENSION SHAFT



- 330 mm long extension shaft for auger bits of 14 to 32 mm diameter
- Two locking screws and one hexagonal key for fastening, supplied with each extension shaft
- Lacquered for rust protection

	 731151		 mm	 mm	
9525-7	8031800	1	14-19	330	220
9525-10	8031817	1	20-32	330	260

9526

AUGER BIT

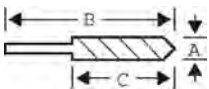

- Auger bit for drilling in wood
- One section of tang with hexagonal shank for firm grip in the chuck. Additional 15 mm long section with four flat sides, suitable for hand braces
- Spirals with Levin pattern
- Lacquered for rust protection
- Sizes 6 to 38 mm

	 731151		A mm	B mm	C mm	
9526-6	8011062	1	6.0	160	100	50
9526-7	8013271	1	7.0	170	100	60
9526-8	8011079	1	8.0	170	100	70
9526-10	8011086	1	10.0	190	120	80
9526-11	8011093	1	11.0	190	120	86
9526-12	8012588	1	12.0	190	120	100
9526-13	8011031	1	13.0	190	120	120
9526-14	8012595	1	14.0	200	130	125
9526-15	8012601	1	15.0	200	130	140
9526-16	8011109	1	16.0	200	130	150
9526-17	8012618	1	17.0	200	130	155
9526-18	8012625	1	18.0	200	130	140
9526-19	8011048	1	19.0	200	130	180
9526-20	8012632	1	20.0	210	140	220
9526-22	8011116	1	22.0	210	140	270
9526-24	8012649	1	24.0	210	140	310
9526-25	8011055	1	25.0	210	140	320
9526-26	8012656	1	26.0	210	140	340
9526-28	8101206	1	28.0	210	140	400
9526-30	8012670	1	30.0	210	140	430
9526-32	8011123	1	32.0	210	140	460
9526-35	8276409	1	35.0	210	140	530
9526-38	8276416	1	38.0	210	140	590





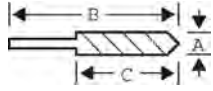

9527

AUGER BIT, LONG



- Extra long auger bit for drilling in wood
- One section of tang with hexagonal shank for firm grip in the chuck. Additional 15 mm long section with four flat sides, suitable for hand braces
- Spirals with Levin pattern
- Lacquered for rust protection
- Sizes 6 to 32 mm with 400 mm overall length



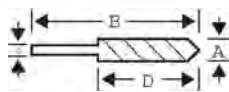

	 731151		A mm	B mm	C mm	 g
9527-6-CA	8045531	1	6.0	400	300	100
9527-8-CA	8045548	1	8.0	400	300	140
9527-10-CA	8045555	1	10.0	400	300	190
9527-12-CA	8045562	1	12.0	400	300	230
9527-13-CA	8045579	1	13.0	400	300	250
9527-14-CA	8045586	1	14.0	400	300	300
9527-16-CA	8045593	1	16.0	400	300	340
9527-18-CA	8045609	1	18.0	400	300	375
9527-19-CA	8045616	1	19.0	400	300	420
9527-20-CA	8045623	1	20.0	400	300	465
9527-22-CA	8045630	1	22.0	400	300	555
9527-24-CA	8045647	1	24.0	400	300	670
9527-25-CA	8045654	1	25.0	400	300	690
9527-26-CA	8045661	1	26.0	400	300	720
9527-28-CA	8045678	1	28.0	400	300	850
9527-32-CA	8045692	1	32.0	400	300	1030

460

TWIST DRILL



- Lip and Spur drill for drilling in solid wood, chipboard and wood fibre board
- Made of hardened and tempered chrome-vanadium
- Precision ground
- Size range 3 to 20 mm

	 731151		A mm	B mm	C mm	D mm	 g
460-3-CA	8006518	1	3.0	61	3.0	33	6
460-4-CA	8006525	1	4.0	75	4.0	43	9
460-5-CA	8006532	1	5.0	86	5.0	52	13
460-6-CA	8006549	1	6.0	93	6.0	57	40
460-7-CA	8006556	1	7.0	109	7.0	69	45
460-8-CA	8006563	1	8.0	117	8.0	75	55
460-9-CA	8018313	1	9.0	125	9.0	81	65
460-10-CA	8006570	1	10.0	133	10.0	87	75
460-11-CA	8018320	1	11.0	142	9.5	94	85
460-12-CA	8006587	1	12.0	151	9.5	101	115
460-13-CA	8018337	1	13.0	151	9.5	101	120
460-14-CA	8006594	1	14.0	160	9.5	108	140
460-15-CA	8018344	1	15.0	169	9.5	114	185
460-16-CA	8006600	1	16.0	178	9.5	120	210
460-18-CA	8018351	1	18.0	178	9.5	120	230
460-20-CA	8018368	1	20.0	178	9.5	120	265



460-PB

TWIST DRILL SET



460-PB-1



460-PB-2

- Lip and Spur drill for drilling in solid wood, chipboard and wood fibre board
- Made of hardened and tempered, chrome-vanadium steel
- Precision ground
- Set of five or eight drills respectively supplied in a plastic box

	 731151		 g
460-PB-1	8007058	1	145
460-PB-2	8007065	1	185

460-PB-1
4, 5, 6, 8, 10 mm



460-PB-2
3, 4, 5, 6, 7, 8, 9, 10 mm



9528

EXPANSIVE BIT

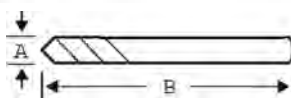

- The expansive bit makes it possible to drill a full range of diameter holes with the same bit
- Adjustable using a screwdriver or wrench
- Made of drop-forged tool steel in one piece, heat treated all over. Head and adjustable cutters hardened and tempered
- Locking screw zinc plated with hexagonal head with slot
- Sizes 15 to 45 mm & 22 to 76 mm, both with round shank

	 731151		A mm	B mm	 g
9528-MD-15-45	8007447	1	15-45	120	170
9528-MD-22-76	8041441	1	22-76	170	210



MASONRY DRILLS

463

MASONRY DRILL

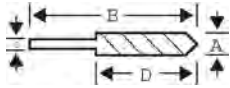

- Masonry drill for drilling in concrete, brick, stone, ceramic tiles and marble etc
- Shank of low-alloy, hardened tool steel. Zinc plated, with rolled flute up to 5 mm, and milled flute above 5 mm size
- Tungsten-carbide tip ensures high drilling capacity and long-life
- High resistance to wear and torsion stresses
- Size range 3 to 25 mm

	 731151		A mm	B mm	C mm	D mm	 g
463-3-60	8024819	1	3.0	60	3.6	39	9
463-3,5-60	8024826	1	3.5	60	3.6	39	9
463-4-75	8024833	1	4.0	75	3.6	47	9
463-4,5-85	8024840	1	4.5	85	4.0	47	12
463-5-85	8026547	1	5.0	85	4.0	47	12
463-5,5-85	8024857	1	5.5	85	4.6	47	13
463-6-100	8024864	1	6.0	100	5.1	58	35
463-6,5-100	8024871	1	6.5	100	5.3	58	40
463-7-100	8024888	1	7.0	100	5.6	58	40
463-8-120	8024895	1	8.0	120	6.3	75	40
463-9-120	8024901	1	9.0	120	7.2	75	60
463-10-120	8024918	1	10.0	120	8.0	75	70
463-11-150	8024925	1	11.0	150	9.52	90	80
463-12-150	8024932	1	12.0	150	9.52	90	80
463-13-150	8024949	1	13.0	150	9.52	90	95
463-14-150	8024956	1	14.0	150	9.52	90	120
463-15-150	8127381	1	15.0	150	9.52	90	125
463-16-150	8024963	1	16.0	150	9.52	90	130
463-18-160	8024970	1	18.0	160	12.7	100	190
463-20-160	8024987	1	20.0	160	12.7	100	210
463-22-160	8024994	1	22.0	160	12.7	100	310
463-25-160	8025007	1	25.0	160	12.7	100	320

464

MASONRY DRILL

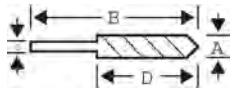

- Masonry drill for percussion drilling in concrete, brick, stone, ceramic tiles and marble etc
- Shank of low-alloy, hardened and tempered tool steel
- Black-oxidised surface with ground diameter
- Tungsten-carbide tip ensures high drilling capacity and long-life
- High resistance to wear and torsion stresses
- Size range 4 to 16 mm

	 731151		A mm	B mm	C mm	D mm	 g
464-4-75	8117368	10	4.0	75	4.0	39	10
464-5-85	8117382	1	5.0	85	5.0	39	13
464-5,5-85	8117375	1	5.5	85	5.5	39	15
464-6-100	8117412	1	6.0	100	6.0	54	20
464-6,5-100	8117399	1	6.5	100	6.5	54	20
464-7-100	8117429	1	7.0	100	7.0	54	24
464-8-120	8117436	1	8.0	120	8.0	80	40
464-9-120	8117443	1	9.0	120	9.0	80	45
464-10-120	8117269	1	10.0	120	10.0	80	57
464-12-150	8117283	1	12.0	150	10.0	90	100
464-14-150	8004354	1	14.0	150	10.0	90	110
464-16-150	8117306	1	16.0	150	10.0	90	153



463-L

MASONRY DRILL, LONG

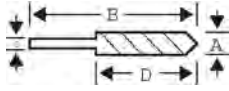

- Long masonry drill for percussion drilling in concrete, brick, stone, ceramic tiles and marble etc
- Shank of low-alloy, hardened and tempered tool steel
- Precision ground
- Tungsten-carbide tip ensures high drilling capacity and long-life
- High resistance to wear and torsion stresses
- Size range 6 to 20 mm

	 731151		A mm	B mm	C mm	D mm	 g
463-6-200	8025014	1	6.0	200	5.9	127	35
463-6,5-400	8025052	1	6.5	400	6.35	300	80
463-8-200	8025021	1	8.0	200	7.94	127	80
463-8-400	8025069	1	8.0	400	7.94	300	110
463-10-200	8025038	1	10.0	200	9.52	127	90
463-10-400	8025076	1	10.0	400	9.52	300	170
463-12-200	8025045	1	12.0	200	9.52	127	110
463-12-400	8025083	1	12.0	400	9.52	300	220
463-14-400	8025090	1	14.0	400	9.52	300	280
463-16-400	8025106	1	16.0	400	9.52	300	390
463-18-400	8025113	1	18.0	400	12.7	300	490
463-20-400	8025120	1	20.0	400	12.7	300	610

463-PB

SET



- Masonry drill set for percussion drilling in concrete, brick, stone, ceramic tiles and marble etc
- Shank of low-alloy, hardened and tempered tool steel
- Precision ground
- Tungsten-carbide tip ensures high drilling capacity and long-life
- High resistance to wear and torsion stresses

	 731151		 g
463-PB	8249281	1	132

463-PB
4, 5.5, 6, 8, 10 mm





MASONRY DRILLS

464-PB

SET



- Masonry drill set for percussion drilling in concrete, brick, stone, ceramic tiles and marble etc
- Shank of low-alloy, hardened and tempered tool steel
- Black finish surface with ground diameter
- Tungsten-carbide tip ensures high drilling capacity and long-life
- High resistance to wear and torsion stresses

464-PB-1	731151	1	g
8175436			

464-PB-1
4, 6, 8, 10 mm



MASONRY DRILLS AND HSS DRILLS

466

TWIST, MASONRY AND HSS DRILLS SET



- Assortment of drills, 3 twist drills, 3 masonry drills and 3 HSS drills, in diameters 5, 6 and 8 mm
- Made of hardened and tempered chrome-vanadium steel to DIN 338
- Supplied in a plastic cassette

466-COMBI	731151	1	g
8018306			

466-COMBI
441-5, 441-6, 441-8, 463-5, 463-6, 463-8, 460-5, 460-6, 460-8







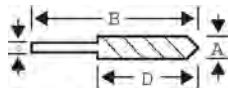

441

HSS DRILL



- High-speed steel drill for drilling in bronze, brass, carbon steel, cast iron, alloy steel and stainless steel
- Rolled flute
- Manufactured to DIN 338
- Size range 1 to 14 mm

	 731151		A mm	B mm	C mm	D mm	 g
441-1.0-CA	8031848	1	1.0	34	1.0	12	1
441-1.5-CA	8031855	1	1.5	40	1.5	18	1
441-2.0-CA	8031862	1	2.0	49	2.0	24	1
441-2.5-CA	8031879	1	2.5	57	2.5	30	2
441-3.0-CA	8031886	1	3.0	61	3.0	33	3
441-3.2-CA	8031893	1	3.2	65	3.2	36	3
441-3.3-P-CA	8130992	1	3.3	50	3.3	15	3
441-3.3-CA	8031909	1	3.3	65	3.3	36	3
441-3.5-CA	8031916	1	3.5	70	3.5	39	3
441-4.0-CA	8031923	1	4.0	75	4.0	43	4
441-4.1-P-CA	8131074	1	4.1	55	4.1	25	4
441-4.2-CA	8031930	1	4.2	75	4.2	43	6
441-4.5-CA	8031947	1	4.5	80	4.5	47	7
441-4.8-CA	8031954	1	4.8	86	4.8	52	9
441-5.0-CA	8031961	1	5.0	86	5.0	52	9
441-5.5-CA	8031978	1	5.5	93	5.5	57	11
441-6.0-CA	8031985	1	6.0	93	6.0	57	14
441-6.5-CA	8031992	1	6.5	101	6.5	63	18
441-6.8-CA	8121921	1	6.8	109	6.8	69	20
441-7.0-CA	8032005	1	7.0	109	7.0	69	22
441-7.5-CA	8032012	1	7.5	109	7.5	69	25
441-8.0-CA	8032029	1	8.0	117	8.0	76	30
441-8.5-CA	8032036	1	8.5	117	8.5	76	35
441-9.0-CA	8032043	1	9.0	125	9.0	81	40
441-9.5-CA	8032050	1	9.5	125	9.5	81	45
441-10.0-CA	8032067	1	10.0	133	10.0	87	50
441-10.5-CA	8032074	1	10.5	133	10.5	87	55
441-11.0-CA	8032081	1	11.0	142	11.0	94	68
441-11.5-CA	8032098	1	11.5	142	11.5	94	75
441-12.0-CA	8034429	1	12.0	151	12.0	101	84
441-12.5-CA	8032104	1	12.5	151	12.5	101	94
441-13.0-CA	8032111	1	13.0	151	13.0	101	98
441-14.0-CA	8046071	1	14.0	160	14.0	108	120



451

HSS DRILL

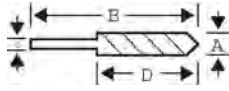

- High-speed steel drill for drilling in bronze, brass, carbon steel, cast iron, alloy steel and stainless steel
- Rolled flute
- Manufactured to DIN 338
- Size range 1 to 20 mm
- In boxes of 10, 5 or 2, depending on dimensions

	 731151		A mm	B mm	C mm	D mm	 g
451-1-10	8038281	10	1.0	34	1.0	12	1
451-1,5-10	8038335	10	1.5	40	1.5	18	1
451-2-10	8038380	10	2.0	49	2.0	24	1
451-2,5-10	8038434	10	2.5	57	2.5	30	2
451-3-10	8038489	10	3.0	61	3.0	33	3
451-3,2-10	8038502	10	3.2	65	3.2	36	3
451-3,5-10	8038533	10	3.5	70	3.5	39	4
451-3,8-10	8038564	10	3.8	75	3.8	43	4
451-4-10	8038588	10	4.0	75	4.0	43	6
451-4,2-10	8038601	10	4.2	75	4.2	43	6
451-4,5-10	8038632	10	4.5	80	4.5	47	7
451-4,8-10	8038663	10	4.8	86	4.8	52	9
451-5-10	8038687	10	5.0	86	5.0	52	9
451-5,5-10	8038731	10	5.5	93	5.5	57	11
451-6-10	8038786	10	6.0	93	6.0	57	14
451-6,5-10	8038830	10	6.5	101	6.5	63	18
451-7-10	8038885	10	7.0	109	7.0	69	20
451-7,5-10	8038939	10	7.5	109	7.5	69	22
451-8-10	8038984	10	8.0	117	8.0	76	30
451-8,5-10	8039035	10	8.5	117	8.5	76	35
451-9-10	8039080	10	9.0	125	9.0	81	40
451-9,5-10	8039134	10	9.5	125	9.5	81	45
451-10-10	8039189	10	10.0	133	10.0	87	50
451-10,2-10	8039196	10	10.2	133	10.2	87	52
451-10,5-5	8039202	5	10.5	133	10.5	87	55
451-11-5	8039226	5	11.0	142	11.0	94	68
451-11,5-5	8039240	5	11.5	142	11.5	94	75
451-12-5	8039264	5	12.0	151	12.0	101	84
451-12,5-5	8039288	5	12.5	151	12.5	101	94
451-13-5	8039301	5	13.0	151	13.0	101	98
451-13,5-5	8039325	5	13.5	160	12.5	108	100
451-14-5	8039349	5	14.0	160	12.5	108	120
451-16-2	8101015	2	16.0	178	12.5	120	158
451-18-2	8101022	2	18.0	191	12.5	130	248
451-20-2	8101039	2	20.0	205	12.5	140	285



451/

SETS



451-PB-1

451-MB-1

- High-speed steel drill for drilling in bronze, brass, carbon steel, cast iron, alloy steel and stainless steel
- Rolled flute
- Manufactured to DIN 338
- 451-PB-1 contains 6 drills from 2.0 to 8.0 mm x 1.0 mm (excl. 7.0 mm) in a plastic cassette
- 451-PB-2 contains 13 drills from 2.0 to 8.0 mm x 0.5 mm in a plastic cassette
- 451-MB-1 contains 13 drills from 1.0 to 7.0 mm x 0.5 mm in a metal case
- 451-MB-2 contains 19 drills from 1.0 to 10.0 mm x 0.5 mm in a metal case
- 451-MB-3 contains 25 drills from 1.0 to 13.0 mm x 0.5 mm in a metal case

	 731151		 g
451-PB-1	8007034	1	100
451-PB-2	8007041	1	150
451-MB-1	8026141	1	290
451-MB-2	8026158	1	785
451-MB-3	8026165	1	1420

451-PB-1 2, 3, 4, 5, 6, 8 mm x 1.0 mm	
451-PB-2 2, 2.5, 3, 3.5, 4, 4.5, 5, 5.5, 6, 6.5, 7, 7.5, 8 mm x 0.5 mm	
451-MB-1 1, 1.5, 2, 2.5, 3, 3.5, 4, 4.5, 5, 5.5, 6, 6.5, 7 mm x 0.5 mm	
451-MB-2 1, 1.5, 2, 2.5, 3, 3.5, 4, 4.5, 5, 5.5, 6, 6.5, 7, 7.5, 8, 8.5, 9, 9.5, 10 mm x 0.5 mm	
451-MB-3 1, 1.5, 2, 2.5, 3, 3.5, 4, 4.5, 5, 5.5, 6, 6.5, 7, 7.5, 8, 8.5, 9, 9.5, 10, 10.5, 11, 11.5, 12, 12.5, 13 mm x 0.5 mm	

STEP DRILLS



228-SD

STEP DRILL BIT

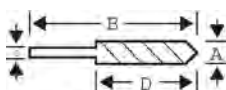

- For making holes in thin metal sheets
- Titanium-nitride coated step drill with a surface hardness that makes the tool last 4 to 5 times longer than ordinary step drill bits. That same surface reduces friction, resulting in a tool that runs cooler and, in effect, self-lubricates whilst running dry
- Drills holes from 4 to 12 mm in 1 mm increments
- Shank 1/4" (6 mm)

	 731151		A mm	B mm	C mm	D mm	 g
228-SD	8277048	24	4-12 / 1	76	1/4"	40	70



STEP DRILLS

229-SD

STEP DRILL BIT

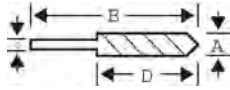

- For making holes in thin metal sheets
- Titanium-nitride coated step drill with a surface hardness that makes the tool last 4 to 5 times longer than ordinary step drill bits. That same surface reduces friction, resulting in a tool that runs cooler and, in effect, self-lubricates whilst running dry
- Drills holes from 4 to 22 mm in 2 mm increments
- Shank 3/8" (10 mm)

	 731151		A mm	B mm	C mm	D mm	 g
229-SD	8277055	24	4 - 22 / 2	76	1/4	40	70

230-SD

STEP DRILL BIT

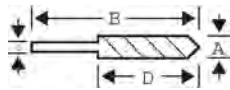

- For making holes in thin metal sheets
- Titanium-nitride coated step drill with a surface hardness that makes the tool last 4 to 5 times longer than ordinary step drill bits. That same surface reduces friction, resulting in a tool that runs cooler and, in effect, self-lubricates whilst running dry
- Drills holes in 13 steps from 5 to 35 mm
- Shank 1/2" (12.7 mm)

	 731151		A mm				B mm	C mm	D mm	 g									
230-SD	8280956	1	5	13	15	17	19	21	23	25	27	29	31	33	35	83	12.7	58	175

228-SET

STEP DRILL SET



- For making holes in thin metal sheets
- Titanium-nitride coated step drill with a surface hardness that makes the tool last 4 to 5 times longer than an ordinary step drill bit
- 3 piece HSS step drill set contents
 - 4 to 12 mm in 1 mm increments
 - 4 to 20 mm in 2 mm increments
 - 4 to 30 mm in 2 mm increments

	 731151		 g
228-SET	0120796	1	610



CLAMPING TOOLS

Bahco clamps – Made for Pressure

Whether you are making cabinets or furniture, completing interior work, flooring or metal works, holding or clamping frames or round pieces – you should always start with the right tool for the job.

Bahco offers a wide range of clamps for all work environments from powerful holding to quick fixing.

This product group includes the quick clamping range, the 420 standard clamp range, spring clamps, the roofing tool LathKo, and bench vices.

Chapter Index

CLAMPS	1068-1072
BENCH VICES	1073-1076



QUICK CLAMPS

QCS SERIES **Superior**™

The Superior range has been created for more demanding work where high-force tension, strength and durability are required. The Power Lever and the glass fibre reinforced polyamide body allow the

application of very strong pressure, suitable for use in tough environments. It provides easy and efficient high-force clamping to 300 mm.



QC-PAD REPLACEMENT SPARE PADS medium and soft



SPRING CLAMPS



QCB SERIES

A clamp created for everyday professional work where powerful clamping is required. The variable speed function makes achieving a high clamping force easier, as the clamp has to move a shorter distance to reach the work piece. It is simple to convert the QCB series into a spreader – just use the orange Spreader button to move the small clamping jaw. Clamping up to 1250 mm.



- Variable speed mechanism makes it easier to reach high clamping force
- Removable pads, with V-groove
- Easy to turn into a spreader with the Spreader button
- Easy access release mechanism
- Comfortable handle from all angles, upside down, front to back



Quick change spreader jaw
Ability to clamp or spread.



Variable Speed Trigger
Clamp moves easily until it makes contact with work piece, slowing down as it exerts pressure.



Flat base
Makes clamp stand flat on table without support pads.



Easy release button
Releases clamp easily, without needing extra force.



“V” groove Pads
Make it easier to grip odd shapes like pipes or corners.



Medium and Soft Pads
Changeable pads for different usage make clamping secure without leaving marks. Spare pads are available.



Power Lever
Only on Superior clamp for high pressure clamping.

QCG SERIES

This clamp has been developed for everyday clamping and is slightly smaller than the rest of the range. It is simple to convert the QCB series into a spreader – just use the orange Spreader button to move the small clamping jaw. Clamping up to 300 mm.



- Easy access in more confined spaces, as a result of the smaller body
- Easy to turn into a spreader with the Spreader button
- Easy access release mechanism
- Comfortable handle for use at any angle; upside down, front to back



CLAMPS

QCS

QUICK CLAMPS



- The Superior clamp has the speed of the Quick Clamp but the extra lever to give the maximum force of 300 kg
- Standard pads are medium

	 731151		 L mm	 g
QCS-150	0135998	6	150	900
QCS-300	0136001	6	300	1050

QCB

QUICK CLAMPS



- A wider range up to 1250 mm in length
- QCB clamp has a force of 200 kg
- Replaceable gripping pads with 2 different compounds, standard pads fitted are medium
- Variable speed trigger mechanism that increases power as the head makes contact with the workpiece
- Can also be used as a spreader

	 731151		 L mm	 g
QCB-150	0135912	6	150	935
QCB-300	0135936	6	300	1044
QCB-1250	0135981	8	1250	1746
QCB-450	0135950	6	450	1145
QCB-600	0135967	4	600	1260
QCB-900	0135974	4	900	1493

QCG

QUICK CLAMPS



- The QCG clamp is slightly smaller in size than the QCB and QCS meaning it is ideal for confined spaces or smaller hands
- Clamp up to 125 kg
- It can also be converted for spreading

	 731151		 L mm	 g
QCG-150	0135899	6	150	500
QCG-300	0135905	6	500	600

QC-PAD



QUICK CLAMPS

- Replaceable pads for the QCS and QCB, available in Soft -S and Medium -M
- Sold in packs of 2, Black - M and Grey - S

	 731151		
QC-PAD-M	0136025	10	60
QC-PAD-S	0136032	10	60





420

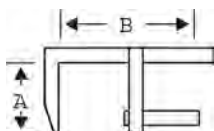

CLAMP

- Professional type F clamp with one fixed and one sliding bracket fitted to a galvanised profiled steel rail
- Zinc plated screw with special, plastic-covered ball-swivel foot for secure and easy clamping of odd shapes
- Tough and weather-resistant
- Square-shaped plastic grip



	 731151		A mm	B mm	
420-50-100	8011253	5	50	100	230
420-50-200	8011260	5	50	200	290
420-60-120	8043827	5	60	120	460
420-60-300	8043834	5	60	300	580
420-80-160	8011161	5	80	160	700
420-100-200	8011178	5	100	200	1100
420-120-250	8011185	5	120	250	1450
420-120-300	8011277	5	120	300	1600
420-120-400	8011284	1	120	400	1750
420-120-500	8011192	1	120	500	1950
420-120-600	8011215	1	120	600	2100
420-120-800	8011291	1	120	800	2400
420-120-1000	8127398	1	120	1000	2800
420-120-1250	8035235	1	120	1250	3230
420-120-1500	8035242	1	120	1500	3385
420-140-400	8043841	10	140	400	2390
420-175-400	8011222	1	175	400	2740



3064

CLAMP

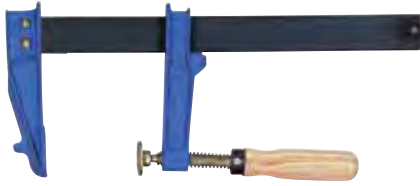

- Steel clamp
- Beach wood handle
- Non-slip braking mechanism

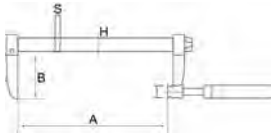

	 841334		A mm	B mm	H mm	S mm	 g
	5216890	5	300	120	35	8	2
	5098724	5	400	120	35	8	2.2
	5216975	5	500	120	35	8	2.4
	5098731	5	600	120	35	8	2.6
	5098748	5	800	120	35	8	3

3066

CLAMP

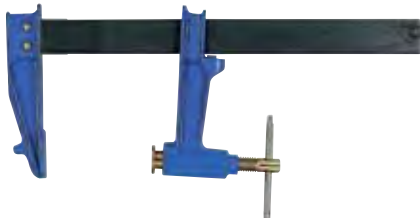

- Steel clamp
- Steel "T" handle
- Non-slip braking mechanism

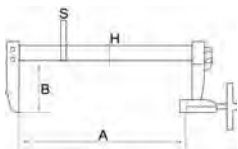

	 841334		A mm	B mm	H mm	S mm	 kg
	5098700	5	150	90	30	8	1.1
	5098717	5	200	90	30	8	1.2
	5217002	5	250	90	30	8	1.3
	5217033	5	300	90	30	8	1.4
	5217095	5	400	90	30	8	1.6

3067

CLAMP



- Steel clamp
- Steel "T" handle
- Non-slip braking mechanism

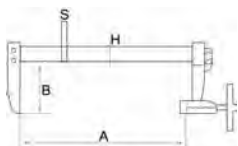

	 841334		A mm	B mm	H mm	S mm	 kg
	5123303	5	250	120	35	8	1.9
	5217194	5	300	120	35	8	2.0
	5123310	5	350	120	35	8	2.1
	5098755	5	400	120	35	8	2.2
	5098762	5	500	120	35	8	2.4
	5098779	5	600	120	35	8	2.6
	5123327	1	700	120	35	8	2.8
	5098786	5	800	120	35	8	3.0
	5098793	5	1000	120	35	8	3.4
	5123334	2	1200	120	35	8	3.8
	5123341	2	1500	120	35	8	4.4



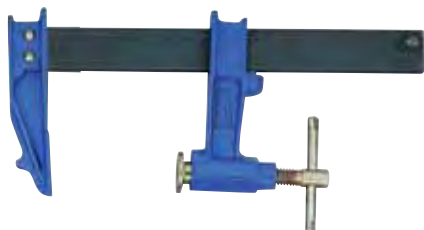

3068

CLAMP

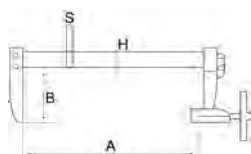

- Steel clamp
- Steel "T" handle
- Non-slip braking mechanism



	 841334		A mm	B mm	H mm	S mm	
306803000	5098809	5	300	150	40	10	3.2
306803500	5123365	5	350	150	40	10	3.1
306804000	5098816	5	400	150	40	10	3.4
306805000	5098823	2	500	150	40	10	3.7
306806000	5098830	2	600	150	40	10	4.0
306807000	5123372	2	700	150	40	10	4.3
306808000	5098847	2	800	150	40	10	4.6
306809000	5123389	2	900	150	40	10	4.9
306810000	5098854	2	1000	150	40	10	5.2
306812000	5098861	2	1200	150	40	10	5.8
306815000	5098878	1	1500	150	40	10	6.7
306820000	5098885	1	2000	150	40	10	8.2





3069

CLAMP

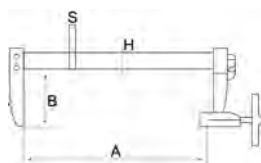

- Steel clamp
- Steel "T" handle
- Non-slip braking mechanism





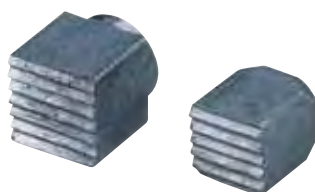

	 841334		A mm	B mm	H mm	S mm	
306903000	5123402	2	300	220	40	10	3.5
306904000	5123419	2	400	220	40	10	3.8
306905000	5123426	2	500	220	40	10	4.1
306906000	5123433	2	600	220	40	10	4.7
306907000	5123440	2	700	220	40	10	5.0
306908000	5123457	2	800	220	40	10	5.7
306910000	5123471	2	1000	220	40	10	6.0

3079

CLAMP



- Square brake for clamps
- 307900010 for 3064 and 3067 model
- 307900020 for 3068 and 3069 model

	 841334			
307900010	5126038	1	10x12	5
307900020	5126045	1	12x14.5	13



420SC



CLAMP

- Handy spring clamps with a movable gripping surface for odd shapes
- Available in 25 mm and 50 mm opening

	 731151		 g
420SC-25	0169825	10	60
420SC-50	0169832	5	130

GC600



GRAVITY CLAMP

- Portable clamping device for work pieces of various sizes, can also be used as a small step ladder
- The clamp secures work pieces of various sizes using the gravity leverage principle
- The lightweight aluminium clamp is hinged and has 2 wheels for easy storage and transportation
- When a work piece is placed in the jaw the wheels will start to roll away to the side. This movement works at the same time to close the jaws, firmly fixating the work piece. To add even more fixation, it is possible to put one foot on the lowest step, applying pressure
- Fitted with 2 steps the clamp can be used as a small stepladder

	 731151		 mm	 g
GC600	8298579	1	690x210x625	11600

450-80/450-130



ROOFING CLAMP

- The lath ko helps the roofer to get the laths in the right position on the roof
- Can be adjusted for different thicknesses of the laths and for different distances between the laths
- Made of aluminium with the handle PVC coated
- Plastic adjustment knobs grooved for easy operation

	 731151		A mm	B mm	C mm	D mm	E mm	 g
450-130	0165186	8	720	60	100	25-130	220-605	775
450-80	8298531	6	473	40	50	25-80	220-455	469



834V

BENCH VICES



- Heavy duty square guide bench vice
- Manufactured in high grade cast steel
- Interchangeable jaws
- Oversized anvil
- Laminated spindle thread for smooth operation

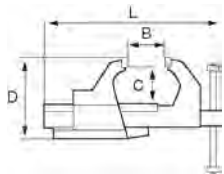

	 731415		 mm	B mm	C mm	D mm	L mm	 g
834V-4	8286811	1	100	125	66	122	325	5500
834V-5	8286828	1	125	150	80	152	402	12400
834V-6	8286835	1	150	200	98	182	492	19000
834V-7	8286842	1	175	235	118	211	551	29400

6072

BENCH VICES



- Heavy duty square guide bench vice
- Manufactured from high grade cast steel
- Interchangeable jaws
- Oversized anvil
- Laminated spindle thread for smooth operation
- Can be used with swivel base 833SB
- Spare jaws and spindle 6072M, 6010M and 6070H

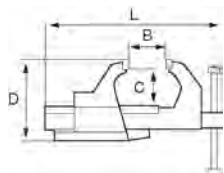

	 841334		 mm	B mm	C mm	D mm	L mm	 g
607201000	5030533	1	100	125	66	122	325	6150
607201250	5030540	1	125	150	80	152	402	12360
607201500	5030557	1	150	200	98	182	492	20200
607201750	5030564	1	175	235	118	211	551	30350

6010

BENCH VICES



- Round guide bench vice
- Material: High grade cast steel
- Heavy duty. Interchangeable jaws
- Oversized anvil. Laminated spindle thread
- Smooth operation
- Can be used with swivel base 833B
- Spare jaws and spindle 6010M and 6010H

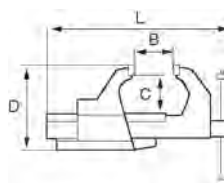

	 841334		 mm	B mm	C mm	D mm	L mm	 g
601000800	5202299	1	80	130	42	80	260	6050
601001000	5202305	1	100	166	56	100	320	11350
601001250	5202312	1	125	196	72	125	375	18200
601001500	5202329	1	150	229	80	150	430	29700



834V-2

BENCH VICES



- Round guide table vice
- Material: High grade cast steel
- Interchangeable jaws. Swivel base
- It can be easily fixed to a table

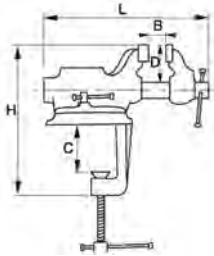

	 731415		 mm	B mm	C mm	D mm	H mm	L mm	 g
834V-2	0124992	1	63	63	75	47	225	210	4500

833SB

SWIVEL BASES



- Swivel base for 834V-4 to 834V-7 vices
- Manufactured from high grade cast steel

	 731415		 mm	 g
833SB-4	8286859	1	100	850
833SB-5	8286866	1	125	1150
833SB-6	8286873	1	150	1500
833SB-7	8286880	1	175	2500

833P

PIPE JAWS SET



- Pipe jaws for Bahco 834V-4 to 834V-7 vices

	 731415		 mm	 mm	 g
833PJ-4	8286897	1	100	13.5 - 26.9	250
833PJ-5	8286903	1	125	21.3 - 76.1	440
833PJ-67	8286910	1	125 / 150	26.9 - 89.0	480

6072M
SPARES FOR WORK BENCHES

- Pair of spare jaws and screws for vice 6072



	 841334		 mm	 g
6072M1000	5015813	1	100	350
6010M1250	5015820	1	125	450
6072M1500	5137454	1	150	750
6072M1750	5030687	1	175	1020

6070H
SPARES FOR WORK BENCHES

- Spare spindle and nut for vices 6072



	 841334		 mm	 g
6070H1000	5030656	1	100	470
6070H1250	5084833	1	125	820
6070H1500	5030663	1	150	1230
6070H1750	5030670	1	175	2060

6010M
SPARES FOR WORK BENCHES

- Pair of spare jaws and screws for vice 6010



	 841334		 mm	 g
6010M0800	5015806	1	80	170
6010M1000	5116619	1	100	350
6010M1250	5015820	1	125	450
6010M1500	5015837	1	150	750

6010H
SPARES FOR WORK BENCHES

- Spare spindle and bolt for vice 6010



	 841334		 mm	 g
6010H0800	5015769	1	80	470
6010H1000	5015776	1	100	820
6010H1250	5015783	1	125	1230
6010H1500	5015790	1	150	750



6040M/H

SPARES FOR WORK BENCHES



- Spare jaws and spindle for table vice 834V-2
- 6040M jaws
- 6040H spindle

	 841334		 mm	 g
6040M0630	5124126	1	63	150
6040H0630	5124119	1	63	400

833AJ

JAWS FOR DELICATE WORK - ALUMINIUM



- Includes built-in power magnet to fix the jaw in a steel vice
- Aluminium jaws

	 731415		 mm	 g
833AJ-4	8286927	1	100	180
833AJ-5	8286934	1	125	200
833AJ-6	8286941	1	150	220

833FJ

JAWS FOR DELICATE WORK - FIBRE



- Includes built-in power magnet to fix the jaw in a steel vice
- Fibre jaws

	 731415		 mm	 g
833FJ-4	8286965	1	100	150
833FJ-5	8286972	1	125	180
833FJ-6	8286989	1	150	200



BAHCO

STRIKING TOOLS

Bahco has over 125 years' experience of forging, and a solid reputation as a high-quality tool manufacturer. Bahco axes, mauls, hammers, cold chisels and punches all meet the high standards that are essential requirements for all applications - where quality, safety, durability and ease of use are key factors.

Safety first.

In this chapter we also highlight the safety rules that should be followed by the users of our striking tools.



Chapter Index

WOODWORKING AND CONSTRUCTION HAMMERS	1082-1084
METAL WORKING AND INDUSTRIAL HAMMERS	1084-1086
INSTRUMENT AND WORKSHOP HAMMERS	1086-1090
AXES, MAULS AND WEDGES	1091-1097
COLD CHISELS	1098-1101
PUNCHES	1102-1108
SETS	1108
WRECKING BARS	1109
MASONS'S PIN	1109



ICON INDEX



Camping

- Camping axes are lightweight axes with a short handle, making them easy to carry around. Also suitable for indoor use e.g. as a kitchen axe
- Head weight: 0.6 kg / 1 1/4 lb to 1 kg / 2 1/4 lb
- Length: 36-50 cm / 14 1/4" - 19 3/4"



Splitting

- Splitting axes have a thick head, specially made for splitting wood. The shape of the head helps to penetrate the wood with little effort. Some are made with a longer head back, for use with a splitting wedge
- Head weight: 2 kg / 4 1/2 lb to 3.5 kg / 7 3/4 lb
- Length: 80-90 cm / 31 1/2" - 35 1/2"



Felling

- Felling axes are heavier, with long handles and a thinner edge, for easy cutting when felling trees
- Head weight: 1.1 kg / 2 1/2 lb to 2.3 kg / 5 lb
- Length: 70-90 cm / 27 1/2" - 35 1/2"



Splitting with wedges

- Mauls are heavy sledge hammers that can be used to drive poles into the ground or splitting wedges into logs
- Head weight: 3 kg / 6 1/2 lb to 4 kg / 8 3/4 lb
- Length: 90 cm / 35 1/2"



Trimming branches and felling

- Hatchets are longer axes for trimming trees and other general purpose work
- Head weight: 1 kg / 2 1/4 lb
- Length: 60-70 cm / 23 1/2" - 27 1/2"

AXES, MAULS AND WEDGES

All axes are supplied with either a leather or rubber edge protector to ensure that the finish of the blade is maintained.

Pulling and breaking tests are performed by VPA Remscheid, an official test institution in Germany. The axes are marked 'GS: Approved Safety'.

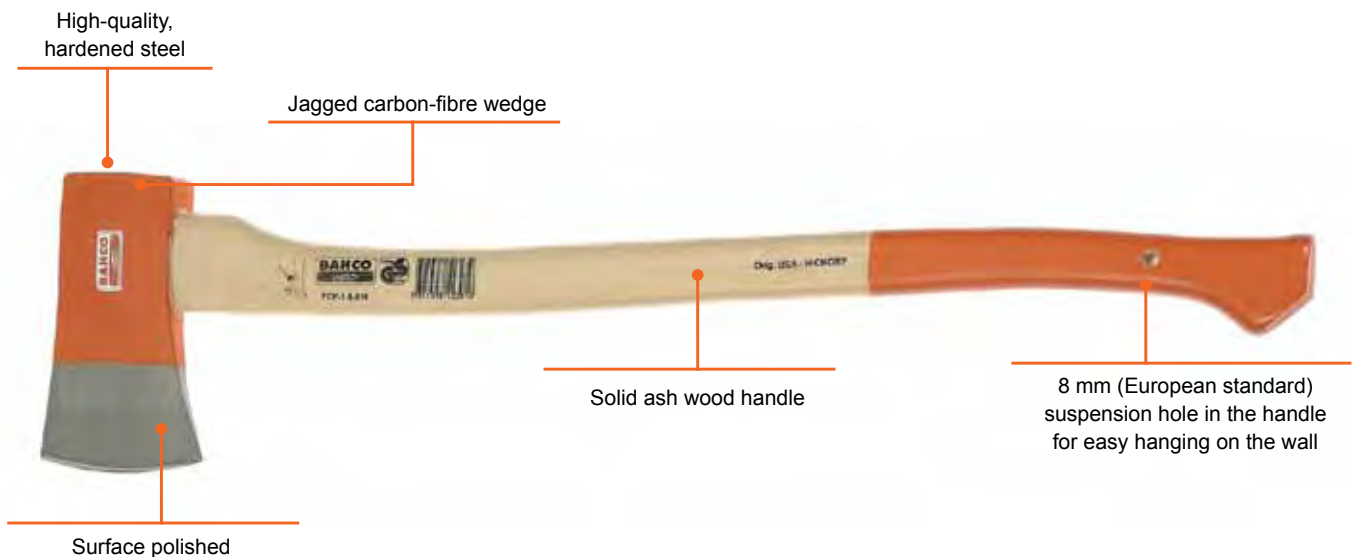

AXE SAFETY AND CARE

DO NOT use the axes on the side of the trunk where you are standing as there is a risk of slipping and hurting yourself.



Keep the trunk between you and the branches you intend to remove. Always cut branches from the root towards the top.

DO NOT stand erect when splitting wood. It could lead to severe injury if you miss your target.



Bend your knees slightly to make sure the axe hits the ground if you should accidentally slip.

DO NOT twist the axe sideways if it gets stuck, as this could break or loosen the handle.



Work the axe loose by moving it up and down.

DO NOT try to force splitting wedges into the wood with a normal axe. This could deform the eye, loosen the handle or even break the head.



Use a maul or a sledge hammer, which are both designed for wood splitting.

DO NOT use a maul as a wedge. The head of the maul may become deformed or break.



Use a special splitting wedge for this task.

DO NOT store axes or mauls in a dry place. Under very low air humidity like in heated rooms the handle could shrink and may no longer fit perfectly into the eye.



Storage in an unheated shed, barn or garage is recommended.

HAMMER SAFETY AND CARE

Never strike with the side of your hammer.



Never use a hammer with loose or cracked handle.

Never strike one hammer with another.



Wear safety goggles when using striking tools.

Never use a hammer with cracked face, claw or eye section.





427

CLAW HAMMER

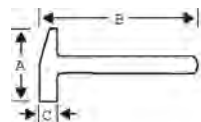

- Claw hammer with first class genuine hickory handle
- Octagonal neck and round head
- Bright polished
- Handle shaped for optimal grip with anti-slip surface and securely fixed with wedges

	 731151		A mm	B mm	C mm	 g	 g
427-16	8025410	4	130	350	28	450	680
427-20	8025427	4	140	365	30	570	760

428

CLAW HAMMER

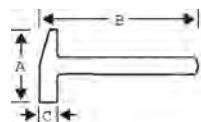

- Claw hammer with fiberglass handle for maximum shock absorption
- Octagonal neck and round head
- Bright polished
- Comfortable black hand grip
- Bright orange colour to make it easier to find

	 731151		A mm	B mm	C mm	 g	 g
428-13	8012243	4	120	315	26	370	580
428-16	8012380	4	130	330	28	450	800
428-20	8012397	4	140	350	30	570	880

429

CLAW HAMMER

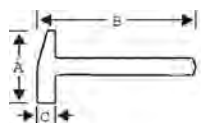

- Claw hammer with tubular manganese steel shaft
- Octagonal neck and round head
- Bright polished
- Comfortable black handle grip

	 731151		A mm	B mm	C mm	 g	 g
429-8	8040703	4	100	255	22	230	400
429-13	8012250	4	120	308	26	370	570
429-16	8012403	4	130	320	28	450	750
429-20	8012410	4	140	345	30	570	850



485

CARPENTER'S HAMMER



- Carpenter's hammer with anti-slip striking face and magnetic nail holder
- Tubular steel shaft with comfortable grip
- DIN 7239, GS certification

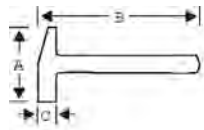

	 731151		A mm	B mm	C mm	 g	 g
485	8005153	4	170	308	26	600	925

480

WARRINGTON HAMMER



- Warrington hammer
- Traditional English joiner's hammer with cross pein
- Handle of first class genuine hickory, straight grained, without knots

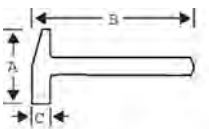

	 731151		A mm	B mm	C mm	 g	 g
480-08	8025496	4	110	305	24	230	400
480-10	8025502	4	120	305	26	280	440
480-12	8025519	4	120	305	28	340	520
480-14	8025526	4	120	305	30	400	540

483

JOINERS HAMMER



- French pattern, joiner's hammer
- Handle of first class genuine ash, straight grained, without knots
- DIN 5109, GS certification

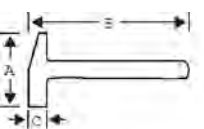

	 731151		A mm	B mm	C mm	 g	 g
483-16	8024314	4	80	265	16	100	140
483-20	8024321	4	90	265	20	160	240
483-22	8005108	4	98	265	22	200	291
483-25	8005115	4	107	305	25	300	399
483-28	8024284	4	115	305	28	400	487
483-30	8024291	4	120	305	30	500	595



WOODWORKING AND CONSTRUCTION HAMMERS

38

NAIL PULLER

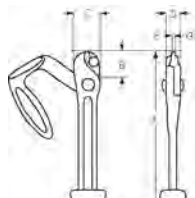

- Comfortable handle of malleable cast iron, other parts forged, specially hardened jaws
- A handy tool for opening wooden crates, or other easily and fast
- Black phosphated, anti-corrosion finish

	 731415		A mm	B mm	C mm	D mm	F mm	G mm	 g
38	0021734	1	450	23	36	18	4.5	4.5	2300



METAL WORKING AND INDUSTRIAL HAMMERS

484

CLUB HAMMER

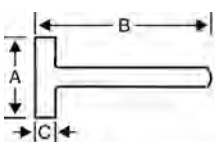

- Club hammer with convex (domed) striking faces
- Handle of first class genuine hickory, straight grained, without knots
- DIN 6475, GS certification

	 731151		A mm	B mm	C mm	 g	 g
484-1000	8005122	4	93	260	40	1000	1080
484-1250	8005139	4	107	260	42	1250	1330
484-1500	8005146	4	107	260	45	1500	1600
484-2000	8024338	2	115	310	50	2000	2100

486

BRICKLAYER'S HAMMER

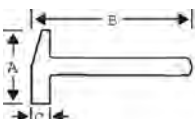

- Bricklayer's hammer with anti-slip striking face and nail puller
- Tubular steel shaft with comfortable grip

	 731151		A mm	B mm	C mm	 g	 g
486	8005160	4	206	282	25.5	600	878



494

HATCHET



- Plasterer's hatchet with anti-slip striking face and nail puller
- Tubular steel shaft with comfortable grip
- GS certification

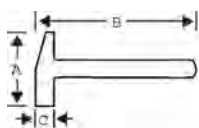

	 731151		A mm	B mm	C mm	 g
494-600	8025397	4	179	315	69	847

3625PU

DEAD BLOW



- Soft grip handle with ribbed, textured grip that prevents hand slippage
- Composite handle shank improves balance while defusing shock and dampening vibration
- Compact head design concentrates power delivery
- Internal canister features a free-flowing steel shot design which improves dead blow action while reducing rebound
- Hammer material is non-sparking and resistant to most shop chemicals



	 731151		A mm	B mm	C mm	 g	 g
3625PU-30	8276119	12	82	300	30	450	550
3625PU-50	8276126	6	107	340	50	900	1050
3625PU-60	8276133	6	138	400	60	1500	1700

3625PU-105

DEAD BLOW



- Steel structure and PU (polyurethane) layer hammers
- Anti-sliding handle
- The striking area will not be marked
- Ideal for tyre change, transmission works, etc.



	 731415		A mm	B mm	C mm	 g
3625PU-105	0170098	1	195	910	105	5970



METAL WORKING AND INDUSTRIAL HAMMERS

489

DEAD BLOW



- Sledge hammer with convex (domed) striking face
- Special heat treated head with a soft striking face and with a hard core
- The soft striking face avoids fractures or chipping and the hard core safeguards the head to the handle
- The unbreakable handle is made of rubber reinforced with a high carbon steel spring rod
- ANSI/HTI B173-1991, ASTM A576 (head), ASTM A421 (handle)

	 731415		A mm	B mm	C mm	 g	 g
489-1100	0133055	1	94	294	45	1100	1820
489-1800	0133062	1	116	300	49	1800	2720
489-2700	0133079	1	151	752	53	2700	4540
489-3600	0133086	1	167	788	59	3600	5900
489-4500	0133093	1	178	797	68	4500	6800
489-5400	0133109	1	192	795	66	5400	7700



INSTRUMENT AND WORKSHOP HAMMERS

481

GERMAN DIN HAMMER



- German DIN Locksmith's hammer for use on metal
- Handle of first class genuine ash, straight grained, without knots
- DIN 1041
- GS certification

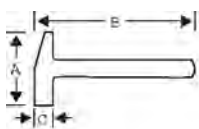

	 731151		A mm	B mm	C mm	 g	 g
481-100	8005030	4	82	260	15	100	160
481-200	8005047	4	95	260	19	200	260
481-300	8005054	4	105	300	23	300	420
481-400	8005061	4	112	300	25	400	520
481-500	8005078	4	118	300	27	500	620
481-800	8025540	4	130	350	29	800	980
481-1000	8005092	4	135	350	36	1000	1180
481-1500	8025533	2	145	385	42	1500	1700



482

RIVOIR HAMMER

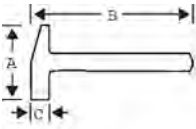

- Rivoir type hammer, French pattern, for use on metal
- Handle of first class genuine ash, straight grained, without knots

	 731151		A mm	B mm	C mm	 g	 g
482-25	8025557	4	85	305	25	250	340
482-28	8025564	4	90	305	28	315	460
482-30	8025571	4	95	305	30	400	520
482-35	8025595	4	105	305	35	630	700
482-40	8025601	4	110	325	40	800	980
482-45	8027551	2	120	355	45	1150	1300

479

BALL PEIN HAMMER

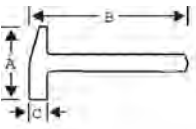

- Ball pein hammer for use on cold chisels, punches, rivets and shaping metal but can also be used as a general purpose hammer
- Handle of first class genuine hickory, straight grained, without knots

	 731151		A mm	B mm	C mm	 g	 g
479-08	8025441	4	80	305	22	230	290
479-12	8025458	4	93	330	27	340	448
479-16	8025465	4	101	330	30	450	554
479-24	8025472	4	115	390	38	800	960
479-32	8025489	4	128	390	42	900	1050

490

CROSS PEIN PIN HAMMER

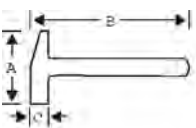

- Pattern makers' hammer with cross pein pin for use on metal
- First class genuine hickory handle, straight grained, without knots

	 731151		A mm	B mm	C mm	 g	 g
490-3.5	8025373	4	100	325	14	100	180



492

PATTERN MAKERS HAMMER

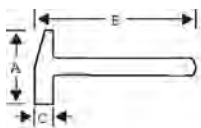

- Pattern makers' hammer with ball pein for use on metal
- First class genuine hickory handle, straight grained, without knots

			A mm	B mm	C mm	
492-3.5	8025380	4	85	325	16	180

3625Y

POLYFLEX PLASTIC HAMMER



- For heavy-duty work in assembly, dismantling and shaping of plates, etc.
- Yellow plastic polls made of polyurethane elastomer (Desmopan® is a registered trade mark of Bayer AG), centre piece made of malleable cast iron
- Wooden handle
- Extremely wear resistant with high break and tear resistance
- No splintering on sharp edges
- Hard finish, superior to that of conventional nylon hammers
- Resistant to virtually all mineral oils, greases and solvents
- **3625YL** = Spare polls, pair

			A mm	B mm	C mm	
3625Y-22	1074074	1	80	260	22	153
3625Y-27	1074081	1	90	280	27	235
3625Y-32	1074098	1	100	300	32	333
3625Y-35	1074104	1	106	320	35	425
3625Y-40	1074111	1	112	340	40	560
3625Y-50	1074128	1	120	360	50	885
3625Y-60	1074135	1	125	380	60	1285
3625YL-22	1074159	1			22	16
3625YL-27	1074166	1			27	28
3625YL-32	1074173	1			32	47
3625YL-35	1074180	1			35	59
3625YL-40	1074197	1			40	82
3625YL-50	1074203	1			50	144
3625YL-60	1074210	1			60	210



3625N

SUPERFLEX PLASTIC HAMMER



- For ordinary workshop use on pressure-sensitive materials
- Blue plastic polls made of cellulose butyrate (Cellidor™ - Bayer AG), centre piece made of malleable cast iron
- Wooden handle
- A hammer that replaces all similar hammers of copper, lead, brass, rubber or wood
- High impact strength. Resistant to low-octane fuels, oil and grease
- Two cambered faces
- 3625NL = Spare polls with cambered face, pair

	 731415		A mm	B mm	C mm	 g
3625N-22	1073602	5	80	260	22	154
3625N-27	1073626	5	90	280	27	230
3625N-32	1073640	5	100	300	32	325
3625N-35	1073664	5	106	320	35	415
3625N-40	1073688	5	112	340	40	570
3625N-50	1073701	1	120	360	50	920
3625N-60	1073718	1	125	380	60	1280
3625NL-22	1073831	1			22	16
3625NL-27	1073848	1			27	28
3625NL-32	1073855	1			32	47
3625NL-35	1073862	1			35	59
3625NL-40	1073879	1			40	82
3625NL-50	1073886	1			50	144
3625NL-60	1073893	1			60	210

487

NON SPARKING HAMMER



- Finish: Polished
- Material: Aluminium, bronze
- Non-sparking and anti-magnetic
- Standard No: II B

	 731151		A mm	B mm	C mm	 g	 g
487-650	0133116	1	93	310	30	450	610
487-1300	0133123	1	112	400	40	1000	1300
487-1800	0133130	1	132	400	44	1500	1800
487-2300	0133147	1	137	400	50	2000	2300
487-5200	0133154	1	176	900	63	4000	4900
487-5900	0133161	1	189	900	66	5000	5900



3625RM

RUBBER MALLET



- Rubber mallet
- Wooden handle

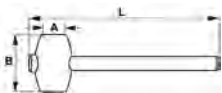

	 731415		A mm	B mm	L mm	 g
3625RM-55	0120758	6	55	90	320	250
3625RM-65	0120765	6	65	115	340	440
3625RM-75	3019820	6	75	125	360	600
3625RM-90	0120390	6	90	139	360	720

3625W

NYLON TIP MALLET



- Nylon tip mallet
- Wooden handle

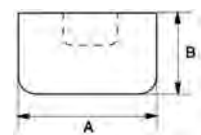
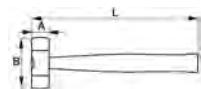

	 731415		A mm	B mm	L mm	 g
3625W-22	0120406	6	22	60	150	150
3625W-28	0120413	6	28	80	275	300
3625W-35	0120420	1	35	100	300	550
3625W-44	0120437	6	44	120	360	1050
3625W-55	0120444	6	55	140	400	1100
3625WL-22	0120451	10	22	12		10
3625WL-28	0120468	10	28	19		15
3625WL-35	0120475	10	35	22		20
3625WL-44	0120482	1	44	27		50
3625WL-55	0120499	1	55	32		80

3625S

NYLON TIP MALLET



- Nylon tip mallet
- Steel shaft with a rubber grip
- Use 3625WL for spare tips



	 731415		A mm	B mm	C mm	 g
3625S-28	0183906	6	80	255	28	325
3625S-35	0183913	6	100	285	35	630
3625S-44	0183920	6	125	300	44	1150



HUS

CAMPING AXES



HUS-0.7-500SG



HUS-0.8-500



- For general purpose applications such as camping or gardening work and occasional branch trimming
- High-quality tool steel according to DIN 7287, class B
- Curved ash wood handle, according to DIN 5132, form B
- Handle secured by a jagged carbon-fibre wedge equipped with a euro suspension hole
- Additional 8 mm (European standard) suspension hole in the handle for easy storage
- Also available with fully polished axe head for an easier cut and a non-slip soft grip for comfort

	 731151			
HUS-0.6-380	8123659	4	380	850
HUS-0.7-500SG	8281229	4	500	1030
HUS-0.8-500	8123666	4	500	1150

HGPS

CAMPING AXES



- For occasional use by home owners, very much an all-round general purpose axe
- Thin wide blade for a clean cut
- Curved ash wood handle, secured by a jagged carbon-fibre wedge
- Equipped with a euro hole in addition to an 8 mm (European standard) suspension hole in the handle for easy storage

	 731151			
HGPS-0.6-360	8123680	4	360	800
HGPS-0.8-380	8123697	4	380	1000
HGPS-1.0-400	8123703	4	400	1250

HFGPS

CAMPING AXES



- Short general purpose axe for lighter applications
- Backside of the axe head can also be used as hammer
- Straight 3-component handle with non-slip grip (polypropylene handle with elastomer grip and fibreglass core) for comfort

	 731151			
HFGPS-0,7-400FG	8275877	4	380	1070



AXES, MAULS AND WEDGES

HUS



HUS-1.0-650



HUS-1.0-650SG



HATCHETS

- For branch trimming and general purpose gardening work
- High-quality tool steel according to DIN 7287, class B
- Curved ash wood handle, according to DIN 5132, form B, secured by a jagged carbon-fibre wedge equipped with a euro suspension hole
- Additional 8 mm (European standard) suspension hole in the handle for easy storage
- Also available with fully polished axe head for an easier cut and a non-slip soft grip for more comfort

	 731151		 mm	 g
HUS-1.0-650	8123673	4	650	1400
HUS-1.0-650SG	8281236	4	650	1350

FGS



HATCHETS

- For branch trimming and felling small trees
- Slightly wider at the eye, the thin, wide blade ensures a clean and easy cut into the branch
- High-quality tool steel according to DIN 17200, carbon 45
- Curved ash wood handle, secured by a jagged carbon-fibre wedge equipped with a euro suspension hole for easy storage
- Additional 8 mm (European standard) suspension hole in the handle for easy storage

	 731151		 mm	 g
FGS-1.0-600	8123796	4	600	1500
FGS-1.25-700	8123802	4	700	1800

FGS



FELLING AXES

- For felling trees and branch trimming
- Slightly wider at the eye, the thin, wide blade ensures a clean and easy cut into the branch
- High-quality tool steel according to DIN 17200, carbon 45
- Curved ash wood handle, secured by a jagged carbon-fibre wedge equipped with a euro suspension hole
- Additional 8 mm (European standard) suspension hole in the handle for easy storage

	 731151		 mm	 g
FGS-1.6-810	8123819	4	800	2200
FGS-1.8-810	8123826	4	800	2400



FCP

FELLING AXES



- For felling trees and also for cutting off branches from felled trees
- Thin blade makes it swing smoothly through the branch
- High-quality hardened tool steel according to DIN 7287, class B
- Surface fine-polished in full
- First-grade hickory handle, secured with a jagged carbon-fibre wedge and an additional metal ring-wedge
- Wedge equipped with a euro suspension hole
- Handle has an 8 mm (European standard) suspension hole for easy storage

	 731151			
FCP-1.8-810	8123970	4	800	2400
FCP-2.3-860	8123994	2	850	3000

FCS

FELLING AXES



- For felling trees and also for cutting off branches from felled trees
- Fully polished axe head and thin blade cuts smoothly through the branch
- High-quality tool steel according to DIN 7287, class B
- Curved ash wood handle, according to DIN 7295, form B, secured by a jagged carbon-fibre wedge which is fixed by an additional metal ring-wedge and equipped with a euro suspension hole for easy storage
- Handle equipped with a non-slip soft grip for comfort and security

	 731151			
FCS-2.0-900SG	8281243	2	900	2530

FFSS

FELLING AXES



- Flare-headed felling axe with long, straight handle, which enables a long swing and a deep cut
- 3-component handle (fibreglass core, polypropylene around the core and elastomer grip) for comfort
- Comfortable, soft non-slip grip offers with large suspension hole for easy storage

	 731151			
FFSS-1.5-900FG	8275884	4	900	2400



AXES, MAULS AND WEDGES

SUS

SPLITTING AXES



- Wedge-shaped axe head and its weight provides easier penetration when splitting wood
- Curved ash wood handle equipped with 8 mm (European standard) suspension hole
- Head secured by a jagged carbon-fibre wedge and an additional metal ring-wedge equipped with a euro suspension hole for easy storage

	 731151		 mm	 g
SUS-2.0-800	8123451	4	800	2400

MCP

SPLITTING AXES



- Heavy axe for use both as a splitting axe and a hammer to drive a wedge
- Intended for chopping difficult and very thick wood
- First-grade hickory handle equipped with 8 mm (European standard) suspension hole for easy storage
- Head secured with a jagged carbon-fibre wedge, and an additional metal ring-wedge

	 731151		 mm	 g
MCP-2.5-810	8124052	2	800	3200

LS/MES

SPLITTING AXES



LS-MERLIN-2.5FG



LS-MERLIN-2.5



- Heavy axe, flat on one side for use both as a splitting axe and a hammer to drive a wedge
- Intended for chopping difficult and very thick wood
- Available with a straight ash wood handle, secured with a leather strap below the head
- Also available as LS-MERLIN-2.5FG with a 3-component handle (polypropylene handle with elastomer grip and fibreglass core) for comfort
- Comfortable non-slip grip on the fibreglass handles give a soft secure grip
- Large suspension hole makes this splitting axe easy storage

	 731151		 mm	 g
LS-MERLIN-2.5	8012069	2	900	3000
LS-MERLIN-2.5FG	8281113	2	900	3550
MES-3.0-900	8123864	2	900	3500



MES



MES-3.5-900



MES-3.5-900FG



SPLITTING AXES

- Heavy axe for use both as a splitting axe and a hammer to drive a wedge
- Head with turning hook for logs
- Intended for chopping difficult and very thick wood
- Available with a straight ash wood handle, secured with a jagged carbon-fibre wedge, and an additional metal ring-wedge
- Also available as MES-2.5-900FG with a straight 3-component handle (polypropylene handle with elastomer grip and fibreglass core) for comfort
- Comfortable non-slip grip on the fibreglass handle gives a soft secure grip and the large suspension hole for easy storage

	 731151		 mm	 g
MES-3.5-900	8123871	2	900	3800
MES-3.5-900FG	8281120	2	900	3900

LS-MASSE



LS-MASSE-4FG



LS-MASSE-4

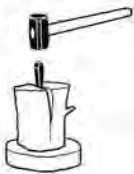

MAULS

- Maul/sledge for driving poles and for forcing wedges into hard-to-work types of wood
- Head of high-quality tool steel, flat on both sides
- Available with straight ash wood handle equipped with 8 mm (European standard) suspension hole for easy storage
- Also available as LS-MASSE-4FG with a straight 3-component handle (polypropylene handle with elastomer grip and fibreglass core) for comfort
- Comfortable non-slip grip on the fibreglass handle gives a soft secure grip and the large suspension hole makes the axe easy store

	 731151		 mm	 g
LS-MASSE-4FG	8275891	2	900	4800
LS-MASSE-4	8012014	2	900	4300

LS-MASSE-TR



MAULS

- Maul/sledge for driving poles and for forcing wedges into hard-to-work types of wood
- Head of high-quality tool steel, flat on one side
- Straight 3-component handle (fibreglass core, polypropylene around the core and elastomer grip) for comfort
- Comfortable non-slip grip gives a soft secure grip and the large suspension hole makes the axe easy to store

	 731151		 mm	 g
LS-MASSE-TR-4FG	8281106	2	900	5000



AXES, MAULS AND WEDGES

SH



SPARE HANDLES AXES

- Traditional axe handles made of selected ash wood of high quality
- Professional handles made of a very resistant 3-component fibreglass material for comfort
- Each wooden spare handle is supplied with a plastic wedge for fixation of the handle in the axe-head
- Advice:
 - Remove the old handle, clean out the eye of the head and fix the new handle into the eye
 - Drive the plastic wedge into the handle using a hammer until it has reached the same level as the head itself
 - For details see instruction card attached to each ash wood handle

	 731151		 mm	 g
SH-FCS-810	8140540	1	800	450
SH-FCS-860	8140557	1	850	500
SH-FGS-600	8140649	1	600	400
SH-FGS-700	8140656	1	700	450
SH-FGS-800	8140663	1	800	500
SH-HFGPS-400FG	8282301	1	400	250
SH-HGPS-400	8207618	1	400	200
SH-MES-F-900	8141554	1	900	500
SH-HGPS-360	8140618	1	360	150
SH-HGPS-380	8140625	1	380	180
SH-HUS-380	8140502	1	380	190
SH-HUS-500	8140519	1	500	250
SH-HUS-650	8140526	1	650	400
SH-MES-900	8140601	1	900	550
SH-MES-900FG	8282318	1	900	1000
SH-SUS-800	8140809	1	800	500
SH-MCS-800	8140595	1	800	500
SH-PAGS-900FG	8326944	1	920	1030

WT



SPLITTING WEDGE

- Twisted steel wedge for easy splitting of hard-to-work types of wood
- Requires less force to drive in
- Excellent splitting capacity

	 731151		 mm	 g
W-T-2.0	8140847	4	220	2000

WS



SPLITTING WEDGE

- Traditional steel splitting wedge
- Different sizes available

	 731151		 mm	 g
W-S-1.5	8140816	4	230	1500
W-S-2.0	8140823	4	250	2000
W-S-2.5	8140830	4	260	2500



LS-COIN



FELLING WEDGES

- Synthetic wedge, ideal for use in conjunction with felling operations using a chain saw
- Does not damage the saw chain

	 731151			
LS-COIN 19 CM	8031077	4	190	260
LS-COIN 24 CM	8031084	4	240	430

PAGS-2.0-900FG



PICK AXES

- Pick axe with a head weight of 2 kg for breaking the ground and for construction work
- Head made of forged and hardened steel
- Handle made of polypropylene reinforce with fibreglass
- Soft grip part on the handle for additional comfort and a large suspension hole for easy storage

	 731151			
PAGS-2.0-900FG	8292355	2	900	3000

PAGS



PICK AXES

- Pick axes for breaking the ground and for construction work
- Head made of forged and hardened steel, round eye
- Three head weights available: 2 kg, 2.5 kg and 3 kg

	 731151		A mm	L mm	
PAGS-2.0	8327835	6	52	450	2000
PAGS-2.5	8327842	6	55	480	2500
PAGS-3.0	8327859	6	58	520	3000

SH-PAGS



PICK AXES

- Spare handles for pick axes with a round eye
- Wooden handles made high quality wood
- Fibreglass handle, very resistant, made of 3-components
 - Fibreglass core
 - Polypropylene coating
 - Elastomer soft grip

	 731151			
SH-PAGS-900	8327866	1	900	700
SH-PAGS-900FG	8326944	1	920	1030



3740

FLAT CHISELS



- Finish: Lacquered, copper coloured, safety impact head
- Material: Vanadium extra
- Flat oval shank
- DIN 6453

	 731415		L mm	a mm	b mm	
3740-100	1834005	5	100	15	14x9	85
3740-125	1834012	5	125	15	14x9	150
3740-150	1834029	5	150	18	17x11	190
3740-175	1834036	5	175	21	20x12	280
3740-200	1834043	5	200	24	23x13	395
3740-250	1834050	5	250	25	23x13	560
3740-300	1834067	5	300	26	23x13	685

SB-3740

FLAT CHISELS



- Finish: Safety impact head
- Material: Vanadium extra
- Flat oval shank
- DIN 6453
- Retail packed on blister card

	 731415		L mm	a mm	b mm	
SB-3740-125	0115990	5	125	18	17x11	150
SB-3740-150	0116003	5	150	18	17x11	190
SB-3740-175	0116010	5	175	21	20x12	280
SB-3740-200	0116027	5	200	24	23x13	400
SB-3740-250	0116034	5	250	25	23x13	500
SB-3740-300	0116041	5	300	26	23x13	600

3745

CAPE CHISELS



- Finish: Lacquered, copper coloured, safety impact head
- Material: Vanadium extra
- Flat oval shank
- DIN 6451

	 731415		L mm	a mm	b mm	
3745-150	1834081	5	150	6	17x11	175
3745-175	1834098	5	175	7	17x11	205
3745-200	1834104	5	200	8	20x12	285
3745-250	1834111	5	250	9	23x13	455



3750

SLITTING CHISEL

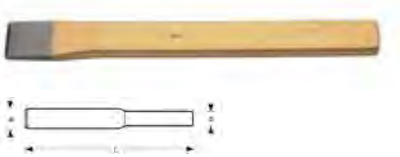

- Finish: Lacquered, copper coloured, safety impact head
- Material: Vanadium extra
- Flat oval shank

	 731415		L mm	a mm	b mm	 g
3750	1834128	5	240	26	26x7	280

3750H

SLITTING CHISEL



- Finish: Lacquered, copper coloured, safety impact head
- Material: Vanadium extra
- With plastic hand protection

	 731415		L mm	a mm	b mm	 g
3750H	1834135	2	240	26	26x7	380

3736M

MASON'S CHISELS



- Finish: Lacquered, copper coloured, safety impact head
- Material: Vanadium extra
- DIN 7254 form B

	 731415		L mm	a mm	b mm	 g
3736M-250	1834142	5	250	23	16	380
3736M-300	1834159	5	300	26	18	660
3736M-400	1834166	5	400	26	18	880

3736MH

MASON'S CHISELS

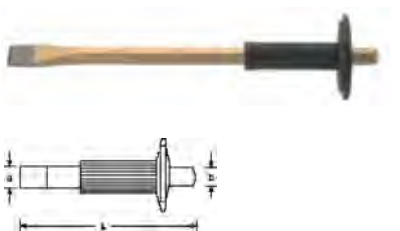

- Finish: Lacquered, copper coloured, safety impact head
- Material: Vanadium extra
- With plastic hand protection

	 731415		L mm	a mm	b mm	 g
3736MH-250	1834173	2	250	23	16	480
3736MH-300	1834180	2	300	26	18	760
3736MH-400	1834197	2	400	26	18	980



COLD CHISELS

3739-250 / -400



POINTED CHISELS

- Finish: Lacquered, copper coloured, safety impact head
- Material: Vanadium extra
- Octagonal shank
- DIN 7256

	 841334		L mm	b mm	 g
	1834203	5	250	16	380
	1834210	5	300	18	610
	1834227	5	400	18	860

3739H



POINTED CHISELS

- Finish: Lacquered, copper coloured, safety impact head
- Material: Vanadium extra
- With plastic hand protection

	 841334		L mm	b mm	 g
	1834234	2	250	16	480
	1834241	2	300	18	710
	1834258	2	400	18	960

8740



COLD CHISELS

- Forged head
- Regrindable
- Chromium steel

	 841334		A mm	BxH mm	L mm	 g
	5024938	5	20	20x10	200	280
	5024945	5	25	25x12	250	500
	5024952	5	26	26x13	300	680
	5024969	5	26	26x13	350	810
	5024976	5	26	26x13	400	920
	5024983	5	26	26x13	500	1140

8741



COLD CHISELS

- Forged head
- Regrindable
- Chromium steel

	 841334		L mm	 g
	5080989	5	200	380
	5081009	5	250	600
	5081023	5	300	780
	5081047	4	350	910
	5081061	5	400	1020



8746

POINTED CHISELS



- Octagonal pointer
- Forged head
- Regrindable
- Chromium steel

	 841334		A mm	L mm	 g
874602000	5024990	5	14	200	240
874602500	5025003	5	14	250	320
874603000	5025065	5	16	300	480
874603500	5025072	5	16	350	570
874604000	5025089	5	18	400	810

8749

POINTED CHISELS



- Rubber handle for octagonal pointer 8746

	 841334		L mm	 g
874900010	5025102	1	128	100

8760

ELECTRICIANS' CHISELS



- Forged head
- Regrindable
- Chromium steel

	 841334		A mm	L mm	 g
876002000	5025119	10	10	200	130
876002500	5025126	10	10	250	170

8770

EXTRA FLAT COLD CHISELS



- Forged head
- Regrindable
- Chromium steel

	 841334		A mm	BxH mm	L mm	 g
877002400	5025140	8	26	26x7	240	245



PUNCHES

3735

CENTRE PUNCHES



- Finish: Lacquered, copper coloured, safety impact head
- Material: Vanadium extra
- Octagonal shank
- DIN 7250

	 731415		L mm	Ø mm	b mm	 g
	1834265	5	120	4	10	70
	1834272	5	120	5	12	85
	1834289	5	150	5	12	145

3735N

CENTRE PUNCHES



- Centre punch with hexagonal shank
- Finish: Full polished steel surface, with brilliant chrome finishing
- Material: Vanadium extra
- Retail packed on blister card

	 731415		L mm	Ø mm	b mm	 g
	1847906	1	100	2	7	39
	1847913	1	120	4	9	66
	1847920	1	120	5	11	91
	1847937	1	150	6	11	114
	1847944	1	150	8	11	118



1157

CENTRE PUNCHES



- Automatic centre punch which strikes blow when pressure is applied - no hammer needed
- Hardened steel point



	 731151		L mm	Ø mm	b mm	 g
1157	8277031	20	130	2	15	35





3733

DRIFT PUNCHES



- Finish: Lacquered, copper coloured, safety impact head
- Material: Vanadium extra
- Octagonal shank
- DIN 6458

	 731415		L mm	Ø mm	b mm	 g
3733-2	1834371	5	120	2	10	65
3733-3	1834388	5	120	3	10	65
3733-4	1834395	5	120	4	10	65
3733-5	1834401	5	120	5	10	65
3733-6	1834418	5	120	6	10	65

3734

DRIFT PUNCHES



- Finish: Lacquered, copper coloured, safety impact head
- Material: Vanadium extra
- Octagonal shank
- DIN 6450. Form C

	 731415		L mm	Ø mm	b mm	 g
3734-2	1834296	5	150	2	10	60
3734-3	1834319	5	150	3	10	60
3734-4	1834326	5	150	4	10	65
3734-5	1834333	5	150	5	10	65
3734-6	1834340	5	150	6	10	70
3734-8	1834357	5	150	8	12	75

3734N

DRIFT PUNCHES



- Drift punch with hexagonal shank
- Finish: Full polished steel surface, with brilliant chrome finishing
- Material: Vanadium extra
- Retailed packed on blister card

	 731415		L mm	Ø mm	b mm	 g
SB-3734N-2-150	1847968	1	150	2	7	48
SB-3734N-3-150	1847975	1	150	3	7	49
SB-3734N-4-150	1847982	1	150	4	9	70
SB-3734N-5-150	1847999	1	150	5	9	72
SB-3734N-6-150	1848071	1	150	6	11	100
SB-3734N-7-150	1848088	1	150	7	11	102
SB-3734N-8-150	1848095	1	150	8	11	111
SB-3734N-10-150	1848101	1	150	10	11	120



PUNCHES

3735-AU

AUTOMATIC PUNCH

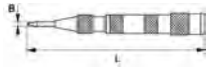

- Automatic centre punch
- No hammer required

			L mm	b mm	
3735-AU	731415 0125050	1	130	2	85

3732

NAIL PUNCHES



- Nail punch with plastic handle
- Finish: Full polished steel surface, with brilliant chrome finishing
- Material: Vanadium extra
- Retail packed on blister card

			L mm	a mm	b mm	
SB-3732-2-125	731415 1847869	1	125	2.0	8.0	62
SB-3732-2.5-125	1847876	1	125	2.5	8.0	62
SB-3732-3.2-125	1847883	1	125	3.2	8.0	62
SB-3732-4-125	1847890	1	125	4.0	8.0	62

3736S/6

SET OF CHISELS



- Finish: Lacquered, copper coloured, safety impact head
- Material: Vanadium extra
- In lacquered metal box, anthracite colour
- 6 pcs

3736S/6	731415 1834463	1	825

3756
125x10x12 mm, 150x12x16 mm



3735
120x10x4 mm



3749
125x10x5 mm



3733
120x10x3 mm, 150x12x4 mm





3734S/6

SET OF DRIFT PUNCHES



- Set of 6 drift punches, 3734
- In lacquered metal box, anthracite colour
- Finish: Lacquered, copper coloured, safety impact head
- Material: Vanadium extra
- Length 150 mm

	 731415		 g
3734S/6	1834470	1	790
3734 2, 3, 4, 5, 6, 8 mm			



3643

CENTRE PUNCHES WITH HAND PROTECTION



- Finish: Nickel-plated, safety head
- Material: Vanadium extra, plastic covered
- DIN 7250
- Octagonal shank

	 731415		L mm	Ø mm	B mm	 g
3643-100	1074654	5	100	3	8	35
3643-120	1074678	5	120	4	10	65
3643-150	1074685	5	150	5	12	145

3644

DRIFT PUNCHES WITH HAND PROTECTION



- Finish: Nickel plated, safety impact head
- Material: Vanadium extra, plastic covered
- DIN 6458
- Octagonal shank

	 731415		L mm	Ø mm	B mm	 g
3644-120	1074708	5	120	2	10	35
3644-125	1074722	5	125	3	10	65
3644-130	1074746	5	130	4	10	110
3644-150	1074760	5	150	4	10	135
3644-165	1074777	5	165	5	10	155
3644-180	1074791	5	180	6	10	250
3644-200	1074807	5	200	8	12	290



PUNCHES

3646

DRIFT PUNCHES WITH HAND PROTECTION



- Finish: Nickel plated, safety impact head
- Material: Vanadium extra, plastic covered
- DIN 6450. Form D
- Pin finely ground and polished, octagonal shank

	 731415		L mm	Ø mm	B mm	 g
3646-115	1074937	5	115	2	8	30
3646-125	1074944	5	125	3	8	35
3646-150	1074951	5	150	4	10	65
3646-165	1074968	5	165	5	10	75
3646-180	1074975	5	180	6	12	130
3646-200	1074982	5	200	8	12	170

3658A

DRIFT PUNCHES WITH HAND PROTECTION



- Finish: Nickel plated, safety impact head
- Material: Vanadium extra, plastic covered
- DIN 6450
- Octagonal shank

	 731415		L mm	Ø mm	B mm	 g
3658A-2	1075293	5	150	2	8	60
3658A-3	1075309	5	150	3	8	60
3658A-4	1075316	5	150	4	10	65
3658A-5	1075323	5	150	5	10	65
3658A-6	1075330	5	150	6	12	70
3658A-8	1075347	5	150	8	12	75

3646/6

SET OF DRIFT PUNCHES WITH HAND PROTECTION SET



- Set of 3646 drift punches
- Finish: Nickel plated, safety impact head
- Material: Vanadium extra, plastic covered
- DIN 6450. Form D
- Pin finely ground and polished, octagonal shank
- In wooden stand

	 731415		 g
3646/6	1074999	1	730

3646
2-115, 3-125, 4-150, 5-165, 6-180, 8-200 mm



3658A/6

SET OF DRIFT PUNCHES WITH HAND PROTECTION SET



- Finish: Nickel plated, safety impact head
- Material: Vanadium extra, plastic covered
- DIN 6450
- Octagonal shank
- In wooden stand

	 731415		
3658A/6	1075354	1	590

3658A
2, 3, 4, 5, 6, 8 mm







3659

DRIFT PUNCHES WITH KNURLED GUIDE SLEEVE



- Finish: Nickel and chrome plated
 - Material: Vanadium extra
 - Pin finely ground and polished
 - The drift pin is positioned with the guide sleeve pushed forward. When driven, the pin is supported by the sliding sleeve, avoiding breakage of the pin
- ** without guide sleeve

	 731415		\varnothing mm	L mm	
3659-0.9	1075507	5	0.9	75	5
3659-1.4	1075514	5	1.4	85	12
3659-1.8	1597351	5	1.8	85	12
3659-2.4	1075538	5	2.4	90	21
3659-2.8	1597436	5	2.8	95	22
3659-3.4	1075552	5	3.4	95	23
3659-3.9	1075569	5	3.9	100	25
3659-6.0	1075576	5	** 5.9	100	30

3659/8

SETS OF PIN PUNCHES



- Set of 8 pin punches in plastic stand
- Finish: Nickel and chrome plated
- Material: Vanadium extra
- Pin finely ground and polished
- The drift pin is positioned with the guide sleeve pushed forward. When driven, the pin is supported by the sliding sleeve, avoiding breakage of the pin
- 6.0 mm without guide sleeve

	 731415		
3659/8	1075583	1	265

3659
0.9, 1.4, 1.8, 2.4, 2.8, 3.4, 3.9, 6.0 mm





PUNCHES

3659/8T



SETS OF PIN PUNCHES

- Set of 8 pin punches in plastic wallet
- Finish: Nickel and chrome plated
- Material: Vanadium extra
- Pin finely ground and polished
- The drift pin is positioned with the guide sleeve pushed forward. When driven, the pin is supported by the sliding sleeve, avoiding breakage of the pin
- 6.0 mm without guide sleeve

3659/8T	731415 1472573	1	g 190
3659			
0.9, 1.4, 1.8, 2.4, 2.8, 3.4, 3.9, 6.0 mm			



SETS

3654R



TOOL SET

- Set of 6 in plastic wallet
- Finish: Nickel plated, safety impact head
- Material: High performance alloy steel, plastic covered

3654R	731415 1075132	1	g 680
3656			
125, 150 mm			
3649			
125x5 mm			
3644			
125, 150 mm			
3643			
120x4 mm			

3656/10



TOOL SET

- Set of chisels, drift and centre punches
- Finish: Nickel plated, safety impact head
- Material: High performance alloy steel
- In plastic wallet

3656/10	731415 1075279	1	g 1245
3656			
125, 150, 175 mm			
3644			
120, 150 mm			
3649			
125x5 mm			
3643			
120x4 mm			
3646			
125, 150, 165 mm			



4400

WRECKING BARS



- Wrecking bar
- Bent end and a flat end
- Nail claw on one end

	 841334		Ø mm	L mm	 g
440005000	5011952	1	18	500	1120
440006000	5011969	1	20	600	1640
440007000	5011976	1	20	700	1900
440008000	5011983	1	22	800	2215
440010000	5011990	1	22	1000	2730
440012000	5005449	1	22	1200	3255
440015000	5098960	1	22	1500	3960

MASON'S PIN



4401

MASON'S PIN

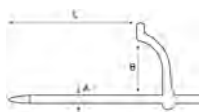

- Fully tempered steel

	 841334		A mm	B mm	L mm	 g
440102500	5098977	10	10	100	250	260
440103000	5098991	10	10	100	300	290

DIGGING TOOLS

Bahco small garden and border tools are designed for tending plants in rock gardens, on balconies or in containers and raised flower-beds.

Special epoxy paint on the steel parts prevents rust and prevents soil from sticking to the tool. Border tools have a longer reach for easier accessibility to wider borders and under shrubs.

Bahco shovels are ideal for building construction, and to collect and move materials. The black paint on the carbon-steel blades protects from rust and prevents material from sticking to the tool.

The handles are made of eucalyptus wood, available with YD- and T-Grip.



Chapter Index

SHOVELS	1112
SPARE PARTS	1112
HOES	1113
RAKES	1113
SMALL GARDEN TOOLS	1114-1118





SHOVELS

4250

ROUND MOUTH SHOVELS

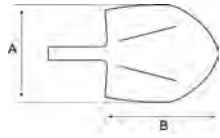

- Round mouth shovels for building and construction
- Blades made of carbon steel with black painted blade
- Two different size offered
- Handles made from eucalyptus wood
- C: Type of handle with YD- and T-grip
- Spare handles available

	 841334		A mm	B mm	C	 g
4250M0020	5079365	6	265	330	T	2060
4250M0030	5033626	6	280	340	T	2130
4250A0020	5079372	6	265	330	YD	2210
4250A0030	5033633	6	280	340	YD	2250

4255

SQUARE MOUTH SHOVELS

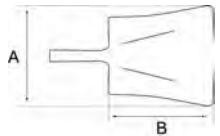

- Square mouth shovels for building and construction
- Blades made of carbon steel with black painted blade
- Two different sizes offered
- Handles made from eucalyptus wood
- C: Type of handle with YD- and T-grip
- Spare handles available

	 841334		A mm	B mm	C	 g
4255M0020	5079396	6	235	320	T	2180
4255M0030	5033640	6	245	340	T	2245
4255A0020	5079402	6	235	320	YD	2100
4255A0030	5033657	6	245	340	YD	2325



SPARE PARTS

4250M

WOODEN HANDLES



- Wooden handle with T-grip
- For shovels and spades
- A = handle thickness

	 841334		A mm	L mm	 g
4250MM000	5033909	6	120	690	595





4300

CONCRETE SPREADER



- Tool with a wide blade to spread concrete and to level surfaces
- Made of carbon steel with black painted blade
- Use with wooden handle reference 430000000



	 841334		A mm	B mm	 g
430002600	5036016	6	160	260	1250
430000000	5040013	6	37	1200	940





4280

RAKE, 5 PRONGS

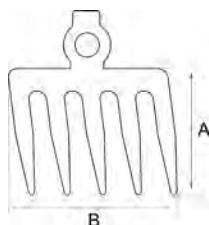

- Rake with 5 prongs
- Forged in one piece with sharpened prongs
- Use with handle reference 428000000



	 841334		A mm	B mm	 g
428005200	5033619	6	160	200	1300
428000000	5033923	6	40	1100	960



SMALL GARDEN TOOLS

P262

EXPERT SMALL GARDEN TOOLS



- For breaking the ground and loosening clogged soil surfaces
- Helps to prepare the soil before sowing
- Head made of fully hardened steel with epoxy powder coating for rust protection
- Comfortable handle with round shape made of polypropylene with a soft grip

	 731151		 mm	 g
P262	8299286	10	315	224

P263

EXPERT SMALL GARDEN TOOLS



- For all kinds of work like preparation of beds and borders, potting, planting and distributing compost, mulch or fertilizer
- Head made of fully hardened steel with epoxy powder coating for rust protection
- Very resistant when digging in wet and heavy soil
- Comfortable handle with round shape made of polypropylene with a soft grip

	 731151		 mm	 g
P263	8299262	10	370	306

P264

EXPERT SMALL GARDEN TOOLS



- For loosening the soil to let air, heat and water in, helping support the development of the root system
- Helps to control weeds by uprooting seedlings
- Head made of fully hardened steel with epoxy powder coating for rust protection
- Comfortable handle with round shape made of polypropylene with a soft grip

	 731151		 mm	 g
P264	8299279	10	315	210







P266

EXPERT SMALL GARDEN TOOLS



- For cleaning and leveling the soil around the plants
- Head made of fully hardened steel with epoxy powder coating for rust protection
- Comfortable handle with round shape made of polypropylene with a soft grip

	 731151		 L mm	 g
P266	8299293	10	320	199

P267

EXPERT SMALL GARDEN TOOLS



- Two-prong fork for loosening the soil to aerate
- Versatile tool for different jobs
- Hoe blade for loosening the ground and for breaking clogged soil or cutting weeds
- Head made of fully hardened steel with epoxy powder coating for rust protection
- Comfortable handle with round shape made of polypropylene with a soft grip

	 731151		 L mm	 g
P267	8299309	10	315	231

P268

EXPERT SMALL GARDEN TOOLS



- For preparing the soil and sowing or transplanting
- Broad hoe blade for breaking clogged soil and for weeding
- Pointed hoe blade for making rows and furrows for sowing and planting
- Head made of fully hardened steel with epoxy powder coating for rust protection
- Comfortable handle with round shape made of polypropylene with a soft grip

	 731151		 L mm	 g
P268	8299316	10	325	235



SMALL GARDEN TOOLS

P269

EXPERT SMALL GARDEN TOOLS



- Special weeding tool to cut and lift deep rooting weeds like dandelions, thistles and certain umbelliferae
- Blade made of fully hardened steel with epoxy powder coating for rust protection
- Comfortable handle with round shape made of polypropylene with a soft grip



P269



731151
8299323



10



315



140

P270

EXPERT SMALL GARDEN TOOLS



- For loosening, cleaning and levelling the ground before planting
- For weeding between plants in borders and for transplanting
- For harvesting root vegetables like radishes or carrots on small plots
- Head made of fully hardened steel with epoxy powder coating for rust protection
- Comfortable handle with round shape made of polypropylene with a soft grip



P270



731151
8299330



10



300



199

P241

EXPERT SMALL GARDEN TOOLS



- Bulb planter with powder coating for rust protection and non-sticking surfaces
- Solid wooden handle
- For planting bulbs and small plants



P241



731151
8008956



5



300



P272

EXPERT SMALL GARDEN TOOLS - 10 CM LONGER



- For breaking the ground and loosening clogged soil
- To prepare the soil before sowing
- Head made of fully hardened steel with epoxy powder coating for rust protection
- Metal rod 10 cm longer than on small garden tools for better reach
- Comfortable handle with round shape made of polypropylene with a soft grip

	 731151		 L mm	 g
P272	8299354	5	430	250

P274

EXPERT SMALL GARDEN TOOLS - 10 CM LONGER



- For loosening and aerating the soil
- For controlling weeds through uprooting their seedlings
- Head made of fully hardened steel with epoxy powder coating for rust protection
- Metal rod 10 cm longer than on small garden tools for better reach
- Comfortable handle with round shape made of polypropylene with a soft grip

	 731151		 L mm	 g
P274	8299347	5	455	210

P276

EXPERT SMALL GARDEN TOOLS - 10 CM LONGER



- Small rake to clean, level and even the ground around plants
- To cover seeds and distribute mulch over a larger surface
- Head made of fully hardened steel with epoxy powder coating for rust protection
- Metal rod 10 cm longer than on small garden tools for better reach
- Comfortable handle with round shape made of polypropylene with a soft grip

	 731151		 L mm	 g
P276	8299361	5	440	250



SMALL GARDEN TOOLS

P277

EXPERT SMALL GARDEN TOOLS - 10 CM LONGER



- Versatile tool for different jobs
- Hoe for loosening the ground and for breaking clogged soil or cutting weeds
- Two pronged fork for loosening the soil to aerate
- Head made of fully hardened steel with epoxy powder coating for rust protection
- Metal rod 10 cm longer than on small garden tools for better reach
- Comfortable handle with round shape made of polypropylene with a soft grip

	 731151		 L mm	 g
P277	8299378	5	435	260

P278

EXPERT SMALL GARDEN TOOLS - 10 CM LONGER



- One point hoe for preparing the soil
- For making rows and furrows for sowing and planting
- Broad hoe for breaking clogged soil and loosening but also for weeding
- Head made of fully hardened steel with epoxy powder coating for rust protection
- Metal rod 10 cm longer than on small garden tools for better reach
- Comfortable handle with round shape made of polypropylene with a soft grip

	 731151		 L mm	 g
P278	8299385	5	435	260



PRUNING TOOLS

Working with plants means working with living things and the users of pruning tools therefore need to be especially careful and respectful of nature. They need perfect cuts as high-quality results and increased productivity are both important. Bahco has developed tools that reduce fatigue and prevent injuries, while providing precise, durable and reliable performance, every time.

Combining functional design, modern aesthetics and decades of experience on five continents, Bahco has developed a range of tools designed to satisfy the specific needs of professionals in numerous, highly demanding pruning applications.

Bahco pruning tools are available in three ranges: Professional, Expert and Tradition.

Chapter Index

SECATEURS	1134-1144
SNIPS	1145-1146
POWER TOOLS	1147-1150
LOPPERS	1151-1157
POLES AND TOP-PRUNERS	1158-1160
HEDGE SHEARS	1161-1164
GRASS SHEARS	1165-1166
PRUNING KNIVES	1166
SCISSORS	1167
PRUNING SAWS	1168-1172
ACCESSORIES & MAINTENANCE	1173-1176



PRUNING TOOLS

An extensive range of pruning tools to satisfy the demands of professional users and discerning gardeners.

PROFESSIONAL

- High-quality pruning and cutting tools aimed at professional users within each different area of application
- Developed with the latest materials and technologies for efficient, comfortable and attractive tools
- Spare parts available for all tools



EXPERT

- Assortment of gardening tools for the quality conscious discerning private consumer
- No spare parts available



TRADITION

- Assortment of functionally-designed pruning and cutting tools for professional users and gardeners
- Spare parts are available for selected tools



ICON INDEX - AREAS OF APPLICATION

To help you select the right tools for the job, the range has been organized into:



VITICULTURE



POMOLOGY



LANDSCAPE



FORESTRY



GARDEN



BLADE TECHNOLOGY

BYPASS: For cutting live and green wood

Bypass secateurs and loppers are used for cuts on living plants, where the impact of the cut has to be as small as possible.

The bypass cutting head owes its name to the fact that the cutting blade 'passes-by' the counterblade in a scissor action.

Bahco bypass secateurs slice through the wood requiring less force than a straight cut, causing less compression damage to the wood.

ANVIL: For cutting mature and dry wood

Anvil secateurs and loppers are used where cleanliness of cut is not as important.

The blade of the cutting head is narrower and sharper than that of the bypass.

When cutting mature and dry wood, the blade needs to be forced through the wood with greater pressure. The 'anvil' supports the branch and spreads the pressure to reduce damage.

BYPASS

As with the blade, the counterblade also presses into the wood.

The waste wood may be damaged.

But the cut itself is clean and flat.

ANVIL

As the narrow blade is forced through the wood.

The board "anvil" spreads the load and supports the branch.

Until the cut is complete.

BLADE TECHNOLOGY

THE GRINDING EDGE

Four separate grinding operations are performed (Drawing A)

1. Main bevel, the cutting area of the blade is tapered to a point
2. Cavity, a shallow hollow is ground into the inner face of the blade
3. Second bevel, the edge is polished to a razor sharp point
4. Back bevel, an additional honing angle is ground on the inside edge

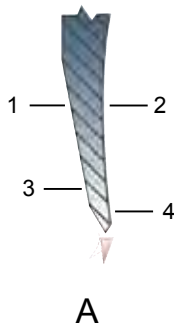

Reduced friction and sticking (Drawing B)

- Due to the hollow inner face, the blade only touches the counterblade at the point of cutting. This reduces friction and the risk of sticking, and increases performance



SLICING CUT

How it works

- The sharp upward curve of the blade causes the leading edge to 'slice' as it cuts into the wood
- The off-centered pivot bolt doubles this slicing motion increasing the length of the blade used for cutting

Why it works

Imagine cutting a loaf of bread. No matter how sharp your blade, if you attempt to cut without slicing, the bread is compressed and becomes harder to cut, requiring more pressure, damaging the loaf.

Cutting live wood is similar – it can also be cut more efficiently if a slicing motion is added to the downward pressure.

Results

- Less cutting force required
- Clean cut without damaging the plants
- Less wear and longer blade life
- Fewer broken blades

EVOLVING BEVEL

The evolving bevel technology is the latest improvement of the slicing cut. The unique grinding profile of the blade reinforces the slicing motion and helps it penetrate the wood, especially at the beginning of the cut. This gives the user a

feeling of ease, quickness and efficiency during pruning.

- The evolving bevel technology is exclusive to Bahco and implemented in the P116-SL lopper range

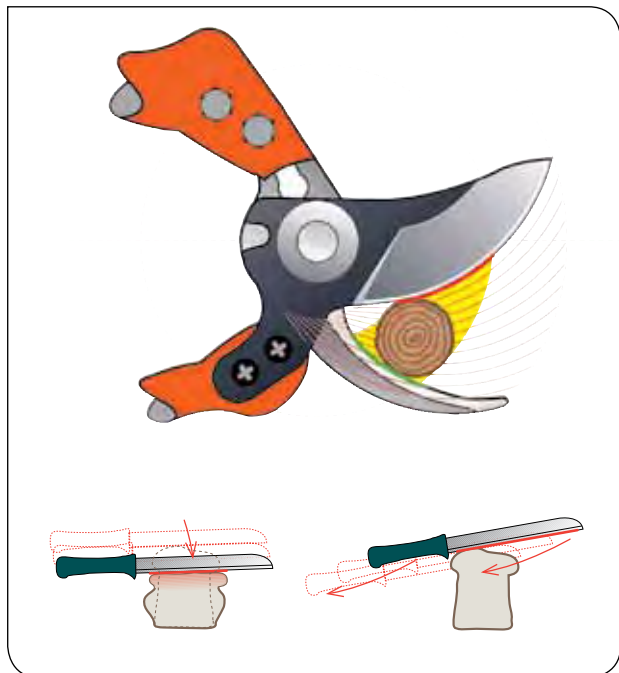

ERGONOMIC SECATEUR



PROFESSIONAL

COMFORT

SECURITY

HEALTH

EFFICIENCY

The design of the ERGO™ secateur is the result of five years of scientific research and hundreds of user tests all over the world to help us understand how repetitive, intense movements affect the

human body. The design of the ERGO™ secateurs mean less fatigue at the end of the day and less painful, more productive work.

What makes the PX and PXR ergonomic?

FEATURES

- Vertical and lateral inclinations
- Shape of the handles
- Elastomer coating on upper handles
- Choice of cutting head
- Choice of spring
- Hand measuring system

BENEFITS

- Keeps the wrist in a neutral position
- Provides comfort
- Helps to spread pressure evenly
- Provides the right cutting head for each job
- Adapts the secateur to the power of the hand
- Guides to find the best secateur



Vertical inclination
Compared to a traditional secateur, the downward inclination of the PX and PXR ERGO™ secateurs compensates the wrist bending and allows the hand to remain in a neutral position, significantly reducing the risk of Carpal Tunnel Syndrome.



Lateral inclination
Compared to a traditional secateur, the inclination to the left (for right-handed secateurs) of the PX and PXR ERGO™ secateurs compensates for the bending of the wrist, and allows the hand to remain in a neutral position, improving pressure capacity to be applied on handles and prevents MSDs (musculoskeletal disorders).



HAND-MEASURING GUIDE FOR PX AND PXR ERGO™ SECATEURS

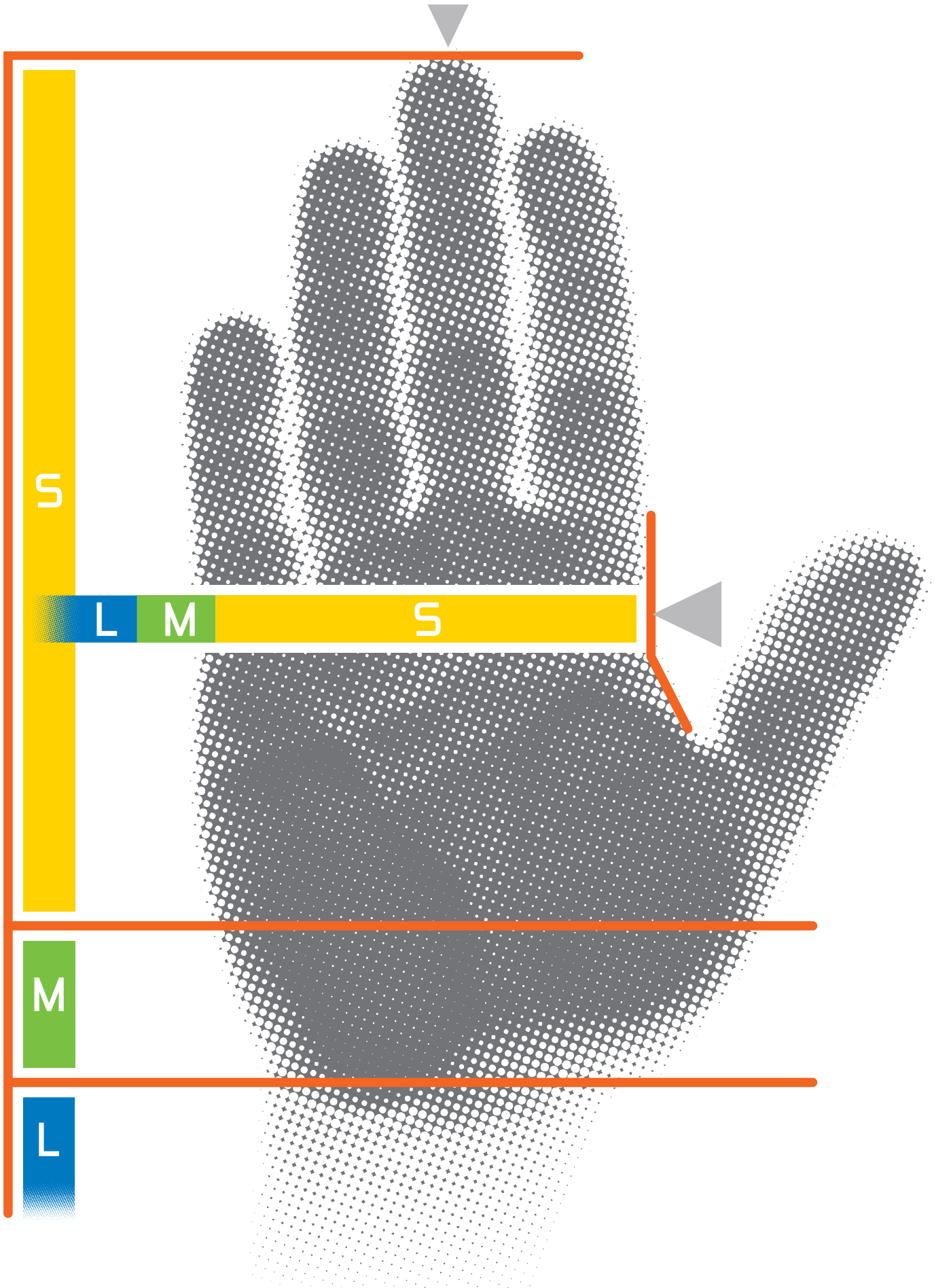

Measure finger-tip to wrist to determine the length of the hand

Measure hand from top of index finger to base of palm to determine the width of the hand

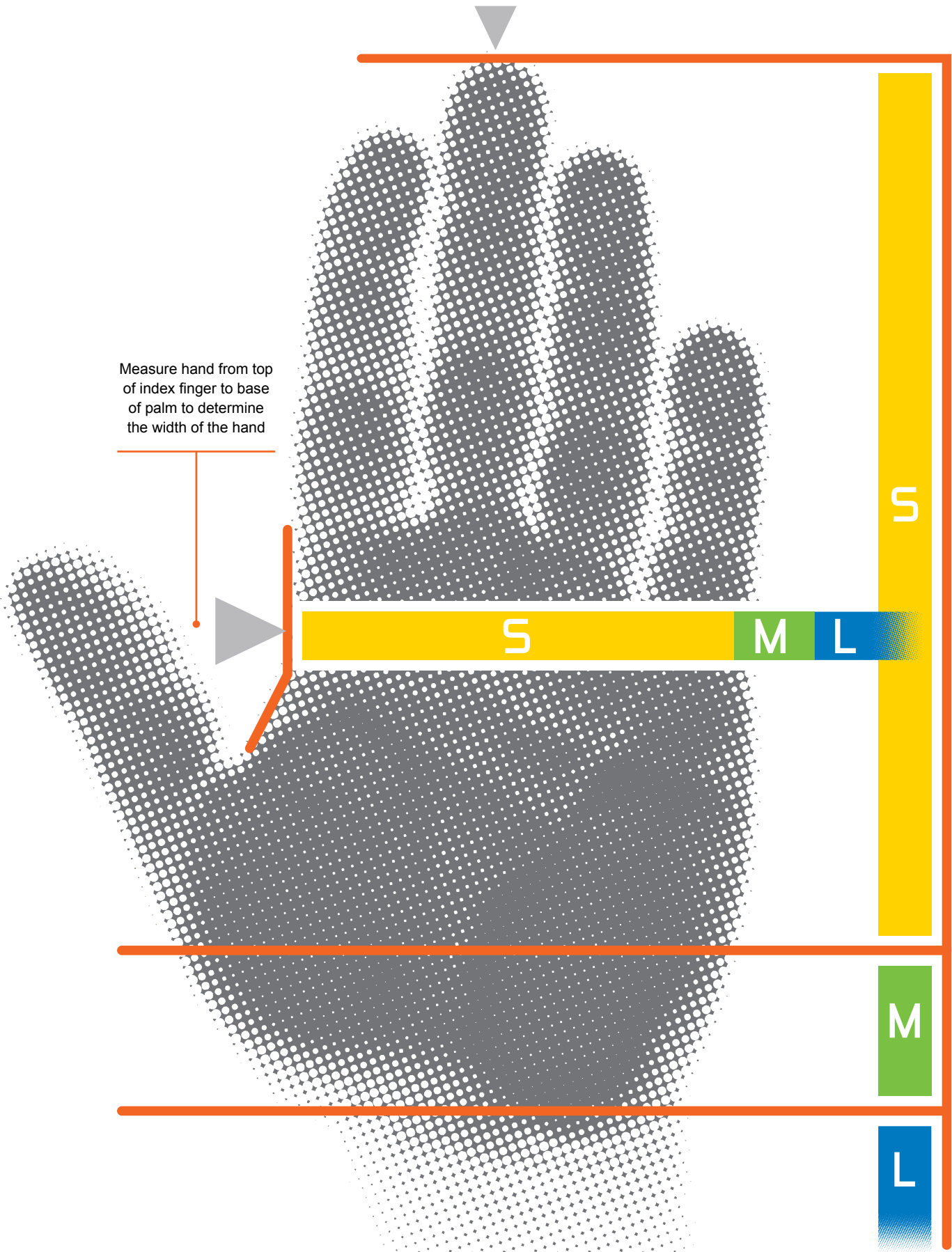

ERGONOMIC CONCEPT

PX TYPE

Fixed handle ergonomic secateur

Ergonomic design within a modular system, enabling the user to build a secateur that fits the hand perfectly.



PXR TYPE

Rotating handle ergonomic secateur

Same head and palm handle as the PX, but with a comfortable, elastomer-coated, rotating handle.

PXR cuts with optimal accuracy and ease.



100% MODULARITY. All spare parts available.

RIGHT-HANDED HANDLES

CUTTING HEAD SIZES



PX-S
Fixed handle
Small size

N° 1 Small cutting head
(Cut. cap. 15 mm - 5/8")



Ø 15 mm (5/8")

Ideal for end of season, clearing of vines from training wires and green pruning.

ERGO™ tip: Highly recommended for users who are already suffering from aches and pains in their hand or arm.



PX-M
Fixed handle
Medium size

N° 2 Medium cutting head
(Cut. cap. 20 mm - 3/4")



Ø 20 mm (3/4")

Ideal for most popular training methods in vineyards of up to 10 years of age.

ERGO™ tip: Recommended for users who do not feel any pain yet, but who wish to avoid it.



PX-L
Fixed handle
Large size



PXR-S
Rotating handle
Small size

N° 3 Large cutting head
(Cut. cap. 30 mm - 1 1/4")



Ø 30 mm (1 1/4")

Ideal for most popular training methods in vineyards of up to 10 years old.

ERGO™ tip: Not recommended for users who already suffer from pains in the hand or arm. It is then advisable to use a lopper or a pruning saw.



PXR-M
Rotating handle
Medium size

LEFT-HANDED HANDLES

CUTTING HEAD SIZE



PX-M2-L
Fixed handle
Medium size



N° 2 Medium cutting head
(Cut. cap. 20 mm - 3/4")



Ø 20 mm (3/4")



PXR-M2-L
Rotating handle
Medium size



HARVESTING SNIPS

FOUR DIFFERENT CUTTING HEADS

The handy and lightweight Bahco Harvesting Snips meet the needs of different end-users. They have comfortable handles reinforced with fibreglass - all snips are supplied with a lightweight plastic holster and are available in different box quantities.



Lightweight plastic holster to avoid injuries and loss. Supplied with all snips models. (Not applicable for BULK56)

P123

Long and slim bypass cutting head.



P127

Short blades, rounded at the tips for safety, with limited opening.



P128

Long, slim and straight blades. Wide opening.



P129

Same blades as P128 but bent at an 11° angle to give better access to hidden stems.



Easy-to-tighten nut

Shock-absorbing rubber buffer with spring inside handles

Very resistant and comfortable handles

Locking device safely clipped inside to avoid palm injuries

Lanyard hole

LOPPERS

SUPER
LIGHT

Lightweight, super-strong aluminium for more strength and comfort, with less fatigue.

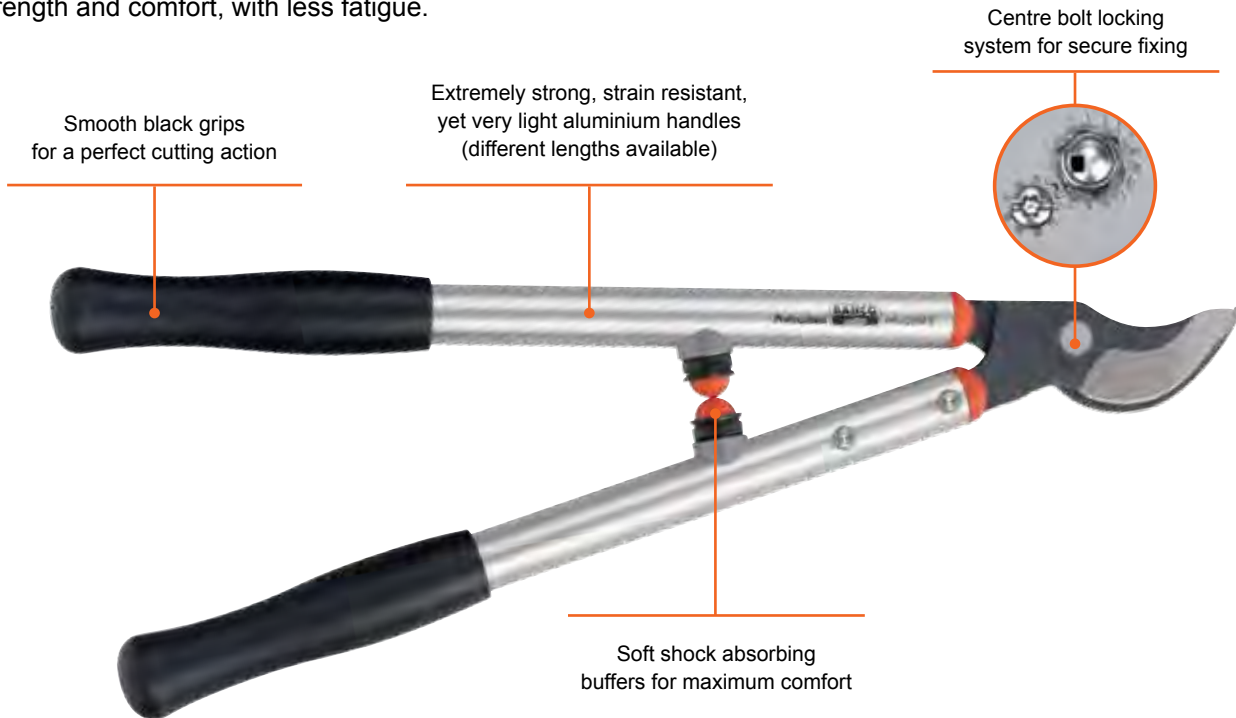

DIFFERENT CUTTING HEADS FOR DIFFERENT APPLICATIONS



P114 STYLE

- Narrow cutting head for pruning in confined spaces
- Main areas of application:
 - Viticulture
 - Pomology with hedge-like cultivation (apple, pear)



P116 STYLE (P116, P19, P16)

- Strongly curved large blade with a deep-hooked counterblade
- Designed for pruning below waist height and near the ground
- Main areas of application:
 - Viticulture
 - Pomology; including soft fruits
 - Landscaping (P19)



The evolving bevel technology is utilized on the P116-SL loppers and reinforces the slicing motion of the blade - an advantage when cutting thick branches.



P160 STYLE

- Narrow blade combined with deep-hooked, thin counter blade
- Well-balanced loppers designed for pruning above shoulder height
- Main areas of application:
 - Pomology
 - Landscaping



P172 STYLE

- Strong blade with anti-friction coating (Xylan®), interchangeable anvil
- Lever-action to facilitate the pruning of mature and dry wood
- Main areas of application:
 - Landscaping
 - Occasionally also used in pomology

HEDGE SHEARS

SUPER **LIGHT**

Lightweight, super-strong aluminium for more strength and comfort with less fatigue.



THREE MAIN TYPES OF SHEAR BLADES

- Large blades with partly serrated edges for hedge trimming on plants with thicker twigs
- Main area of application:
 - Landscape

- Narrow blades with smooth edges for trimming leaves and soft shoots, very clean cut
- Main areas of application:
 - Landscape: topiary
 - Viticulture: leaf pruning

- Wavy blades with smooth edges for pruning hedges and shrubs with a fairly open structure and soft shoots. The waves trap groups of twigs and prevent them from sliding out of the blade
- Main area of application:
 - Landscape



PRUNING SAWS

SAW TEETH PERFORM THREE FUNCTIONS

CUTTING



Teeth tips act like small knives that cut through the wood fibres. Only 0,2 mm (0.008 inch) of a tooth is used for this function, which is done by the sharp ground tip.



SEPARATING



Teeth edges are chisels that shave wood from between the cuts.



CLEARING



Gullets collect saw dust to deposit it outside the kerf. For this an open and smooth ground surface is needed in the gullet.



TOOTH DESIGN



HARDPOINT

Teeth are heat-treated after grinding. Hardened teeth remain sharp four times longer but cannot be re-sharpened with a file.

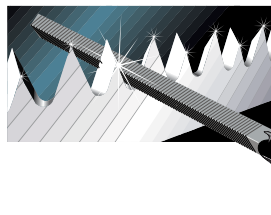

FILEABLE

Teeth can be re-sharpened with Bahco file 4-272.

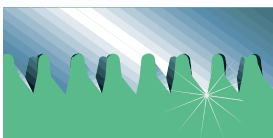

JS-TOOTH

45° cutting angle, wide gullets for removal of wood chips, taper ground blade with non-set tooth design for very fast and aggressive cutting.

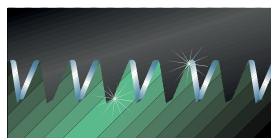

JT-TOOTH

45° cutting angle, triple-grinding, long teeth with narrow gullets, non-set but taper ground blade.

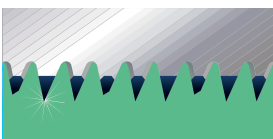

XT-TOOTH

Triangular shape, every third tooth is cut off and set to help with the removal of wood chips from the kerf.

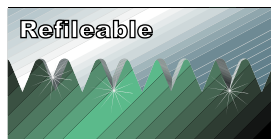

STANDARD TOOTH

Triangular shape, all teeth are set, with hardpoints or re-fileable.

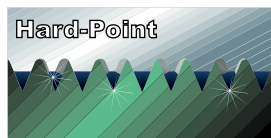

PROFESSIONAL

JS BLADES

Very aggressive tothing for an extremely fast and easy cut for green wood and thick branches.

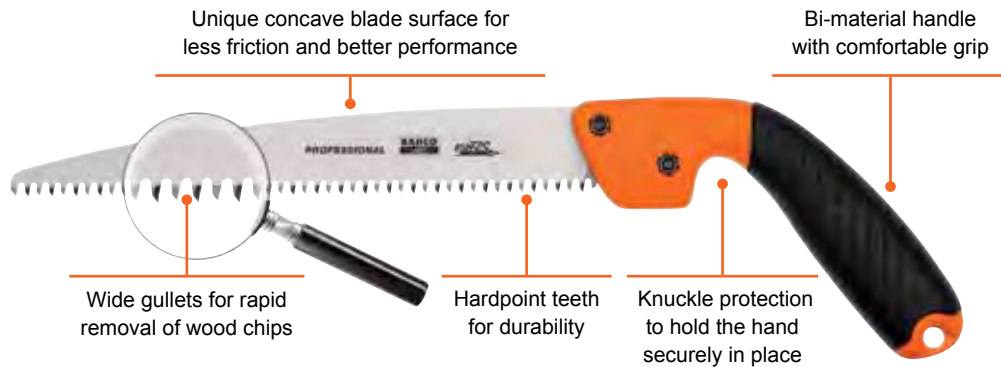

JT BLADES

For clean, fast pruning of live and green wood. Ideal for winter pruning.

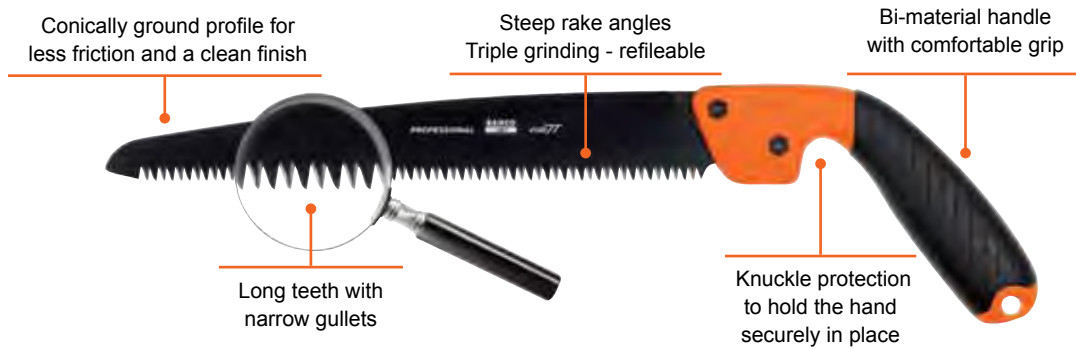

XT BLADES

For pruning all varieties of mature and dry wood.



TRADITION

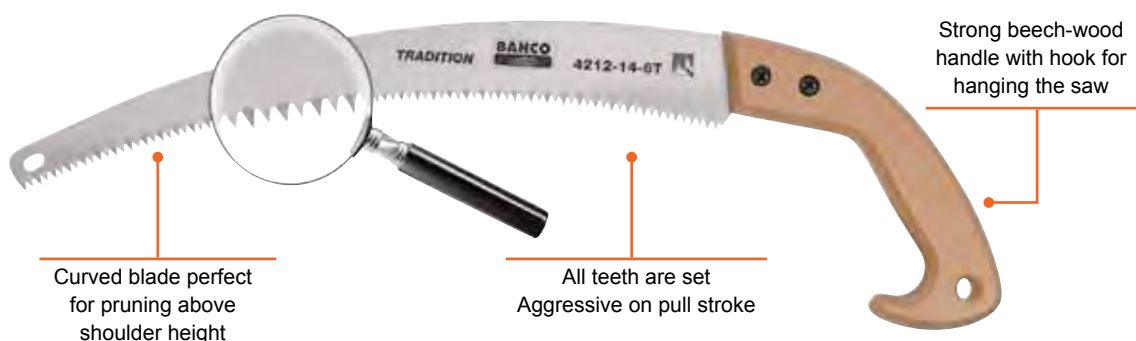



SECATEURS

PX

PROFESSIONAL ERGO™ SECATEURS



- Secateurs developed according to the scientific ERGO™ process
- Shape and size of handles adapted to the size of the hand
- Size of the cutting head adapted to the task to be performed
- Vertical and lateral inclinations of cutting head allow pruning with a straight wrist
- Reduces fatigue and pains and increases comfort and performance
- PX handles made of composite material with soft rubber on upper part
- Available in three sizes: S (small), M (medium) and L (large)
- Three sizes of cutting heads with different cutting capacities available: 1 (15 mm, 1/2"), 2 (20 mm, 3/4") and 3 (30 mm, 1 1/4")
- All cutting heads fit all handles
- PX-M2-L left-handed version

	 731151				 mm	 g
PX-S1	8233785	2	S	1	15	308
PX-S2	8233792	2	S	2	20	296
PX-M1	8233815	2	M	1	15	322
PX-M2	8233822	2	M	2	20	319
PX-M2-L	8240714	2	M	2	20	319
PX-M3	8233839	2	M	3	30	347
PX-L2	8233853	2	L	2	20	331
PX-L3	8233860	2	L	3	30	470

PXR

PROFESSIONAL ERGO™ SECATEURS



- Secateur developed according to the scientific ERGO™ process
- PXR is a PX with a rotating lower handle also covered with soft material
- Rotating handle increases performance, designed for very frequent use
- Available in three sizes: S (small), M (medium) and L (large)
- Three sizes of cutting heads with different cutting capacities available: 1 (15 mm, 1/2"), 2 (20 mm, 3/4") and 3 (30 mm, 1 1/4")
- All cutting heads fit all handles
- PXR-M2-L left-handed version

	 731151				 mm	 g
PXR-S1	8240677	2	S	1	15	366
PXR-S2	8240684	2	S	2	20	377
PXR-M1	8233877	2	M	1	15	382
PXR-M2	8233884	2	M	2	20	394
PXR-M2-L	8240738	2	M	2	20	394
PXR-M3	8233891	2	M	3	30	407
PXR-L2	8233914	2	L	2	20	395



R801P-R804P

ERGO™ SECATEUR SPARE PARTS



- Pre-assembled cutting head for the ERGO™ secateurs PX and PXR
- Supplied with 4 handle screws and inserts (R902P)

	 731151				 g
R801P	8234126	1	PX & PXR	1	126
R802P	8234133	1	PX & PXR	2	129
R803P	8234140	1	PX & PXR	3	139
R804P	8240806	1	PX-L & PXR-L	2	131

R211P/R300P/R500P/R600P

ERGO™ SECATEUR SPARE PARTS



- Spare cutting blades for the ERGO™ secateurs

	 731151			 g
R211P	8234027	1	PX/ PXR N° 2, P1-20, P2-20	60
R211P-BULK80	8252212	80	PX/ PXR N° 2, P1-20, P2-20	4800
R300P	8234034	1	PX/ PXR N° 1	52
R500P	8234041	1	PX/ PXR N° 3	65
R600P	8240783	1	PX-M2-L & PXR-M2-L	60

R303P-R603P

ERGO™ SECATEUR SPARE PARTS



- Spare counter blade for the ERGO™ secateurs

	 731151			 g
R303P	8234157	1	PX-S1, PX-M1, PX-L1, PXR-M1, PXR-L1	63
R403P	8234164	1	PX-S2, PX-M2, PX-L2, PXR-M2, PXR-L2	66
R503P	8234171	1	PX-S3, PX-M3, PX-L3, PXR-M3, PXR-L3	72
R603P	8240790	1	PX-M2-L, PXR-M2-L	66



R811P-RT824P



ERGO™ SECATEUR SPARE PARTS

- Secateur handle developed according to the scientific ERGO™ process
- Spare pair of handles for the ERGO™ secateurs PX and PXR
- Supplied with buffer and medium-strength spring

	 731151			 g
R811P	8234058	1	PX-S	115
R812P	8234065	1	PX-M	122
R813P	8234072	1	PX-L	130
R815P	8240752	1	PX-M2-L	122
RT821P	8242237	1	PXR-S	202
RT822P	8234102	1	PXR-M	203
RT823P	8234119	1	PXR-L	210
RT824P	8240776	1	PXR-M2-L	203

R900P



ERGO™ SECATEUR SPARE PARTS

- Spare centre bolt for the ERGO™ secateurs

	 731151			 g
R900P	8234188	1	PX & PXR	30

R901P



ERGO™ SECATEUR SPARE PARTS

- Spare centre bolt locking system for the ERGO™ secateurs

	 731151			 g
R901P	8234195	1	PX & PXR	13

R902P



ERGO™ SECATEUR SPARE PARTS

- Set with four spare handle screws with inserts
- To join cutting head and handles of the ERGO™ secateurs PX and PXR





	 731151			 g
R902P	8234201	1	PX & PXR	27

R903P/R1269P

ERGO™ SECATEUR SPARE PARTS



- Two spare buffers for all ERGO™ secateurs, P1, P2 and P64 rose secateurs
- R1269P-BULK50 contains 50 buffers

	 731151			
R903P	8234218	1	PX & PXR, P1 & P2, P64	15
R1269P-BULK50	8240820	50	PX & PXR, P1 & P2, P64	486

R904P

ERGO™ SECATEUR SPARE PARTS



- Spare locking device for the ERGO™ secateurs



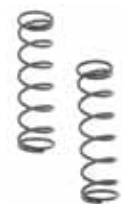

	 731151			
R904P	8234225	1	PX & PXR	15

R905P-R907P

ERGO™ SECATEUR SPARE PARTS



- Pack of two spare springs for the ERGO™ secateurs and P64
- Strength:
R905P low - R906P medium - R907P high









	 731151			
R905P	8234232	1	PX & PXR, P64	20
R905P-BULK50	8252250	50	PX & PXR, P64	164
R906P	8234249	1	PX & PXR	20
R906P-BULK50	8252267	50	PX & PXR	181
R907P	8234256	1	PX & PXR	20

PG-S/M/L

EXPERT SECATEUR



- Secateurs developed according to the scientific ERGO™ process
- Designed for all pruning work in the home garden
- Horizontal and vertical inclination of the cutting head allow the natural alignment of hand and forearm to preserve tendons and nerves from strain
- Xylan® coated blade for easy cutting and soft-grip on upper handle for more comfort
- Narrow cutting head for easy reach
- Handles available in 3 sizes (S, M, L)
- No spare parts available

	 731151				 mm	 mm	
PG-S1-F	8327743	2	S	1	15	175	160
PG-M2-F	8269715	2	M	2	20	200	182
PG-L2-F	8269746	2	L	2	20	210	185



SECATEURS

PG-R-M

EXPERT SECATEUR



- Secateurs developed according to the scientific ERGO™ process
- For all pruning work in the home garden
- Medium size (M2) version with rotating lower handle for frequent use
- No spare parts available

PG-R-M2-F	731151 8269722	2	M	2	20	205	264

PG-03-L

EXPERT SECATEUR

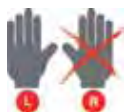

- Secateur especially for left-hand use
- For all pruning work in the home garden
- Xylan® coated blade for rust protection and reduced friction
- Fibreglass reinforced plastic handles
- One-hand locking mechanism
- No spare parts available

PG-03-L	731151 8242855	6	20	200	260

P108

EXPERT SECATEUR



- Secateur designed for pruning grape vines and fruit trees
- Narrow cutting head for easy reach
- Handles made of composite material with a soft grip on the upper handle for comfort and thermal protection
- One-hand locking mechanism at the cutting head

P108-20-F	731151 8275518	2	20	200	305
P108-23-F	8275525	2	25	230	375









P5

EXPERT SECATEUR



- Secateur for general pruning
- Robust design with handles with 2-component sleeves for comfortable grip and thermal protection of hands
- Narrow counter blade gives access to inner branches of dense plants
- One-hand locking mechanism at the cutting head







	 731151		 mm	 mm	 g
P5-20-F	8275273	2	20	210	307
P5-23-F	8275280	2	25	230	366

P3

TRADITION SECATEURS



- Designed for pruning and training of vines
- Large cutting head suitable for general pruning
- Fully hardened steel blade
- Robust design with forged steel handles
- Spare parts available







	 731151		 mm	 mm	 g
P3-20-F	8275259	2	20	200	375
P3-23-F	8275266	2	25	230	440

P110

TRADITION SECATEURS



- Designed for pruning grape vines
- Narrow cutting head for easier access
- Fully hardened steel blade
- Stamped and pressed steel handles
- Spare parts available

	 731151		 mm	 mm	 g
P110-20-F	8275532	2	20	200	315
P110-23-F	8275549	2	25	230	390



SECATEURS

P138

TRADITION SECATEURS



- Anvil secateur for cutting old, hard and dead wood
- Stamped and double bevelled blade, fully hardened
- Tough aluminium anvil
- Stamped and pressed steel handles with wire clasp at the end
- Spare parts available

	 731151		 mm	 mm	 g
P138-22-F	8301279	6	20	220	275

P64

TRADITION SECATEURS



- Light secateur with handles made of composite material for picking roses
- Designed for cut flower production
- Special device on the blade for holding stems after cutting so that flowers do not fall on the ground
- P64-20-BULK12: Display of 12 pcs
- Spring and buffer are available as spare parts

	 731151		 mm	 mm	 g
P64-20	8288174	6	12	210	175
P64-20-BULK12	8288204	12	12	210	2520

P121

TRADITION SECATEURS



- Versatile secateur for various cutting purposes
- Narrow cutting head for easier access
- Robust and traditional design
- Handles made of stamped and pressed steel
- Locking mechanism with wire clasp at the end of handle
- No spare parts available

	 731151		 mm	 mm	 g
P121-18-F	8275662	6	15	180	225
P121-20-F	8275631	6	20	200	255
P121-23-F	8275648	6	25	230	330



P126

TRADITION SECATEURS



- Traditional and robust design for general purpose gardening
- Handles made of stamped and pressed steel
- Locking mechanism with wire clasp at the end of handle
- No spare parts available

	 731151		 mm	 mm	 g
P126-19-F	8275297	6	15	190	245
P126-22-F	8275303	6	20	220	310

PG-10-F

TRADITION SECATEURS



- Designed for leisure gardening work
- Precision ground blade with a slicing cut action for a clean cut in green stems and living wood
- No spare parts available

	 731151		 mm	 mm	 g
PG-10-F	8275327	6	20	210	135

PG-12

TRADITION SECATEURS



- Secateur with narrow cutting head for cutting flowers, herbs and shrubs
- Carbon steel blade and lightweight composite handles
- No spare parts available

	 731151		 mm	 mm	 g
PG-12-F	8328122	6	20	210	165

R221P

TRADITION SECATEUR SPARE PARTS



- Easy to replace tough aluminium anvil including rivet

	 731151			 g
R221P	8229412	1	P138-22	27
R221P-BULK50	8240653	50	P138-22	1350



R201P/R171P

TRADITION SECATEUR SPARE PARTS



- Spare cutting blades for P1-22 and P2-22 and left-handed P6 and P7

	 731151			 g
R201P	8219536	1	P1-22, P2-22	54
R201P-BULK80	8225209	80	P1-22, P2-22	4320
R171P	8226534	1	P6-20, P7-20	59

R112PG-R124PG/R223P

TRADITION SECATEUR SPARE PARTS



- Spare cutting blade for hand and top-pruners

	 731151			 g
R112PG	8010058	1	P3-20, P5-20	42
R114PG	8010065	1	P108-20, P110-20	40
R122PG	8010072	1	P3-23, P5-23	46
R124PG	8010089	1	P108-23, P110-23, P34-27A	48
R223P	8237554	1	P138-22	37
R223P-BULK80	8240646	80	P138-22	2960

R202P/R271P

TRADITION SECATEUR SPARE PARTS



- Spare counter blades for hand-pruners P1-22, P2-22 and left-handed P6 and P7

	 731151			 g
R202P	8219550	1	P1-22, P2-22	76
R271P	8226541	1	P6-20, P7-20	66

R239P/R141P/R142P

TRADITION SECATEUR SPARE PARTS



- Complete sets comprising spare centre bolt, nut and washer(s) for hand-pruners

	 731151			 g
R239P	8219567	1	P1-20, P1-22, P2-20, P2-22, P6-20, P7-20	32
R141P	8288235	1	P64-20	27
R142P	8010126	1	P34-27A, P3-20, P3-23, P5-20, P5-23, P108-20, P108-23, P110-20, P110-23	35



R113PG/R123PG

TRADITION SECATEUR SPARE PARTS



- Spare counter blade and pin for hand-pruners

	 731151			 g
R113PG	8044374	1	P108-20, P110-20	48
R123PG	8044381	1	P108-23, P110-23	50

R341P/R474P

TRADITION SECATEUR SPARE PARTS



- Spare closing springs or wire clasps

	 731151			 g
R341P	8011529	1	P3-20, P3-23	32
R474P	8011536	1	P5-20, P5-23, P108-20, P108-23, P110-20, P110-23	16

R438P/R463P

TRADITION SECATEUR SPARE PARTS



- Spare springs for one-hand pruners

	 731151			 g
R463P	8223908	1	P121-23	21
R438P	8229429	1	P138-22	27
R438P-BULK50	8240660	50	P138-22	1350

R1069P

TRADITION SECATEUR SPARE PARTS



- Spare spring and buffer for one-hand pruners

	 731151			 g
R1069P	8219574	1	P1-20, P2-20, P6-20, P7-20	20



R1068

TRADITION SECATEUR SPARE PARTS



- Spare spring, buffers and light metal buffer cup for one-hand pruners

	 731151			 g
R1068	8044398	1	P3-20, P3-23, P5-20, P5-23, P108-20, P108-23, P110-20, P110-23	32

R1080P

TRADITION SECATEUR SPARE PARTS



- Spare part kit for the re-designed secateur P5-20 and P5-23 with 2-component handles
- Contains one spring and a pair of buffers

	 731151			 g
R1080P	8282479	1	P5-20, P5-23	22

R1601

TRADITION SECATEUR SPARE PARTS



- Set of spare handle screws, nuts and closing button with flat spring for one-hand pruners

	 731151			 g
R1601	8044640	1	P1-20, P1-22, P2-20, P6-20, P7-20	28

R478P/R480P

TRADITION SECATEUR SPARE PARTS



- Locking device with screw and nut for P108 (R478P) and P5 (R480P)







	 731151			 g
R478P	8275600	1	P108	14
R480P	8282486	1	P5	14

P123

SNIPS



- Snip for harvesting grapes and other fruits as well as flowers and some vegetables
- Long and fine bypass cutting head with an opening of 40 mm
- Handles made of fibreglass reinforced material
- Snips in BULK15 & BULK30 are supplied with holster
- Snips in BULK56 are supplied without holster







	 731151		 mm	 L mm	 g
P123-19-BULK15	8226251	15	10	190	87
P123-19-BULK30	8218218	30	10	190	87
P123-19-BULK56	8240202	56	10	190	87

P127

SNIPS



- Snip for harvesting and florist work
- Can cut thin wires
- Short and robust blade with straight edge and serrated counter blade to avoid hard stems slipping out
- Opening of blades limited to 20 mm
- Supplied with lightweight plastic holster, 30 pcs in a box







	 731151		 mm	 L mm	 g
P127-19-BULK30	8199333	30	6	170	70

P128

SNIPS



- Lightweight snips for grape harvesting
- Also recommended for thinning out apple fruit to encourage a better growth
- Long and fine cutting head with a good opening of 35 mm
- Fibreglass reinforced plastic handles
- Supplied with lightweight plastic holster (P128-19-BULK30), 30 pcs in a box. P128-19 is supplied on card

	 731151		 mm	 L mm	 g
P128-19	8160814	6	6	190	85
P128-19-BULK30	8172329	30	6	190	85



SNIPS

P129

SNIPS



- Handy and lightweight grape harvesting snip
- Used for cutting fruit stems and cleaning out fruit bunches
- Long and slim blades are slightly bent (11°) to facilitate access to hidden stems
- Opening of 35 mm. Fibreglass reinforced plastic handles
- Supplied with lightweight plastic holster, 30 pcs in a box

	 731151		 mm	 L mm	 g
P129-19-BULK30	8172336	30	6	190	85

R1071/R1075

SNIPS SPARE PARTS



- Spare springs with buffers

	 731151			 g
R1071	8222918	1	P123-19, P127-19, P128-19, P129-19	30
R1075-BULK50	8220495	50	P123, P127, P128, P129	130



9320

PROFESSIONAL ELECTRIC SECATEUR



- Designed for professional users in viticulture, horticulture and forestry
- Secateur driven by an electric motor (90 W)
- Power supplied by rechargeable nickel-metalhydrite batteries (2 x 24 V)
- Servo-progressive cutting program for full control of blade movement
- Comfortable and handy due to its shape and the position of the triggers
- Adjustable back pack for batteries with soft shoulder straps for maximum comfort
- High cutting speed, low energy consumption

9320	731151 8292126	1	30 mm	320 mm	3470 Kg	Ni MH	3.5 Ah	945 g

9210

PROFESSIONAL PNEUMATIC SECATEUR



- Powerful but light tool
- Designed for pruning all kinds of fruit trees and for landscaping work
- Body made of acetalic resin (POM)
- Single piston with a spring return
- Cutting head with excellent slicing cut
- Centre bolt locking system
- Special ice-free valve protects the tool against condensation water freezing inside the tool in cold weather
- Connecting thread requires a 1/4" male coupler for the air hose

					BAR		
9210	731151 8278182	1	30 mm	255 mm	10	80 l/min	700 g

9210-1

PNEUMATIC SECATEUR SPARE PARTS



- Cutting blade and rivet for pneumatic secateur 9210

9210-1	731151 8278212	1	9210	82 g



9210-10

PNEUMATIC SECATEUR SPARE PARTS



- Complete, pre-assembled cutting head for pneumatic secateur 9210 (includes rivet)

9210-10	8278229	1	9210	212

9210-20

PNEUMATIC SECATEUR SPARE PARTS



- Pack of assorted O-rings for pneumatic secateur 9210

9210-20	8278236	1	9210	28

9210-1720100

PNEUMATIC SECATEUR SPARE PARTS



- Brass sleeve (10 pcs) for pneumatic secateur 9210

9210-1720100	8295295	1	9210	55.3

9210-1230235

PNEUMATIC SECATEUR SPARE PARTS



- Piston seal for pneumatic secateur 9210

9210-1230235	8295325	1	9210	6.7

9210-1690148

PNEUMATIC SECATEUR SPARE PARTS



- Piston disc for pneumatic secateur 9210

9210-1690148	8295332	1	9210	22



9210-1730107

PNEUMATIC SECATEUR SPARE PARTS



- Shock absorber for pneumatic secateur 9210

9210-1730107	731151 8295349	10	9210	176

9210-1640142

PNEUMATIC SECATEUR SPARE PARTS

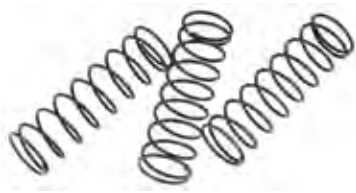

- Return spring for pneumatic secateur 9210

9210-1640142	731151 8295356	1	9210	26.6

9210-1700118

PNEUMATIC SECATEUR SPARE PARTS



- Connecting rod for pneumatic secateur 9210

9210-1700118	731151 8295363	1	9210	41

9210-1770106

PNEUMATIC SECATEUR SPARE PARTS



- Special rivet to join blade and connecting rod, Ø 6 mm
- For pneumatic secateur 9210

9210-1770106	731151 8295370	40	9210	1000

9210-1230219

PNEUMATIC SECATEUR SPARE PARTS



- Dust protection seal for pneumatic secateur 9210

9210-1230219	731151 8295387	1	9210	8.6



9210-1060238

PNEUMATIC SECATEUR



- Self tapping screws, TSP 2.2 x 6.5 for pneumatic secateur 9210
- For fixing front cover 9210-1830137

9210-1060238	731151 8295394	20	9210	10

9210-1830137

PNEUMATIC SECATEUR SPARE PARTS



- Front cover for pneumatic secateur 9210

9210-1830137	731151 8295400	1	9210	9.5

9210-1710266

PNEUMATIC SECATEUR SPARE PARTS



- Secateur body with brass cylinder inside for pneumatic secateur 9210

9210-1710266	731151 8295417	1	9210	193

9210-1060177

PNEUMATIC SECATEUR SPARE PARTS



- Screws, TCCE M6 x 20 UNI 5931, for pneumatic secateur 9210

9210-1060177	731151 8295424	1	9210	7

9210-1320281

PNEUMATIC SECATEUR SPARE PARTS



- Hand guard for pneumatic secateur 9210

9210-1320281	731151 8295431	1	9210	35



P114-SL

PROFESSIONAL LOPPERS



- Light lopper designed for pruning soft and green wood mainly in vineyards and orchards
- Narrow cutting head for easy access and quick, precise cuts
- Professional blade material and grinding for highest performance
- Lightweight aluminum handles with in-tube assembled blade and counter blade for easy maintenance

	 731151		 mm	 mm	 g
P114-SL-40	8301149	2	30	400	630
P114-SL-50	8301156	2	30	500	682
P114-SL-60	8301163	2	30	600	826

P116-SL

PROFESSIONAL LOPPERS



- Light lopper designed for use in vineyards, orchards and for landscaping activities
- Professional blade design with an evolving bevel for an easy cut in tough wood
- Excellent cutting performance in all types of wood
- Lightweight aluminium handles with in-tube assembled blade and counter blade for easy maintenance

	 731151		 mm	 mm	 g
P116-SL-40	8301101	2	30	400	687
P116-SL-50	8301118	2	30	500	735
P116-SL-60	8301125	2	30	600	879
P116-SL-70	8301132	2	30	700	964

P160-SL

PROFESSIONAL LOPPERS



- Special-design orchard lopper, also recommended for landscaping
- Slim, narrow blade combined with hooked counter blade for a powerful but smooth and easy cut
- Forged counter blade to stand the stress of intensive use
- Light aluminium handles with long reach for overhead cutting

	 731151		 mm	 mm	 g
P160-SL-60	8301170	2	45	600	960
P160-SL-75	8301187	1	45	750	1090
P160-SL-90	8301194	1	45	900	1160



LOPPERS

P19

PROFESSIONAL LOPPERS



- Heavy-duty bypass lopper for cutting very thick and strong branches on mature trees and vines
- Long reach, also for overhead cutting
- Cutting head with fully hardened blade for powerful cuts and smooth finish
- Very comfortable to use due to integrated shock absorbing rubber buffers between the handles
- Aluminium tube handles for easy handling

P19-80-F	8275365	1	50	800	1790

P280-SL

PROFESSIONAL LOPPERS



- Heavy duty bypass lopper with lever action
- Fully hardened steel blades with Xylan® coating for less friction
- Cutting head with sliding lever action for 50% more force and a large cutting capacity of 40 mm
- Lightweight aluminium handles for long reach

P280-SL-80	8301330	2	40	800	1318

P172-SL

PROFESSIONAL LOPPERS



- Heavy duty anvil lopper for cutting hard and dry wood
- Cutting head with sliding lever action for 50% more force and a large cutting capacity of up to 40 mm
- Blade with Xylan® coating to reduce friction
- Lightweight aluminium handles with comfortable grips

P172-SL-85	8301200	1	40	850	1220



PG-18

EXPERT LOPPERS



- Lightweight lopper with aluminium handles
- For pruning trees and shrubs in gardens
- Comfortable 2-component grips and shock absorbing buffers
- Hardened steel blade for a high cutting performance
- Available in two lengths: 60 cm and 75 cm

	 731151		 mm	 L mm	 g
PG-18-60-F	8288853	2	40	610	785
PG-18-75-F	8288877	2	40	750	925

PG-18-45

EXPERT LOPPERS



- Lightweight lopper with aluminium handles for pruning shrubs and small trees
- Shock absorbing buffers and 2-component handles for added comfort
- Narrow blade with big cutting capacity for a high performance

	 731151		 mm	 L mm	 g
PG-18-45-F	8299033	2	40	450	545

PG-19

EXPERT LOPPERS



- Telescopic lopper with handles made of silver aluminium tubes, extendable from 70-90 cm
- For pruning high trees with thick branches
- Blade with slicing cut is made of high grade steel, fully hardened
- Special locking system locks/unlocks with just a quarter-turn
- Comfortable 2-component grips made of orange polypropylene and soft black thermoplastic elastomer

	 731151		 mm	 L mm	 g
PG-19-F	8295936	2	40	700 - 900	1135



LOPPERS

PG-17

EXPERT LOPPERS



- Telescopic anvil lopper for pruning high branches from 70 to 90 cm
- Blade made of high grade steel, fully hardened and with anti-friction coating
- Handles with special one-way locking system, locks/unlocks with just a quarter-turn
- Comfortable 2-component grips

PG-17-F	731151 8324629	2	30	700 - 900	1120

P16

TRADITION LOPPERS



- Bypass lopper for pruning and training grape vines and fruit trees
- Strongly curved blade with slicing cut for quick and powerful cuts
- Comfortable to use with soft rubber buffers to prevent fatigue
- Very robust, forged counter blade
- Spare parts available

P16-50-F	731151 8301286	2	30	500	935
P16-60-F	8276461	2	30	600	1025

P140

TRADITION LOPPERS



- Bypass lopper for pruning trees and shrubs in the home garden
- Curved blade with slicing cut for easy cutting, integrated plastic buffers
- No spare parts available

P140-F	731151 8275372	2	35	600	1010



PG-20

TRADITION LOPPERS



- Bypass lopper with a compact design to prune in difficult-to-reach places
- Oval steel tube handles with comfortable plastic grip and buffers for added comfort in use
- Small cutting head, ideal for pruning ornamental shrubs and rose bushes
- No spare parts available

	 731151		 mm	 L mm	 g
PG-20-F	8275396	2	30	440	665
PG-20-60-F	8275419	2	30	570	780

PG-22

TRADITION LOPPERS



- Loppers with a robust cutting head for pruning shrubs and small trees
- Handles made of steel tubes with plastic grips
- Cutting head made of hardened and tempered carbon steel
- No spare parts available

	 731151		 mm	 L mm	 g
PG-22-45-F	8328351	6	25	450	715
PG-22-65-F	8328153	6	25	650	1085

R114V-R180V/R16V/R160A/
R172A

LOPPERS SPARE PARTS



- Spare cutting blades for loppers

	 731151			 g
R114V	8042660	1	P14	140
R114V-BULK28	8177539	28	P14	3920
R16V	8254513	1	P-SL2, P116-SL	170
R16V-BULK14	8288334	14	P-SL2, P116-SL	2380
R115V	8243210	1	P-SL, P114-SL	145
R115V-BULK14	8288341	14	P-SL, P114-SL	2030
R172A	8235413	1	P172-85, P172-65	158
R380A	8000066	1	P172-SL-85	170
R116VP	8042721	1	P16-40W	150
R116V	8010164	1	P16	157
R116V-BULK36	8159924	36	P16	5652
R119V	8029487	1	P19-80	370
R160A	8201821	1	P160	167
R180V	8042677	1	P180-70	292







LOPPERS

R214V/R26V/R260A/...

LOPPERS SPARE PARTS



- Spare counter blades for loppers
- *P16 with centre bolt locking system R901P





	 731151			
R214V	8042745	1	P14	155
R214V-BULK28	8177553	28	P14	4340
R26V	8254520	1	P-SL2-40/50/60	200
R216SL	8301408	1	P116-SL	190
R215V	8243227	1	P-SL-40/45/60	142
R214SL	8301392	1	P114-SL	155
R260A	8201814	1	P160	233
R716VCB	8255497	1	P16*	215
R680V	8042752	1	P180-70	205
R619V	8029494	1	P19-80	390

R430V-R516V

LOPPERS SPARE PARTS



- Spare buffers for loppers and hedge shears
- Different grades of hardness available





	 731151			
R430V	8243265	1	P-SL, P-SL2, P114, P116 - all 40 cm	18
R440V	8254544	1	P-SL, P-SL2, P114, P116, P52-SL, P54-SL	18
R515VS	8046514	1	P14, P16, P180-70, P19-80, P160-60, P51	20
R516V	8200824	1	P160-75, P160-90, P51H, P280, P51H	20

R372H

LOPPERS SPARE PARTS



- Spare anvil with screws for loppers

	 731151			
R372H	8235406	1	P172-65 /-85, P172-SL	39



**R312V-R318V/R143PV/
R144PV/R146**



LOPPERS SPARE PARTS

- Centre bolt kit comprising nut, bolt and washers
- For *P16 loppers with centre bolt locking system R901P

	 731151			 g
R143PV	8010133	1	P16	33
R143PV-BULK50	8240837	50	P16	1650
R143PVCB	8255633	1	P16*	33
R144PV	8291075	1	P160	34
R146VS	8046538	1	P14, P174, P176-75	34
R146VS-BULK50	8159955	50	P14, P174, P176-75	1700
R166V	8328085	1	P114-SL, P116-SL	60
R312V	8235420	1	P172-65 /-85	31
R315V	8243234	1	P-SL-40 /-45 /-60	60
R328V	8296056	1	P280-(SL)	32
R318V	8029500	1	P180-70, P19-80, P172	64

R415V-R773V



R415V - R660V

LOPPERS SPARE PARTS

- Complete set (4) bolt/nut for loppers

	 731151			 g
R415V	8243241	1	P-SL, P-SL2, P114, P116	29
R419V	8042936	1	P180-70	52
R519V	8029517	1	P19-80	52
R615V	8010119	1	P14, P16	28
R660V	8210281	1	P160	30
R772V	8301385	1	P172-SL	30
R773V	8324414	1	P280-SL-80	32

R272H



LOPPERS SPARE PARTS

- Hexagonal screw for adjusting the blade to the anvil after wear

	 731151			 g
R272H	8258016	1	P172-65/-85, P172-SL-85	15



POLES AND TOP-PRUNERS

P34-37

TRADITION TOP-PRUNERS



- Top-pruner with fully hardened, double bevelled blade
- Stamped, fully hardened counter blade
- Sap groove to prevent blade from sticking
- Triple lever action to reduce the amount of effort required
- Adjustable clamp fits Ø 25 mm (1") to 35 mm (1 3/8") poles
- Supplied with a 5 m rope with handle
- A pruning saw blade can be mounted on this top pruner
- Spare parts available

P34-37	731151 8002787	2	40	1260

P34-27A

TRADITION TOP-PRUNERS



- Lightweight top pruner with fully hardened blade
- Stamped, fully hardened counter blade with sap groove to prevent sticking
- Double lever action
- Steel clamp secured with screws
- Fits Ø 25 mm (1") poles
- Supplied with a 5 m rope

P34-27A-F	731151 8275464	2	30	610

AP-234

TRADITION TOP-PRUNERS



- Top-pruner for pruning and clearing out
- Clearing out: Hook the cutting head over the branch and pull the pole towards to you
- Pruning: Hook the cutting head on the branch and pull the rope down with the orange handle
- Fully hardened steel blade with slicing action for neat and efficient cut
- Long aluminum pole for difficult to reach branches
- Grip on aluminum tube for added comfort

AP-234-F	731151 8289027	2	30	2200	1520



R127E/R137E

TOP-PRUNERS, SPARE PARTS



- Spare cutting blades for top-pruners
- 30 units per box

	 731151			
R127E	8011567	1	P34-27	56
R137E	8011574	1	P34-37	56

R142P/R337E

TOP-PRUNERS, SPARE PARTS



R142P

- Spare centre bolt and nut R142P for P34-27AR337E for P34-37

	 731151			
R142P	8010126	1	P34-27A, P3-20, P3-23, P5-20, P5-23, P108-20, P108-23, P110-20, P110-23	35
R337E	8011598	1	P34-37	56

R124PG

TOP-PRUNERS, SPARE PARTS



- Spare cutting blade with pin for hand and top-pruners

	 731151			
R124PG	8010089	1	P108-23, P110-23, P34-27A	48

R133PG

TOP-PRUNERS, SPARE PARTS



- Spare counter blade with pin for top-pruners

	 731151			
R133PG	8328252	1	P34-27A	50



POLES AND TOP-PRUNERS

R427AE/R427E/R437E

TOP-PRUNERS, SPARE PARTS



- Spare spring for top-pruners. *R427E for old model of P34-27A

	 731151			
R427AE	8176068	1	P134, P34-27A	45
R427E	8011604	1	*P34-27A	40
R437E	8011611	1	P34-37	64

AP-/FP-

TRADITION POLES



- Extension pole for work in difficult-to-reach areas up to 5 m
- Made of aluminium or fibreglass
- Top diameter 25 mm (1")
- Supplied with a bolt and wing nut
- Fits all top-pruners (P34-37, P34-27A) suitable for all Bahco top-pruners and pole saws (339-6T, 340-6T, 383-6T, 384-6T, 384-5T, 385-6T, 386-6T)
- AP-5M: Aluminium pole, 2 piece fibreglass pole
- AP-3M: Aluminium pole, 1 piece fibreglass pole
- FP-3M: Fibreglass pole, 1 piece fibreglass pole

	 731151			
AP-5M	8152079	1	2000 - 5000	1600
AP-3M	8152062	1	2000 - 3500	1000
FP-3M	8168612	1	1800 - 3200	1000

LOCKING

TELESCOPIC EXTENSION POLE, SPARE PARTS



- Spare parts for the locking-system of aluminium telescopic extension poles
- Locking-S for Ø 25 mm extension tube
- Locking-B for the Ø 28 mm extension tube
- R2000AP is the eccentric screw supplied with 2 different adapters for AP-3M and both sections of AP-5M



	 731151		
LOCKING-B	8222406	1	30
LOCKING-S	8222390	1	25
R2000AP	8301088	8	101



P51-SL

PROFESSIONAL HEDGE SHEARS



- High-quality shears for professional use in parks, topiary gardens and nurseries
- Fully hardened blades
- Partly serrated edge for cutting up to 10 mm (1/2") thick branches
- Lightweight aluminium handles with smooth plastic grips
- Reduced fatigue through superior cutting performance and very comfortable handling

	 731151		 L mm	 g
P51-SL	8301217	2	570	990

P51H-SL

PROFESSIONAL HEDGE SHEARS



- High-quality shears for professional use in parks, topiary gardens and nurseries
- Fully hardened blades
- Partly serrated edge for cutting up to 10 mm (1/2") thick branches
- Extra long, lightweight aluminium handles for a good reach
- Reduced fatigue through superior cutting performance and very comfortable handling

	 731151		 L mm	 g
P51H-SL	8301224	2	730	1076

P54-SL

PROFESSIONAL HEDGE SHEARS



- High quality shears with short handles (26 cm) for professional use in parks, nurseries and vineyards
- Compact design and angled form, ideal for topiary and leaf pruning
- Slim, straight blades, available in 20 and 25 cm, giving a clean cut especially important when clipping topiary
- Lightweight aluminium handles with comfortable plastic grip and soft buffers reduce fatigue

	 731151		 L mm	 g
P54-SL-20	8301248	2	500	742
P54-SL-25	8301231	2	550	813



HEDGE SHEARS

P54H-SL



PROFESSIONAL HEDGE SHEARS

- High quality shears with long handles (36 cm) for professional use in parks, nurseries and vineyards
- Compact design and angled form, ideal for topiary and leaf pruning
- Slim, straight blades, available in 20 and 25 cm, giving a clean cut especially important when clipping topiary
- Lightweight aluminum handles with comfortable plastic grip and soft buffers to reduce fatigue

	 731151		 L mm	 g
P54H-SL-20	8301262	2	600	787
P54H-SL-25	8301255	2	650	871

PG-56



EXPERT HEDGE SHEARS

- Lightweight hedge shears for trimming all kinds of hedges
- Fully hardened steel blades
- Aluminium handles with 2-component grips
- Shock absorbing buffers for added comfort

	 731151		 L mm	 g
PG-56-F	8288938	2	560	850

PG-57-F



EXPERT HEDGE SHEARS

- Very light telescopic hedge shear, extendable from 790 to 1040 mm for long reach
- Special locking system locks/unlocks with just a quarter-turn
- Fully hardened steel blades
- Handles made of aluminium tubes with 2-component grips
- Rubber buffer for additional comfort

	 731151		 L mm	 g
PG-57-F	8295943	2	790 - 1040	1345



P51

TRADITION HEDGE SHEARS



- Hedge shears for intensive professional use in parks, vineyards and nurseries
- Fully hardened blades
- Partly serrated edge for cutting up to 10 mm (1/2") thick branches
- Superior cutting performance and comfortable handling
- Spare parts available

	 731151		 L mm	 g
P51-F	8275426	2	570	1085

P57-25

TRADITION HEDGE SHEARS



- Traditional hedge shears for all hedge types
- Comfortable wooden handles
- Stamped and fully hardened blade
P57-25 with straight blade and partly serrated edge to cut branches up to 10 mm (1/2")
P57-25-W with wavy blade, for cutting soft twigs and stems that tend to slip out when closing the blades
- Spare parts available

	 731151		 L mm	 g
P57-25-F	8301293	4	540	1020
P57-25-W-F	8301309	4	540	1020

P59

TRADITION HEDGE SHEARS



- Universal hedge shear for all hedge types
- For frequent hedge trimming in gardens
- Simple and reliable design with stamped and fully hardened blade
- No spare parts available

	 731151		 L mm	 g
P59-25-F	8275655	5	660	1115



HEDGE SHEARS

PG-51

TRADITION HEDGE SHEARS



- Universal hedge shears for leisure gardening
- Handles made of robust steel tubes
- Stamped fully hardened blades for durability
- Shock absorbing plastic buffers for added comfort



PG-51-F

8275440

5

510

715

PG-32

TRADITION HEDGE SHEARS



- Hedge shears with narrow straight blade for hedge trimming
- Blades made of carbon steel and handles made of steel tubes with plastic grips
- No spare parts available



PG-32-F

8328146

6

505

755

R440V-R516V

SPARE PARTS FOR HEDGE SHEARS



- Spare buffers for professional hedge shears with broad blade:
 - Soft R515VS for shears with short handles
 - Hard R516V for shears with long handles
- Spare buffers for super light hedge shears:
 - Soft R440V for shears with short handles
 - Hard R444V for shears with long handles



R515VS

8046514

1

P14, P16, P180-70, P19-80, P160-60, P51

20

R516V

8200824

1

P160-75, P160-90, P51H, P280, P51H

20

R440V

8254544

1

P-SL, P-SL2, P114, P116, P52-SL, P54-SL

18

R444V

8243340

1

P53-SL, P54H-SL

18

R146VC/R147V

SPARE PARTS FOR HEDGE SHEARS



- Complete spare set, comprising nut, bolt and washers, VC includes locking ring



R146VC

8046545

1

P51, P51H, P52, P53, P54

34

R147V

8044909

1

P55, P57

30



GS-180

EXPERT GRASS SHEARS



- Single handed grass shear with stainless steel blades carefully set for self-grinding during use
- Rotating head (90° left & right) for lawn edging
- Swivels easily into different positions to facilitate the cut in certain slopes
- Soft touch and non-slip grip on upper handle for maximum comfort
- Lower handle loop for finger protection
- No spare parts available

	 731151		 L mm	 g
GS-180-F	8275488	6	375	317

GS-76

TRADITION GRASS SHEARS



- Grass shear with hardened blades, carefully set for self-grinding during use to ensure a good cutting edge
- Precise spring mechanism ensures that the blades are kept aligned in use on grass
- Lever mechanism designed for minimum effort in operating the shears
- Three different cutting head positions to gain access to difficult-to-reach corners and edges which need trimming
- Blades are solely made to cut grass
- No spare parts available

	 731151		 L mm	 g
GS-76	8010782	6	355	435

P74

TRADITION GRASS SHEARS



- Lawn shear for cutting in difficult-to-reach places where lawn mowers cannot gain access
- Suitable for cutting in shrubs, borders, around trees etc.
- 90 cm long handles of round steel tubes, fitted with black plastic covers
- Cutting head with horizontal oriented blades, also known as duck's foot
- Stamped, fully hardened, double bevelled blade with black Xylan® coating, straight cutting edge, length 20 cm
- Stamped, flat-edged, fully hardened counter blade, black Xylan® coating
- Plastic buffer to reduce jarring

	 731151		 L mm	 g
P74	8124076	1	1100	2000



GRASS SHEARS

P75

TRADITION GRASS SHEARS



- Lawn edge shear for trimming borders
- 90 cm long handles of round steel tubes, fitted with black plastic covers
- Stamped, fully hardened, double bevelled blade with black Xylan® coating, straight cutting edge, length 20 cm
- Stamped, flat-edged, fully hardened counter blade, black Xylan® coating
- Plastic buffer to reduce jarring



P75



731151

8124083



1



1000



1900

P11

PROFESSIONAL KNIVES



- High-quality grafting knife for razor-sharp cutting of the graft and bark
- Spatula with round edges for lifting of the bark for the graft insertion
- Extremely sharp folding blade, folding brass spatula and plastic covered for comfortable grip



P11



731151

8009076



6



180



70



PRUNING KNIVES

P20

PROFESSIONAL KNIVES



- High-quality pruning knife for pruning of very delicate trees such as peaches
- Also for pruning young trees in the nursery and for thinning out fruit bunches
- Special hook design of the folding blade and plastic covered for comfortable grip



P20



731151

8009281



6



200



100



FS-5

EXPERT SCISSORS



- Floral scissors ideal for pruning delicate plants
- For deadheading and clearing out of dry leaves, for pruning and harvesting herbs and for creating floral decoration
- Short pointed blades made of stainless steel, with micro serration for cutting soft stems of small diameter
- Finger loops with soft touch material

	 731151		 L mm	 g
FS-5	8266455	10	125	24

FS-8

EXPERT SCISSORS



- Floral scissors designed for cutting soft stems of small diameter, ribbons, any kind of paper, thin cardboard and tissues used in floral decoration
- Also useful for pruning indoor plants, for deadheading in difficult to reach places
- Long straight blades made of stainless steel with micro serration
- Finger loops with soft touch material

	 731151		 L mm	 g
FS-8	8266462	10	165	47

FS-7.5

EXPERT SCISSORS



- Floral scissors with large finger loops
- Compact strong blades with serration, designed for all kinds of flower stems and twigs as well as ribbons, cardboard and even soft wire
- Could also be used for pruning small shrubs on the balcony and indoor plants
- Finger loops with soft touch material

	 731151		 L mm	 g
FS-7.5	8266479	10	200	108



PRUNING SAWS

51 -JS



-JS RANGE

- Sword saw especially designed for landscaping
- JS tothing developed for pruning living wood
- Extremely sharp and very aggressive tothing for fastest cut
- Non-set teeth with hardpoint, taper ground blade for perfect clean finish
- Comfortable, non-fatigue 2-component handle
- Available in two different lengths, both equipped with holster
- Replacement blades available

	 731151		 mm	 T _{1/2} "	 g
5124-JS-H	8219352	4	240	5	280
5128-JS-H	8219369	4	280	5	300

396-JS



-JS RANGE

- Foldable pruning saw with JS tothing designed for fruit growing, wine growing and landscaping
- Blade with hardpoint teeth and extra wide gullet for faster cutting in thicker green branches
- Strong 2-component plastic handle with comfortable grip
- Safety lock both in opened and closed position
- Replacement blade available

	 731151		 mm	 inch	 T _{1/2} "	 g
396-JS	8223250	4	190	7 1/2	5	200

41 -JT



-JS RANGE

- Sword saw especially designed for wine and fruit growing
- JT blade with aggressive teeth designed for winter pruning
- Non-set teeth, refilable, for a smooth cutting surface
- Comfortable, non-fatigue 2-component handle
- Available in two different lengths, both equipped with holster
- Replacement blades available

	 731151		 mm	 T _{1/2} "	 g
4124-JT-H	8267803	4	240	7	340
4128-JT-H	8267810	4	280	7	356



396-JT

-JS RANGE



- Foldable pruning saw designed for occasional use in vineyards and orchards
- JT toothting for pruning living wood in winter with a fast and clean cut
- Strong 2-component plastic handle with comfortable grip
- Safety lock in both open and closed position
- Replacement blade available

	 731151		 mm	 inch		 g
396-JT	8168056	4	190	7 1/2	7	200

396-HP

-JS RANGE



- Foldable pruning saw with special patented XT7 toothting for a fast cut in hard or dry wood
- Multipurpose saw with hardpoint teeth, performing well in living wood
- Strong 2-component plastic handle with comfortable grip
- Safety lock both in opened and closed position
- Replacement blade available

	 731151		 mm	 inch		 g
396-HP	8152284	4	190	7 1/2	7	200

349

EXPERT PRUNING SAWS



- Pruning saw for home owners
- For pruning ornamental shrubs and fruit trees in the garden
- Anti-friction coating for rust protection and easy cut
- Toothting designed for aggressive cut on pullstroke

	 731151		 mm		 g
349	8018924	4	300	7	225

PG-72

EXPERT PRUNING SAWS



- Folding saw for home owners
- For occasional pruning when a secateur or a lopper is not sufficient
- Anti-friction coating for fast cut in hard and dry wood

	 731151		 mm	 inch		 g
PG-72	8242534	4	190	7 1/2	7	196



PRUNING SAWS

4211-/4212-

TRADITIONAL PRUNING SAWS



- Pruning saw for dry or hard wood
- Curved blade with fully ground, set teeth
- Comfortable and strong beech wood handle with a long hook
- Available in 11" and 14" blade lengths
- 4211 with hardpoint teeth, 4212 can be filed
- Replacement blades available

	 731151		 mm	 inch	 TPI	 g
4211-11-6T	8152000	4	280	11	6	225
4211-14-6T	8128883	4	360	14	6	280
4212-11-6T	8002060	4	280	11	6	225
4212-14-6T	8002077	4	360	14	6	280

339-/340-

TRADITION POLE SAWS



- Combination pruning saw with plastic handle
- Can be used handheld or with a 25 mm (1") Ø extension pole
- Fits all poles: AP-2.7M, AP-3M, AP-5M and FP-3M
- 339 with hardpoint teeth
340 can be filed
- Replacement blades available

	 731151		 mm	 inch	 TPI	 g
339-6T	8128371	4	360	14	6	250
340-6T	8002008	4	360	14	6	250

383-/384-

TRADITION POLE SAWS



- Pole pruning saw with steel tube handle
- To be used with a 25 mm (1") Ø extension pole
- Fits all poles: AP-2.7M, AP-3M, AP-5 and FP-3M
- For softer wood like pine and spruce the more aggressive 384-5T (5TPI) is recommended
- 383 with hardpoint teeth
384 can be filed

	 731151		 mm	 inch	 TPI	 g
383-6T	8128876	4	360	14	6	320
384-6T	8002039	4	360	14	6	320
384-5T	8159795	4	360	14	5	320



385-/386-

TRADITION POLE SAWS



- Pole pruning saw with steel tube handle
- To be used with 25 mm (1") Ø extension pole
- Fits all poles: AP-2.7M, AP-3M, AP-5M and FP-3M
- Blade tip extended into a hook to prevent the blade from slipping out of the kerf
- Striking knife attached to the blade and handle to cut the bark before sawing through the branch
- Prevents bark stripping
- 386 with hardpoint teeth
385 can be filed

	 731151		 mm	 inch	 T/°	 g
385-6T	8002053	4	360	14	6	410
386-6T	8152017	4	360	14	6	410

5724-JS/5728-JS

PRUNING SAW BLADE



- Replacement blades for the 51xx pruning saws
- Blades are with hardpoint teeth for long lasting sharpness

	 731151		 mm	 T/°	 g
5724-JS	8216085	1	240	5	60
5728-JS	8216092	1	280	5	74

4724-JT/4728-JT

PRUNING SAW BLADE



- Replacement blades for 41xx pruning saws
- Iron tetroxide coating for rust protection

	 731151		 mm	 T/°	 g
4724-JT	8265847	1	240	7	60
4728-JT	8265854	1	280	7	74

396-JS-BLADE

PRUNING SAW BLADE



- Spare blade for folding saw 396-JS
- Blade with hardpoint teeth and extra wide gullet for faster cutting in thicker green branches

	 731151		 mm	 inch	 T/°	 g
396-JS-BLADE	8223267	1	190	7 1/2	5	55



PRUNING SAWS

396-JT-BLADE

PRUNING SAW BLADE



- Spare blade for folding saw 396-JT
- JT tothing for pruning living wood in winter with a fast and clean cut

396-JT-BLADE	731151	1	190	7 1/2	7	55

396-HP-BLADE

PRUNING SAW BLADE



- Spare blade for folding saw 396-HP
- Multipurpose blade with hardpoint teeth performs well in living wood

396-HP-BLADE	731151	1	190	7 1/2	7	44

4400-/4420-

PRUNING SAW BLADE



- Pruning saw replacement blades
- Blades can be used on all 4211-, 4212-, 339- and 340- saws, as well as the top-pruner P34-37
- 4420 with hardpoint teeth
4400 can be filed
- BULK: No retail packaging and without blade protector

4400-11	731151	10	280	11	6	96
4400-14	8200596	10	360	14	6	140
4420-11	8200602	10	280	11	6	96
4420-14	8200619	10	360	14	6	140
4400-11-BULK	8200626	10	280	11	6	94
4400-14-BULK	8200633	10	360	14	6	140
4420-11-BULK	8200640	10	280	11	6	94
4420-14-BULK	8200657	10	360	14	6	140



LS-COMBINESS

GRINDING STONES AND CARBIDE SHARPENER



- Synthetic 2-component grinding stone for small blades
- Has to be moistened with petrol or oil for full efficiency
- Quick removal of damaged metal surfaces with 180 grain/cm² (green side of stone)
- Smooth finish with 400 grain/cm² (grey side)

	 731151		 L mm	 g
LS-COMBINESS	8041366	1	100	75

LS-NATURAL

GRINDING STONES AND CARBIDE SHARPENER



- High quality natural grinding stone, grain size 600
- For finishing edges of pruning tools
- This stone has to be used in a wet state in order to sharpen more efficiently
- Especially recommended for small blades requiring to be sharpened precisely

	 731151		 L mm	 g
LS-NATURAL	8224622	1	70	40

LS-TRIANGLE

GRINDING STONES AND CARBIDE SHARPENER



- Synthetic grinding stone, grain size 220
- To sharpen blades with high precision
- Stone can either be moistened with petrol, oil or water

	 731151		 L mm	 g
LS-TRIANGLE	8224653	1	100	50

LS-CORINDON

GRINDING STONES AND CARBIDE SHARPENER



- Synthetic grinding stone with 320 grain/cm² for professional use to sharpen high performance blades
- For rather small blades like on secateurs
- Very high removal rate
- Stone has to be moistened with petrol or oil for full efficiency

	 731151		 L mm	 g
LS-PIERRE CORINDON	8009977	1	100	50



SHARP-X



GRINDING STONES AND CARBIDE SHARPENER

- Professional tungsten-carbide sharpener to re-sharpen all kind of blades
- 2-component handle for comfortable use
- Very secure with two side protections to avoid fingers slipping down to the cutting edge of the blade
- Two carbide edges for easy and long-lasting use

	 731151		 L mm	 g
SHARP-X	8264895	10	100	25
SHARP-X-DISP	8264901	1	100	25

LS-PIERRE-FAUX



GRINDING STONES AND CARBIDE SHARPENER

- Synthetic grinding stone, grain size 180
- To sharpen long blades for tough work such as long-shafted tools, scythes and axes
- Stone has to be moist with petrol or oil for full efficiency

	 731151		 L mm	 g
LS-PIERRE-FAUX	8009038	1	230	210

LS-6160-23



GRINDING STONES AND CARBIDE SHARPENER

- Synthetic grinding stone, "Carbor" type, grain size 220
- Produces very fine surfaces on cutting tools
- Can be used wet or dry but it's not recommended for finishing work on small or new blades

	 731151		 L mm	 g
LS-6160-23	8041304	1	230	170

LS-6060-23



GRINDING STONES AND CARBIDE SHARPENER

- High quality natural grinding stone, "Lombarde" type
- For finishing edges of all types of cutting tools
- Stone has to be moist with petrol or oil for full efficiency

	 731151		 L mm	 g
LS-6060-23	8041311	1	230	300



SAP-X

CLEANERS AND LUBRICANT



- Cleaning liquid for pruning blades
- Removes dirt and stains and is a corrosion inhibitor
- Advice:
 - Spray on the surface of the blade
 - Leave to react for a few seconds
 - Wipe clean and lubricate

	 731151		 g
SAP-X	8225728	6	75

RESIN-X

CLEANERS AND LUBRICANT



- Very efficient resin dissolvent
- Designed for quick removal of resins and natural adhesives
- Particularly useful for maintenance of blades
- Tensio-active, cationic, non ionic and contains a corrosion inhibitor
- Advice: Spray on the surface to be cleaned
- Let react for a few seconds
- Wipe clean and lubricate

	 731151		 g
RESIN-X	8222215	6	75

ECO-LUBE

CLEANERS AND LUBRICANT



- Synthetic lubricant for secateurs
- To keep tools in good shape reducing parts friction and allowing a smoother cutting action
- To be applied to bolts and junctures

	 731151		 g
ECO-LUBE100	8249434	4	128

PROF-H

HOLSTERS



- Strong and natural-coloured leather holster for secateurs
- Two belt slits to fit any belt up to 50 mm width. Top-quality leather, studded and stitched. Steel belt clip feature

	 731151		 g
PROF-H	8158439	2	86



ACCESSORIES & MAINTENANCE

PROF-K

HOLSTERS



- Strong leather holster for small grinding stones or knives, with belt loop on the back
- Top quality leather, studded and stitched

	 731151		 g
PROF-K	8218256	1	42

PROF-PH

HOLSTERS



- Top quality plastic holster, which holds the secateur very securely

	 731151		 g
PROF-PH	8243548	2	100

PROF-LOPP

HOLSTERS



- Practical lopper holster primarily for pruning in vineyards
- Additional pocket to carry a sharpening stone, grafting knife or a SHARP-X
- Holster can be strapped to the lower part of the leg or on a belt
- Made of wear-resistant and lightweight nylon material for durability and comfort
- Holster suitable for P16,P14,P-SL2 & P-SL loppers up to 60 cm length

	 731151		 g
PROF-LOPP	8288549	1	375

PROF-SEC

HOLSTERS



- Practical secateur holster
- Wear-resistant and lightweight nylon material for durability and comfort
- Additional pocket for grinding stone or grafting knife.
Belt loop. (fits 4750-QRLB-1 & 4750-HDB-1)

	 731151		 g
PROF-SEC	8288532	1	150



LINDSTRÖM PRECISION TOOLS

Lindström precision tools are the essential, specialist tools for electronic, electromechanical and medical device assembly, rework and repair. Since 1856 Lindström tools have been setting standards for precision tool manufacture.

Chapter Index

ELECTRONICS AND FINE MECHANICAL PLIERS	1188-1206
ELECTRONICS AND FINE MECHANICAL TWEEZERS	1207-1224
TORQUE SCREWDRIVERS	1225

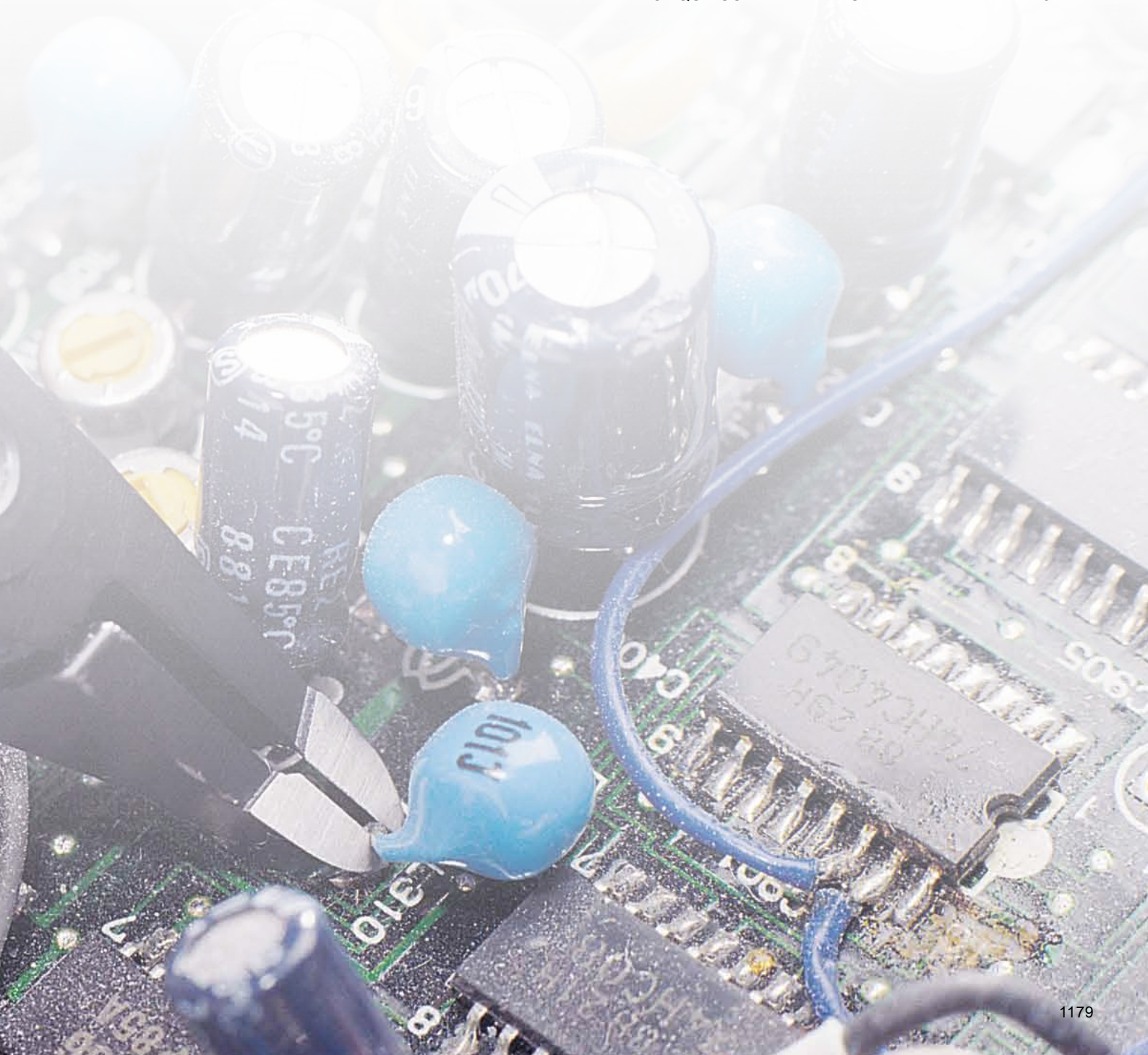

CUTTING PLIERS

Lindström cutters offer an unequalled blend of the technical elements required to achieve the level of performance demanded by a growing number of users.

Every cutter begins with the fundamental materials. Even slight adjustments to these ingredients can change the way steel performs. Lindström has been refining this formula for almost 150 years. The 1% carbon, with a pinch of chrome and other key materials, is similar in many ways to the steel used for high-quality ball bearings. This is the material used for Lindström Rx and 80-Series cutters. The use of ball-bearing grade steel and appropriate heat treatment ensures Lindström cutters last for longer than other brands used in the same applications.

The Lindström cutter is designed to cut with ease, helping to improve the work quality, and reducing operator fatigue.

Proud of its heritage, Lindström is constantly driven by improving quality results, such as through perfect symmetry of the cutter components, the exactness of the grinding and the consistent hardening. Reliability and consistency are the Lindström hallmark.

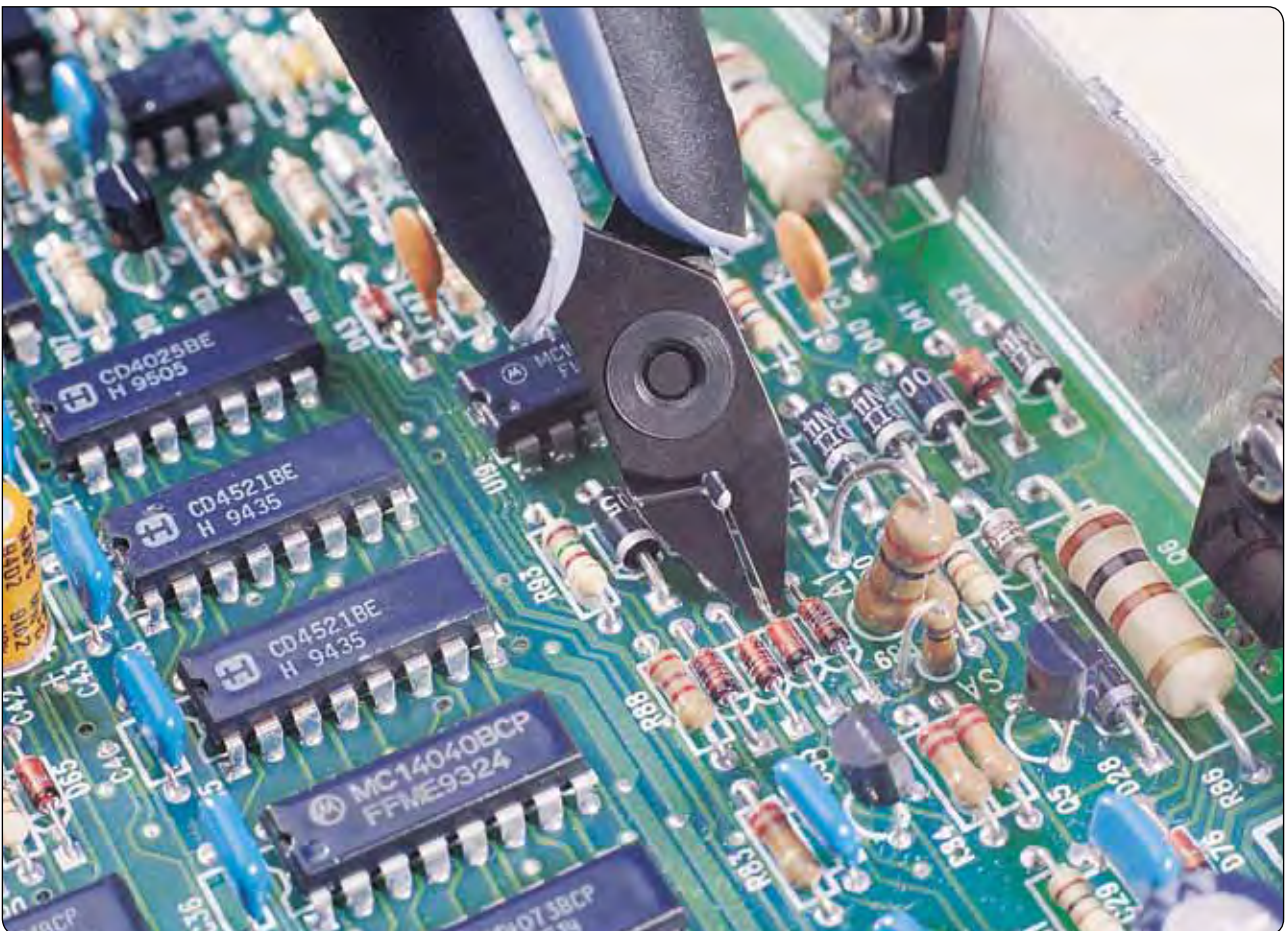

CUTTING TYPES

In order to select the right tool, it is important to recognize what type of cut is required and what the cut lead-end should look like after the cut. This is especially true when working to the stricter requirements and specifications of military and high-end commercial electronics.

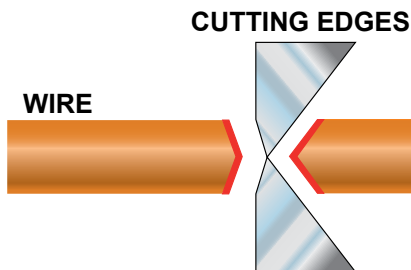

Semi-Flush Cut

The semi-flush cut leaves a large lead-end shaped like a pyramid and can be seen as the standard cut. This type of cutting edge is a good application match for general electrical and semi-professional cutting.

Micro-Bevel® Cut

To meet the requirements of the electronic assembly industry, Lindström designed the Micro-Bevel® cut. This unique cut is quite different as the leads are 'pinched' unlike the pyramid look of the semi-flush cut, allowing less altitude and smaller overall surface area.

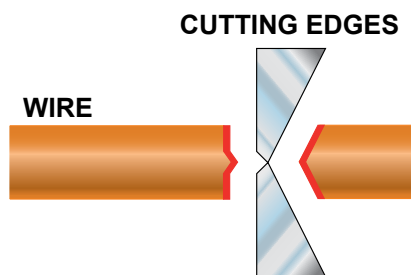
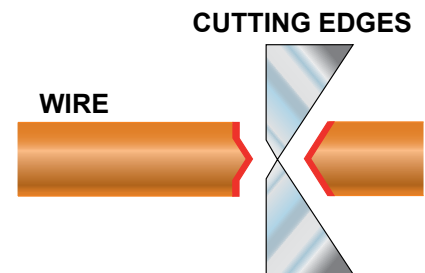

Flush Cut

Flush cutters also pinch the leads, but at a lower altitude than Micro-Bevel® cutters. The Lindström flush cutter leaves a narrower and shorter taper along the pinch, reducing the total exposed area. The flush cut is preferred over the Micro-Bevel® when the specification is slightly stricter for the cut lead-end, or to gain a more flush result to a board, component or part.

Ultra-Flush® Cut

As the cutter wears down, the size of the pinch increases. The greater the pinch, the greater the mechanical shock transmitted. To solve the pinch problem, Lindström engineers have designed the Ultra-Flush® cutter to eliminate the pinch that other cutters make. The Ultra-Flush® configures two flat panes with a barely discernible line separating each planar surface.

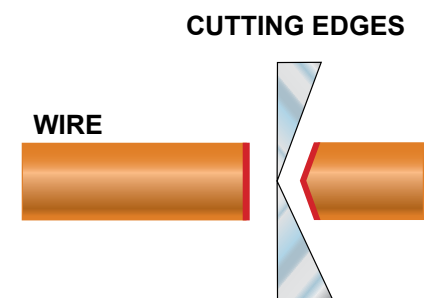

The unique design of the Ultra-Flush® is perfect for use in close tolerance electronic and medical device assembly where final lead-end configuration and mechanical shock transmission are top priorities.



ESD safety

All Lindström RX pliers (except TRX 8180) are ESD safe. Resins with conductive additives in the handles create a material that safely dissipates electrostatic charges, reducing possibility of damage to sensitive components.

Warning! Lindström pliers are not 1000V insulated and therefore should never be used on electrified equipment.

TO ADJUST RX



Microtouch is the shape that makes it possible to control and rotate the RX between thumb and index finger for precision work.

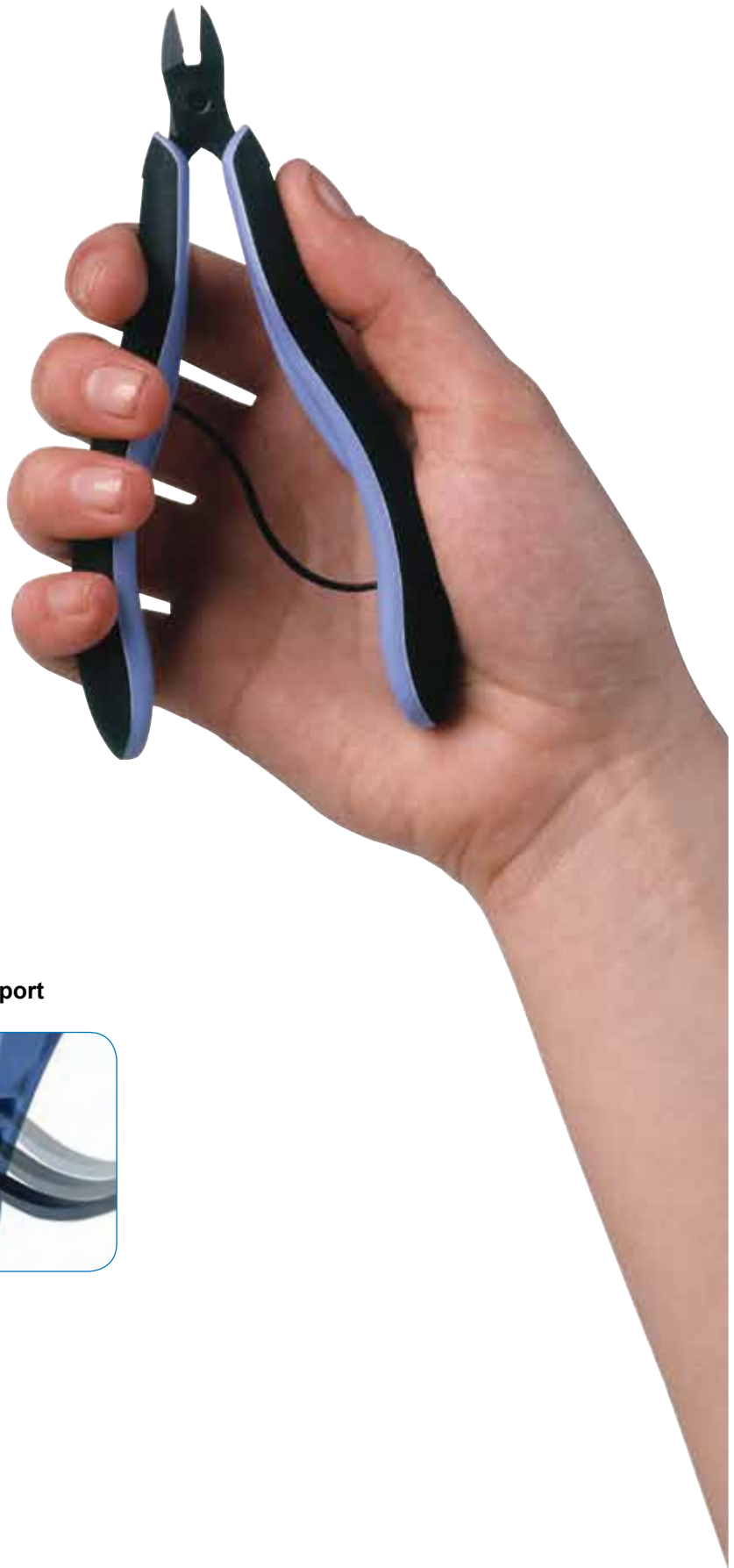

1. Pull the tool handles apart



2. Place the spring into the desired port

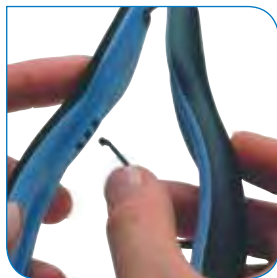

3. Close the tool



HOLDING PLIERS

Holding pliers are used on some of the toughest applications – from removing plate steel retaining pins on an oil derrick to the most sensitive and sterile of environments such as surgery. Pliers replicate the function of the human hand, with greatly increased capability, in particular the thumb and index finger, in terms of force and precision. That is why holding pliers are available in an almost unlimited number of shapes, styles, configurations, materials and sizes.

Lindström offers a wide range of precision holding pliers for numerous applications.



TWEEZERS

Lindström tweezers offer perfect balance, tip alignment and symmetry, and are made from a wide range of materials to meet the most sophisticated and demanding requirements. In addition to general assembly, the range includes models specifically designed for surface mounted devices, ESD-sensitive areas and medical and laboratory applications.

When choosing tweezers, special attention should be paid to the following four criteria.

- How are the tweezers' tips finished?
- How symmetrical are the two sides?
- How delicate do they feel?
- How easily do they handle small parts?

A wide variety of materials are available: Carbon steel, stainless steel, special stainless steel, nickel plating, nickel-content, and even beryllium and titanium. However, for use in most assembly or repair situations, three primary types will suffice:

- Carbon steel – has strong, flame hardened tips, but has low rust resistance and can develop a high level of magnetism
- Stainless steel – is rust resistant with reasonably strong tips, but with lower hardness and shorter life than carbon. In time they are however susceptible to rust and magnetism (care and use factors notwithstanding)
- Special stainless steel – has excellent anti-acid (resistant to hydrofluoric and nitric acids), anti-magnetic and rust-resistant properties



TORQUE SCREWDRIVERS

HIGH PRECISION TORQUE CONTROL

With a unique high-precision cam-over torque-limiting design, Lindström's Torque Screwdrivers eliminate over-application of force reducing the risk for damage and rework costs. Available in Micro-Adjustable or Preset Torque versions, Lindström's Torque Screwdrivers offer comfort with a user-friendly shape and non-slip grip. Built to last and with a non-magnetic bit holder that accepts any standard drive, it is the ideal choice for flexible applications as well as volume production. All models are ESD-safe.



MICRO-ADJUSTABLE TORQUE SCREWDRIVERS

The Micro-Adjustable Torque Screwdriver allows instant change to the torque value with an easy-to-read window scale and a precise pull-to-set, push-to-lock mechanism. Adjustment is easy - just pull the knob, turn to the desired torque, push the knob back in, and it is ready to use.

The Micro-Adjustable Screwdriver series includes three models ranging from 10 to 450 Ncm or 20 in.oz. to 40 in.lbs. Accuracy +/- 6%.

PRESET TORQUE SCREWDRIVERS

With the same ruggedness, comfort and precision of the Micro-Adjustable version, the Preset Torque Screwdriver is an excellent choice for volume manufacturing applications.

The desired torque value is easily set using an internal adjustment screw accessible by removing the end cap of the handle. The Preset Torque Driver is available with a torque of 70-100 Ncm or 100 in.oz. Accuracy +/- 6%.



All models are ESD-safe.

Certified to the following industry specifications:
ASME B107.14 M-1994 and ISO 6789, EN 26789/1994

Capacity and Options

SIZE

XS	Extra Small
S	Small
M	Medium
L	Large



SHAPE

O	Oval
T	Tapered
T&R	Tapered & Relieved
A	Angle
TP	Tip
ED	End

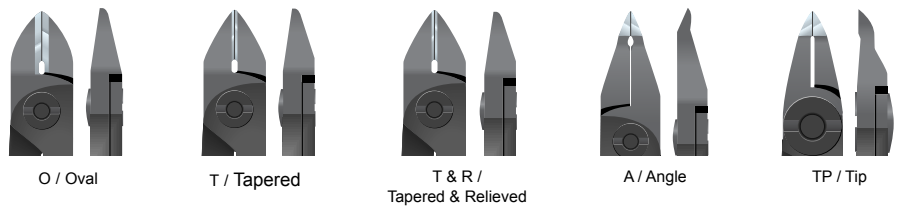

CUT OR SURFACE

MB	Micro-Bevel®
F	Flush
UF	Ultra-Flush®
SM	Smooth
SE	Serrated

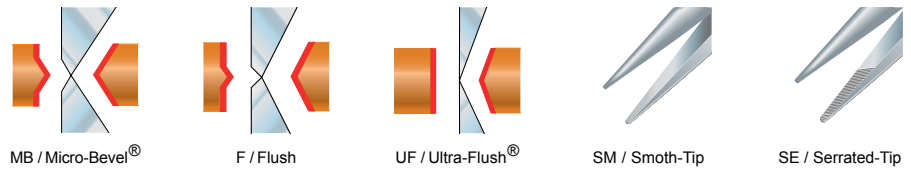

HANDLE OPTIONS

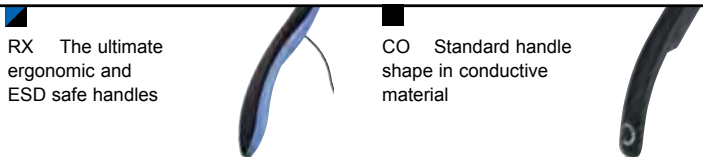

RX The ultimate ergonomic and ESD safe handles

CO Standard handle shape in conductive material

To order handle options, add two letter prefix to part no. = Rx8130

LEAD CATCHER

Lindström's patented lead-catcher is an accessory that stops just-cut ends of wire from falling into critical or sensitive areas, which could result in a short circuit or contamination. The lead catcher product code is 813 for 8130-8132 and RX 8130-8132 and RX 814 for cutters 8140-8148 and RX 8140-8148.





RX 8130-RX 8162

ergo®

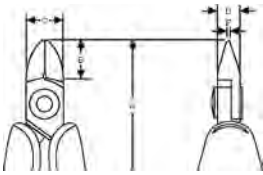

RX SERIES DIAGONAL CUTTERS OVAL HEAD

- Precision cutters developed according to the scientific ERGO™ process
- Material: High performance alloy steel
- Black finish
- Numerically controlled machine grinding guarantees edge angle accuracy and contact, increasing the tools reliability and consistency
- Precision induction hardened edges 63-65 HRC
- Screw joint that minimizes friction and maximizes alignment of cutting edges
- ESD safe handles in 2-component synthetic material
- Biospring that limits the tension throughout the working cycle of the tool and can be adjusted in three different positions or removed
- Ideal for wire harness work and standard printed circuit board assembly
- The cutting capacity that is given is for copper wire

			A mm	B mm	C mm	D mm	F mm			
	731415							mm		g
RX 8130	0103003	1	133.5	8.5	8.0	5	0.8	0.2-1.0	Micro	68
RX 8131	0103010	1	133.5	8.5	8.0	5	0.8	0.1-1.0	Flush	68
RX 8132	0103027	1	133.5	8.5	8.0	5	0.8	0.1-0.8	Ultra	68
RX 8140	0103034	1	135.5	10.5	10.0	6	0.8	0.2-1.25	Micro	70
RX 8141	0103041	1	135.5	10.5	10.0	6	0.8	0.1-1.25	Flush	70
RX 8142	0103058	1	135.5	10.5	10.0	6	0.8	0.1-1.0	Ultra	70
RX 8150	0103133	1	138.0	13.0	12.5	6	1.2	0.3-1.6	Micro	73
RX 8151	0103140	1	138.0	13.0	12.5	6	1.2	0.2-1.6	Flush	73
RX 8152	0103157	1	138.0	13.0	12.5	6	1.2	0.2-1.25	Ultra	73
RX 8160	0111534	10	147.0	16.0	16.0	8	1.6	0.4-2.0	Micro	97
RX 8161	0111541	10	147.0	16.0	16.0	8	1.6	0.3-2.0	Flush	97
RX 8162	0111558	10	147.0	16.0	16.0	8	1.6	0.3-1.6	Ultra	97

RX 8143-RX 8145

ergo®

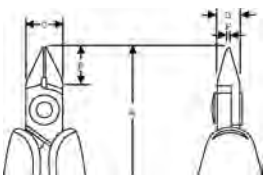

RX SERIES DIAGONAL CUTTERS TAPERED HEAD

- Precision cutters developed according to the scientific ERGO™ process
- Material: High performance alloy steel
- Black finish
- Numerically controlled machine grinding guarantees edge angle accuracy and contact, increasing the tools reliability and consistency
- Precision induction hardened edges 63-65 HRC
- Screw joint that minimizes friction and maximizes alignment of cutting edges
- ESD safe handles in 2-component synthetic material
- Biospring that limits the tension throughout the working cycle of the tool and can be adjusted in three different positions or removed
- Ideal for assembly work where accessibility is a consideration
- The cutting capacity that is given is for copper wire

			A mm	B mm	C mm	D mm	F mm			
	731415							mm		g
RX 8143	0103065	1	135.5	10.5	10	6	0.8	0.2-1.25	Micro	68
RX 8144	0103072	1	135.5	10.5	10	6	0.8	0.1-1.25	Flush	68
RX 8145	0103089	1	135.5	10.5	10	6	0.8	0.1-1.0	Ultra	68



RX 8146-RX 8148

ergo®

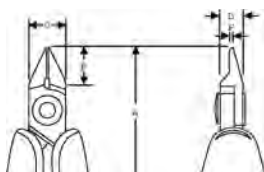

RX SERIES DIAGONAL CUTTERS TAPERED AND RELIEVED HEAD

- Precision cutters developed according to the scientific ERGO™ process
- Material: High performance alloy steel
- Black finish
- Numerically controlled machine grinding guarantees edge angle accuracy and contact; increasing the tools reliability and consistency
- Precision induction hardened edges 63-65 HRC
- Screw joint that minimizes friction and maximizes alignment of cutting edges
- ESD safe handles in 2-component synthetic material
- Biospring that limits the tension throughout the working cycle of the tool and can be adjusted in three different positions or removed
- Ideal for use in confined spaces and for rework
- The cutting capacity that is given is for copper wire

			A mm	B mm	C mm	D mm	F mm			
RX 8146	731415	1	135.5	10.5	10	6	0.8	0.2-1.0	Micro	68
RX 8147	0103102	1	135.5	10.5	10	6	0.8	0.1-1.0	Flush	68
RX 8148	0103119	1	135.5	10.5	10	6	0.8	0.1-0.8	Ultra	68

RX 8149

ergo®

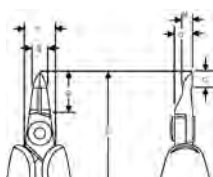

RX SERIES DIAGONAL CUTTERS TIP CUTTER

- Precision cutters developed according to the scientific ERGO™ process
- Material: High performance alloy steel
- Black finish
- Numerically controlled machine grinding guarantees edge angle accuracy and contact; increasing the tools reliability and consistency
- Precision induction hardened edges 58-60 HRC
- Screw joint that minimizes friction and maximizes alignment of cutting edges
- ESD safe handles in 2-component synthetic material
- Biospring that limits the tension throughout the working cycle of the tool and can be adjusted in three different positions or removed
- Ideal for use with multi-lead components and for rework
- The cutting capacity that is given is for copper wire

			A mm	B mm	C mm	D mm	E mm	G mm	H mm			
RX 8149	731415	1	139.0	14	10	6	5	5	3.2	0.1-0.6	Flush	70



RX 8211

RX SERIES OBLIQUE CUTTERS 20° SHORT HEAD

ergo®

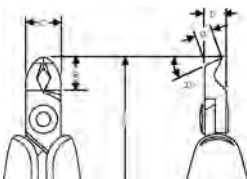

- Precision cutters developed according to the scientific ERGO™ process
- Material: High performance alloy steel
- Black finish
- Numerically controlled machine grinding guarantees edge angle accuracy and contact; increasing the tools reliability and consistency
- Precision induction hardened edges 63-65 HRC
- Screw joint that minimizes friction and maximizes alignment of cutting edges
- ESD safe handles in 2-component synthetic material
- Biospring that limits the tension throughout the working cycle of the tool and can be adjusted in three different positions or removed
- Ideal for rework and close assembly needs
- The cutting capacity that is given is for copper wire

			A mm	B mm	C mm	D mm	G mm			
RX 8211	0103188	1	134.5	9.5	10	6	4.1	0.2-1.2 mm	Flush	70

RX 8247

RX SERIES OBLIQUE CUTTERS 45° LONG HEAD

ergo®

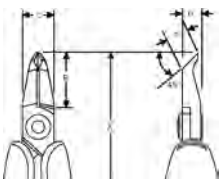

- Precision cutters developed according to the scientific ERGO™ process
- Material: High performance alloy steel
- Black finish
- Numerically controlled machine grinding guarantees edge angle accuracy and contact; increasing the tools reliability and consistency
- Precision induction hardened edges 63-65 HRC
- Screw joint that minimizes friction and maximizes alignment of cutting edges
- ESD safe handles in 2-component synthetic material
- Biospring that limits the tension throughout the working cycle of the tool and can be adjusted in three different positions or removed
- Ideal for rework and close assembly needs
- The cutting capacity that is given is for copper wire

			A mm	B mm	C mm	D mm	G mm			
RX 8247	0103164	1	143.0	18	10	6	6.7	0.2-1.0 mm	Flush	72



RX 8248

RX SERIES OBLIQUE CUTTERS 45° LONG HEAD

ergo®

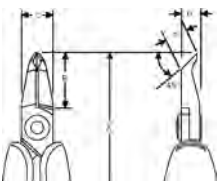

- Precision cutters developed according to the scientific ERGO™ process
- Material: High performance alloy steel
- Black finish
- Numerically controlled machine grinding guarantees edge angle accuracy and contact; increasing the tools reliability and consistency
- Precision induction hardened edges 63-65 HRC
- Screw joint that minimizes friction and maximizes alignment of cutting edges
- ESD safe handles in 2-component synthetic material
- Biospring that limits the tension throughout the working cycle of the tool and can be adjusted in three different positions or removed
- Ideal for rework and close assembly needs
- The cutting capacity that is given is for copper wire

			A mm	B mm	C mm	D mm	G mm			
RX 8248	0103171	1	143.0	18	10	6	6.7	0.2-0.8	Flush	72

RX 8233

RX MICRO TIP CUTTERS

ergo®

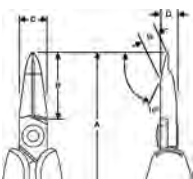

- Precision micro tip cutters developed according to the scientific ERGO™ process
- Material: High performance alloy steel
- Black finish
- Numerically controlled machine grinding guarantees edge angle accuracy and contact; increasing the tools reliability and consistency
- Precision induction hardened edges 63-65 HRC
- Screw joint that minimizes friction and maximizes alignment of cutting edges
- ESD safe handles in 2-component synthetic material
- Biospring that limits the tension throughout the working cycle of the tool and can be adjusted in three different positions or removed
- Ideal for rework and close fine pitch applications
- The cutting capacity that is given is for copper wire

			A mm	B mm	C mm	D mm	G mm			
RX8233	0113521	1	149.0	22.3	10.6	7.0	7.2	0.1-0.65	Flush	69



RX 8234

RX MICRO TIP CUTTERS

ergo®

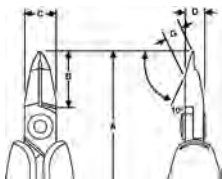

- Precision micro tip cutters developed according to the scientific ERGO™ process
- Material: High performance alloy steel
- Black finish
- Numerically controlled machine grinding guarantees edge angle accuracy and contact; increasing the tools reliability and consistency
- Precision induction hardened edges 63-65 HRC
- Screw joint that minimizes friction and maximizes alignment of cutting edges
- ESD safe handles in 2-component synthetic material
- Biospring that limits the tension throughout the working cycle of the tool and can be adjusted in three different positions or removed
- Ideal for rework and close fine pitch applications
- The cutting capacity that is given is for copper wire

	 731415		A mm	B mm	C mm	D mm	G mm	 mm		 g
RX8234	0113538	1	141.0	14.2	10.6	7.0	3.2	0.05-0.4	Flush	62

RX 8237

RX MICRO TIP CUTTERS

ergo®

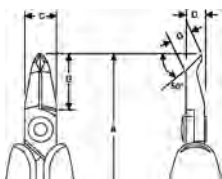

- Precision micro tip cutters developed according to the scientific ERGO™ process
- Material: High performance alloy steel
- Black finish
- Numerically controlled machine grinding guarantees edge angle accuracy and contact; increasing the tools reliability and consistency
- Precision induction hardened edges 63-65 HRC
- Screw joint that minimizes friction and maximizes alignment of cutting edges
- ESD safe handles in 2-component synthetic material
- Biospring that limits the tension throughout the working cycle of the tool and can be adjusted in three different positions or removed
- Ideal for rework and close fine pitch applications
- The cutting capacity that is given is for copper wire

	 731415		A mm	B mm	C mm	D mm	G mm	 mm		 g
RX8237	0113545	1	144.0	17.4	10.6	7.0	4.1	0.1-0.65	Flush	65



RX 7490

RX SERIES HOLDING PLIERS FLAT NOSE PLIERS

ergo®

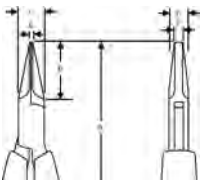

- Precision flat nose pliers developed according to the scientific ERGO™ process
- Material: High performance alloy steel
- Polished
- Numerically controlled machine grinding guarantees accuracy and contact, increasing the tools reliability and consistency
- Tough hardened 42-46 HRC
- Screw joint that minimizes friction and maximizes jaw alignment
- ESD safe handles in 2-component synthetic material
- Micro-Touch: The shape of the handles makes it possible to control and rotate the pliers between thumb and index finger for precision work
- Biospring that limits the tension throughout the working cycle of the tool and can be adjusted in three different positions or removed
- 20 mm of smooth gripping jaws with radiused edges

			A mm	B mm	C mm	D mm	E mm	F mm	
RX 7490	731415 0103195	10	146.5	20	9	6.7	1.2	3.2	70

RX 7590

RX SERIES ROUND NOSE PLIER

ergo®

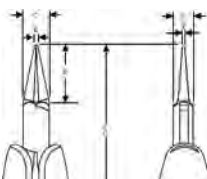

- Precision round nose pliers developed according to the scientific ERGO™ process
- Material: High performance alloy steel
- Polished
- Numerically controlled machine grinding guarantees accuracy and contact, increasing, the tools reliability and consistency
- Tough hardened 42-46 HRC
- Screw joint that minimizes friction and maximizes jaw alignment
- ESD safe handles in 2-component synthetic material
- Micro-Touch: The shape of the handles makes it possible to control and rotate the pliers between thumb and index finger for precision work
- Biospring that limits the tension throughout the working cycle of the tool and can be adjusted in three different positions or removed
- Round nose, fine jaws with no sharp edges

			A mm	B mm	C mm	D mm	E mm	F mm	
RX 7590	731415 0103201	10	146.5	20	9	6.7	1.8	0.9	69



RX 7890, RX 7891

RX SERIES SNIPE NOSE PLIERS

ergo®



RX 7890



RX 7891

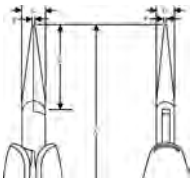

- Precision snipe nose pliers developed according to the scientific ERGO™ process
- Material: High performance alloy steel
- Polished
- Numerically controlled machine grinding guarantees accuracy and contact, increasing the tools reliability and consistency
- Tough hardened 42-46 HRC
- Screw joint that minimizes friction and maximizes jaw alignment
- ESD safe handles in 2-component synthetic material
- Micro-Touch: The shape of the handles makes it possible to control and rotate the pliers between thumb and index finger for precision work
- Biospring that limits the tension throughout the working cycle of the tool and can be adjusted in three different positions or removed
- 32 mm jaws with radiused edges
- RX 7890 with smooth jaws
- RX 7891 with serrated jaws

	 731415		A mm	B mm	C mm	D mm	E mm	F mm	 g
RX 7890	0103218	1	158.5	32	9	6	1.2	0.8	72
RX 7891	0103225	10	158.5	32	9	6	1.2	0.8	72

RX 7892

RX SERIES SNIPE NOSE PLIER WITH BENT TIP

ergo®

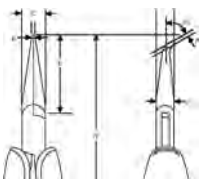

- Precision snipe nose pliers developed according to the scientific ERGO™ process
- Material: High performance alloy steel
- Polished
- Numerically controlled machine grinding guarantees accuracy and contact, increasing the tools reliability and consistency
- Tough hardened 42-46 HRC
- Screw joint that minimizes friction and maximizes jaw alignment
- ESD safe handles in 2-component synthetic material
- Micro-Touch: The shape of the handles makes it possible to control and rotate the pliers between thumb and index finger for precision work
- Biospring that limits the tension throughout the working cycle of the tool and can be adjusted in three different positions or removed
- 29 mm of smooth jaws and bent tip angled at 60°, radiused edges

	 731415		A mm	B mm	C mm	D mm	E mm	F mm	 g
RX 7892	0103232	1	155.5	29	9	6.7	1.2	0.8	73



RX 7893

RX SERIES SHORT SNIPE NOSE PLIER

ergo®

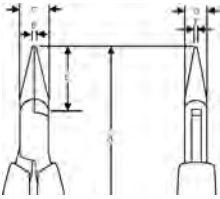

- Precision snipe nose pliers developed according to the scientific ERGO™ process
- Material: High performance alloy steel
- Polished
- Numerically controlled machine grinding guarantees accuracy and contact, increasing the tools reliability and consistency
- Tough hardened 42-46 HRC
- Screw joint that minimizes friction and maximizes jaw alignment
- ESD safe handles in 2-component synthetic material
- Micro-Touch: The shape of the handles makes it possible to control and rotate the pliers between thumb and index finger for precision work
- Biospring that limits the tension throughout the working cycle of the tool and can be adjusted in three different positions or removed
- 20 mm of smooth jaws with radiused edges

	 731415		A mm	B mm	C mm	D mm	E mm	F mm	 g
RX 7893	0103249	1	146.5	20	9	6.7	1.2	0.8	71

RX 01

RX SERIES BIO SPRING



- 5 springs for Rx-series'packed in a plastic bag

	 731415		 g
RX 01	0103263	1	5



TRX 8180

HEAVY DUTY CUTTER

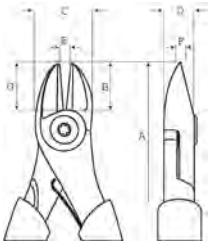

- High leverage side cutting pliers
- ISO 5749
- Black finish, anti-corrosion treated
- Material: High performance alloy steel
- Induction hardened cutting edges
- Progressive edges: The cutting radius progresses along the edge in order to cut hard material like piano wire close to the joint and soft materials like copper and plastic insulated wire at the tip
- Screw joint that minimizes friction and maximizes jaw alignment
- 2-component handles in synthetic material
- High leverage: Redesigned for optimum cutting performance and reduced cutting effort
- Equipped with a return spring featuring an on/off function

			A	B	C	D	E	F	G				
	731415		mm	mm	mm	mm	mm	mm	mm	Cu	Fe+	Piano	g

TRX 8180 0112272 5 210 21 29 11 2.5 1.5 21 4.5 3.0 2.5 304

P6160

PLASTIC CUTTER

ergo®

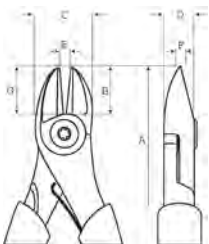

- Side cutting pliers developed according to the scientific ERGO™ process
- Dimensions according to ISO 5749
- Black finished, anti-corrosion treated
- Material: High performance alloy steel
- Induction hardened cutting edges
- Full flush cutting edge without bevelling which is designed to smoothly cut all kind of plastic parts such as e.g. the flash of plastic component
- Screw joint that minimizes friction and maximizes jaw alignment
- ESD safe handles in 2-component synthetic material
- Round shaped jaws give improved accessibility in confined spaces
- Equipped with a return spring featuring an on/off function
- Max cutting capacity: Copper 1.5 mm and plastic material PA (Nylon) 3 mm

			A	B	C	D	F	G	
	731415		mm	mm	mm	mm	mm	mm	g

P6160 0115075 5 160 18 21.5 10 1.5 18 162



8130-8162

80-SERIES DIAGONAL CUTTERS OVAL HEAD

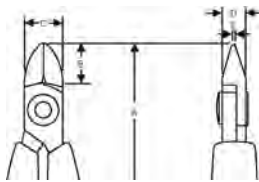

- Material: High performance alloy steel
- Black finish
- Numerically controlled machine grinding guarantees edge angle accuracy and contact, increasing the tools reliability and consistency
- Precision induction hardened edges 63-65 HRC
- Screw joint that minimizes friction and maximizes alignment of cutting edges
- ESD safe handles in synthetic material with return spring
- Ideal for wire harness work and standard printed circuit board assembly
- The cutting capacity that is given is for copper wire
- “J” edges for stripping and cutting insulated copper wire
- “CO” standard handle shape in conductive material

			A mm	B mm	C mm	D mm	F mm			
8130	0050918	10	108.0	8.0	8.0	5	0.8	0.2-1.0	Micro	43
8131	0050925	10	108.0	8.0	8.0	5	0.8	0.1-1.0	Flush	43
8131 CO	0051519	10	108.0	8.0	8.0	5	0.8	0.1-1.0	Flush	43
8132	0050932	10	108.0	8.0	8.0	5	0.8	0.1-0.8	Ultra	44
8140	0050949	10	110.0	10.0	10.0	6	0.8	0.2-1.25	Micro	46
8140 CO	0051533	10	110.0	10.0	10.0	6	0.8	0.2-1.25	Micro	46
8141	0050987	10	110.0	10.0	10.0	6	0.8	0.1-1.25	Flush	45
8141 CO	0051557	10	110.0	10.0	10.0	6	0.8	0.1-1.25	Flush	45
8142	0051007	10	110.0	10.0	10.0	6	0.8	0.1-1.0	Ultra	46
8142 CO	0051564	10	110.0	10.0	10.0	6	0.8	0.1-1.0	Ultra	46
8150	0051113	10	112.5	12.5	12.5	6	1.2	0.3-1.6	Micro	50
8150 CO	0051670	10	112.5	12.5	12.5	6	1.2	0.3-1.6	Micro	50
8150 J	0051137	10	112.5	12.5	12.5	6	1.2	Max 0.5	Micro	50
8151	0051199	10	112.5	12.5	12.5	6	1.2	0.2-1.6	Flush	49
8151 CO	0051694	10	112.5	12.5	12.5	6	1.2	0.2-1.6	Flush	49
8152	0052097	10	112.5	12.5	12.5	6	1.2	0.1-1.25	Ultra	49
8160	0051229	10	125.0	16.0	16.0	8	1.6	0.4-2.0	Micro	88
8160 CO	0051724	10	125.0	16.0	16.0	8	1.6	0.4-2.0	Micro	88
8160 J	0051250	10	125.0	16.0	16.0	8	1.6	Max 0.5	Micro	87
8161	0051328	10	125.0	16.0	16.0	8	1.6	0.3-2.0	Flush	88
8161 CO	0051748	10	125.0	16.0	16.0	8	1.6	0.3-2.0	Flush	88
8162	0051335	10	125.0	16.0	16.0	8	1.6	0.3-1.6	Ultra	88



8143-8165

80-SERIES DIAGONAL CUTTERS TAPERED HEAD

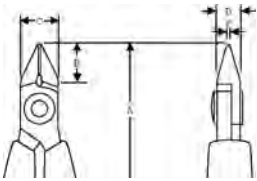

- Material: High performance alloy steel
- Black finish
- Numerically controlled machine grinding guarantees edge angle accuracy and contact, increasing the tools reliability and consistency
- Precision induction hardened edges 63-65 HRC
- Screw joint that minimizes friction and maximizes alignment of cutting edges
- ESD safe handles in synthetic material with return spring
- Ideal for assembly work where accessibility is a consideration
- The cutting capacity that is given is for copper wire
- "CO" standard handle shape in conductive material

	 731415		A mm	B mm	C mm	D mm	F mm	 mm		 g
8143	0051021	10	110.0	10.0	10.0	6	0.8	0.2-1.25	Micro	46
8144	0051045	10	110.0	10.0	10.0	6	0.8	0.2-1.25	Flush	46
8144 CO	0051601	10	110.0	10.0	10.0	6	0.8	0.2-1.25	Flush	46
8145	0051052	10	110.0	10.0	10.0	6	0.8	0.1-1.0	Ultra	46
8153	0051205	10	112.5	12.5	12.5	6	1.2	0.3-1.6	Micro	49
8154	0052103	10	112.5	12.5	12.5	6	1.2	0.2-1.6	Flush	49
8154 CO	0052233	10	112.5	12.5	12.5	6	1.2	0.2-1.6	Flush	49
8155	0052110	10	112.5	12.5	12.5	6	1.2	0.2-1.25	Ultra	49
8163	0051342	10	125.0	16.0	16.0	8	1.6	0.4-2.0	Micro	88
8163 CO	0051762	10	125.0	16.0	16.0	8	1.6	0.4-2.0	Micro	88
8164	0052141	10	125.0	16.0	16.0	8	1.6	0.3-2.0	Flush	88
8165	0052158	10	125.0	16.0	16.0	8	1.6	0.3-1.6	Ultra	88
8165 CO	0052288	10	125.0	16.0	16.0	8	1.6	0.3-1.6	Ultra	88

8146-8158

80-SERIES DIAGONAL CUTTERS TAPERED AND RELIEVED HEAD

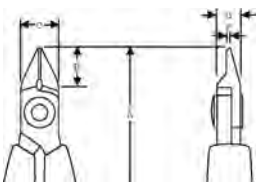

- Material: High performance alloy steel
- Black finish
- Numerically controlled machine grinding guarantees edge angle accuracy and contact, increasing the tools reliability and consistency
- Precision induction hardened edges 63-65 HRC
- Screw joint that minimizes friction and maximizes alignment of cutting edges
- ESD safe handles in synthetic material with return spring
- Ideal for use in confined spaces and for rework
- The cutting capacity that is given is for copper wire
- "CO" standard handle shape in conductive material

	 731415		A mm	B mm	C mm	D mm	F mm	 mm		 g
8146	0051076	10	110.0	10.0	10.0	6	0.8	0.2-1.0	Micro	46
8147	0051083	10	110.0	10.0	10.0	6	0.8	0.1-1.0	Flush	46
8148	0051090	10	110.0	10.0	10.0	6	0.8	0.1-0.8	Ultra	45
8148 CO	0051656	10	110.0	10.0	10.0	6	0.8	0.1-0.8	Ultra	45
8156	0051212	10	112.5	12.5	12.5	6	1.0	0.3-1.25	Micro	49
8157	0052127	10	112.5	12.5	12.5	6	1.0	0.2-1.25	Flush	49
8158	0052134	10	112.5	12.5	12.5	6	1.0	0.2-1.0	Ultra	49



8149

80-SERIES DIAGONAL CUTTERS TIP CUTTER

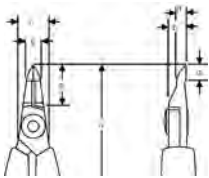

- Material: High performance alloy steel
- Black finish
- Numerically controlled machine grinding guarantees edge angle accuracy and contact, increasing the tools reliability and consistency
- Precision induction hardened edges 58-60 HRC
- Screw joint that minimizes friction and maximizes alignment of cutting edges
- ESD safe handles in synthetic material with return spring
- Ideal for use with multi-lead components and for rework
- The cutting capacity that is given is for copper wire

	 731415		A mm	B mm	C mm	D mm	E mm	G mm	H mm	 mm		 g
8149	0051106	10	114	14	5	6	5	5	3.2	0.1-0.6	Flush	48

8211

80-SERIES OBLIQUE CUTTERS 20° SHORT HEAD

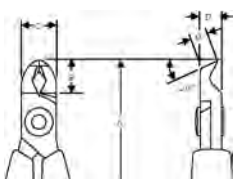

- Material: High performance alloy steel
- Black finish
- Numerically controlled machine grinding guarantees edge angle accuracy and contact; increasing the tools reliability and consistency
- Precision induction hardened edges 63-65 HRC
- Screw joint that minimizes friction and maximizes alignment of cutting edges
- ESD safe handles in synthetic material with return spring
- Ideal for rework and close assembly needs
- The cutting capacity that is given is for copper wire

	 731415		A mm	B mm	C mm	D mm	G mm	 mm		 g
8211	0101030	1	110	9.5	10	6	4.1	0.2-1.2	Flush	43



8247

80-SERIES OBLIQUE CUTTERS 45° LONG HEAD

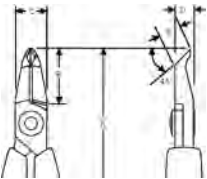

- Material: High performance alloy steel
- Black finish
- Numerically controlled machine grinding guarantees edge angle accuracy and contact; increasing the tools reliability and consistency
- Precision induction hardened edges 63-65 HRC
- Screw joint that minimizes friction and maximizes alignment of cutting edges
- ESD safe handles in synthetic material with return spring
- Ideal for rework and close assembly needs
- The cutting capacity that is given is for copper wire
- "CO" standard handle shape in conductive material

			A mm	B mm	C mm	D mm	G mm			
8247	0051397	1	117.5	18	10	6	6.7	0.2-1.0	Flush	51
8247 CO	0051809	1	117.5	18	10	6	6.7	0.2-1.0	Flush	51

8248

80-SERIES OBLIQUE CUTTERS 45° LONG HEAD, RELIEVED

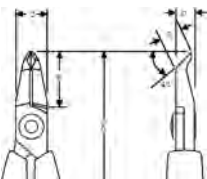

- Material: High performance alloy steel
- Black finish
- Numerically controlled machine grinding guarantees edge angle accuracy and contact; increasing the tools reliability and consistency
- Precision induction hardened edges 63-65 HRC
- Screw joint that minimizes friction and maximizes alignment of cutting edges
- ESD safe handles in synthetic material with return spring
- Ideal for rework and close assembly needs
- The cutting capacity that is given is for copper wire
- "CO" standard handle shape in conductive material

			A mm	B mm	C mm	D mm	G mm			
8248	0051427	1	117.5	18	10	6	6.7	0.2-0.8	Flush	51
8248 CO	0051823	1	117.5	18	10	6	6.7	0.2-0.8	Flush	51



813/814

80-SERIES LEAD CATCHERS



- Patented 80-series accessories hold cut wires, preventing injury and keeping leads from flying into the assembly
- Lead catchers for 8130 and 8140 series can be removed and reused

	 731415			
813	0055852	1	8130-8132, RX 8130-8132	4
814	0055845	1	8140-8148, RX 8140-8148	4

7190, 7191

SUPREME-SERIES DIAGONAL CUTTERS TAPERED HEAD



- Material: High performance alloy steel
- Polished
- Numerically controlled machine grinding guarantees edge angle accuracy and contact, increasing the tools reliability and consistency
- Precision induction hardened edges 58-60 HRC
- Screw joint that minimizes friction and maximizes alignment of cutting edges
- ESD safe handles in synthetic material with return spring
- The cutting capacity that is given is for copper wire
- "CO" standard handle shape in conductive material

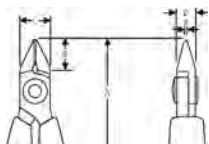

	 731415		A mm	B mm	C mm	D mm	F mm	 mm		
7190	0052479	10	109	9	9	6	1	0.2-1.0	Micro	50
7190 CO	0052790	1	109	9	9	6	1	0.2-1.0	Micro	50
7191	0052509	1	109	9	9	6	1	0.1-1.0	Flush	50
7191 CO	0052806	1	109	9	9	6	1	0.1-1.0	Flush	50



7280

SUPREME-SERIES OBLIQUE CUTTERS REVERSE ANGLE

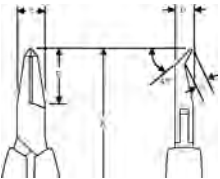

- Material: High performance alloy steel
- Polished
- Numerically controlled machine grinding guarantees edge angle accuracy and contact; increasing the tools reliability and consistency
- Precision induction hardened edges 58-60 HRC
- Screw joint that minimizes friction and maximizes alignment of cutting edges
- ESD safe handles in synthetic material with return spring
- Ideal for use in confined spaces
- The cutting capacity that is given is for copper wire

			A mm	B mm	C mm	D mm	G mm			
7280	0052523	1	118	18	9	6	3.5	0.2-08 mm	Flush	54

7285

SUPREME-SERIES OBLIQUE CUTTERS

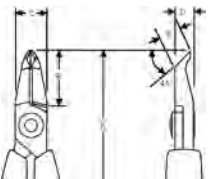

- Material: High performance alloy steel
- Polished
- Numerically controlled machine grinding guarantees edge angle accuracy and contact; increasing the tools reliability and consistency
- Precision induction hardened edges 58-60 HRC
- Screw joint that minimizes friction and maximizes alignment of cutting edges
- ESD safe handles in synthetic material with return spring
- Ideal for rework and close assembly needs
- The cutting capacity that is given is for copper wire

			A mm	B mm	C mm	D mm	G mm			
7285	0052530	1	120	20	9	6	6.7	0.2-1.0 mm	Flush	56



7290,7291

SUPREME-SERIES OBLIQUE CUTTERS

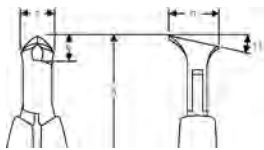

- Material: High performance alloy steel
- Polished
- Numerically controlled machine grinding guarantees edge angle accuracy and contact; increasing the tools reliability and consistency
- Precision induction hardened edges 58-60 HRC
- Screw joint that minimizes friction and maximizes alignment of cutting edges
- ESD safe handles in synthetic material with return spring
- Angled shape ideal for use in confined spaces
- The cutting capacity that is given is for copper wire

	 731415		A mm	B mm	C mm	G mm	 mm		 g
7290	0052547	1	108	8	10.5	15	0.35-1.25	Micro	56
7291	0052554	1	108	8	10.5	15	0.35-1.25	Flush	56

7293

SUPREME-SERIES OBLIQUE CUTTERS

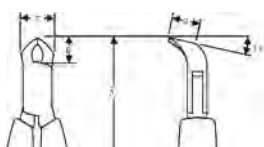

- Material: High performance alloy steel
- Polished
- Numerically controlled machine grinding guarantees edge angle accuracy and contact; increasing the tools reliability and consistency
- Precision induction hardened edges 58-60 HRC
- Screw joint that minimizes friction and maximizes alignment of cutting edges
- ESD safe handles in synthetic material with return spring
- Angled shape ideal for use in confined spaces
- The cutting capacity that is given is for copper wire

	 731415		A mm	B mm	C mm	G mm	 mm		 g
7293	0052592	10	108	8	10.5	8	0.35-1.0	Flush	56



7292

END CUTTERS

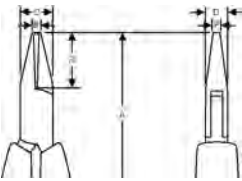

- Material: High performance alloy steel
- Polished
- Numerically controlled machine grinding guarantees edge angle accuracy and contact; increasing the tools reliability and consistency
- Precision induction hardened edges 58-60 HRC
- Screw joint that minimizes friction and maximizes alignment of cutting edges
- ESD safe handles in synthetic material with return spring
- Miniature head ideal for use in confined spaces
- The cutting capacity that is given is for copper wire

			A mm	B mm	C mm	D mm	E mm	F mm			
7292	0052578	1	115	15	9	6	3.2	4	0.35-0.8 mm	Flush	54

7490

SUPREME-SERIES HOLDING PLIERS FLAT NOSE PLIER

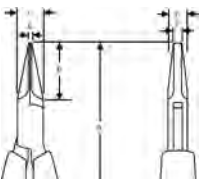

- Material: High performance alloy steel
- Polished
- Numerically controlled machine grinding guarantees accuracy and increases the tools reliability and consistency
- Tough hardened 42-46 HRC
- Screw joint that minimizes friction and maximizes jaw alignment
- ESD safe handles in synthetic material with return spring
- 20 mm of smooth gripping jaws with radiused edges
- "CO" standard handle shape in conductive material

			A mm	B mm	C mm	D mm	E mm	F mm	
7490	0052646	1	120	20	9	6	1.2	3.2	53
7490 CO	0052875	1	120	20	9	6	1.2	3.2	53



7590

SUPREME-SERIES ROUND NOSE PLIERS

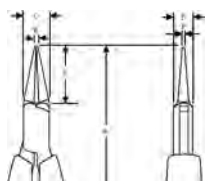

- Material: High performance alloy steel
- Polished
- Numerically controlled machine grinding guarantees accuracy and increases the tools reliability and consistency
- Tough hardened 42-46 HRC
- Screw joint that minimizes friction and maximizes jaw alignment
- ESD safe handles in synthetic material with return spring
- Round jaws with no sharp edges
- "CO" standard handle shape in conductive material

	 731415		A mm	B mm	C mm	D mm	E mm	F mm	 g
7590	0052660	1	120	20	9	6	1.8	0.9	54
7590 CO	0052882	1	120	20	9	6	1.8	0.9	54

7890, 7891

SUPREME-SERIES SNIPE NOSE PLIERS



7890



7891

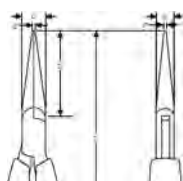

- Material: High performance alloy steel
- Polished
- Numerically controlled machine grinding guarantees accuracy and increases the tools reliability and consistency
- Tough hardened 42-46 HRC
- Screw joint that minimizes friction and maximizes jaw alignment
- ESD safe handles in synthetic material with return spring
- 32 mm jaws with radiused edges
- 7890 with smooth jaws
- 7891 with serrated jaws
- "CO" standard handle shape in conductive material

	 731415		A mm	B mm	C mm	D mm	E mm	F mm	 g
7890	0052691	1	132	32	9	6	1.2	0.8	60
7890 CO	0052899	1	132	32	9	6	1.2	0.8	60
7891	0052714	1	132	32	9	6	1.2	0.8	59
7891 CO	0052905	1	132	32	9	6	1.2	0.8	59



7892

SUPREME-SERIES SNIPE NOSE PLIERS, WITH BENT TIP

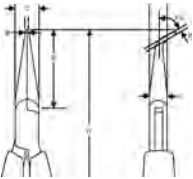
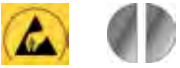

- Material: High performance alloy steel
- Polished
- Numerically controlled machine grinding guarantees accuracy and increases the tools reliability and consistency
- Tough hardened 42-46 HRC
- Screw joint that minimizes friction and maximizes jaw alignment
- ESD safe handles in synthetic material with return spring
- 29 mm of smooth jaws bent at 60° with radiused edges

			A mm	B mm	C mm	D mm	E mm	F mm	
7892	0052738	1	129	29	9	6	1.2	0.8	59

7893

SUPREME-SERIES SHORT SNIPE NOSE PLIERS

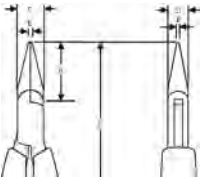

- Material: High performance alloy steel
- Polished
- Numerically controlled machine grinding guarantees accuracy and increases the tools reliability and consistency
- Tough hardened 42-46 HRC
- Screw joint that minimizes friction and maximizes jaw alignment
- ESD safe handles in synthetic material with return spring
- 20 mm of smooth jaws with radiused edges

			A mm	B mm	C mm	D mm	E mm	F mm	
7893	0052769	1	120	20	9	6	1.2	0.8	56

HS6000

MULTIPURPOSE SHEAR

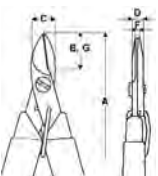

- Multipurpose shear
- High carbon steel blades with a hardness of 57-59 HRC
- Serrations on one edge to prevent the material being cut from sliding away
- Precision screw joint that minimizes friction and maximizes alignment of cutting edges
- User friendly while optimizing durability and precision, fits comfortably in either hand
- ESD safe non-slip grips provide cushioning and secure grasp
- Designed to cut tough Kevlar elements used in fibre optic and other types of cables
- Ideal for many other applications such as cutting insulation, cables, ties and corded material of all types

			A mm	B mm	C mm	D mm	E mm	F mm	
HS6000	0113781	1	145.0	29.0	12.7	6.4	2.2	2.0	88



TL -ET

SOFT TOUCH TWEEZERS, ESD-SAFE



- High quality, precision tweezers with comfortable, soft and “tactile” grips
- Material: Static dissipative material provides reliable ESD protection, anti-acid, anti-magnetic stainless steel for use in many electronic environments
- Finish: Polished
- ESD-safe packaging protects tweezers on workbench and in tool cases

	 731151			 L mm	 g
TL 00-SA-ET	8279219	1	00	120	28
TL 3-SA-ET	8279356	1	3	120	19

TL 00B-SA

HIGH PRECISION TWEEZERS



- High precision tweezers
- Material: Stainless steel, anti-magnetic, anti-acid
- Finish: Polished
- Thick tips and serrated grips

	 731415			 L mm	 g
TL 00B-SA	0109555	1	00B-SA	120	21

TL 00D-SA

HIGH PRECISION TWEEZERS



- High precision tweezers
- Material: Stainless steel, anti-magnetic, anti-acid
- Finish: Polished
- Serrated tips and grips

	 731415			 L mm	 g
TL 00D-SA	0109562	1	00D-SA	120	21

TL 00-SA

HIGH PRECISION TWEEZERS



- High precision tweezers with flat edge and thick tips
- Material: Stainless steel, anti-magnetic, anti-acid
- Finish: Polished



	 731415			 L mm	 g
TL 00-SA	0109579	1	00-SA	120	22
TL 00-SA-SL	0115228	5	00-SA	120	22



TL 0C9-SA

HIGH PRECISION TWEEZERS



- High precision tweezers with flat edge and thick tips
- Material: Stainless steel, anti-magnetic, anti-acid
- Finish: Polished

	 731415			 L mm	 g
TL 0C9-SA	0109586	1	0C9-SA	90	7

TL 0-SA

HIGH PRECISION TWEEZERS



- High precision tweezers with flat edge and fine tips
- Material: Stainless steel, anti-magnetic, anti-acid
- Finish: Polished

	 731415			 L mm	 g
TL 0-SA	0109593	1	0-SA	120	21

TL 10G-SA

HIGH PRECISION TWEEZERS



- High precision tweezers with serrated tips and grips
- Material: Stainless steel, anti-magnetic, anti-acid
- Finish: Polished

	 731415			 L mm	 g
TL 10G-SA	0109609	1	10G-SA	110	13

TL 15AP

HIGH PRECISION TWEEZERS



- Cutting tweezers with parallel cutting tips



	 731415			 L mm	 g
TL 15AP	0109630	1	15 AP	115	27



TL 1-SA

HIGH PRECISION TWEEZERS



TL 1-SA

- High precision tweezers with strong, accurate tips
- Material: Stainless steel, anti-magnetic, anti-acid
- Finish: Polished

	 731415			 L mm	 g
TL 1-SA	0109647	1	1-SA	120	13
TL 1-SA-SL	0115235	5	1-SA	120	13

TL 2AB-SA

HIGH PRECISION TWEEZERS



- High precision tweezers with flat, curved, round tips
- Material: Stainless steel, anti-magnetic, anti-acid
- Finish: Polished

	 731415			 L mm	 g
TL 2AB-SA	0110094	1	2AB-SA	120	15

TL 2A-SA

HIGH PRECISION TWEEZERS



- High precision tweezers with strong, sharp tips
- Material: Stainless steel, anti-magnetic, anti-acid
- Finish: Polished

	 731415			 L mm	 g
TL 2A-SA	0110100	1	2A-SA	120	15
TL 2A-SA-SL	0115259	5	2A-SA	120	15

TL 2-SA

HIGH PRECISION TWEEZERS



- High precision tweezers with strong, sharp-tips
- Material: Stainless steel, anti-magnetic, anti-acid
- Finish: Polished

	 731415			 L mm	 g
TL 2-SA	0110117	1	2-SA	120	15
TL 2-SA-SL	0115242	5	2-SA	120	15



TL 3C-SA

HIGH PRECISION TWEEZERS



- High precision tweezers with very sharp tips
- Material: Stainless steel, anti-magnetic, anti-acid
- Finish: Polished

	 731415			 L mm	 g
TL 3C-SA	0110148	1	3C-SA	110	7
TL 3C-SA-SL	0115273	5	3C-SA	110	7

TL 3C-TA

HIGH PRECISION TWEEZERS



- High precision tweezers with very sharp tips
- Material: Titanium, anti-magnetic, anti-acid
- Finish: Polished

	 731415			 L mm	 g
TL 3C-TA	0110155	1	3C-TA	110	7

TL 3-SA

HIGH PRECISION TWEEZERS



- High precision tweezers with very sharp tips
- Material: Stainless steel, anti-magnetic, anti-acid
- Finish: Polished

	 731415			 L mm	 g
TL 3-SA	0110162	1	3-SA	120	13
TL 3-SA-SL	0115266	5	3-SA	120	13

TL 4-SA

HIGH PRECISION TWEEZERS



- High precision tweezers, tapered and relieved, extra fine tips
- Material: Stainless steel, anti-magnetic, anti-acid
- Finish: Polished

	 731415			 L mm	 g
TL 4-SA	0110186	1	4-SA	110	13
TL 4-SA-SL	0115280	5	4-SA	110	13



TL 51S-SA

HIGH PRECISION TWEEZERS



- High precision tweezers with extra fine, double bent tips
- Material: Stainless steel, anti-magnetic, anti-acid
- Finish: Polished

	 731415			 L mm	 g
TL 51S-SA	0110209	1	51S-SA	115	13

TL 5A-SA

HIGH PRECISION TWEEZERS



- High precision tweezers with extra fine tips
- Material: Stainless steel, anti-magnetic, anti-acid
- Finish: Polished

	 731415			 L mm	 g
TL 5A-SA	0110216	1	5A-SA	115	13
TL 5A-SA-SL	0115303	5	5A-SA	115	13

TL 5B-SA

HIGH PRECISION TWEEZERS



- High precision tweezers with extra fine bent tips
- Material: Stainless steel, anti-magnetic, anti-acid
- Finish: Polished

	 731415			 L mm	 g
TL 5B-SA	0110223	1	5B-SA	110	13

TL 5-SA

HIGH PRECISION TWEEZERS



- High precision tweezers tapered and relieved with extra fine tips
- Material: Stainless steel, anti-magnetic, anti-acid
- Finish: Polished

	 731415			 L mm	 g
TL 5-SA	0110247	1	5-SA	110	12
TL 5-SA-SL	0115297	5	5-SA	110	12



TL 5-TA

HIGH PRECISION TWEEZERS



- High precision tweezers tapered and relieved with extra fine tips
- Material: Titanium, anti-magnetic, anti-acid
- Finish: Polished

	 731415			 L mm	 g
TL 5-TA	0110254	1	5-TA	110	7

TL 65A-SA

HIGH PRECISION TWEEZERS



- High precision tweezers with long, fine curved tips
- Material: Stainless steel, anti-magnetic, anti-acid
- Finish: Polished

	 731415			 L mm	 g
TL 65A-SA	0110278	1	65A-SA	140	12

TL 7A-SA

HIGH PRECISION TWEEZERS



- High precision tweezers with strong, curved tips
- Material: Stainless steel, anti-magnetic, anti-acid
- Finish: Polished

	 731415			 L mm	 g
TL 7A-SA	0110285	1	7A-SA	115	14
TL 7A-SA-SL	0115327	5	7A-SA	115	14

TL 7-SA

HIGH PRECISION TWEEZERS



- High precision tweezers with fine, curved tips
- Material: Stainless steel, anti-magnetic, anti-acid
- Finish: Polished

	 731415			 L mm	 g
TL 7-SA	0110292	1	7-SA	115	13
TL 7-SA-SL	0115310	5	7-SA	115	13



TL AC-SA

HIGH PRECISION TWEEZERS



- High precision tweezers with strong tips and serrated grips
- Material: Stainless steel, anti-magnetic, anti-acid
- Finish: Polished

	 731415			 L mm	 g
TL AC-SA-SL	0115341	5	AC-SA	110	18

TL SS-SA

HIGH PRECISION TWEEZERS



- High precision tweezers with long, slender and fine tips
- Material: Stainless steel, anti-magnetic, anti-acid
- Finish: Polished

	 731415			 L mm	 g
TL SS-SA	0109937	1	SS-SA	140	12
TL SS-SA-SL	0115358	5	SS-SA	140	12

TL 124-SA

GENERAL PURPOSE TWEEZERS



- High precision tweezers with strong, double-bent tips and serrated grips and tips
- Material: Stainless steel, anti-magnetic, anti-acid
- Finish: Polished

	 731415			 L mm	 g
TL 124-SA	0110018	1	124-SA	150	20

TL 2AX-SA

GENERAL PURPOSE TWEEZERS



- Reverse action tweezers, 2A style
- Material: Stainless steel, anti-magnetic, anti-acid
- Finish: Polished

	 731415			 L mm	 g
TL 2AX-SA	0110025	1	2AX-SA	120	15



TL 475-SA

STRONG PRECISION TIP TWEEZERS



- General purpose tweezers with strong blunt tips and serrated grips and tips
- Material: Stainless steel, anti-magnetic, anti-acid
- Finish: Polished

	 731415			 L mm	 g
TL 475-SA	0110032	1	475-SA	140	25

TL 648-SA

STRONG PRECISION TIP TWEEZERS



- General purpose tweezers with fine tips and serrated grips and tips
- Material: Stainless steel, anti-magnetic, anti-acid
- Finish: Polished

	 731415			 L mm	 g
TL 648-SA	0110049	1	648-SA	150	25

TL 649-SA

STRONG PRECISION TIP TWEEZERS



- General purpose tweezers with fine, serrated and bent tips
- Material: Stainless steel, anti-magnetic, anti-acid
- Finish: Polished

	 731415			 L mm	 g
TL 649-SA	0110063	1	649-SA	150	25

TL 231-SA

STRONG PRECISION TIP TWEEZERS



- General purpose tweezers with strong serrated precision tips
- Material: Stainless steel, anti-magnetic, anti-acid
- Finish: Polished

	 731415			 L mm	 g
TL 231-SA	0110087	1	231-SA	120	14



TL 577-SA

PRECISION COMPONENT HANDLING TWEEZERS



- Tweezers with straight tips, \varnothing 4 mm, for components \varnothing 2.0 mm with serrated grips
- Material: Stainless steel, anti-magnetic, anti-acid
- Finish: Polished

	 731415			 L mm	 g
TL 577-SA	0110421	1	577-SA	115	13

TL 578-SA

PRECISION COMPONENT HANDLING TWEEZERS



- Tweezers with angled tips 90° , \varnothing 6 mm, for components \varnothing 2,0 mm with serrated grips
- Material: Stainless steel, anti-magnetic, anti-acid
- Finish: Polished

	 731415			 L mm	 g
TL 578-SA	0110438	1	578-SA	115	15

TL 582-SA

PRECISION COMPONENT HANDLING TWEEZERS



- Tweezers with angled tips 90° , \varnothing 4 mm, for components \varnothing 1,0 mm with serrated grips
- Material: Stainless steel, anti-magnetic, anti-acid
- Finish: Polished

	 731415			 L mm	 g
TL 582-SA	0110452	1	582-SA	115	15

TL AA-S

BOLEY STYLE TWEEZERS



- Boley style tweezers with strong fine tips
- Material: Stainless steel
- Finish: Polished

	 731415			 L mm	 g
TL AA-S	0110544	1	AA-S	130	16



TL AA-SA

BOLEY STYLE TWEEZERS



- Boley style tweezers with strong fine tips
- Material: Stainless steel, anti-magnetic, anti-acid
- Finish: Polished

	 731415			 L mm	 g
TL AA-SA	0110551	1	AA	130	17
TL AA-SA-SL	0115334	5	AA	130	17

TL AA-TA

BOLEY STYLE TWEEZERS



- Boley style tweezers with strong fine tips
- Material: Titanium, anti-magnetic
- Finish: Polished

	 731415			 L mm	 g
TL AA-TA	0110575	1	AA-TA	130	10

TL MM-SA

BOLEY STYLE TWEEZERS



- Boley style tweezers with strong tips
- Material: Stainless steel, anti-magnetic, anti-acid
- Finish: Polished

	 731415			 L mm	 g
TL MM-SA-SL	0115365	5	MM-SA	130	15

TL 251-SA

TWEEZERS WITH FIBRE TIPS



- Tweezer with special tip
- Material: Stainless steel body and carbon fibre tips
- Finish: Polished
- Tips are 10 mm

	 731415			 L mm	 g
TL 251-SA	0110643	1	251-SA	110	17



TL 252-SA



TWEEZERS WITH FIBRE TIPS

- Tweezer with special tip
- Material: Stainless steel body and carbon fibre tips
- Finish: Polished
- Tips are 6 mm

	 731415			 L mm	 g
TL 252-SA	0110650	1	252-SA	110	17

TL 253-SA



TWEEZERS WITH FIBRE TIPS

- Tweezer with special tip
- Material: Stainless steel body and carbon fibre tips
- Finish: Polished
- Tips are 2.5 mm

	 731415			 L mm	 g
TL 253-SA	0110667	1	253-SA	110	17

TL 269CF-SA



TWEEZERS WITH FIBRE TIPS

- Tweezer with special tip
- Material: Stainless steel body and carbon fibre tips
- Finish: Polished
- Tips are 3 mm, 2A style

	 731415			 L mm	 g
TL 269CF-SA	0110735	1	269 CF-SA	130	16

TL 249CFR-SA



TWEEZERS WITH REPLACEABLE CARBON FIBRE TIPS

- Tweezer with special tip
- Material: Stainless steel body and carbon fibre tips
- Finish: Polished
- Tips have flat edge and thick tips

	 731415			 L mm	 g
TL 249CFR-SA	0115143	1	249 CFR-SA	130	17



TL 259CFR-SA

TWEEZERS WITH REPLACEABLE CARBON FIBRE TIPS



- Tweezer with special extra fine tips
- Material: Stainless steel body and carbon fibre tips
- Finish: Polished

	 731415			 L mm	 g
TL 259 CFR-SA	0115150	1	259CFR-SA	130	19

TL 00CFR-SA

TWEEZERS WITH REPLACEABLE CARBON FIBRE TIPS



- Tweezer with flat edge and thick tips
- Material: Stainless steel body and carbon fibre tips
- Finish: Polished

	 731415			 L mm	 g
TL 00CFR-SA	0115402	1	00CFR-SA	130	19

TL 2ACFR-SA

TWEEZERS WITH REPLACEABLE CARBON FIBRE TIPS



- Tweezer with special flat round tips
- Material: Stainless steel body and carbon fibre tips
- Finish: Polished

	 731415			 L mm	 g
TL 2ACFR-SA	0115419	1	2A CFR-SA	130	19

TL 5CFR-SA

TWEEZERS WITH REPLACEABLE CARBON FIBRE TIPS



- Tweezer with special extra fine tips
- Material: Stainless steel body and carbon fibre tips
- Finish: Polished

	 731415			 L mm	 g
TL 5CFR-SA	0115426	1	5 CFR-SA	130	19



TL 7CFR-SA

TWEEZERS WITH REPLACEABLE CARBON FIBRE TIPS



- Tweezer with fine curved special tips
- Material: Stainless steel body and carbon fibre tips
- Finish: Polished

	 731415			 L mm	 g
TL 7CFR-SA	0115433	1	7 CFR-SA	130	19

TL 249ACF

REPLACEMENT TIPS



- Flat edge and thick tips
- Includes 2 tips and 2 screws in a plastic bag

	 731415			 L mm	 g
TL 249 ACF	0115174	1	249 ACF	40	2

TL 259ACF

REPLACEMENT TIPS



- Extra fine tips
- Includes 2 tips and 2 screws in a plastic bag

	 731415			 L mm	 g
TL 259 ACF	0115167	1	259 ACF	40	2

TL 2AACF

REPLACEMENT TIPS



- Replacement tips
- Includes 2 tips and 2 screws in a plastic bag

	 731415			 L mm	 g
TL 2AACF	0115457	1	2AACF	40	2



TL 5ACF



REPLACEMENT TIPS

- Replacement tips
- Includes 2 tips and 2 screws in a plastic bag

	 731415			 L mm	 g
TL 5ACF	0115464	1	5 ACF	40	2

TL 7ACF



REPLACEMENT TIPS

- Fine curved tips
- Includes 2 tips and 2 screws

	 731415			 L mm	 g
TL 7ACF	0115471	1	7 ACF	130	19

TL SM103-SA



SMD TWEEZERS

- High precision tweezers for handling and positioning 2 and 3 lead SOT packages at 45° angle
- Material: Stainless steel, anti-magnetic, anti-acid
- Finish: Polished

	 731415			 L mm	 g
TL SM 103-SA	0110773	1	SM 103-SA	115	15

TL SM104-SA



SMD TWEEZERS

- High precision tweezers for handling and positioning 3 lead SOT packages, monolithic chip capacitors, etc.
- Material: Stainless steel, anti-magnetic, anti-acid
- Finish: Polished

	 731415			 L mm	 g
TL SM 104-SA	0110780	1	SM 104-SA	120	15



TL SM105-SA

SMD TWEEZERS



- High precision tweezers for placing SOT packages vertically

	 731415			 L mm	 g
TL SM 105-SA	0110797	1	SM 105-SA	120	15

TL SM107-SA

SMD TWEEZERS



- High precision tweezers for positioning all flat devices at 60° angle
- Material: Stainless steel
- Finish: Polished

	 731415			 L mm	 g
TL SM 107-SA	0110810	1	SM 107-SA	120	15

TL SM108-SA

SMD TWEEZERS



- High precision tweezers for positioning and soldering 1 mm wide components
- Material: Stainless steel, anti-magnetic, anti-acid
- Finish: Polished
- Tips grooved inside

	 731415			 L mm	 g
TL SM 108-SA	0110827	1	SM 108-SA	120	15

TL SM109-SA

SMD TWEEZERS



- High precision tweezers for positioning and soldering 1 mm wide components
- Material: Stainless steel, anti-magnetic, anti-acid
- Finish: Polished
- Tips 45° angle and grooved inside

	 731415			 L mm	 g
TL SM 109-SA	0110834	1	SM 109-SA	120	15



TL SM110-SA

SMD TWEEZERS



- High precision tweezers with grooved tips for positioning monolithic chip capacitors
- Material: Stainless steel, anti-magnetic, anti-acid
- Finish: Polished

	 731415			 L mm	 g
TL SM 110-SA	0110841	1	SM 110-SA	120	15

TL SM111-SA

SMD TWEEZERS



- High precision tweezers for positioning 5 mm monolithic chip capacitors with flat base
- Material: Stainless steel, anti-magnetic, anti-acid
- Finish: Polished
- Grooved tips 2 mm long

	 731415			 L mm	 g
TL SM 111-SA	0110858	1	SM 111-SA	120	15

TL SM115-SA

SMD TWEEZERS



- Tweezers with grooved tips at 30° angle for holding and positioning cylindrical devices up to \varnothing 1 mm
- Material: Stainless steel body and carbon fibre tips
- Finish: Polished

	 731415			 L mm	 g
TL SM 115-SA	0110896	1	SM 115-SA	120	15

TL SM117-SA

SMD TWEEZERS



- High precision tweezers for positioning SOT packages at 30° angle
- Material: Stainless steel, anti-magnetic, anti-acid
- Finish: Polished

	 731415			 L mm	 g
TL SM 117-SA	0110919	1	SM 117-SA	120	15



9854

TWEEZER SETS



- SMD tweezers set, 7 pcs
- 9854W: Empty wallet

	 731415		 mm		 g
9854	0111831	1	180x200x20	TL 5C-SA, TL 5-SA-SL, TL SM 101-SA, TL SM 102-SA, TL SM 107-SA, TL SM 108-SA, TL SM 115-SA	140
9854W	0112760	1	180x200x20		

TL 5C-SA
115 mm



TL SM 107-SA
120 mm



TL 5-SA-SL
110 mm



TL SM 108-SA
120 mm



TL SM 101-SA
115 mm



TL SM 115-SA
120 mm



TL SM 102-SA
115 mm



9855

TWEEZER SETS



- High precision tweezer set, 5 pcs
- 9855W: Empty wallet

	 731415		 mm		 g
9855	0111848	1	110x200x10	TL SS-SA-SL, TL AA-SA-SL, TL 2A-SA-SL, TL 4A-SA-SL, TL 7A-SA-SL	115
9855W	0112777	1	110x200x10		

TL SS-SA-SL
140 mm



TL 4-SA-SL
110 mm



TL AA-SA-SL
130 mm



TL 7A-SA-SL
115 mm



TL 2A-SA-SL
120 mm



9856

TWEEZER SETS



- Titanium tweezer set, 4 pcs

	 731415		 mm		 g
9856	0111855	1	110x200x10	TL 3C-SA, TL 3-TA, TL 5-TA, TL AA-TA	75

TL 3C-TA
110 mm



TL 5-TA
110 mm



TL 3-TA
120 mm



TL AA-TA
130 mm





9857

TWEEZER SETS



- High precision tweezer set, 5 pcs
- 9855W: Empty wallet

	 731415		 mm		 g
9857	0114283	1	110x200x10	TL 00-SA-SL, TL 1-SA-SL, TL 3C-SA-SL, TL 5-SA-SL, TL 7-SA-SL	115

9855W	0112777	1	110x200x10		
-------	---------	---	------------	--	--

TL 00-SA-SL 120 mm		TL 5-SA-SL 110 mm	
TL 1-SA-SL 120 mm		TL 7-SA-SL 115 mm	
TL 3C-SA-SL 110 mm			

9858

TWEEZER SETS



- Fine tip tweezer set, 2 pcs
- 9858W: Empty wallet

	 731415		 mm		 g
9858	0111862	1	65x200x8	TL AA-SA-SL, TL SS-SA-SL	60

9858W	0112784	1	65x200x8		
-------	---------	---	----------	--	--

TL AA-SA-SL 130 mm		TL SS-SA-SL 140 mm	
-----------------------	--	-----------------------	--

9859

TWEEZER SETS



- Strong tip tweezer set, 2 pcs

	 731415		 mm		 g
9859	0113057	1	65x200x8	TL 00B-SA, TL 2A-SA	75

TL 00B-SA 120 mm		TL 2A-SA-SL 120 mm	
---------------------	--	-----------------------	--



MA500-1 - MA500-3

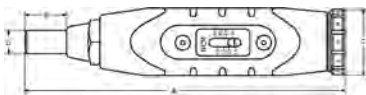

TORQUE SCREWDRIVERS

- Adjustable torque screwdriver
- Accuracy $\pm 6\%$
- Over-torque limiting clutch
- ESD safe (IEC 61340-5-1 & EN 100015-1)
- 1/4" hex non-magnetic spring loaded bit holder to avoid damaging sensitive equipment or components in electronic applications
- ISO 6789, ISO 1174

	 731415				A mm	B mm	C mm	D mm	 g
MA500-1	0112395	1	1/4	10-80 cNm	138	18.2	28	9.6	195
MA500-2	0112401	1	1/4	40-200 cNm	157	18.2	28	9.6	260
MA500-3	0112418	1	1/4	50-450 cNm	171	18.2	32	9.6	306

PS501-2

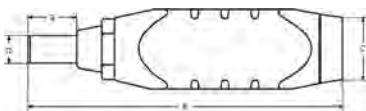







TORQUE SCREWDRIVERS

- Preset Torque Screwdriver
- Cam-over torque limiting clutch for repeatability and accuracy
- 1/4" hexagon
- Non-magnetic spring loaded bit holder to avoid damaging sensitive equipment or components in electronic applications (1/4" 6.3 DIN 3126, ISO 1174)
- An adaptor makes it possible to use 1/4" sockets (1/4" 6.3 DIN 3120, ISO 1174)
- Accuracy: $\pm 6\%$
- DIN/ISO 6789, EN 26789/1994







	 731415				A mm	B mm	C mm	D mm	 g
PS501-2	0112432	1	1/4	7-70 cNm	141	18.2	28	9.6	187



ALPHANUMERICAL INDEX







					
020	450	1031	1025	1470K6	788
021	450	1084	610	1470K7	789
022	451	10RM	160	1475K8	782
023	451	10RM/	160	1475KXL12TSS	786
024	452	111M	149	1475KXL6	783
025	452	111M/	150	1475KXL7	784
026	453	111M/SH	150	1475KXL7TW	785
027	453	111M/T	150	1480K4	790
028	454	111M/T15/6	794	1519D	593
029	454	111M/T4/8	793	1520D	546
030	451	111M/T6/7	793	1520G	545
031	455	111Z	151	1544	947
032	456	111Z/	152	1547	947
032.1/4	455	1150	947	158-N	555
033	459	1150D	947	158-NB	559
033	863	1157	1102	166-2	104
034	459	1162N	937	166/167-12	105
034	863	1175	606	168 - 1P	103
035	460	1177-SCRIBE	945	168 - 3P	104
035	864	1178-SCRIBE	946	168-6	104
036	460	1179-FLX	939	168-C	105
036	864	1179-SCRIBE	946	168-C-G	105
037	456	11M	153	187/264/340	217,268
038	457	11M/	154	190	475
039	457	1300Z	177	191	475
040	458	1320RM	162	192	476
		1320RM/	162	193	476
1-100...-0	72	1320RZ	162	1931M	170
1-100...-2	72	1320SRM	163	1931M/	170
1-102	73	1320SRM/	163	1931Z	171
1-104	73	133SGM	184	1931Z/	171
1-106...-0	73	14-24	1014	1933M/	172
1-106...-2	74	140-147	607	1936M	189
1-110...-0	74	141	477	1936M/	189
1-110...-2	75	1410/1420	606	194	477
1-111...-0	75	1411-1415	758	1943M	179
1-111...-2	76	1418A-K	758	1949M	180
1-115	76	1418S	758	1949Z	180
1-143...-0	76	1419-MD	704	195	478
1-143...-2	77	1419/4	759	1950M	181
1-160...-0	77	142	481	1950MZ	181
1-160...-2	78	142	871	1952M	155
1-170...-0	78	1420-1424	757	1952M/	156
1-170...-2	79	143	479	1952M/SH	156
1-210...-0	79	1435/5	757	1952M/T	156
1-210...-2	80	1435/8	757	1952Z	157
1-230...-0	80	1450D-ISO	761	1952Z/T	157
1-230...-2	81	1450D-WW	761	196	480
1-320...-0	81	1450D/2	761	196	870
1-473	82	1450L-SP	826	197	481
1-476	82	1460M/1	759	197	870
1-477	83	1460M/2	759	1976TORX	525
1-478	83	1460Z/2	760	1976TORX/	525
1-479	84	1467-250	601	198	479
		1467-320-850	601	1986TORX	523
10	1012	1467-520	601	1986TORX/	524
1019/1067/13561	507	1470K5	787	199	482









					
199	871	202.031	865	219.102	483
1995LM	513	202.032	464	219.105	483
1995M	512	202.032	866	219.109	484
1995M/	513	202.033	463	219.110	484
1995TORX	519	202.033	866	219.600	486
1995TORX/	520	202.035	463	219.600	872
1995Z	516	202.035	865	219.601	487
1996M	517	204	960	219.601	873
1996TORX	522	2045	961	219.602	487
1996TORX/	522	2047	526	219.602	873
1997M	509	2047PR	526	219.605	486
1997M/T	509	2058/S26	417	219.605	872
1998M	511	2058/S26-2	418	2190PD	543
1998M/	511	208	985	2191V	875
1998M/8R	512	209	960	2192	959
1999M/7H	510	2092	961	2193	959
1999MV	888	2094	961	221 D - 225 D	597
		2101D	542	2212	959
1RM	158	2101G	540	2213	960
1RM/	158	2101G-A	540	2220	708
1RM/T2/4	796	2101G-AHL	541	2223D	567
1RM/T6/8	796	2101GC	541	2223G	566
1RMA/S4	164	2101PG	542	2223GC	566
1RMA/S8	164	2101S	544	2223S	567
1RZ	159	2101S	876	2223S	881
1RZ/	159	211	961	2223V	880
		2120	962	2233D	582
2-21-51	1012	2122	962	2235-160	584
2-300	85	2123	962	225-PLUS	982
2-300-D - 2-304-D	91	2125	963	2250V	882
2-301	85	2126	963	2252	507
2-302	86	2127	963	2260V	882
2-303	86	213	962	228	985
2-304	87	2145PD	543	228-P	987
2-305	87	2145xxxC	969	228-SD	1061
2-306	87	2145xxxD	969	228-SET	1062
2-306-D - 2-308-D	92	2145xxxL	969	229-SD	1062
2-307	88	215	987	23	1015
2-308	88	2150	958	230-SD	1062
2-309	88	2155	956	2301	965
2-313	89	2156	957	2301MB	965
2-470	89	216	957	2302	965
2-471	90	216	987	2302MB	966
2-472	90	2161	958	2303	966
2010	927	2165	957	2303MB	966
2010-L	928	2171G	545	2304	966
202	960	2171V	875	2304MB	967
202.005	461	218	985	2307	967
202.006	461	219	958	2307MB	967
202.007	461	219	985	2308	967
202.008	462	219.000	484	2309	968
202.013	463	219.001	485	2309MB	968
202.020	458	219.002	485	232	456
202.021	458	219.003	485	233	1008
202.030	462	219.005	486	2339	592
202.030	865	219.100	482	2339D	592
202.031	462	219.101	483	234-A	1008



ALPHANUMERICAL INDEX







					
234-W	1008	250703000	956	2704	1043
2360	968	2509	923	2705R	1043
2361	968	2510	923	2707	1043
238	984	2520	583	2713A	563
239	984	2520S	883	2718	562
2420G	560	2521D	565	2718B/2458B	561
2421D	561	2521G	564	2719SB/2457B/2456AB	554
2421G	560	2521GC	564	2720	584
2421GC	561	2521V	880	2724B/2694B	562
2421V	880	2530	922	2727	565
2427D	557	2535F	704	2727B/2698B	565
2427G	556	255	1003	2744	1041
2427GC	556	255-15/29	1003	2787F	574
2427S	557	2555	132	2787G	574
2427S	879	256	1003	27M	190
2427V	879	2600	993	27M/	190
2430D	553	2600-16	994	27M/T	191
2430G	552	2619LS	596	28-29/S4	578
2430G-HD	553	2619V	884	2800	577
2430GC	552	2620-80	583	2800-2900/T8/4	812
2430S	554	2628D	548	2800N-2801N	582
2430S	878	2628G	547	2804-2805	583
2430V	878	2628GC	547	2804CC	584
244	1006	2628S	548	2806	881
2444	1047	2628S	877	2816	1044
2448	1026	2630D	549	2817	1044
244P	1006	2630GC	549	2817K	1045
2456B	558	2632	762	2819	1045
2456BB	558	2633/	920	2820EF1	1046
2456BVDE	558	2635	620	2820EF2	1046
2457/2456A	554	2640D	550	2820EF3	1046
2457VDE/2456AVDE	555	2646 - 2648A	573	2820EF4	1047
2460	581	2646M - 2649	573	2820EK	1046
2461	580	2646MF	575	2820HSV1	891
2463	580	2646MS	575	2820HSV2	892
2464	581	2646MT	575	2820V	888
2465D	582	2650	598	2820VBC	883
2466	581	2656/2656A	574	2820VDE	893
2468	678	2656R	576	2820VFP	894
2470G	555	2656S	576	2820VGCOT	895
2471G	563	2665B	550	2820VHELP	893
2477AB	559	2665VDE	551	2820VM	894
2477BB	559	2666NB-2676NB	544	2820VP	892
2477G-200	557	2667B-2678B	544	2820VPC	892
2484/S4	763	2667NVDE-2676NVDE	545	2820VTEE	893
2487	922	2678G	551	2855	600
2488	954	2678V	877	2890	577
2489	955	268	984	28M	187
2491	955	2681	600	28M/	187
2500	964	2681-2635/T8/2	818	28M/T15/13	799
2500 XT	1006	2686	546	28M/T20/6	799
2501	964	2688D	550	28MV	887
2502	964	2694VDE/2458VDE	562	29-B/BWXW1/BWXW2	692
2504	963	2698VDE	566	2900	577
250501800	970	26S	191	2928	579
250502450	970	2700	993	2928-1 - 4	580
250600010	956	2702	1043		



					
2949	591	306	611	3419A	568
2950	587	306	983	3419B	569
2951	586	306-15-95	611	349	1169
2951/T8/3	817	3064	1070	350.008.1	465
2952	586	3066	1070	350.008.2	465
2953	587	3067	1070	350.011	464
2955	587	3068	1071	3524	922
2957	588	3069	1071	3525HB	922
2958	588	3079	1071	361	609
296	1007	3085	944	3625N	1089
2963	589	3090	994	3625PU	1085
2964	589	31/86/87	146	3625PU-105	1085
2965	588	3100TB	780	3625RM	1090
2966	589	310M	186	3625S	1090
2967	590	311-32	613	3625W	1090
2968	586	311-42	613	3625Y	1088
2971G	596	312-42	613	363	615
2979D	564	3126N/3128N	833	3643	1105
2990	578	3140N/3141N/3149	834	3644	1105
2997	591	3150	995	3646	1106
2998	590	315M	185	3646/6	1106
2999	590	315Z	185	3654R	1108
29M	188	316-1	614	3656/10	1108
29M/	188	316-2	614	3658A	1106
29M/T15/13	800	316-2-95	614	3658A/6	1107
29M/T20/6	800	316107000	942	3659	1107
		317	615	3659/8	1107
2M	175	317	983	3659/8T	1108
2M/	175	318	614	3680	762
2M/S	176	3180	994	3681	762
2M/T10/5	797	319	982	3683	762
2M/T8/7	797	320	983	3684	763
2MV	887	321	984	369	1007
2Z	176	321-SB	988	370	616
		3225	916,917	372	616
3-24-51	1013	3240	995	3732	1104
3-330	93	325	982	3733	1103
3-331	93	3250	915	3734	1103
		3260	915	3734N	1103
300	1005	3270	918	3734S/6	1105
301	1009	3280	918	3735	1102
301-22	611	3280M/	172	3735-AU	1104
302	1010	3290	918	3735N	1102
302-35	612	3291	919	3736M	1099
302-6X4P	1010	3295	916	3736MH	1099
302-76	612	3296	917	3736S/6	1104
302M	1011	331	1013	3739-250 / -400	1100
302S	1011	332	1012	3739H	1100
302W	1011	333	1014	3740	1098
303	1009	333-5	1015	3745	1098
304	983	3365NM	831	375	615
3045/1VDE	896	3370M	832	3750	1099
3045V-1	896	339-/340-	1170	3750H	1099
3045V-2	897	341-343	607	38	593
3046-OP	925	3417NF	568	38	1084
3046-REF	679	3417NFB	567	38-8 - 38-24	694
3049-2	926	3417NFVDE	568	380	609



ALPHANUMERICAL INDEX

					
3802	34	3857 Easy-Cut	22	4106	194
3802 KA	35	3860 Unset Carbide TMC	28	4130,4131	569
3806-SPIRO	988	3868 Carbide Triple Set® TSS	27	414	1022
3809	32	3868 Carbide Triple Set® TSX	26	414-S	1023
3809 KA	33	3869 Carbide Triple Set®	30	41RM	161
3810	988	3870	30,31	41RM/S8	161
3816	988	3870	852	420	1069
383-/384-	1170	3881 Carbide Multi Set THQ	27	420SC	1072
3830-C	37	3881 Carbide Multi Set THS	28	4211-/4212-	1170
3830-VIP	36	39-24	694	422P	1026
3832	38	3905	986	4231	570
3834-103	48	3906	986	4239	570
3834-42	42	396-HP	1169	424P	1021
3834-53	42	396-HP-BLADE	1172	424P-S3-EUR	1022
3834-61	42	396-JS	1168	424P-S6/S8	1022
3834-62	43	396-JS-BLADE	1171	425	1023
3834-62-16/50	43	396-JT	1169	425-081/082	1024
3834-65-16/51	44	396-JT-BLADE	1172	425-083	1024
3834-65-22/64	44	396-LAP	1007	4250	1112
3834-72	45			4250M	1112
3834-73	45	4-138...-0	94	4255	1112
3834-73-22/68	45	4-138...-2	95	426	940
3834-86	46	4-140...-0	95	426TOR9	940
3834-87	46	4-140...-2	95	427	1082
3834-92	47	4-142	96	428	1082
3834-94	47	4-144...-0	96	4280	1113
3834-95	48	4-144...-2	96	429	1082
3834-ADP	41	4-152	97	42H	418
3834-ARBR	39	4-153	97	4300	1113
3834-DP	41	4-154	97	4307/4310	194
3834-DRL	40	4-155	98	434	1020
3834-DRL-CT	40	4-183...-0	98	434-S3-EUR	1020
3834-ES	41	4-183...-2	98	434-S6-EUR	1021
3834-EXT	40	4-186...-0	99	4400	1109
3834-MRS	41	4-186...-2	99	4400-/4420-	1172
3840	53	4-187...-0	99	4401	1109
3840 DSL	51	4-187...-2	100	441	1059
3840 F&R	52	4-188...-0	100	442 B-444 B	607
3840 HST	52	4-188...-2	100	4430	570
3840 SC	50	4-190...-0	101	446	940
3840 SL	50	4-190...-2	101	4480/	617
3840 ST	49	4-192...-0	101	4480M	617
3840 UST	51	4-192...-2	102	449/442/451	953
3840-5/10	53	4-202 - 4-204	102	450-80/450-130	1072
3840-P	54	4-272...-0	102	451	1060
3842	54	4-272...-2	103	451/	1061
3844	55	400.003.020	618	4518	747
3845	54	400.003.030	618	4519	753
3846	55	4003M	275	4519/S	753
385-/386-	1171	4020L-M	154	4521N	750
3851 Contour	23	4040M	191	4521N/7	751
3851 Sandflex® Cobra™	24	4040M/6T	192	4522	750
3851 Sandflex® Cobra™ Foundry	29	4040M/S6	192	4523G	751
3851-Sandflex® Cobra™ PSG	25	4040M/T12/8	801	4524G	751
3853 Sandflex® Top Fabricator	29	4040Z	192	4528	746
3854-Sandflex® King Cobra™ PQ	26	40B	194	4528M	746
3854-Sandflex® King Cobra™ PHG	25	41 -JT	1168	4529	744



4530	572	4750-HDBS-1	770	541D	592
4532	742	4750-HDLB	775	5423	921
4532-0	742	4750-HHO	772	5463	907
4532/S	743	4750-HMPH-1	774	5463AMT	906
4532K	743	4750-HMPH-2	775	5464	907
4532K0	743	4750-JU3PB	770	5465	908
4532LK	743	4750-KNHO-1	773	5465AMT	906
4532ST/5	744	4750-KP	777	5467	908
4533	744	4750-LBBLM/LBBLL-1	776	5467AM	907
4537	745	4750-LBBRM/LBBRL-1	776	5468	900
4540	749	4750-LUBA-1	781	5469	900
4541	745	4750-MOSBA-1	781	5469AMI	907
4542	745	4750-MTHO-1	773	5469AMT	906
4543	746	4750-QRLB	776	5469B	900
4543/S	747	4750-ROCO-1	780	5470	908
4544	747	4750-SLTC-1	779	5471F	901
4545	748	4750-TOBA-1	780	5473	908
4545-N	748	4750-TOCS-1	779	5475R/5475K	901
4551	748	4750-TOCSAE-1	778	5476H	909
4552	749	4750-TOCSSL-1	778	5479	909
4553	754	4750-TOCST-1	779	5484R	910
4559	585	4750-UP	771	5488AM	913
4559 JC	585	4750-VMPH-1	774	5489AM	913
4560-210	585	4750-VMPH-2	774	5490AM	913
4574	755	479	1087	5491AM	913
4577	756	480	1083	5492AM	914
4580N/7	752	481	1086	5493	914
4581N-4583N	752	482	1087	5515B	924
4581NA-4583NB	752	483	1083	5515GV	924
4591-4593	755	4830, 4831	571	5515L	923
45M	418	4833	571	5515M	923
460	1054	484	1084	5515T	924
460-PB	1055	485	1083	5515T-52	924
4610	754	486	1084	5516	902
4611	754	487	1089	5517	909
4614	753	489	1086	5518	909
463	1056	490	1087	5540AM	902
463-L	1057	492	1088	5541AM	902
463-PB	1057	494	1085	5543AM	903
464	1056	4M	178	5544AM	903
464-PB	1058	4M/	179	5545AM	903
466	941	4M/T	178	5546AM	903
466	1058			5547AM	904
466-250	941	5-600-D - 5-670-D	92	5549AM	904
4724-JT/4728-JT	1171	502	1010	5550	920
474	955	502/	1010	5551-5554	921
4750-2PP	771	5050	738	5568/5	914
4750-3PB	770	51	1014	5570/7	912
4750-BAPA-1	780	51 -JS	1168	5571	910
4750-BAPA-2	781	52	132	5572	910
4750-BWC-1	777	5223 - 5226 DC	597	5573	910
4750-DHO	772	527D	546	5574	911
4750-DHOP-1	772	527V	876	5575	911
4750-EP	771	528-700	1027	5576	912
4750-FOLTC-1	777	528-COM	1027	5577	912
4750-GNP-1	773	5418	919	5578	911
4750-HDB-1	775	5419/6T	920	5579	911



ALPHANUMERICAL INDEX



5583AM	904
5584AM	904
5586AM	905
5587GAM	905
5588AM	905
5589AM	905
5590AM	906
5600/4	921
5724-JS/5728-JS	1171
583D	1039
584D	1039
585D	1039
586D	1040
59/S28-4	417
59S/	385
59S/ 3P	385
59S/125PH	388
59S/125PZ	391
59S/150T	394
59S/17-1	410
59S/17-2	410
59S/17-3	411
59S/22-1	416
59S/22-2	416
59S/31-1	408
59S/31-2	408
59S/31-3	409
59S/50	386
59S/50H	398
59S/50PH	387
59S/50PH 2P	387
59S/50PZ	390
59S/50PZ 2P	390
59S/50R	399
59S/50T	393
59S/50T 2P	393
59S/7-1	412
59S/7-2	412
59S/7-3	413
59S/7-4	413
59S/70PH	388
59S/70PZ	391
59S/70T	394
59S/70T 2P	394
59S/70TR	396
59S/H "	397
59S/H 3P	397
59S/H BALL	398
59S/H BALL 3P	398
59S/H mm	396
59S/M	401
59S/PH	386
59S/PH 30P	387
59S/PH 3P	386
59S/PH COMBI 2P	401
59S/PH2G	388
59S/PH2G-30P	389



59S/PZ	389
59S/PZ 30P	390
59S/PZ 3P	389
59S/R	399
59S/R 3P	399
59S/T	391
59S/T 30P	392
59S/T 3P	392
59S/TR	395
59S/TR 3P	395
59S/TS mm	400
59S/TW	400
6	507
6-342...-0	106
6-342...-2	106
6-343...-0	106
6-343...-2	107
6-344...-0	107
6-344...-2	107
6-345...-0	108
6-345...-2	108
6-470	84
600	610
600	760
600-3	491
600-x-95	610
600S/T10/9	807
6010	1073
6010H	1075
6010M	1075
602-4	491
604-5	491
6040M/H	1076
605-6	492
606-6	492
6070H	1075
6072	1073
6072M	1075
608-6	492
60T/17-1	411
60T/31-1	409
60T/7-1	414
60T/PH	375
60T/PH 2P	375
60T/PZ	375
60T/PZ 2P	376
60T/T	376
60T/T 2P	377
610-6	493
611	488
612-5	493
613	488
614	489
615	488
616	489
617	490









618	489
61H/50PH	378
61H/50PZ	379
61H/50T	380
61H/PH	377
61H/PH 2P	378
61H/PZ	378
61H/PZ 2P	379
61H/T	379
62	420
620-6	493
620-6	874
6224DC	596
6224GC	597
6224V	884
623	490
623	874
625	490
625	874
625	952
625-	953
62TIN/50PH	373
62TIN/50PZ	374
62TIN/7-1	415
62TIN/PH	373
62TIN/PZ	373
62TIN/PZ 2P	374
62TIN/T	374
6330M	925
63D/50PH	370
63D/50PZ	371
63D/7-1	415
63D/PH	369
63D/PH 2P	369
63D/PH2G	369
63D/PH2G-2P	370
63D/PZ	370
63D/PZ 2P	371
63D/T	372
63D/T 2P	372
64A/PH	380
64A/PH 2P	381
64A/PZ	381
64A/PZ 2P	381
650	952
65I/7-1	414
65I/PH	382
65I/PH 2P	382
65I/PZ	383
65I/PZ 2P	383
65I/T	384
65I/T 2P	384
65TORX	420
665	952
6700SM	202
6700SM/T4/19	804
6700SZ	203









6700TORX-E	207	6M/T12/7	791	7452-8	315
6709F	207	6M/T3/5	791	7452-9	315
6709M	209	6MV	886	7452P/7852P	314
6709PH	207	6MV/	886	7453	328
6709PZ	208	6Z	168	7454	319
6709TORX	208	6Z/	169	7455	312
6709TORX-R	208			7456	313
671002600	971	700	499	7490	1204
671002850	971	701	499	7590	1205
6712R	218	702	500	75M	420
6712RN	218	703	500	7710	237
6715GE	221	704	500	7710-SO/1	243
6715GJ	222	705	480	7750	236
6715MG	220	706-1	501	7750-SPARE	243
6715MGS	219	706-2	501	7750RN	236
6715MZ	224	706-3	501	7750RN-SPARE	243
6715PZ	222	706-4	502	7752	237
6719SM	219	706-5	502	7754	238
6720NM	223	70MH	419	7755-3/8	235
6721NM	220	7106	242,267	7755-SO/1	243
6722M	221	7190, 7191	1201	7757	238
6729SM	225	71PZSDVH	419	7758	237
6729SZ	225	7224	595	7759	239
6821NZ	224	7280	1202	7760-7761-7762	239
6852-5	328	7285	1202	7760-W - 7761-W	239
6852-5/S17	318	7290,7291	1203	7764	241
6852/7452/7852	313	7292	1204	7765	215
6852/7452/7852/8952 -1	314	7293	1203	7766	240
6873N-6880N	327	72H	419	7767	216
6881	325	7372I	502	7768	241
6950	210	7400SM	227	7800DM	251
6950-SPARE	217	7400SM/T8/23	805	7800DM/T12/27	802
6950RN	210	7400SR/	227	7800DMV	889
6950RN-SPARE	217	7400TORX-E	231	7800DZ	252
6951	211	7400TORX-ER/	232	7800SM	249
6952	211	7406ZZ	662	7800SM/T12/26	802
6954	212	7407H-7409H	343	7800TORX-E	253
6956	213	7409BH	235	7805DM	252
6958	212	7409F	232	7805DM/T6/6	803
6960 - 6962L	213	7409KML	421	7805SM	250
6960-W - 6962-W	213	7409M	234	7805ZZ	662
6963	214	7409MR/	234	7806	665
6966	214	7409PH	232	7807	665
6968	215	7409TORX	233	7807H-7809H	351
6972H	210	7409TORX-L	234	7809F	254
6972H	340	7409TORX-R	233	7809M	256
6973N-6978N	325	7409TORX-TRR/	233	7809M/10	276
6975A	327	7420RE	244	7809M/T8/15	814
6976	327	7429JDE	248	7809PH	254
6976AN	326	7430GE	245	7809PZ	254
6976CN	326	7440ME	245	7809T-2/T2/6	813
6976E	326	7444SG-M	182	7809T/T3/9	813
6M	166	7444SG-Z	183	7809TORX	255
6M-BOX	167	744T	284	7809TORX/10	277
6M/	167	7451/7851	312	7809XZN	257
6M/S	168	7452-10	316	7809Z	257
6M/SH	167	7452-7	317	7809Z/10	276



ALPHANUMERICAL INDEX

					
7811DMV	890	810-5	474	822VDE-5	869
7819DME	269	811	466	8231	595
7819DRN	272	8110-1/2	260	8247	1200
7819DZ	274	8110-SO/1	268	8248	1200
7819DZE	274	8110H-1/2	261	833AJ	1076
7819HNRE	270	813	466	833FJ	1076
7819HRN	271	813/814	1201	833P	1074
7819JE	273	8130-8162	1197	833SB	1074
7819SRE	269	813VDE	469	834V	1073
782-U	132	813VDE	867	834V-2	1074
783	132	814	471	850 / 865	953
7835G	563	8143-8165	1198	8501	58
7851-G	329	8146-8158	1198	8501-F / -XF	58
7851-M/8951-M	329	8149	1199	8501-S	59
7852-10	317	815	467	8501-SW	59
7852-7	318	8150-1/2	258	8640	970
7852-8	316	8150-1/2-SPARE	267	8641	970
7865	421	8150-1/2V	889	8691	1037
7886DME	271	8150RN-1/2	259	8740	1100
7886DZE	275	8150RN-1/2-SPARE	268	8741	1100
7886SME	270	8151-1/2	261	8746	1101
7888DM	273	8152-1/2	261	8749	1101
7888SM	272	8154-1/2	263	8760	1101
7890, 7891	1205	8154-1/2V	890	8770	1101
7892	1206	8155-1/2	258	8840M	285
7893	1206	8155-SO/1	267	8845DM	285
7993M	361	8158-1/2	262	8845NM	284
7993S	352	8158-SO/1	268	8900DM	278
7993T	357	8159-W - 8162-W	264	8900DZ	278
7994S	352	8159/8160/8162	263	8900SM	277
		815VDE	469	8905-TM/9505-TM	329
80	145	815VDE	867	8905S/9675S	330
800-4	471	816	467	894M	173
800S/T10/9	806	8160-1/2V - 8162-1/2V	890	8950N	279
800S/T8/9	808	8160-B	264	8950N/A	280
804-6	472	8164-1/2	241	8950NA-SO/2	284
8045LVDE	506	8165-1/2	265	8951	281
8045VDE	506	8166-1/2	265	8951-F-800	313
805-6	472	8167	241	8952-3	316
8052	495	8168	265	8952F	314
806	506	816VDE	470	8952N	279
806-6	472	816VDE	868	8952N/A	280
807-5	473	817	471	8952N/B	280
8070V - 8074V	885	817V	470	8953	279
8071VLT - 8073VLT	885	817V	868	8954	281
808-10	473	818	468	8954A	281
808-9	473	819	468	8958	282
808050	496	8193-1/2	260	8958A	282
808050/T6/41	819	8194-1/2	260	895M	174
808050A/TORX	498	820VDE	474	8961/8962	283
808050L	496	820VDE-5	869	8963	282
808050P	496	8211	1199	8964	266
808050P-	497	8223 - 8226	594	8965	283
808050S	497	8224-9072P/T6/2	816	8966	283
808050S-	498	8224/8225C	594	8967	266
808050TS	497	8224C-9072C/T6/2	816	8967/	216
80C	145	822VDE	474		



					
9-12	1014	9526	1053	A/G	123
9-462	108	9527	1054	A3362L/A3364L	833
9-467	109	9528	1055	A6700DM	204
9-469	109	9529	1052	A6700DZ	204
9-484...10	109	9531	1052	A6709M	209
9-484...1P	109	9540MB	289	A6709Z	209
9-485...10	110	9540MBL	290	A6710DM	205
9-485...1P	110	9540ZB	290	A6710DZ	205
9-486-C-10	111	9540ZBL	291	A6716DM	218
9-486-C-1P	111	9550AB	287	A6716DZ	223
9-486...10	110	9550AB-SO/1	289	A6800DM	203
9-486...1P	111	9551	287	A6800DZ	206
9-488-02	91	9552AB	287	A7400DM	228
90	142	9555	288	A7400DZ	229
900T	503	9555AB	288	A7402DM	230
900T/T18/8	810	956	1026	A7402DZ	230
901T	503	9560AB/9563AB	288	A7410DZ	229
901T/T18/7	810	9564	283	A7435DME	246
9029-9035	143	9565AB	288	A7440DME	247
9029C/9031C	143	9572	943	A7440DZE	246
902T	504	9574	943	A7535DZE	247
9031-T	144	9575	943	ADJP/T10/4	815
9031P	144	95C	148	AP-/FP-	1160
903T-1	505	9600	834	AP-234	1158
903T-2	505	9601	834		
903T-3	505	9710	494	B400	619
9045-B	944	9710/S6	495	BB12-1200	696
9048	944	9715	495	BB12-760	696
904T	504	9733	572	BB1224-1200	697
905T	504	9778	494	BB1224-760	697
90C	142	9778PZD	494	BB24-1200	698
91	56,57	9841	845	BBBC	698
91C/97C	148	9845	845	BBBCAB	698
9210	1147	9848	846	BBR110	688
9210-1	1147	9850	844	BBR300P43	687
9210-10	1148	9852	846	BBR320	688
9210-1060177	1150	985200000	831	BBR350	688
9210-1060238	1150	9853	599	BBS100	708
9210-1230219	1149	9853	830	BBS150	707
9210-1230235	1148	9853ALU	830	BBS160	707
9210-1320281	1150	9854	830	BBS20P12	707
9210-1640142	1149	9854	1223	BBS50	707
9210-1690148	1148	9855	1223	BBT30	699
9210-1700118	1149	9856	1223	BBT40	699
9210-1710266	1150	9857	1224	BE-3529	919
9210-1720100	1148	9858	1224	BE-6400M	442
9210-1730107	1149	9859	1224	BE-6990	322
9210-1770106	1149	9860S	599	BE-6990-AH	328
9210-1830137	1150	9873	598	BE-6990-IP-KL	323,324
9210-20	1148	9883	1025	BE-6990-IP20/25	324
9320	1147	9897	599	BE-6990-IPSET	323
95	147	9938	579	BE-6990TX-KL	322,325
9500SM	286	9938/T8/6	812	BE-76	442
9500SZ	286	A	112	BE-7675	526
9505/9605/9525/9625	330	A-AL	121	BE-78	443
9508	778	A-int	123	BE-7907 - BE-7940	439
9525	1053			BE-8010 - BE-8252	434



ALPHANUMERICAL INDEX



BE-8010S - BE-8065S	443
BE-8010S - BE-8065S	858
BE-8080	441
BE-8150 - BE-8258	434
BE-8158 - BE-8890	435
BE-8330 - BE-8455	435
BE-8510S - BE-8520S	446
BE-8510S - BE-8520S	860
BE-8577	442
BE-8600 - BE-8624	436
BE-8600S - BE-8640S	444
BE-8600S - BE-8640S	858
BE-8601/BE-8602	437
BE-8628 - BE-8640	436
BE-8675	524
BE-8702 - BE-8710	440
BE-8710S - BE-8720S	446
BE-8710S - BE-8720S	860
BE-8725S - BE-8708S	445
BE-8725S - BE-8708S	859
BE-8800 - BE-8824	437
BE-8800S - BE-8840S	444
BE-8800S - BE-8840S	859
BE-8801/BE-8802	438
BE-8828 - BE-8840	438
BE-8904 - BE-8945	439
BE-8910S - BE-8930S	445
BE-8910S - BE-8930S	860
BE-8975	521
BE-8975B	521
BE-8980	441
BE-8985	441
BE-9001 - BE-9003	440
BE-9575	520
BE-9578	514
BE-9585	520
BE-9588	515
BE-9675	523
BE-9678	518
BE-9688	518
BE-9765/BE-9770	517
BE-9775-BE-9785	519
BE-9776/BE-9777	515
BE-9777B	514
BE-9778	510
BE-9787	516
BE-9878	512
BE-9881	446
BE-9881S	448
BE-9881S	861
BE-9882	447
BE-9882S	449
BE-9882S	861
BE-9883	447
BE-9885	447
BE-9885S	449
BE-9885S	862









BE-9886	448
BE-9888S	449
BE-9888S	862
BE-9889	448
BE009/T10/9	806
BE009/T12/8	809
BE009/T6/7	807
BE009/T8/5	808
BE100	664
BE1GP5	664
BE1GP5-T	664
BE1P	662
BE1SP14L	663
BE1T14/BE1T16/BE1T21	663
BE200	736
BE200C	737
BE200M	737
BE210	736
BE220	738
BE230	677
BE250	678
BE255	678
BE300	677
BE500P24	677
BE5049	679
BE504901	682
BE504902	682
BE5049H	680
BE5049H_L	680
BE5049M	681
BE5049M_L	682
BE5049T_H	681
BE5049T_HL	681
BE52304405	675
BE523047	671
BE52305450	670
BE523055	668
BE52305650	674
BE52305801	672
BE52305802	672
BE52306100	667
BE52306110	676
BE52306120	674
BE52306170	668
BE52306900	670
BE52306912	675
BE52306920	675
BE52306929	671
BE52306950	670
BE523076	667
BE523106	676
BE523110B	667
BE523110C	667
BE52311102	668
BE523156	669
BE523158	669
BE523160	669









BE523161	673
BE52316150	674
BE52316190	673
BE52316197	675
BE523161B	674
BE52316230	673
BE52316404	676
BE523166	671
BE523167	672
BE523171	668
BE52317301	671
BE523174	672
BE523175	669
BE523176	673
BE523360	670
BE611	687
BE6217	685
BE630	685
BE6302/BE6303/BE6306	685
BE64520/BE64350	686
BE65F65120	686
BE65R	686
BE74-55100/BE74-80120	665
BE74-57125/BE74-90175	666
BE78/T10/8	809
BELP1224	702
BELS12	700
BELT10	702
BELT1213	701
BELT127	701
BELT2415	701
BELT247N	700
BELT247S	700
BELTKEY	702
BELTRP16	703
BH110000	718
BH11500	716
BH12000	716
BH13000	717
BH15000	718
BH1A2500	717
BH23015	719
BH23015C	719
BH2402010	720
BH2604020	720
BH2AC60	721
BH33000/BH36000	721
BH3HD	721
BH4	715
BH5SP300/BH5SP500	715
BH5US500	715
BH6AC1-680	714
BH6FC1000	714
BH8AC1-500	722
BH8AC2-450	722
BH8AC3-500	722
BH8PR	723









					
BHVIS08	689	BP51137	647	BPN251	652
BHVIS12 / BHVIS06	689	BP601	647	BPQCF14	654
BHVISxxBPW	690	BP610	647	BS10/BS10AC1	694
BKE850901	508	BP700	635	BS1000	695
BL11W	731	BP799	646	BS10AC2	695
BL15	728	BP79912	646	BS10MEC	695
BL15BASE	730	BP814	632	BS20/	153
BL15CLC	729	BP815	631	BS50	693
BL15MAG	729	BP815K1	632	BUC100	666
BL15WC	729	BP815K2	632	BUC50	666
BL30/60/80 WC	729	BP816	630	BWB14	693
BL30/60/80CLC	729	BP816K1	630	BWP150	693
BL30/BL60/BL80	728	BP817	633	BWSS	690
BLBT100	704	BP820	636	BWTB	692
BLE200	703	BP821	636	BWTSP	691
BLW42W/BLW84W	730	BP822	637	BZWTB	691
BLX120	728	BP822E	637		
BLX120WC	730	BP823	638	C	113
BOD1016	684	BP824	641	C-AL	122
BOD2008	684	BP825	642	C1/2	269
BOD301200	684	BP826	655	C1/4	217
BOD4200/BOD4500	706	BP827	655	C3/8	244
BOD5400/BOD5450	706	BP900	633	CHALK	942
BOD5HD400	705	BP900L	633	CL-1221	942
BOD60	705	BP909	643	CS	945
BOD70	705	BP909K	643	CTTG/T15/5	818
BOD8901	683	BP909NE	645		
BOD8901AC1	684	BP909NF	645	D	114
BOD8902	683	BP909TE	644	D-AL	122
BP110	641	BP909TF	644	D-DD/	347
BP115	637	BP909TH	644	D/	345
BP117	640	BP909TSP	645	DD/	347
BP117EH	640	BP909TTP	644	DOW175	608
BP125	643	BP909TWF	644	DOW176	608
BP127	646	BP919	635	DOW177	608
BP204	648	BP91B	636	DTT	331
BP204K	648	BP920	635		
BP204PAD	649	BP921	636	E	115
BP212	647	BP925	642	ECO-LUBE	1175
BP215	646	BP926	642	EF-1/T8/5	814
BP218	655	BPBG	650	EPCP/T8/4	811
BP222	648	BPBG5725/9057	650	EPP/T8/4	811
BP233	649	BPBK	650	EX-	989
BP254	652	BPBSC	650	EX-14-TEN-C	991
BP255	653	BPBU	649	EX-14-VEN-C	992
BP405	634	BPH1010	654	EX-16-GNP-C	991
BP420M	638	BPH1310	654	EX-20-LAM-C	990
BP421M	638	BPHR1020/1315	653	EX-20-XT11-C	990
BP422M	638	BPHRS1315	653	EX-22-PLS-C	991
BP423M	639	BPHVLP	651	EX-22-U7	993
BP424M	639	BPHVLP01	651	EX-244P-22	992
BP430M	639	BPM914	631	EX-NPP-22	992
BP431M	639	BPM915	631	EX-XT7	989
BP432M	639	BPM916	630	EX-XT9	990
BP433M	640	BPM91B	634		
BP434M	640	BPM91MK	634	F	116
BP500	652	BPN22201/21201	648	F-AL	122



ALPHANUMERICAL INDEX

											
FCP	1093	K19PZD	407	K9806M	365						
FCS	1093	K20TORX	407	K9806Z	366						
FCT128	823	K560F-1	341	K9860H	367						
FCT169	824	K560F-2/3	343	K9867S	367						
FCT238	825	K560F-4/5	351	KCB753	404						
FCT71	822	K560F-6	344	KM653	405						
FFSS	1093	K560F-7/8	362	KM653-QR	406						
FGS	1092	K560F-9	368	KM653-SF	406						
FM10	93	K66100	403	KM6701M	340						
FS-5	1167	K6625	402	KM6750	402						
FS-7.5	1167	K6638	402	KM753-QR	406						
FS-8	1167	K6650	403	KMR150	406						
		K6660-QR	403	KMR653	405						
G	117	K6701M	340	KMR753	405						
GC600	1072	K6750	401	KR653	404						
GL008	853	K6964C/K8164C	343	KSR753	404						
GL010	853	K7401M	341								
GL012	853	K7406M	342	L	119						
GS-180	1165	K7760C	342	L-AL	123						
GS-76	1165	K7764D/K8964D	351	LOCKING	1160						
		K7767S	342	LS-6060-23	1174						
H	118	K7801M	344	LS-6160-23	1174						
HFGPS	1091	K7801TORX-E	350	LS-COIN	1097						
HGPS	1091	K7801VM	344	LS-COMBINESS	1173						
HRFM10	94	K7801VM/S4	345	LS-CORINDON	1173						
HS6000	1206	K7801Z	348	LS-MASSE	1095						
HSSG-A	124	K7801Z/10	349	LS-MASSE-TR	1095						
HSSG-A-S	124	K7806M	346	LS-NATURAL	1173						
HSSG-C	125	K7806M/S4	346	LS-PIERRE-FAUX	1174						
HSSG-C-S	125	K7806Z	348	LS-TRIANGLE	1173						
HSSG-D	126	K7806Z/10	349	LS/MES	1094						
HSSG-D-S	126	K8160D	350	LTB	938						
HSSG-E	127	K8164F/K9564F	357	LTG	938						
HSSG-E-S	127	K8167S	350	LTS	937						
HSSG-F	128	K8901M	353								
HSSG-F-S	128	K8901M/8	355	M	120						
HSSG-G	129	K8901Z	353	M126	1036						
HSSG-G-S	129	K8901Z/8	355	M330	1036						
HSSG-M	130	K8906M	354	M6376	1040						
HSSG-M-S	130	K8906M/8	355	M676	1040						
HSSG-N	131	K8906Z	354	M730	1036						
HSSG-O	131	K8906Z/8	356	M780	507						
HSSG-P	131	K8909H	357	M781	508						
HUS	1091	K8909ML/K9509ML	362	M926	1041						
		K8960F	356	MA225	1032						
IZO-D	319	K8964G/K9895G	361	MA225L	1032						
IZO-DAG	320	K8967S	356	MA225R	1032						
IZO-DM	321	K9501M	358	MA311	1034						
IZO-DR	320	K9501Z	359	MA321	1034						
IZO-DRM	321	K9506M	359	MA325	1035						
		K9506Z	360	MA351	1035						
J	118	K9509H5	361	MA361	1035						
		K9560G	360	MA401	1033						
K	119	K9567S	360	MA411	1033						
K-AP-1	1048	K9598H/K9998H	368	MA421	1033						
K-GP-1	1048	K9801M	363	MA431	1034						
K18NF	407	K9801Z	364	MA500-1 - MA500-3	1225						



					
MCP	1094	P280-SL	1152	PH-6604	111
MES	1095	P3	1139	PROF-H	1175
MIX-C/T20/8	819	P34-27A	1158	PROF-K	1176
MIX-H/T15/10	815	P34-37	1158	PROF-LOPP	1176
MR126	1037	P5	1139	PROF-PH	1176
MR227L	1037	P51	1163	PROF-SEC	1176
MR227R	1038	P51-SL	1161	PS501-2	1225
MR340	1038	P51H-SL	1161	PTB101440	838
MR726	1038	P54-SL	1161	PTB102390	839
MSR/T6/4	817	P54H-SL	1162	PTB103390	839
MTB	936	P57-25	1163	PTB105490/PTB105550	838
MTG	937	P59	1163	PTB201390/PTB201420	835
MTS	936	P6160	1196	PTB202510/PTB202660	835
MTT151	1048	P64	1140	PTB2025102/PTB2026602	836
MW-150	939	P74	1165	PTB252560	836
MW-250	939	P75	1166	PTB253580	837
N	121	PAGS	1097	PTB303440	837
NP	1004	PAGS-2.0-900FG	1097	PTB401165-6	840
NP-COM	1005	PC-11-PS	1001	PTB402105	840
NP-CONC	1005	PC-12-PS	1000	PTB402210-6	841
NP-TEN	1004	PC-22-INS	1003	PTB402220-6	841
NP-VEN	1004	PC-6-DRY	1001	PTB402275-19	842
P-HB	945	PC-9-PS	1001	PTB402280-18	842
P108	1138	PC-COM	998	PTB402280-6	841
P11	1166	PC-DECO	1002	PTB402355-24	843
P110	1139	PC-DTF	999	PTB402355-30	843
P114-SL	1151	PC-DTL	999	PTB402380-12	842
P116-SL	1151	PC-DTR	999	PX	1134
P121	1140	PC-FILE	997	PXR	1134
P123	1145	PC-GNP	1002	QC-PAD	1069
P126	1141	PC-GT7	996	QCB	1068
P127	1145	PC-GT9	997	QCG	1068
P128	1145	PC-LAM	1000	QCS	1068
P129	1146	PC-PLS	1002	R1068	1144
P138	1140	PC-PRC	1000	R1069P	1143
P140	1154	PC-TBX	997	R1071/R1075	1146
P16	1154	PC-TEN	998	R1080P	1144
P160-SL	1151	PC-TIM	1002	R112PG-R124PG/R223P	1142
P172-SL	1152	PC-VEN	998	R113PG/R123PG	1143
P19	1152	PCP-GT7	996	R114V-R180V/R16V/R160A/R172A	1155
P20	1166	PCP-GT9	996	R124PG	1159
P241	1116	PG-03-L	1138	R127E/R137E	1159
P262	1114	PG-10-F	1141	R133PG	1159
P263	1114	PG-12	1141	R142P/R337E	1159
P264	1114	PG-17	1154	R146VC/R147V	1164
P266	1115	PG-18	1153	R1601	1144
P267	1115	PG-18-45	1153	R201P/R171P	1142
P268	1115	PG-19	1155	R202P/R271P	1142
P269	1116	PG-20	1155	R211P/R300P/R500P/R600P	1135
P270	1116	PG-22	1164	R214V/R26V/R260A/...	1156
P272	1117	PG-32	1164	R221P	1141
P274	1117	PG-51	1162	R239P/R141P/R142P	1142
P276	1117	PG-56	1162	R272H	1157
P277	1118	PG-57-F	1162	R303P-R603P	1135
P278	1118	PG-72	1169	R310	186
		PG-R-M	1138		
		PG-S/M/L	1137		



ALPHANUMERICAL INDEX

R312V-R318V/R143PV/R144PV/R146	1157	S30	177	SC127V	891
R341P/R474P	1143	S330	294	SC140/SC140C	1042
R372H	1156	S330-CASE	307	SC150NG	1042
R415V-R773V	1157	S330AF	295	SC150NGV	891
R427AE/R427E/R437E	1160	S350AF	297	SCRAPER-SET2	954
R430V-R516V	1156	S400	296	SE -15/-16	1013
R438P/R463P	1143	S410	305	SF	231
R440V-R516V	1164	S460	294	SH	1096
R478P/R480P	1144	S4RM	165	SH-PAGS	1097
R6725MK	226	S4RM/	165	SHARP-X	1174
R6725ZK	226	S50	193	SL24	291
R6950	211	S530T	298	SL25	292
R801P-R804P	1135	S560	304	SLX 17	305
R811P-RT824P	1136	S60	206	SLX17AF	306
R900P	1136	S63	214	SQZ150003	1044
R901P	1136	S64	212	SQZ150003-HSBL	1045
R902P	1136	S65	215	SQZ150003-SBL	1045
R903P/R1269P	1137	S67	212	SUP-LAM	995
R904P	1137	S69	216	SUS	1094
R905P-R907P	1137	S705	237	T10/E	821
RESIN-X	1175	S723 / S724	242	T2/E	820
RPS	146	S755	238	T3/E	820
RPS-P	147	S760 - S762	240	T4/E	820
RPS-R	147	S775	240	T6/E	821
RX 01	1195	S80	253	T8/E	821
RX 7490	1193	S80/	276	TL -ET	1207
RX 7590	1193	S83	264	TL 0-SA	1208
RX 7890, RX 7891	1194	S85	265	TL 00-SA	1207
RX 7892	1194	S86	263	TL 00B-SA	1207
RX 7893	1195	S87	262	TL 00CFR-SA	1218
RX 8130-RX 8162	1188	S87+7	301	TL 00D-SA	1207
RX 8143-RX 8145	1188	S87+7-CASE	307	TL 0C9-SA	1208
RX 8146-RX 8148	1189	S88	266	TL 1-SA	1209
RX 8149	1189	S89	266	TL 10G-SA	1208
RX 8211	1190	S910	299	TL 124-SA	1213
RX 8233	1191	S910-CASE	307	TL 15AP	1208
RX 8234	1192	S910AF	300	TL 2-SA	1209
RX 8237	1192	SAP-X	1175	TL 231-SA	1214
RX 8247	1190	SB-2444	1047	TL 249ACF	1219
RX 8248	1191	SB-3740	1098	TL 249CFR-SA	1217
S10	169	SBS10/T12/6	792	TL 251-SA	1216
S10/	169	SBS10/T3/5	792	TL 252-SA	1217
S106	302	SBS20/T15/6	795	TL 253-SA	1217
S108	303	SBS20/T4/8	794	TL 259ACF	1219
S140T	297	SBS20/T6/7	795	TL 259CFR-SA	1218
S140T-R	298	SBS30/T10/4	798	TL 269CF-SA	1217
S160	292	SBS30/T8/7	798	TL 2A-SA	1209
S160-CASE	306	SBS50/T12/8	801	TL 2AACF	1219
S160AF	293	SBS60/T4/21	804	TL 2AB-SA	1209
S20	152	SBS61	211	TL 2ACFR-SA	1218
S20/	153	SBS71	663	TL 2AX-SA	1213
S240	295	SBS750	236	TL 3-SA	1210
S240-CASE	306	SBS80/T20/29	803	TL 3C-SA	1210
S240AF	296	SBS81	259	TL 3C-TA	1210
S290	293	SBS82	259	TL 4-SA	1210
S290-CASE	307	SBSF/T8/23	805	TL 475-SA	1214
		SC127/SC127S	1042		



TL 5-SA 1211
 TL 5-TA 1212
 TL 51S-SA 1211
 TL 577-SA 1215
 TL 578-SA 1215
 TL 582-SA 1215
 TL 5A-SA 1211
 TL 5ACF 1220
 TL 5B-SA 1211
 TL 5CFR-SA 1218
 TL 648-SA 1214
 TL 649-SA 1214
 TL 65A-SA 1212
 TL 7-SA 1212
 TL 7A-SA 1212



TL 7ACF 1220
 TL 7CFR-SA 1219
 TL AA-S 1215
 TL AA-SA 1216
 TL AA-TA 1216
 TL AC-SA 1213
 TL MM-SA 1216
 TL SM103-SA 1220
 TL SM104-SA 1220
 TL SM105-SA 1221
 TL SM107-SA 1221
 TL SM108-SA 1221
 TL SM109-SA 1221
 TL SM110-SA 1222
 TL SM111-SA 1222



TL SM115-SA 1222
 TL SM117-SA 1222
 TL SS-SA 1213
 TRX 8180 1196
 TVAB/THAB 821
 W120SL1 827
 W120SL1-D1 827
 W120SL2-D2 828
 W180SL2-D2 829
 W180SL3 828
 W180SL3-D1 829
 WS 1096
 WT 1096



ALPHABETICAL INDEX



ADJUSTABLE WRENCHES	142-148
Insulated adjustable wrenches	885
AIR CUT OFF TOOLS	641
AIR DRILLS	642
AIR GRINDERS	
Die Grinders	637-638
Abrasive wheels	638-640
AIR GUNS	655
AIR HAMMER CHISELS	644-645
AIR HAMMERS	643
AIR RATCHETS	
1/4"	635
3/8"	635-636
1/2"	636
AIR RIVETERS	643
AIR SANDERS	647-649
AIR TOOLS	630-655
AUTO ELECTRIC TOOLS AND EQUIPMENT	
Battery boosters	696-698
Battery testers	699
Socket/plug testers	700-701
AUTOMOTIVE TOOLS & EQUIPMENT	662-709
AXES	1091-1095
BANDSAW BLADES	
Blades	22-30
Bandsaw sawing aids	30-31
BENCH VICES	1073-1076
BEVELS	943
BITS	
Diamond torsion bits 1/4"	369-372
Tin torsion bits 1/4"	373-374
Torsion bits 1/4"	375-377
Extra hard torsion bits 1/4"	377-380
Acr bits 1/4"	380-381
Stainless steel torsion bits 1/4"	382-384
Standard bits 1/4"	385-406
Bits for magazine screwdrivers	407
Bit sets 1/4"	408-418
Bits 5/32"	418
Bits 5/16"	419-420
Bit sets 5/16"	421
Bits 11.2 mm (7/16")	421
BODY SHOP TOOLS AND EQUIPMENT	707-708
BOLT CUTTERS	585
BOWSAWS	
Frames	1012-1014
Blades	1015
BRAKE SYSTEM TOOLS AND EQUIPMENT	
Brake piston tools	687-688
Brake fluid equipment	688



CABINETS	831-832
CABLE CUTTERS	582-584
Insulated cable cutters	881
CALIPERS	947
CAPE CHISELS	1098
CENTRE PUNCHES	1102, 1105
CHALK LINE AND CHALK	942
CHISELS	1098-1099
CIRCULAR SAW BLADES	58-59
CLAMPS	
Quick clamps	1068-1069
Clamps	1069-1072
COLD CHISELS	1098-1101
COPING SAWS	1009
CRANES & ACCESSORIES	714
DRIFT PUNCHES	1103, 1105-1107
DRILLS	
Drills for wood	1052-1055
Masonry drills	1056-1058
HSS drills	1058-1061
Step drills	1061-1062
ELECTRICIANS CHISELS	1101
ELECTRONICS AND PRECISION PLIERS	573-576
ELECTRONICS SPECIALITY TOOLS	
Hooks and picking tools	920
Tuning and trimming tools	921
Other fine mechanical tools	912-922
Mirrors	923-924
Sets for electronics service and electricians	925-927
ENDOSCOPES & ACCESSORIES	736-737
ENGINE TOOLS AND EQUIPMENT	
Spark and glow plug tools	662-665
Piston and piston ring tools	665-666
Exhaust system tools	666
Engine setting tools (timing)	667-677
Clutch tools	677
Cooling system tools	678-679
10 mm bits	679-682
EXTRACTORS	742-761
EYEWEAR/GLASSES	852
FEELER GAUGES	947
FENCING PLIERS	592-593
FILES	
Engineering files	72-84
Needle files	85-91
Diamond files	91-92
Milled tooth files	93-94
Sharpening files	94-103
Chain saw files	103-105



Rasps	106-108
Handles	109-111
Accessories	108-109
FLAT CHISELS	1098
FRET SAWS	1010-1011
GARAGE EQUIPMENT	
Light garage equipment	703-704
Grease/lubrication tools & equipment	705-706
GLOVES	852-853
GOUGES	1026
GRASS SHEARS	1165-1166
GRAVITY CLAMP	1072
GRINDING STONES	1027,1173
GRIP AND WELDING PLIERS	586-591
HAMMERS	
Woodworking and construction	1082-1084
Metal working and industrial	1084-1086
Instrument and workshop	1086-1090
HAND HACKSAWS	
Frames	982-985
Blades	986-988
Insulated frames	892
HANDBSAWS	
Handsaw with interchangeable blades	989-993
Superior™ handsaws	993-995
Profcut™ handsaws	996-1003
Prizecut™ handsaws	1004-1005
Other handsaws	1006-1007
HEDGE SHEARS	1161-1164
HEXAGONAL KEYS	509-519
HOES	1113
HOLESAWS AND ACCESSORIES	
Holesaws	36-38
Holesaw accessories	39-41
Holesaw sets	42-48
HYDRAULIC & LIFTING EQUIPMENT	714-723
IMPACT TOOLS	
Impact tools for square drives 1/4"	340-341
Impact tools for square drives 3/8"	341-343
Impact tools for square drives 1/2"	344-352
Impact tools for square drives 3/4"	353-358
Impact tools for square drives 1"	358-362
Impact tools for square drives 1.1/2"	363-368
IMPACT WRENCHES	
3/8"	630
1/2"	631-632
3/4"	633
1"	633-634
Impact wrench accessories	634
INSPECTION TOOLS	736-738



INSULATED TOOLS	
ERGO™ screwdrivers	858-862
TEKNO+ screwdrivers	863-866
800 series screwdrivers	867-869
Premium screwdrivers	870-873
600 series screwdrivers	874
Pliers	875-884
Wrenches	885-888
Sockets & accessories	889-890
Other insulated tools	891-893
Protective equipment	894-895
Insulated tool sets	896-897
JACKS & ACCESSORIES	715-723
JIGSAW BLADES	56-57
KNIVES	1044-1048
Insulated knives	892
LAMPS	
Cordless	728-730
Corded	730-731
LEVELS	940-941
LONG TAPES	937-938
LOPPERS	1151-1157
MASON'S CHISELS	1099
MASONRY TROWELS	965-968
MASONS'S PIN	1109
MAULS	1095
MEASURING TAPES	936-938
MEASURING WHEELS	939
METAL SHEARS	1032-1041
MITRE BOX	1008
OIL SERVICE TOOLS AND EQUIPMENT	
Draining & refilling equipment	683-685
Filter tools	685-687
PAINT GUNS	651
PENCILS	945
PICK AXES	1097
PIN PUNCHES	1107-1108
PIPE TOOLS	
Tube reamers	614-615
Special pipe wrenches	615
Plumbing wrenches	615-616
Chain pipe wrench	616
Flaring tools	617
PIPE WRENCHES	606-609
PLASTERBOARD TOOLS	
Plasterboard lifter	963-964
Setting tools	970
Trim cutters	970
Punching tools	971
PLASTERER'S RAILS	969



PLASTIC CUTTERS	613
PLIERS	
Side cutters	540-546
End cutters	546
Combination pliers	547-551
Snipe nose pliers	552-555
Snipe nose pliers, bent tip	556-559
Machinists pliers	559
Flat nose pliers	560-564
Round nose pliers	564-566
Fine mechanical cutters and pliers	569-572
Circlip pliers	577-582
Plier sets	598-599
Wire twisting pliers	600
Insulated pliers	875-880
PLUMB BOB	942
PNEUMATIC ACCESSORIES	652-654
PNEUMATIC MARKERS	646
POINTED CHISELS	1100
POLES	1160
POWER HACKSAW BLADES	32-35
PRUNING KNIVES	1166
PRUNING SAWS	1168-1172
PRUNING SCISSORS	1167
PRY BARS	762-763
PULLERS	742-761
RAKES	1113
RECIPROCATING SAWBLADES	49-55
RECIPROCATING SAWS	641
RIVETING TOOLS	600-601
ROOFING CLAMP	1072
ROTARY BURRS	
Tungsten carbide rotary burrs	112-123
HSS rotary burrs	124-131
Brushes	132
RULES	939
SCISSORS	1042-1043
Insulated scissors	891
SCRAPERS	952
SCRAPERS, DRY WALL	
Paint scrapers	956-958
Cabinet scrapers	955-956
Filling scrapers	958-959
Glue comb scrapers	959-960
SCREWDRIVERS	
ERGO™ series	434-449
TEKNO+ series	450-465
800-series	466-474
Premium series	475-487
600-series	488-493



9000-series	494-495
8000/9000 series	495
Ratcheting screwdrivers	496-498
Precision screwdrivers	499-502
Electronic screwdrivers	502
T-handle screwdrivers	503-505
Special screwdrivers	506-508
Offset screwdrivers	509-526
Insulated screwdrivers	858-874
SCRIBERS	945-946
SECATEURS	1134-1147
SHOVELS	1112
SLIP JOINT PLIERS	594-598
Insulated slip joint pliers	884
SLITTING CHISELS	1099
SMALL GARDEN TOOLS	1114-1118
SNIPS	1145-1146
SOCKETS AND ACCESSORIES	
Sockets 1/4"	202-207
Socket drivers 1/4"	207-210
Accessories 1/4"	210-217
Socket sets 1/4"	218-226
Sockets 3/8"	227-232
Socket drivers 3/8"	232-235
Accessories 3/8"	235-244
Socket sets 3/8"	244-248
Sockets 1/2"	249-253
Socket drivers 1/2"	254-257
Accessories 1/2"	258-269
Socket sets 1/2"	269-277
Insulated sockets and accessories 1/2"	889
Sockets 3/4"	277-278
Accessories 3/4"	279-284
Socket sets 3/4"	284-285
Sockets 1"	286
Accessories 1"	287-289
Socket sets 1"	289-291
Socket sets	291-307
SOLDERING TOOLS	915-919
SQUARES	944-945
STETHOSCOPE	738
SUSPENSION TOOLS AND EQUIPMENT	
Strut spring compressors	694-695
Miscellaneous	695
TOOL BOXES	833-843
TOOL HOLDERS	770-781
TOOL KITS	844-846
TOOL MODULES	791-825
TOOL TROLLEYS	782-790



TOP PRUNERS	1158-1160
TORQUE TOOLS	
Torque wrenches	312-321
Torque screwdrivers	322-328
Angle meters	329
Torque multipliers	329-330
TORX® KEYS	519-526
TRANSMISSION AND WHEEL TOOLS	
Auto specific sockets	689-691
Torsion bars	691-692
4-way wheel wrenches	692
Wheel bearing tools	693
Axle joint tools	693
Tyre levers	694
TROWELS	960-963
TUBE CUTTERS	611-612
TUBER BENDERS	610
TWEEZERS	900-914



WAD PUNCHES	618-620
WEDGES	1096-1097
WIRE STRIPPERS	566-569
WOOD CHISELS	1020-1026
WORKBENCHES	826-830
WRECKING BARS	1109
WRECKING KNIFE	1026
WRENCHES	
Adjustable wrenches	142-148
Combination wrenches	149-157
Ratcheting wrenches	158-165
Open end wrenches	166-174
Ring end wrenches	175-179
Flare nut wrenches	180-181
Heavy duty wrenches	182-186
Tubular wrenches	187-193
Hook wrenches	194
Insulated wrenches	885-887



ELECTRONICS AND FINE MECHANICAL PLIERS	
Rx series	1188-1195
Heavy duty cutter	1196
Plastic cutter	1196
80-series	1197-1201
Supreme-series	1201-1206
Multipurpose shear	1206
ELECTRONICS AND FINE MECHANICAL TWEEZERS	
Soft touch tweezers, ESD-safe	1207
High precision tweezers	1207-1213



General purpose tweezers	1213
Strong precision tip tweezers	1214
Precision component handling tweezers	1215
Boley style tweezers	1215-1216
Tweezers with fibre tips	1216-1217
Tweezers with replaceable carbon fibre tips	1217-1219
Replacement tips	1219-1220
SMD tweezers	1220-1222
Tweezer sets	1223-1224
TORQUE SCREWDRIVERS	1225

Argentina

Tronador 4890 2° Piso
C1430DNN- Saavedra
CAP. FED.
Tel: +54 (11) 4545-1400
Fax: +54 (11) 4543-6600

Australia

3 Cooper Street, Smithfield,
NSW 2164
Tel: +61 (0) 2 8787 5700
Fax: +61 (0) 2 9756 6130

Беларусь

220075, Минск,
ул. Селицкого, 8а
Tel.: +375 17 389 79 00
Fax: +375 17 389 79 51

Belgium

branch of SNA Europe (Benelux) BV
De Kleetlaan 12A Pegasus Park
1831 DIEGEM
Tel: +32 (0)2 726 03 03
Fax: +32 (0)2 726 04 36

Chile

Av. Pdte.Edo. Frei Montalva 6001-76
Conchalí - Santiago de Chile
Tel: +56 2 949 18 88
Fax: +56 2 949 18 99

Česká republika

SNA Europe s.r.o.
Holadnská 2/4
639 00 Brno
Tel.: +420 537 022 520
Fax: +420 537 022 200

Danmark

Vallensbækvej 40,
2605 Brøndby
Tel: +45 4363 0330
Fax: +45 4396 2456

Deutschland

Auf dem Hüls 5
40822 Mettmann
Tel: +49 (0) 2104 8 33 83 0
Fax: +49 (0) 2104 833 83 79 99

España

c/ Hilanderas, 1
(P.O. Box / Arpd de Correos nº 5)
C.P. 20303 Irún
Tel: +34 902 235 100 / +34 943 649 111
Fax: +34 943 649 120

Ελλάδα

Λ. Βουλιαγμένης 604Γ
167 77 Ελληνικό, Αθήνα
Τηλ: +30 210 9914263
Fax: +30 210 9914587

Export

Antigua Carretera de Altube Km 5,5
P.O.Box 307
01080 VITORIA (Spain)
Tel.: +34 945269711
Fax: +34 945165040

France

Espace @robase
122 rue du Château d'Orgemont
BP 30730
49007 Angers Cedex 1
Tél : +33 (0) 2 41 22 98 40
Fax: +33 (0) 2 41 22 98 50

Italia

Via Varesina 204
20156 Milano
Tel: +39 02 302 416 1
Fax: +39 02 380 036 98

Nederland

Vossenbeemd 113
5705 CL Helmond
Tel: +31 (0) 492 58 23 33
Fax: +31(0) 492 58 23 20

New Zealand

Unit 3/25 Highbrook Drive
East Tamaki
Auckland
Tel: +64 9-273 46 50
Fax: 64-9-273-2453

Norge

Box 114
1306 Bærum Postterminal
Tel: +47 40 49 66 00
Fax: +47 67 17 56 51

Österreich

Handelskai 94-96/23 Millenium Tower
A-1200 Wien
Tel: +49 (0) 2104 8 33 83 0
Fax +49 (0) 2104 833 83 79 99

Polska

Marynarska 19A
02-674 Warszawa
Tel.: +48 (0) 22 6070510
Fax.: +48 (0) 22 6070521

Россия

117105, Москва, Варшавское шоссе,
д.9, стр.1Б, оф. 202
Тел : (495) 7800421
Факс : (495) 7800422

Portugal

SNAEurope [Industries] S.A.
R. Maria Julia M. Ramos - Junqueira
4480-254 Vila Do Conde
Tel. +351 252 650 131
Fax. +351 252 650 160

Slovenská republika

SNA Europe s.r.o.
Karadžičova 8/A
821 08 Bratislava
Tel.: +421 (0)2 5939 6124
Fax: +421 (0)2 5939 6217

Suomi

Ayritie 8 A, 01510 Vantaa
PO Box 79, 01511 Vantaa
Tel: +358 207 433 510
Fax: +358 207 433 525

Sverige

Box 83
SE-745 22 Enköping
Tel: +46 (0) 171-47 82 00
Fax: +46 (0) 171-47 82 38

Schweiz / Suisse

Auf dem Hüls 5
D-40822 Mettmann
Deutschland
Tel: +49 (0) 2104 8 33 83 0
Fax +49 (0) 2104 833 83 79 99

Türkiye

Girne Mah. Maltepe Küçük San. Sitesi
F Blok No:19 Maltepe
Istanbul
Tel: +90 (0) 216 367 10 21
Fax: +90 (0) 216 367 11 71

Україна

Україна, 02140, м. Київ
вул. Єлизавети Чавдар, 9, офіс «А»
Tel: +38 044 562 25 91
Fax: +38 044 560 05 15

United Kingdom

Moorhead Way, Bramley,
Rotherham, South Yorkshire S66 1YY
Tel: +44 (0) 1709 731731
Fax: +44 (0) 1709 731741

Warranty

1. Where permitted by law, all hand tools in the catalogue are offered with a lifetime warranty - a warranty against material and manufacturing defects for the normal lifetime of the tool in question. 'Lifetime' is defined as the period of time a tool can be expected to last under normal use and conditions.

2. SNA Europe's range of power tools, pneumatic tools and measuring tools are excluded from point 1 and each has a separate warranty card supplied with the product covering the specific warranty conditions. Products are designed and manufactured for professional use. Generally the warranty period is one year (12 months) for professional use and two years (24 months) for private use. The warranty period starts on the purchase date. This date may be verified with the invoice or any other document of equivalent legal validity.

3. Defective products will be repaired, replaced or substituted. SNA Europe does not cover transit costs for repaired, replaced or substituted products.

4. Any product that has been incorrectly used and/or maintained or that is worn from improper use or that has suffered unauthorized modifications is not covered by this warranty.

5. A warranty claim must be submitted within the warranty period. This requires the submission or shipment of the complete tool in question with verification of sale documentation, which must validate the purchase date and the product designation, to the retailer or distributor.

6. Replacement or repair of the product will be carried out as quickly as possible. At the reception of the replaced or repaired product the customer is asked to validate conformity. Replacements and repairs provided under the warranty do not lengthen or renew the warranty period for the tool.

This catalogue comprises our current product assortment. Changes in the assortment as well as change of net shapes, forms, designs and designations are made continuously. No specific information will necessarily be issued to this effect.

Illustrations and drawings have been reproduced to be as accurate as possible. For the purposes of a catalogue they may, however, differ from the products themselves, as may the technical specifications.

Indications of weight are to be understood as approximate net weights, and serve primarily to facilitate calculations of freight and postage charges.

This catalogue supersedes all previous specifications and assortment lists.

The intellectual property in this catalogue is the property of SNA Europe. Excerpts, reprints or copies of the contents may be made with our permission.

X-ON Electronics

Largest Supplier of Electrical and Electronic Components

Click to view similar products for [Tool Kits & Cases](#) category:

Click to view products by [Bahco](#) manufacturer:

Other Similar products are found below :

[AM3310HLX23GXS](#) [229668-1](#) [217434-1](#) [QB-78K0RKE3L-TB](#) [4263](#) [1055420-1](#) [11-18-3023](#) [63860-8170](#) [856600-2](#) [11-40-3247](#) [63883-2870](#) [63866-1070](#) [63865-5170](#) [63863-5070](#) [63892-7370](#) [11-18-3209](#) [63860-4070](#) [63881-0970](#) [A0403641](#) [11-18-3040](#) [63865-2070](#) [63910-1470](#) [11-11-0387](#) [63850-7470](#) [11-18-3201](#) [63910-7570](#) [FM 0501 146](#) [63883-0670](#) [63830-0070](#) [63901-2670](#) [11-18-3147](#) [11-18-3079](#) [63883-2670](#) [63900-1770](#) [11-18-3190](#) [63851-1070](#) [63912-4770](#) [63911-5270](#) [63895-1070](#) [63860-1470](#) [63850-6070](#) [1-69411-3](#) [63852-9270](#) [63802-6270](#) [11-18-3202](#) [63852-9170](#) [63850-1070](#) [63830-0170](#) [11-18-3016](#) [63910-2870](#)