

Datasheet

One-Button Programmable Sensors For Use With Glass or Plastic Fibers



- Fiber optic sensors for DIN rail mounting; 10 to 30V dc operation
- Visible red (680 nm) light source; models for use with either glass or plastic fibers
- High optical sensing power when needed, also excels at low-contrast sensing
- Easy TEACH-mode programming automatically adjusts sensitivity to optimal setting¹
- D12E sensors are designed for low-contrast sensing applications (switching threshold set to just above the “dark” condition)
- D12E2 sensors set their switching threshold midway between the “dark” and “light” conditions to ignore subtle changes, such as web flutter
- Output may be programmed for either light or dark operate
- Fast 200 microsecond sensing response; programmable 40 millisecond pulse stretcher
- Secure one-button programming is easy to use; one button sets both TEACH and sensor configuration settings
- 7-segment LED bar graph indicates relative received signal strength and sensing contrast, programming status, and diagnostic trouble warnings
- Marginal sensing alarm
- Separate input allows remote programming by an external device, such as a switch or a process controller



WARNING: Not To Be Used for Personnel Protection

Never use this device as a sensing device for personnel **protection**. Doing so could lead to serious injury or death. This device does not include the self-checking redundant circuitry necessary to allow its use in personnel safety applications. A sensor failure or malfunction can cause either an energized or de-energized sensor output condition.



CAUTION: Electrostatic Discharge (ESD)

ESD **Sensitive** Device. Use proper handling procedures to prevent ESD damage to these devices. The module does not contain any specific ESD protection beyond the structures contained in its integrated circuits. Proper handling procedures should include leaving devices in their anti-static packaging until ready for use; wearing anti-static wrist straps; and assembling units on a grounded, static-dissipative surface.

Models

D12 Expert Series Glass Fiber Optic Models			
Models	Switching Threshold Setting	Output Type	Maximum Range
D12EN6FV	Just above the “dark” condition	NPN (sinking)	Range varies by sensing mode and fiber optics used; see Glass Fiber - Opposed Mode on page 9.
D12EP6FV		PNP (sourcing)	
D12E2N6FV	Midway between “dark” and “light” conditions	NPN (sinking)	
D12E2P6FV		PNP (sourcing)	

D12 Expert Series Plastic Fiber Optic Models			
Models	Switching Threshold Setting	Output Type	Maximum Range
D12EN6FP	Just above the “dark” condition	NPN (sinking)	Range varies by sensing mode and fiber optics used; see Plastic Fiber - Opposed Mode on page 10.
D12EP6FP		PNP (sourcing)	
D12E2N6FP	Midway between “dark” and “light” conditions	NPN (sinking)	
D12E2P6FP		PNP (sourcing)	

Overview

D12 Expert self-contained sensors offer one-button programming that provides security for your settings, yet is simple to set. D12 Expert sensors offer two programming modes: TEACH mode and SENSOR OUTPUT CONFIGURATION mode. The D12 Expert also features an advanced and comprehensive LED status display, plus sensor self-diagnostics and an alarm output to signal marginal sensing conditions.

¹ U.S. Patent(s) issued or pending

² Standard 2 m (6.5 ft) cable models are listed. To order the 9 m (30 ft) cable model, add suffix “W/30” to the cabled model number (for example, D12EN6FV W/30).



Unlike competitive sensors, D12 Expert models have no exposed switches or adjustments. All programming is accomplished using a single, sealed push button, using quick commands. Your settings remain secure, and the sensor is sealed against the elements of the sensing environment. Also, a separate input is provided for remote programming (see [Remote Programming](#) on page 5).

Models are available for either glass or plastic fiber optics. Fiber optics are purchased separately to fit your exact sensing application. A few representative fiber optic styles are listed, see [Accessories](#) on page 9. See Banner's product catalog for the full selection of fiber optic assemblies.

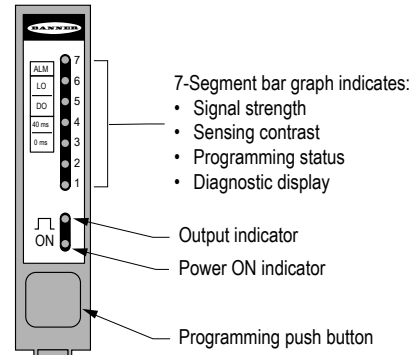
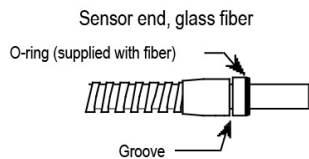

Figure 1. Features

Installing Glass Fibers

1. Gently seat an o-ring onto each sensor end of the fiber.



2. Slide the sensor ends into the fiber ports as far as they will go.
3. Push firmly on the fiber ends to compress the o-ring, and while holding the sensor ends snugly in place, slide the fiber retaining clip into the slot.
4. Press the retaining clip in until it snaps into the groove.

Installing Plastic Fibers

1. Cut the fiber ends according to the instructions included with the fibers.
2. Slide the fiber gripper up (open).
3. If you are using 0.010 inch or 0.020 inch (0.254 mm and 0.508 mm) diameter fibers: Insert the adaptor into the ports as far as it will go.

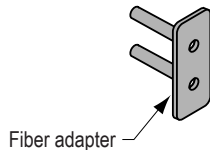

4. For all fiber diameters: Insert the prepared plastic fiber sensor ends gently into the ports as far as they will go.
5. Slide the fiber gripper back down to lock it.

Wiring Diagrams

NPN (Sinking) Outputs

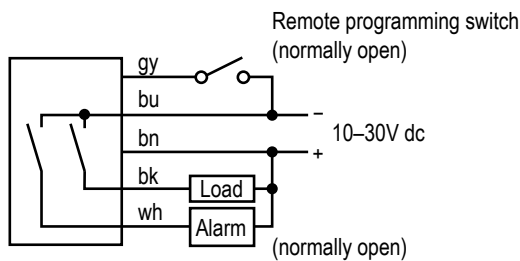

PNP (Sourcing) Outputs

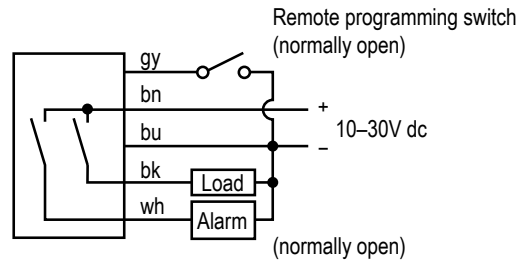

Configuration Modes

TEACH Mode

All photoelectric sensing applications (excluding analog response applications) involve differentiating between two received light levels. The condition with the higher received light level is known as the light condition, and the condition with the lower received light level is known as the dark condition. The difference between the two conditions is the sensing contrast.

The D12 Expert TEACH mode evaluates the light and dark sensing conditions and automatically adjusts the sensitivity to the optimal level. Programming is fast, easy, and accurate.

D12 Expert sensors offer high excess gain needed for demanding sensing environments and/or for long-range sensing. However, unlike standard D12 sensors, D12 Expert sensors also excel in low contrast sensing applications. When a D12 Expert sensor recognizes a low-contrast application during the TEACH mode process, the sensor's on-board microprocessor expands the bottom end of the sensitivity range to establish an accurate setting that allows the sensor to respond to the slight difference in received light levels.

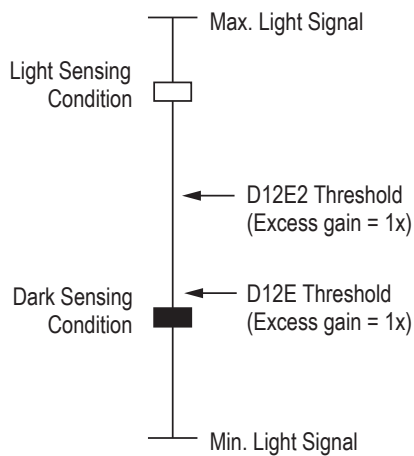

D12E and D12E2 models set their sensing threshold points differently during the TEACH mode process. D12E sensors automatically place the switching threshold just above the dark condition taught to the sensor. This scheme works exceptionally well for sensing a very small sensing contrast, where the light level represented by the dark condition remains constant. However, in some applications, a subtle rise in the amount of light received in the dark condition may prevent the D12E from responding to the intended sensing event.

D12E2 models automatically set the switching threshold at the mid-point between the light and dark sensing conditions taught to the sensor. This mid-point switching threshold allows D12E2 model sensors to ignore subtle changes in both the light and dark sensing conditions. D12E2 models were first developed to ignore a small amount of web flutter in high-speed registration color-mark-sensing applications.

At the end of the TEACH mode process, the D12 Expert bar graph indicator flashes one to seven segments to indicate the relative sensing contrast (see [TEACH-Mode Programming](#) on page 4), so you know how forgiving your application will be to changing sensing conditions.

Figure 2. Comparing the placement of the switching thresholds for D12E and D12E2 sensors

Sensor Output Configuration Mode

The Output Configuration Program mode allows you to set the sensor's output for either no delay or for a fixed 40 millisecond pulse stretcher (OFF-delay) for use with loads (or circuit inputs) that are too slow to react to a quick event. With no OFF delay, sensing response is a fast 200 microseconds (.0002 seconds) both ON and OFF.

The output can also be configured for either light operate (LO) or dark operate (DO). Light operate energizes the sensor's load output when the light condition is sensed, and dark operate energizes the load output for the dark condition.

The output configuration can be checked at any time by holding down the push button for 2 seconds. The sensor's 7-segment LED display indicates the current setting for 10 seconds (see [Figure 3](#) on page 4), while the sensor continues normal operation. Factory settings for the output configuration are no delay (0 ms) and light operate (LO).

Run Mode

Normal operation of the D12 Expert is called Run mode. During Run mode, the seven-segment LED display becomes a moving dot signal strength indicator (see [Overview](#) on page 1). When the light and dark sensing conditions are analyzed by the sensor during TEACH mode, the sensor's microprocessor automatically distributes the range of signal strength seen in the light condition evenly between the seven LEDs. This display gives a true reading of the relative signal strength for the current application, and is a useful indicator of changing sensing conditions.

Maximum Sensitivity. D12 Expert sensors are factory set for maximum sensitivity. Use the following TEACH mode procedure at any time to return the sensitivity to its maximum setting.

Following the TEACH mode procedure (see [TEACH-Mode Programming](#) on page 4), teach the following two conditions:

1. No light reaching the receiver. One easy way to do this is to disconnect the emitter and/or receiver fiber at the sensor.
2. Maximum light reaching the receiver. The best way to do this is to pipe the light from the sensor's emitter port directly into the receiver port, using a short individual fiber. If this is not convenient, return the greatest amount of light possible to the receiver by using a reflective target at close range (diffuse mode sensing) or by bringing the sensing end tips together (opposed mode sensing).

Factory Default Settings. D12E and D12E2 sensors are factory set at the following defaults: maximum sensitivity, light operate output and pulse stretcher OFF. Perform the procedures on the following pages to program your own settings. Unlike competitive sensors, the D12E has no exposed switches or adjustments.

Configuring a Sensor

Output Configuration Programming

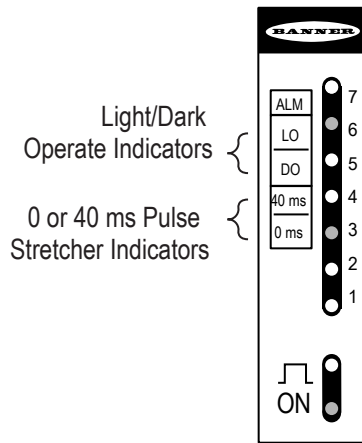

Use the push button and a combination of single-, double-, and triple-clicks to program the sensor. (For a description of these clicks, see [Remote Programming](#) on page 5). Two output functions may be programmed by the push button:

1. Either no delay or a fixed 40 millisecond pulse stretcher (OFF-delay) for loads (or circuit inputs) that are too slow to react to a quick event. With no OFF-delay, sensing response is a fast 200 microseconds (.0002 seconds), both ON and OFF.
2. The output may be programmed for either light operate (LO) or dark operate (DO). In light operate, the sensor load output is energized during the light condition; in dark operate the load output is energized during the dark condition.

These two output functions are programmed in sequence – first the output timing, followed by the light/dark operate selection – as explained in the chart. The factory settings are 0 millisecond OFF-delay (no delay) and light operate (LO). To check the output configuration at any time, hold down the push button for 2 seconds. The sensor's seven-segment LED display indicates the setting for 10 seconds, while the sensor continues normal operation.



Note: To escape from Program mode and return to Run mode at any point, push and hold the push button for 2 seconds.

Figure 3. D12 Expert setting indicators, shown set to factory defaults

Push button	Mode	Indicator Status
Push and hold 2 seconds or longer - Output settings are displayed.	Change from Run mode to Output Configuration (Display) mode	Two steady red LEDs indicate the output settings: light or dark operate and output timing (0 or 40 ms). The sensor continues to operate normally during the display period. The display automatically returns to Run mode if the button is not pushed within 10 seconds.
Triple-click - Output timing selection is displayed. (Single-click to toggle between 0 ms and 40 ms)	Change to Output Configuration (Program) mode (Output timing selection)	Red LED flashes at 1 Hz opposite either 0 ms or 40 ms output timing. The sensor returns to Run mode if the button is not pushed within 90 seconds. (Flashing red LED toggles between 0 ms (no delay) and 40 ms (off-delay))
Double-click - Output timing is stored and the LO or DO selection is displayed. (Single-click to toggle between LO and DO)	Continue in Output Configuration (Program) mode (Light/dark operate selection)	Red LED flashes at 1 Hz opposite either LO or DO output mode. The sensor returns to Run mode if the button is not pushed within 90 seconds. (Flashing red LED toggles between LO and DO)
Double-click - LO/DO choice is stored and the sensor returns to Run mode.	Return to Run mode	The 7-segment LED bar graph indicates relative received signal strength.

TEACH-Mode Programming

Sensitivity is automatically set (and optimized) by “teaching” the sensor the light and dark conditions in TEACH mode. TEACH mode is accomplished by presenting each of the two sensing conditions to the fiber optics. They may be presented in either order (the light condition first, then the dark, or vice versa). When the button is clicked, the sensor samples the sensing condition and registers it into memory. After the second sensing condition is registered, the sensor automatically sets its sensitivity to the optimum value for the application, and the sensor returns to RUN mode.



Note: There is a period of a few seconds at the end of TEACH mode when the display is blank, before RUN mode begins.

Contrast Indication

When the push button is clicked to teach the second condition (see [TEACH-Mode Programming](#) on page 4), the 7-segment display flashes 1 to 7 LEDs three times to indicate relative contrast level. Contrast is the difference in light level between the two sensing conditions. Higher contrast allows a higher sensitivity level, and, therefore, a higher excess gain. In short, a high contrast level is directly related to sensing reliability, and to the sensor's ability to “forgive” subtle changes in sensing conditions.

Contrast, as indicated by the 7-segment display	
LEDs Flash 3 Times at End of TEACH Mode	Relative Contrast
1 (only)	Unacceptable
1 and 2	Low
1, 2, and 3	Moderate

Contrast, as indicated by the 7-segment display	
LEDs Flash 3 Times at End of TEACH Mode	Relative Contrast
1, 2, 3, and 4	Good
1, 2, 3, 4, and 5	Very Good
1, 2, 3, 4, 5, and 6	High
1, 2, 3, 4, 5, 6, and 7	Very High

Push Button	Mode	Indicator Status
Push and hold 2 seconds or longer - Current output settings are displayed	Change from Run mode to Output Configuration (Display) mode	Two steady red LEDs indicate the output settings: light or dark operate and output timing (0 or 40ms). The sensor continues to operate normally during the display period. The display automatically returns to Run mode if the button is not pushed within 10 seconds.
Double-click - ON indicator (green LED) single-flashes at 1 Hz.	Change to TEACH mode	Green ON LED single-flashes at 1Hz and the 7-segment display indicates relative received signal strength. There is no timeout for the TEACH mode sequence. To escape from TEACH mode and return to Run mode with the previous setting, press and hold the button for 2 seconds or longer.
TEACH Condition #1 - Present the first condition to the sensor and single-click the push button		When the push button is single-clicked, the 7-segment display turns each of its LEDs ON in sequence from #7 to #1, as the sensor samples and registers the first condition. The green ON LED double-flashes at 1 Hz to indicate the sensor is ready to learn the second condition. There is no timeout for the TEACH mode sequence. To escape from TEACH mode and return to Run mode with the previous setting, press and hold the button for 2 seconds or longer.
TEACH Condition #2 - Present the second condition to the sensor and single-click the push button		When the push button is clicked, the 7-segment display will turn each of its LEDs ON in sequence from #7 to #1, as the sensor samples and registers the second condition. The 7-segment display will then flash 1 to 7 of its LEDs three times to indicate relative sensing contrast. (See Figure 4, above right.) If the contrast is acceptable, the sensor returns (after a few seconds) to RUN mode with the new, optimized sensitivity setting. If the contrast is unacceptable (indicated by only #1 LED of the 7-segment display flashing three times), the sensor returns to TEACH mode condition 1. If the contrast is unacceptable, the ALARM output also pulses three times.

Remote Programming

To remotely program the TEACH and Output Configuration modes, connect the sensor's gray wire to a remote programming switch. (This input parallels the push button on the sensor, so the push button sequences explained in [Output Configuration Programming](#) on page 4 and [Contrast Indication](#) on page 4 also apply for a remote switch.)

Connect a remote programming switch between the gray wire and dc common (see [Wiring Diagrams](#) on page 2). The switch may be either a normally open contact, or an open-collector NPN transistor.

The timing diagrams define single-, double-, and triple-click, simulating the D12 Expert's programming push button. The ON time of each click must be at least 40 milliseconds. The minimum space between clicks must be at least 40 milliseconds. The total time of two adjacent clicks of a double- or triple-click must be less than 800 milliseconds. Conversely, there must be at least 800 milliseconds between the start of a single- or double-click and the next input.

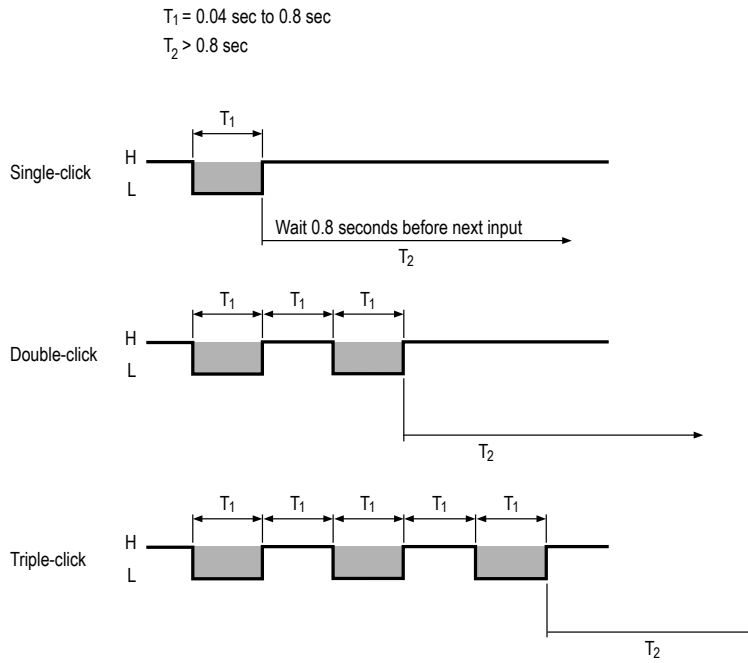

Figure 4. Timing Diagrams for Remote Programming

Self-Diagnostics

D12 Expert sensors provide several self-diagnostic functions. One or more flashing LEDs on the 7-segment display indicates a trouble condition and an alarm output warns of marginal sensing conditions.

The D12 Expert's 7-segment display indicates four problems:

LED Behavior		Problem
Flashing LED #7 and solid green ON indicator	<ul style="list-style-type: none"> ○ Indicator OFF ● Indicator ON ⊗ Indicator Single-Flashing 	<p>The sensor flashes the #7 LED continuously and energizes the alarm output when a marginal sensing condition develops during Run mode.</p> <p>Check the sensing area for any change affecting the received light level in either or both sensing conditions (for example, dirt buildup on the sensing end of a fiber, misalignment of a fiber, or a change in the target's physical properties).</p> <p>If no changes can be identified, re-teach the sensor.</p>
Flashing LED #7 and no green ON indicator	<ul style="list-style-type: none"> ○ Indicator OFF ● Indicator ON ⊗ Indicator Single-Flashing 	<p>Load output is overloaded. Remove power, correct the problem, and re-apply power. Sensor will come up in Run mode with the most recent settings.</p>

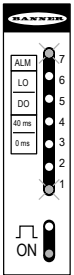
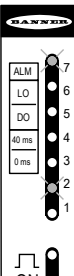
LED Behavior		Problem
LEDs #1 and 7 flash together 6 times	 <ul style="list-style-type: none"> ○ Indicator OFF ● Indicator ON ⊗ Indicator Single-Flash 6 Times 	This occurs at the end of TEACH mode when the sensor has received faulty data. Faulty data may result from an unstable target or from high electrical noise occurring while TEACH mode is in process. The sensor returns to Run mode, with the previous setting. Re-teach the sensor.
LEDs #2 and 7 flash together	 <ul style="list-style-type: none"> ○ Indicator OFF ● Indicator ON ⊗ Indicator Single-Flashing 	These LEDs flash continuously to indicate a sensor component failure. Return the sensor to the factory for replacement.

Specifications

Supply Voltage and Current

10 to 30V dc at 45 mA max. (exclusive of load); 10% maximum ripple

Supply Protection Circuitry

Protected against reverse polarity and transient voltages

Output Configuration

NPN open collector (both outputs) or PNP open collector (both outputs), depending on model
Load output: N.O. and programmable light- or dark-operate
Alarm output: N.O.

Output Rating

150 mA maximum each output; the total load may not exceed 150 mA
Off-state leakage current: less than 10 microamps at 30 V dc
On-state saturation voltage: less than 1 volt at 10 mA dc and less than 1.5 volts at 150 mA dc

Output Protection Circuitry

Protected against false pulse on power-up and overload of outputs (trips at 175 mA)

Required Overcurrent Protection



WARNING: Electrical connections must be made by qualified personnel in accordance with local and national electrical codes and regulations.

Overcurrent protection is required to be provided by end product application per the supplied table.

Overcurrent protection may be provided with external fusing or via Current Limiting, Class 2 Power Supply.

Supply wiring leads < 24 AWG shall not be spliced.

For additional product support, go to <http://www.bannerengineering.com>.

Supply Wiring (AWG)	Required Overcurrent Protection (Amps)
20	5.0
22	3.0
24	2.0
26	1.0
28	0.8
30	0.5

Output Response Time

200 microseconds ON and OFF (40 milliseconds OFF when OFF-delay selected)



Note: False pulse protection circuit causes a 0.1 second delay on power-up

Output Operation Mode

Light operate or dark operate; selected by push button

Output Timing Functions

ON/OFF (no delay) or fixed 40 millisecond OFF-delay; selected by push button

Repeatability

66 microseconds

Adjustments

Push button TEACH mode sensitivity setting; remote teaching input is provided

Indicators

Green LED lights for DC power ON and flashes when ready for TEACH mode; 1 Hz when ready to learn first condition; 2 Hz for second condition
Yellow LED lights for load output ON (conducting)
7-segment Moving Dot Red LED Display indicates relative received light signal strength, output program settings, relative contrast level and alarm

Construction

Black ABS housing with acrylic cover, stainless steel M3 x 0.5 hardware for use with PBT polyester mounting bracket (supplied); the plastic fiber clamping element is acetal

Environmental Rating

NEMA 2; IEC IP11

Connections

PVC-jacketed 2 m (6.5 ft) or 9 m (30 ft) cables

Operating Conditions

Temperature: -20 °C to +70 °C (-4 °F to +158 °F)
90% at +50 °C maximum relative humidity (non-condensing)

Certifications



Dimensions

Glass Fiber Optic Models

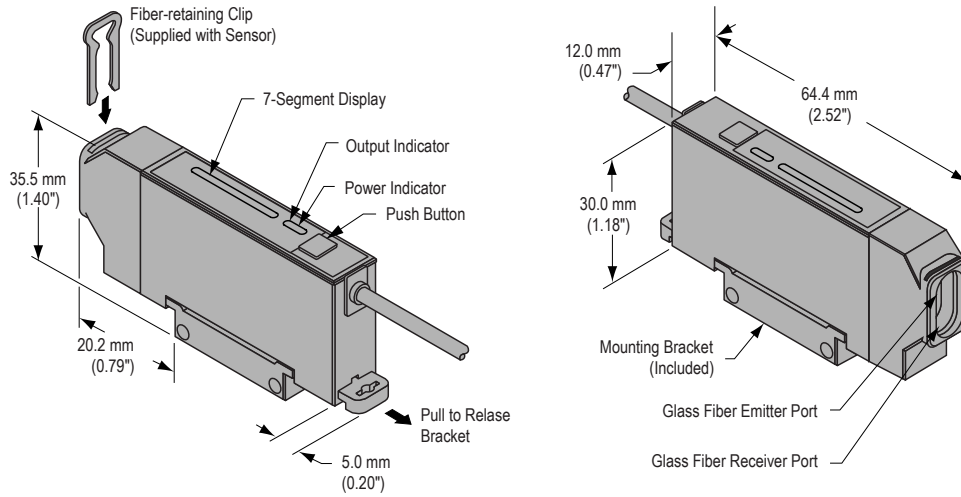

Plastic Fiber Optic Models

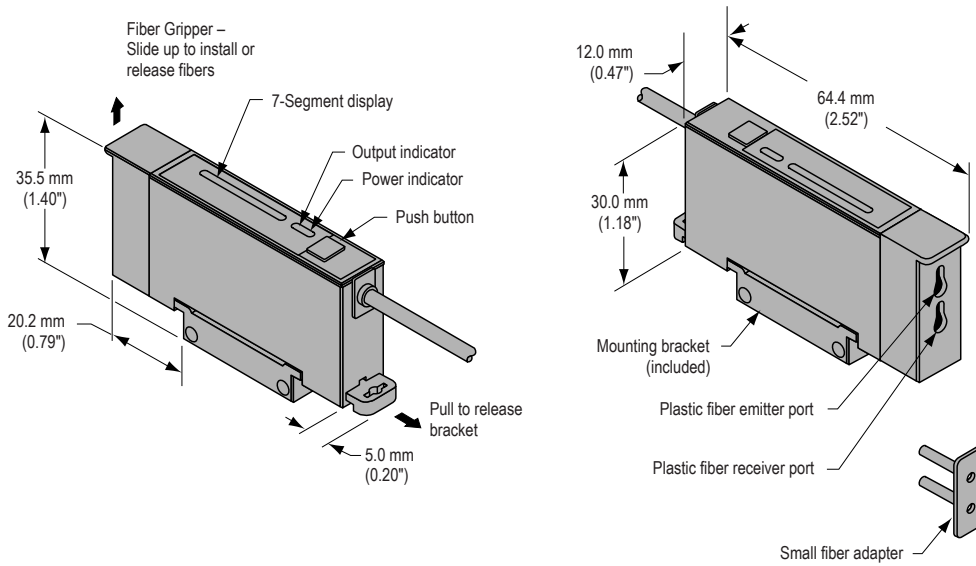

Dimensions—D12 Bracket

D12 Sensors mount directly to a standard 35 mm DIN rail, or may be through-hole mounted using the supplied mounting bracket and stainless steel M3 x 0.5 hardware.

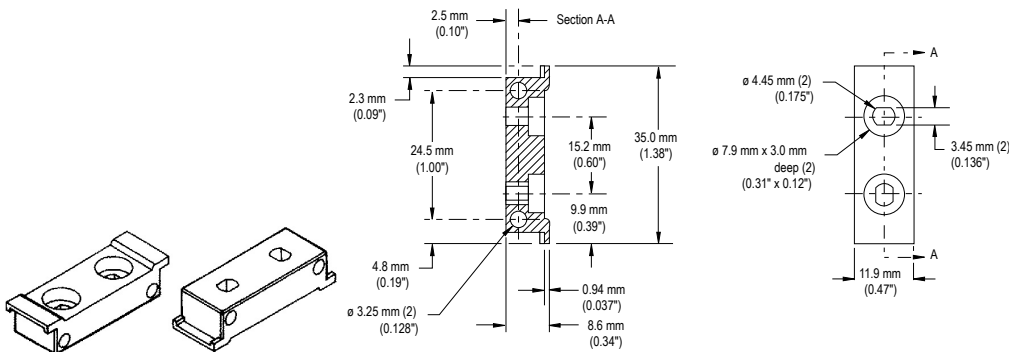

Accessories

The following table lists all the fiber sizes that can be used with these sensors. Typical fiber models (one for each size and type) are indicated, along with the maximum range for each (expect less range for fiber assemblies with angled sensing ends). For a complete selection of fibers in these sizes and for more information see your current Banner Engineering Catalog.

Range data is for 0.9 m (3 ft) glass fiber assemblies.

Glass Fiber - Opposed Mode

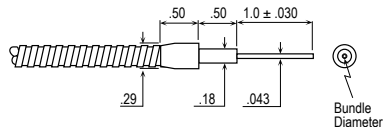
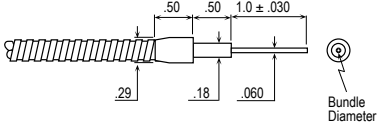
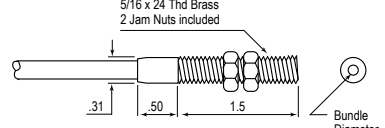
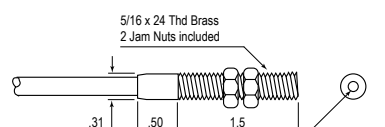
Part Number	Features	Sensors	Range
IMM.443S	 <ul style="list-style-type: none"> Fiber diameter: 0.7 mm (0.027 inches) Individual fiber Stainless steel flexible conduit Used in pairs, but sold individually; two are required 	D12E	107 mm (4.2 inches)
IM.753S	 <ul style="list-style-type: none"> Fiber diameter: 1.2 mm (0.046") Individual fiber Stainless steel flexible conduit Used in pairs, but sold individually; two are required 	D12E	295 mm (11.6 inches)
IT13S	 <ul style="list-style-type: none"> Fiber diameter: 1.6 mm (0.062") Individual fiber Thread Stainless steel flexible conduit Used in pairs, but sold individually; two are required 	D12E	442 mm (17.4 inches)
IT23S	 <ul style="list-style-type: none"> Fiber diameter: 3.18 mm Individual fiber 19 mm bend radius Thread Stainless steel flexible conduit Lenses available Used in pairs, but sold individually; two are required 	D12E D12 OS18 R55F SME312	930 mm 550 mm 900 mm 1050 mm 250 mm

Glass Fiber - Diffuse Mode

Based on a 90% reflectance white test card.

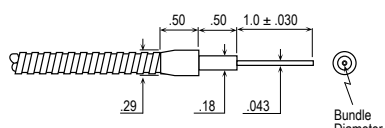
Part Number	Features	Sensors	Range
BMM.443P	 <ul style="list-style-type: none"> Fiber diameter: 0.7 mm (0.027 inches) Bifurcated fiber PVC with galvanized monocoil reinforcing wire sheathing 	D12E	55 mm (0.6 inches)

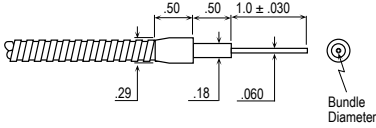
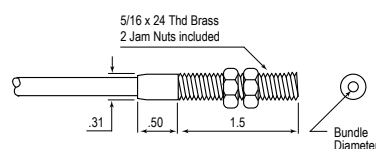
BM.753S	Features	Sensors	Range
	<ul style="list-style-type: none"> Fiber diameter: 1.2 mm (0.046") Bifurcated fiber Stainless steel flexible conduit 	D12E	46 mm (1.8 inches)
BT13S	Features	Sensors	Range
	<ul style="list-style-type: none"> Fiber diameter: 1.6 mm (0.062") Bifurcated fiber Thread Stainless steel flexible conduit 	D12E	68 mm (2.7 inches)
BT23S	Features	Sensors	Range
	<ul style="list-style-type: none"> Fiber diameter: 3.18 mm Bifurcated fiber 19 mm bend radius Thread Stainless steel flexible conduit 	D12E D12 OS18 R55F SME312	178 mm 150 mm 100 mm 110 mm 25 mm

Plastic Fiber - Opposed Mode

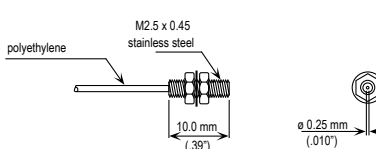
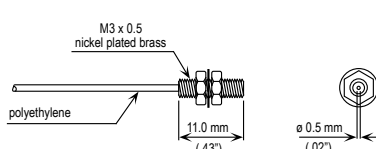
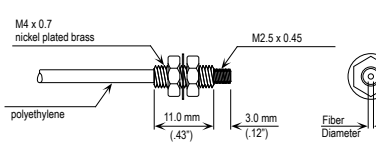
PIT16U	Features	Sensors	Range
	<ul style="list-style-type: none"> Fiber diameter: 0.25 mm Individual fiber pair 8 mm bend radius Thread 	DF-G1 D10D D10B D10A D12E	58 mm 90 mm 20 mm 15 mm 18 mm
PIT26U	Features	Sensors	Range
	<ul style="list-style-type: none"> Fiber diameter: 0.5 mm Individual fiber pair 12 mm bend radius Thread 	DF-G1 D10D D10B D10A D12E	220 mm 400 mm 95 mm 75 mm 84 mm
PIT46U	Features	Sensors	Range
	<ul style="list-style-type: none"> Fiber diameter: 1.0 mm Individual fiber pair 25 mm bend radius Thread 	DF-G1 D10D D10B D10A D12E	820 mm 1200 mm 320 mm 300 mm 315 mm

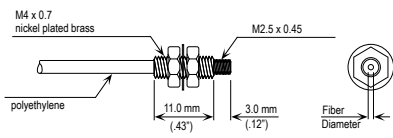
PIT66U	Features	Sensors	Range
	<ul style="list-style-type: none"> Fiber diameter: 1.5 mm Individual fiber pair 38 mm bend radius Thread Long range 	DF-G1	1320 mm
		D10D	2400 mm
		D10B	600 mm
		D10A	525 mm
		D12E	660 mm

Plastic Fiber - Diffuse Mode

Based on a 90% reflectance white test card.

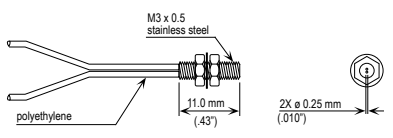
PBT16U	Features	Sensors	Range
	<ul style="list-style-type: none"> Fiber diameter: 0.25 mm Bifurcated fiber 8 mm bend radius Thread 	DF-G1	12 mm
		D10D	30 mm
		D10B	7 mm
		D10A	5 mm
		D12E	3.8 mm

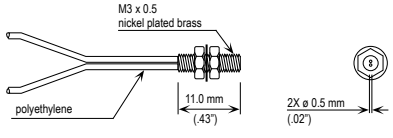
PBT26U	Features	Sensors	Range
	<ul style="list-style-type: none"> Fiber diameter: 0.5 mm Bifurcated fiber 12 mm bend radius Thread 	DF-G1	80 mm
		D10D	150 mm
		D10B	38 mm
		D10A	25 mm
		D12E	25 mm

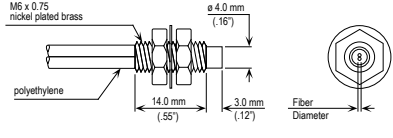
PBT46U	Features	Sensors	Range
	<ul style="list-style-type: none"> Fiber diameter: 1.0 mm Bifurcated fiber 25 mm bend radius Thread 	DF-G1	220 mm
		D10D	300 mm
		D10B	100 mm
		D10A	85 mm
		D12E	95 mm

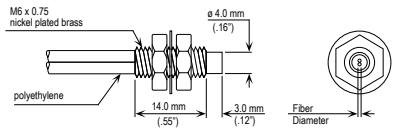
PBT66U	Features	Sensors	Range
	<ul style="list-style-type: none"> Fiber diameter: 1.5 mm Bifurcated fiber 38 mm bend radius Thread Long range 	DF-G1	310 mm
		D10D	475 mm
		D10B	200 mm
		D10A	170 mm
		D12E	190 mm

Banner Engineering Corp. Limited Warranty

Banner Engineering Corp. warrants its products to be free from defects in material and workmanship for one year following the date of shipment. Banner Engineering Corp. will repair or replace, free of charge, any product of its manufacture which, at the time it is returned to the factory, is found to have been defective during the warranty period. This warranty does not cover damage or liability for misuse, abuse, or the improper application or installation of the Banner product.

THIS LIMITED WARRANTY IS EXCLUSIVE AND IN LIEU OF ALL OTHER WARRANTIES WHETHER EXPRESS OR IMPLIED (INCLUDING, WITHOUT LIMITATION, ANY WARRANTY OF MERCHANTABILITY OR FITNESS FOR A PARTICULAR PURPOSE), AND WHETHER ARISING UNDER COURSE OF PERFORMANCE, COURSE OF DEALING OR TRADE USAGE.

This Warranty is exclusive and limited to repair or, at the discretion of Banner Engineering Corp., replacement. IN NO EVENT SHALL BANNER ENGINEERING CORP. BE LIABLE TO BUYER OR ANY OTHER PERSON OR ENTITY FOR ANY EXTRA COSTS, EXPENSES, LOSSES, LOSS OF PROFITS, OR ANY INCIDENTAL, CONSEQUENTIAL OR SPECIAL DAMAGES RESULTING FROM ANY PRODUCT DEFECT OR FROM THE USE OR INABILITY TO USE THE PRODUCT, WHETHER ARISING IN CONTRACT OR WARRANTY, STATUTE, TORT, STRICT LIABILITY, NEGLIGENCE, OR OTHERWISE.

Banner Engineering Corp. reserves the right to change, modify or improve the design of the product without assuming any obligations or liabilities relating to any product previously manufactured by Banner Engineering Corp. Any misuse, abuse, or improper application or installation of this product or use of the product for personal protection applications when the product is identified as not intended for such purposes will void the product warranty. Any modifications to this product without prior express approval by Banner Engineering Corp will void the product warranties. All specifications published in this document are subject to change; Banner reserves the right to modify product specifications or update documentation at any time. Specifications and product information in English supersede that which is provided in any other language. For the most recent version of any documentation, refer to: www.bannerengineering.com.

X-ON Electronics

Largest Supplier of Electrical and Electronic Components

Click to view similar products for [Fibre Optic Sensors](#) category:

Click to view products by [Banner](#) manufacturer:

Other Similar products are found below :

[BTA23S](#) [BF13S](#) [BT21S](#) [IAT28S](#) [E32L56E1](#) [E32L56E2](#) [FD-R31G](#) [FD-R41](#) [BF3RX-P](#) [D12E2N6FP](#) [PBT46UHT1](#) [D12SN6FVY](#) [CCS-NFCB2-CC-3](#) [CCS-LFV3-35RD](#) [CCS-QBL-120120SW](#) [E3Z-T81-M1TJ-1 0.3M](#) [S7-4-E-P](#) [CN-14A-R-C2](#) [CN-73-C1](#) [FD-42G](#) [E32-D11L 2M](#) [E32-T11L 2M](#) [FX-101-CC2](#) [FX-101P](#) [FX-101P-CC2](#) [FX-101P-Z](#) [FX-102-CC2](#) [D11SN6FP](#) [PBCL22T](#) [FT-420-10](#) [WLL180T-P432](#) [FD-31](#) [FD-62](#) [E3X-NA41 2M](#) [FT-F93](#) [FX-102P-CC2](#) [FX-502P](#) [FX-505P-C2](#) [E32-D32 2M](#) [CN-73-C2](#) [CN-24A-C5](#) [CN-24A-C2](#) [CN-14A-R-C5](#) [CN-14A-R-C1](#) [FT-42](#) [FT-A11](#) [CS1W-PTS03](#) [E32-A04 2M](#) [E32-D11R](#) [E32-T61-S](#)