

K50 Pro Touch Button

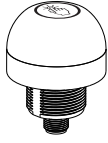

Datasheet

50 mm Programmable Multicolor RGB Indicator with Independent Momentary or Latching Touch Button Output



Standard Model



Compact Model

- Excellent immunity to false triggering by water spray, detergents, oils, and other foreign materials
- Programmable using Banner's Pro Editor software and Pro Converter Cable
- Vibration feedback models available for an unmistakable touch confirmation
- Up to 14 default colors with flash input in one unit
- Devices are completely self-contained—no controller needed
- Rated IP67 and IP69K per DIN 40050-9
- Ergonomically designed to eliminate hand, wrist, and arm stresses associated with repeated switch operation; no physical force required to operate
- 12 V DC to 30 V DC operation
- Can be actuated with bare hands or gloves; adjustable sensitivity using Pro Editor software
- Compact models available for lower profile applications
- Models constructed from FDA-grade materials available
- Configurable input/output with Pro Editor software
- Device can be configured to remember touch state on power loss using Pro Editor software



WARNING:

- **Do not use this device for personnel protection**
- Using this device for personnel protection could result in serious injury or death.
- This device does not include the self-checking redundant circuitry necessary to allow its use in personnel safety applications. A device failure or malfunction can cause either an energized (on) or de-energized (off) output condition.

Models

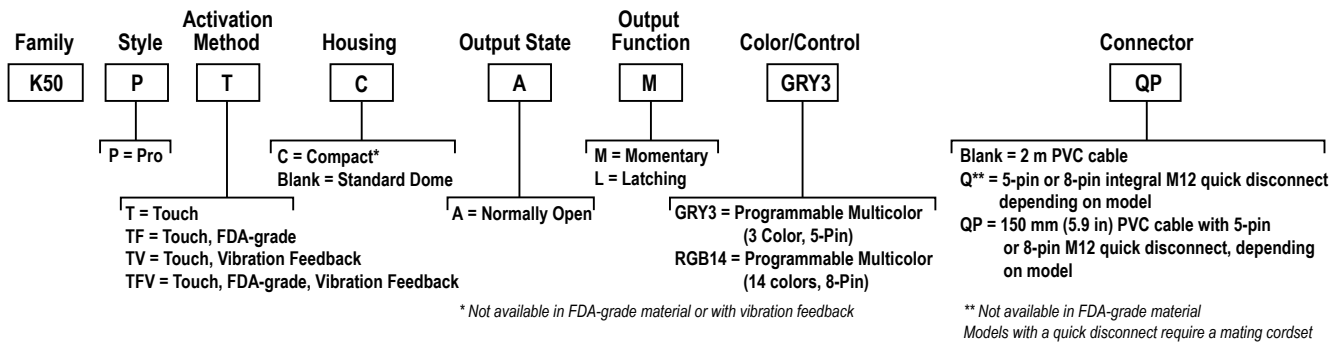

To order the touch button with an alternate laser marking than the touch icon, see [Standard Laser Marking Options](#) on page 7.

Pro Editor

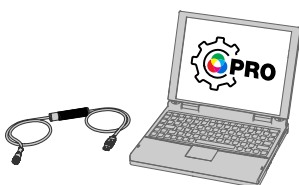

Use Banner's Pro Editor software and Pro Converter Cable to create custom configurations by selecting different colors, flash patterns, and animations. For more information visit www.bannerengineering.com/proeditor.



Vibration Feedback

Only applicable to Vibration Feedback models. See [Pro Editor Manual](#) for additional information.

Vibration	Description
Off	No vibration on touch
On	Steady vibration on touch
Pattern	Only available if Animation is defined as Flash or Two Color Flash. The vibration follows the defined animation flash Pattern (Normal, Strobe, 3-Pulse, SOS, Random) and animation Speed (Slow, Standard, Fast).

Wiring Diagrams

For the Vibration Feedback models, for all touch conditions, the default **Vibration Feedback** is **On** and the type of vibration feedback is **Steady**.

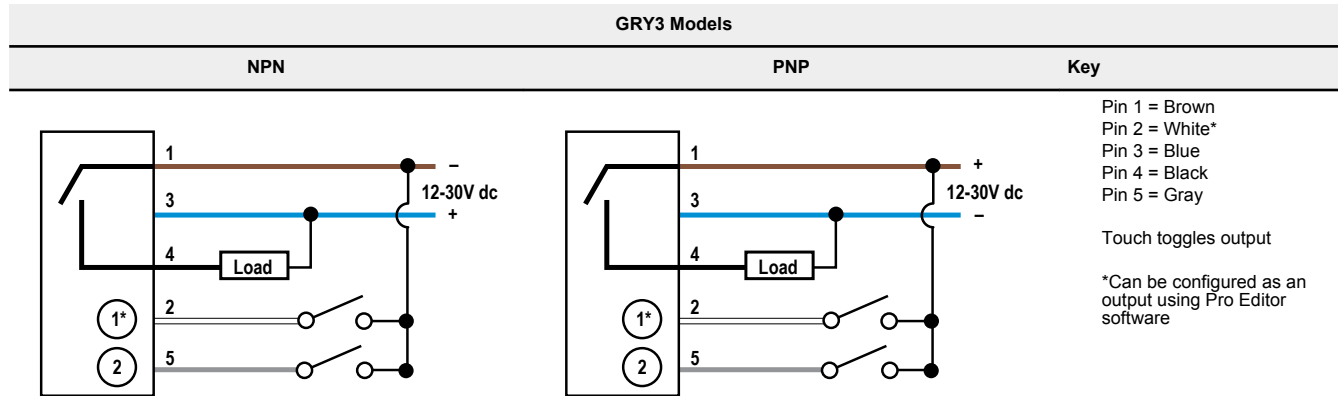

Table 1: GRY3 Multicolor Color/Function Definition

	Green	Yellow	Red
Input 1	X	X	
Input 2		X	X

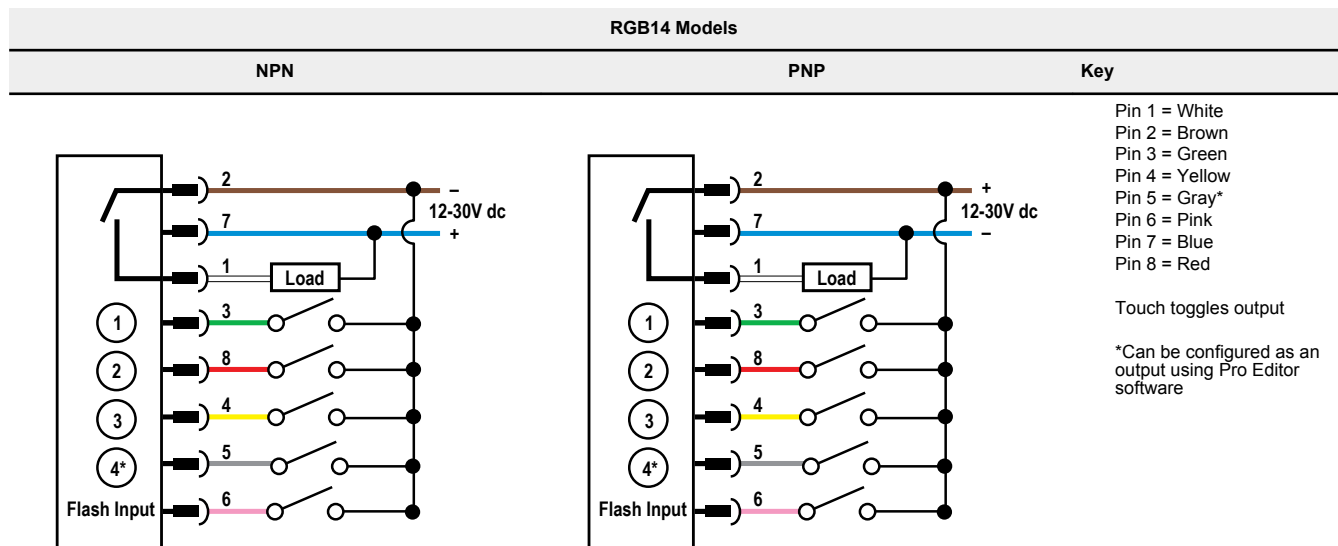

Table 2: RGB Multicolor Color/Function Definition

	Red	Yellow	Green	Cyan	Blue	Magenta	White	Amber	Rose	Lime Green	Orange	Sky Blue	Violet	Spring Green
Input 1	X	X				X	X		X		X		X	
Input 2		X	X	X			X			X	X			X
Input 3				X	X	X	X					X	X	X
Input 4								X	X	X	X	X	X	X

Specifications

Supply Voltage

12 V DC to 30 V DC

Supply Current

175 mA maximum current at 12 V DC (exclusive of load)
93 mA maximum current at 24 V DC (exclusive of load)
82 mA maximum current at 30 V DC (exclusive of load)

Supply Protection Circuitry

Protected against reverse polarity and transient voltages

Leakage Current Immunity

400 µA

Output Rating

Maximum load: 150 mA
ON-state saturation voltage: < 2 V DC at 10 mA; <2.5 V DC at 150 mA
OFF-state leakage current: <10 µA at 30 V DC

Output Response Time

Power-Up Delay: 500 milliseconds maximum
Input Response: 40 milliseconds maximum
Output Response: 300 milliseconds maximum

Touch Dwell Time

If touch dwells for longer than 60 seconds, the output will revert to the untouched state

Vibration Feedback Characteristics

Max Total On-Time Per Touch: 3 seconds
Mechanical Life: 500,000 cycles
For all touch conditions, the default Vibration Feedback is On and the type of vibration feedback is Steady

Operating Conditions

−40 °C to +50 °C (−40 °F to +122 °F)
Humidity: 90% at +50 °C maximum relative humidity (non-condensing)

Environmental Rating

Standard Models: IP67, IP69K per DIN 40050-9
Cabled models also meet IP69K per DIN 40050-9 if the cable and cable entrance are protected from high-pressure spray
FDA Models: IP67, IP69K per DIN 40050-9

Mounting

M30 × 1.5 threaded base, maximum torque 4.5 N·m (40 in·lbf)

Construction

Standard Model Base, Dome, and Nut: Polycarbonate
FDA Model Base, Dome, and Nut: FDA-grade copolyester

Pro Editor Configuration

Connection to Pro Editor software enables control of:

- **Animation:** Steady, Flash, Two Color Flash, 50/50, 50/50 Rotate, Chase, Intensity Sweep, Demo
- **Color:** Green, Red, Yellow, Blue, White, Cyan, Magenta, Amber, Rose, Lime Green, Orange, Sky Blue, Violet, Spring Green
- **Intensity:** Low, Medium, High
- **Speed:** Slow, Standard, Fast
- **Output State:** Normally Open, Normally Closed, Momentary, Latching, On Delay, Off Delay, Remember Touch State on Power Loss
- **Vibration Feedback:** On, Pattern, Off
- **Touch Sensitivity:** Low, Standard, High
- **Logic Type:** Three State Advanced Control (F2 Mode), Seven State Advanced Control (F2 Mode), Four State Full Logic (Custom)
- One pin configurable as either an input or an output

Pro Converter Cable required to interface between PC and indicator, see [Accessories](#) on page 4

Refer to [Pro Editor Manual](#) for additional information

Default Indicator Characteristics

Color	Dominant Wavelength (nm) or Color Temperature (CCT)	Color Coordinates ¹		Lumen Output (Typical at 25 °C) ²
		x	y	
Green	522	0.154	0.700	16.5
Red	620	0.689	0.309	8.3
Yellow	576	0.477	0.493	23.8
Blue	466	0.140	0.054	4.6
White	5700K	0.328	0.337	25.1
Cyan	493	0.170	0.340	18.4
Magenta	–	0.379	0.172	11.1
Amber	589	0.556	0.420	15.7
Rose	–	0.515	0.220	9.1
Lime Green	562	0.388	0.561	21.4
Sky Blue	486	0.155	0.247	19.5
Orange	599	0.616	0.370	12.1
Violet	–	0.217	0.089	9.7
Spring Green	508	0.177	0.536	17.0

¹ Refer to the CIE 1931 (x,y) Chromaticity Diagram to show equivalent color with indicated color coordinates. Actual coordinates may differ ± 5%.

² Values shown apply to dome models only. Compact models are 20% lower.

Vibration and Mechanical Shock

Meets IEC 60068-2-6 requirements (Vibration: 10 Hz to 55 Hz, 1.0 mm amplitude, 5 minutes sweep, 30 minutes dwell)
 Meets IEC 60068-2-27 requirements (Shock: 30G 11 ms duration, half sine wave)

Connections

5-pin or 8-pin integral M12 quick disconnect, 2 m (6.5 ft) integral PVC cable, or 5-pin or 8-pin 150 mm (5.9 inch) PVC cable with an M12 quick disconnect, depending on model
 Models with a quick disconnect require a mating cordset

Storage

-40 °C to +70 °C (-40 °F to +158 °F)

Certifications



Banner Engineering Europe Park Lane,
 Culliganlaan 2F bus 3, 1831 Diegem,
 BELGIUM



Turck Banner LTD Blenheim House,
 Blenheim Court, Wickford, Essex SS11 8YT,
 Great Britain



Required Overcurrent Protection



WARNING: Electrical connections must be made by qualified personnel in accordance with local and national electrical codes and regulations.

Overcurrent protection is required to be provided by end product application per the supplied table.
 Overcurrent protection may be provided with external fusing or via Current Limiting, Class 2 Power Supply.
 Supply wiring leads < 24 AWG shall not be spliced.
 For additional product support, go to www.bannerengineering.com.

Supply Wiring (AWG)	Required Overcurrent Protection (Amps)
20	5.0
22	3.0
24	2.0
26	1.0
28	0.8
30	0.5

Dimensions

Standard Models

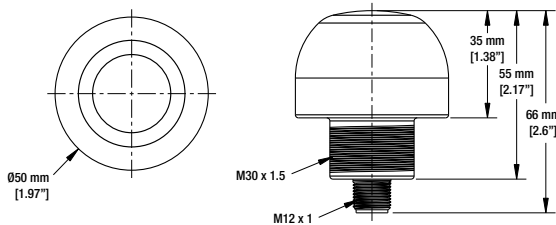

Compact Models

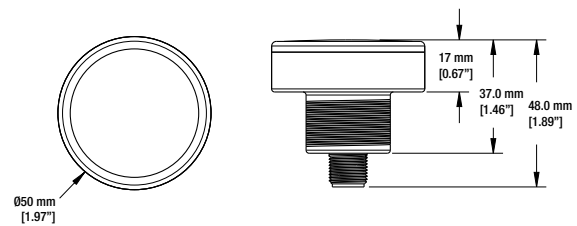

All measurements are listed in millimeters [inches], unless noted otherwise.

Accessories

Pro Editor Hardware

MQDC-506-USB

- Pro Converter Cable
- 1.83 m (6 ft) length 5-pin M12 quick disconnect to Device and USB to PC
- Required for connection to Pro Editor

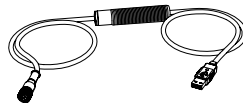

CSB-M1251FM1251M

- 5-pin parallel Y splitter (Male-Male-Female)
- For full Pro Editor preview capability
- Requires external power supply, sold separately

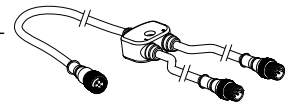

PSW-24-1

- 24 V DC, 1 A power supply
- 2 m (6.5 ft) PVC cable with M12 quick disconnect
- Provides external power with splitter cable, sold separately

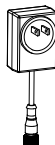

ACC-PRO-CABLE5

- Mating accessory for cabled and terminal models
- 150 mm (6 inch) PVC cable with M12 quick disconnect
- Lever wire nuts included (qty 5)
- Required to connect cabled models and screw terminal models to Pro Converter Cable, sold separately

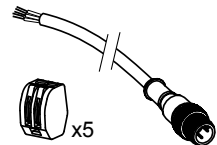

MQDC-801-5M-PRO

- 8-pin to 5-pin double-ended cordset
- 0.31 m (1 ft) PVC cable with M12 quick disconnects
- Required to connect 8-pin Pro Series-enabled devices to Pro Converter Cable (MQDC-506-USB), sold separately



Cordsets

5-Pin Threaded M12 Cordsets—Single Ended				
Model	Length	Style	Dimensions	Pinout (Female)
MQDC1-501.5	0.5 m (1.5 ft)	Straight		<p>1 = Brown 2 = White 3 = Blue 4 = Black 5 = Gray</p>
MQDC1-506	2 m (6.5 ft)			
MQDC1-515	5 m (16.4 ft)			
MQDC1-530	9 m (29.5 ft)			
MQDC1-506RA	2 m (6.5 ft)	Right-Angle		<p>1 = Brown 2 = White 3 = Blue 4 = Black 5 = Gray</p>
MQDC1-515RA	5 m (16.4 ft)			
MQDC1-530RA	9 m (29.5 ft)			

5-Pin Threaded M12 Stainless Steel Washdown Cordsets—Single Ended				
Model	Length	Style	Dimensions	Pinout (Female)
MQDC-WDSS-0506	2 m (6.56 ft)	Straight		<p>1 = Brown 2 = White 3 = Blue 4 = Black 5 = Gray</p>
MQDC-WDSS-0515	5 m (16.4 ft)			
MQDC-WDSS-0530	9 m (29.5 ft)			

8-Pin Threaded M12 Cordsets with Open-Shield—Single Ended				
Model	Length	Style	Dimensions	Pinout (Female)
MQDC2S-806	2.04 m (6.7 ft)	Straight		<p>1 = White 2 = Brown 3 = Green 4 = Yellow 5 = Gray 6 = Pink 7 = Blue 8 = Red</p>
MQDC2S-815	5.04 m (16.54 ft)			
MQDC2S-830	10.04 m (32.95 ft)			
MQDC2S-850	16 m (52.49 ft)			

8-Pin Threaded M12 Cordsets with Open-Shield—Single Ended				
Model	Length	Style	Dimensions	Pinout (Female)
MQDC2S-806RA	2 m (6.56 ft)	Right-Angle		
MQDC2S-815RA	5 m (16.4 ft)			
MQDC2S-830RA	10 m (32.81 ft)			
MQDC2S-850RA	16 m (52.49 ft)			

8-Pin Threaded M12 Cordsets with Open-Shield—Washdown, Stainless Steel				
Model	Length	Style	Dimensions	Pinout (Female)
MQDC-WDSS-0806	2 m (6.56 ft)	Straight		
MQDC-WDSS-0815	5 m (16.4 ft)			
MQDC-WDSS-0830	9 m (29.53 ft)			

1 = White
2 = Brown
3 = Green
4 = Yellow
5 = Gray
6 = Pink
7 = Blue
8 = Red

Brackets

SMB30A

- Right-angle bracket with curved slot for versatile orientation
- Clearance for M6 (1/4 in) hardware
- Mounting hole for 30 mm sensor
- 12-ga. stainless steel

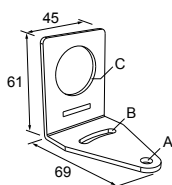

Hole center spacing: A to B=40

Hole size: A=ø 6.3, B= 27.1 x 6.3, C=ø 30.5

SMB30FA

- Swivel bracket with tilt and pan movement for precise adjustment
- Mounting hole for 30 mm sensor
- 12-ga. 304 stainless steel
- Easy sensor mounting to extrude rail T-slot
- Metric and inch size bolt available

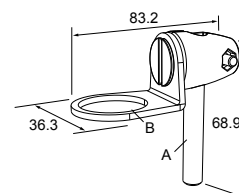

Bolt thread: SMB30FA, A= 3/8 - 16 x 2 in; SMB30FAM10, A= M10 - 1.5 x 50
Hole size: B= ø 30.1

SMB30FVK

- V-clamp, flat bracket and fasteners for mounting to pipe or extensions
- Clamp accommodates 28 mm dia. tubing or 1 in. square extrusions
- 30 mm hole for mounting sensors

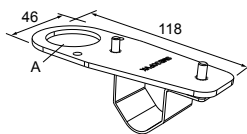

Hole size: A= ø 31

SMB30MM

- 12-ga. stainless steel bracket with curved mounting slots for versatile orientation
- Clearance for M6 (1/4 in) hardware
- Mounting hole for 30 mm sensor

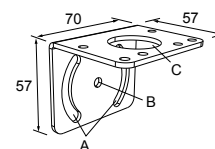

Hole center spacing: A = 51, A to B = 25.4
Hole size: A = 42.6 x 7, B = ø 6.4, C = ø 30.1

SMB30RAVK

- V-clamp, right-angle bracket and fasteners for mounting sensors to pipe or extrusion
- Clamp accommodates 28 mm dia. tubing or 1 in. square extrusions
- 30 mm hole for mounting sensors

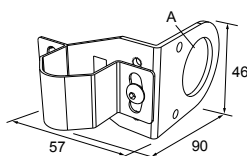

Hole size: A = ø 30.5

SMB30SC

- Swivel bracket with 30 mm mounting hole for sensor
- Black reinforced thermoplastic polyester
- Stainless steel mounting and swivel locking hardware included

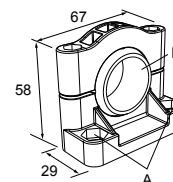

Hole center spacing: A=ø 50.8
Hole size: A=ø 7.0, B=ø 30.0

SMBAMS30P

- Flat SMBAMS series bracket
- 30 mm hole for mounting sensors
- Articulation slots for 90°+ rotation
- 12-ga. 300 series stainless steel

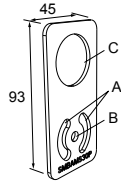

Hole center spacing: A=26.0, A to B=13.0
Hole size: A=26.8 x 7.0, B=∅ 6.5, C=∅ 31.0

SMBAMS30RA

- Right-angle SMBAMS series bracket
- 30 mm hole for mounting sensors
- Articulation slots for 90°+ rotation
- 12-ga. (2.6 mm) cold-rolled steel

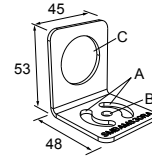

Hole center spacing: A=26.0, A to B=13.0
Hole size: A=26.8 x 7.0, B=∅ 6.5, C=∅ 31.0

TC-K50-CL

- Touch cover

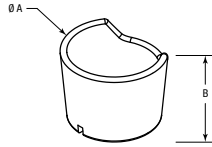

Diameter: A = 67 mm
Height: B = 42.5 mm

Standard Laser Marking Options

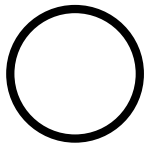

Circle Icon
 (add **-CRCLI** to model number)



Power/Start Icon
 (add **-STRTI** to model number)



Stop Icon
 (add **-STOPI** to model number)

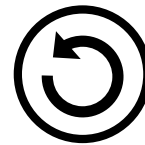

Reset Icon
 (add **-RSETI** to model number)

Example: K50PTAMGRY3Q-RSETI

Banner Engineering Corp Limited Warranty

Banner Engineering Corp. warrants its products to be free from defects in material and workmanship for one year following the date of shipment. Banner Engineering Corp. will repair or replace, free of charge, any product of its manufacture which, at the time it is returned to the factory, is found to have been defective during the warranty period. This warranty does not cover damage or liability for misuse, abuse, or the improper application or installation of the Banner product.

THIS LIMITED WARRANTY IS EXCLUSIVE AND IN LIEU OF ALL OTHER WARRANTIES WHETHER EXPRESS OR IMPLIED (INCLUDING, WITHOUT LIMITATION, ANY WARRANTY OF MERCHANTABILITY OR FITNESS FOR A PARTICULAR PURPOSE), AND WHETHER ARISING UNDER COURSE OF PERFORMANCE, COURSE OF DEALING OR TRADE USAGE.

This Warranty is exclusive and limited to repair or, at the discretion of Banner Engineering Corp., replacement. **IN NO EVENT SHALL BANNER ENGINEERING CORP. BE LIABLE TO BUYER OR ANY OTHER PERSON OR ENTITY FOR ANY EXTRA COSTS, EXPENSES, LOSSES, LOSS OF PROFITS, OR ANY INCIDENTAL, CONSEQUENTIAL OR SPECIAL DAMAGES RESULTING FROM ANY PRODUCT DEFECT OR FROM THE USE OR INABILITY TO USE THE PRODUCT, WHETHER ARISING IN CONTRACT OR WARRANTY, STATUTE, TORT, STRICT LIABILITY, NEGLIGENCE, OR OTHERWISE.**

Banner Engineering Corp. reserves the right to change, modify or improve the design of the product without assuming any obligations or liabilities relating to any product previously manufactured by Banner Engineering Corp. Any misuse, abuse, or improper application or installation of this product or use of the product for personal protection applications when the product is identified as not intended for such purposes will void the product warranty. Any modifications to this product without prior express approval by Banner Engineering Corp will void the product warranties. All specifications published in this document are subject to change; Banner reserves the right to modify product specifications or update documentation at any time. Specifications and product information in English supersede that which is provided in any other language. For the most recent version of any documentation, refer to: www.bannerengineering.com.

For patent information, see www.bannerengineering.com/patents.

FCC Part 15

This device complies with Part 15 of the FCC Rules. This equipment generates, uses, and can radiate radio frequency energy and, if not installed and used in accordance with the instruction manual, may cause harmful interference to radio communications. Operation is subject to the following two conditions: 1) This device may not cause harmful interference; and 2) This device must accept any interference received, including interference that may cause undesired operation.

Industry Canada

This device complies with CAN ICES-3 (B)/NMB-3(B). Operation is subject to the following two conditions: 1) This device may not cause harmful interference; and 2) This device must accept any interference received, including interference that may cause undesired operation.

Cet appareil est conforme à la norme NMB-3(B). Le fonctionnement est soumis aux deux conditions suivantes : (1) ce dispositif ne peut pas occasionner d'interférences, et (2) il doit tolérer toute interférence, y compris celles susceptibles de provoquer un fonctionnement non souhaité du dispositif.

X-ON Electronics

Largest Supplier of Electrical and Electronic Components

Click to view similar products for [Beacons](#) category:

Click to view products by [Banner](#) manufacturer:

Other Similar products are found below :

[K50APTWXDQ](#) [K50ABT2XGH](#) [K50APT2GXDQ](#) [K50ABTGRHQ](#) [K50APT2FGRYF2QP](#) [K50LGRYPPB1Q](#) [K50APTGRCQ](#)
[K50APTGRYF2](#) [K50ABT2GYHQ](#) [K50APTGRYC3Q](#) [K50APT2GREQP](#) [K50APT2GRYF2Q](#) [K100PBLGYRQ](#) [K30LGRYPPB2](#)
[K30APPBGREQP](#) [K30APT2FGRYF2QP](#) [K30LGRXPPB2Q](#) [K30LGRYPPB2Q](#) [K30APT2RGF2](#) [K30APTXRQF2](#) [K30APTXXWF2](#)
[K30PTALRGB7](#) [K30PTAMGRY3QP](#) [K30PTALGRY3Q](#) [K30PTAMGRY3Q](#) [K30PTALRGB7Q](#) [K30PTAMRGB7Q](#) [K50APPBGRYF2Q8](#)
[K50BCLXRXPQ](#) [K50BCLS1XYXPQ](#) [K50BCLGRBP](#) [K50BCLXGXP](#) [K50BCLS1XRXPQ](#) [K50BLGRXPQ](#) [K50LGRYPPB2](#)
[K50LGXXPPB2Q](#) [K50LGRXPPB2Q](#) [K50LBXXPPB2Q](#) [K50LGYXPPB2Q](#) [K50PBLSQ](#) [K50PBLRQ7B](#) [K50PFF100AMGRY3Q](#)
[K50PTAMGRY3](#) [K50PTAMGRY3AQP](#) [K50PTKAQ](#) [K50PTAMGRY3AQ](#) [K50PTAMRGB7AQ](#) [K50PTCAMGRY3AQ](#)
[K50PTCAMGRY3Q-812166](#) [K50PTCAMGRY3Q](#)