

## Datasheet

The Sure Cross® K50U sensor works in a variety of environments to provide a measurement of the distance between the target and the sensor. It is designed for use with MultiHop Modbus radios, creating a cost-effective solution for monitoring remote or mobile tanks and totes.

### Benefits

- Monitor wirelessly to avoid long cable runs
- Threaded housing for easy installation
- Easily monitor remote and mobile tanks and totes
- Completely wireless solution with 2+ year battery life at default sample rates
- Provides a distance measurement from the target to the sensor
- Built-in temperature compensation
- Rugged design for demanding sensing environments; rated IEC IP67, NEMA 6P
- Functions as a Modbus slave device using RS-485
- Designed to interface to the RS-485 Modbus network through a Euro-style cordset



### WARNING: Not To Be Used for Personnel Protection

**Never use this device as a sensing device for personnel protection. Doing so could lead to serious injury or death.** This device does not include the self-checking redundant circuitry necessary to allow its use in personnel safety applications. A sensor failure or malfunction can cause either an energized or de-energized sensor output condition.

## Models

Model	Range and Frequency	Supply Voltage	I/O
K50UX2ARA	Range: 100 mm to 1 m (3.94 in to 39.4 in) Freq: 224 kHz	3.6 to 5.5 V dc or 10 to 30 V dc	Distance to target using Modbus RS-485
K50UX2CRA	Range: 300 mm to 3 m (11.8 in to 118 in) Freq: 114 kHz		

## Overview

The K50U is an easy-to-use ultrasonic sensor with extended range and built-in temperature compensation. This sensor is designed to interface to the RS-485 Modbus network through a 5-pin M12/Euro-style female cordset. To install the sensor to a cable, follow these instructions:

1. Align the notch in the cable's female connector with the key in the sensor's male connector.
2. Gently slide the sensor end into the cable's connector.
3. Rotate the cable's threaded nut to tighten the sensor down. DO NOT attempt to rotate the sensor after it is connected to the cable end, this will damage the sensor.

Indicator LEDs communicate the status of the sensor. The flashing green Power LED indicates the sensor is in Run Mode (the sensor's normal operating condition).

Configure this sensor using the Sure Cross® [Sensor Configuration Tool](#) (instruction manual [170002](#)) and adapter cable BWA-HW-006 (datasheet [140377](#)).

## Principles of Operation

Ultrasonic sensors emit one or multiple pulses of ultrasonic energy, which travel through the air at the speed of sound. A portion of this energy reflects off the target and travels back to the sensor. The sensor measures the total time required for the energy to reach the target and return to the sensor. The distance to the object is then calculated using the following formula:  $D = ct \div 2$



**D** = distance from the sensor to the target  
**c** = speed of sound in air  
**t** = transit time for the ultrasonic pulse

To improve accuracy, an ultrasonic sensor may average the results of several pulses before outputting a new value.

## Temperature Effects

The speed of sound is dependent upon the composition, pressure and temperature of the gas in which it is traveling. For most ultrasonic applications, the composition and pressure of the gas are relatively fixed, while the temperature may fluctuate.

In air, the speed of sound varies with temperature according to the following approximation:

$$\text{In metric units: } C_{m/s} = 20 \sqrt{273 + T_C}$$

$$\text{In English units: } C_{ft/s} = 49 \sqrt{460 + T_F}$$

$C_{m/s}$  = speed of sound in meters per second

$C_{ft/s}$  = speed of sound in feet per second

$T_C$  = temperature in °C

$T_F$  = temperature in °F

## Temperature Compensation

Changes in air temperature affect the speed of sound, which in turn affects the total time for the echo measured by the sensor. An increase in air temperature shifts both sensing window limits closer to the sensor. Conversely, a decrease in air temperature shifts both limits farther away from the sensor. This shift is approximately 3.5% of the limit distance for a 20° C change in temperature.

The K50U series ultrasonic sensors are temperature compensated, to reduce sensor errors from temperature by about 90%. Exposure to direct sunlight can affect the sensor's ability to accurately compensate for changes in temperature.

## LED Indicators

	Signal LED (red)	Power LED (green)
Power is Off		Off
Sensor is operating normally (power is on, sensor is in Run mode)		Flashing
Serial Communications Transmit/Receive	Intermittent Flashing	
Error	Continuous Flashing	
Reserved	Off	

**Self-Diagnostic Error Mode**—In the unlikely event of a microprocessor memory error, the Signal LED continuously flashes. If this occurs, the setup parameters have been lost and the sensor may be corrupt. Contact your Banner representative for further information.

## Sensor Configuration Tool

The Sensor Configuration Tool offers an easy way to manage sensor parameters, retrieve data, and visually show sensor data from a number of different sensors. The Sensor Configuration Tool software runs on any Windows machine and uses an adapter cable to connect the sensor to your computer.

Download the most recent version of the Sensor Configuration Tool from Banner Engineering's website: [www.bannerengineering.com/wireless](http://www.bannerengineering.com/wireless). The Sensor Configuration Tool currently supports the following sensors:

Sensor Type	Model	USB Adapter Cable
Temperature and Humidity	M12FTH3Q and M12FT3Q	Model BWA-HW-006: USB-to-RS-485 adapter cable OR Model BWA-UCT-900: USB to RS-485 adapter cable
	M12FTH4Q and M12FT4Q	Model BWA-USB1WIRE-001: USB-to-RS-232 1-Wire adapter cable
Vibration and Temperature	QM42VT1	Model BWA-USB1WIRE-001: USB-to-RS-232 1-Wire adapter cable
	QM42VT2	Model BWA-HW-006: USB-to-RS-485 adapter cable OR Model BWA-UCT-900: USB to RS-485 adapter cable OR When updating the firmware, you must use one of the two USB to RS-485 adapter cables plus a splitter pigtail cable p/n 83265

Sensor Type	Model	USB Adapter Cable
GPS	GPS50M	Model BWA-HW-006: USB-to-RS-485 adapter cable AND a field-wireable M12/Euro-style connector or connector with pigtail OR Model BWA-UCT-900: USB to RS-485 adapter cable AND a field-wireable M12/Euro-style connector or connector with pigtail
U-GAGE K50U Ultrasonic	K50UX1CRA	Model BWA-USB1WIRE-001: USB-to-RS-232 1-Wire adapter cable
	K50UX2CRA	Model BWA-HW-006: USB-to-RS-485 adapter cable OR Model BWA-UCT-900: USB to RS-485 adapter cable
	K50UX1ARA	Model BWA-USB1WIRE-001: USB-to-RS-232 1-Wire adapter cable
	K50UX2ARA	Model BWA-HW-006: USB-to-RS-485 adapter cable OR Model BWA-UCT-900: USB to RS-485 adapter cable

To update your sensor's firmware, follow the instructions in the Sensor Configuration Tool Instruction Manual (p/n [170002](#)).

## Wiring

This sensor is designed for use as a Modbus slave. This sensor can be plugged into any Modbus RS-485 network, including compatible Nodes and MultiHop Data Radios.

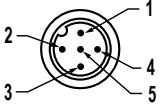
5-pin M12/Euro-style Male Connector	Pin	Wire Color	Sensor Connection
	1	Brown	Power IN (+). Either 3.6 to 5.5 V dc or 10 to 30 V dc
	2	White	RS485 / D1 / B / +
	3	Blue	Ground (-)
	4	Black	RS485 / D0 / A / -
	5	Gray	Not Used (default) or Discrete NPN Select Line (optional)

## Holding Registers

The distance (in) and the temperature (°C and °F) = (Modbus register value) ÷ 100.

Modbus Register Alias Address	Modbus Register Address	Output Type	I/O Range		Holding Register Representation	
			Min	Max	Min (Dec)	Max (Dec)
5201	1	Distance (mm)	0	65535	0	65535
5202	6	Distance (in)	0	655.35	0	65535
5203	5	Temperature °F	-327.68	327.67	-32768	32767
5204	4	Temperature °C	-327.68	327.67	-32768	32767

Modbus Register Address	Parameters	Values
6101	Baud	0 = 9.6 k 1 = 19.2 k (default) 2 = 38.4 k
6102	Parity	0 = None (default) 1 = Odd 2 = Even
6103	Modbus Slave Address	1 (default) through 247

Distance readings below 250 mm (9.84 in) for model K50UX2CRA and below 75 mm (2.95 in) for model K50UX2ARA result in a register value of 0. If no reflection is received because the target is too far away, the register value is an error value of 65535.

## Specifications

### Supply Voltage

3.6 to 5.5 V dc or 10 to 30 V dc

### Current

Active comms: 11.3 mA at 30 V dc

### Indicators

Two LEDs

### K50UX2CRA Performance

Sensing range: 300 mm to 3 m (11.8 in to 118 in)  
 Ultrasonic frequency: 114 kHz  
 Temperature effect: 0.02% of distance/°C  
 Resolution: 0.1% of distance (1.5 mm minimum)

### K50UX2ARA Performance

Sensing range: 100 mm to 1 m (3.94 in to 39.4 in)  
 Ultrasonic frequency: 224 kHz  
 Temperature effect: 0.02% of distance/°C  
 Resolution: 0.1% of distance (1.5 mm minimum)

### Discrete Inputs

One Sinking  
 Rating: 3 mA max current at 30 V dc  
 ON Condition: Less than 0.7 V  
 OFF Condition: Greater than 2 V or open

### Communication Protocol

Modbus RTU

### Environmental Rating<sup>1</sup>

Leakproof design, rated IEC IP67 (NEMA 6)

### Operating Conditions

-40 °C to +70 °C (-40 °F to +158 °F)  
 95% at +50 °C maximum relative humidity (non-condensing)

### Construction

Housing: PBT polyester  
 Transducer: epoxy/ceramic composite

### Connection

Integral 5-pin M12/Euro-style male quick disconnect

### Communication Hardware

RS-485 Serial  
 Baud Rates: 9.6k, 19.2k (default), or 38.4k  
 Data Format: 8 data bits, No parity (default), even parity, or odd parity  
 1 stop bit  
 Do not use a termination resistor.

### Communications Line

Level Receive ON: Greater than 2 V  
 Level Receive OFF: Less than 0.7 V  
 Level Transmit ON: 2.7 to 3 V  
 Level Transmit OFF: 0 V (pulldown resistor of 10 kOhm)

### Vibration and Mechanical Shock

All models meet MIL-STD-202F, Method 201A (Vibration: 10 Hz to 60 Hz maximum, 0.06 inch (1.52 mm) double amplitude, 10G maximum acceleration) requirements. Also meets IEC 60947-5-2 (Shock: 30G 11 ms duration, half sine wave) requirements.

### Certifications



## Dimensions

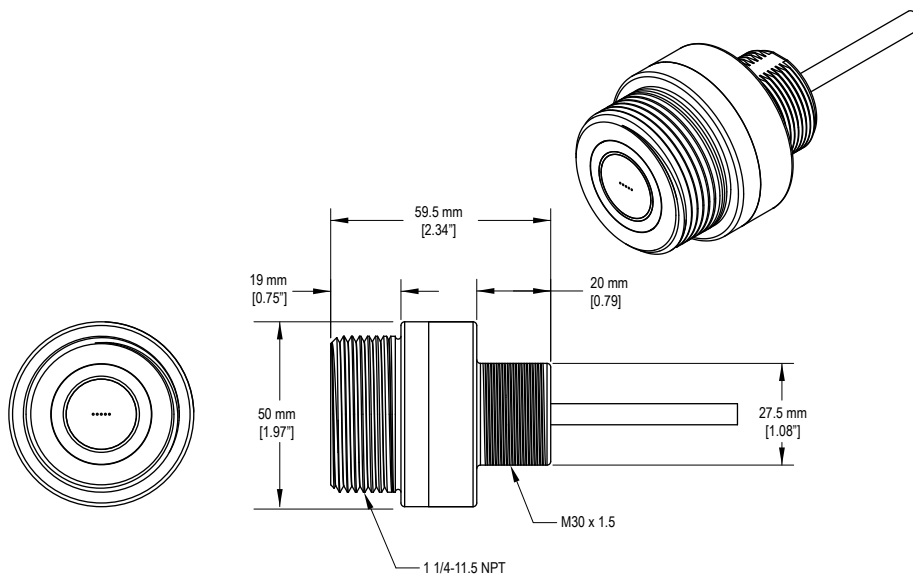

All measurements are listed in millimeters [inches], unless noted otherwise.

<sup>1</sup> Operating the devices at the maximum operating conditions for extended periods can shorten the life of the device.

## Performance Curves

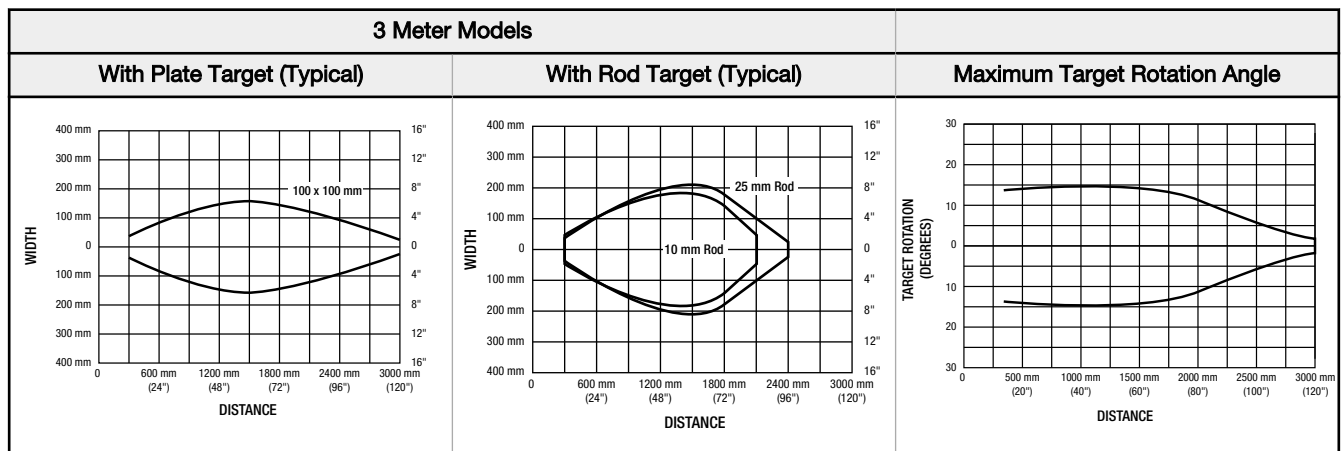
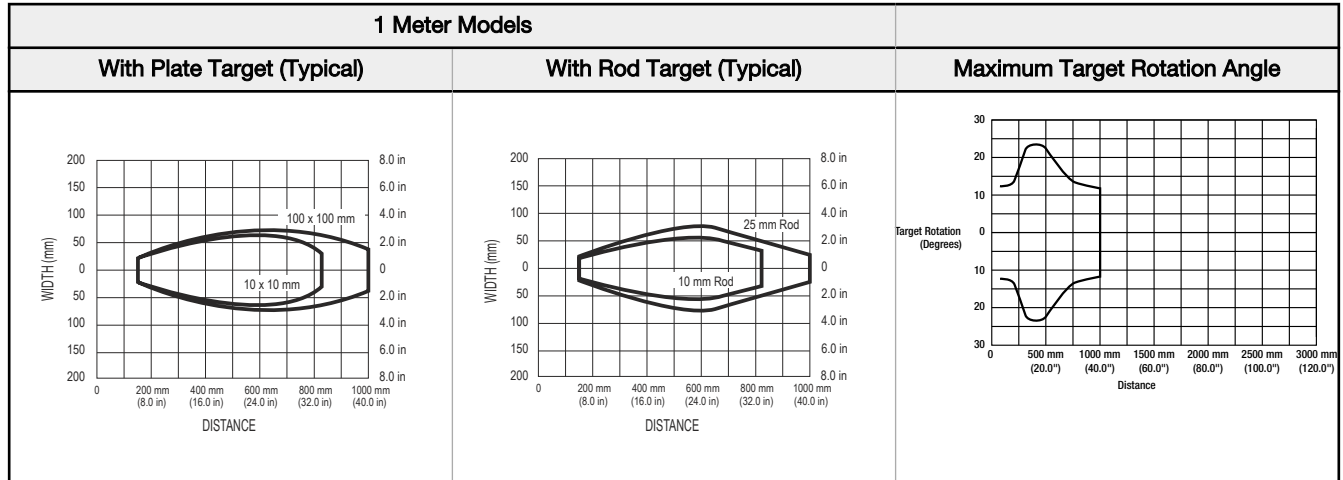

## Accessories

### Brackets

#### BWA-BK-004

- Mounts both the K50U Ultrasonic sensor and a Wireless Q45U Node or DX80 Node

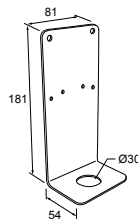

#### BWA-BK-006

- Mounts both the K50U Ultrasonic sensor and a Wireless Q45U Node

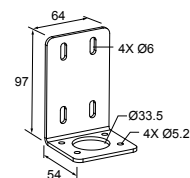

### Euro-Style Cordsets - Double Ended

When using the FlexPower Node with integrated battery, use a double ended cordset. When using a FlexPower Node with external power supply, use a single ended cordset. **If using the communication lines, the cable length cannot exceed 3 meters (10 ft).**

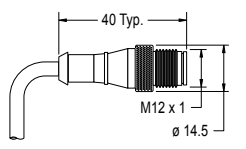
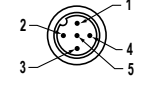
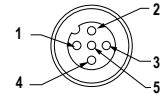
5-Pin Threaded M12/Euro-Style Cordsets—Double Ended and Less Than 3 m Long				
Model	Length	Style	Dimensions	Pinout
DEE2R-51D	0.31 m (1 ft)	Female Straight/ Male Straight		Male
DEE2R-53D	0.91 m (3 ft)			
DEE2R-58D	2.44 m (8 ft)			Female
				<p>1 = Brown 2 = White 3 = Blue 4 = Black 5 = Green/Yellow</p>

## Banner Engineering Corp. Limited Warranty

Banner Engineering Corp. warrants its products to be free from defects in material and workmanship for one year following the date of shipment. Banner Engineering Corp. will repair or replace, free of charge, any product of its manufacture which, at the time it is returned to the factory, is found to have been defective during the warranty period. This warranty does not cover damage or liability for misuse, abuse, or the improper application or installation of the Banner product.

**THIS LIMITED WARRANTY IS EXCLUSIVE AND IN LIEU OF ALL OTHER WARRANTIES WHETHER EXPRESS OR IMPLIED (INCLUDING, WITHOUT LIMITATION, ANY WARRANTY OF MERCHANTABILITY OR FITNESS FOR A PARTICULAR PURPOSE), AND WHETHER ARISING UNDER COURSE OF PERFORMANCE, COURSE OF DEALING OR TRADE USAGE.**

This Warranty is exclusive and limited to repair or, at the discretion of Banner Engineering Corp., replacement. **IN NO EVENT SHALL BANNER ENGINEERING CORP. BE LIABLE TO BUYER OR ANY OTHER PERSON OR ENTITY FOR ANY EXTRA COSTS, EXPENSES, LOSSES, LOSS OF PROFITS, OR ANY INCIDENTAL, CONSEQUENTIAL OR SPECIAL DAMAGES RESULTING FROM ANY PRODUCT DEFECT OR FROM THE USE OR INABILITY TO USE THE PRODUCT, WHETHER ARISING IN CONTRACT OR WARRANTY, STATUTE, TORT, STRICT LIABILITY, NEGLIGENCE, OR OTHERWISE.**

Banner Engineering Corp. reserves the right to change, modify or improve the design of the product without assuming any obligations or liabilities relating to any product previously manufactured by Banner Engineering Corp. Any misuse, abuse, or improper application or installation of this product or use of the product for personal protection applications when the product is identified as not intended for such purposes will void the product warranty. Any modifications to this product without prior express approval by Banner Engineering Corp will void the product warranties. All specifications published in this document are subject to change; Banner reserves the right to modify product specifications or update documentation at any time. Specifications and product information in English supersede that which is provided in any other language. For the most recent version of any documentation, refer to: [www.bannerengineering.com](http://www.bannerengineering.com).

## X-ON Electronics

Largest Supplier of Electrical and Electronic Components

*Click to view similar products for [Beacons](#) category:*

*Click to view products by [Banner](#) manufacturer:*

Other Similar products are found below :

[K50APTWXDQ](#) [K50ABT2XGH](#) [K50APT2GXDQ](#) [K50ABTGRHQ](#) [K50APT2FGRYF2QP](#) [K50LGRYPPB1Q](#) [K50APTGRCQ](#)  
[K50APTGRYF2](#) [K50ABT2GYHQ](#) [K50APTGRYC3Q](#) [K50APT2GREQP](#) [K50APT2GRYF2Q](#) [K100PBLGYRQ](#) [K30LGRYPPB2](#)  
[K30APPBGREQP](#) [K30APT2FGRYF2QP](#) [K30LGRXPPB2Q](#) [K30LGRYPPB2Q](#) [K30APT2RGF2](#) [K30APTXRQF2](#) [K30APTXXWF2](#)  
[K30PTALRGB7](#) [K30PTAMGRY3QP](#) [K30PTALGRY3Q](#) [K30PTAMGRY3Q](#) [K30PTALRGB7Q](#) [K30PTAMRGB7Q](#) [K50APPBGRYF2Q8](#)  
[K50BCLXRXPQ](#) [K50BCLS1XYXPQ](#) [K50BCLGRBP](#) [K50BCLXGXP](#) [K50BCLS1XRXPQ](#) [K50BLGRXPQ](#) [K50LGRYPPB2](#)  
[K50LGXXPPB2Q](#) [K50LGRXPPB2Q](#) [K50LBXXPPB2Q](#) [K50LGYXPPB2Q](#) [K50PBLSQ](#) [K50PBLRGB7Q](#) [K50PFF100AMGRY3Q](#)  
[K50PTAMGRY3](#) [K50PTAMGRY3AQP](#) [K50PTKAQ](#) [K50PTAMGRY3AQ](#) [K50PTAMRGB7AQ](#) [K50PTCAMGRY3AQ](#)  
[K50PTCAMGRY3Q-812166](#) [K50PTCAMGRY3Q](#)