

Datasheet

Momentary Action Optical Touch Buttons

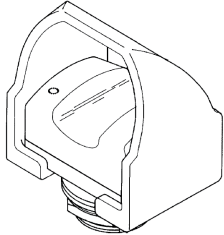

- Zero-force touch-activated photoelectric replacements for mechanical push buttons
- Momentary-action touch buttons with SPDT electromechanical relay or solid-state outputs
- Optimized for easy mounting with a 30 mm threaded base
- Ergonomic design eliminates hand, wrist and arm stress
- Field covers included to prevent inadvertent activation from loose clothing, debris, etc.

Banner Optical Touch Buttons are manufactured and sold under license for U. S Patent #4,939,358.



WARNING: Banner OPTO-TOUCH® OTB and OTBL Series Optical Touch Buttons are intended as general-purpose initiators, and are not safety devices. Like most solid-state devices, they are as equally likely to fail in the conducting (on) state as in the non-conducting (off) state. If OPTO-TOUCH Optical Touch Buttons are used to initiate machines or operations in which false operation of an Optical Touch Button could be dangerous, point-of-operation guarding devices or related safety controls must be installed and maintained to meet all appropriate OSHA regulations and ANSI B11 machine safety standards.

Models

Model ¹	Voltage	Output	Connection ²
OTBVN6	10 to 30 V dc	Complementary NPN (sinking) outputs	6-foot attached cable
OTBVN6QD			4-pin quick-disconnect
OTBVP6		Complementary PNP (sourcing) outputs	6-foot attached cable
OTBVP6QD			4-pin quick-disconnect
OTBA5	120 V ac	SPDT electromechanical relay output	6-foot attached cable
OTBA5QD			5-pin quick-disconnect
OTBB5	220/240 V ac		6-foot attached cable
OTBB5QD			5-pin quick-disconnect
OTBVR81	20 to 30 V ac or dc ³		6-foot attached cable
OTBVR81QD			5-pin quick-disconnect

Overview

Banner Optical Touch Buttons are touch-activated photoelectric switches designed to replace capacitive touch switches and mechanical push buttons. The OPTO-TOUCH's SPDT electromechanical relay or solid-state output (depending upon model) is activated for as long as a finger, introduced into the "touch area" (yoke) of the switch, interrupts the OPTO-TOUCH's infrared sensing beam.

Banner Optical Touch Buttons are ergonomically designed to eliminate the hand, wrist, and arm stresses associated with mechanical push buttons. They require absolutely no physical pressure to operate. LED indicators light for "power on" and "output activated".

All models are highly resistant to EMI, RFI, and ambient light interference. OTBs have either a black polysulfone (or red polycarbonate) upper housing and fiber-reinforced thermoplastic polyester base. Polycarbonate models have the letter "L" in their model number suffix. Environmental considerations for use of the two types differ; see specifications below. The 30-mm threaded base on all models provides easy mounting, and Banner Optical Touch Buttons are easily retrofitted to existing machines.

¹ To order a model with polycarbonate upper housing (others are polysulfone), added suffix "L" to the model number. For example, OTBVN6L.

² Models with a quick disconnect require a mating cordset.

³ 20 to 30 V dc power may be applied without regard to polarity.



Important Application Information



Safety Instruction: A field cover is supplied with this OPTO-TOUCH. Install the cover, as shown in the drawing page 1, to minimize the possibility of unintended switch operation. If this cover is missing or has become lost or damaged, contact Banner Engineering immediately for a no-charge replacement.

Use of OPTO-TOUCH Optical Touch Buttons for Two-hand Machine Trip Controls

Requirements for Anti-Tiedown Circuitry

Two-hand trip control has been a popular means for actuation of single-stroke presses and other single-cycle machinery for many years. Optical touch buttons (OTBs) provide an ergonomic (stress-free) alternative to conventional mechanical push buttons used as actuators in two-hand trip controls.

OSHA Requirement for Anti-Tiedown Control

Use of OTBs for two-hand trip machine actuation must include "anti-tiedown" control to prevent any means of defeating one or both actuators to create a one-hand trip. Federal law mandates the use of anti-tiedown control when two-hand trip actuators are used for cycle initiation of a single stroke part revolution clutched mechanical power press. OSHA Code of Federal Regulation, 7-1-92 Edition, CFR Title 29, Part 1910.217 (b) (6) (i) states:

"A two-hand trip shall have the individual operator's hand controls protected against unintentional operation and have the individual operator's hand controls arranged by design and construction and/or separation to require the use of both hands to trip the press and use a control arrangement requiring concurrent operation of the individual operator's hand controls."

Concurrent or "synchronous" actuation of two-hand trips is the most popular approach to anti-tiedown control. European Standard prEN 574, titled "Safety of Machinery - Two-handed Control Device", defines synchronous actuation as follows:

"6.7 Synchronous actuations

In synchronous actuation an output signal shall be generated only when both control actuating devices are actuated - in a time which is less than or equal to 0.5 seconds...

... If the control actuating devices are not actuated synchronously the output signal shall be prevented and it shall be necessary to release both control actuating devices and to reinitiate both input signals."

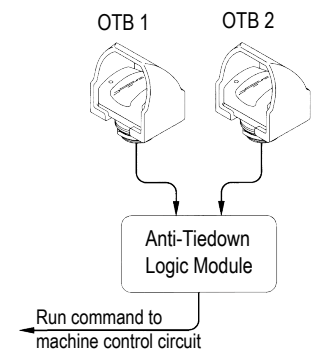

WARNING: In the United States, the functions that a two-hand control device is intended to perform are regulated by the Occupational Safety and Health Administration (OSHA). Whether or not any particular two-hand control system installation meets all applicable OSHA requirements depends upon the details of how the two-hand control device is applied, installed, operated, and maintained.



WARNING: Point-of-Operation Guarding

When properly installed, a two-hand control device provides protection only for the hands of the machine operator. It may be necessary to install **additional** safeguarding, such as safety light screens, additional two-hand controls, and/or hard guards, to protect all individuals from hazardous machinery.

Failure to properly guard hazardous machinery can result in a dangerous **condition** which could lead to serious injury or death.



WARNING: Never use an OPTO-TOUCH Optical Touch Button as an actuator in an emergency stop (E-Stop) circuit. E-Stop actuators must be purely mechanical devices that require no power to operate. OPTOTOUCH Optical Touch Buttons require power to operate and must not be used as E-Stop actuators under any circumstances.



Note: In addition to the standards and regulations mentioned in this section, there are numerous regulations and machine safety standards that apply to specific industries. For assistance in obtaining copies of any of these standards, contact Banner Engineering.

Prevention of False Actuation

Any anti-tiedown control must be designed to prevent accidental actuation. Anti-tiedown circuitry must be designed to ignore false input signals. False signals include (but are not limited to) voltage transients, contact bounce, and EMI or RFI noise. If a PLC or any other solid-state controller is used to provide anti-tiedown, the design must assure that short duration signals (typically any signals less than a few milliseconds) are ignored. There are several manufacturers of anti-tiedown logic modules which include circuitry to minimize the possibility of false actuation.

Definitions:

Two-hand trip (control)

A control that requires the operation of two separate control actuating devices by a machine operator's hands for initiation of a machine cycle.

Anti-tiedown (control)

A two-hand trip control configured so that both of the operator's hands must be removed and then reapplied to the control actuating devices to start another machine cycle. Also called anti-defeat control.

Wiring Diagrams

NPN Models

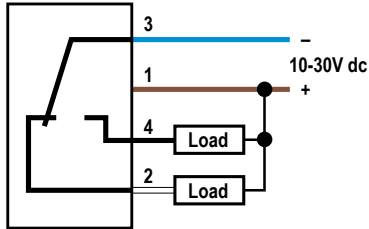

PNP Models

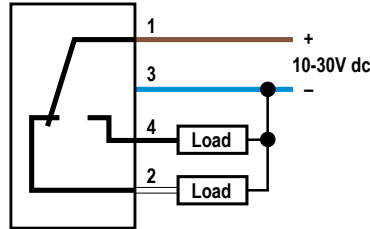

Key

- 1 = Brown
- 2 = White
- 3 = Blue
- 4 = Black

AC and AC/DC Models

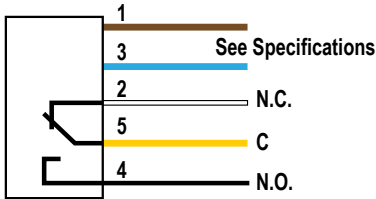

Voltage Specifications

OTBA5 models: 105 V ac to 130 V ac

OTBB5 models: 210 V ac to 250 V ac

OTBVR81 models: 20 V ac/dc to 30 V ac/dc



Note: For OTBVR81 Models, connection of dc power is without regard to polarity.

Key

- 1 = Brown
- 2 = White
- 3 = Blue
- 4 = Black
- 5 = Yellow

Specifications

Supply Voltage

- Supply voltage varies, depending on the model ordered:
 - 105 V ac to 130 V ac
 - 210 V ac to 250 V ac (50/60Hz)
 - 10 V dc to 30 V dc
 - 20 V ac/dc to 30 V ac/dc (at 25 mA, exclusive of load)

Supply Protection Circuitry

Protected against reverse polarity and transient voltages

Output Protection

100 ms delay on power-up; outputs do not conduct at this time
 Models with solid-state outputs are protected against false pulse on power-up and continuous overload or short circuit of outputs

Output Configuration:

- AC and ac/dc models: All models have SPDT electromechanical relay (one N.O. contact, one N.C. contact)
- DC-only models:
 - OTBVN6 models have complementary NPN sinking outputs
 - OTBVP6 models have complementary PNP sourcing outputs

Indicator LEDs

Two indicator LEDs. One lights whenever power is applied; the other lights whenever the switch is activated

Ambient Light Immunity

120,000 lux (direct sunlight)

EMI/RFI Immunity

Highly resistant to both single and mixed EMI and RFI noise sources

Response Time

100 ms ON/OFF

Cable

AC and ac/dc Quick-disconnect (QD) models require a MBCC-512 5-conductor cable (purchased separately).
 DC-only Quick-disconnect (QD) models require model MBCC-412 4-conductor mini-style cable
 Models with attached cable (non-QD models): 2 m (6 ft) PVC-jacketed, 22 AWG 4- or 5-conductor cable

Output Rating:

- AC and ac/dc models:
 - Maximum voltage is 250 V ac or 30 V dc
 - Maximum current is 7 amps (resistive load), 1 HP maximum
 - Minimum load is .05 watts (dc), .05VA (ac)
 - Mechanical life of relay is 50,000,000 operations (minimum)
 - Electrical life of relay is 100,000 operations (minimum) at full resistive load
 - Transient suppression recommended when switching inductive loads
- DC models:
 - 150 mA maximum load (each output)
 - ON-state saturation voltage: less than 1 V at 10 mA; less than 1.5 V at 150 mA
 - OFF-state leakage current: less than 1 µA

Operating Temperature

-20 °C to +50 °C (-4 °F to +122 °F)
 90% at +50 °C maximum relative humidity (non-condensing)

Environmental Considerations

Models with polysulfone housing): Prolonged exposure to direct outdoor sunlight causes embrittlement of the polysulfone housing. Window glass effectively filters longer wavelength ultraviolet and provides excellent protection from sunlight. Contact Banner Engineering regarding outdoor applications.

Models with polycarbonate housing: Avoid prolonged exposure to hot water and moist high-temperature environments above 66 °C (150 °F). Avoid aromatic hydrocarbons (such as xylene and toluene), halogenated hydrocarbons, and strong alkalis. Clean periodically using mild soap solution and a soft cloth. Avoid strong alkaline materials.

Construction

Black polysulfone (or red polycarbonate) upper housing and fiber-reinforced thermoplastic polyester base. Electronics fully epoxy-encapsulated. Totally encapsulated, non-metallic enclosure. Threaded base has M30 x 1.5 external threads and 1/2-in NPSM internal threads. Base requires a 1-3/16-in diameter mounting hole (fits most standard automotive- size jumbo legend plates and oiltight pushbutton holes).

Field cover: Polypropylene copolymer (supplied)

Certifications

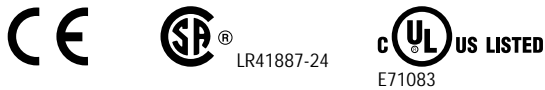

Environmental Rating

NEMA 1, 3, 4, 4X, 12, and 13; IEC IP66

Required Overcurrent Protection



WARNING: Electrical connections must be made by qualified personnel in accordance with local and national electrical codes and regulations.

Overcurrent protection is required to be provided by end product application per the supplied table.

Overcurrent protection may be provided with external fusing or via Current Limiting, Class 2 Power Supply.

Supply wiring leads < 24 AWG shall not be spliced.

For additional product support, go to www.bannerengineering.com.

Supply Wiring (AWG)	Required Overcurrent Protection (Amps)
20	5.0
22	3.0
24	2.0
26	1.0
28	0.8
30	0.5

Dimensions

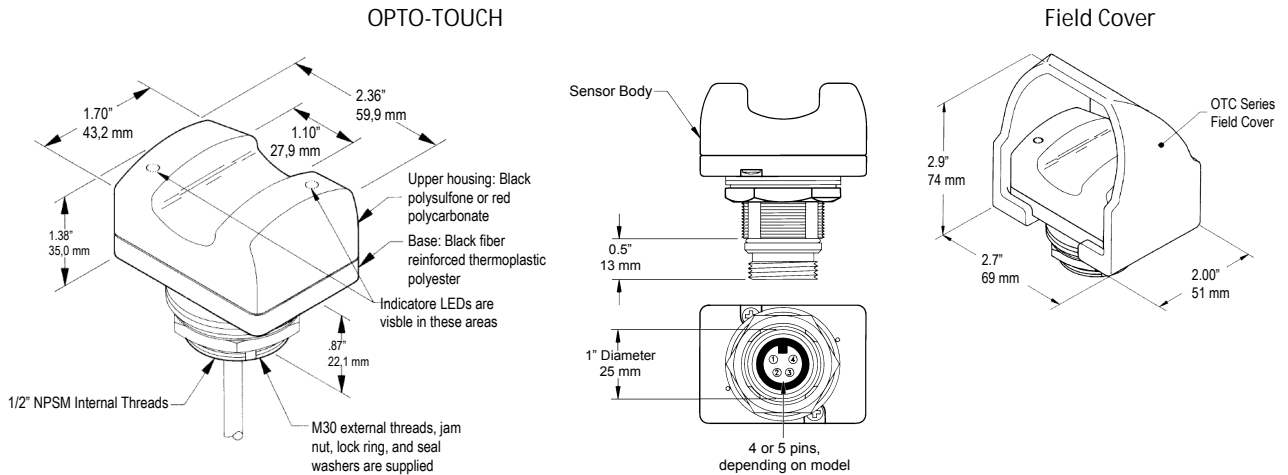

Accessories

Cordsets: dc-only models

4-Pin Mini-Style Cordsets				
Model	Length	Style	Dimensions	Pinout (Female)
MBCC-406	1.83 m (6 ft)	Straight		<p>1 = Brown 2 = White 3 = Blue 4 = Black</p>
MBCC-412	3.66 m (12 ft)			
MBCC-430	9.14 m (30 ft)			

Cordsets: ac and ac/dc models

5-Pin Mini-Style Cordsets				
Model	Length	Style	Dimensions	Pinout (Female)
MBCC-506	1.83 m (6 ft)	Straight		
MBCC-512	3.66 m (12 ft)			
MBCC-530	9.14 m (30 ft)			

Field Covers

OPTO-TOUCH Field Covers are designed to prevent inadvertent activation of OPTO-TOUCHS due to objects (loose clothing, debris, etc.) which might accidentally block the sensing beam.

Field covers are constructed of rugged Polypropylene copolymer, which is capable of absorbing high impacts (even at low temperatures). This material is highly resistant to abrasion and to damage by most chemicals.

Every OPTO-TOUCH is supplied with a black field cover, as standard. Field covers are available separately in four colors, which can be used to differentiate touch button functions when several touch buttons are in use.

Model	Color
OTC-1-BK	Black (supplied)
OTC-1-RD	Red
OTC-1-YW	Yellow
OTC-1-GN	Green

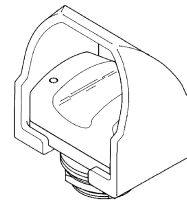

Swivel-Mount Bracket

SMB30S

- Swivel bracket with 30 mm mounting hole for sensor
- Adjustable captive swivel ball
- Black reinforced thermoplastic polyester
- Stainless steel mounting and swivel locking hardware included

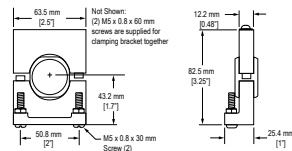

Ordering Information

OPTO-TOUCH Optical Touch Buttons are shipped with a black field cover. A black field cover will be received if the OPTO-TOUCH is ordered by its model number (only). A red, yellow, or green field cover may be specified instead by ordering the OPTO-TOUCH using the appropriate 5-digit part number from the table. Field covers may also be ordered separately.

Model	Black Cover	Red Cover	Yellow Cover	Green Cover
OTBA5	27986	35058	35078	35098
OTBB5	27987	35062	35082	35102
OTBVR81	33080	35066	35086	35106
OTBVN6	28591	35070	35090	35110
OTBVP6	28589	35074	35094	35114
OTBA5QD	28149	35059	35079	35099
OTBB5QD	28150	35063	35083	35103

Model	Black Cover	Red Cover	Yellow Cover	Green Cover
OTBVR81QD	34078	35067	35087	35107
OTBVN6QD	28585	35071	35091	35111
OTBVP6QD	28590	35075	35095	35115
OTBA5L	32167	35060	35080	35100
OTBB5L	32254	35064	35084	35104
OTBVR81L	34040	35068	35088	35108
OTBVN6L	33706	35072	35092	35112
OTBVP6L	34110	35076	35096	35116
OTBA5LQD	32255	35061	35081	35101
OTBB5LQD	32256	35065	35085	35105
OTBVR81LQD	34041	35069	35089	35109
OTBVN6LQD	35057	35073	35093	35113
OTBVP6LQD	34997	35077	35097	35117



Note: Banner Optical Touch Buttons are manufactured and sold under license for U. S Patent #4,939,358.

Banner Engineering Corp. Limited Warranty

Banner Engineering Corp. warrants its products to be free from defects in material and workmanship for one year following the date of shipment. Banner Engineering Corp. will repair or replace, free of charge, any product of its manufacture which, at the time it is returned to the factory, is found to have been defective during the warranty period. This warranty does not cover damage or liability for misuse, abuse, or the improper application or installation of the Banner product.

THIS LIMITED WARRANTY IS EXCLUSIVE AND IN LIEU OF ALL OTHER WARRANTIES WHETHER EXPRESS OR IMPLIED (INCLUDING, WITHOUT LIMITATION, ANY WARRANTY OF MERCHANTABILITY OR FITNESS FOR A PARTICULAR PURPOSE), AND WHETHER ARISING UNDER COURSE OF PERFORMANCE, COURSE OF DEALING OR TRADE USAGE.

This Warranty is exclusive and limited to repair or, at the discretion of Banner Engineering Corp., replacement. IN NO EVENT SHALL BANNER ENGINEERING CORP. BE LIABLE TO BUYER OR ANY OTHER PERSON OR ENTITY FOR ANY EXTRA COSTS, EXPENSES, LOSSES, LOSS OF PROFITS, OR ANY INCIDENTAL, CONSEQUENTIAL OR SPECIAL DAMAGES RESULTING FROM ANY PRODUCT DEFECT OR FROM THE USE OR INABILITY TO USE THE PRODUCT, WHETHER ARISING IN CONTRACT OR WARRANTY, STATUTE, TORT, STRICT LIABILITY, NEGLIGENCE, OR OTHERWISE.

Banner Engineering Corp. reserves the right to change, modify or improve the design of the product without assuming any obligations or liabilities relating to any product previously manufactured by Banner Engineering Corp. Any misuse, abuse, or improper application or installation of this product or use of the product for personal protection applications when the product is identified as not intended for such purposes will void the product warranty. Any modifications to this product without prior express approval by Banner Engineering Corp will void the product warranties. All specifications published in this document are subject to change; Banner reserves the right to modify product specifications or update documentation at any time. Specifications and product information in English supersede that which is provided in any other language. For the most recent version of any documentation, refer to:

www.bannerengineering.com.

X-ON Electronics

Largest Supplier of Electrical and Electronic Components

Click to view similar products for [banner manufacturer](#):

Other Similar products are found below :

[Q45VR2FPQ](#) [BTA23S](#) [RS-11](#) [L16F](#) [2LM3](#) [2PBA](#) [LM8-1](#) [LMT](#) [SM312CV](#) [SM31RQD](#) [LS4ELQ](#) [FX1](#) [Q45BB6LLQ](#) [QM42VP6AFV150Q](#)
[D12SP6FP](#) [MBCC-412](#) [BA23S](#) [BT21S](#) [BTA13S](#) [LM4-2](#) [QS18VN6LP](#) [ES-FA-6G](#) [T183E](#) [SLSP30-600Q88](#) [SLSP30-1200Q88](#)
[OTBVN6QD](#) [OPBA5](#) [PBAT](#) [SBLV1](#) [SMA91EQD](#) [SMA91E](#) [SMA912LVQD](#) [SMA912DQD](#) [SM2A312CVQD](#) [SM2A912LVQD](#)
[SM312FP1H](#) [SM31RL](#) [TL70RAQ](#) [TL70RQ](#) [K50LGRYPQ](#) [BRT-THG-4X4-5](#) [T18-2VNDL-Q8](#) [SLLP14-1190P88](#) [SME312DQD](#)
[SM312CUQD](#) [BR-2](#) [BR23P](#) [SM2A312FPQD](#) [SM2A312LVQD](#) [SM31EQD](#)