

## Instruction Manual

### 30 mm Panel Mount Electro-Mechanical Push Buttons

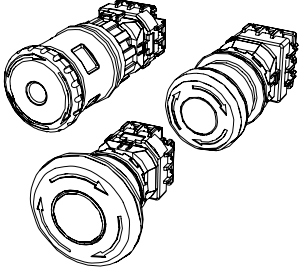

- Four styles of actuators: standard, illuminated, lockable, and illuminated lockable
- Push-to-stop, twist-to-release (standard and lockable), or pull-to-release (standard) operation per IEC 60947-5-5
- Latching design complies with ISO 13850; direct (positive) opening operation per EN 60947-5-1
- Compliant with ANSI B11.19, NFPA 79, and IEC/EN 60204-1 Emergency Stop requirements
- "Safe Break Action" ensures normally closed (NC) contacts will open if the contact block is separated from the actuator
- Panel mount though 30 mm mounting hole
- "Emergency Stop" legend optional

**SSA-EB...** series models are "mushroom-style" electro-mechanical emergency stop push buttons. These buttons mount through a 30 mm hole in an enclosure. When the button is armed, the switch's safety contacts (normally closed/NC) are closed and its monitoring contacts (normally open/NO), if present, are open. When the button is pushed, the switch's safety contacts open, and the monitoring contacts close. The contacts remain in this condition until they are manual rearmed.

The standard 40 mm and 60 mm actuators can be rearmed by pulling or twisting clockwise the red actuator. The lockable 44 mm actuator can be rearmed only by twisting the actuator clockwise. Do not pull the actuator while twisting or the switch may be damaged, causing a malfunction or operational failure. The illuminated models provide a red indication within the face of the button that allows for easy identification of a pushed/actuated button.

SSA-EB1M... series padlock-style lockable emergency stop push buttons are intended to prevent unauthorized or accidental resetting of a pushed/latched button. The SSA-EB1M... series are not to be used as an energy isolating device or as the sole means of complying with Lockout/Tagout or with the requirements of the isolation of hazardous energy (see OSHA 29CFR1910.147, ANSI Z244.1, CSA Z460, ISO 14118). The locking feature can be used to provide supervisory/personal control and provide an additional safety measure(s) to reduce the likelihood of inadvertent arming and energization of the emergency stop circuit.

## Models

### Non-illuminated models

Standard 40 mm	Standard 60 mm	Lockable 44 mm	Safety Contacts	Monitor Contacts
SSA-EB1P-02	SSA-EB2P-02	SSA-EB1MP-02	2 normally closed (NC)	
SSA-EB1P-04	SSA-EB2P-04	SSA-EB1MP-04	4 normally closed (NC)	
SSA-EB1P-11	SSA-EB2P-11	SSA-EB1MP-11	1 normally closed (NC)	1 normally open (NO)
SSA-EB1P-13	SSA-EB2P-13	SSA-EB1MP-13	3 normally closed (NC)	1 normally open (NO)
SSA-EB1P-22	SSA-EB2P-22	SSA-EB1MP-22	2 normally closed (NC)	2 normally open (NO)

### Illuminated models

Standard 40 mm	Lockable 44 mm	LED	Safety Contacts	Monitor Contacts
SSA-EB1PL1-02	SSA-EB1ML1P-02	Per wiring connection	2 normally closed (NC)	
SSA-EB1PL1-04	SSA-EB1ML1P-04	Per wiring connection	4 normally closed (NC)	
SSA-EB1PL1-11	SSA-EB1ML1P-11	Per wiring connection	1 normally closed (NC)	1 normally open (NO)
SSA-EB1PL1-13	SSA-EB1ML1P-13	Per wiring connection	3 normally closed (NC)	1 normally open (NO)
SSA-EB1PL1-22	SSA-EB1ML1P-22	Per wiring connection	2 normally closed (NC)	2 normally open (NO)
SSA-EB1PL2-12	SSA-EB1ML2P-12	PUSH ON	2 normally closed (NC)	1 normally open (NO)

ISD Connect—All models with 2 normally closed (NC) contacts can be used with Banner's **SSA-ISD-TCA** by using an **MQDMC-5xx(RA)** series cable.

## Important... Read this before proceeding!

**The user is responsible for satisfying all local, state, and national laws, rules, codes, and regulations** relating to the use of this product and its application. Banner Engineering Corp. has made every effort to provide complete application, installation, operation, and maintenance instructions. Please contact a Banner Applications Engineer with any questions regarding this product.

**The user is responsible** for making sure that all machine operators, maintenance personnel, electricians, and supervisors are thoroughly familiar with and understand all instructions regarding the installation, maintenance, and use of this product, and with the machinery it controls. The user and any personnel involved with the installation and use of this product must be thoroughly familiar with all applicable standards, some of which are listed within the specifications. Banner Engineering Corp. makes no claim regarding a specific recommendation of any organization, the accuracy or effectiveness of any information provided, or the appropriateness of the provided information for a specific application.

**WARNING:**

- **Not a safeguarding device**
- Failure to follow these instructions could result in serious injury or death.
- This device is not considered a safeguarding device because it requires an overt action by an individual to stop machine motion or hazards. A safeguarding device limits or eliminates an individual's exposure to a hazard without action by the individual or others. This device cannot be substituted for required safeguarding. Refer to the applicable standards to determine those requirements.

## Emergency Stop Considerations

---

NFPA 79, ANSI B11.19, IEC/EN 60204-1, and ISO 13850 specify emergency stop requirements, including the following:

- Emergency-stop push buttons shall be located at each operator control station and at other operating stations where emergency shutdown is required.
- Stop and emergency-stop push buttons shall be continuously operable and readily accessible from all control and operating stations where located. Do not mute or bypass E-stop buttons.
- Actuators of emergency-stop devices shall be colored red. The background immediately around the device actuator shall be colored yellow (where possible). The actuator of a push-button-operated device shall be of the palm or mushroom-head type.
- The emergency-stop actuator shall be a self-latching type.

**WARNING:**

- **Do not mute or bypass any emergency stop device**
- Muting or bypassing the safety outputs renders the emergency stop function ineffective.
- ANSI B11.19, NFPA 79 and IEC/EN 60204-1 require that the emergency stop function remains active at all times.

**WARNING:**

- **Connect two or more devices to the same safety module (controller) in series**
- Connecting devices in parallel defeats the switch contact monitoring ability of the module and creates an unsafe condition that could result in serious injury or death.
- Failure to test each device individually in this manner could result in undetected faults and create an unsafe condition that could result in serious injury or death.
- Connect the contacts of the corresponding pole of each switch in series. Never connect the contacts of multiple switches in parallel. Individually actuate (engage) each device, then release (or re-arm) and reset the safety module. This allows the module to check each switch and its wiring to detect faults. Perform this check during the prescribed checkouts.

## Installation and Maintenance

---

The device must not be affected by environmental conditions. **Install the device so that operation is not impeded, but should be protected against inadvertent operation** (for example, accidental actuation by being bumped or leaned against). Do not operate the switch using a tool. Do not expose the switch to excessive shocks and vibrations, otherwise the switch may be deformed or damaged, causing malfunction or operation failure. See "[Dimensions](#)" on [page 8](#).

Electrical installation must be made by qualified personnel<sup>(1)</sup> and must comply with NEC (National Electrical Code), NFPA 79 or IEC/EN 60204-1, and all applicable local standards. It is not possible to give exact wiring instructions for a device that interfaces to a multitude of machine control configurations. The following is general in nature; it is recommended to perform a risk assessment to ensure appropriate application, interfacing/hookup, and risk reduction (see ISO 12100 or ANSI B11.0).

For SSA-EB1M... series padlock-style lockable emergency stop push buttons, make sure that an applicable padlock and hasp is used. The total weight of the padlock and hasp must not exceed 1500 g (3.3 lbs) or the switch may malfunction or fail.

## Removing and Installing the Contact Block and Panel Mounting

For more information, please refer to the training video at <https://www.youtube.com/watch?v=FjFR6d4JrA>.

<sup>(1)</sup> A Qualified Person possesses a recognized degree or certificate or has extensive knowledge, training, and experience to solve problems relating to the emergency stop installation.

## Remove the Contact Block

1. Arm (reset) the actuator (button). Do not attempt to remove the contact block while the actuator is latched (pushed), or the switch may be damaged.
2. Grip the beveled surfaces at the corners of the yellow bayonet ring and pull the ring toward the contact block until the latch pin clicks.

If the switch is not installed, place the contact block against the base of the index finger and grip the bayonet ring with the thumb, index finger, and middle finger, then squeeze until the click is heard.

3. Rotate the contact block counterclockwise and pull out to remove the contact block. Do not use excessive force when removing the contact block, or the switch may be damaged.

For illuminated pushbuttons, the LED lamp is built into the contact block. When removing the contact block, pull the contact block straight to prevent damage to the LED lamp. Do not use excessive force or the LED lamp may be damaged and fail to light.

When the contact block is removed, the monitor contact (normally open contact) is closed.

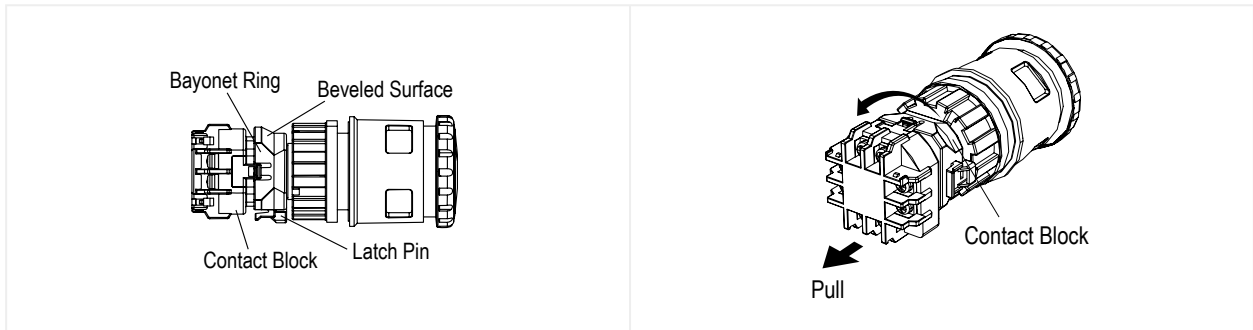

## Panel Mounting

1. Remove the contact block and the M30 jam nut from the actuator and verify that the rubber gasket is in place.
2. Align the anti-rotation key on the bezel with the keyway (notch) in the panel.
3. Insert the actuator into the hole from the front of the panel, and tighten the M30 jam nut using wrench **SSA-EB1-LRW** or **SSA-EB1-LRTW** to a maximum torque of 2.5 N•m (1.8 ft-lbs).

### NOTE:

- The allowable panel thickness is 1 mm to 5 mm for SSA-EB1P... and 1 mm to 6 mm for SSA-EB1M....
- Banner recommends that the anti-rotation key/keyway is placed at the top of the hole (0° versus 90° or 180°) so the word "TOP" on the contact block and actuator is on the top so that the terminal label is easier to read.
- If using ESLP1-30/60-.. Plastic Emergency Stop legend, remove the anti-rotation projection on the legend using pliers, and then install the legend onto the actuator before inserting it into the hole.

## Install the Contact Block

1. Arm (reset) the actuator (button). Do not attempt to install the contact block while the actuator is latched (pushed), or the switch may be damaged.
2. Align the small ▼ mark on the edge of the actuator with the small ▲ mark on the yellow bayonet ring. The contact block (TOP LOCK) should be turned approximately 45° counterclockwise from the anti-rotation key/keyway on the bezel.
3. Hold the black contact block (not the yellow bayonet ring), and slide the contact block onto the actuator. Push until the actuator is fully inserted into the contact block (the bayonet ring will compress and motion will stop).

**NOTE:** If not installed on a panel, press on the actuator's bezel (not the button).

4. Turn the contact block clockwise until the yellow bayonet ring pops into position and clicks. When properly seated, the contact block cannot be turned or pulled.

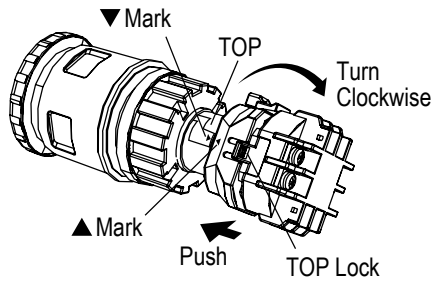

## Wiring Diagrams

Non-Illuminated	Contacts	Wiring	Illuminated	Contacts	Wiring
SSA-EB1P-02 SSA-EB1MP-02	2 normally closed (NC)		SSA-EB1PL1-02 SSA-EB1ML1P-02	2 normally closed (NC)	
SSA-EB1P-04 SSA-EB1MP-04	4 normally closed (NC)		SSA-EB1PL1-04 SSA-EB1ML1P-04	4 normally closed (NC)	
SSA-EB1P-11 SSA-EB1MP-11	1 normally closed (NC) / 1 normally open (NO)		SSA-EB1PL1-11 SSA-EB1ML1P-11	1 normally closed (NC) / 1 normally open (NO)	
SSA-EB1P-13 SSA-EB1MP-13	3 normally closed (NC) / 1 normally open (NO)		SSA-EB1PL1-13 SSA-EB1ML1P-13	3 normally closed (NC) / 1 normally open (NO)	
SSA-EB1P-22 SSA-EB1MP-22	2 normally closed (NC) / 2 normally open (NO)		SSA-EB1PL1-22 SSA-EB1ML1P-22	2 normally closed (NC) / 2 normally open (NO)	
			SSA-EB1PL2-12 SSA-EB1ML2P-12 (Push ON LED)	2 normally closed (NC) / 1 normally open (NO)	

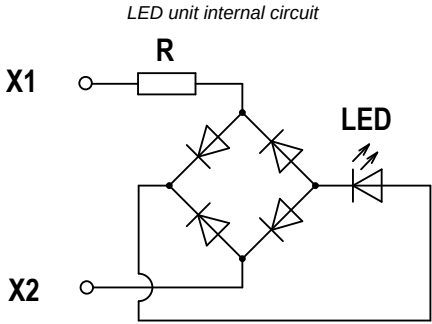

Applicable Crimping Terminal

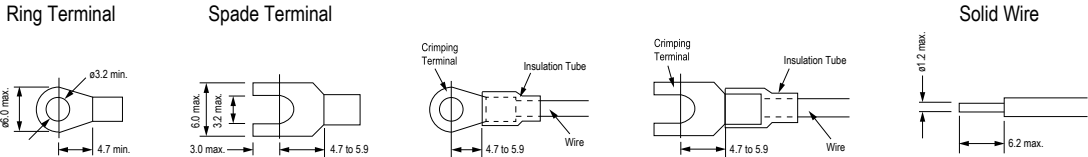

Banner recommends the use of crimp terminals with stranded wire or solid core wire to prevent short circuits between terminals. Ensure that the insulation tube is installed on crimp terminals.

## Installing and Removing the Terminal Cover

### Install the SSA-EB1-TC Terminal Cover

1. Align the TOP mark on the SSA-EB1-TC terminal cover with the TOP mark on the contact block.
2. Place the two projections on the bottom of the contact block into the slots in the SSA-EB1-TC terminal cover.

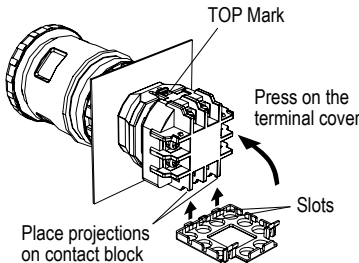

3. Press the SSA-EB1-TC terminal cover toward the contact block.

### Remove the SSA-EB1-TC Terminal Cover

1. Pull out the two latches on the top of the SSA-EB1-TC terminal cover. Do not exert excessive force on the latches, or the latches may break.

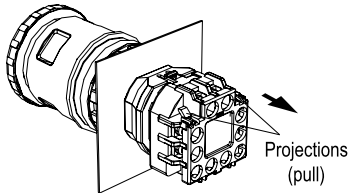

2. Remove the SSA-EB1-TC terminal cover.

### Install the IP20 Fingersafe SSA-EB1-FSTC Terminal Cover

The SSA-EB1-FSTC terminal covers cannot be installed after wiring. After installation, the SSA-EB1-FSTC terminal cover cannot be removed.

With the SSA-EB1-FSTC terminal cover installed, crimping terminals cannot be used. Use solid wires.

Make sure that the SSA-EB1-FSTC terminal cover is securely installed. IP20 cannot be achieved when installed loosely, and electric shocks may occur.

**WARNING:**



- **Risk of electric shock**
- Use extreme caution to avoid electrical shock. Serious injury or death could result.
- Always disconnect power from the safety system (for example, device, module, interfacing, etc.), guarded machine, and/or the machine being controlled before making any connections or replacing any component. Lockout/tagout procedures might be required. Refer to OSHA 29CFR1910.147, ANSI Z244-1, or the applicable standard for controlling hazardous energy.
- Make no more connections to the device or system than are described in this manual. Electrical installation and wiring must be made by a Qualified Person<sup>(1)</sup> and must comply with the applicable electrical standards and wiring codes, such as the NEC (National Electrical Code), NFPA 79, or IEC 60204-1, and all applicable local standards and codes.

1. Align the TOP mark on the cover with the TOP mark on the contact block.
2. Press the cover toward the contact block.

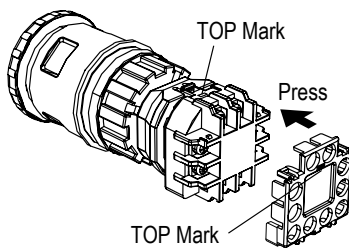

## Checkout

At machine set up, a *Designated Person*<sup>(2)</sup> should test each safety point for proper machine shutdown response. A *Designated Person* should check the safety point for proper operation, physical damage, button looseness, and excessive environmental contamination. This should take place on a periodic schedule determined by the user, based on the severity of the operating environment and the frequency of switch actuations.

Adjust, repair, or replace components as needed. If inspection reveals contamination on the switch, thoroughly clean the switch and eliminate the cause of the contamination. Replace the switch and/or appropriate components when any parts or assemblies are damaged, broken, deformed, or badly worn; or if the electrical/mechanical specifications (for the environment and operating conditions) have been exceeded.

**Always test the control system for proper functioning** under machine control conditions after performing maintenance, replacing the safety point, or replacing any component of the device.

## Specifications

**Button/Locking Collar**

Polyamide/Aluminum

**Insulation Resistance**

100 MΩ minimum (500 V DC megger)

**Rated Current (Ith)**

5A

**Impulse Withstand Voltage**

2.5 kV

**Pollution Degree**

3

**Overvoltage Category**

II

**Vibration Resistance**

Operating extremes: 10 Hz to 500 Hz, amplitude 0.35 mm acceleration 50 m/s<sup>2</sup>

**Shock Resistance**

Operating extremes: 150 m/s<sup>2</sup> (15G)

**Direct Opening**

Force: 80 N Minimum  
Travel: 4.0 mm Minimum

**Button Travel**

4.5 mm Maximum

**Contact Resistance**

50 mΩ maximum (initial value)

**Electrical Life**

100,000 operations minimum, 250,000 operations minimum at 24 V AC/DC, 100 mA

<sup>(1)</sup> A person who, by possession of a recognized degree or certificate of professional training, or who, by extensive knowledge, training and experience, has successfully demonstrated the ability to solve problems relating to the subject matter and work.

<sup>(2)</sup> A *Designated Person* is identified in writing by the employer as being appropriately trained to perform a specified checkout procedure. A Qualified Person possesses a recognized degree or certificate or has extensive knowledge, training, and experience to solve problems relating to the emergency stop installation.

**Output Configuration**

See "Installation and Maintenance" on page 2

**Mechanical Life**

250,000 operations

**Operating Temperature**

Non-illuminated: -25 °C to +60 °C (-13 °F to +140 °F)  
 Illuminated: -25 °C to +55 °C (-13 °F to +131 °F)

**Environmental Rating**

Actuator: IP65 (IEC 60529)  
 Terminal: IP20 with SSA-EB1-FSTC installed

**Operating Frequency**

900 operations/hour

**LED Color**

Red (The LED is built into the contact block and cannot be replaced)

**LED Voltage/Typical Current**

24 V AC/DC ±10%, 5 mA (units with date codes before 2301S have a typical current draw of 15 mA)

**Total Weight of Padlock and Hasp (SSA-EB1M... only)**

1500 g (3.3 lb) maximum

**Rated Insulation Voltage (UI)**

250 V

**Operating Humidity**

45% to 85% RH (no condensation)

**Contact Material/Bounce<sup>(1)</sup>**

Gold plated silver / 20 ms

**Electrical Rating**

Minimum load: 1 mA at 5 V AC/DC  
**Maximum Rated Load:** See table  
 UL Applications: 1.5 A at 250 V AC, 1 A at 30 V DC (pilot duty)  
 CE Applications: AC-15: 1.5 A at 250 V AC, DC-13: 1 A at 30 V DC

**Terminals**

M3 screw terminal (terminal cover included)  
 Recommended Torque: 0.6 to 1.0 N·m (5.3 to 8.8 in-lbf)  
 Allowable Wire: 0.75 to 1.25 mm<sup>2</sup> (18 to 16 AWG)

**B10d**





100,000 (based on ISO13849-1)

**Standards**

**Design and Compliance:** EN/IEC 60497-5-1, EN/IEC 60947-5-5, UL 508, CSA C22.2 No.14  
**Application and Other Applicable Standards (not all inclusive):** ISO 13850, ANSI B11.19, IEC 60204-1, NFPA79  
**Date code format (U.S. Standard Format)**  
 YYWWX: 2-digit year, 2-digit week, "X" internal code

<sup>(1)</sup> When the button is reset, the normally closed contacts will chatter. When pressing the button, the normally open contacts will chatter. When designing a control circuit, take the contact chatter time into consideration. Do not expose the switch to external shocks, otherwise the contacts will bounce.

**Certifications**

		
	Banner Engineering BV Park Lane   Culliganlaan 2F bus 3   1831 Diegem, BELGIUM	
	Turck Banner LTD Blenheim House   Blenheim Court   Wickford, Essex SS11 8YT   Great Britain	

**Rated Operating Voltage (Ue) and Current**

Safety Contact (N.C.)		30 V	125 V	250 V
AC 50/60 Hz	Resistive Load (AC-12)	-	5 A	3 A
	Inductive Load (AC-15)	-	3 A	1.5 A
DC	Resistive Load (DC-12)	2 A	0.4 A	0.2 A
	Inductive Load (DC-13)	1 A	0.22 A	0.1 A

Monitor Contacts (N.O.)		30 V	125 V	250 V
AC 50/60 Hz	Resistive Load (AC-12)	-	1.2 A	0.6 A
	Inductive Load (AC-14)	-	0.6 A	0.3 A
DC	Resistive Load (DC-12)	2 A	0.4 A	0.2 A
	Inductive Load (DC-13)	1 A	0.22 A	0.1 A

The operating current is classified according to EN 60947-5-1 making and breaking capacities and are measured at resistive/inductive load types specified in EN 60947-5-1. See "Electrical Rating" above for specific model and UL/CE maximum ratings.

**Required Overcurrent Protection**



**WARNING:** Electrical connections must be made by qualified personnel in accordance with local and national electrical codes and regulations.

Overcurrent protection is required to be provided by end product application per the supplied table.  
 Overcurrent protection may be provided with external fusing or via Current Limiting, Class 2 Power Supply.  
 Supply wiring leads < 24 AWG shall not be spliced.  
 For additional product support, go to [www.bannerengineering.com](http://www.bannerengineering.com).

Supply Wiring (AWG)	Required Overcurrent Protection (A)	Supply Wiring (AWG)	Required Overcurrent Protection (A)
20	5.0	26	1.0
22	3.0	28	0.8
24	1.0	30	0.5





Continued from page 8

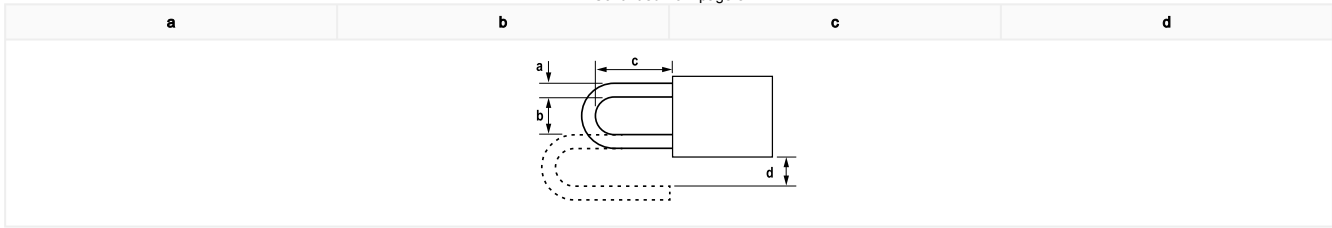

### Mounting Hole Layout

The values are the minimum dimensions for mounting with other  $\varnothing 30$  mm push buttons. For other control units of different sizes and styles, determine the values according to the dimensions, operation, and wiring convenience.

For padlock-style lockable emergency stop push buttons, determine the values according to the size and number of padlocks and hasp.

Mounting hole layout

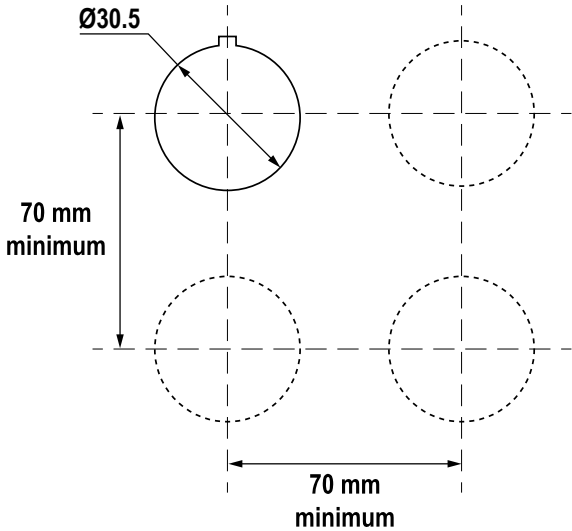



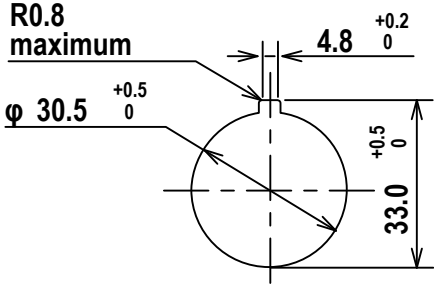

Notch dimensions

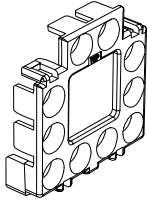
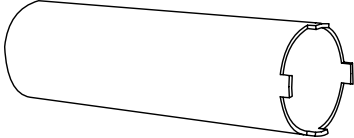
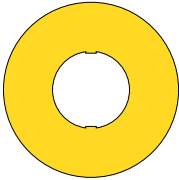

### Accessories

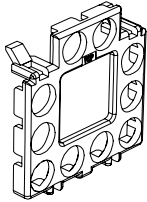
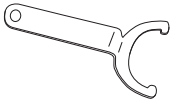
**NOTE:** Actuators and contact blocks (including LED indicators) are only available as complete units and are not sold separately.

<p><b>SSA-EB1-FSTC</b> IP20 Finger-safe terminal cover</p>	
<p><b>SSA-EB1-LRW</b> Jam nut wrench</p>	
<p><b>ESLP1-30/60-NW</b></p> <ul style="list-style-type: none"> <li>• E-Stop Legend, Plastic</li> <li>• Blank</li> <li>• 60 mm diameter (OD)</li> <li>• 30 mm hole</li> </ul>	
<p><b>ESL-41/60 (1 each)</b> <b>ESL-41/60-10 (10 each)</b></p> <ul style="list-style-type: none"> <li>• E-Stop Legend, Label</li> <li>• "Emergency Stop"</li> <li>• 60 mm diameter (OD)</li> <li>• 41 mm hole for application around SSA-EB1P...</li> </ul>	
<p><b>ESL-44/70 (1 each)</b> <b>ESL-44/70-10 (10 each)</b></p> <ul style="list-style-type: none"> <li>• E-Stop Legend, Label</li> <li>• "Emergency Stop"</li> <li>• 70 mm diameter (OD)</li> <li>• 44 mm hole for application around SSA-EB1M...</li> </ul>	
<p><b>SSA-EB1-TC</b> Standard terminal cover (supplied)</p>	
<p><b>SSA-EB1-LRTW</b> Jam nut twist wrench</p>	

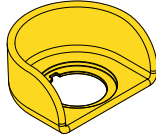
<p><b>ESLP1-30/60</b></p> <ul style="list-style-type: none"> <li>• E-Stop Legend, Plastic</li> <li>• "Emergency Stop"</li> <li>• 60 mm diameter (OD)</li> <li>• 30 mm hole</li> </ul>	
<p><b>ESL-41/60-ENES (1 each)</b></p> <p><b>ESL-41/60-ENES-10 (10 each)</b></p> <ul style="list-style-type: none"> <li>• E-Stop Legend, Label</li> <li>• "Emergency Stop - Parada de Emergencia"</li> <li>• 60 mm diameter (OD)</li> <li>• 41 mm hole for application around SSA-EB1P...</li> </ul>	
<p><b>ESC-1-YW</b></p> <ul style="list-style-type: none"> <li>• Emergency stop cover</li> <li>• 72 mm wide; 30 mm center hole</li> <li>• For use on standard (non-lockable) 40mm models</li> </ul>	

## US Application Standards

ANSI B11.0 Safety of Machinery, General Requirements, and Risk Assessment

ANSI B11.19 Performance Criteria for Safeguarding

NFPA 79 Electrical Standard for Industrial Machinery

## International/European Standards

EN ISO 12100 Safety of Machinery – General Principles for Design — Risk Assessment and Risk Reduction

ISO 13850 (EN 418) Emergency Stop Devices, Functional Aspects – Principles for Design

IEC 62061 Functional Safety of Safety-Related Electrical, Electronic and Programmable Control Systems

EN ISO 13849-1:2015 Safety-Related Parts of Control Systems

IEC/EN 60204-1 Electrical Equipment of Machines Part 1: General Requirements

EN 60947-1 Low Voltage Switchgear – General Rules

EN 60947-5-1 Low Voltage Switchgear – Electromechanical Control Circuit Devices

EN 60947-5-5 Low Voltage Switchgear – Electrical Emergency Stop Device with Mechanical Latching Function

## EU/UK Declaration of Conformity (DoC)

Banner Engineering Corp. herewith declares that these products are in conformity with the provisions of the listed directives and all essential health and safety requirements have been met. For the complete DoC, please go to [www.bannerengineering.com](http://www.bannerengineering.com).

Product	Directive
SSA-EB1P and PL Emergency Stop Push Button	EU: Machinery Directive 2006/42/EC; Low Voltage Directive 2014/35/EU
	UKCA: Machinery (Safety) Regulations 2008

Representative in EU: Spiros Lachandidis, Managing Director, **Banner Engineering BV** Park Lane | Culliganlaan 2F bus 3 | 1831 Diegem, BELGIUM

Representative in UK: Tony Coghlan, Managing Director, **Turck Banner LTD** Blenheim House | Blenheim Court | Wickford, Essex SS11 8YT | Great Britain

## Banner Engineering Corp. Limited Warranty

---

Banner Engineering Corp. warrants its products to be free from defects in material and workmanship for one year following the date of shipment. Banner Engineering Corp. will repair or replace, free of charge, any product of its manufacture which, at the time it is returned to the factory, is found to have been defective during the warranty period. This warranty does not cover damage or liability for misuse, abuse, or the improper application or installation of the Banner product.

**THIS LIMITED WARRANTY IS EXCLUSIVE AND IN LIEU OF ALL OTHER WARRANTIES WHETHER EXPRESS OR IMPLIED (INCLUDING, WITHOUT LIMITATION, ANY WARRANTY OF MERCHANTABILITY OR FITNESS FOR A PARTICULAR PURPOSE), AND WHETHER ARISING UNDER COURSE OF PERFORMANCE, COURSE OF DEALING OR TRADE USAGE.**

This Warranty is exclusive and limited to repair or, at the discretion of Banner Engineering Corp., replacement. **IN NO EVENT SHALL BANNER ENGINEERING CORP. BE LIABLE TO BUYER OR ANY OTHER PERSON OR ENTITY FOR ANY EXTRA COSTS, EXPENSES, LOSSES, LOSS OF PROFITS, OR ANY INCIDENTAL, CONSEQUENTIAL OR SPECIAL DAMAGES RESULTING FROM ANY PRODUCT DEFECT OR FROM THE USE OR INABILITY TO USE THE PRODUCT, WHETHER ARISING IN CONTRACT OR WARRANTY, STATUTE, TORT, STRICT LIABILITY, NEGLIGENCE, OR OTHERWISE.**

Banner Engineering Corp. reserves the right to change, modify or improve the design of the product without assuming any obligations or liabilities relating to any product previously manufactured by Banner Engineering Corp. Any misuse, abuse, or improper application or installation of this product or use of the product for personal protection applications when the product is identified as not intended for such purposes will void the product warranty. Any modifications to this product without prior express approval by Banner Engineering Corp will void the product warranties. All specifications published in this document are subject to change; Banner reserves the right to modify product specifications or update documentation at any time. Specifications and product information in English supersede that which is provided in any other language. For the most recent version of any documentation, refer to: [www.bannerengineering.com](http://www.bannerengineering.com).

For patent information, see [www.bannerengineering.com/patents](http://www.bannerengineering.com/patents).

## X-ON Electronics

Largest Supplier of Electrical and Electronic Components

*Click to view similar products for [Emergency Stop Switches / E-Stop Switches](#) category:*

*Click to view products by [Banner](#) manufacturer:*

Other Similar products are found below :

[AVN302N-R](#) [SR AL40ALK-A01N](#) [AVD000T8](#) [D2D 1013H](#) [84-6820.0020A](#) [45-2C35.2920.110](#) [45-2C36.2820.000](#) [45-2D36.2920.000](#) [45-2D36.2A20.000](#) [84-5321.2B20](#) [84-5331.2B20](#) [84-5341.2B20](#) [84-6820.0040](#) [84-6841.2B40](#) [TZ-75](#) [BP 15](#) [SCHRAUBENSATZ M5X12](#) [SCHRAUBENSATZ M5X16](#) [AZ 16-03ZI-B1](#) [MONTAGESATZ MS AZM 161 P](#) [AZM201B-I2-SK-T-1P2PW](#) [SLK-F-UC-55-R1-A0-L1-0](#) [SLC-M-024-20/20-R4](#) [F3S-TGR-NLPC-21-10](#) [XCSPA891](#) [1.15.105.002/0000](#) [84-5040.0130](#) [HWAV-74-Y](#) [84-5141.2B40](#) [1.15.210.900/0000](#) [3004.5246](#) [3031.1306](#) [3050.0071](#) [3050.1303N](#) [30B4.1206](#) [3100.0110N](#) [ESR5-NE-51-24VAC-DC](#) [440A-A17101](#) [440E-A13078](#) [440E-A13079](#) [440E-A13080](#) [440E-A13081](#) [440G-A27011](#) [440G-T27127](#) [440K-A21006](#) [440K-A27010](#) [440K-T11090](#) [440K-T11467](#) [504222](#) [506406](#)