

# TL70 Modular Tower Light



## Quick Start Guide

This guide is designed to help you set up and install the TL70 Modular Tower Light. For complete information on programming, performance, troubleshooting, dimensions, and accessories, please refer to the Instruction Manual at [www.bannerengineering.com](http://www.bannerengineering.com). Search for p/n 182214 to view the Instruction Manual. Use of this document assumes familiarity with pertinent industry standards and practices.

## Configuring the Modules



Turn on the appropriate DIP switch to set the order of the components, counting up from the tower light's base.

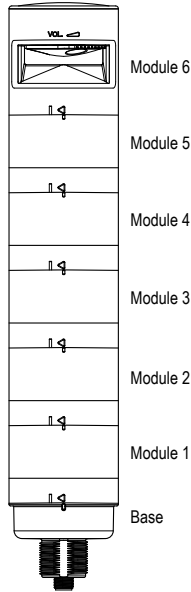

Assembly Options		DIP Switches							
		1	2	3	4	5	6	7	8
Light and Standard Audible Components	Module 1	ON							
	Module 2		ON						
	Module 3			ON					
	Module 4				ON				
	Module 5					ON			
	Module 6						ON		
Light Module Flash Rate	3 Hz							ON	OFF
	1.5 Hz							ON	ON
	Solid On*							OFF	OFF
Standard Audible Module Settings	Pulse 1.5 Hz							ON	OFF
	Chirp Alarm							ON	ON
	Siren Alarm							OFF	ON
	Continuous Alarm*							OFF	OFF

Assembly Options		DIP Switches									
		1	2	3	4	5	6	7	8	9	10
Loud Audible Module Settings	Pulse 1.5 Hz							ON	OFF		
	Chirp Alarm							ON	ON		
	Siren Alarm							OFF	ON		
	Continuous Alarm*							OFF	OFF		
	Low Intensity*									OFF	OFF
	Med. Intensity									ON	OFF
	Med./Loud Intensity									OFF	ON
	Loud Intensity									ON	ON

\* Factory default setting



# Assembling the Modules

Figure 1. Assembling the modules

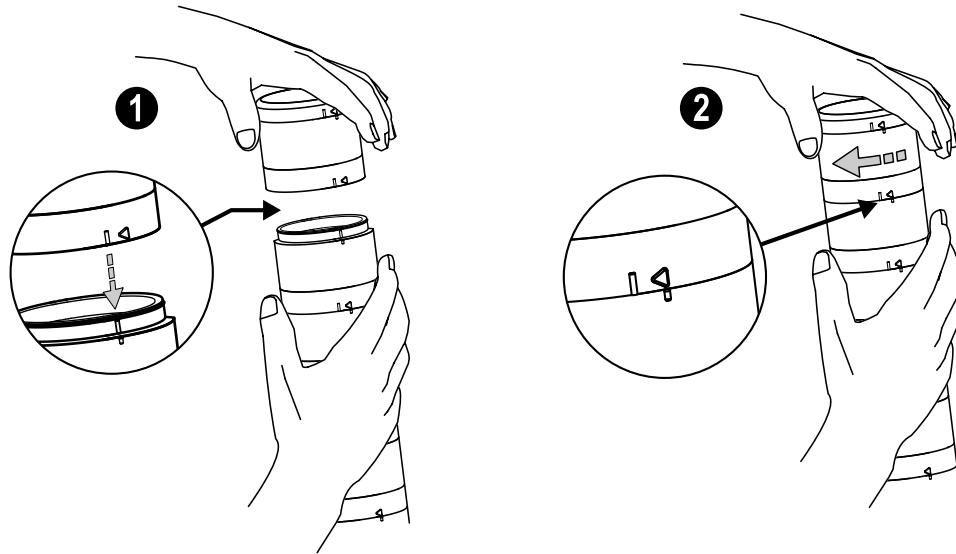

To assemble the modules:

1. Align the notches on each module and press together.
2. Rotate the top module clockwise to lock into place (notches shown in the locked position).

# Wiring Diagrams

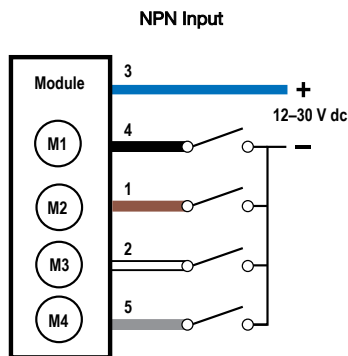
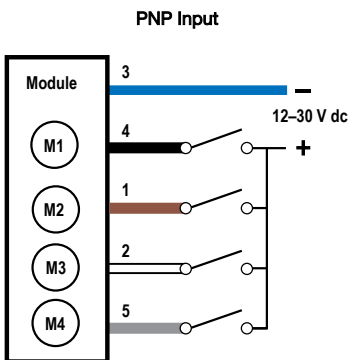

Euro-style Male Pinouts

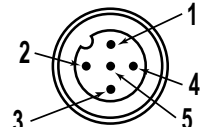

Key

- 1 = brown
- 2 = white
- 3 = blue
- 4 = black
- 5 = gray
- M1 = Module 1
- M2 = Module 2
- M3 = Module 3
- M4 = Module 4

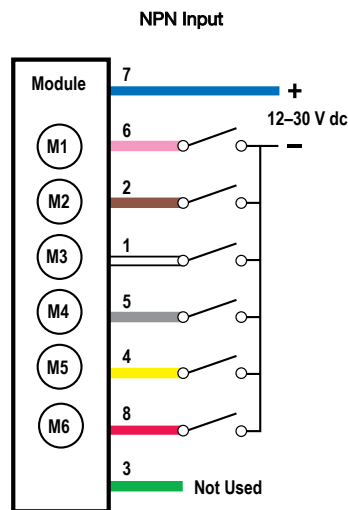
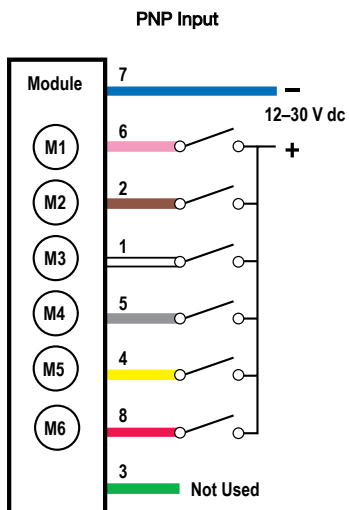

Euro-style Male Pinouts

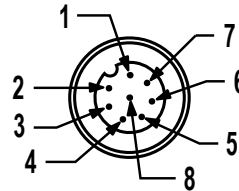

Key

- 1 = white
- 2 = brown
- 3 = green
- 4 = yellow
- 5 = gray
- 6 = pink
- 7 = blue
- 8 = red
- M1 = Module 1
- M2 = Module 2
- M3 = Module 3
- M4 = Module 4
- M5 = Module 5
- M6 = Module 6



**Note:** Models SG-TL70-ALM and SG-TL70-ALMC are not compatible with NPN input wiring.

**Wiring Terminal Block**

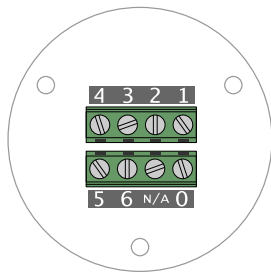

**Terminal Block Key**

- 0 = dc common
- 1 = Module 1
- 2 = Module 2
- 3 = Module 3
- 4 = Module 4
- 5 = Module 5
- 6 = Module 6

**Specifications**

**Supply Voltage and Current**  
12 V DC to 30 V DC

Indicator Color or Audible Model	Maximum Current (mA)		
	at 12 V DC	at 24 V DC	at 30 V DC
Blue, Green, White	420	200	150
Red, Yellow, Orange	285	145	120
Standard Audible	30	30	30
Loud Audible (Intensity 1)	30	28	25
Loud Audible (Intensity 2)	50	45	40
Loud Audible (Intensity 3)	165	90	75
Loud Audible (Intensity 4)	350	160	120
Programmable Audible	290	140	125

**Supply Protection Circuitry**  
Protected against transient voltages

**Indicators**

1 to 6 colors depending on model (Green, Red, Yellow, Blue, White, and Orange)  
LEDs are independently selected  
**Flash Rates:** 1.5 Hz ±10% and 3 Hz ±10%

**Indicator Response Time**

**Off Response:** 150 µs (maximum) at 12 V DC to 30 V DC  
**On Response:** 180 ms (maximum) at 12 V DC; 50 ms (maximum) at 30 V DC

**Indicator Characteristics**

Color	Dominant Wavelength (nm) or Color Temperature (CCT)	Color Coordinates <sup>1</sup>		Lumen Output (Typical at 25 °C)
		x	y	
Green	525 nm	-	-	92
Red	625 nm	-	-	40
Yellow	590 nm	-	-	22
Blue	470 nm	-	-	32
White	5000 K	-	-	125
Orange	-	0.66	0.33	33

**Connections**

5-pin M12 quick disconnect connector, 8-pin M12 quick disconnect connector, 150 mm (5.9 in) PVC cable with an M12 quick disconnect connector, terminal block, or 2 m (6.5 ft) unterminated cable, depending on model

**Terminal Block Models**

14 to 28 AWG wire

**Operating Conditions**

-40 °C to +50 °C (-40 °F to +122 °F)  
95% at +50 °C maximum relative humidity (non-condensing)

**Environmental Rating**

IP65

**Certifications**



**Banner Engineering Europe** Park Lane, Culliganlaan 2F bus 3, 1831 Diegem, BELGIUM

**Turck Banner LTD** Blenheim House, Blenheim Court, Wickford, Essex SS11 8YT, Great Britain

**Audible Alarm**

**Standard Audible:** 2.6 kHz ± 250 Hz oscillation frequency; maximum intensity (typical) 98 dB at 1 m (3.3 ft)  
**Loud Audible:** 2.6 kHz ± 250 Hz oscillation frequency; maximum intensity (typical) at 1 m (3.3 ft) (see table)

DIP Switches		Maximum Intensity (typical) at 1 meter dB
9	10	
ON	ON	Intensity 4: 109 dB
OFF	ON	Intensity 3: 106 dB
ON	OFF	Intensity 2: 101 dB
OFF	OFF	Intensity 1: 94 dB

**Audible Adjustment**

**Standard Audible:** Rotate the cover until the desired volume is reached  
**Loud Audible Alarm:** Select the desired volume using DIP switches 9 and 10  
**Typical Reduction in Sound Intensity with Audible Adjustment (maximum to minimum):**

- **Standard Audible:** 8 dB
- **Loud Audible:** 15 dB

**Construction**

**Bases, Segments, Covers:** polycarbonate

**Vibration and Mechanical Shock**

Vibration: 10 Hz to 55 Hz, 0.5 mm peak-to-peak amplitude per IEC 60068-2-6  
Shock: 15G 11 ms duration, half sine wave per IEC 60068-2-27

**Required Overcurrent Protection**



**WARNING:** Electrical connections must be made by qualified personnel in accordance with local and national electrical codes and regulations.

Overcurrent protection is required to be provided by end product application per the supplied table. Overcurrent protection may be provided with external fusing or via Current Limiting, Class 2 Power Supply. Supply wiring leads < 24 AWG shall not be spliced. For additional product support, go to [www.bannerengineering.com](http://www.bannerengineering.com).

Supply Wiring (AWG)	Required Overcurrent Protection (Amps)
20	5.0
22	3.0
24	2.0
26	1.0
28	0.8
30	0.5

<sup>1</sup> Refer to CIE 1931 chromaticity diagram or color chart, to show equivalent color with indicated color coordinates.

## Banner Engineering Corp. Limited Warranty

---

Banner Engineering Corp. warrants its products to be free from defects in material and workmanship for one year following the date of shipment. Banner Engineering Corp. will repair or replace, free of charge, any product of its manufacture which, at the time it is returned to the factory, is found to have been defective during the warranty period. This warranty does not cover damage or liability for misuse, abuse, or the improper application or installation of the Banner product.

**THIS LIMITED WARRANTY IS EXCLUSIVE AND IN LIEU OF ALL OTHER WARRANTIES WHETHER EXPRESS OR IMPLIED (INCLUDING, WITHOUT LIMITATION, ANY WARRANTY OF MERCHANTABILITY OR FITNESS FOR A PARTICULAR PURPOSE), AND WHETHER ARISING UNDER COURSE OF PERFORMANCE, COURSE OF DEALING OR TRADE USAGE.**

This Warranty is exclusive and limited to repair or, at the discretion of Banner Engineering Corp., replacement. **IN NO EVENT SHALL BANNER ENGINEERING CORP. BE LIABLE TO BUYER OR ANY OTHER PERSON OR ENTITY FOR ANY EXTRA COSTS, EXPENSES, LOSSES, LOSS OF PROFITS, OR ANY INCIDENTAL, CONSEQUENTIAL OR SPECIAL DAMAGES RESULTING FROM ANY PRODUCT DEFECT OR FROM THE USE OR INABILITY TO USE THE PRODUCT, WHETHER ARISING IN CONTRACT OR WARRANTY, STATUTE, TORT, STRICT LIABILITY, NEGLIGENCE, OR OTHERWISE.**

Banner Engineering Corp. reserves the right to change, modify or improve the design of the product without assuming any obligations or liabilities relating to any product previously manufactured by Banner Engineering Corp. Any misuse, abuse, or improper application or installation of this product or use of the product for personal protection applications when the product is identified as not intended for such purposes will void the product warranty. Any modifications to this product without prior express approval by Banner Engineering Corp will void the product warranties. All specifications published in this document are subject to change; Banner reserves the right to modify product specifications or update documentation at any time. Specifications and product information in English supersede that which is provided in any other language. For the most recent version of any documentation, refer to: [www.bannerengineering.com](http://www.bannerengineering.com).

For patent information, see [www.bannerengineering.com/patents](http://www.bannerengineering.com/patents).

## X-ON Electronics

Largest Supplier of Electrical and Electronic Components

*Click to view similar products for [Tower Lights](#) category:*

*Click to view products by [Banner manufacturer](#):*

Other Similar products are found below :

[5125](#) [TL50BGYRQ](#) [TL50GYRAQ](#) [LD6A-3DQB-RYG](#) [LD6A-3DZQB-RYG](#) [790520900](#) [LD6A-3WQB-RYG](#) [LD6A-0PZQB](#) [2994](#)  
[TL50HRQP](#) [4000-76501-5310000](#) [TL50GRAQ](#) [TL50GYRQ](#) [TL50GYR](#) [LD6A-3WZQB-RYG](#) [TL70GYRQ](#) [C30-Q01](#) [HD90-Q01](#) [HD90-](#)  
[Q31](#) [B-TL70B-Q5](#) [B-TL70B-Q8](#) [LCA130T3-TL50GYR300Q](#) [LCA130T3-TL50GYR600Q](#) [LCA130T3-TL50GYR900Q](#) [LCA130T3-](#)  
[TL50GYRAJ300Q](#) [LCA130T3-TL50GYRAJ600Q](#) [LCA130T3-TL50GYRAJ900Q](#) [LCA130T4-TL50BGYR300Q](#) [LCA130T4-](#)  
[TL50BGYR600Q](#) [LCA130T4-TL50BGYR900Q](#) [LCA130T4-TL50BGYRAJ300Q](#) [LCA130T4-TL50BGYRAJ600Q](#) [LCA130T4-](#)  
[TL50BGYRAJ900Q](#) [LCA130T4-TL50GYRA300Q](#) [LCA130T4-TL50GYRA600Q](#) [LCA130T4-TL50GYRA900Q](#) [LCA130T5-](#)  
[TL50BGYRA300Q](#) [LCA130T5-TL50BGYRA600Q](#) [LCA130T5-TL50BGYRA900Q](#) [SG-TL70-A](#) [SG-TL70B-A](#) [SG-TL70B-B](#) [SG-TL70B-G](#)  
[SG-TL70B-R](#) [SG-TL70B-W](#) [SG-TL70B-Y](#) [SG-TL70-W](#) [SG-TL70-G](#) [SG-TL70-O](#) [SG-TL70-Y](#)