

承 認 書

SPECIFICATION FOR APPROVAL

<i>CUSTOMER:</i>	
<i>CUSTOMER P/N</i>	
<i>PART NO:</i>	BC1610D
<i>DESCRIPTION:</i>	
<i>PRODUCTS NO:</i>	10/100 Dual Port TRANSFORMER Module
<i>PRODUCTS REV:</i>	01
<i>DATE:</i>	2019-10-22

<i>PURCHASER CONFIRMED.</i>		
<i>APPROVAL BY</i>	<i>CHECK BY</i>	<i>DRAWN BY</i>
<i>REMARK</i>		
<i>PROVIDER ENGINEER DEPT.</i>		
<i>APPROVAL BY</i>	<i>CHECK BY</i>	
ouyangweijun	xuqiuyue	chenlinli



TAIPEI OFFICE

誠陽實業有限公司

TAIWAN CHENG YANG COMPONENT CORP.
2F-1, NO. 176, Chine-Yi Road., Zhonghe District, New Taipei City, TAIWAN(R.O.C)
新北市中和區建一路 176 號 2 樓之一
POSTAL CODE: 23500
TEL NO.:+886-2- 8228-0930 FAX NO.:+886-2-8228-0929 E-mail:h21803@ms29.hinet.net



CHINA FACTORY

寶誠電子股份有限公司

ZHUHAI BAO CHENG ELECTRONICSCO.,LTD
Guan Tang Industrial Park, Tang Jia Wan Town, Zhuhai City, Guangdong Province, CHINA
中國廣東省珠海市塘家灣鎮官塘工業區
POSTAL CODE: 519085
TEL NO:86-756-3383187 FAX NO:86-756-3380704 E-mail: baocheng@baocheng.biz



CHINA FACTORY

昆山誠陽電子科技股份有限公司

KUNSHAN CHENG YANG ELECTRONICSCO.,LTD
Qiang-An Road., High-Tech. Industrial Park, Kunshan City, Jiangsu Province, China
江蘇省昆山市高科技工業園區強安路 38 號
POSTAL CODE: 215300
TEL NO:86-512-57823500 FAX NO:86-512-57823503 E-mail: kscy@taiwan-chengyang.com.tw

KUNSHAN CHENG YANG ELECTRONICSCO.,LTD

SPECIFICATION FOR APPROVAL

Customer:	Customer P/N:	Date: 2019-10-22
Quantity: 50PCS	P/N: BC1610D	REV: A0

1. MECHANICAL DIMENSIONS:

UNIT: mm ±0.25

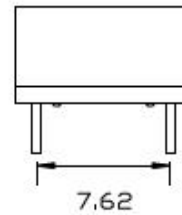
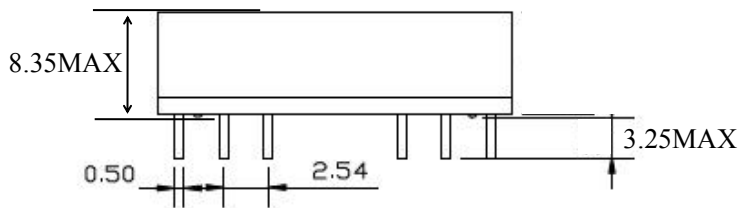
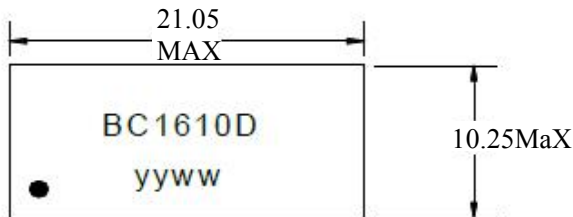

(PIN4,5,12,13 cutoff)

Unless otherwise specified, all tolerances are mm(inch) ± 0.25(0.010)

2. SCHEMATICS:

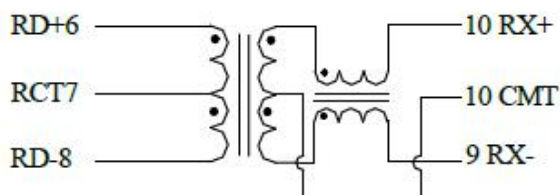
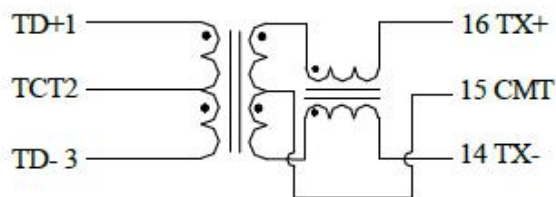

KUNSHAN CHENG YANG ELECTRONICSCO.,LTD

SPECIFICATION FOR APPROVAL

Customer:	Customer P/N:	Date: 2019-10-22
Quantity: 50PCS	P/N: BC1610D	REV: A0

3. ELECTRICAL SPECIFICATIONS @ 25°C:

3-1. Inductance OCL:

@350uH Min 100KHz 0.1V 8mA

3-2. Leakage Inductance:

@0.5 uH Max 100KHz 0.1V

3-3. Interwinding Capacitance:

@80PF Max 100KHz 0.1V

3-4. D.C.R:

@0.9Ω Max

3-5. Turn Ratio:

@ Receive=ICT:ICT ±5%

@ Transmit=ICT:ICT ±5%

3-6. Polarity:

@1-16,6-10 In-Phase

3-7. Isolation HI-POT:

@1500VAC 1mA 1S

Operating Temp Range: 0°C TO 70°C.

KUNSHAN CHENG YANG ELECTRONICSCO.,LTD

SAMPLE TEST DATA

Customer:		Customer P/N:				Date: 2019-10-22			
Quantity: 50PCS		P/N: BC1610D				REV: A0			
SPECIFICATION:		1	2	3	4	5			
L:(AT 100KHz 0.1V 8mA)									
350uH Min									
(Test by TH2818)									
1-3		550.0	578.2	593.4	550.1	611.2			
6-8		568.2	560.5	600.5	612.2	622.4			
LK:(AT 100KHz 0.1V)									
0.5uH Max									
(Test by TH2817)									
1-3(16-14short)		0.24	0.26	0.25	0.21	0.23			
6-8(10-9short)		0.24	0.24	0.24	0.25	0.24			
CW/W:(AT 100KHz 0.1V)									
80 PF Max									
(Test by TH2817)									
1-3 to 16-14		20.5	20.1	22.2	21.2	19.5			
6-8 to 10-9		19.5	22.3	21.5	19.5	20.5			
URNS RATIO:									
(Test by TH2818)									
Receive=1CT:1CT±5%		OK	OK	OK	OK	OK			
Transmit=1CT:1CT±5%		OK	OK	OK	OK	OK			
DCR:(AT 25°C)									
0.9 Ω Max									
(Test by TH2818)									
1-3		0.60	0.61	0.60	0.60	0.61			
6-8		0.60	0.60	0.61	0.61	0.60			
Polarity:									
(Test by TH2818)									
1-16 In-Phase		OK	OK	OK	OK	OK			
6-10 In-Phase		OK	OK	OK	OK	OK			
QA Inspection	Dimension	OK		Electrical		OK		Result	PASS
Reported: ouyangweijun		Checked: xuqiuyue			Approved: chenlinli				

KUNSHAN CHENG YANG ELECTRONICSCO

材質成份表 Component Composition Sheet

Basic Information of Supplier and Component

Supplier Name: 昆山诚阳电子科技股份有限公司	Part No. of customer:						製造商 Make:
Contact Person: 刘莉	Part No. of Supplier:	BC1610D					
E-mail: kscy@taiwan-chengyang.com.tw	Part Description:						
TEL: (0512-57823500)	Meet Standard?	RoHS	Y	GP			

材料ICP 檢測查核表 Component ICP test results Checklist

Data Reporting Structure - Complete BOM (材料以完整的BOM展開列表)

組成部品名稱 Component /Part Name	部品/UL型號 Part #	ICP 報告編號 ICP report #	測試單位 Test Org.	測試日期 Test Date	測試結果 Test results				
					Cd	Pb	Hg	Cr+6	PBB
铁芯		CANEC1710517503	SGS	2017. 6. 7	N. D.	N. D.	N. D.	N. D.	N. D.
铁芯		CANEC1710517501	SGS	2017. 6. 7	N. D.	N. D.	N. D.	N. D.	N. D.
漆包线		SCL01J000468003E	CTI	2017.1.9	N. D.	N. D.	N. D.	N. D.	N. D.
胶		SCL01I006312011	SGS	2017.2.17	N. D.	N. D.	N. D.	N. D.	N. D.
无铅锡		CANEC1703266202	SGS	2017.3.10	N. D.	10	N. D.	N. D.	N. D.
胶壳		SCL01I11731901E	CTI	2017.01.03	N. D.	N. D.	N. D.	N. D.	N. D.

Memo:

1. 請依照材料申請的種類, 勾選 **RoHS** 或是 **GP**
2. 合格與否, 需依照勾選的**RoHS** 或是**GP** 的要求標準.
3. **ICP** 每年測試一次, 或是有**ECN** 變更時須重新測試.

核准: _____

填表人: 刘莉 填寫日期: _____ 20

KUNSHAN CHENG YANG ELECTRONICSCO.,LTD

Packaging specifications

Customer: 上海斐讯	Customer P/N: 806001573	Date: 2017-12-01
Quantity: 50PCS	TEJIN P/N: BC1610D	REV: A0

Packaging:

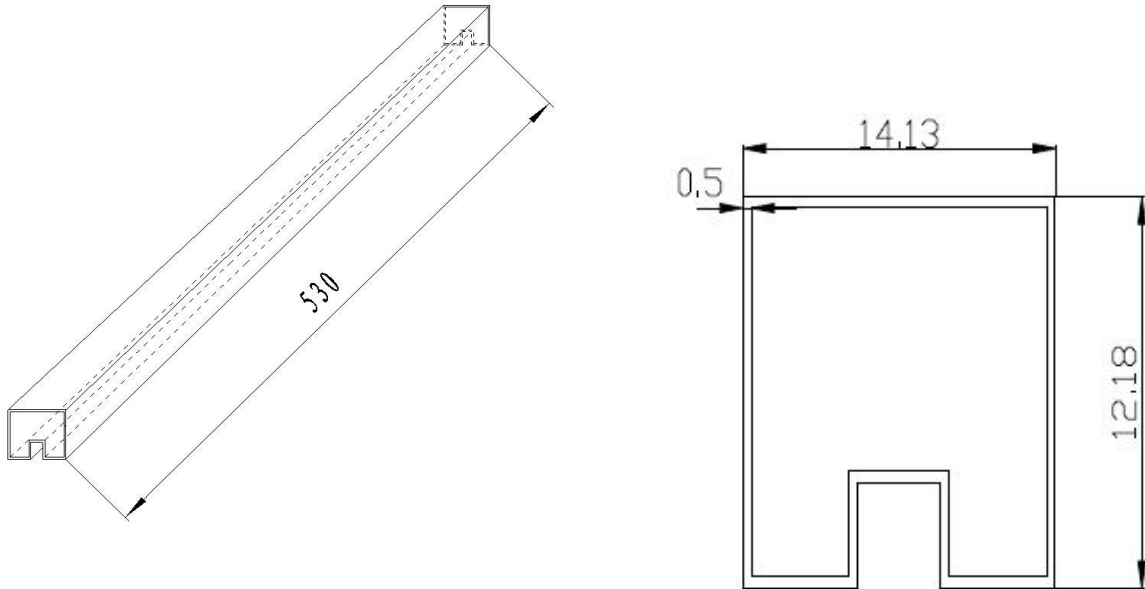

Length:530±2mm General Tolerance:±0.20mm
Thickness:0.5±0.1mm Plug Color:White
Component:25PCS/Tube

2.Catton

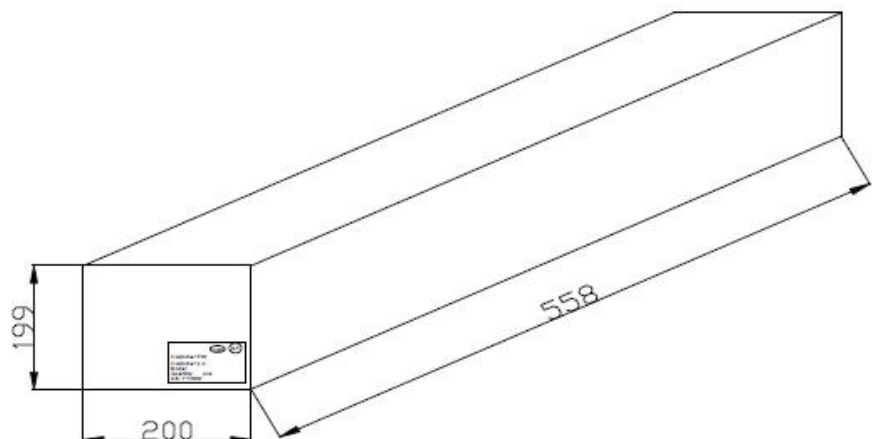

Material:Paper

Size:558x200x199 mm

Total Component:5250PCS/BOX

二、标签示意图

Customer P/N:	HSF	GP
Customer P/O:		
Model:		
Magcom P/N:		
Quantity:	PCS	
D/C :YY/WW:		MDAE IN XXXXX

标签一

材质: 铜板纸 厚度 $0.08\text{mm}\pm 0.02\text{mm}$

油墨: 黑色

尺寸: 自定

X-ON Electronics

Largest Supplier of Electrical and Electronic Components

Click to view similar products for [Audio Transformers](#) / [Signal Transformers](#) category:

Click to view products by [Bao Cheng](#) manufacturer:

Other Similar products are found below :

[749023020](#) [CU4S0506AT-2655-H1](#) [MET-58](#) [PE-64961](#) [H5008FNL](#) [H5020FNLT](#) [H5079NLT](#) [1879479-1](#) [1879564-1](#) [PA1277NLT](#)
[PA1528ANL](#) [PA2007NLT](#) [FL1066](#) [T1137NLT](#) [T3012NL](#) [PE-65812FNL](#) [TTC-100](#) [TTC-143-H](#) [TTC-5032-1](#) [HX1234NLT](#) [HX5008FNLT](#)
[100B-1001XNL](#) [PA1282NLT](#) [HX5084FNL](#) [T1108NLT](#) [2-1879391-5](#) [TTC-266-2](#) [3-1879385-4](#) [PA1032NL](#) [H2009FNLT](#) [PA0801NLT](#)
[TTC-266](#) [X-1619](#) [SM51295PEL](#) [T5008NLT](#) [PE-68517T](#) [HX1294NLT](#) [HX5084FNLT](#) [H5015FNLT](#) [H6080NLT](#) [CX2024NL](#) [HX1294FNLT](#)
[TX1473NLT](#) [PE-69011NLT](#) [CX2047LNLT](#) [CX2043LNLT](#) [DCT20EFD-U32S003](#) [H5120NLT](#) [H7137FNLT](#) [H1259NLT](#)