

承 認 書

SPECIFICATION FOR APPROVAL

CUSTOMER:	鹿鸣
CUSTOMER P/N	
PART NO:	
DESCRIPTION:	SMD POWER INDUCTORS
PRODUCTS NO:	CYSCM9085TL-162
PRODUCTS REV:	1
DATE:	2018-7-20

PURCHASER CONFIRMED		
REMARK		

PROVIDER ENGINEER DEPT.		
APPROVAL BY	CHECK BY	DRAWN BY
		<i>chenlinli</i>



TAIPEI OFFICE

誠陽實業有限公司
TAIWAN CHENG YANG COMPONENT CORP
2F-1, NO. 176, Chine-Yi Road., Zhonghe District, New Taipei City,
新北市中和區建一路176號2樓之一
POSTAL CODE: 23500
TEL NO.:+886-2- 8228-0930 FAX NO.:+886-2-8228-0929 E-



CHINA FACTORY

寶誠電子有限公司
ZHUHAI BAO CHENG ELECTRONICSCO.,LTD
Guan Tang Industrial Park, Tang Jia Wan Town, Zhuhai City, Guangdong
中國廣東省珠海市塘家灣鎮官塘工業區
POSTAL CODE: 519085
TEL NO:86-756-3383187 FAX NO:86-756-3380704 E-mail:



CHINA FACTORY

昆山誠陽電子有限公司
KUNSHAN CHENG YANG ELECTRONICSCO.,LTDP
Qiang-An Road., High-Tech. Industrial Park, Kunshan City, Jiangsu Province,
江蘇省昆山市高科技工業園區強安路38號
POSTAL CODE: 215300
TEL NO:86-512-57823500 FAX NO:86-512-57823503 E-mail: kscy@taiwan-che

TEST DATA

DIMENSION&ELECTRIC CHARACTER

CUSTOMER:	鹿鸣	PART NO.:	
TOMER :	SMD INDUCTOR	SERIES NO:	CYSCM9085TL-162

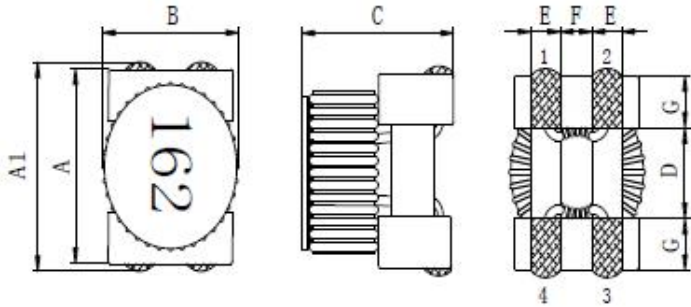
EXTERNAL DIMENSIONS**UNIT: mm**

A	9.0±0.5
A1	9.5±0.6
B	9.2MAX
C	8.5MAX
D	5.7REF
E	1.5REF
F	2.0REF
G	1.7REF
a	3.00
b	5.00
c	2.20
d	1.80

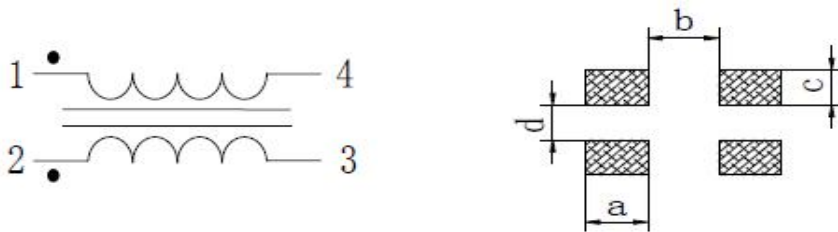
RECOMMEND LAND PATTERN DIMENSIONS**ELECTRICAL CHARACTERISTICS(@ 25°C)**

Part No.	Inductance (1-4)(2-3) (uH)	DCR (mΩ)	Rated Current (A) Max
CYSCM9085TL-162	1600±40%	130 Max	2.3
	100KHz/0.25V		ΔT ≤ 40°C
	TH2816B	GKT-502BC	CH2816+WR7210

NOTE:

Operating temperature: '-25°C~+85°C

storage : 温度: 0°C~+40°C 湿度: RH10%~70%

APPROVED BY: Vincent

CHECKED BY: Yasir

DRAWN BY: chenlinli

TEST DATA

DIMENSION&ELECTRIC CHARACTER

CUSTOMER	鹿鸣	PART NO.:	
TOMER :	SMD INDUCTOR	SERIES NO:	CYSCM9085TL-162

Curve

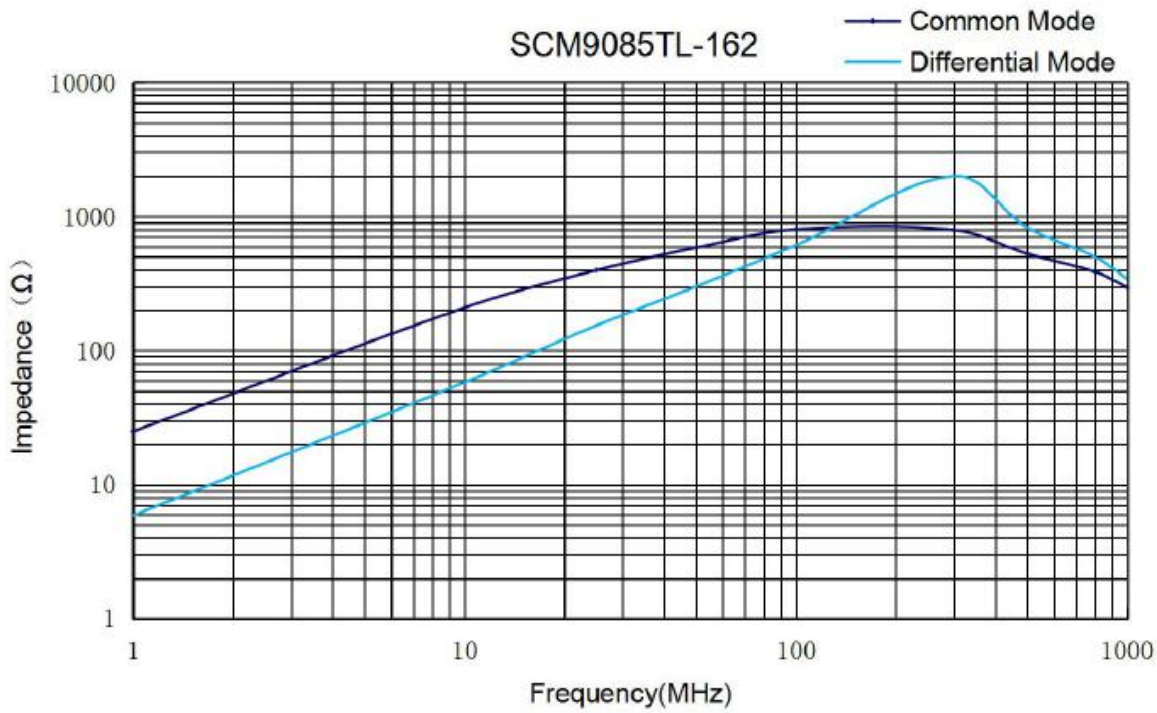

Impedance TEST EQUIPMENT

Measured by using HP4191 RF Impedance Analyzer.

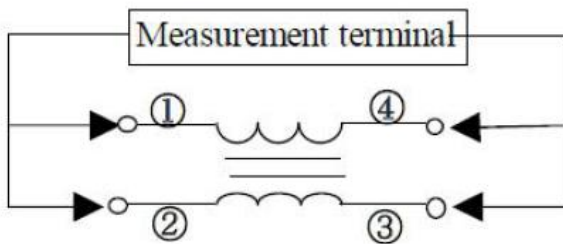

APPROVED BY	CHECKED BY	PREPARED BY
Vincent	Yasir	chenlinli

TEST DATA

DIMENSION&ELECTRIC CHARACTER

CUSTOMER :	鹿鸣	PART NO.:	
COMER :	SMD INDUCTOR	SERIES NO:	CYSCM9085TL-162

Material List

No.	Item	Material	Specification	Supplier	UL
a	Core	Ferrite	T CORE	ENCORE OR EQU	
b	Wire	Enamelled copper wire	G2P180	ELEKTRISOA OR EQU	E258243
c	Base	Plastic	LCP E4008	SUMITOMO OR EQU	
d	Adhesive	Epoxy resin	EP-600	SANTONG OR EQU	
e	Terminal	Sn /Cu	Sn99.3:Cu0.7	THOUSAND OR EQU	

Recommended Soldering Temperature Graph

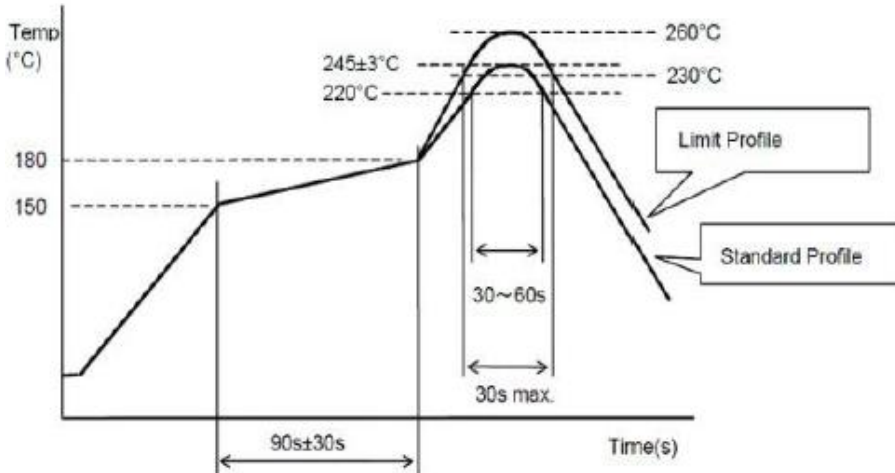

	Standard Profile	Limit Profile
Pre-heating	150~180°C、90s±30s	
Heating	above 220°C、30s-60s	above 240°C、30s max
Peak temperature	245°C±3°C	260°C、10s
Cycle of reflow	2 times	2 times

Product photos

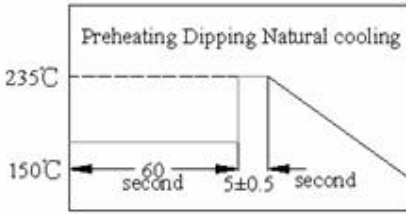
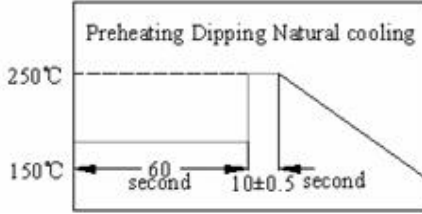
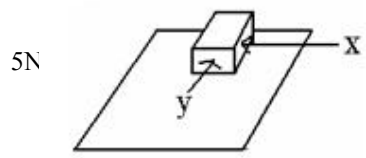

APPROVED BY	CHECKED BY	PREPARED BY
Vincent	Yasir	chenlinli

Operation Temperature	-40°C to +125°C (Includes temperature when the coil is heated)
External Appearance	On visual inspection, the coil has no external defects.
Solder Ability Test	<p>More than 90% of terminal electrode should be covered with solder.</p> <p>1 After fluxing, component shall be dipped in a melted solder bath at 235°C ± 5°C for 5 ± 0.5 seconds.</p> 
Heat endurance of Soldering	<p>1. Components should have not evidence of electrical and mechanical damage. 2. Inductance: within ±10% of initial value. 3. Impedance: within ±10% of initial value.</p> <ul style="list-style-type: none"> ● Preheat: 150 ± 5°C 60 seconds. ● Solder temperature: 250 ± 5°C. ● Flux: rosin. ● Dip time: 10 ± 0.5 seconds. 
Terminal Strength	<p>After soldering of X,Y withstanding at below conditions .The terminal should not Peel off. (Refer to figure at below)</p> 
Insulating Resistance	Over 100MΩ at 100V D.C. between coil and core.
Dielectric Strength	No dielectric breakdown at 30V D.C. for 1 minute between coil and core.
Vibration Test	Inductance deviation within +10% after vibration for 1 hour. In each of three orientations at sweep vibration(10~55~10HZ)with 1.5mmP-P amplitudes
Drop test	Inductance deviation within +10% after being dropped once with 981m/s ² (100G) shock Attitude upon a rubber block method shock testing machine, in three different orientations
<p>v Application Notice/Handling</p> <p>1. Storage Conditions To maintain the solder ability of terminal electrodes: (1) Temperature and humidity conditions: less than 40°C and 70% RH. (2) Products should be used within 6 months. (3) The packaging material should be kept where no chlorine or sulfur exists in the air.</p> <p>2. Handling (1) Do not touch the electrodes(soldering terminals)with fingers as this may lead to deterioration of solderability. (2) The use of tweezers or vacuum pick-ups is strongly recommended for individual components. (3) Bulk handling should ensure that abrasion and mechanical shock are minimized.</p>	

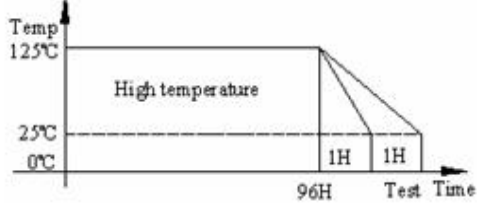
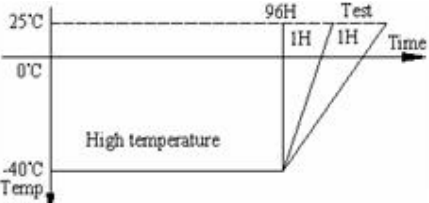
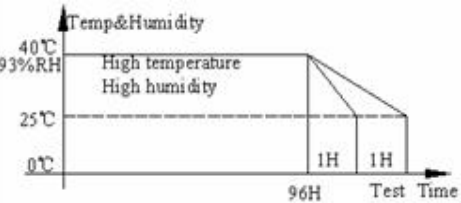
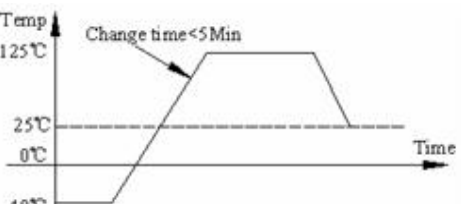
TEST	Required Characteristics	Test Method/Condition
<p>High Temperature Storage Test</p> <p>Reference documents: MIL-STD-202G Method108A</p>	<p>1. No case deformation or change in appearance 2. $\Delta L/L \leq 10\%$ 3. $\Delta Q/Q \leq 30\%$ 4. $\Delta DCR/DCR \leq 10\%$</p>	 <p>Temperature: $125^{\circ}\text{C} \pm 2^{\circ}\text{C}$ Time: 96 ± 2 hours. Tested not less than 1 hour, nor more than 2 hours at room.</p>
<p>Low Temperature Storage Test</p> <p>Reference documents: IEC 68-2-1A 6.1 6.2</p>	<p>1. No case deformation or change in appearance 2. $\Delta L/L \leq 10\%$ 3. $\Delta Q/Q \leq 30\%$ 4. $\Delta DCR/DCR \leq 10\%$</p>	 <p>Temperature: $-40^{\circ}\text{C} \pm 2^{\circ}\text{C}$ Time: 96 ± 2 hours. Tested not less than 1 hour, nor more than 2 hours at room.</p>
<p>Humidity Test</p> <p>Reference documents: MIL-STD-202G Method103B</p>	<p>1. No case deformation or change in appearance 2. $\Delta L/L \leq 10\%$ 3. $\Delta Q/Q \leq 30\%$ 4. $\Delta DCR/DCR \leq 10\%$</p>	 <p>1. Dry oven at a temperature of $40^{\circ}\text{C} \pm 2^{\circ}\text{C}$ for 96hours 2. Measurements At the end of this period 3. Exposure: Temperature: $40^{\circ}\text{C} \pm 2^{\circ}\text{C}$. Humidity: 93 ± 2hoys. 4. Tested while the chamber. 5. Tested not less than 1 hour. Nor more than 2 hours at room temperature.</p>
<p>Thermal Shock Test</p> <p>Reference documents: MIL-STD-202G Method107G</p>	<p>1. No case deformation or change in appearance 2. $\Delta L/L \leq 10\%$ 3. $\Delta Q/Q \leq 30\%$ 4. $\Delta DCR/DCR \leq 10\%$</p>	 <p>First -40°C for 30 Minutes, last 125°C for 30 Minutes as 1 cycle. Go through 20 cycles.</p>

■ Application Notice/Handling

- (1) Temperature and humidity conditions : less than 40°C and 70% RH.
- (2) Products should be used within 6 months.
- (3) The packaging material should be kept where no chlorine or sulfur exists in the air.
- (4) Do not touch the electrodes (soldering terminals) with fingers as this may lead to deterioration of solder ability
- (5) The use of tweezers or vacuum pick-ups is strongly recommended for individual components.
- (6) Bulk handling should ensure that abrasion and mechanical shock are minimized.

TYPICAL WAVE SOLDER PROFILE FOR LEADED AND LEAD-FREE THROUGH-HOLE PACKAGES

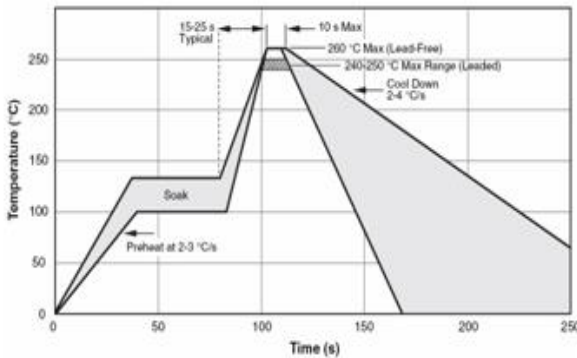

TYPICAL IR REFLOW PROFILE FOR LEADED AND LEAD-FREE SURFACE MOUNT PACKAGES

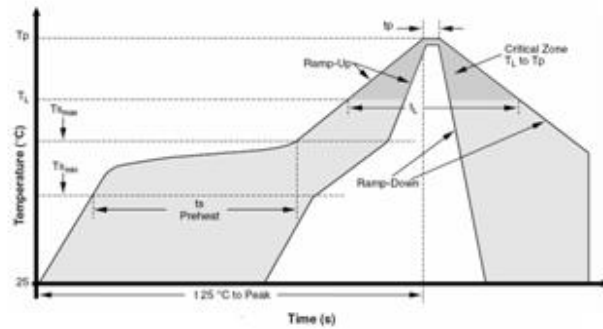

IPC/JEDEC J-STD-020C, Figure 5-1

Profile Feature	Sn-Pb Eutectic Assembly	Pb-Free Assembly
Average Ramp-Up Rate (Ts _{max} to Tp)	3 °C/second max.	3 °C/second max.
Preheat		
± Temperature Min (Ts _{min})	100 °C	150 °C
± Temperature Max (Ts _{max})	150 °C	200 °C
± Time (ts _{min} to ts _{max})	60-120 seconds	60-180 seconds
Time maintained above:		
± Temperature (T _l)	183 °C	217 °C
± Time (t _l)	60-150 seconds	60-150 seconds
Peak/Classification Temperature (Tp)	See Table 4.1	See Table 4.2
Time within 5 °C of actual Peak Temperature (tp)	10-30 seconds	20-40 seconds
Ramp-Down Rate	6 °C/second max.	6 °C/second max.
Time 25 °C to Peak Temperature	6 minutes max.	8 minutes max.

Table 4. Classification Reflow Profiles (per IPC/JEDEC J-STD-020C, Table 5.2)

Note 1: All temperatures refer to top side of the package, measured on the package body surface.

Package Thickness	Volume mm ³ <350	Volume mm ³ ≥350
<2.5 mm	240 +0/-5 °C	225 +0/-5 °C
≥2.5 mm	225 +0/-5 °C	225 +0/-5 °C

Table 5. SnPb Eutectic Process – Package Peak Reflow Temperatures (per IPC/JEDEC J-STD-020C, Table 4.1)

Package Thickness	Volume mm ³ <350	Volume mm ³ 350-2000	Volume mm ³ >2000
<1.6 mm	260 + 0 °C *	260 + 0 °C *	260 + 0 °C *
1.6 mm - 2.5 mm	260 + 0 °C *	250 + 0 °C *	245 + 0 °C *
≥2.5 mm	250 + 0 °C *	245 + 0 °C *	245 + 0 °C *

* Tolerance: Process compatibility is up to and including the stated classification temperature (this means Peak reflow temperature + 0 °C. For example 260 °C + 0 °C) at the rated MSL level.

Table 6. Pb-free Process – Package Classification Reflow Temperatures (per IPC/JEDEC J-STD-020C, Table 4.2)

Note 1: The profiling tolerance is + 0 °C, -X °C (based on machine variation capability) whatever is required to control the profile process but at no time will it exceed -5 °C. Process compatibility at the peak reflow profile temperatures as defined in Table 4.2.

Note 2: Package volume excludes external terminals (balls, bumps, lands, leads) and/or nonintegral heat sinks.

Note 3: The maximum component temperature reached during reflow depends on package thickness and volume. The use of convection reflow processes reduces the thermal gradients between packages. However, thermal gradients due to differences in thermal mass of SMD packages may still exist.

Note 4: Components intended for use in a “lead-free” assembly process shall be evaluated using the “lead-free” classification temperatures and profiles defined in Tables 4.1, 4.2 and 5.2 whether or not lead free.

X-ON Electronics

Largest Supplier of Electrical and Electronic Components

Click to view similar products for [Common Mode Chokes / Filters](#) category:

Click to view products by [Bao Cheng](#) manufacturer:

Other Similar products are found below :

[74279408](#) [PE-62911NL](#) [PE-64683](#) [RD5122-6-9M6](#) [RGCMF1210900H3T](#) [ST6118T-R](#) [FE3X025-10-7NL](#) [T8114NLT](#) [RD5122-10-6M0](#)
[TCM0806G-350-2P-T](#) [TCM0806G-650-2P-T](#) [B2013FNLT](#) [IND-0110](#) [UAL21V07012500](#) [UAL21VR0802000](#) [UAL24VR06500CH](#)
[UALSC023000000](#) [UALSC1020JH000](#) [UALSC1520JH000](#) [UALSU10VR15019](#) [UALSU9HF060300](#) [UALSU9VD070100](#) [36-00037](#)
[5701610000](#) [UALW21HS200290](#) [UALW21HS072450](#) [UALSU9VD070400](#) [UALSU9HF050500](#) [UALSU9H0208000](#) [UAL24VK06450CH](#)
[PLT10HH401100PNB](#) [PLT10HH1026R0PNB](#) [PE-67531](#) [TLH10UB](#) [113 0R5](#) [2752045447](#) [CMS3-11-R](#) [7351V](#) [7408-RC](#) [CMF16-153131](#)
[744252510](#) [T8116NLT](#) [CMS2-10-R](#) [DLW44SN101SK2L](#) [FE2X10-4-2NL](#) [744253200](#) [744253101](#) [744252220](#) [TX8111NLT](#)
[UAL30VR3500470](#) [CTX01-19077-R](#)