

V_{RRM} = 650 V
 $I_F(T_c=110^\circ\text{C})$ = 6 A
 Q_c = 20.4 nC

Features:

- Extremely low reverse current
- No reverse recovery current
- Temperature independent switching
- Positive temperature coefficient on V_F
- Excellent surge current capability
- Low Capacitive charge



Benefits

- Essentially No switching losses
- System efficiency improvement over Si Diodes
- Increased power density
- Enabling higher switching frequency
- Reduction of Heat Sink Requirements
- System Cost savings due to smaller magnetics
- Reduced EMI

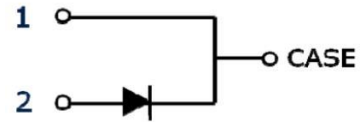

Applications

- Switch Mode Power Supplies (SMPS)
- Uninterruptable power supplies
- Motor Drivers
- Power Factor Correction

Pacakge Pin definitions

- Pin1-Cathode
- Pin2-Anode

Package Parameters

Part Number	Marking	Package
B1D06065KF	B1D06065KF	TO-220F-2L

Maximum ratings

Symbol	Parameter	Test conditions	Value	Unit
V_{RRM}	Repetitive Peak Reverse Voltage		650	V
V_{RSM}	Surge Peak Reverse Voltage		650	V
I_F	Continuous Forward Current	$T_c=25^{\circ}C$ $T_c=110^{\circ}C$ $T_c=150^{\circ}C$	10.6 6 3	A
I_{FSM}	Non-Repetitive Forward Surge Current	$T_c=25^{\circ}C$, $t_p=10ms$, sine halfwave	44	A
$\int i^2 dt$	i^2t Value	$T_c=25^{\circ}C$, $t_p=10ms$	9.68	A ² S
P_{tot}	Power Dissipation	$T_c=25^{\circ}C$ $T_c=110^{\circ}C$	27 12	W
T_j	Operating junction temperature		-55~175	$^{\circ}C$
T_{stg}	Storage temperature		-55~135	$^{\circ}C$

Thermal Characteristics

Symbol	Parameter	Value			Unit
		Min.	Typ.	Max.	
$R_{th(jc)}$	Thermal resistance from junction to case		5.394		K/W
$R_{th(ja)}$	Thermal resistance from junction to ambient		61.94		K/W

Electrical Characteristics
Static Characteristics (T_j=25°C unless otherwise specified)

Symbol	Parameter	Test conditions	Value			Unit
			Min.	Typ.	Max.	
V _{DC}	DC blocking voltage	T _j =25°C	650			V
V _F	Diode forward voltage	I _F =6A T _j =25°C I _F =6A T _j =175°C		1.45 1.9		V
I _R	Reverse current	V _R =650V T _j =25°C V _R =650V T _j =175°C		0.05 3		μA

Dynamic Characteristics (T_j=25°C unless otherwise specified)

Symbol	Parameter	Test conditions	Value			Unit
			Min.	Typ.	Max.	
Q _C	Total capacitive charge	V _R =400V T _j =25°C $Q_c = \int_0^{V_R} C(V)dV$		20.4		nC
C	Total Capacitance	V _R =1V f=1MHz V _R =300V f=1MHz V _R =500V f=1MHz		259 39.1 38.8		pF

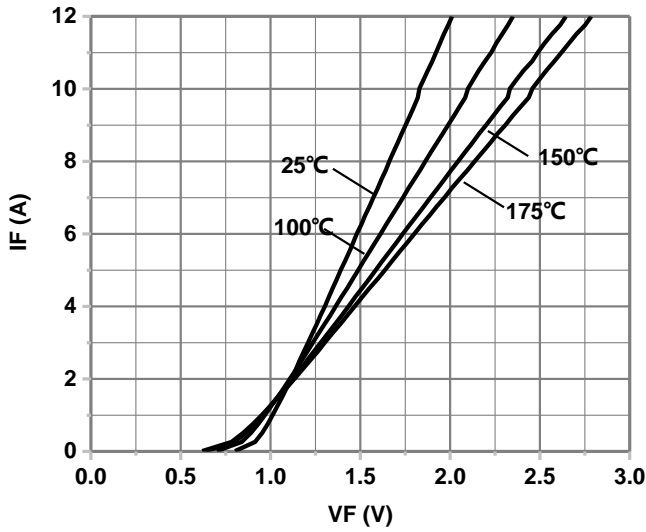

Figure 1. Typical forward characteristics

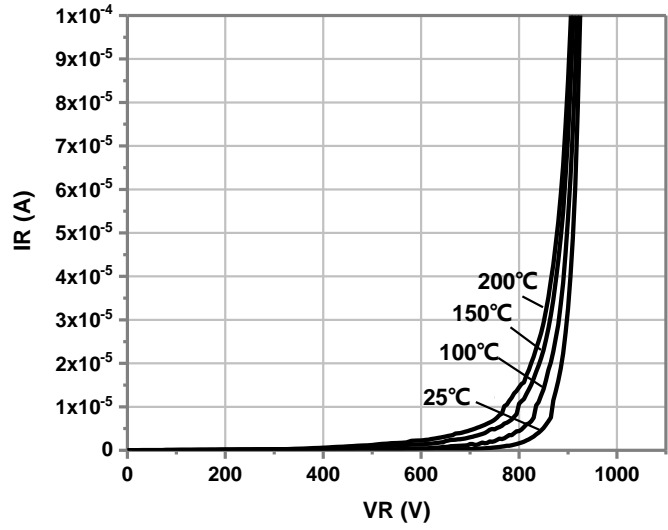

Figure 2. Typical reverse current as function of reverse voltage

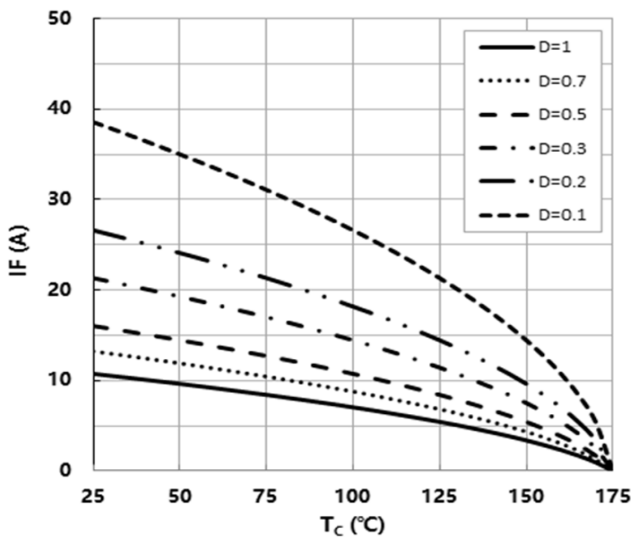

Figure 3. Diode forward current as function of temperature, D=duty cycle

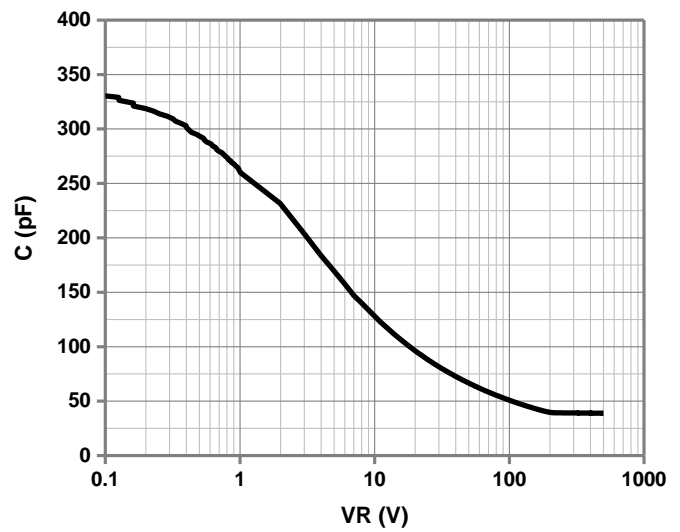

Figure 4. Typical capacitance as function of reverse voltage, $C=f(V_R)$; $T_j=25^\circ\text{C}$; $f=1\text{ MHz}$

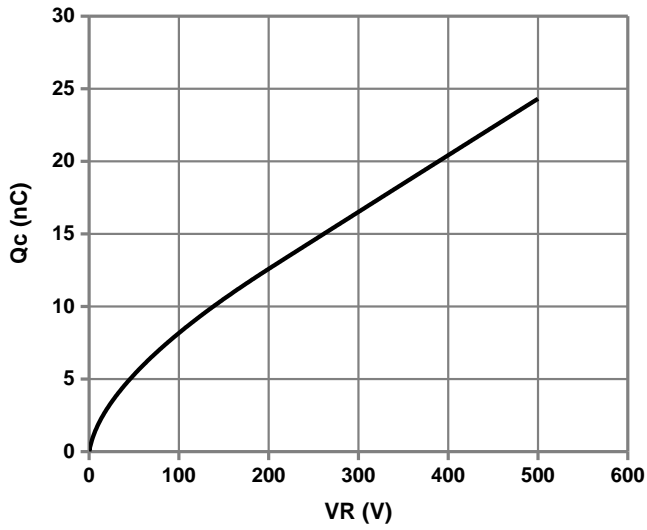

Figure 5. Typical reverse charge as function of reverse voltage

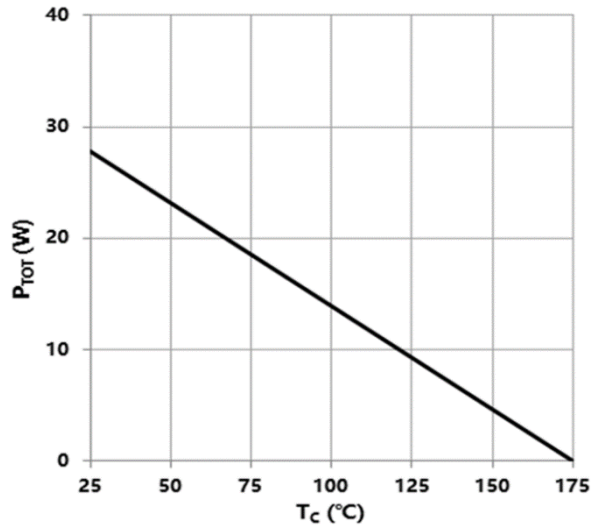

Figure 6. Power dissipation as function of case temperature

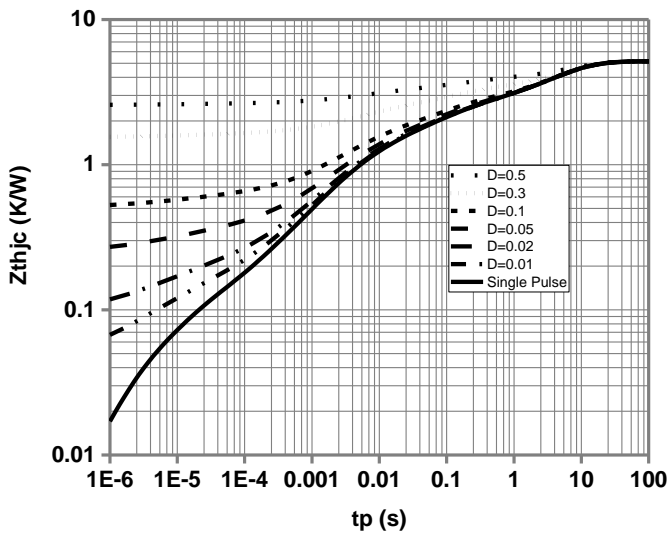
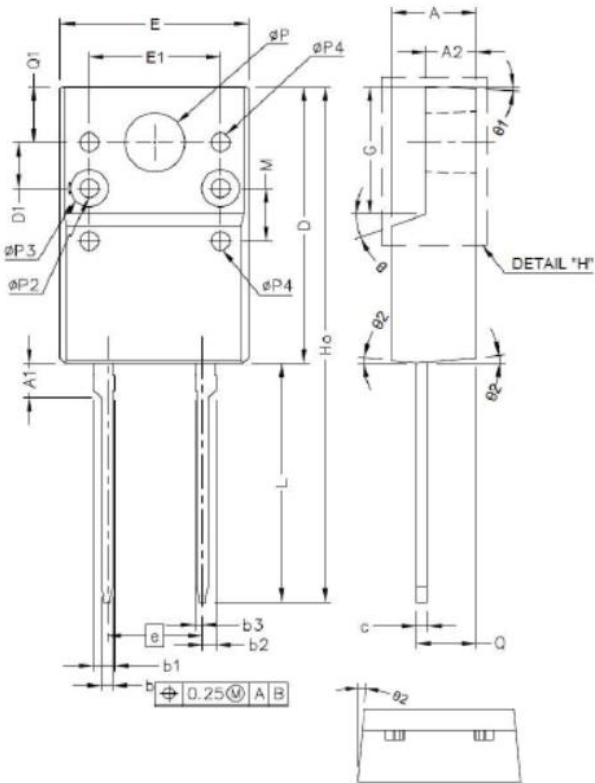

Figure 7. Max. transient thermal impedance, $Z_{th,jc}=f(t)$, parameter: $D=t/T$

Package Dimensions



SYMBOL	MIN (mm)	MAX (mm)
A	4.30	4.93
A1	1.80	3.90
A2	2.34	2.90
b	0.40	0.91
b1	1.00	1.40
b2	0.56	0.93
b3	0.24	0.55
C	0.40	0.80
D	14.70	16.07
D1	2.50 TYP	
D2	2.66 TYP	
e	4.83	5.33
E	9.70	10.36
E1	7.00 TYP	
G	6.50	7.10
H _o	28 TYP	
L	12.10	13.50
L1	0.50	
M	2.86 TYP	
ϕP	2.98	3.40
Q	3.10	3.30
Q1	2.70	3.50
θ	20° TYP	
$\theta1$	3° TYP	
$\theta2$	5° TYP	

Revision History:

2019-05-15

Preliminary Version

BASiC Semiconductor Ltd.
Shenzhen, China
© 2018 BASiC Semiconductor Ltd.
All Rights Reserved.

Information

For further information on technology, delivery terms and conditions and prices, please contact the nearest BASiC Semiconductor Office

Disclaimer

The information given in this document shall in no event be regarded as a guarantee of conditions or characteristics. With respect to any examples or hints given herein, any typical values stated herein and/or any information regarding the application of the device, BASiC semiconductor Ltd. hereby disclaims any and all warranties and liabilities of any kind, including without limitation, warranties of non-infringement of intellectual property rights of any third party.

X-ON Electronics

Largest Supplier of Electrical and Electronic Components

Click to view similar products for [Schottky Diodes & Rectifiers](#) category:

Click to view products by [BASiC Semiconductor](#) manufacturer:

Other Similar products are found below :

[CUS06\(Te85L,Q,M\)](#) [MA4E2039](#) [D1FH3-5063](#) [MBR0530L-TP](#) [MBR10100CT-BP](#) [MBR30H100MFST1G](#) [MMBD301M3T5G](#) [PMAD1103-LF](#) [PMAD1108-LF](#) [RB160M-50TR](#) [RB520S-30](#) [RB551V-30](#) [DD350N18K](#) [DZ435N40K](#) [DZ600N16K](#) [BAS16E6433HTMA1](#) [BAS 3010S-02LRH E6327](#) [BAT 54-02LRH E6327](#) [IDL02G65C5XUMA1](#) [NSR05F40QNXT5G](#) [NSVR05F40NXT5G](#) [JANS1N6640](#) [SB07-03C-TB-H](#) [SB1003M3-TL-W](#) [SBAT54CWT1G](#) [SBM30-03-TR-E](#) [SBS818-TL-E](#) [SK32A-LTP](#) [SK33A-TP](#) [SK34A-TP](#) [SK34B-TP](#) [SMD1200PL-TP](#) [ACDBN160-HF](#) [SS3003CH-TL-E](#) [STPS30S45CW](#) [PDS3100Q-7](#) [GA01SHT18](#) [CRS10I30A\(Te85L,QM\)](#) [MBR1240MFST1G](#) [MBRB30H30CT-1G](#) [BAS28E6433HTMA1](#) [BAS 70-02L E6327](#) [HSB123JTR-E](#) [JANTX1N5712-1](#) [VS-STPS40L45CW-N3](#) [DD350N12K](#) [SB007-03C-TB-E](#) [SB10015M-TL-E](#) [SB1003M3-TL-E](#) [SK110-LTP](#)