

Product Summary

V_{CE}	650V
I_C	75A @ $T_C=100^\circ\text{C}$
$V_{CE(sat),Typ}$	1.6V @ $I_C=75\text{A}$

Trench Field Stop IGBT Co-packed with SiC Schottky Barrier Diode

Features

- Low $V_{CE(sat)}$
- Trench FS Technology
- High Speed Switching
- Hybrid SiC Discrete Device
- Halogen Free, RoHS Compliant

Applications

- UPS
- PV Inverter
- Welding Machine
- On-board Charger
- Totem Pole Bridgeless PFC

Package Pin Definitions

- Pin1 and backside - Collector
- Pin2 - Power Emitter
- Pin3 - Kelvin Emitter
- Pin4 - Gate

Package Parameters

Part Number	Marking	Package
BGH75N65ZF1	BGH75N65ZF1	TO-247-4

Package: TO-247-4

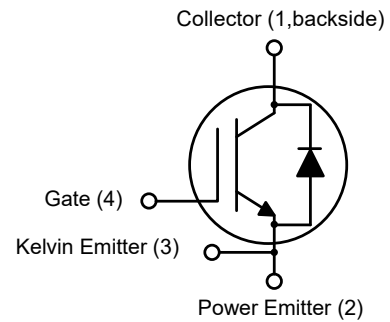

Maximum Ratings ($T_c=25^\circ\text{C}$ Unless Otherwise Noted)

Symbol	Parameter		Value	Unit
V_{CE}	Collector-Emitter Breakdown Voltage, $T_j \geq 25^\circ\text{C}$		650	V
V_{GE}	Continuous Gate-Emitter Voltage		± 20	
	Transient Gate-Emitter Voltage		± 30	
I_C	DC Collector Current, limited by T_{jmax}	$T_c=25^\circ\text{C}$	135	A
		$T_c=100^\circ\text{C}$	75	
I_F	Diode Forward Current, limited by T_{jmax}	$T_c=25^\circ\text{C}$	70	A
		$T_c=100^\circ\text{C}$	41	
$I_{C,pulse}$	Pulse Collector Current	$V_{GE}=15\text{V}$, limited by T_{jmax}	300	A
P_{tot}	Power Dissipation	$T_c=25^\circ\text{C}$	338	W
T_j	Operating Junction Temperature		-40~150	$^\circ\text{C}$
T_{stg}	Storage Temperature		-55~150	$^\circ\text{C}$
M_d	TO-247 mounting torque	M3 Screw	0.7	N*m

Thermal Characteristics

Symbol	Parameter	Value	Unit
$R_{th(j-c)}$	IGBT Thermal Resistance-Junction to Case	0.37	K/W
$R_{th(j-c)}$	Diode Thermal Resistance-Junction to Case	0.57	K/W
$R_{th(j-a)}$	Thermal Resistance-Junction to Ambient	30	K/W

Electrical Characteristics (Defined at $T_j=25^\circ\text{C}$ Unless Otherwise Specified)
IGBT Static Characteristics

Symbol	Parameter	Test Conditions	Min.	Typ.	Max.	Unit	
$V_{CE(sat)}$	Collector-Emitter Saturation Voltage	$V_{GE}=15\text{V}$, $I_C=75\text{A}$	$T_j=25^\circ\text{C}$	1.6	2.1	V	
			$T_j=100^\circ\text{C}$	1.79			
			$T_j=150^\circ\text{C}$	1.94			
I_{CES}	Zero Gate Voltage Collector Current	$V_{CE}=650\text{V}$, $V_{GE}=0\text{A}$	$T_j=25^\circ\text{C}$		500	μA	
			$T_j=150^\circ\text{C}$		2000		
		$V_{CE}=480\text{V}$, $V_{GE}=0\text{A}$	$T_j=25^\circ\text{C}$		90		
$V_{GE(th)}$	Gate Threshold Voltage	$V_{GE}=V_{CE}$, $I_C=750\mu\text{A}$	$T_j=25^\circ\text{C}$	4.2	5	5.8	V
I_{GES}	Gate-Emitter Leakage Current	$V_{CE}=0\text{V}$, $V_{GE}=\pm 20\text{V}$	$T_j=25^\circ\text{C}$			100	nA

g_{fs}	Transconductance	$V_{CE}=20V, I_C=75A$		94		S
----------	------------------	-----------------------	--	----	--	---

Dynamic Characteristics

Symbol	Parameter	Test conditions	Value			Unit
			Min.	Typ.	Max.	
C_{iss}	Input Capacitance	$V_{GE}=0V, V_{CE}=25V$ $f=250kHz$		8164		pF
C_{oss}	Output Capacitance			468		pF
C_{riss}	Reverse Transfer Capacitance				137	
Q_G	Total Gate Charge	$V_{CC}=520V, V_{GE}=15V, I_C=75A$		444		nC

Switching Characteristics, Inductive Load

Symbol	Parameter	Test conditions	Value			Unit	
			Min.	Typ.	Max.		
$t_{d(on)}$	Turn-On Delay Time	$T_j=25^\circ C$ $V_{DC}=400V, I_C=37.5A$ $V_{GE}=0/15V, R_{G(ext)}=10\Omega$ $L_\sigma=60nH$		38		ns	
t_r	Rise Time			26			
$t_{d(off)}$	Turn-Off Delay Time			481			
t_f	Fall Time			37			
E_{on}	Turn-On Energy			440		uJ	
E_{off}	Turn-Off Energy			600			
E_{total}	Total Switching Energy			1040			
$t_{d(on)}$	Turn-On Delay Time		$T_j=25^\circ C$ $V_{DC}=400V, I_C=75A$ $V_{GE}=0/15V, R_{G(ext)}=10\Omega$ $L_\sigma=60nH$		40		ns
t_r	Rise Time				47		
$t_{d(off)}$	Turn-Off Delay Time			429			
t_f	Fall Time			32			
E_{on}	Turn-On Energy			1210		uJ	
E_{off}	Turn-Off Energy			1305			
E_{total}	Total Switching Energy			2515			

SiC Schottky Barrier Diode Characteristics

Symbol	Parameter	Test Conditions	Min.	Typ.	Max.	Unit	
V_F	Diode Forward Voltage	$V_{GE}=0V,$ $I_F=30A$	$T_j=25^\circ C$		1.5		V
			$T_j=100^\circ C$		1.63		
			$T_j=150^\circ C$		1.81		
Q_C	Diode Capacitive Charge	$V_R=400V, T_j=25^\circ C$		64		nC	
C	Diode Capacitance	$V_R=1V, f=1MHz$		998		pF	
		$V_R=300V, f=1MHz$		110			

Typical Performance

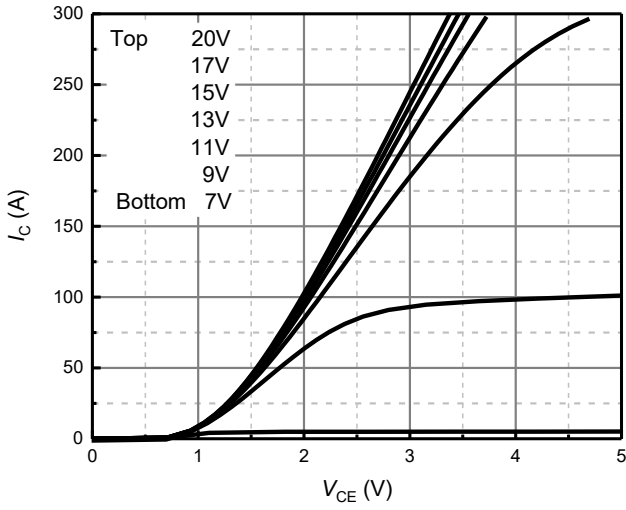

Figure 1 Output Characteristics
($T_j=25^\circ\text{C}$)

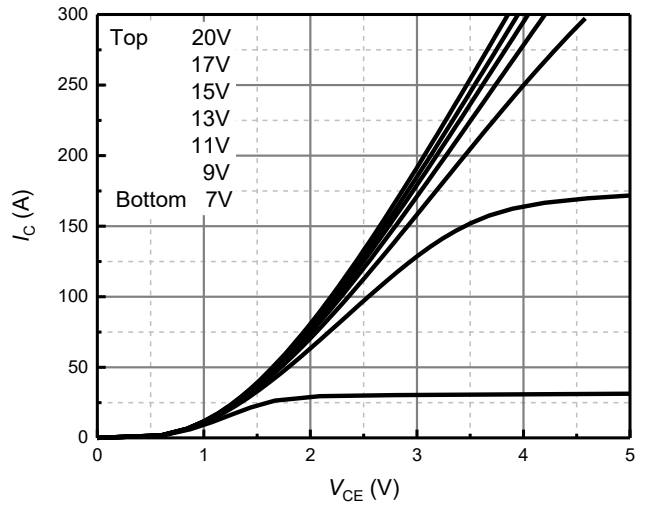

Figure 2 Output Characteristics
($T_j=150^\circ\text{C}$)

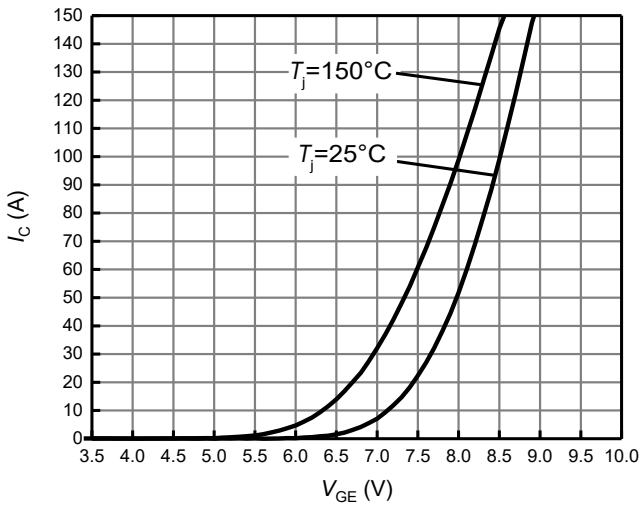

Figure 3 Transfer Characteristics for Various Temperature
($V_{CE}=20\text{V}$)

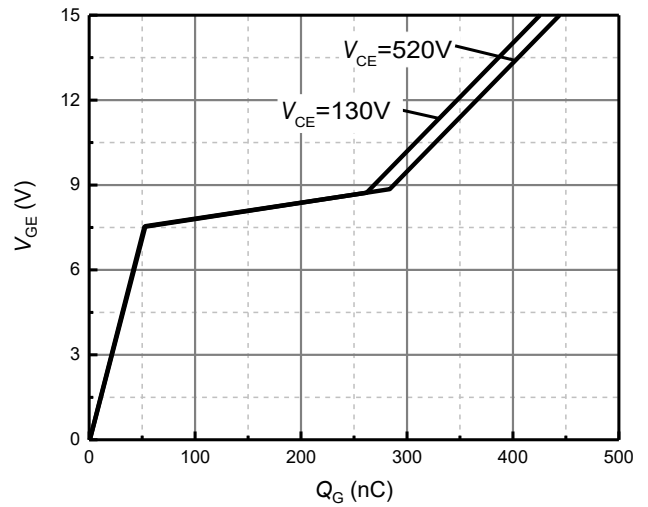

Figure 4 Gate Charge Characteristics
($I_c=75\text{A}$)

Typical Performance

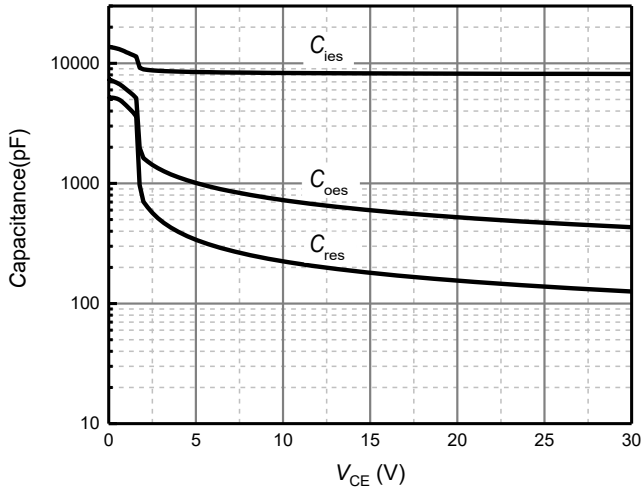

Figure 5 Capacitance Characteristics
($V_{GE}=0V$, $f=250kHz$)

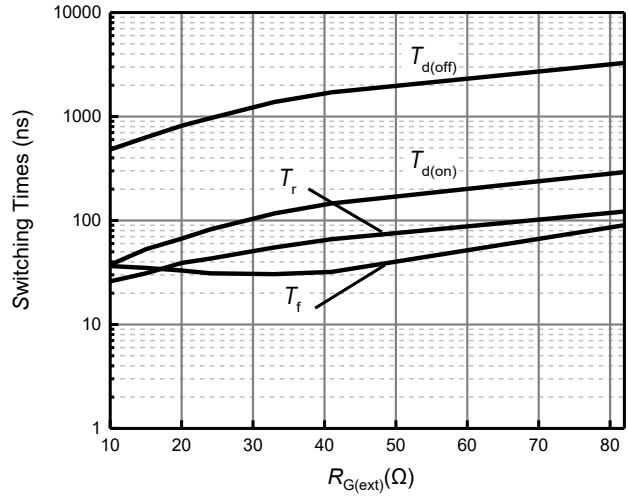

Figure 6 Switching Times vs. Gate Resistor
($V_{DC}=400V$, $V_{GE}=0/15V$, $I_C=37.5A$, $T_j=25^\circ C$)

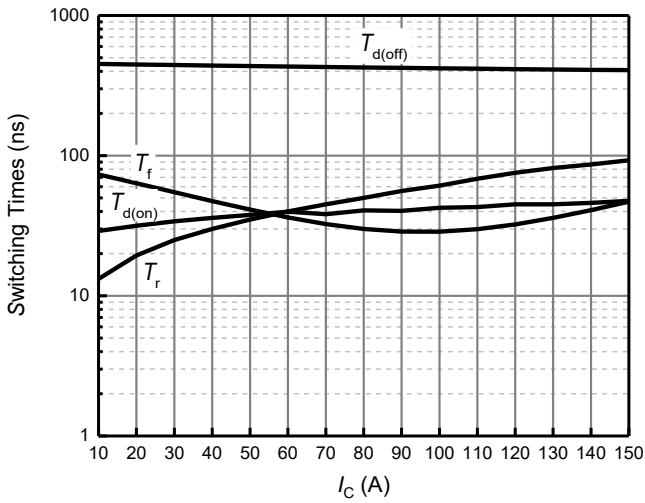

Figure 7 Switching Times vs. Collector Current
($V_{DC}=400V$, $V_{GE}=0/15V$, $R_{G(ext)}=10\Omega$, $T_j=25^\circ C$)

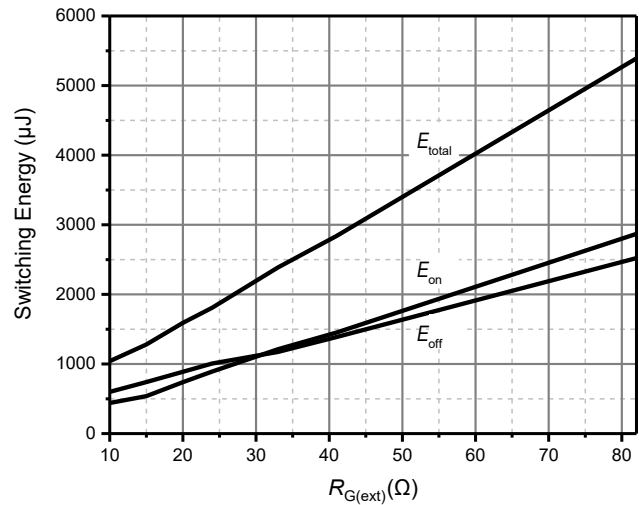

Figure 8 Switching Loss vs. Gate Resistor
($V_{DC}=400V$, $V_{GE}=0/15V$, $I_C=37.5A$, $T_j=25^\circ C$)

Typical Performance

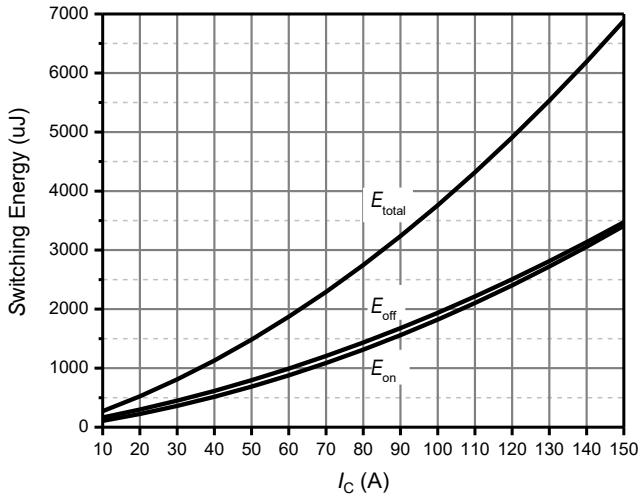

Figure 9 Switching Loss vs. Collector Current ($V_{DC}=400V$, $V_{GE}=0/15V$, $R_{G(ext)}=10\Omega$, $T_j=25^\circ C$)

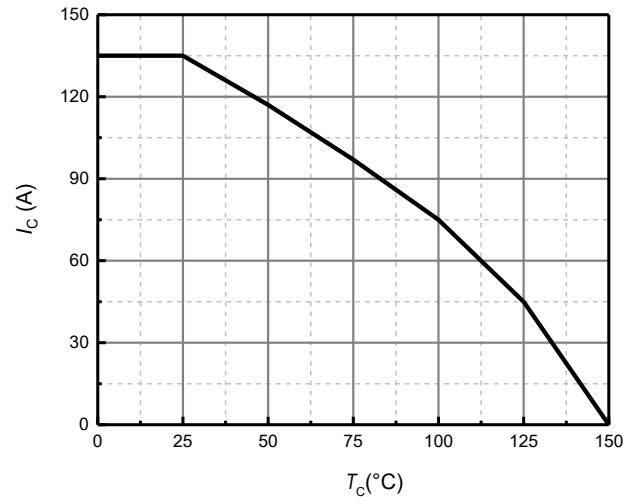

Figure 10 Collector current vs. Case Temperature

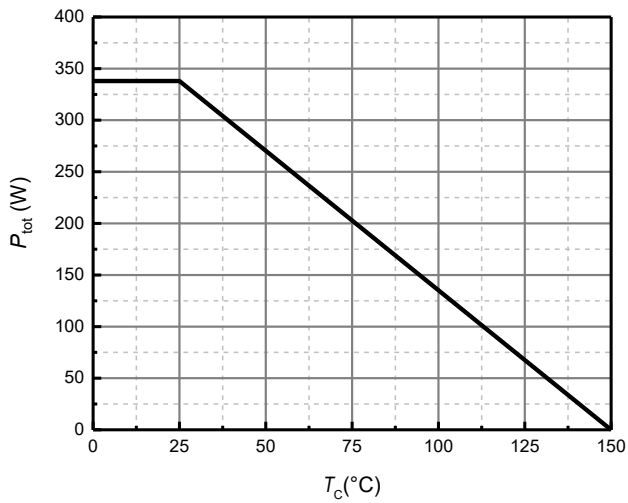

Figure 11 Power Dissipation vs. Case Temperature

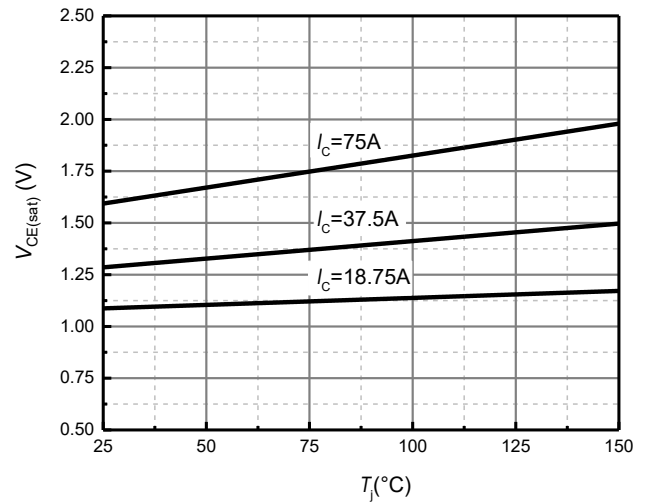

Figure 12 Collector-Emitter Saturation Voltage vs. Junction Temperature ($V_{GE}=15V$)

Typical Performance

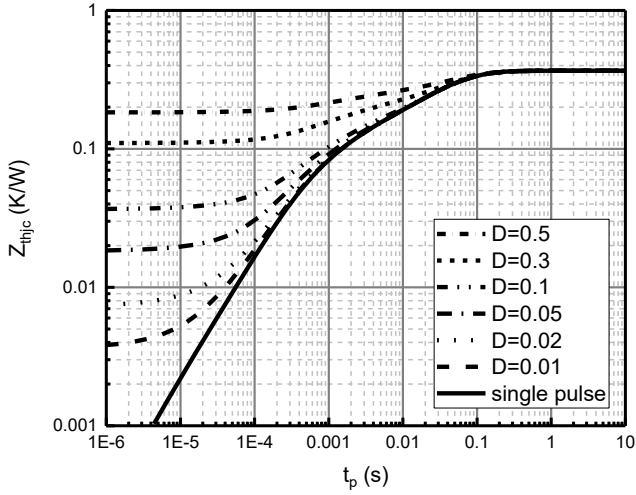

Figure 13 IGBT Transient Thermal Response Curve

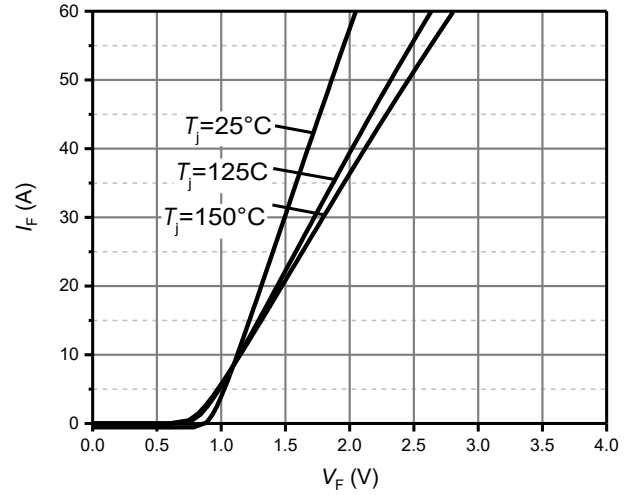

Figure 14 Forward characteristic of Diode

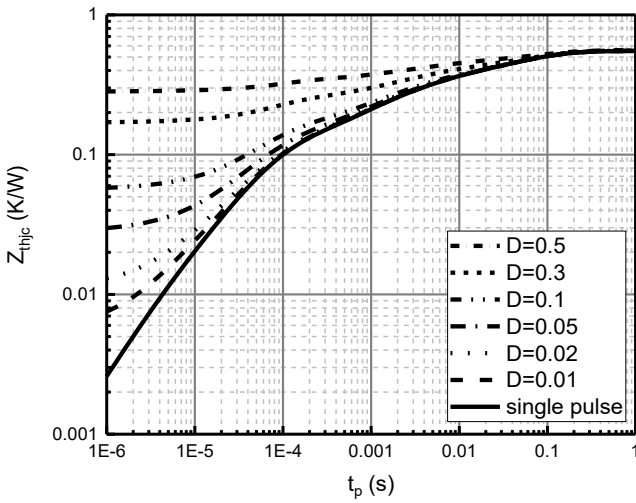

Figure 15 Diode Transient Thermal Response Curve

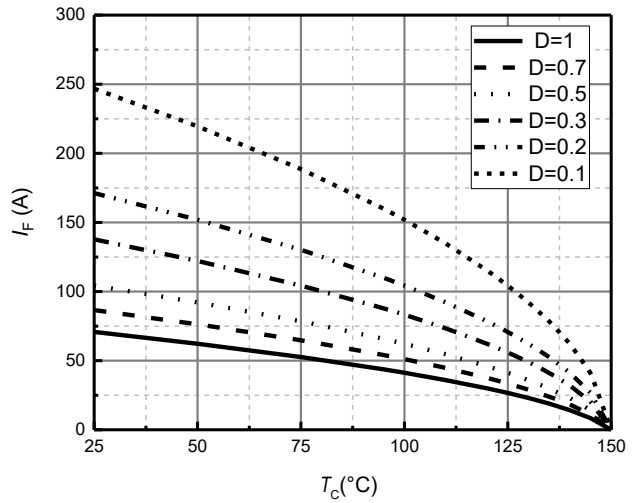
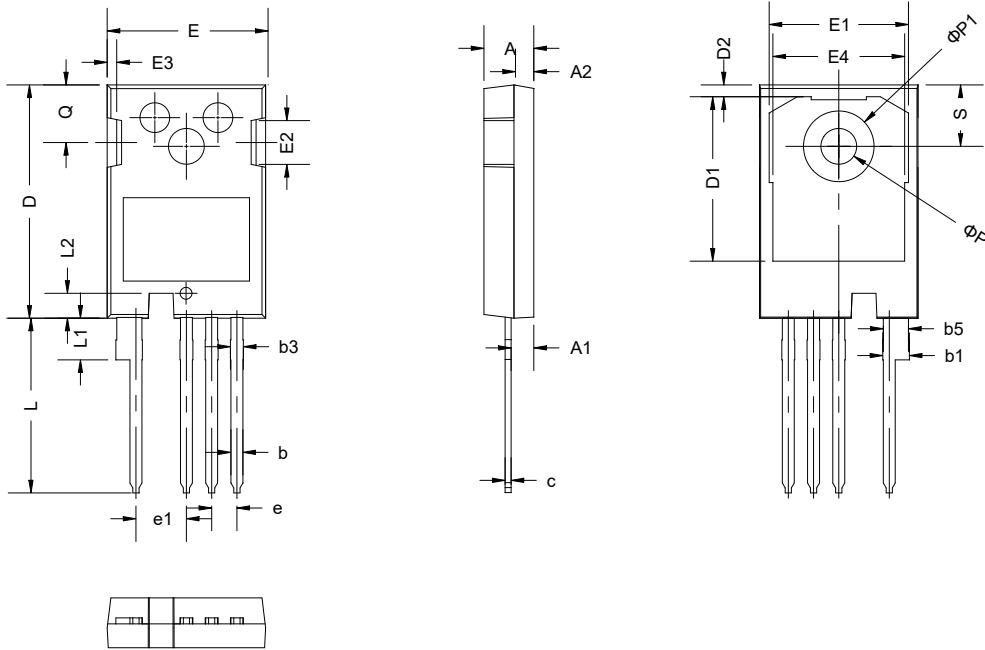

Figure 16 Diode forward current as function of temperature, D=duty cycle

Package Dimensions

SYMBOL	mm		
	MIN	NOM	MAX
A	4.83	5.02	5.21
A1	2.29	2.41	2.54
A2	1.91	2.00	2.16
b	1.07	1.20	1.33
b1	2.39	2.67	2.84
b3	1.07	1.30	1.60
b5	2.39	2.53	2.69
c	0.55	0.60	0.68
D	23.30	23.45	23.60
D1	16.25	16.55	17.65
D2	0.95	1.19	1.25
E	15.75	15.94	16.13
E1	13.10	14.02	14.15
E2	3.68	4.40	5.10
E3	1.00	1.45	1.90
E4	12.38	13.26	13.43
e	2.54 BSC		
e1	5.08 BSC		
L	17.31	17.57	17.82
L1	3.97	4.19	4.37
L2	2.35	2.50	2.65
φ P	3.51	3.61	3.65
φ P1	7.19 REF		
Q	5.49	5.79	6.00
S	6.04	6.17	6.30

Revision History

Document Version	Date of Release	Description of Changes
Rev. 0.0	2022-10-11	Draft datasheet created.

BASiC Semiconductor Ltd.
Shenzhen, China
© 2022 BASiC Semiconductor Ltd.
All Rights Reserved.

Information

For further information on technology, delivery terms and conditions and prices, please contact the nearest BASiC Semiconductor Office

Disclaimer

The information given in this document shall in no event be regarded as a guarantee of conditions or characteristics. With respect to any examples or hints given herein, any typical values stated herein and/or any information regarding the application of the device, BASiC semiconductor Ltd. hereby disclaims any and all warranties and liabilities of any kind, including without limitation, warranties of non-infringement of intellectual property rights of any third party.

X-ON Electronics

Largest Supplier of Electrical and Electronic Components

Click to view similar products for [IGBT Transistors](#) category:

Click to view products by [BASiC Semiconductor](#) manufacturer:

Other Similar products are found below :

[IRG4PC30W](#) [APT20GT60BRDQ1G](#) [STGWA25H120DF2](#) [APT30GS60BRDQ2G](#) [TIG058E8-TL-H](#) [IDW40E65D2](#) [STGB40V60F](#)
[STGWA25H120F2](#) [NGTB75N65FL2WAG](#) [NTE3320](#) [FGD3040G2-F085](#) [FGD3440G2-F085](#) [STGW80H65DFB-4](#) [AFGY160T65SPD-B4](#)
[IGW30N60TP](#) [IGW40N60TP](#) [IGW50N60TP](#) [IHW30N65R5](#) [IKFW40N60DH3E](#) [IKP15N65H5](#) [IKQ100N60T](#) [IKQ120N60T](#)
[IKW30N65WR5](#) [IKW75N60H3](#) [IKZ50N65NH5](#) [IKZ75N65NH5](#) [FGD3040G2-F085C](#) [FGH4L50T65SQD](#) [FGHL40T65MQDT](#)
[FGHL50T65MQD](#) [FGHL50T65MQDTL4](#) [FGHL75T65LQDT](#) [FGHL75T65MQD](#) [FGHL75T65MQDT](#) [FGHL75T65MQDTL4](#)
[FGY75T120SWD](#) [EL3120S1\(TA\)\(SAS\)-V](#) [IHW15N120E1](#) [IKQ75N120CS6](#) [IKW50N65WR5](#) [MG150HF12MIC2](#) [SL15T65FK](#)
[KGF50N65KDF-U/H](#) [LEGM75BF120L5H](#) [IHF40N65R5S](#) [IKW08N120CS7XKSA1](#) [IKQ75N120CH3](#) [IHW30N160R5](#)
[SGM100HF12A1TFD](#) [CRG50T60AK3SD](#)