

**300 Series  
Media Converter &  
Industrial Ethernet Switches  
Installation  
Guide**

## *Industrial Ethernet Switch Installation Guide*

**302MC-XX**

**302MCE-XX-YY**

**304TX**

**305FX-XX**

**305FXE-XX-YY**

**306TX**

**306FX2-XX**

**306FXE2-XX-YY**

**308TX**

Where: XX = ST or SC and YY = -15, -40, or -80





Copyright, © N-TRON Corp., 2008  
820 S. University Blvd., Suite 4E  
Mobile, AL 36609 USA

All rights reserved. Reproduction, adaptation, or translation without prior written permission from N-TRON Corp. is prohibited, except as allowed under copyright laws.

Ethernet is a registered trademark of Xerox Corporation. All other product names, company names, logos or other designations mentioned herein are trademarks of their respective owners.

The information contained in this document is subject to change without notice. N-TRON Corp. makes no warranty of any kind with regard to this material, including, but not limited to, the implied warranties of merchantability or fitness for a particular purpose. In no event shall N-TRON Corp. be liable for any incidental, special, indirect, or consequential damages whatsoever included but not limited to lost profits arising out of errors or omissions in this manual or the information contained herein.

## Warning

Do not perform any services on the unit unless qualified to do so. Do not substitute unauthorized parts or make unauthorized modifications to the unit.

Do not operate the unit with the top cover removed, as this could create a shock or fire hazard.

Do not block the air vents on the sides or the top of the unit.

Do not operate the equipment in the presence of flammable gasses or fumes. Operating electrical equipment in such an environment constitutes a definite safety hazard.

# Safety Warnings

## ELECTRICAL SAFETY



**WARNING:** Explosion hazard, do not disconnect while circuits is live unless area is known to be non-hazardous.

**WARNING:** Disconnect the power cable before removing the enclosure top.

**WARNING:** Do not operate the unit with the top cover removed.

**WARNING:** Do not work on equipment or cables during periods of lightning activity.

**WARNING:** Do not perform any services on the unit unless qualified to do so.

**WARNING:** Do not block the air vents.

**WARNING:** Observe proper DC Voltage polarity when installing power input cables. Reversing voltage polarity can cause permanent damage to the unit and void the warranty.

**Power must be supplied by an isolating source, and a 3.3 A maximum rated UL Recognized fuse must be installed immediately before the unit.**

## LASER SAFETY (FXE Products Only)



**CAUTION:** CLASS 1 LASER PRODUCT. Do not stare into the laser!)



### **Hazardous Location Installation Requirements**

1. **WARNING:** Do not disconnect while circuit is live, unless area is known to be non-hazardous.
2. **WARNING:** Install only in accordance with Local & National Codes of Authorities Having Jurisdiction.
3. Class I, Div 2 Installations require that power connections must be current limited at the power source with an in-line fuse rated at 0.5A.
4. Class I, Div 2 installations require that all devices connected to this product must be UL approved for the area in which it is installed.
5. Only UL approved wiring with temperature ratings greater than 90°C permitted for Class I, Div 2 installations operating at temperatures up to 70°C ambient.
6. Limited Operating Voltage: 12-30V for Class I, Div 2 installations.

## **300 Series Industrial Ethernet Switches**

The 300 Series Unmanaged Industrial Ethernet Switches support high speed layer 2 switching between ports. All N-TRON 300 Series switches are housed in a ruggedized steel enclosure, and provide Category-5 compliant 10/100-BaseT connections for high performance network design, and hub/repeater upgrades.

The 302MC/MCE is a 2 port unmanaged media converter that converts 10/100BaseTX copper to 100BaseFX full duplex fiber.

The 304TX, 306TX, and 308TX are affordable and share a small footprint. Each switch is capable of auto negotiating 10/100 Mb and half/full duplex communications.

The 305FX and 306FX2 switches are unmanaged and have 4 ports similar to the 304TX, plus an additional multimode fiber optic up-link port(s), capable of 2 Kilometers of 100 Mb communications without the use of repeaters.

The 305FXE and 306FXE2 switches are unmanaged and similar to the 305FX and 306FX2, respectively. However, these models use singlemode transceivers with extended range capability. The N-TRON FXE products utilize singlemode fiber transceiver(s) that are capable of 15, 40, and up to 80 Kilometers of 100 Mb full duplex communications.

All fiber products utilize the IEEE compliant SC or ST duplex connectors for fiber optic communications. All 10/100Base-TX ports utilize the RJ45 shielded connectors.

### **Key Features**

- Full IEEE 802.3 & 100Base-FX Compliance
- Full IEEE 1613 Compliance (Communications Networking Devices in Electric Power Stations)
- NEMA TS1/TS2 Compliance (Traffic Control Systems)
- American Bureau of Shipping (ABS) Type Approval (Maritime and Offshore Applications)
- Extended Environmental Specifications
- Support for Full/Half Duplex Operation
- LED Link/Activity Status Indication
- Autonegotiation, Autosensing Speed, Duplex, and Flow Control
- Up to 1.0 Gb/s Maximum Throughput
- Industry Standard 35mm DIN-Rail Mounted Enclosure



## PACKAGE CONTENTS

Please make sure the Ethernet Switch package contains the following items:

1. 300 Series Unit
2. N-Tron Product CD

Contact your carrier if any items are damaged.

## INSTALLATION

Read the following warning before beginning the installation:

### WARNING



FXE units contain a class 1 laser. Do not stare into the laser beam (fiber optic connector) when installing or operating the product.



Never install or work on electrical equipment or cabling during periods of lightning activity.

Disconnect the power cable before removing the enclosure top.

Do not operate the unit with the top cover removed

### UNPACKING

Remove all the equipment from the packaging, and store the packaging in a safe place. File any damage claims with the carrier.

## DIN-Rail Mounting

Install the unit in a standard DIN-Rail. Recess the unit to allow at least 5" of horizontal clearance for fiber optic cable bend radius (2" for TX models).

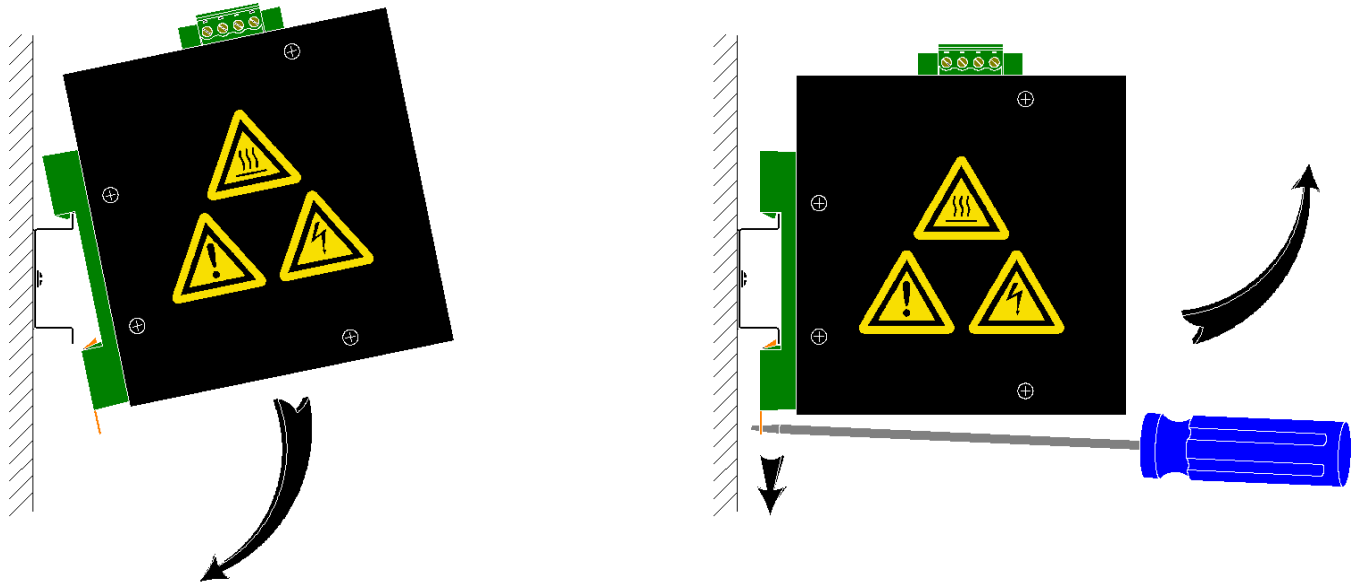

To install the unit to 35mm industrial DIN-Rail, place the top edge of the included mounting bracket on the back of the unit against the DIN-Rail at a 15° angle as shown. Rotate the bottom of the unit to the back (away from you) until it snaps into place.

To remove the unit from the 35mm industrial DIN-Rail, place a flat head screwdriver into the orange release clip found at the bottom of the unit, and apply downward force on the clip until it disengages from the bottom of the unit from the DIN-Rail. Rotate the bottom of the unit towards you and up at an approximate 15° upward angle to completely remove the unit.

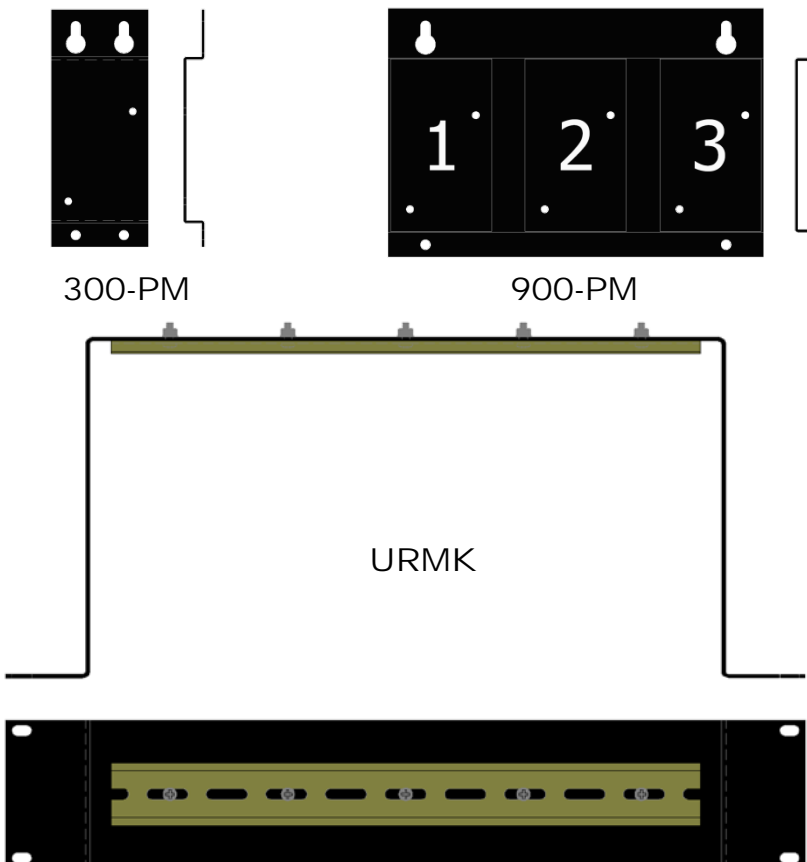

With the exception of the 524TX and 526FX2, all N-Tron™ products are designed to be mounted on industry standard 35mm DIN-Rail. However, DIN-Rail mounting may not be suitable for all applications. We offer three alternative mounting solutions: Our 300 Panel Mount Assembly (P/N: 300-PM) may be used to mount a single 300 Series unit to a panel or other flat surface. Our 900 Panel Mount Assembly (P/N: 900-PM) may be used to securely mount our 100, 200, 300, 400, 500, or 900 Series products to a panel or other flat surface; Our Universal Rack Mount Kit (P/N: URMK) may be used to mount our products to standard 19" racks.



## FRONT PANEL



<b>LNK</b>	Link LED for Fiber Optic Ports
<b>TX</b>	Fiber Optic Transmit Ports
<b>RX</b>	Fiber Optic Receive Ports
<b>ACT</b>	Activity LED for Fiber Optic Ports
<b>RJ45 Ports</b>	Ports 1-4 Auto sensing 10/100BaseT Connections
<b>⏻</b>	Green LED lights when Power is connected

**NOTE:** Each RJ45 data port has two LED's for each connector. The lower LED indicates LINK status, and the upper LED indicates ACTIVITY.

**LED's:** The table below describes the operating modes:

LED	Color	Description
⏻	GREEN	Power is Applied
	OFF	Power is OFF
LNK	GREEN	Link between ports established
	OFF	No Link between ports
ACT	GREEN	Data is active between ports
	OFF	Data is inactive between ports

## APPLYING POWER (Top View)

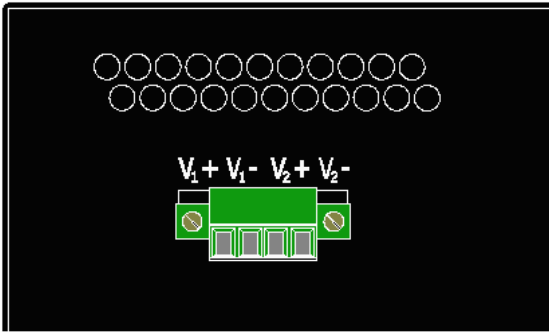

Unscrew & Remove the DC Voltage Input Plug from the top header.  
Install the DC Power Cables into the Plug (observing polarity on unit).  
Plug the Voltage Input Plug back into the top header.  
Tightening torque for the terminal block power plug is **0.22 Nm/0.162 Pound Foot**.  
All LED's will flash ON Momentarily  
Verify the Power LED stays ON (GREEN).

**Note:** Either V1 or V2 can be connected to power for minimal operation. For redundant power operation, V<sub>1</sub> and V<sub>2</sub> plugs must be connected to separate DC Voltage sources. Use wire sizes of 16-28 gauge. The power cord should be limited to less than 10 meters in order to ensure optimum performance.

Recommended 24V DC Power Supplies, similar to

100VAC/240VAC:

N-Tron's NTPS-24-1.3, DC 24V/1.3A (NOTE: Not appropriate for use with M12, POE, and HV models.)

## N-TRON SWITCH GROUNDING TECHNIQUES

The grounding philosophy of any control system is an integral part of the design. N-Tron switches are designed to be grounded, but the user has been given the flexibility to float the switch when required. The best noise immunity and emissions (i.e. CE) are obtained when the N-Tron switch chassis is connected to earth ground via a drain wire. Some N-Tron switches have metal din-rail brackets that can ground the switch if the din-rail is grounded. In some cases, N-Tron switches with metal brackets can be supplied with optional plastic brackets if isolation is required.

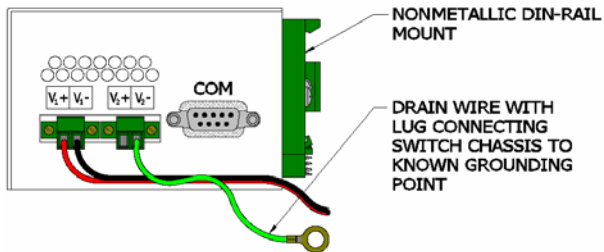

Both V- legs of the power input connector are connected to chassis internally on the PCB. Connecting a drain wire to earth ground from one of the V- terminal plugs as shown here will ground the switch and the chassis. The power leads from the power source should be limited to 3 meters or less in length.

As an alternate, users can run a drain wire & lug from any of the Din-Rail screws or empty PEM nuts on the enclosure. When using an unused PEM nut to connect a ground lug via a machine screw, care should be taken to limit the penetration of the outer skin by less than 1/4 in. Failure to do so may cause irreversible damage to the internal components of the switch.

Note: Before applying power to the grounded switch, you must use a volt meter to verify there is no voltage difference between the power supply's negative output terminal and the switch chassis grounding point.

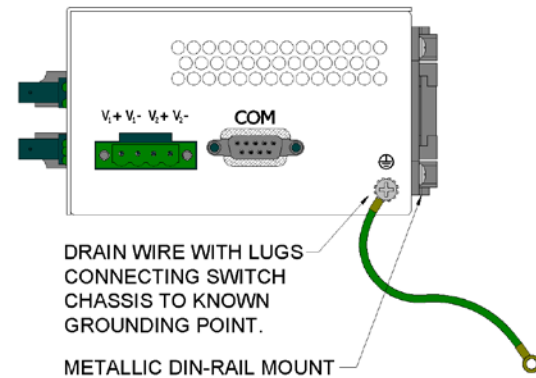

If the use of shielded cables is required, it is generally recommended to only connect the shield at one end to prevent ground loops and interfere with low level signals (i.e. thermocouples, RTD, etc.). Cat5e cables manufactured to EIA-568A or 568B specifications are required for use with N-Tron Switches.



In the event all Cat5e patch cable distances are small (i.e. All Ethernet devices are located the same local cabinet and/or referenced to the same earth ground), it is permissible to use fully shielded cables terminated to chassis ground at both ends in systems void of low level analog signals.

## RJ45 CONNECTOR CRIMP SPECIFICATIONS

Please reference the illustration below for your Cat5 cable specifications:

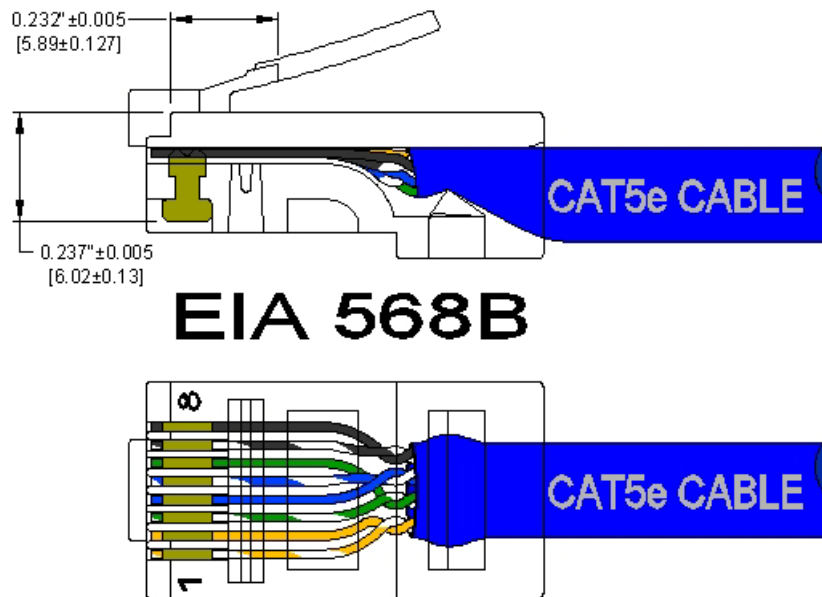

## CONNECTING THE UNIT

For 300 Series fiber units, remove the dust cap from the fiber optic connectors and connect the fiber optic cables. For Fiber Optic ports, the TX port on the near station should be connected to the RX port of the far end station, and the RX port should be connected to the TX port of the far end station.

For 10Base-T ports, plug a Category 3 (or greater) twisted pair cable into the RJ45 connector. For 100Base-T ports, plug a Category 5 (or greater) twisted pair cable into the RJ45 connector. Connect the other end to the far end station. Verify that the LNK LED's are ON once the connection has been completed. To connect any other port to another Switch or Repeater, use a standard Cat5 straight through or crossover cable.

**Warning:** Creating a port to port connection on the same switch (i.e. loop) is an illegal operation and will create a broadcast storm which will crash the network!

**Note:** For units which have the **N-View Option**, you can validate that all ports are working correctly by installing the N-View OPC Server software. The software is freely distributed on the ProductCD and our website (<http://www.n-tron.com/html/opc.html>). Once the software is installed, you should view the Ports Counter page to remotely monitor each connected port. You may find it helpful to copy [Alt]+[Print Screen] the Port Counter information for each port and paste [Control]+[V] into a Windows document for further review. Please consult your N-View OPC Server Manual for additional information.

## TROUBLESHOOTING

1. Make sure the  (Power LED) is ON.
2. Verify that Link LED's are ON for connected ports.
3. Verify cabling used between stations.
4. Verify that cabling is Category 5 (or greater) for 100Mbit Operation.
5. Verify TX is connected to far end RX and vice versa (fiber optic units only).

## SUPPORT

Contact N-TRON Corp. at:

TEL: 251-342-2164

FAX: 251-342-6353

[www.n-tron.com](http://www.n-tron.com)

[N-TRON\\_Support@n-tron.com](mailto:N-TRON_Support@n-tron.com)

## FCC STATEMENT

This product complies with Part 15 of the FCC-A Rules.

Operation is subject to the following conditions:

- (1) This device may not cause harmful Interference
- (2) This device must accept any interference received, including interference that may cause undesired operation.

## KEY SPECIFICATIONS

<b>Physical</b>	<b><u>302MC</u></b>	<b><u>304TX</u></b>	<b><u>305FX</u></b>	<b><u>306FX2</u></b>	<b><u>306TX</u></b>	<b><u>308TX</u></b>
<i>Height:</i>	2.97"	3.06"	3.46"	3.46"	3.06"	3.46"
<i>Width:</i>	2.01"	2.01"	2.01"	2.01"	2.01"	2.01"
<i>Depth:</i>	3.17"	3.38"	3.38"	3.38"	3.39"	3.38"
<i>Weight:</i>	0.75 lbs	0.75 lbs	0.75 lbs	0.75 lbs	0.75 lbs	0.75 lbs

### Electrical

<i>Input Voltage:</i>	10-30 VDC (Regulated)
<i>Input Current:</i>	230mA max. @ 24VDC (Steady State)
<i>Inrush Current:</i>	9.0Amp/0.5 ms max. @ 24VDC
<i>Input Ripple:</i>	Less than 100 mV
<i>Input Wire Size:</i>	6-28 AWG

### Environmental

<i>Operating Temperature:</i>	-20°C to 70°C
<i>Storage Temperature:</i>	-20°C to 85°C
<i>Operating Humidity:</i>	10% to 90% (Non Condensing)
<i>Operating Altitude:</i>	0 to 10,000 ft.

### Network Media

<i>10BaseT:</i>	> Cat-3 Cable
<i>100BaseT:</i>	> Cat-5 Cable
<i>100BaseFX:</i>	Multimode: 50-62.5/125µm Fiber Singlemode: 7-10/125µm Fiber

### Fiber Transceiver Characteristics

Fiber Length:	2km*	15km**	40km**	80km**
TX Power Min/Max	-19dBm/-14dBm	-15dBm/-7dBm	-5dBm/0dBm	-5dBm/0dBm
RX Sensitivity Max:	-32dBm	-34dBm	-34dBm	-34dBm
Wavelength:	1310nm	1310nm	1310nm	1550nm

\*=Multimode \*\* =Singlemode

### Connectors

10/100BaseT:	RJ45 UTP Ports
100BaseFX:	SC or ST Duplex Port(s) (if equipped)

### Recommended Minimum Wiring Clearance:

<i>Front:</i>	2" (5.08 cm) for 304TX, 306TX, & 308TX models 5" (12.7 cm) for 302MC, 305FX, & 306FX2 models
<i>Side:</i>	1" (2.54 cm)

## **Regulatory Approvals**

**Safety:** Listed as UL 1604 (US and Canada) Hazardous Locations, Class I, Div 2, Groups A, B, C, D, T4A

**EMI:** EN61000-6-4, EN55011 - Class A  
FCC Title 47, Part 15, Subpart B - Class A

**EMS:** EN61000-6-2  
EN61000-4-2 (ESD)  
EN61000-4-3 (RS)  
EN61000-4-4 (EFT)  
EN61000-4-5 (Surge)  
EN61000-4-6 (Conducted Disturbances)

**Conducted Low Frequency:** IEC60533

**Shock:** IEEE 1613 (250 mm)  
**Vibration:** IEEE 1613 (V.S.4 150mm/s)  
IEC60068-2-6 (Test Fc)  
**Cold:** IEC60068-2-1  
**Dry Heat:** IEC60068-2-2  
**Damp Heat:** IEC60068-2-30 (Test Db)

**GOST- R Certified.**

**Warranty:** Effective January 1, 2008, all N-TRON products carry a 3 year limited warranty from the date of purchase.

## **N-TRON Limited Warranty**

N-TRON, Corp. warrants to the end user that this hardware product will be free from defects in workmanship and materials, under normal use and service, for the applicable warranty period from the date of purchase from N-TRON or its authorized reseller. If a product does not operate as warranted during the applicable warranty period, N-TRON shall, at its option and expense, repair the defective product or part, deliver to customer an equivalent product or part to replace the defective item, or refund to customer the purchase price paid for the defective product. All products that are replaced will become the property of N-TRON. Replacement products may be new or reconditioned. Any replaced or repaired product or part has a ninety (90) day warranty or the remainder of the initial warranty period, whichever is longer. N-TRON shall not be responsible for any custom software or firmware, configuration information, or memory data of customer contained in, stored on, or integrated with any products returned to N-TRON pursuant to any warranty.

**OBTAINING WARRANTY SERVICE:** Customer must contact N-TRON within the applicable warranty period to obtain warranty service authorization. Dated proof of purchase from N-TRON or its authorized reseller may be required. Products returned to N-TRON must be pre-authorized by N-TRON with a Return Material Authorization (RMA) number marked on the outside of the package, and sent prepaid and packaged appropriately for safe shipment. Responsibility for loss or damage does not transfer to N-TRON until the returned item is received by N-TRON. The repaired or replaced item will be shipped to the customer, at N-TRON's expense, not later than thirty (30) days after N-TRON receives the product. N-TRON shall not be responsible for any software, firmware, information, or memory data of customer contained in, stored on, or integrated with any products returned to N-TRON for repair, whether under warranty or not.

**ADVANCE REPLACEMENT OPTION:** Upon registration, this product qualifies for advance replacement. A replacement product will be shipped within three (3) days after verification by N-TRON that the product is considered defective. The shipment of advance replacement products is subject to local legal requirements and may not be available in all locations. When an advance replacement is provided and customer fails to return the original product to N-TRON within fifteen (15) days after shipment of the replacement, N-TRON will charge customer for the replacement product, at list price.

**WARRANTIES EXCLUSIVE:** IF AN N-TRON PRODUCT DOES NOT OPERATE AS WARRANTED ABOVE, CUSTOMER'S SOLE REMEDY FOR BREACH OF THAT WARRANTY SHALL BE REPAIR, REPLACEMENT, OR REFUND OF THE PURCHASE PRICE PAID, AT N-TRON'S OPTION. TO THE FULL EXTENT ALLOWED BY LAW, THE FOREGOING WARRANTIES AND REMEDIES ARE EXCLUSIVE AND ARE IN LIEU OF ALL OTHER WARRANTIES, TERMS, OR CONDITIONS, EXPRESS OR IMPLIED, EITHER IN FACT OR BY OPERATION OF LAW, STATUTORY OR OTHERWISE, INCLUDING WARRANTIES, TERMS, OR CONDITIONS OF MERCHANTABILITY, FITNESS FOR A PARTICULAR PURPOSE, SATISFACTORY QUALITY, CORRESPONDENCE WITH DESCRIPTION, AND NON-INFRINGEMENT, ALL OF WHICH ARE EXPRESSLY DISCLAIMED. N-TRON NEITHER ASSUMES NOR AUTHORIZES ANY OTHER PERSON TO ASSUME FOR IT ANY OTHER LIABILITY IN CONNECTION WITH THE SALE, INSTALLATION, MAINTENANCE OR USE OF ITS PRODUCTS. N-TRON SHALL NOT BE LIABLE UNDER THIS WARRANTY IF ITS TESTING AND EXAMINATION DISCLOSE THAT THE ALLEGED DEFECT OR MALFUNCTION IN THE PRODUCT DOES NOT EXIST OR WAS CAUSED BY CUSTOMER'S OR ANY THIRD PERSON'S MISUSE, NEGLIGENCE, IMPROPER INSTALLATION OR TESTING, UNAUTHORIZED ATTEMPTS TO OPEN, REPAIR OR MODIFY THE PRODUCT, OR ANY OTHER CAUSE BEYOND THE RANGE OF THE INTENDED USE, OR BY ACCIDENT, FIRE, LIGHTNING, POWER CUTS OR OUTAGES, OTHER HAZARDS, OR ACTS OF GOD.

**LIMITATION OF LIABILITY:** TO THE FULL EXTENT ALLOWED BY LAW, N-TRON ALSO EXCLUDES FOR ITSELF AND ITS SUPPLIERS ANY LIABILITY, WHETHER BASED IN CONTRACT OR TORT (INCLUDING NEGLIGENCE), FOR INCIDENTAL, CONSEQUENTIAL, INDIRECT, SPECIAL, OR PUNITIVE DAMAGES OF ANY KIND, OR FOR LOSS OF REVENUE OR PROFITS, LOSS OF BUSINESS, LOSS OF INFORMATION OR DATA, OR OTHER FINANCIAL LOSS ARISING OUT OF OR IN CONNECTION WITH THE SALE, INSTALLATION, MAINTENANCE, USE, PERFORMANCE, FAILURE, OR INTERRUPTION OF ITS PRODUCTS, EVEN IF N-TRON OR ITS AUTHORIZED RESELLER HAS BEEN ADVISED OF THE POSSIBILITY OF SUCH DAMAGES, AND LIMITS ITS LIABILITY TO REPAIR, REPLACEMENT, OR REFUND OF THE PURCHASE PRICE PAID, AT N-TRON'S OPTION. THIS DISCLAIMER OF LIABILITY FOR DAMAGES WILL NOT BE AFFECTED IF ANY REMEDY PROVIDED HEREIN SHALL FAIL OF ITS ESSENTIAL PURPOSE.

**DISCLAIMER:** Some countries, states, or provinces do not allow the exclusion or limitation of implied warranties or the limitation of incidental or consequential damages for certain products supplied to consumers, or the limitation of liability for personal injury, so the above limitations and exclusions may be limited in their application to you. When the implied warranties are not allowed to be excluded in their entirety, they will be limited to the duration of the applicable written warranty. This warranty gives you specific legal rights which may vary depending on local law.

**GOVERNING LAW:** This Limited Warranty shall be governed by the laws of the State of Alabama, U.S.A.



## X-ON Electronics

Largest Supplier of Electrical and Electronic Components

*Click to view similar products for [Ethernet Modules](#) category:*

*Click to view products by [B+B SmartWorx](#) manufacturer:*

Other Similar products are found below :

[TDKEZW3](#) [V23993-USB1029A](#) [100-POE4](#) [I210T1BLK](#) [X520QDA1](#) [BCM84794A1KFSBG](#) [X520DA2OCP](#) [808-38157](#) [7506GX2](#) [TC](#)  
[EXTENDER 2001](#) [ETH-2S](#) [105FX-SC-MDR](#) [110FX2-SC](#) [7000-P3201-P050150](#) [750-1515](#) [750-494](#) [750-495](#) [750-497](#) [750-501](#) [750-612](#)  
[750-613](#) [750-627](#) [750-643](#) [750-940](#) [753-440](#) [753-540](#) [753-650/003-000](#) [852-1322](#) [852-1328](#) [852-1812](#) [852-1813](#) [852-1816](#) [LANTICK PE-](#)  
[0-16](#) [LANTICK PE-16-0](#) [RBMTXLITE-L4X2.X.X.X.X.](#) [USR-TCP232-T2](#) [2017008](#) [EKI-7708E-4F-AE](#) [EKI-7708E-4FP-AE](#) [EKI-7708G-](#)  
[4FP-AE](#) [2352903-2](#) [753-620](#) [EGU-0702-SFP-T](#) [EKI-2706G-1GFPI-BE](#) [SW-125](#) [SW-525](#) [SW-725](#) [7000-74712-4780030](#) [7000-74712-](#)  
[4780060](#) [7000-74712-4780100](#) [7000-74712-4780150](#)