

# Type 0AKM

## Electric Vehicle Auxiliary Fuses

0AKM Series

RoHS Compliant

### Description

500VDC rated ceramic tube fuse

### Features



- Design to EV fuse standard UL248-20
- Reliability performance design refer to ISO8820-8&GB/T31465.6
- Excellent DC performance
- Full compliance with EU Directive 2011/65/EU and amending directive 2015/863

### Applications

EV/HEV/ESS Applications

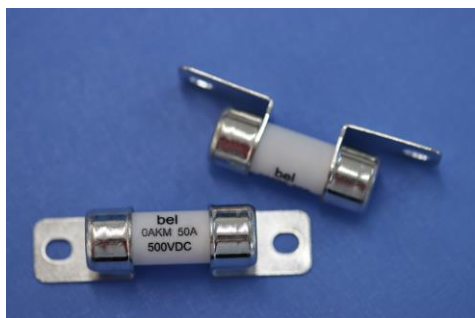
### Physical Specifications



Materials	Body : Ceramic
	Terminals : Tin Plated Copper
Marking	On Fuse :
	"bel", "0AKM"
	"Current Rating", "Voltage Rating"
	On Label :
	"bel", "0AKMX", "Current Rating", "Voltage Rating", "Interrupting Rating", and "  ", "  "(China RoHS compliant).

### Ratings

Ampere Rating / Voltage Rating	Ampere Range / Volt @ I.R. ability*
50A-80A / 500V DC	50A-80A / 500V @ 20kA DC
*I.R.= Interrupting Rating = Short Circuit Rating(Amps)	

## Temperature Derating Curve

Operating Temperature: -40°C to +125°C,  
with proper derating factor applied

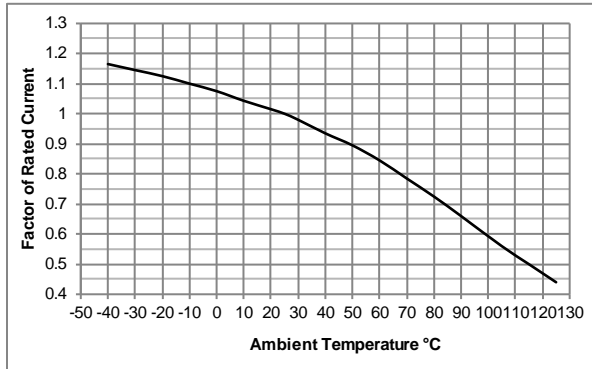

## Average Time Current Curve

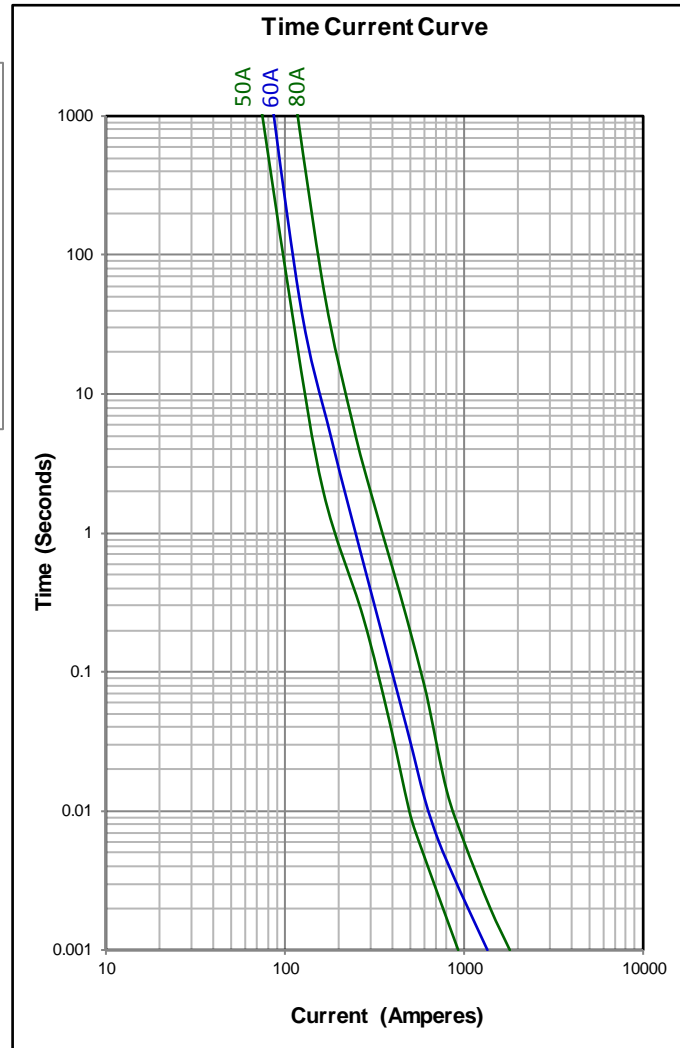

## Electrical Specifications

Part Number	Rated Current	Voltage and Interrupting Ratings	$I^2t$ *	Power Loss@0.5In (W)
			(A <sup>2</sup> sec) Pre-arcing	
0AKMx9500-xx	50A	See Table of Ratings on Page 1 for Voltage and associated Interrupting Ratings	1760	1.35
0AKMx9600-xx	60A		3960	1.70
0AKMx9800-xx	80A		8020	1.90

Consult manufacturer for other ratings  
\*  $I^2t$  is measured with 10In.

# Type 0AKM

## Fuse FGNO Explanation

0AKM X [XXXX] -XX

0AKMB=0AKMB; [XXXX]=Ampere Rating; XX=See Ordering Information as below

Amps	Bel FGNO[XXXX]
50A	9500
60A	9600
80A	9800

## Mechanical Dimensions

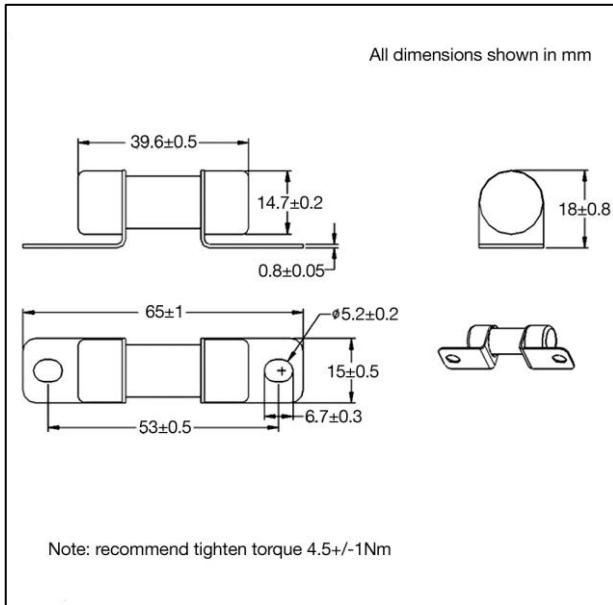

## Ordering Information

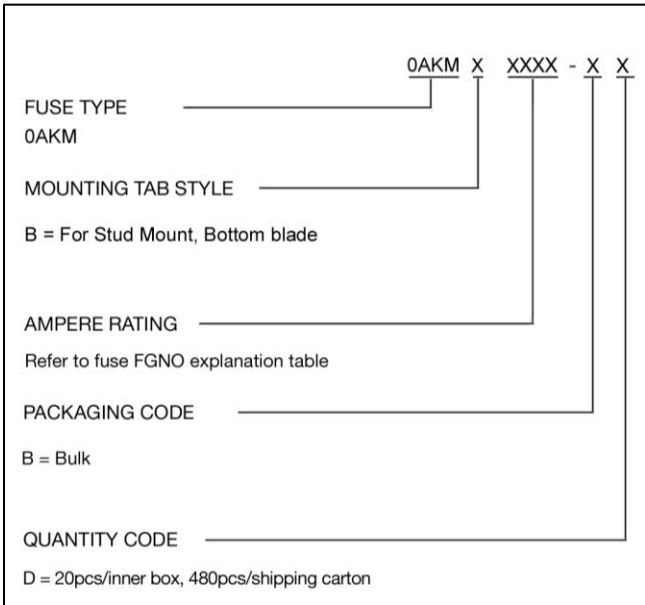

## Packaging

Packaging Option	Quantity	Packaging Code
Bulk	20pcs/inner box, 480pcs/shipping carton	BD

## X-ON Electronics

Largest Supplier of Electrical and Electronic Components

*Click to view similar products for [Automotive Fuses](#) category:*

*Click to view products by [Bel Fuse](#) manufacturer:*

Other Similar products are found below :

[ATM-4LP](#) [299080](#) [HBO-70](#) [0287015](#) [FMM-15](#) [0297003.WXT](#) [0695060.PXPS](#) [MRBF-075](#) [MRBF-300](#) [MRBF-200](#) [ANX80-UL-20A](#)  
[ANX80-UL-25A](#) [ANX80-UL-30A](#) [ANX80-UL-35A](#) [ANX80-UL-40A](#) [ANT-I-3A](#) [APM-I-25A](#) [APR-10A](#) [APR-25A](#) [ANX58-UL-20A](#)  
[ANX58-UL-25A](#) [ANX58-UL-35A](#) [ANX58-UL-40A](#) [ANX58-UL-50A](#) [ANM-4A](#) [ANM-25A](#) [ANE-175A](#) [APM-25A](#) [APM-4A](#) [ACB2-PL-](#)  
[15A](#) [ACB2-PL-25A](#) [ANM58-15A](#) [ANM58-5A](#) [FMX-LP-20A](#) [MIDA-50A](#) [0695040.PXP](#) [0327030.YX2T](#) [0298500.UX1M8](#) [0299070.ZXT](#)  
[20A32V](#) [ATM-1](#) [MRBF-040](#) [MRBF-100](#) [MRBF-250](#) [MRBF-050](#) [MRBF-060](#) [CFCOVER-2R](#) [MRBF-030](#) [3298600.ZXM10](#) [AMG-80](#)