

Type 0AKN

Electric Vehicle Power Fuses

0AKN Series

RoHS Compliant

Description

500VDC rated ceramic tube fuse

Features



- Design to EV fuse standard UL248-20
- Reliability performance design refer to ISO8820-8&GB/T31465.6
- Excellent DC performance
- Full compliance with EU Directive 2011/65/EU and amending directive 2015/863

Applications

EV/HEV/ESS Applications



Physical Specifications

Materials	Body : Ceramic
	Terminals : Tin Plated Copper
Marking	On Fuse :
	"bel", "0AKN"
	"Current Rating", "Voltage Rating"
	On Label :
	"bel", "0AKNX", "Current Rating", "Voltage Rating", "Interrupting Rating", and "  ", "  "(China RoHS compliant).

Ratings

Ampere Rating / Voltage Rating	Ampere Range / Volt @ I.R. ability*
100A-250A / 500V DC	100A-250A / 500V @ 50kA DC
*I.R.= Interrupting Rating = Short Circuit Rating(Amps)	

Temperature Derating Curve

Operating Temperature: -40°C to +125°C, with proper derating factor applied

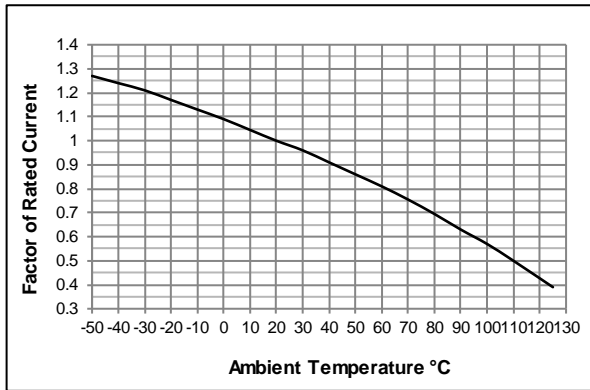

Re-rating with High altitude

The high altitude load calculation formula is:
 $I = I_n * (1 - (h-2000)/100 * (0.5/100))$,
 where h is an elevation, not more than 5000

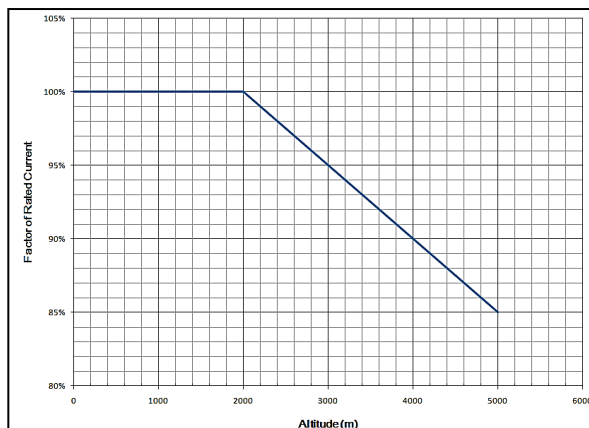

Average Time Current Curve

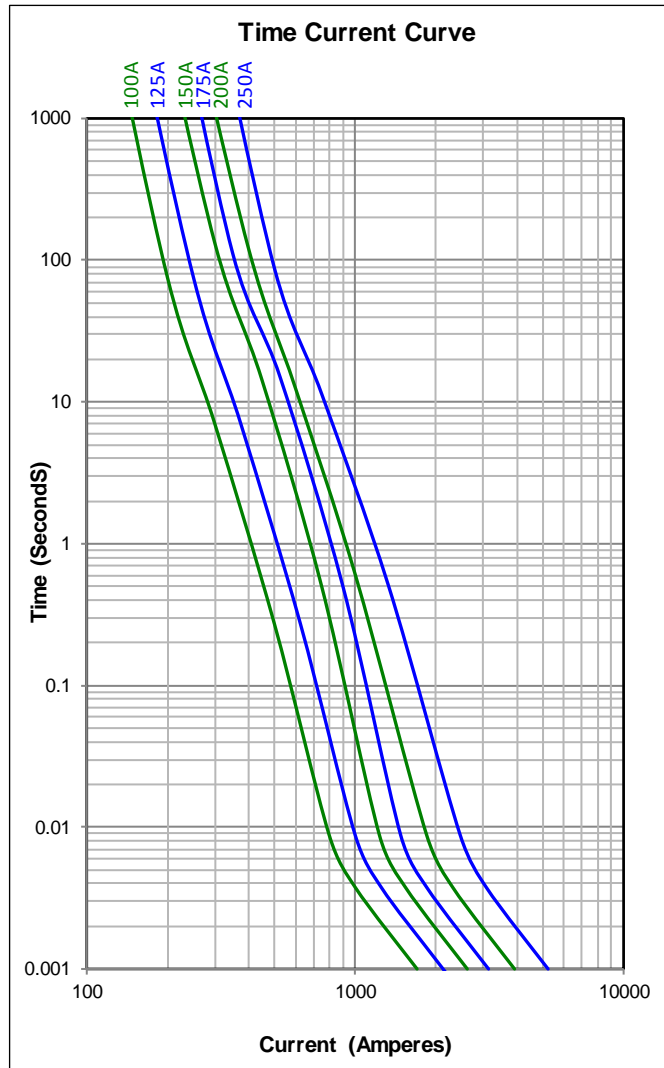

Electrical Specifications

Part Number	Rated Current	Voltage and Interrupting Ratings	I2t (A2sec)		Power Loss (W)
			Pre-arcing	Total @ 500Vdc	
0AKNxK100-xx	100A	See Table of Ratings on Page 1 for Voltage and associated Interrupting Ratings	1770	7020	14.9
0AKNxK125-xx	125A		2850	11500	19.3
0AKNxK150-xx	150A		4150	15770	23.1
0AKNxK175-xx	175A		5970	22850	27.5
0AKNxK200-xx	200A		9350	36500	30.8
0AKNxK250-xx	250A		16600	67800	35.2

Consult manufacturer for other ratings



Specifications subject to change without notice

Bel Fuse Inc.
 206 Van Vorst Street
 Jersey City, NJ 07302 USA

+1 201.432.0463
 Bel.US.CS@belf.com
belfuse.com/circuit-protection

Fuse FGNO Explanation

0AKN X [XXXX] -XX

0AKNB=0AKNB; [XXXX]=Ampere Rating; XX=See Ordering Information as below

Amps	Bel FGNO[XXXX]
100A	K100
125A	K125
150A	K150
175A	K175
200A	K200
250A	K250

Mechanical Dimensions

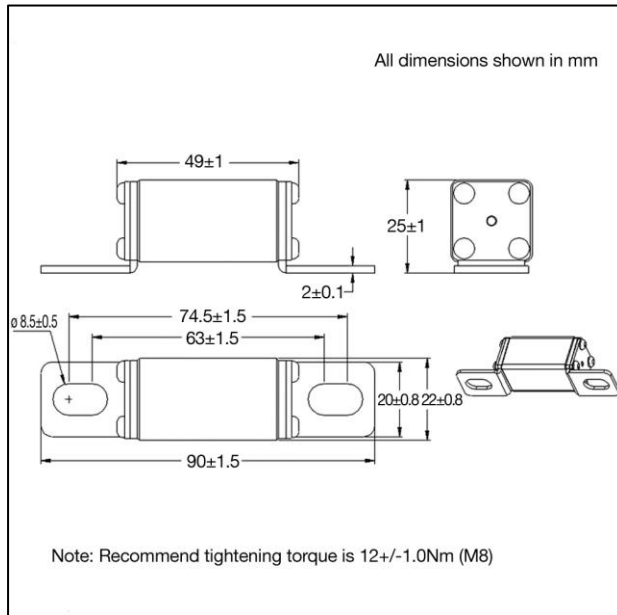

Ordering Information

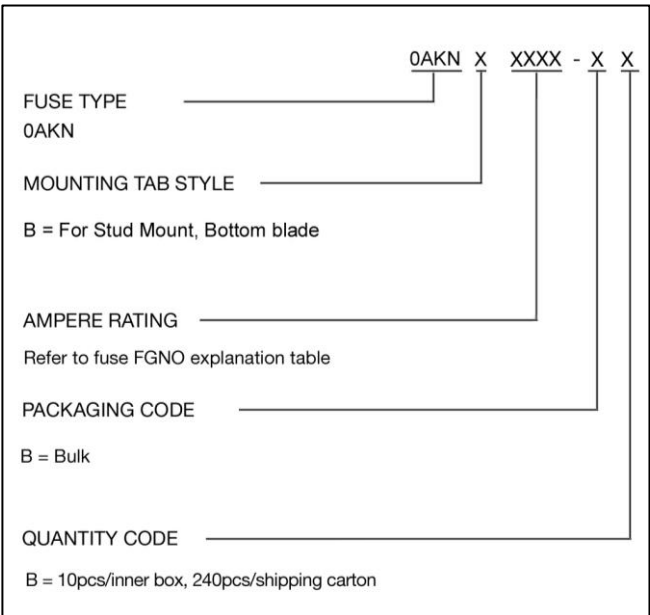

Packaging

Packaging Option	Quantity	Packaging Code
Bulk	10pcs/inner box, 240pcs/shipping carton	BB

X-ON Electronics

Largest Supplier of Electrical and Electronic Components

Click to view similar products for [Automotive Fuses](#) category:

Click to view products by [Bel Fuse](#) manufacturer:

Other Similar products are found below :

[AFX-150](#) [AT-10](#) [AT-30](#) [AT-5](#) [ATM-4LP](#) [299080](#) [AT-20](#) [AT-3](#) [0287015](#) [142.7010.5502](#) [0MIN015.HXGLO](#) [0695030.PXPS](#)
[0695040.PXPS](#) [0297003.WXT](#) [0MIN025.HXGLO](#) [0MIN030.HXGLO](#) [0695025.PXPS](#) [0695015.PXPS](#) [0695050.PXPS](#) [0695060.PXPS](#)
[MRBF-075](#) [MRBF-300](#) [ACBP-12-V-35A](#) [ACBP-V-40C](#) [ANT-I-3A](#) [ANE-175A](#) [253080](#) [253100](#) [ACB-12-H-50A](#) [ACB-24-V-25A](#) [ACB2-](#)
[PL-25A](#) [353150](#) [153050](#) [153090](#) [153200](#) [353100](#) [MIDA-50A](#) [142.7010.5302](#) [LMIN015.ZXPROA](#) [0695040.PXP](#) [0327030.YX2T](#)
[0299040.ZXT](#) [142.7010.6102](#) [LMIN020.ZXPROA](#) [0298500.UX1M8](#) [0299070.ZXT](#) [02400106P](#) [0297002.WXT](#) [0297004.WXT](#)
[0297010.WXT](#)