



Type 0AMA

3x8.4mm Fast-acting Fuses for hazardous applications

0AMA Series

RoHS Compliant

Description

250V AC/DC rated ceramic tube fuse

Features

- designed for barrier circuits in intrinsic safety applications relating to Hazardous Locations
- Meets electrical performance specifications for intrinsically safe(EN60079-11) applications
- Fast-acting, high interrupting rating of 4000A at 250Vac/dc
- Available in both axial lead and surface mount
- Full compliance with EU Directive 2011/65/EU and amending directive 2015/863
- Halogen Free



Applications

- Hazardous Locations and Environments
- Intrinsically safe network barriers
- Electrical connections and components
- Test equipment
- Petrochemical processing and refining equipment
- Pulp and paper processing equipment



HALOGEN FREE = **HF**

Physical Specifications

Materials	Body : Ceramic
	Terminals : Silver plated brass
Marking	On Fuse :
	"Color coding for Current Rating",
	On Label :
	"bel", "0AMA", "Current Rating", "Voltage Rating", "Interrupting Rating", "Appropriate Safety Logos" and "  ", "  "(China RoHS compliant).

Ratings

Safety Agency	Safety Agency Certificate	Ampere Rating / Voltage Rating	Ampere Range / Volt @ I.R. ability*
	E491441	40mA-250mA/250V DC 250V AC	40mA-250mA/250V @ 4kA DC 250V @ 4KA AC
*I.R.= Interrupting Rating = Short Circuit Rating(Amps)			

Temperature Derating Curve

Operating Temperature: -55°C to +125°C,
with proper derating factor applied

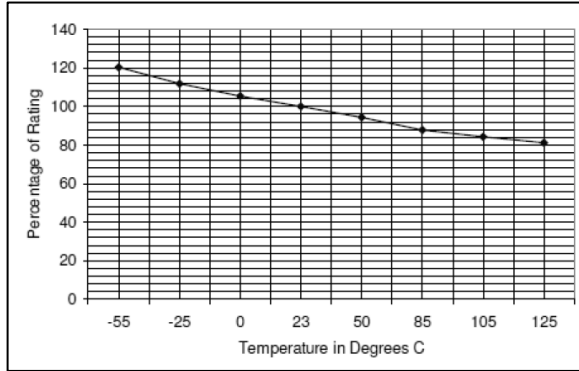

Average Time Current Curve

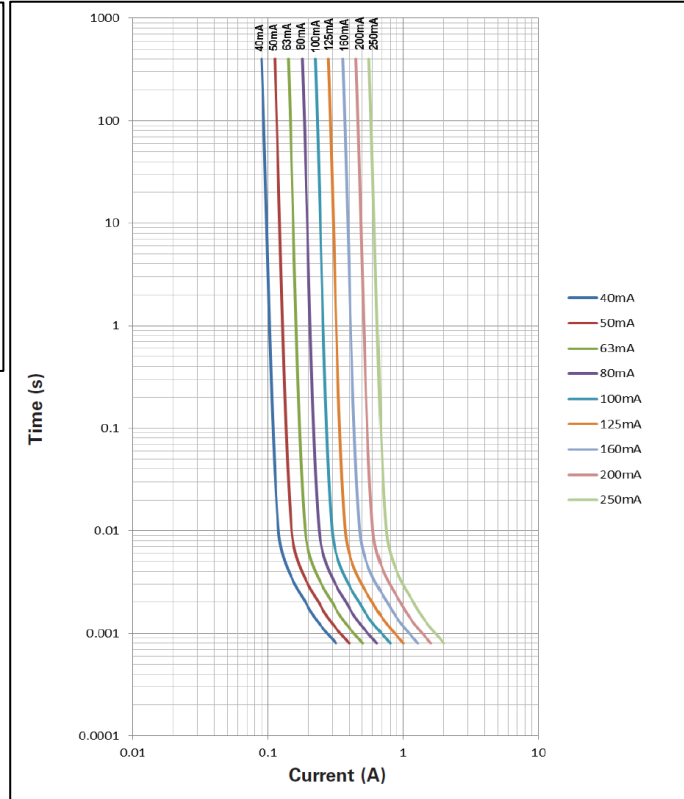

Electrical Specifications

Part Number	Rated Current	Voltage and Interrupting Ratings	Typical Cold Resistance (Ω)	I ² t * (A ² sec)	color coding	Agency Approvals
				Pre-arcing		
0AMA-0040-TD	40mA	See Table of Ratings on Page 1 for Voltage and associated Interrupting Ratings	14.2	0.00006	Grey	Y
0AMA-0050-TD	50mA		9.40	0.00010	Red	Y
0AMA-0063-TD	63mA		8.80	0.00012	Pink	Y
0AMA-0080-TD	80mA		5.10	0.00018	Green	Y
0AMA-0100-TD	100mA		2.87	0.00087	Yellow	Y
0AMA-0125-TD	125mA		2.20	0.00134	Orange	Y
0AMA-0160-TD	160mA		2.05	0.00166	Violet	Y
0AMA-0200-TD	200mA		1.01	0.00237	Brown	Y
0AMA-0250-TD	250mA		0.71	0.00530	Black	Y

Consult manufacturer for other ratings
* I²t is measured with 10In.



Specifications subject to change without notice

Bel Fuse Inc.
206 Van Vorst Street
Jersey City, NJ 07302 USA

+1 201.432.0463
Bel.US.CS@belf.com
belfuse.com/circuit-protection

Soldering Parameters

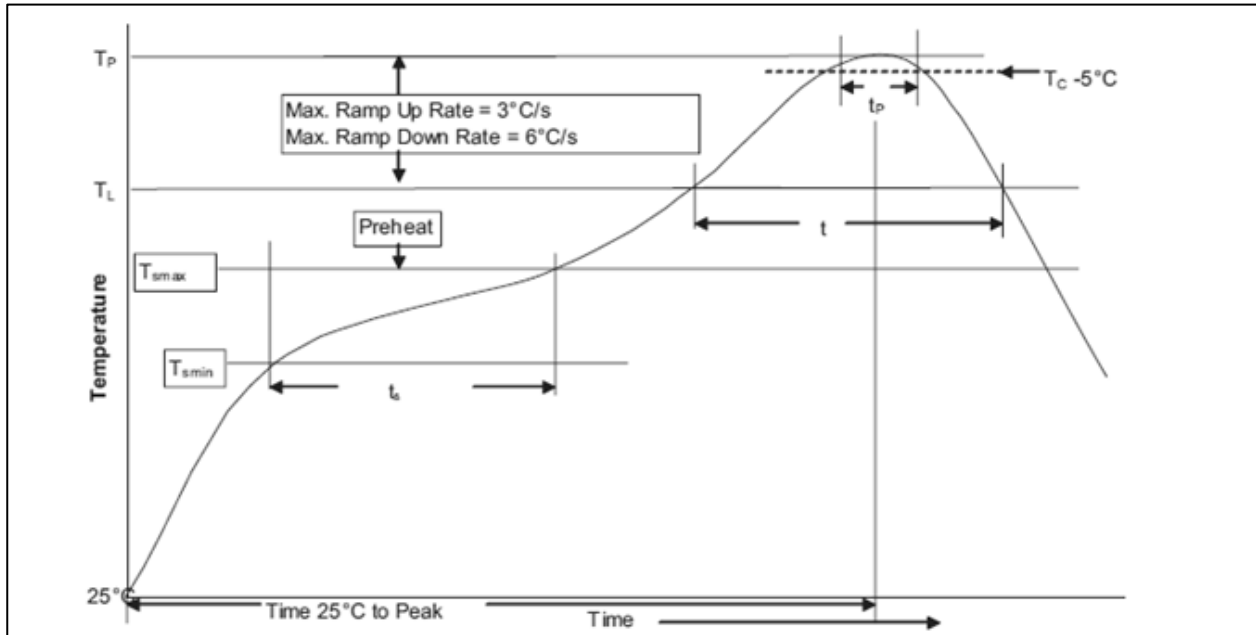

Profile Feature	Lead(Pb) free solder
Preheat and soak	
<ul style="list-style-type: none"> • Temperature min. (T_{smin}) • Temperature max. (T_{smax}) • Time (T_{smin} to T_{smax}) (ts) 	150°C 200°C 60 - 120 Seconds
Average ramp up rate T_{smax} to T_p	3°C / Second Max.
Liquidous temperature (T_L)	217°C
Time at liquidous (t_L)	60 - 150 Seconds
Peak package body temperature (T_p)	260°C
Time (t_p) within 5°C of the specified classification temperature (T_c)	30 Seconds
Average ramp-down rate (T_p to T_{smax})	6°C / Second Max.
Time (25°C to Peak Temperature)	8 Minutes Max.

Type 0AMA

Fuse FGNO Explanation

0AMA - [XXXX] -TD

0AMA=0AMA; [XXXX]=Ampere Rating; TD=See Ordering Information as below

Amps	Bel FGNO[XXXX]
40mA	0040
50mA	0050
63mA	0063
80mA	0080
100mA	0100
125mA	0125
160mA	0160
200mA	0200
250mA	0250

Mechanical Dimensions

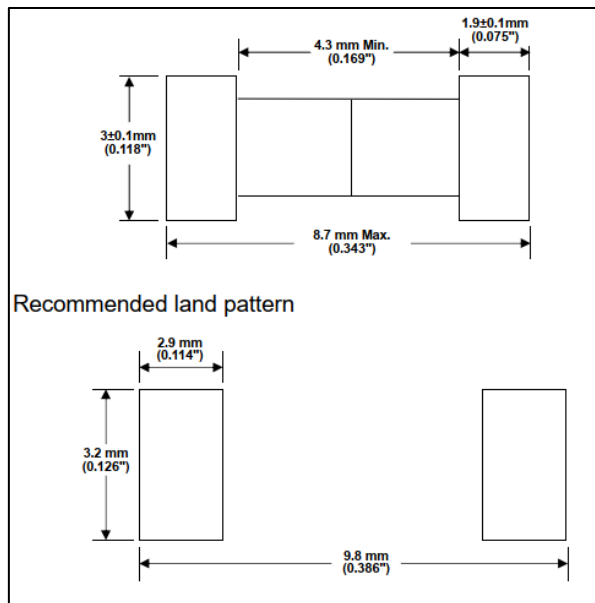

Ordering Information

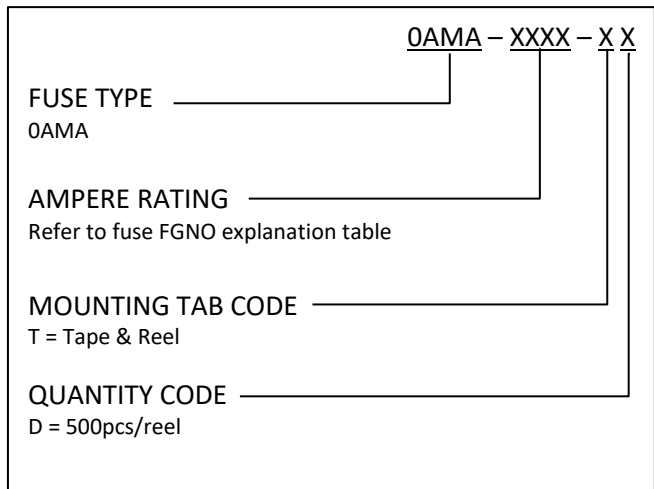

Packaging

Packaging Option	Quantity	Packaging Code
Tape (width 24mm) and reel (dia. 13inch)	500	TD



Specifications subject to change without notice

Bel Fuse Inc.
206 Van Vorst Street
Jersey City, NJ 07302 USA

+1 201.432.0463
Bel.US.CS@belf.com
belfuse.com/circuit-protection

X-ON Electronics

Largest Supplier of Electrical and Electronic Components

Click to view similar products for [Cartridge Fuses](#) category:

Click to view products by [Bel Fuse](#) manufacturer:

Other Similar products are found below :

[MBO-20](#) [MDM-4/10](#) [MDQ-V-15/100](#) [MDX-1-6/10](#) [MDX-2](#) [MDX-3-2/10](#) [MDX-6-1/4](#) [FLSR-15](#) [FLSR-30](#) [FRS-1-6/10](#) [FRS-4/10](#) [H362003](#)
[ABC-2](#) [1/2A](#) [12C10X38GI](#) [AGC-15EX](#) [AGC-V-3-12-R](#) [AGY-50](#) [15019-G](#) [MSL-1-1/2](#) [MSL-3](#) [MSL-5](#) [BK1/C436-2A](#) [BK1GMD-4-R](#)
[BK1-S501-3-15-R](#) [BK/C515S-250-R](#) [S501-V-10A](#) [301030](#) [303030](#) [FLA10](#) [FLA-4/10](#) [FLNR-5](#) [20.0M6.3X32F](#) [301001](#) [301020](#) [311008](#)
[31301.5H-XP](#) [313.25](#) [313.75](#) [334006](#) [361.250](#) [362001](#) [36201.5](#) [36202.5](#) [362.500](#) [3AG3](#) [3AG5](#) [3AG8](#) [TF16SN0.63TTD](#) [MDM-1-6/10](#)