

0RQB-50Y24x

Isolated DC-DC Converter

The 0RQB-50Y24x is an isolated DC/DC converter providing 50 W of output power from a wide input range (24 / 48 / 72 / 96 / 110 V typical). Standard features include remote on/off, input under-voltage protection, output over-voltage protection, over current and short circuit protection.

This converter can also provide a 5 V / 5 mA auxiliary supply. When a large hold-up capacitor is added, the converter can still work up to 10 ms when the input supply is interrupted.

Conformal coated PCB is used for environmental ruggedness.



Key Features & Benefits

- 24/48/72/96/110 VDC Input
- 24 VDC @ 2.1 A Output
- Reinforced Isolation
- High Efficiency
- Hold-Up Function
- Remote ON/OFF
- Conformal Coated
- Input Under-Voltage Lockout
- Input Under-Voltage Protection
- Output Over-Voltage Protection
- Over Current and Short Circuit Protection
- 5V Auxiliary Supply at Primary Side
- Wide Input Range (24 V, 48 V, 72 V, 96 V, 110 V typical)
- Approved to IEC/EN 62368-1
- Approved to CSA/UL 62368-1
- Class II, Category 2, Isolated DC/DC Converter (refer to IPC-9592B)

Applications

- Industrial
- Railways

1. MODEL SELECTION

MODEL NUMBER	OUTPUT VOLTAGE	INPUT VOLTAGE	MAX. OUTPUT CURRENT	MAX. OUTPUT POWER	TYPICAL EFFICIENCY
0RQB-50Y24x	24 VDC	24/48/72/96/110 VDC	2.1 A	50 W	88% @ 110 V

NOTE: Add "G" suffix at the end of the model number to indicate packaging.

PART NUMBER EXPLANATION

0	R	QB	-	50	Y	24	x	G
Mounting Type	RoHS Status	Series Name		Output Power	Input Range	Output Voltage	Active Logic	Package Type
Through hole mount	RoHS	1/4th Brick		50 W	14.4-154 V	24 V	L- Active low, with baseplate 0- Active high, with baseplate F- Active low, with flange E- Active high, with flange	G - Tray package

2. ABSOLUTE MAXIMUM RATINGS

PARAMETER	DESCRIPTION	MIN	TYP	MAX	UNITS
Continuous non-operating Input Voltage		-0.5	-	200	V
Remote On/Off		-0.3	-	15	V
Operating Temperature	Hot spot temperature, see Thermal Derating Curves section	-40	-	105	°C
Storage Temperature		-55	-	125	°C
Altitude		-	-	5000	m

NOTE: Ratings used beyond the maximum ratings may cause a reliability degradation of the converter or may permanently damage the device.

3. INPUT SPECIFICATIONS

All specifications are typical at 25°C unless otherwise stated.

PARAMETER	DESCRIPTION	MIN	TYP	MAX	UNIT
Operating Input Voltage 1	Fully functioning for long term operation.		24		
			48		
		14.4	72	154	V
			96		
			110		
Operating Input Voltage 2	Fully functioning for 0.1 s operation. Full function is not guaranteed but undamaged for 1 s operation.	12.9	-	14.4	V
		154	-	200	V
Input Voltage Rising Slope		-	-	2	V/ms
Input Current (full load)		-	-	4.5	A
Input Current (no load)	Vin = 48 V	-	130	170	mA
	Vin = 110 V	-	25	40	mA
Remote Off Input Current		-	-	40	mA
Input Reflected Ripple Current (rms)	With simulated source impedance of 1 μ H, 5 Hz to 20 MHz. Use a 100 μ F / 250 V electrolytic capacitor with ESR = 1 ohm max, at 200 kHz @ 25°C.	-	-	150	mA
Input Reflected Ripple Current (pk-pk)		-	-	500	mA
Turn-on Voltage Threshold		12.5	13.5	14.4	V
Turn-off Voltage Threshold		11	12	12.9	V
Over-voltage Recovery Threshold		156	160	164	V
Over-voltage Shutdown Threshold		162	165	168	V
Input L/C	Inner inductance	-	3.3	-	μ H
	Inner capacitance, Ctotal	-	2.7	-	μ F
Input Capacitance	Outside capacitance, typically electrolytic capacitors.	100	-	-	μ F
Recommended input fast-acting fuse on system board	CAUTION: This converter is not internally fused. An input line fuse must be used in application.	-	15	-	A

4. OUTPUT SPECIFICATIONS

All specifications are typical at nominal input, full load at 25°C unless otherwise stated.

PARAMETER	DESCRIPTION	MIN	TYP	MAX	UNIT
Output Voltage Set Point		23.8	24	24.2	V
Load Regulation		-	-	50	mV
Line Regulation		-	-	50	mV
Regulation Over Temperature		-	-	± 100	mV
Output Ripple and Noise (Pk-Pk)	With a 100 µF ceramic and a 100 µF electrolytic capacitors at output.	-	50	100	mV
Output Ripple and Noise (RMS)		-	10	15	mV
Output Current Range		0	-	2.02	A
Output DC Current Limit	Enter a hiccup mode, non-latching.	2.2	-	3.5	A
Rise Time		-	-	150	ms
Start-up Time	Start up from Vin	-	-	1500	ms
	Start up from remote on/off	-	-	200	ms
Overshoot at Turn on		-	0	3	%
Output Capacitance	Typically, 50% ceramic and 50% electrolytic capacitors.	200	-	1000	µF
5V Auxiliary Supply Source Current		-	-	5	mA
<i>Transient Response</i>					
ΔV 50%~75% of Max Load		-	500	720	mV
Settling Time	di/dt = 0.1 A/µs, with a 100 µF ceramic and a 100 µF electrolytic capacitors near the brick output.	-	0.5	1	ms
ΔV 75%~50% of Max Load		-	500	720	mV
Settling Time		-	0.5	1	ms

5. GENERAL SPECIFICATIONS

PARAMETER	DESCRIPTION	MIN	TYP	MAX	UNIT
Efficiency	Vin = 24 V, Iout = 2.02 A at 25°C	-	84	-	%
	Vin = 48 V, Iout = 2.02 A at 25°C	-	86	-	%
	Vin = 110 V, Iout = 2.02 A at 25°C	-	88	-	%
Switching Frequency	1st stage	-	150	-	kHz
	2nd stage	-	250	-	kHz
Over Temperature Protection		-	125	-	°C
Over Voltage Protection (Static)	Enter a latching, non-hiccup mode	-	28	-	V
FIT	Calculated Per Bell Core SR-332	-	173	-	-
MTBF	(Vin = 48 V, Vo = 24 V, Io = 2.02 A, Ta = 40°C, FIT=10 ⁹ /MTBF)	-	4.5	-	Mhrs
Weight	Baseplate version	-	62	-	g
	Flange version	-	71	-	g
Dimensions (L x W x H)	Baseplate version	2.30 x 1.45 x 0.59			inch
		58.42 x 36.83 x 15.00			mm
	Flange version	2.386 x 2.20 x 0.59			inch
		60.60 x 55.88 x 15.00			mm
Isolation Characteristics					
Input to Output		-	-	3000	Vdc
Input to Heatsink		-	-	3000	Vdc
Output to Heatsink		-	-	3000	Vdc
Isolation Resistance	Test with 500 VDC	100M	-	-	Ohm
Isolation Capacitance		-	-	2200	pF

6. EFFICIENCY DATA

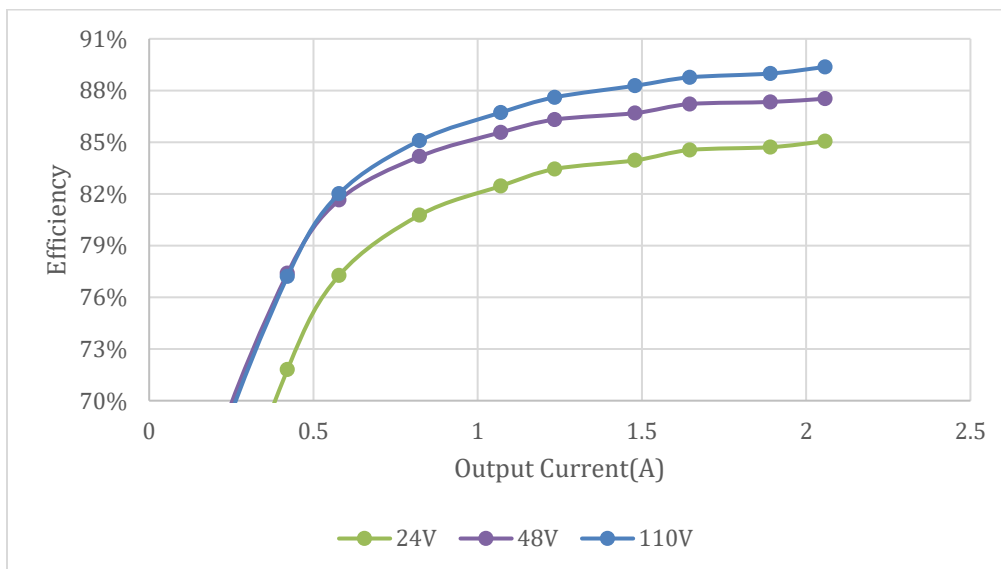

Figure 1. Efficiency data



Asia-Pacific
+86 755 298 85888

Europe, Middle East
+353 61 225 977

North America
+1 408 785 5200

7. REMOTE ON/OFF

PARAMETER		DESCRIPTION	MIN	TYP	MAX	UNIT
Signal Low (Unit On)	Active Low	Remote On/Off pin is open, the module is off	-0.3	-	0.8	V
Signal High (Unit Off)			2.4	-	15	V
Signal Low (Unit Off)	Active High	Remote On/Off pin is open, the module is on	-0.3	-	0.8	V
Signal High (Unit On)			2.4	-	15	V
Current Sink			0	-	1	mA

Recommended remote on/off circuit for active low

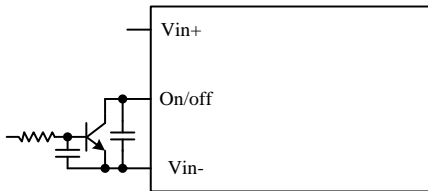

Figure 2. Control with open collector/drain circuit

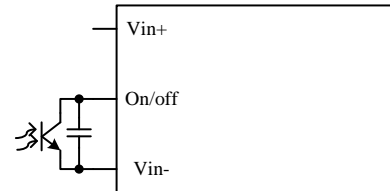

Figure 3. Control with photocoupler circuit

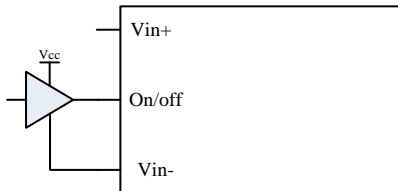

Figure 4. Control with logic circuit

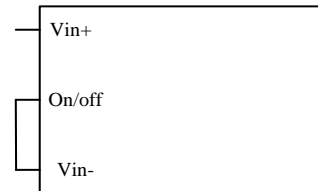

Figure 5. Permanently on

Recommended remote on/off circuit for active high

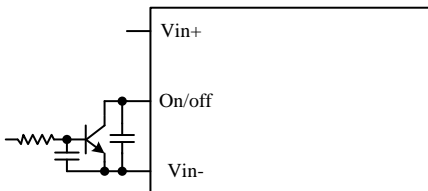

Figure 6. Control with open collector/drain circuit

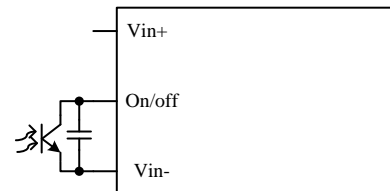

Figure 7. Control with photocoupler circuit

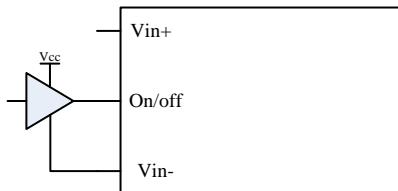

Figure 8. Control with logic circuit

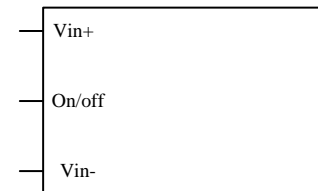

Figure 9. Permanently on

8. INPUT NOISE

Input reflected ripple current

Testing setup:

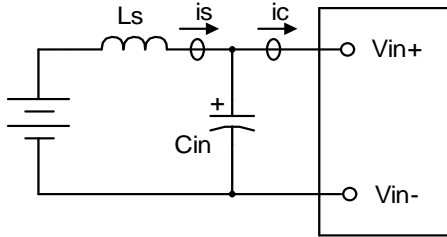

Figure 10.

Notes and values in testing.

is: Input Reflected Ripple Current

ic: Input Terminal Ripple Current

Ls: Simulated Source Impedance (1 μ H)

Cin: Electrolytic capacitor, should be as closed as possible to the power module to damped ic ripple current and enhance stability.

Recommendation: 2* 100 μ F, ESR<0.5R @ 100 kHz, 20°C

Below measured waveforms are based on above simulated and recommended inductance and capacitance

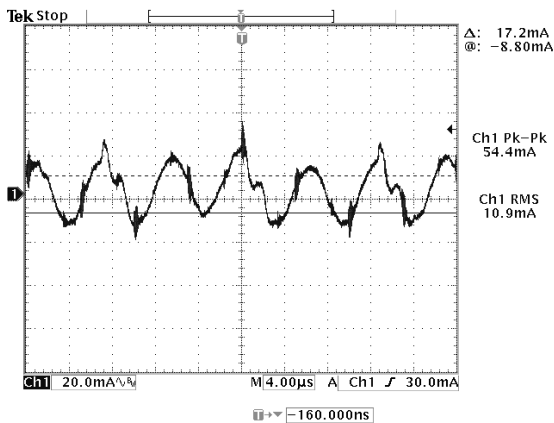

Figure 11. is (input reflected ripple current), AC component

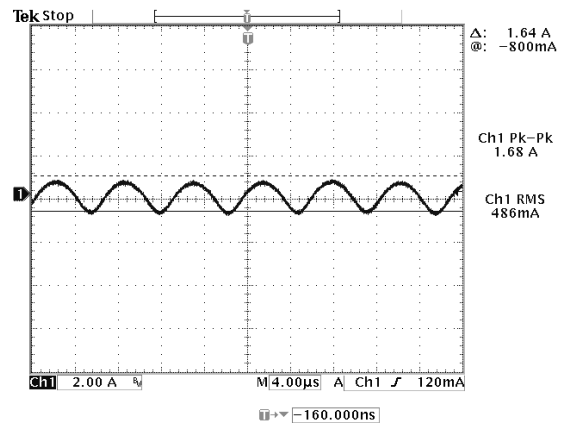

Figure 12. ic (input terminal ripple current), AC component

Test condition: 48Vdc input, 24Vdc/2.1A output and Ta=25 deg C, with 200 μ F capacitor at output

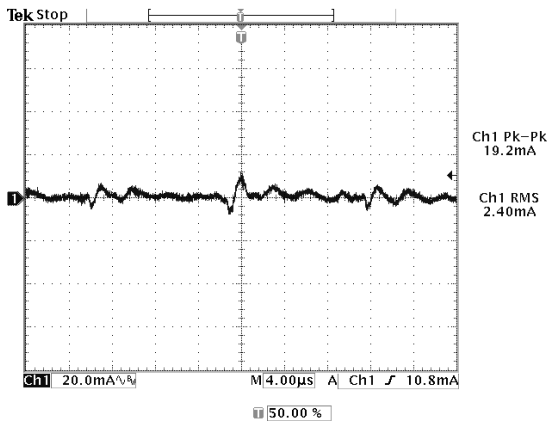

Figure 13. is (input reflected ripple current), AC component

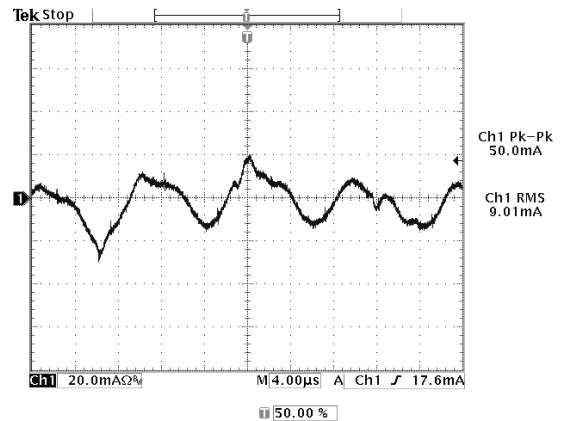

Figure 14. ic (input terminal ripple current), AC component

Test condition: 110Vdc input, 24Vdc/2.1A output and Ta=25 deg C, with 200 μ F capacitor at output

9. RIPPLE AND NOISE

Testing setup

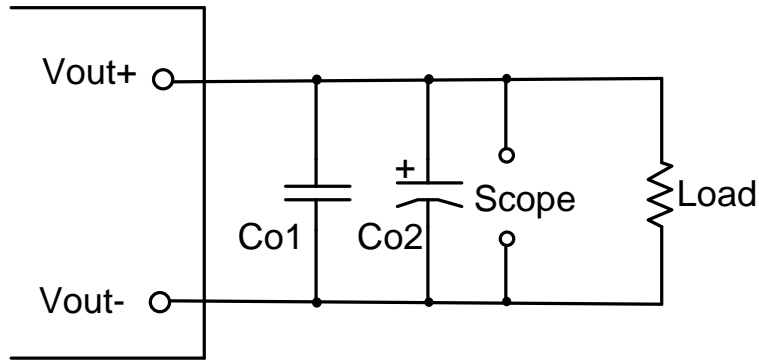

Figure 15.

Notes and values in testing.

Co1: 100uF ceramic capacitor

Co2: 100uF POSCAP capacitor

The capacitor should be as close as possible to the power module to swallow ripple current and help with stability.

Below measured waveforms are based on above capacitance.

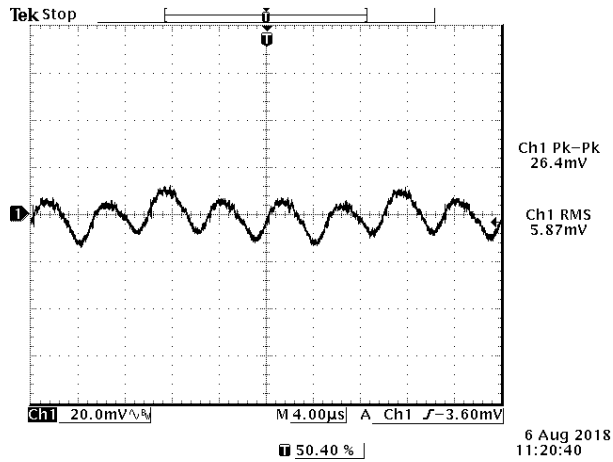

Figure 16. Ripple and noise,

$V_{in}=48V_{dc}$, 24Vdc/2.1A output @ $T_a=25^{\circ}C$ with $C_{ext}=200\mu F$

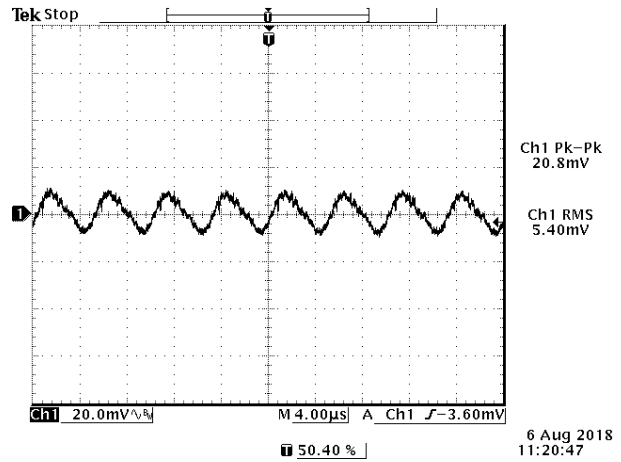

Figure 17. Ripple and noise,

$V_{in}=110V_{dc}$, 24Vdc/2.1A output @ $T_a=25^{\circ}C$ with $C_{ext}=200\mu F$

10. TRANSIENT RESPONSE WAVEFORMS

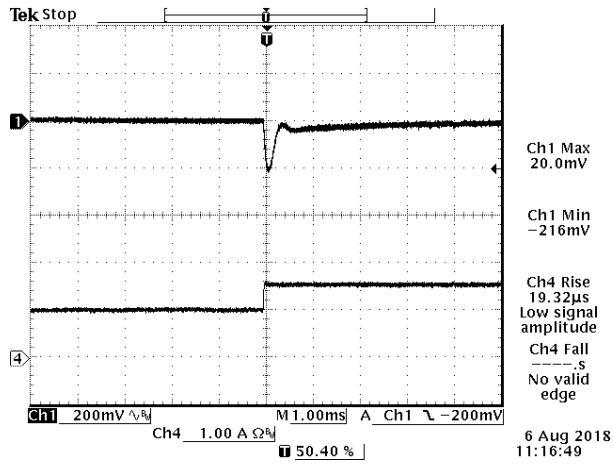

Figure 18. 50%-75% Load Transients at $V_{in}=48V@T_a=25^{\circ}C$ with $C_{ext}=200\mu F$

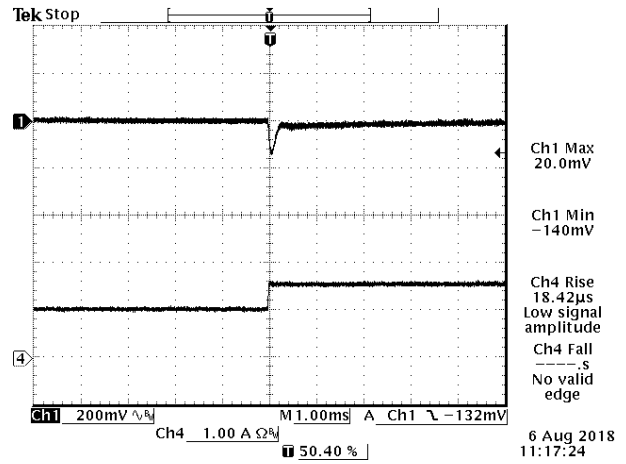

Figure 19. 50%-75% Load Transients at $V_{in}=110V@T_a=25^{\circ}C$ with $C_{ext}=200\mu F$

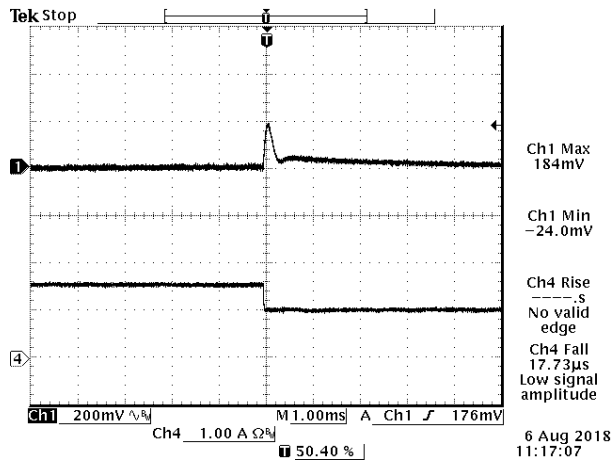

Figure 20. 75%-50% Load Transients at $V_{in}=48V@T_a=25^{\circ}C$ with $C_{ext}=200\mu F$

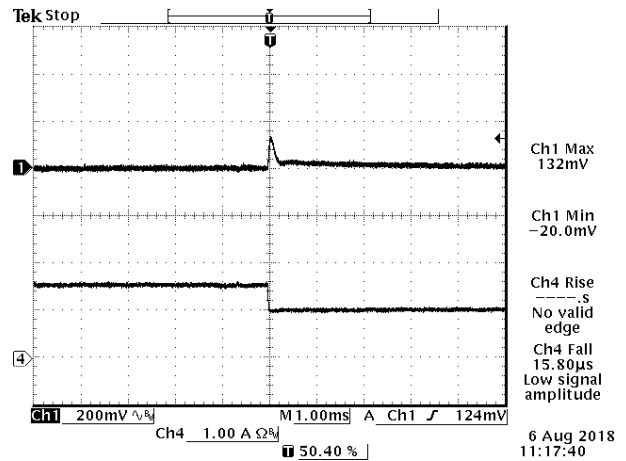

Figure 21. 75%-50% Load Transients at $V_{in}=110V@T_a=25^{\circ}C$ with $C_{ext}=200\mu F$

11. STARTUP & SHUTDOWN

Turn on rise time

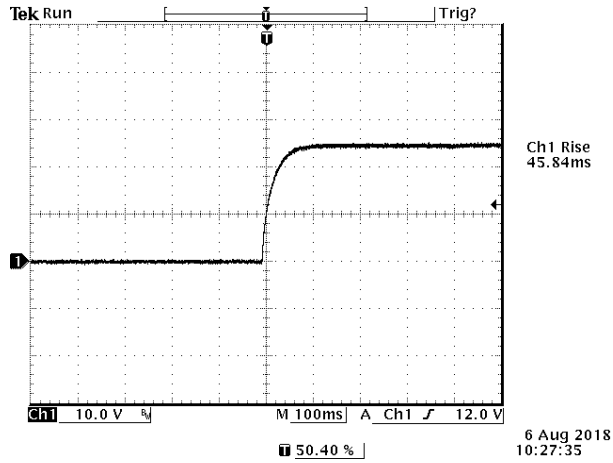

Figure 22. $V_{in}=48V$, $I_o=2.1A$, $V_o=24V$ with $C_{ext}=200\mu F$

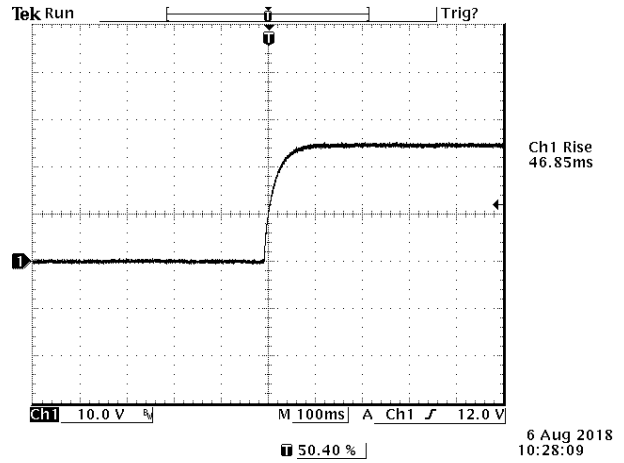

Figure 23. $V_{in}=110V$, $I_o=2.1A$, $V_o=24V$ with $C_{ext}=200\mu F$

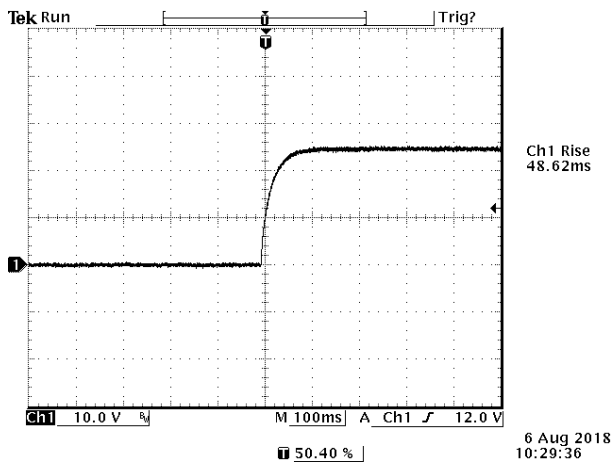

Figure 24. $V_{in}=48V$, $I_o=2.1A$, $V_o=24V$ with $C_{ext}=1200\mu F$

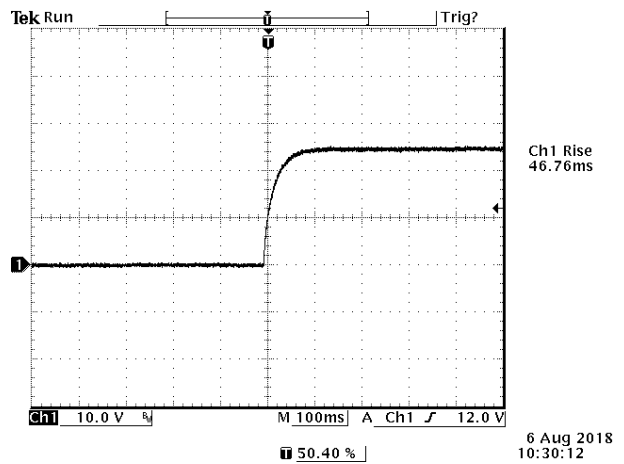

Figure 25. $V_{in}=110V$, $I_o=2.1A$, $V_o=24V$ with $C_{ext}=1200\mu F$

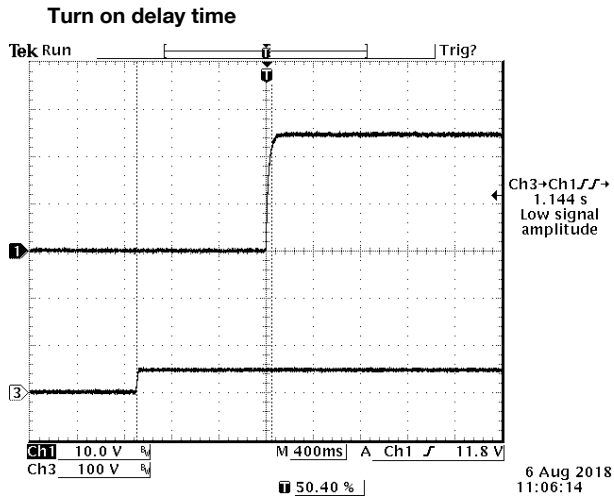

Figure 26. Startup from
Ch1: Vo
Ch3: Vin

Test Condition: Vin=48V, Io=2.1A, Vo=24V with Cext=1200uF

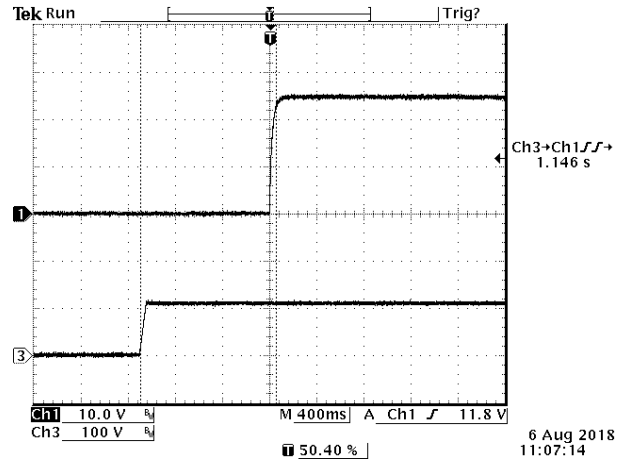

Figure 27. Startup from Vin
Ch1: Vo
Ch3: Vin

Test Condition: Vin=110V, Io=2.1A, Vo=24V with Cext=1200uF

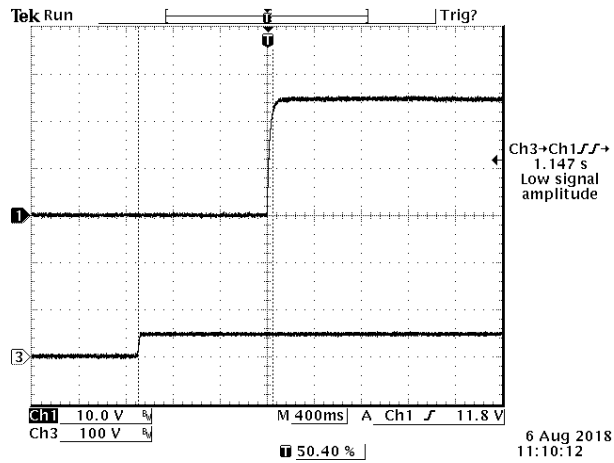

Figure 28. Startup from Vin
Ch1: Vo
Ch3: Vin

Test Condition: Vin=48V, Io=2.1A, Vo=24V with Cext=200uF

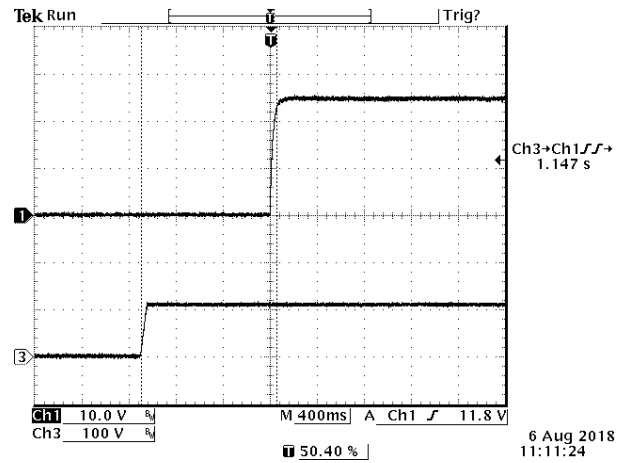

Figure 29. Startup from Vin
Ch1: Vo
Ch3: Vin

Test Condition: Vin=110V, Io=2.1A, Vo=24V with Cext=200uF



Asia-Pacific
+86 755 298 85888

Europe, Middle East
+353 61 225 977

North America
+1 408 785 5200

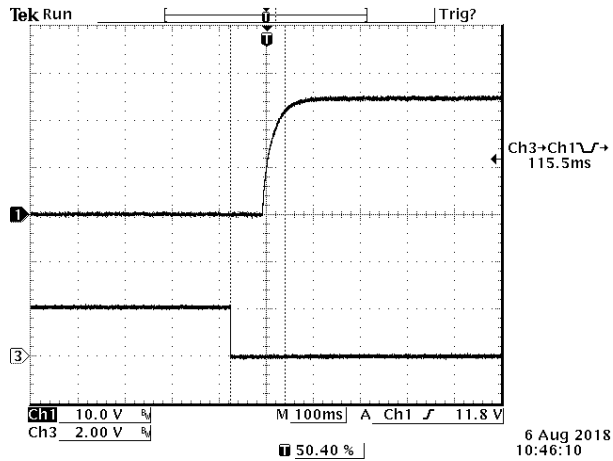

Figure 30. Startup from on/off
Ch1: Vo
Ch3: Vin

Test Condition: Vin=48V, Io=2.1A, Vo=24V with Cext=200uF

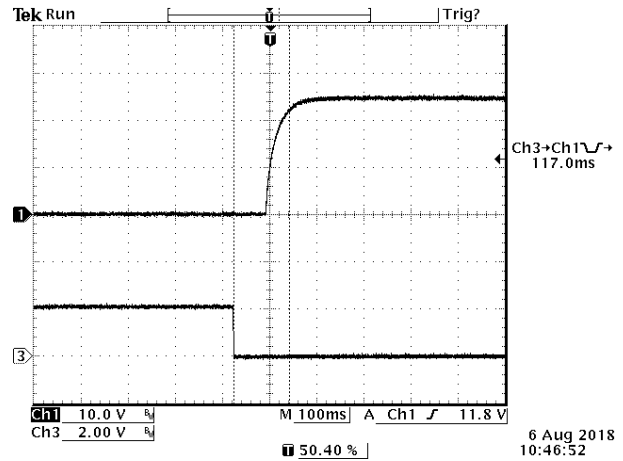

Figure 31. Startup from on/off
Ch1: Vo
Ch3: Vin

Test Condition: Vin=110V, Io=2.1A, Vo=24V with Cext=200uF

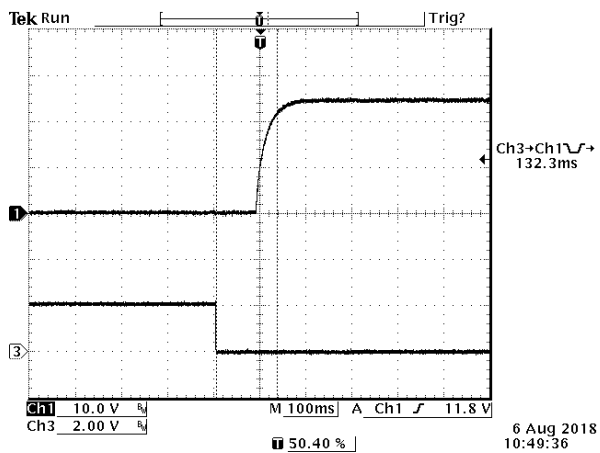

Figure 32. Startup from on/off
Ch1: Vo
Ch3: Vin

Test Condition: Vin=48V, Io=2.1A, Vo=24V with Cext=1200uF

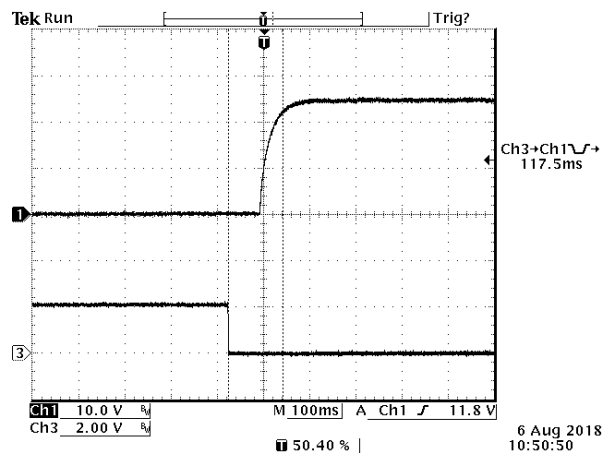

Figure 33. Startup from on/off
Ch1: Vo
Ch3: Vin

Test Condition: Vin=110V, Io=2.1A, Vo=24V with Cext=1200uF

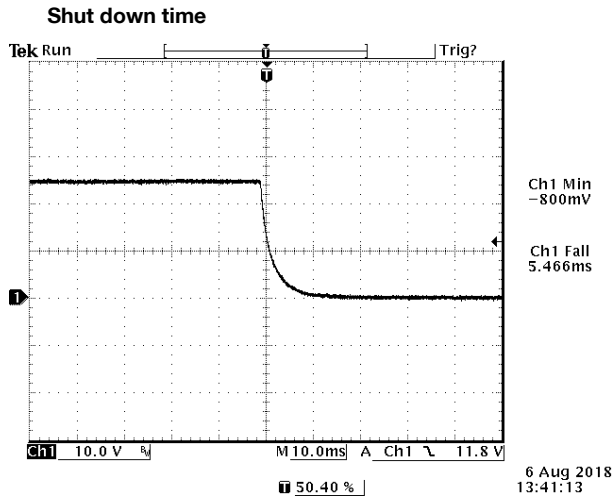

Figure 34. Typical Shut down From Vin

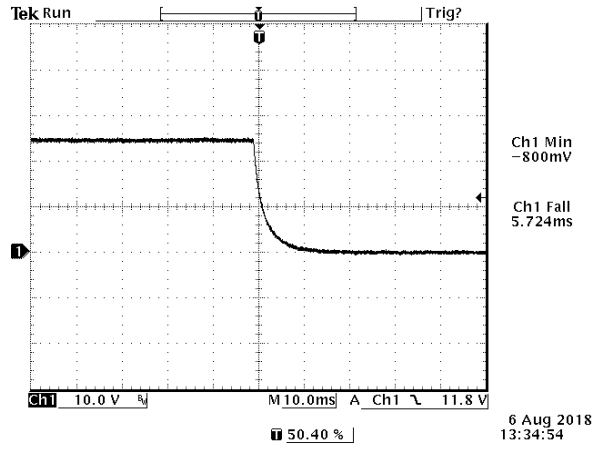

Figure 35. Typical Shut down From Venable

Test Condition: 48Vdc input, 24Vdc/2.1A output and Ta=25 deg C, with 200µF capacitor at output

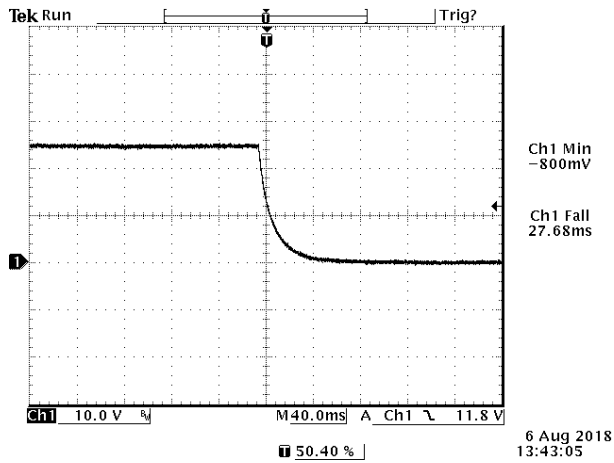

Figure 36. Typical Shut down From Vin

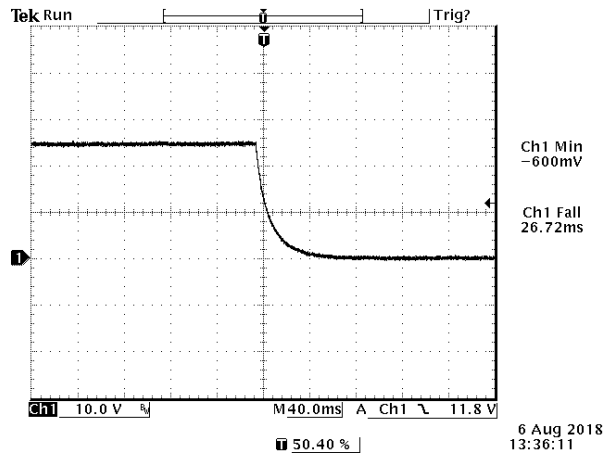

Figure 37. Typical Shut down From Venable

Test Condition: 48Vdc input, 24Vdc/2.1A output and Ta=25 deg C, with 1200µF capacitor at output



Asia-Pacific
+86 755 298 85888

Europe, Middle East
+353 61 225 977

North America
+1 408 785 5200

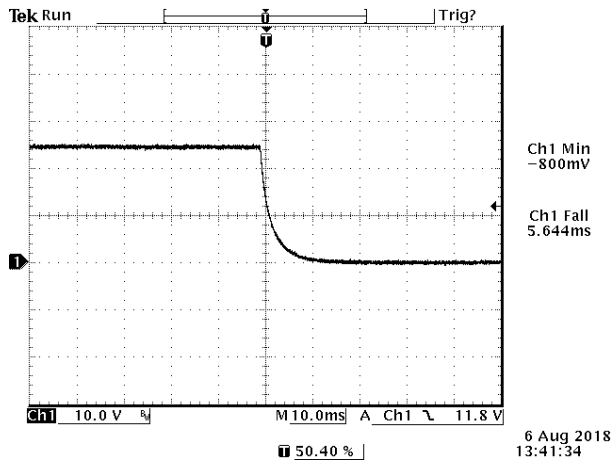

Figure 38. Typical Shut down From Vin

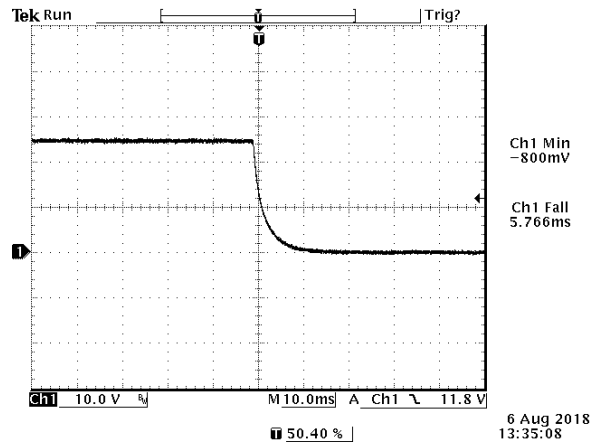

Figure 39. Typical Shut down From Venable

Test Condition: 110Vdc input, 24Vdc/2.1A output and Ta=25 deg C, with 200µF capacitor at output

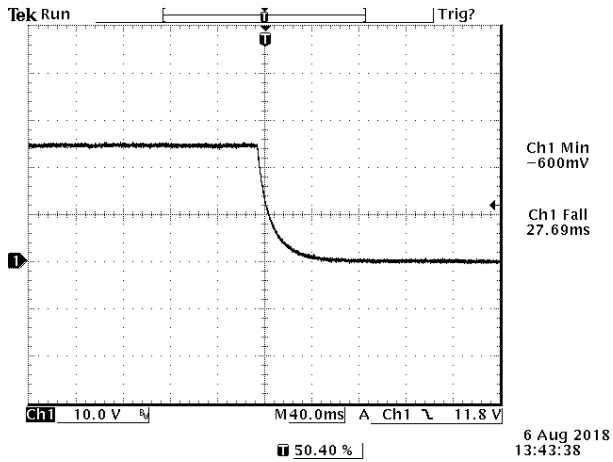

Figure 40. Typical Shut down From Vin

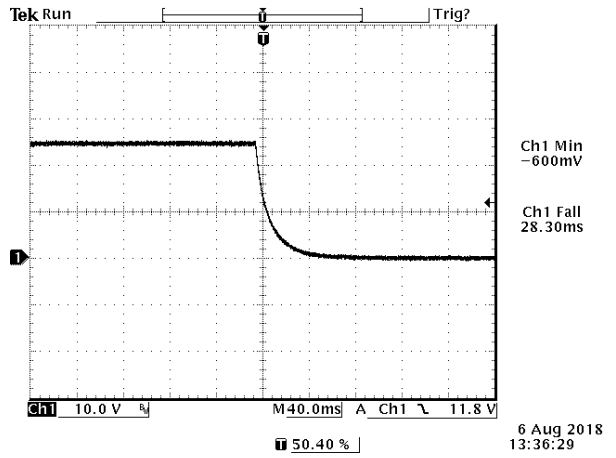

Figure 41. Typical Shut down From Venable

Test Condition: 110Vdc input, 24Vdc/2.1A output and Ta=25 deg C, with 1200µF capacitor at output

12. OVER CURRENT PROTECTION

Hiccup: To provide protection in a fault output overload condition, the module is equipped with internal current-limiting circuitry which can endure current limiting for a few milliseconds. If the over current condition persists beyond a few milliseconds, the module will shut down into hiccup mode and restart once every 1600ms. The module operates normally when the output current goes into specified range.

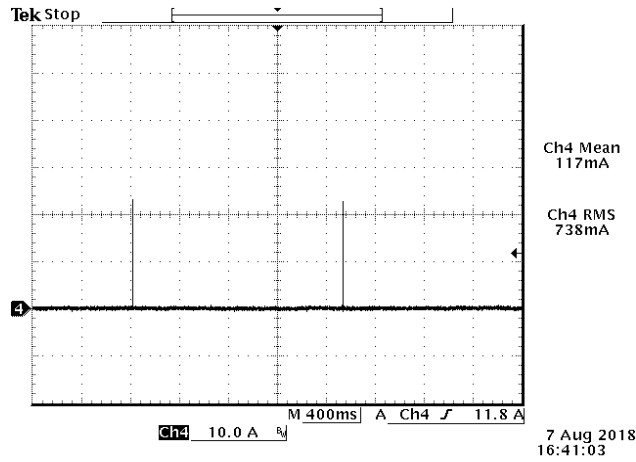

Figure 42. Over current protection

13. INPUT UNDER-VOLTAGE LOCKOUT

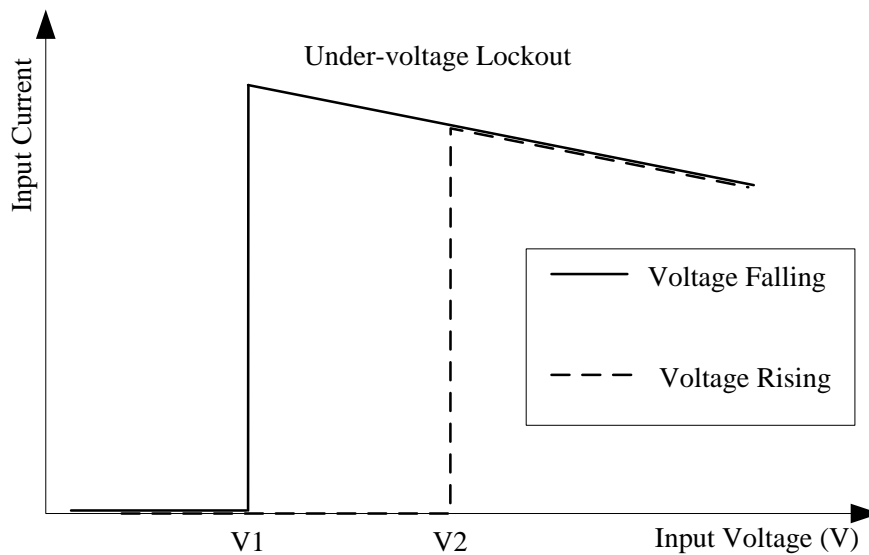
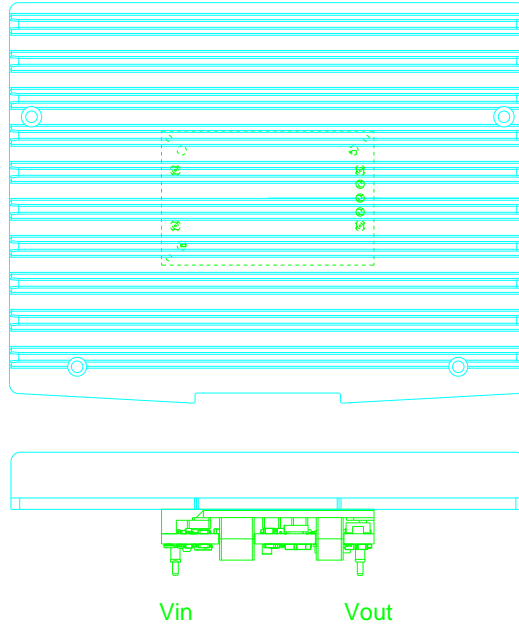

Figure 43. Input under-voltage lockout
 $V1=12V$
 $V2=13.5V$

14. THERMAL DERATING CURVE

Test setup:

Vin=24V,48V,110V, 0LFM, external HSK Dimension: 142 x 110 x 16 mm



HSK Dimension:142x110x16mm (16 includes baseplate and ribs)

Figure 44. Thermal test setup

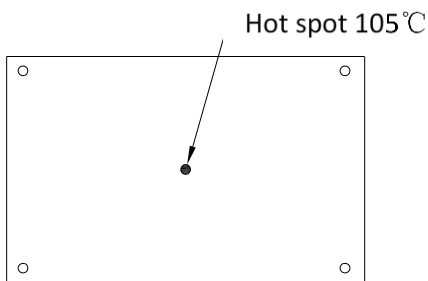

Figure 45. Module top view hot spot

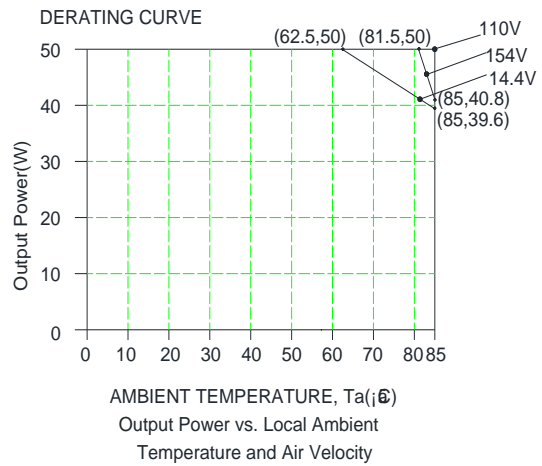

Figure 46. Thermal derating curve

15. HOLD UP CAPACITOR

Recommended external hold up circuit (Option 1)

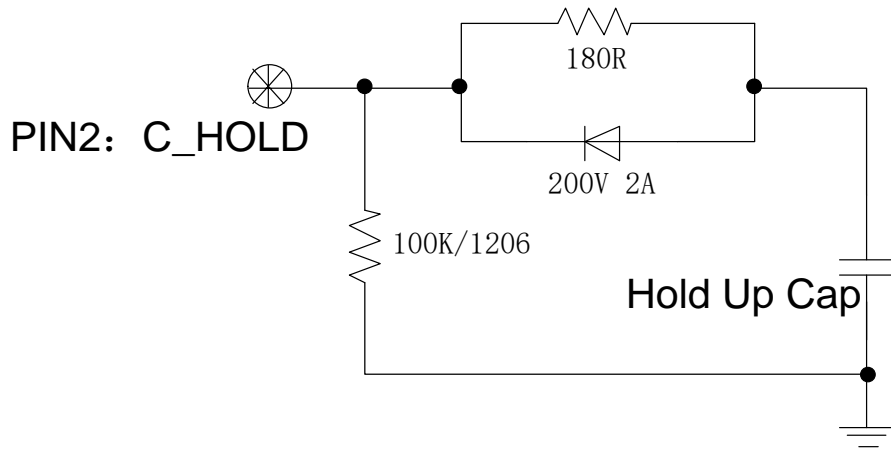

Figure 47. Recommended external hold up circuit-1

NOTE: The rated power of the current-limiting resistor 180R is determined by the rise slope of the input voltage.

PARAMETER	NOTES	SYMBOL	MIN	TYP	MAX	UNITS
Hold up capacitor	working voltage rating should be 200V. Caution: This capacitor is necessary for both normal and hold up operation.	C_HOLD	100	470	-	uF
Hold up voltage	Normal operation	V_HOLD	40	80	154	V
Hold up time	14.4-154 V input and all output range.	T_HOLD	-	12	-	ms

16. SAFETY & EMC

Safety

- 1. Material flammability UL94V-0
- 2. Nemko certification EN 62368-1
- 3. CSA certification CSA/UL 62368-1
- 4. CB certification IEC/EN 62368-1

EMC

- 1. Conductive EMI: EN55032 class A

Compliance to EN55032 class A (both peak and average) with the following inductive and capacitive filter

Test Setup:

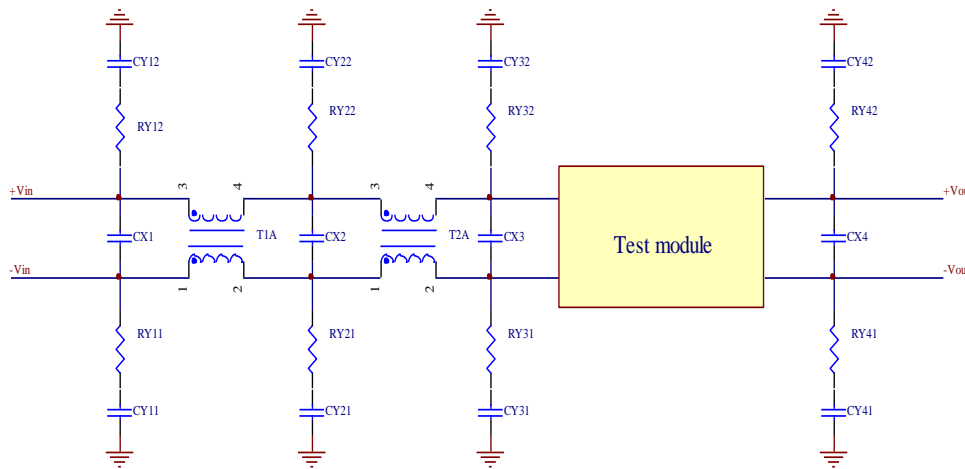

Figure 49.

ITEM	DESIGNATOR	PARAMETER	VENDOR	VENDOR P/N
1	T1A	1.85mH Common mode Choke		
2	CX1	CAP X2 1.377uF+/-20% 310VAC		
3	CY11	CAP Y2 4700PF+/-20% 250VAC		
4	CY12	CAP Y2 4700PF+/-20% 250VAC		
5	T2A	12uH Differential Mode Choke		
6	CX3	CAP X2 1uF +/-20% 310VAC		

Positive:

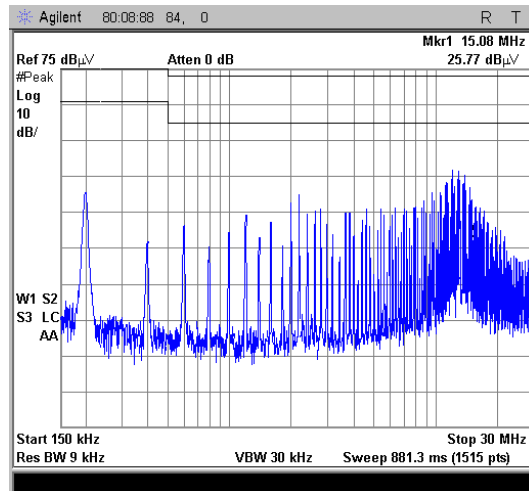

Figure 50.

Negative:

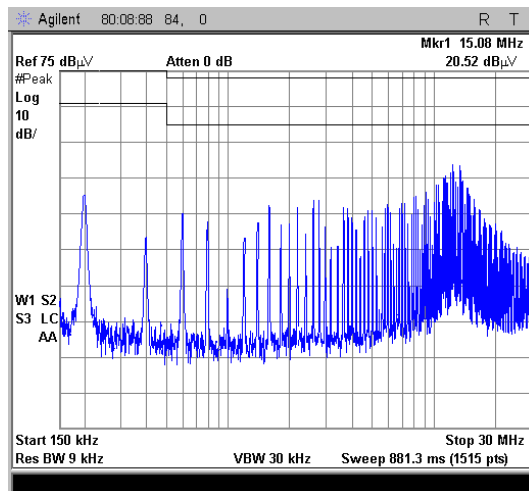

Figure 51.

17. MECHANICAL DIMENSIONS

ORQB-50Y24L/0 OUTLINE

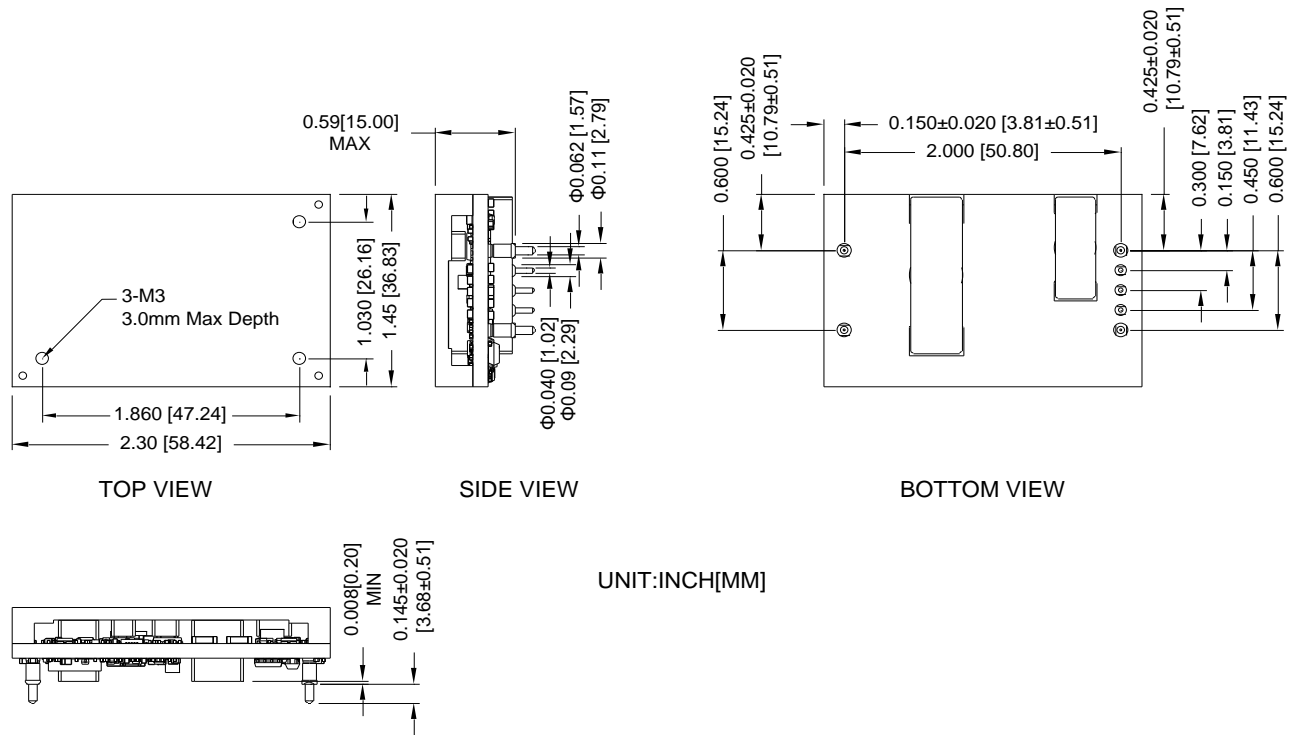

Figure 52. ORQB-50Y24L/0 Outline

Note: This module is recommended and compatible with Pb-Free Wave Soldering and must be soldered using a peak solder temperature of no more than 260 °C for less than 5 seconds.

Notes:

- 1) All Pins: Material – Copper Alloy;
Finish – Tin plated.
- 2) Un-dimensioned components are shown for visual reference only.
- 3) All dimensions in inches; Tolerances: x.xx +/-0.02 in [0.51 mm]. x.xxx +/-0.010 in [0.25 mm]. Unless otherwise stated.

0RQB-50Y24L/0 PIN DEFINITIONS

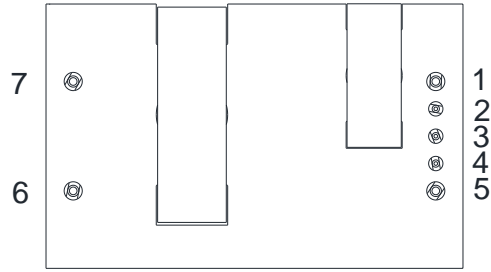

BOTTOM VIEW

Figure 53. 0RQB-50Y24L/0 Pins

PIN	FUNCTION	PIN	FUNCTION
1	Vin (+)	5	Vin (-)
2	C_HOLD	6	Vout (-)
3	ON/OFF	7	Vout (+)
4	V_AUX(5V)		

0RQB-50Y24L/0 RECOMMENDED PAD LAYOUT

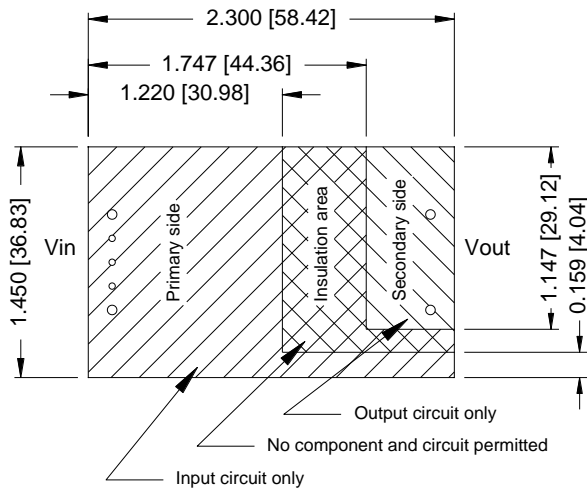
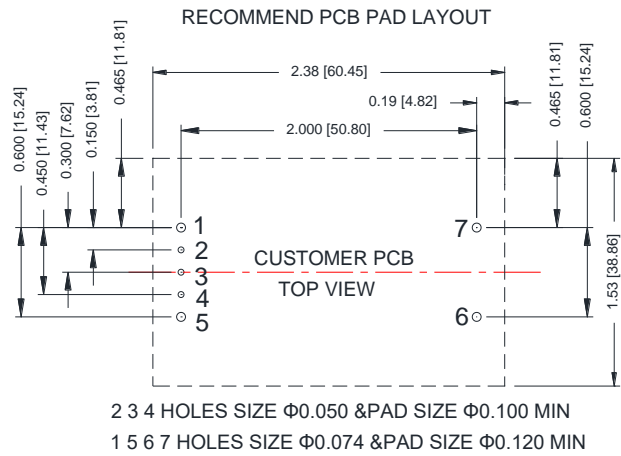

Figure 54. 0RQB-50Y24L/0 Recommended pad layout-1



2 3 4 HOLES SIZE $\Phi 0.050$ & PAD SIZE $\Phi 0.100$ MIN
 1 5 6 7 HOLES SIZE $\Phi 0.074$ & PAD SIZE $\Phi 0.120$ MIN

Figure 55. 0RQB-50Y24L/0 Recommended pad layout-2

ORQB-50Y24E/F OUTLINE

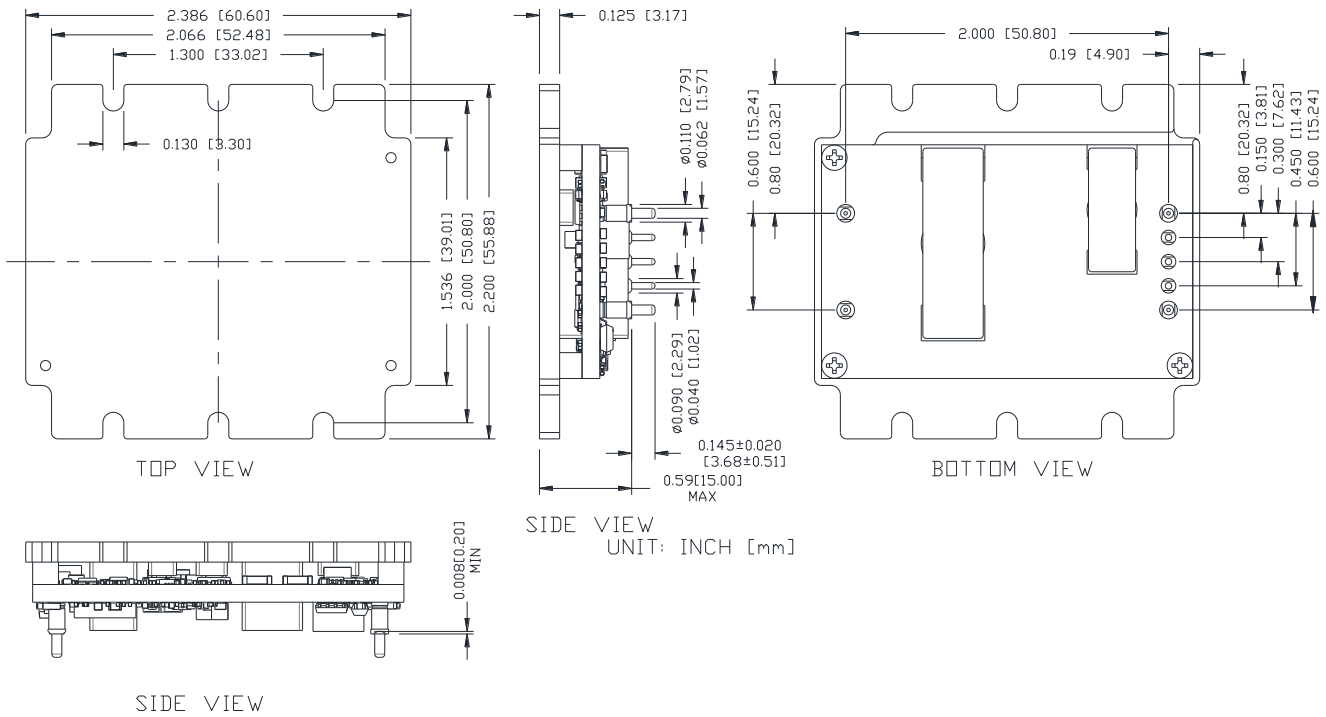

Figure 56. ORQB-50Y12E/F Outline

Note: This module is recommended and compatible with Pb-Free Wave Soldering and must be soldered using a peak solder temperature of no more than 260 °C for less than 5 seconds.

Note:

- 1) All Pins: Material – Copper Alloy;
Finish – Tin plated.
- 2) Un-dimensioned components are shown for visual reference only.
- 3) All dimensions in inches; Tolerances: x.xx +/-0.02 in [0.51 mm]. x.xxx +/-0.010 in [0.25 mm]. Unless otherwise stated.

0RQB-50Y24E/F PIN DEFINITIONS

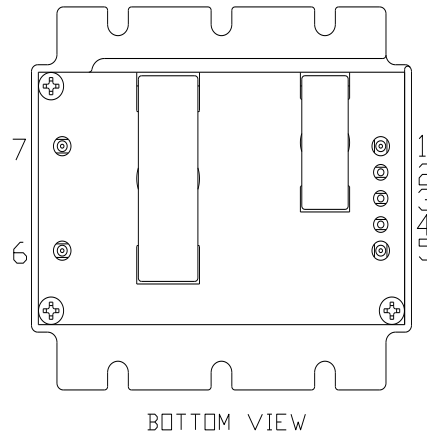

Figure 57. 0RQB-50Y24E/F Pins

PIN	FUNCTION	PIN	FUNCTION
1	Vin (+)	5	Vin (-)
2	C_HOLD	6	Vout (-)
3	ON/OFF	7	Vout (+)
4	V_AUX(5V)		

0RQB-50Y24E/F RECOMMENDED PAD LAYOUT

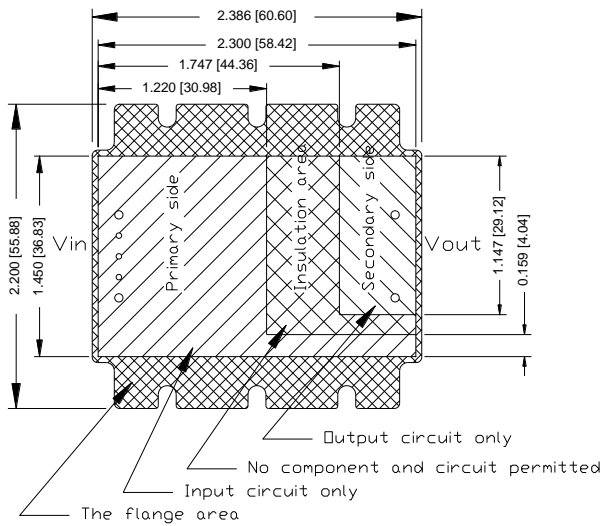
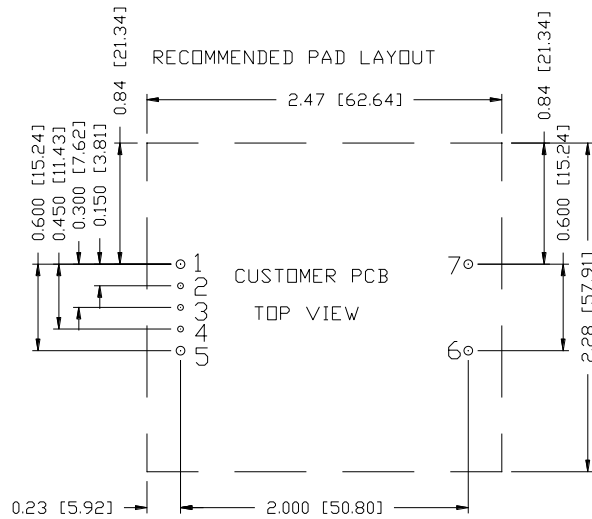

Figure 58. 0RQB-50Y12E/F Recommended pad layout-1



2,3,4 Ø0.050 HOLE SIZE, Ø0.100 min PAD SIZE
 1,5,6,7 Ø0.074 HOLE SIZE, Ø0.120 min PAD SIZE

Figure 59. 0RQB-50Y12E/F Recommended pad layout-2

18. REVISION HISTORY

DATE	REVISION	CHANGES DETAIL	APPROVAL
2018-08-08	AA	First release	J.Yao
2018-11-06	AB	Update TD	J.Yao
2019-04-15	AC	Update Wave	J.Yao
2019-11-04	AD	Add 0RQB-50Y24F, Update TD	J.Yao
2019-11-14	AE	Add feature reinforced isolation	J.Yao
2020-01-15	AF	Add safety approved to IEC/EN 62368-1 and CSA/UL 62368-1. Update altitude to 5000m	F.Tao
2020-05-20	AG	Update operating input voltage 2. Add module photo.	J.Yao
2020-07-09	AH	Update format. Add input L/C.	J.Yao
2020-11-25	AI	Update hold up capacitor.	J.Yao
2021-04-01	AJ	Add object ID. Add weight and dimensions for flange version.	J.Yao

For more information on these products consult: tech.support@psbel.com

NUCLEAR AND MEDICAL APPLICATIONS - Products are not designed or intended for use as critical components in life support systems, equipment used in hazardous environments, or nuclear control systems.

TECHNICAL REVISIONS - The appearance of products, including safety agency certifications pictured on labels, may change depending on the date manufactured. Specifications are subject to change without notice.



Asia-Pacific
+86 755 298 85888

Europe, Middle East
+353 61 225 977

North America
+1 408 785 5200

X-ON Electronics

Largest Supplier of Electrical and Electronic Components

Click to view similar products for [Isolated DC/DC Converters](#) category:

Click to view products by [Bel Fuse](#) manufacturer:

Other Similar products are found below :

[ESM6D044440C05AAQ](#) [FMD15.24G](#) [PSL486-7LR](#) [Q48T30020-NBB0](#) [JAHW100Y1](#) [SPB05C-12](#) [SQ24S15033-PS0S](#) [18952](#) [19-130041](#)
[CE-1003](#) [CE-1004](#) [GQ2541-7R](#) [RDS180245](#) [MAU228](#) [J80-0041NL](#) [DFC15U48D15](#) [XGS-0512](#) [XGS-1205](#) [XGS-1212](#) [XGS-2412](#) [XGS-](#)
[2415](#) [XKS-1215](#) [06322](#) [NCT1000N040R050B](#) [SPB05B-15](#) [SPB05C-15](#) [L-DA20](#) [DCG40-5G](#) [QME48T40033-PGB0](#) [XKS-2415](#) [XKS-2412](#)
[XKS-1212](#) [XKS-1205](#) [XKS-0515](#) [XKS-0505](#) [XGS-2405](#) [XGS-1215](#) [XGS-0515](#) [PS9Z-6RM4](#) [73-551-5038I](#) [AK1601-9RT](#) [VI-R5022-](#)
[EXWW](#) [PSC128-7iR](#) [RPS8-350ATX-XE](#) [DAS1004812](#) [VI-LJ11-iz](#) [PQA30-D24-S24-DH](#) [VI-LN2-EW](#) [VI-PJW01-CZY](#) [CK2540-9ERT](#)