

50 Ohm SMB Right Angle Crimp Type Plug - Captivated Contact

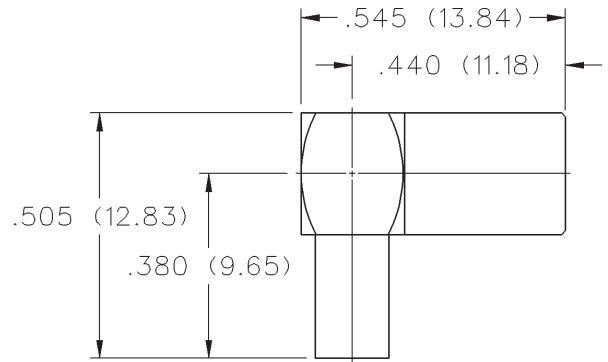

INCHES (MILLIMETERS)
CUSTOMER DRAWINGS AVAILABLE UPON REQUEST



CABLE TYPE	GOLD PLATED	NICKEL PLATED
RG-316DS, 188 DS, 179 DS, 187 DS	131-3404-101	131-3404-116

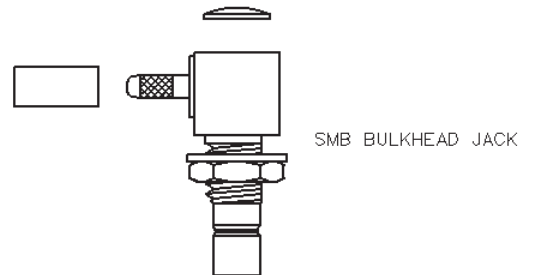
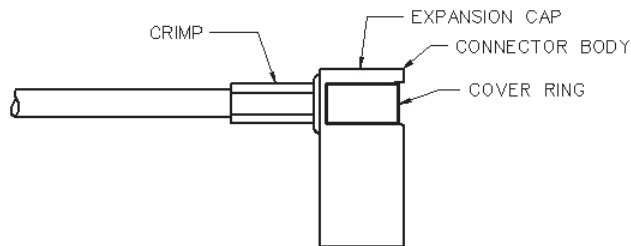
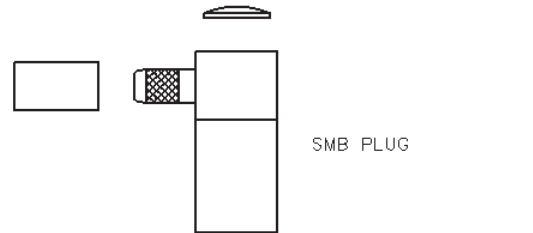
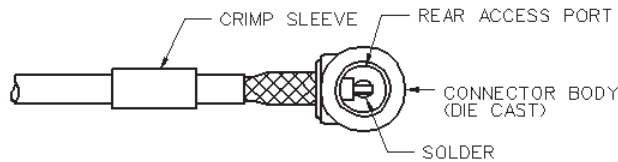
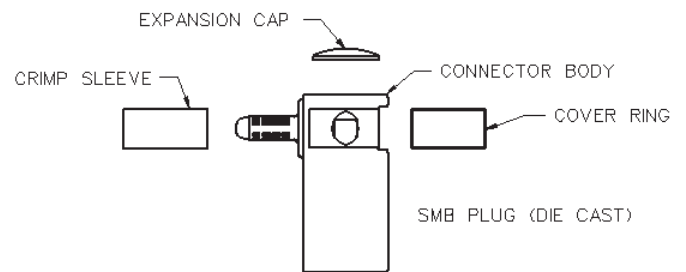
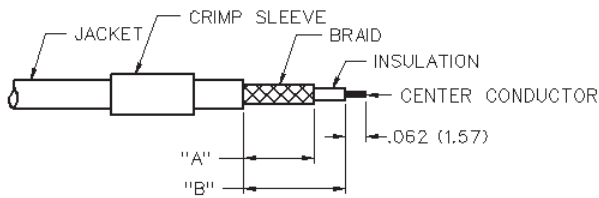

1. Identify connector parts. (4 piece parts: crimp sleeve, body assembly, expansion cap and covering ring. Die cast body only.)
2. Strip cable to dimensions shown. Do not nick braid or center conductor. A wire stripper of correct size is recommended for this step. Twist stranded center conductor into tight bundle and tin (optional). Slide crimp sleeve onto cable as shown.
3. Flare braid and slide cable into body assembly making certain that the cable insulation bottoms on center contact. Solder center conductor to contact through the rear and side access ports. Use a minimum amount of solder for a good joint. **.020 (0.51) diameter solder is recommended.**
4. Arrange braid uniformly around crimp stem of body assembly. Slide crimp sleeve over braid and crimp securely using recommended crimp tool. Place expansion cap in access port and seat with a .125 (3.17) diameter flat punch. Snap cover ring over side access port.

CABLE GROUP	PART NUMBER	"A"	"B"	CRIMP HEX
RG-179DS, 187DS, 188DS, 316DS	131-3404-101/116	.177 (4.50)	.289 (7.34)	.151 (3.83)

X-ON Electronics

Largest Supplier of Electrical and Electronic Components

Click to view similar products for [RF Connectors / Coaxial Connectors](#) category:

Click to view products by [Bel Fuse](#) manufacturer:

Other Similar products are found below :

[R125315120](#) [8915-1511-000](#) [89674-0827](#) [5916-1103-603](#) [6-0001-3](#) [6001-7071-019](#) [6002-7051-003](#) [6002-7551-202](#) [6059674-1](#) [619550-1](#)
[630059-000](#) [M39012/25-0021](#) [M39012/79-3008](#) [M39030/3-01N](#) [M39030/3-03N](#) [M3933/25-36N](#) [6500-7071-046](#) [M83723/72W24576](#)
[M83723/72W2457N](#) [6769](#) [CX050L2AQ](#) [7002-1541-010](#) [7002-1572-002](#) [7003-1572-002](#) [7010-1511-000](#) [7029-1511-060](#) [7101-1541-010](#)
[7101-1571-002](#) [7105-1521-002](#) [7145-1521-002](#) [7209-1511-011](#) [7210-1511-015](#) [7210-1511-019](#) [7225-1512-050](#) [7242-1511-000](#) [73137-5015](#)
[73251-0111](#) [73251-0672](#) [7325-1512-000](#) [73276-1501](#) [73366-0013](#) [73404-2300](#) [73413-6080](#) [73415-5721](#) [7405-1521-005](#) [7405-1521-802](#)
[7406-1521-005](#) [804S01D04M040](#) [8145-1521-002](#) [81590](#)