

Connectivity...for
Business-Critical Continuity

Stainless Steel SMA Connectors

Product Catalog



JOHNSON[®]

EMERSON[™]
Network Power

Johnson® Stainless Steel SMA Connectors meet or exceed the performance requirements of MIL-PRF-39012. All designs are based on 50 ohm system impedance per MIL-STD-348, and operate at frequencies up to 26.5 GHz.

Applications

- Antennas
- Base stations
- Broadcast
- Cable assemblies
- Cellular
- Instrumentation
- Microwave Radio
- Radar
- Radios
- RF and Microwave Components
- Satcom
- Aircraft

Features

- All contacts are plated with 50 micro-inches of gold for excellent durability and high frequency performance
- Stainless steel bodies are offered with passivation as a standard finish, and gold plating where soldering is required
- Plug interfaces and semi-rigid bulkhead jack bodies include gaskets for environmental sealing
- Cabled contacts are captivated upon assembly
- Flexible cable contacts can be crimped or soldered
- Semi-rigid cabled plug connectors are available in one piece versions, requiring solder attachment only between the cable jacket and connector body
- The right angle PC mount features a rugged one-piece body with a one-piece swept contact

Table of Contents

	PAGE
ASSEMBLY INSTRUCTIONS	14
ASSEMBLY TOOLS	13
COMPETITOR CROSS REFERENCE	19
ELECTRICAL SPECIFICATIONS	3-4
ENVIRONMENTAL SPECIFICATIONS	5
FLEXIBLE CABLE CONNECTORS	9
MATERIAL SPECIFICATIONS	5
MECHANICAL SPECIFICATIONS	5
MOUNTING HOLES	6
PANEL MOUNT JACK RECEPTACLES	10-12
PC MOUNT JACKS RECEPTACLES	10
SEMI-RIGID CABLE CONNECTORS	7

ELECTRICAL SPECIFICATIONS

Impedance: 50 Ohms

Frequency Range:

Flexible cable connectors	0-12.4 GHz
Uncabled receptacles	0-18.0 GHz
Straight Semi-Rigid cable connectors	0-26.5 GHz

VSWR: (f = GHz)

	<u>Straight Cable Connectors</u>	<u>Right Angle Cable Connectors</u>
RG-316, LMR-100 cable	1.15+.02f	1.15+.03f
RG-58, LMR-195 cable	1.15+.01f	1.15+.02f
RG-142 cable	1.15+.01f	1.15+.02f
.086 Semi-Rigid cable (0 - 18 GHz)	1.07+.008f	
.086 Semi-Rigid cable (18 - 26.5 GHz)	1.35 MAX	
.141 Semi-Rigid cable (w/contact)	1.05+.008f	
.141 Semi-Rigid cable (w/o contact)	1.035+.005f	

Insertion Loss: (dB maximum)

Straight flexible cable connectors	$0.06\sqrt{f}$ (GHz), tested at 6 GHz
Right angle flexible cable connectors	$0.15\sqrt{f}$ (GHz), tested at 6 GHz
Straight Semi-Rigid cable connectors with contact	$0.03\sqrt{f}$ (GHz), tested at 10 GHz
Straight Semi-Rigid cable connectors w/o contact	$0.03\sqrt{f}$ (GHz), tested at 16 GHz
Uncabled receptacles	N/A

Working Voltage: (Vrms maximum)

	<u>Sea Level</u>	<u>70K Feet</u>
RG-316, LMR-100, 195	250	65
RG-58, RG-142, .086 Semi-Rigid, Uncabled receptacles, .141 Semi-Rigid w/o contact	335	85
.141 Semi-Rigid with contact	500	125

Dielectric Withstanding Voltage: (Vrms minimum at sea level)

	<u>Sea Level</u>
Connectors for RG-316, LMR-100, 195	750
Connectors for RG-58, RG-142, .086 Semi-Rigid, Uncabled receptacles	1000
Connectors for .141 Semi-Rigid with contact	1500
Connectors for .141 Semi-Rigid w/o contact	N/A

Corona Level: (Volts minimum at 70,000 feet)

	<u>70K Feet</u>
Connectors for RG-316, LMR-100, 195	190
Connectors for RG-58, RG-142, .086 Semi-Rigid, Uncabled receptacles, .141 Semi-Rigid w/o contact	250
Connectors for .141 Semi-Rigid with contact	375

ELECTRICAL SPECIFICATIONS cont'd

RF High Potential Withstanding Voltage: (Vrms minimum, tested at 4 and 7 MHz)

Connectors for RG-316, LMR-100, 195	500
Connectors for RG-58, RG-142, .086 Semi-Rigid, .141 Semi-Rigid cable w/o contact, Uncabled receptacles	670
Connectors for .141 Semi-Rigid with contact	1000

Insulation Resistance: 5000 Megohms minimum

Contact Resistance: (milliohms maximum)

	<u>Initial</u>	<u>After Environmental</u>
Center contact (straight cabled connectors and Uncabled receptacles)	3.0*	4.0*
Center contact (right angle cabled connectors)	4.0	6.0
Outer Contact (all connectors)	2.0	N/A
Braid to Body (gold plated bodies)	0.5	N/A

*N/A where the cable center conductor is used as a contact

RF Leakage: (dB minimum, tested at 2.5 GHz)

Flexible cable connectors and .141 Semi-Rigid connectors w/o contact	-60
.086 Semi-Rigid connectors and .141 Semi-Rigid connectors with contact	-90
Uncabled receptacles	N/A

MECHANICAL SPECIFICATIONS

- Engagement Design:** MIL-PRF-39012, Series SMA
- Durability:** 500 cycles minimum
100 cycles minimum for .141 Semi-Rigid connectors w/o contact
- Engagement/Disengagement Force:** 2 inch-pounds maximum
- Mating Torque:** 7 to 10 inch-pounds
- Bulkhead Mounting Nut Torque:** 15 inch-pounds recommended
- Coupling Proof Torque:** 15 inch-pounds minimum
- Coupling Nut Retention:** 60-pounds minimum
- Contact Retention:**
 - 6 lbs. minimum axial force (captivated contacts)
 - 4 inch-ounce minimum torque (uncabled receptacles)

Cable Retention: (minimum*)

	Axial Force (lbs)	Torque (in-oz)
Connectors for RG-316, LMR-100	20	N/A
Connectors for RG-58	40	N/A
Connectors for RG-142 Cabled	45	N/A
Connectors for .086 Semi-Rigid	30	16
Connectors for .141 Semi-rigid	60	55
Connectors for LMR-195	30	N/A

* Or cable breaking strength, whichever is less

ENVIRONMENTAL SPECIFICATIONS

(Meets or Exceeds the Applicable Paragraph of MIL-PRF-39012)

- Temperature Range:** -65°C to +165°C
- Thermal Shock:** MIL-STD-202, Method 107, Condition B (except +85°C high temperature)
- Corrosion:** MIL-STD-202, Method 101, Condition B
- Shock:** MIL-STD-202, Method 213, Condition I
- Vibration:** MIL-STD-202, Method 204, Condition D
- Moisture Resistance:** MIL-STD-202, Method 106

MATERIAL SPECIFICATIONS

- Bodies:** Stainless Steel, type 303, per ASTM A 582, passivated per MIL-F-14072 (EL 300), or gold Plated per MIL-G-45204 B .00003" min.
- Contacts:** Male - Brass per ASTM B16, Gold plated* per MIL-G-45204 (.00005" min)
Female - Beryllium Copper per ASTM B196, Gold plated* per MIL-G-45204 (.00005" min)
- Insulators:** PTFE Fluorocarbon per ASTM D1710 and ASTM D1457
- Gaskets:** Silicon Rubber per ZZ-R-765
- Expansion Caps:** Brass per QQ-B-613, gold plated per MIL-G-45204 .00001" min. or nickel plated per QQ-N-290
- Crimp Sleeves:** Copper per ASTM A75, gold plated per MIL-G-45204 .0001"min. or nickel per QQ-N-290 plated (.00001" min)
- Nut Retention Spring (Plugs):** Beryllium Copper per ASTM B196, un-plated
- Mounting Hardware:** Stainless Steel, type 303, Per ASTM A 582, passivated per MIL-F-14072 (EL 300), or gold plated* per MIL-G-45204 B .00001" min.

Note: All Gold plated parts include a .00005" minimum Nickel under plated barrier layer

MATING ENGAGEMENT FOR STAINLESS STEEL SMA SERIES PER MIL-STD-348A

1. ID TO MEET VSWR, CONTACT RESISTANCE AND INSERTION WITHDRAWAL FORCES WHEN MATED WITH A DIA. .0355-.0370 PIN.
2. GASKET IS NOT SUPPLIED WITH BRASS CONNECTORS.

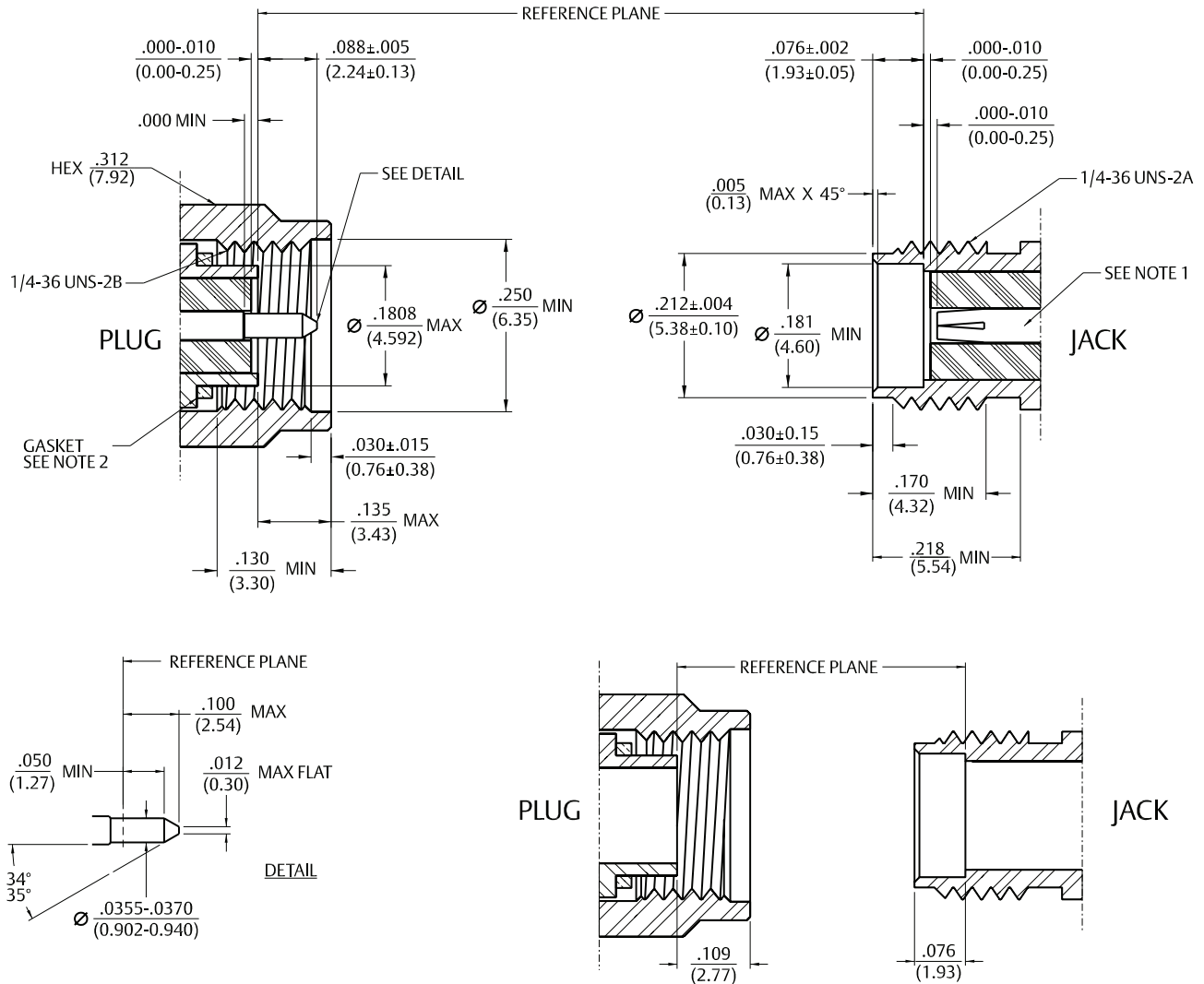

MOUNTING HOLES

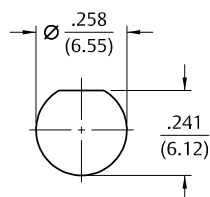

Fig 1



Fig 2

Straight Solder Type Plug - with Contact, Captive Nut Thin Wall



Cable Type	VSWR & Freq. Range	Gold Plated Body	"A"
RG-405, .086 Semi-Rigid	1.07+.008f (0-18 GHz), 1.35 Max (18-26.5 GHz)	141-0693-002	.405
RG-402, .141 Semi-Rigid	1.05+.008f (0-26.5 GHz)	141-0694-002	.440

Assembly instructions page 16

Straight Solder Type Plug - without Contact, Thread-on Nut Connector Interface for .141 Cable



Cable Type	VSWR & Freq. Range	Gold Plated Body
RG-402, .141 Semi-Rigid	1.035+.005f (0-26.5 GHz)	141-0694-012

Assembly instructions page 15

Straight Solder Type Plug with Captivated Solderless Contact, Captive Nut and Thick Wall Interface



Cable Type	VSWR & Freq. Range	Gold Plated Body
RG-405, .086 Semi-Rigid	1.07+.008f (0-18 GHz), 1.35 Max (18-26.5 GHz)	141-0693-062
RG-402, .141 Semi-Rigid	1.05+.008f (0-26.5 GHz)	141-0694-062

Assembly instructions page 17

Straight Solder Type Jack

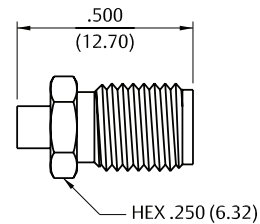
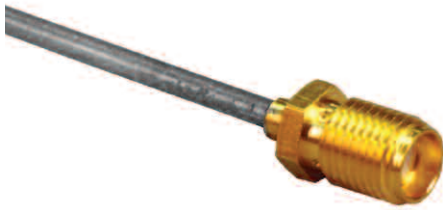

Cable Type	VSWR & Freq. Range	Gold Plated
RG-405, .086 Semi-Rigid	1.07+.008f (0-18 GHz), 1.35 Max (18-26.5 GHz)	141-0593-001
RG-402, .141 Semi-Rigid	1.05+.008f (0-26.5 GHz)	141-0594-001

Assembly instructions page 16

Straight Solder Type Bulkhead Jack with O-Ring

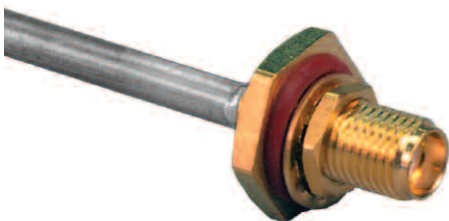

Cable Type	VSWR & Freq. Range	Gold Plated
RG-405, .086 Semi-Rigid	1.07+.008f (0-18 GHz), 1.35 Max (18-26.5 GHz)	141-0593-401
RG-402, .141 Semi-Rigid	1.05+.008f (0-26.5 GHz)	141-0594-401

Assembly instructions page 16

Straight Solder Type Bulkhead Jack with Captivated Solderless Contact and O-Ring

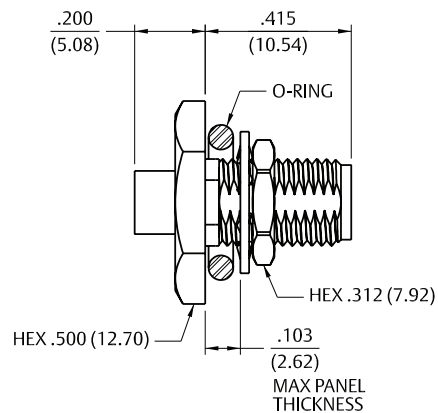
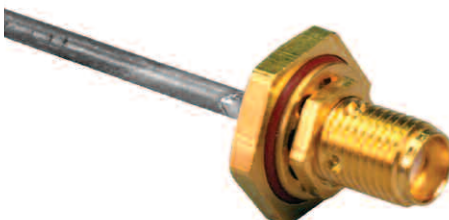

Cable type	VSWR & Freq. Range	Gold Plated
RG-405, .086 Semi-Rigid	1.07+.008f (0-18 GHz), 1.35 Max (18-26.5 GHz)	141-0593-421
RG-402, .141 Semi-Rigid	1.05+.008f (0-26.5 GHz)	141-0594-421

Assembly instructions page 17

Straight Crimp Type Plug (3-piece) - Solder or Crimp Captivated Contact



Cable Type	VSWR & Freq. Range	Passivated
RG-161/U, 174,188, 316, LMR-100, HPF-100, RF-100	1.15+.02f (0-12.4 GHz)	141-0403-012
RG-188 DS, RG-316 DS	1.15+.02f (0-12.4 GHz)	141-0404-012
RG-58/U, 141, 303, LMR-195, HPF-195, RF-195	1.15+.01f (0-12.4 GHz)	141-0407-012
RG-55/U, 142, 223, 400	1.15+.01f (0-12.4 GHz)	141-0408-012

Assembly instructions page 14

Right Angle Crimp Type Plug - Captivated Contact



Cable Type	VSWR & Freq. Range	Passivated	"A"	"B"	"C"	"D"
RG-161/U, 174,188, 316	1.15+.03f (0-12.4 GHz)	141-0403-102	.652	.527	.593	.467
RG-188 DS, RG-316 DS	1.15+.03f (0-12.4 GHz)	141-0404-112	.652	.527	.593	.467
RG-58/U, 141, 303	1.15+.02f (0-12.4 GHz)	141-0407-102	.636	.519	.596	.471
RG-55/U, 142, 223, 400	1.15+.02f (0-12.4 GHz)	141-0408-102	.636	.519	.596	.471

Assembly instructions page 18

Straight Crimp Type Bulkhead Jack (3-piece) - Solder or Crimp Captivated Contact



Cable Type	VSWR & Freq. Range	Passivated
RG-161/U, 174,188, 316	1.15+.02f (0-12.4 GHz)	141-0303-412
RG-188 DS, RG-316 DS	1.15+.02f (0-12.4 GHz)	141-0304-412
RG-58/U, 141, 303	1.15+.01f (0-12.4 GHz)	141-0307-412
RG-55/U, 142, 223, 400	1.15+.01f (0-12.4 GHz)	141-0308-412

Assembly instructions page 14

Right Angle PC Mount Jack Receptacle



Freq. Range	Gold Plated
0-18 GHz	141-0701-301

Mounting hole layout Figure 2 on page 6

Straight PC Mount Jack Receptacle



Freq. Range	Gold Plated
0-18 GHz	141-0701-201

Mounting hole layout Figure 2 on page 6

Rear Mount Bulkhead Jack Receptacle

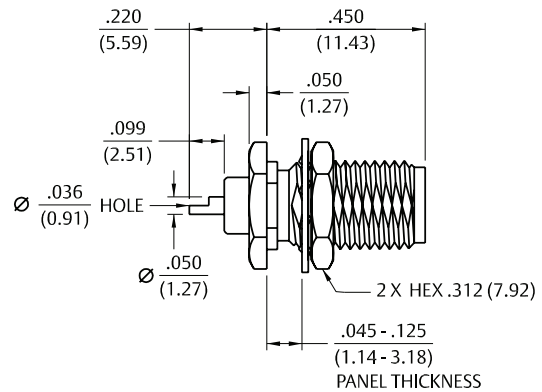

Freq. Range	Passivated
0-18 GHz	141-0701-402

Mounting hole layout Figure 1 on page 6

2-Hole Flange Mount Jack Receptacle - Flush Dielectric

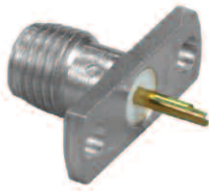

Freq. Range	Passivated
0-18 GHz	141-0701-602

4-Hole Flange Mount Jack Receptacle - Flush Dielectric



Freq. Range	Passivated
0-18 GHz	141-0701-612

2-Hole Flange Mount Jack Receptacle - Extended Dielectric



VSWR & Freq. Range	Passivated
1.15+.02f (0-18 GHz)	141-0701-622

4-Hole Flange Mount Jack Receptacle - Extended Dielectric



VSWR & Freq. Range	Passivated
1.15+.02f (0-18 GHz)	141-0701-632

ASSEMBLY TOOLS

Semi-Rigid Assembly Tools

Accurate assembly of the Semi-Rigid Cabled Connectors is obtained with the tools listed below. Industry standard devices are used if possible for customer convenience and tool compatibility.



Item	Part No.	Description
A	140-0000-962	Soldering Vise (does not include inserts (B) or stop screw (H))
B	140-0000-964	Semi-Rigid Cable Clamp Inserts for .086" OD Cable
	140-0000-965	Semi-Rigid Cable Clamp Inserts for .141" OD Cable
C	140-0000-973	Soldering Mating Fixture for SMA Jack Connectors
D	140-0000-975	Complete Center Conductor Pointing Tool for .086" OD Cable
	140-0000-976	Complete Center Conductor Pointing Tool for .141" OD Cable
E	140-0000-977	Bushing for .086" OD Cable Conductor Pointing Tool
	140-0000-978	Bushing for .141" OD Cable Conductor Pointing Tool
F	140-0000-979	Blade for Center Conductor Pointing Tool
G	140-0000-980	Frame for Center Conductor Pointing Tool
H	140-0000-981	Stop Screw for Semi-Rigid Cable Soldering Vise
I	140-0000-982	Soldering Mating Fixture for SMA Plug Connectors

ASSEMBLY INSTRUCTIONS

SMA Type Straight Plugs, Straight Jacks, and Straight Bulkhead Jacks for Flexible Cable - Crimp or Solder Contacts

1. Identify connector parts. (3 piece parts—except bulkhead)
2. Strip cable to dimensions shown. Do not nick braid or center conductor. Tin center conductor if contact will be solder attached. Do not tin center conductor if contact is to be crimp attached. When stripping LMR-100 low loss cable, remove foil back to where cable jacket is stripped. A wire stripper of correct size is recommended for this step. Slide heat shrink (as applicable) and crimp sleeve onto jacket of cable.
3. Assemble contact onto cable as shown.
Solder Attachment: Solder contact to center conductor through solder hole using .020 (0.51) diameter solder. Use a minimum amount of solder for a good joint.
Crimp Attachment: Crimp contact to center conductor using Johnson® Hand Tool 144-0000-910, setting #2, with positioner 141-0000-907. Crimp location should be centered between end of contact and X-hole. Crimp attachment to solid center conductor cables is not recommended.
4. Flare braid and slide body assembly over contact and under braid. Then seat body assembly firmly onto contact. The cable may have to be held in a clamping fixture. Arrange braid uniformly around crimp stem. Slide crimp sleeve forward and crimp using recommended crimp tool. Slide heat shrink forward and shrink (as applicable).

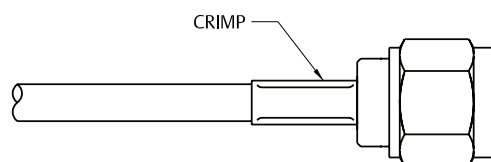
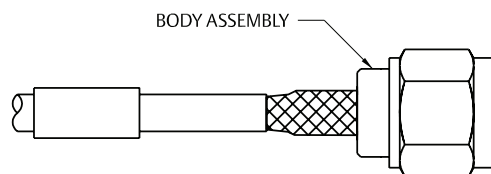
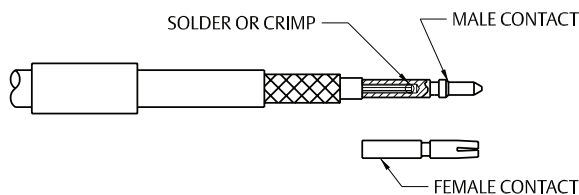
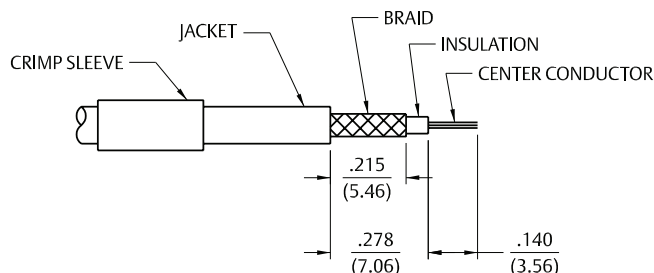
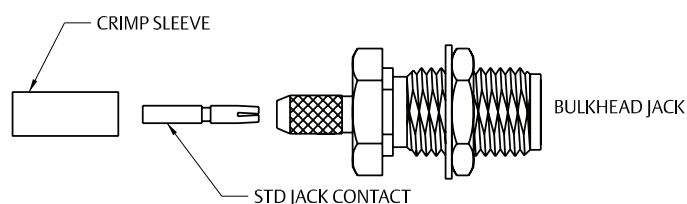
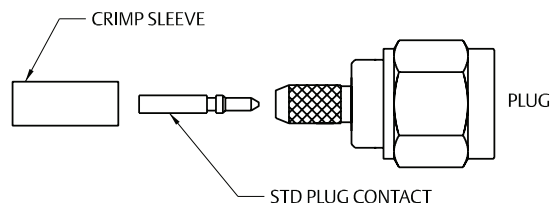

Cable Type	Part No.	Crimp Hex
RG-316/U, 161, 174, 188; LMR-100	141-0303-412	.128 (3.25)
RG-316 DS, 188 DS	141-0304-412	.151 (3.83)
RG-58/U, 141, 303	141-0307-412	.213 (5.41)
RG-55/U, 142, 223, 400	141-0308-412	.213 (5.41)
RG-316/U, 161, 174, 188; LMR-100	141-0403-012	.128 (3.25)
RG-316 DS, 188 DS	141-0404-012	.151 (3.83)
RG-58/U, 141, 303	141-0407-012	.213 (5.41)
RG-55/U, 142, 223, 400	141-0408-012	.213 (5.41)

SMA Solder Type Straight Plugs for Semi-Rigid Cable

1. Identify connector parts. (2 piece parts)
2. Strip cable to dimensions shown. Do not nick center conductor. Bevel the cable center conductor per contact detail of SMA interface on page 6. Slide coupling nut onto cable as shown.
3. Insert cable into body making sure cable jacket is flush with front of body. Solder body to cable. Use a minimum amount of heat to minimize cable insulation movement. Trim expanded insulation flush with front of body or fixture body and cable during soldering to prevent cable insulation expansion.
4. Thread coupling nut over body.



Cable Type	Part No.
RG-402/U (.141 Semi-Rigid)	141-0694-012

SMA Solder Type Straight Jacks, Straight Plugs, and Straight Bulkhead Jacks for Semi-Rigid Cable

1. Identify connector parts. (2 piece parts)
2. Strip cable to dimensions shown. Do not nick center conductor.
3. Place center contact on center conductor making sure contact bottoms against cable insulation. Solder center conductor to center contact through solder hole. Solder must not be allowed to run on outside of contact. Use a minimum amount of solder for a good joint. **.020 (0.51) diameter solder is recommended.** Trim excess insulation.
4. Insert contact and cable into body assembly making sure cable is bottomed against insulator in body. Solder body to cable. Use a minimum amount of heat to minimize cable insulation movement.

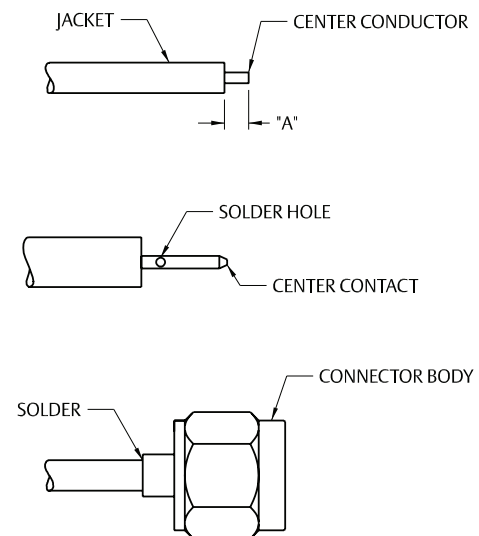

Cable Type	Part No.	"A"
RG-405/U (.086 Semi-Rigid)	141-0593-001	.070 (1.78)
	141-0593-401	.070 (1.78)
	141-0693-002	.070 (1.78)
RG-402/U (.141 Semi-Rigid)	141-0594-001	.085 (2.16)
	141-0594-401	.085 (2.16)
	141-0694-002	.085 (2.16)

SMA Straight Solder Type for Semi-Rigid Cable

1. Identify the connector (plug or jack) and tools
2. Strip the cable jacket and dielectric to dimension shown. Do not nick the center conductor.
3. Bevel the entire diameter on the end of the cable center conductor until the point resembles the appropriate dimensional profile. This operation can be accomplished effectively by using the recommended center conductor pointing tool as described in step 4.
4. Insert the stripped cable into the bushing of the appropriate pointing tool until the center conductor just touches the blade. While maintaining light pressure on the center conductor against the blade, turn the tool in a counter-clockwise fashion as viewed from the bushing end of the tool. Continue cutting the center conductor point until the cable jacket bottoms out inside the bushing.
5. Attach the appropriate soldering mating fixture to the connector and tighten to a maximum of 8 inch pounds of torque.
6. Clean all debris from the prepared cable and insert the cable into the connector, making sure that the cable jacket bottoms out against the internal shoulder of the connector body.
7. Insert the stop screw into the mating fixture. Clamp the cable and fixtured connector assembly securely in the soldering vise. Solder the connector body to the cable as shown, while insuring the cable dielectric expansion does not move the assembly. Allow the assembly to cool before removing the connector from the fixture

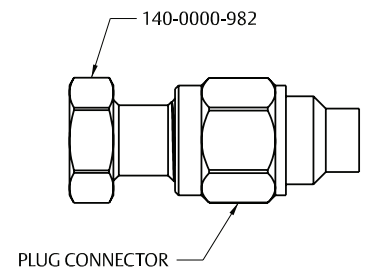
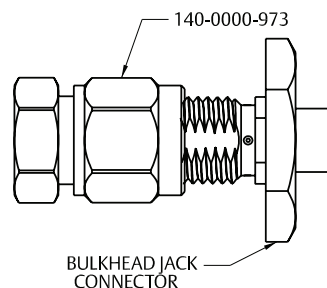
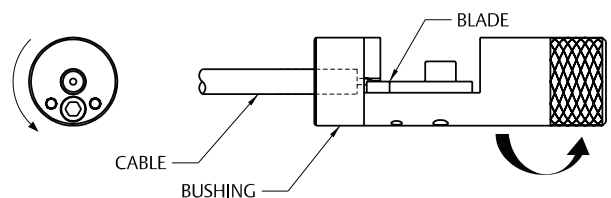
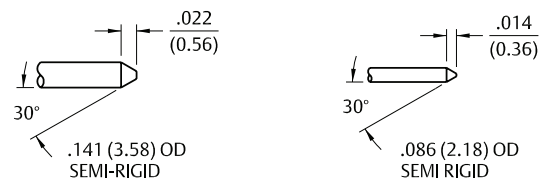
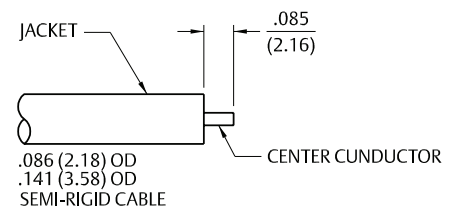
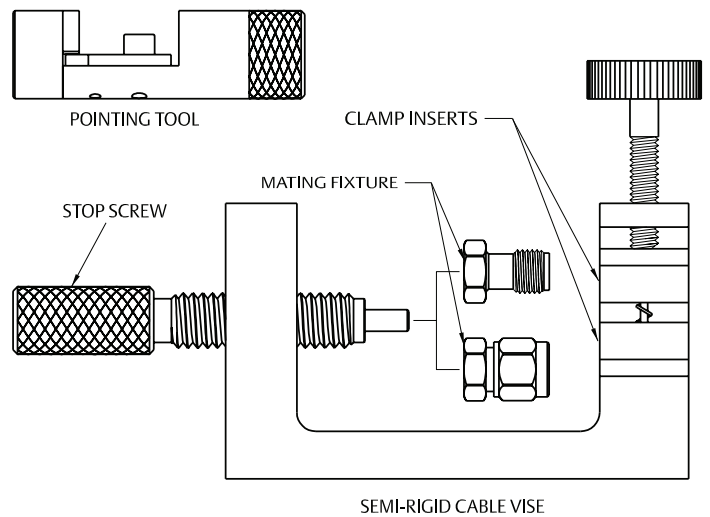

Cable Type	Part No.
RG-405/U (.086 Semi-Rigid)	141-0593-421
	141-0693-062
RG-402/U (.141 Semi-Rigid)	141-0594-421
	141-0694-062

SMA Crimp Type Right Angle Plugs for Flexible Cable

1. Identify connector parts. (3 piece parts)
2. Strip cable to dimensions shown. Do not nick braid or center conductor. When stripping LMR-100 low loss cable, remove foil back to where cable jacket is stripped. A wire stripper of correct size is recommended for this step. Twist stranded center conductor into tight bundle and tin (optional). Slide crimp sleeve onto cable as shown.
3. Flare braid and slide cable into body making certain that the cable insulation bottoms on center contact. Solder center conductor to contact through the rear access port. Use a minimum amount of solder for a full fillet joint. **.020 (0.51) diameter solder is recommended.**
4. Arrange braid uniformly around crimp stem. Slide crimp sleeve over braid and crimp securely using recommended crimp tool. Place expansion cap in access port and seat with .187 (4.75) diameter flat punch. Shrink heat shrink tubing over crimp sleeve if applicable.

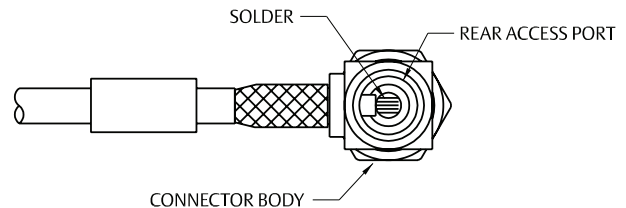
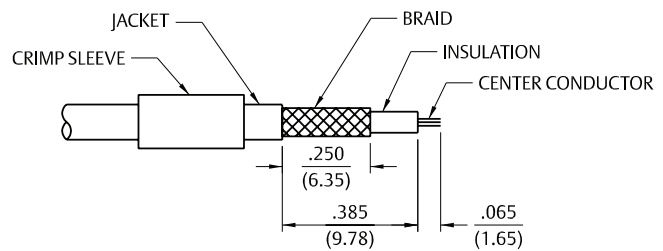

Cable Type	Part No.	Crimp Hex
RG-316/U, 161, 174, 188; LMR-100	141-0403-102	.128 (3.25)
RG-316 DS, 188 DS	141-0404-112	.151 (3.83)
RG-58/U, 141, 303	141-0407-102	.213 (5.41)
RG-55/U, 142, 223, 400	141-0408-102	.213 (5.41)

COMPETITOR CROSS REFERENCE

JOHNSON	HUBER SUHNER	AMP/TYCO	RADIAL	AMPHENOL	AEP
141-0403-012	11SMA-50-2-55C	225532-4	R125072001	901-9511-3SFC	9101-9573-03
141-0404-012	11SMA-50-2-56C		R125072081	901-9511-12SFC	9101-9573-19
141-0407-012	11SMA-50-3-55C	225532-1	R125075001	901-9511-2SF	9101-9573-06
141-0408-012	11SMA-50-3-56C	225532-3	R125076001	901-9511-1SF	9101-9573-01
141-0403-102	16SMA-50-2-55C	225609-4	R125172001	901-9531-3SF	9043-9523-03
141-0404-102	16SMA-50-2-56C		R125174011	901-9531-12SF	9043-9523-19
141-0407-102	16SMA-50-3-55C	225609-1	R125175001	901-9531-2SF	9043-9523-06
141-0408-102	16SMA-50-3-56C	225609-3	R125176001	901-9531-1	9043-9523-01
141-0693-002	11SMA-50-2-65		R125052002	901-9201-2A	9401-1083-010
141-0694-002	11SMA-50-3-65				9401-1083-109
141-0694-012	11SMA-50-3-64		R125054002	901-9201-1A	9301-1063-009
141-0693-062	11SMA-50-2-65		R125052002	901-9723	9401-1583-010
141-0694-062	11SMA-50-3-65		R125057002	901-9808	9401-1583-109
141-0303-412		225608-4	R125312121	901-9610-3SF	9130-9573-03
141-0304-412		1-225608-1	R125313121	901-9610-12SF	9130-9573-19
141-0307-412			R125314121	901-9610-2SF	9130-9573-06
141-0308-412		225608-3	R125315121	901-9610-1SF	9130-9573-01
141-0593-001			R125222000	901-9202-2A	9402-1533-010
141-0594-001			R125225000	901-9202-1A	9402-1583-009
141-0593-401	24SMA-50-2-41		R125326000		9453-1083-010
141-0594-401	24SMA-50-3-41		R125325000		9453-1083-009
141-0593-421	24SMA-50-2-41		R125326000		9453-1583-010
141-0594-421	24SMA-50-3-41		R125325000		9453-1083-009
141-0701-201	82SMA-50-0-1	221789-1	R125426000	901-144	9650-1113-000
141-0701-301	85SMA-50-0-1	221790-1	R125680000	901-143	9647-1513-000
141-0701-402	22SMA-50-0-54	228496-1	R125553001	901-9211-SF	9412-9113-000
141-0701-602	23SMA-50-0-61	221641-1	R125454001		9408-9113-000
141-0701-612	23SMA-50-0-51	221640-1	R125403001	901-9215-SF	9404-9113-000
141-0701-622	23SMA-50-0-63		R125464274	901-9000-CCSF	9008-9113-000
141-0701-602	23SMA-50-0-53		R125415275	901-9204-CCSF	9004-9113-000

Emerson Network Power Connectivity Solutions

Johnson
299 Johnson Avenue
Waseca, MN 56093
USA

Tel: 800.247.8256
Fax: 507.833.6287

www.EmersonNetworkPower.com/Connectivity

About Emerson Network Power Connectivity Solutions

Emerson Network Power Connectivity Solutions, an Emerson business, serves the needs of wireless communications, telephony and data networks, CATV, security systems, health care and industrial facilities with a full spectrum of broadband copper and fiber optic connectivity products. For more information, visit www.EmersonNetworkPower.com/Connectivity.

About Emerson

Emerson (NYSE: EMR), based in St. Louis, is a global leader in bringing technology and engineering together to provide innovative solutions to customers through its network power, process management, industrial automation, climate technologies, and appliance and tools businesses. Sales in fiscal 2005 were \$17.3 billion. For more information, visit www.gotoemerson.com.

Emerson Network Power.

The global leader in enabling business-critical continuity.

- | | | |
|--------------------|--------------------------------|--------------------------------|
| ■ AC Power Systems | ■ Embedded Power | ■ Outside Plant |
| ■ Connectivity | ■ Inbound Power | ■ Precision Cooling |
| ■ DC Power Systems | ■ Integrated Cabinet Solutions | ■ Site Monitoring and Services |

www.EmersonNetworkPower.com

X-ON Electronics

Largest Supplier of Electrical and Electronic Components

Click to view similar products for [RF Connectors / Coaxial Connectors](#) category:

Click to view products by [Bel Fuse](#) manufacturer:

Other Similar products are found below :

[8915-1511-000](#) [89674-0827](#) [6001-7071-019](#) [6002-7051-003](#) [6002-7551-202](#) [6059674-1](#) [619550-1](#) [630059-000](#) [M39030/3-01N](#) [6500-7071-046](#) [6769](#) [CX050L2AQ](#) [7002-1541-010](#) [7002-1542-011](#) [7004-1512-000](#) [7009-1511-004](#) [7010-1511-000](#) [7029-1511-060](#) [7101-1541-010](#) [7101-1571-002](#) [7145-1521-002](#) [7203-1571-003](#) [7209-1511-011](#) [7210-1511-015](#) [7210-1511-019](#) [73137-5015](#) [73216-2241](#) [73404-2300](#) [7405-1521-005](#) [7405-1521-802](#) [8527](#) [8547](#) [FS11V](#) [877931](#) [8808-1511-001](#) [9049-9513-000](#) [9074-9513-000](#) [9101-9573-002](#) [910A205F](#) [9130-9573-002](#) [PL11SC-026](#) [PL375-33](#) [PL40-5](#) [PL74C-221](#) [PL75MC-217](#) [PL803-7](#) [1200690078](#) [1-201144-1](#) [R107003010W](#) [R110A172100](#)