



MODEL NUMBER	PACKAGING	RoHS STATUS
142-0711-201	25/BAG BULK PACK	RoHS
142-0711-202	500 PCS. TAPE & REEL w/.005 THK COVER TAPE PER FIG 1	
142-0711-205 	25/BAG BULK PACK	NON-RoHS
142-0711-206 	500 PCS. TAPE & REEL w/.005 THK COVER TAPE PER FIG 1	



NOTES: UNLESS OTHERWISE SPECIFIED.

1. MATERIAL & FINISH:

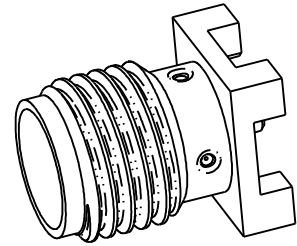
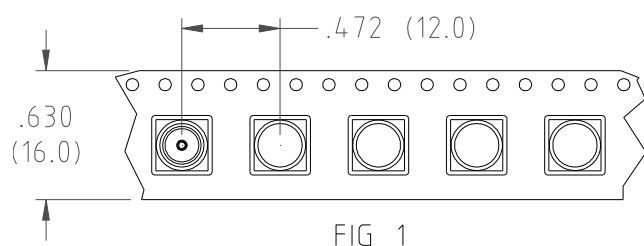
- 1.1 BODY:
 - 1.1.1 142-0711-201 & -202: GOLD PLATED BRASS
 - 1.1.2 142-0711-205 & -206: NICKEL PLATED BRASS
- 1.2 DIELECTRIC: PTFE (TEFLON)
- 1.3 CENTER CONTACT: GOLD PLATED BERYLLIUM COPPER

2. ELECTRICAL:

- 2.1 IMPEDANCE: 50 OHMS
- 2.2 FREQUENCY RANGE: 0-18 GHz
- 2.3 WORKING VOLTAGE: 335 VRMS MAX AT SEA LEVEL
- 2.4 DIELECTRIC WITHSTANDING VOLTAGE: 1000 VRMS MIN AT SEA LEVEL
- 2.5 INSULATION RESISTANCE: 5000 MEGOHM MIN
- 2.6 CONTACT RESISTANCE:
 - 2.6.1 CENTER CONTACT: INITIAL 3.0 MILLIOHM MAX, AFTER ENVIRONMENTAL 4.0 MILLIOHM MAX.
 - 2.6.2 OUTER CONDUCTOR: INITIAL 2.0 MILLIOHM MAX
- 2.7 CORONA LEVEL: 250 VOLTS MIN AT 70,000 FEET
- 2.8 RF HIGH POTENTIAL WITHSTANDING VOLTAGE: 670 VRMS MIN AT 4 & 7 MHz

3. MECHANICAL:

- 3.1 ENGAGE/DISENGAGE TORQUE: 2 IN-LBS MAX
- 3.2 MATING TORQUE: 7-10 IN-LBS
- 3.3 CONTACT RETENTION: 6 LBS MIN AXIAL FORCE, 4 IN-OZ MIN RADIAL TORQUE
- 3.4 DURABILITY: 500 CYCLES MIN.

4. ENVIRONMENTAL: (MEETS OR EXCEEDS THE APPLICABLE PARAGRAPH OF MIL-PRF-39012)



- 4.1 THERMAL SHOCK: MIL-STD-202, METHOD 107, CONDITION B
- 4.2 OPERATING TEMPERATURE: -65°C TO 165°C
- 4.3 CORROSION: MIL-STD-202, METHOD 101, CONDITION B
- 4.4 SHOCK: MIL-STD-202, METHOD 213, CONDITION I
- 4.5 VIBRATION: MIL-STD-202, METHOD 204, CONDITION D
- 4.6 MOISTURE RESISTANCE: MIL-STD-202, METHOD 106.

 BOTTOM OF CONNECTOR MOUNTING PADS PRE-TINNED WITH 60%/40% TIN/LEAD SOLDER.

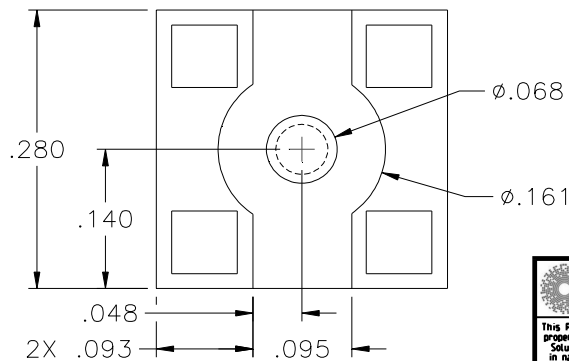
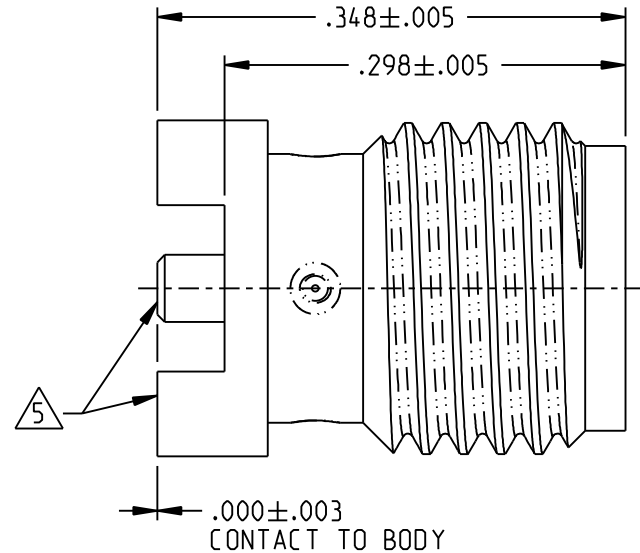
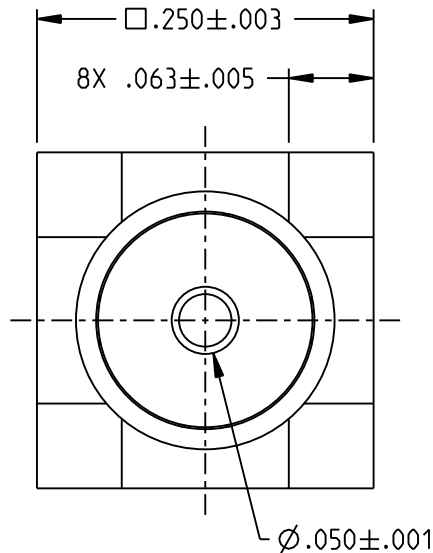
 LAND PATTERN FOR REFERENCE ONLY. PATTERN MAY VARY DEPENDING ON ASSEMBLY PROCESS, BOARD TYPE OR SPECIFIC ELECTRICAL OR MECHANICAL REQUIREMENTS.



RECOMMENDED LAND PATTERN 

 <small>This PROPRIETARY Document is property of Cinch Connectivity Solutions. It is confidential in nature, non-transferable, and issued with the clear understanding that it is not traced or copied without permission and is returnable upon demand.</small> <small>INTERPRET DRAWING IN ACCORDANCE WITH ASME Y14.5-2009.</small>		JOHNSON	
	SEE TABLE	Title: JACK ASSEMBLY STRAIGHT PC SURFACE MOUNT SMA	
	UNLESS OTHERWISE SPECIFIED UNITS: INCH	Model No. 142-0711-201/210	
	.XX ±.02 .XXX ±.010 ANGLES ±2°	Size A	DO NOT SCALE DRAWING

X-ON Electronics

Largest Supplier of Electrical and Electronic Components

Click to view similar products for [RF Connectors / Coaxial Connectors](#) category:

Click to view products by [Bel Fuse](#) manufacturer:

Other Similar products are found below :

[8915-1511-000](#) [89674-0827](#) [6001-7071-019](#) [6002-7051-003](#) [6002-7551-202](#) [6059674-1](#) [619550-1](#) [630059-000](#) [M39030/3-01N](#) [6500-7071-046](#) [6769](#) [CX050L2AQ](#) [7002-1541-010](#) [7002-1542-011](#) [7004-1512-000](#) [7009-1511-004](#) [7010-1511-000](#) [7029-1511-060](#) [7101-1541-010](#) [7101-1571-002](#) [7145-1521-002](#) [7203-1571-003](#) [7209-1511-011](#) [7210-1511-015](#) [7210-1511-019](#) [73137-5015](#) [73216-2241](#) [73404-2300](#) [7405-1521-005](#) [7405-1521-802](#) [8527](#) [8547](#) [FS11V](#) [877931](#) [8808-1511-001](#) [9049-9513-000](#) [9074-9513-000](#) [9101-9573-002](#) [910A205F](#) [9130-9573-002](#) [PL11SC-026](#) [PL375-33](#) [PL40-5](#) [PL74C-221](#) [PL75MC-217](#) [PL803-7](#) [980-8666-005](#) [1200690078](#) [1-201144-1](#) [R107003010W](#)