

MODEL NO.	PACKAGING
147-0701-822	ONE PCS PER BAG

REV	ECO	DATE
001	ECO-19-0037	08/28/2019

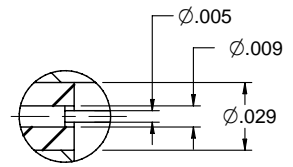

DETAIL A (15/1)

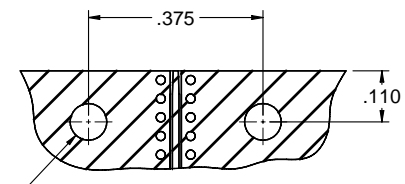
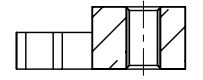
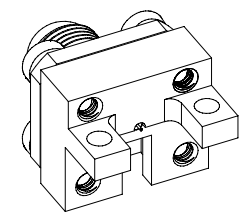
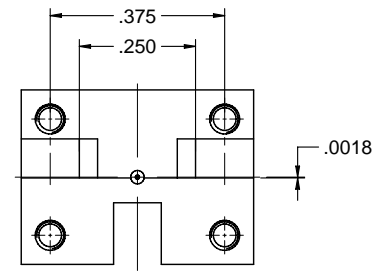
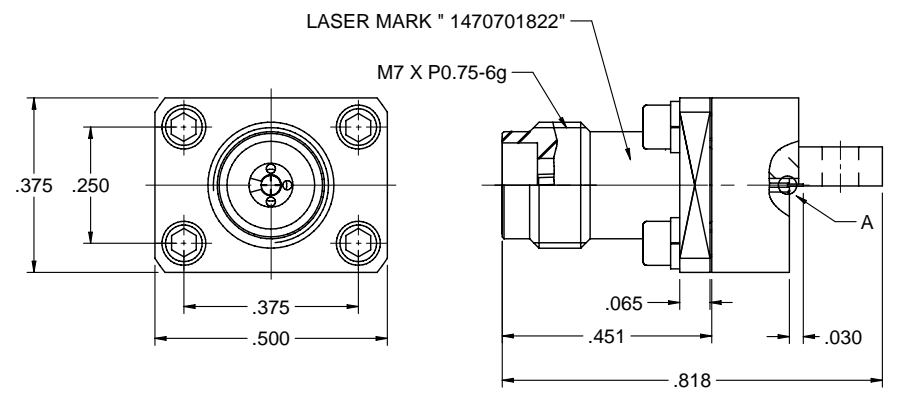
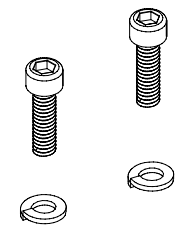
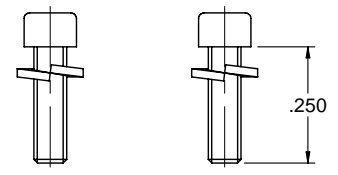

PCB LAYOUT

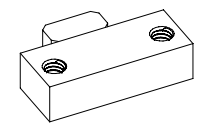
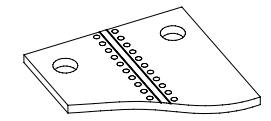

NOTES: UNLESS OTHERWISE SPECIFIED

1. MATERIAL & FINISH:
 - 1.1 MAIN BODY: PASSIVATED STAINLESS STEEL
 - 1.2 MOUNTING BODY: NICKEL PLATED BRASS
 - 1.3 CONTACT PIN: GOLD PLATED BERYLLIUM COPPER
 - 1.4 MAIN INSULATOR: ULTEM 1000, AMBER
 - 1.5 MOUNTING INSULATOR: PTFE, WHITE
 - 1.6 WASHER, BOLT: STAINLESS STEEL
2. ELECTRICAL:
 - 2.1 IMPEDANCE: 50 OHMS
 - 2.2 FREQUENCY RANGE: DC-50 GHz
 - 2.3 RETURN LOSS: -20DB MAX
 - 2.4 DIELECTRIC WITHSTANDING VOLTAGE: 500 VRMS MIN
 - 2.5 CONTACT RESISTANCE:
 - 2.5.1 CENTER CONTACT: 4 MILLIOHMS MAX
 - 2.5.2 OUTER CONTACT: 2.5 MILLIOHMS MAX
3. MECHANICAL:
 - 3.1 DURABILITY: 500CYCLES MIN
4. ENVIRONMENT:
 - 4.1 OPERATING TEMPERATURE: -55 TO 125°C
 - 4.2 THERMAL SHOCK: MIL-STD-202, METHOD 107, CONDITION B.
 - 4.3 SHOCK: MIL-STD-202, METHOD 213, CONDITION I
 - 4.4 VIBRATION: MIL-STD-202, METHOD 204, CONDITION D
 - 4.5 MOISTURE RESISTANCE: MIL-STD-202, METHOD 106
 - 4.6 SALT SPRAY: MIL-STD-202, METHOD 101, CONDITION B

	Model No. 147-0701-821/830		RoHS 2011/65/EU		REACH		Model No. 147-0701-821/830		

X-ON Electronics

Largest Supplier of Electrical and Electronic Components

Click to view similar products for [RF Connectors / Coaxial Connectors](#) category:

Click to view products by [Bel Fuse](#) manufacturer:

Other Similar products are found below :

[8915-1511-000](#) [89674-0827](#) [6001-7071-019](#) [6002-7051-003](#) [6002-7551-202](#) [6059674-1](#) [619550-1](#) [630059-000](#) [M39030/3-01N](#) [6500-7071-046](#) [6769](#) [CX050L2AQ](#) [7002-1541-010](#) [7002-1542-011](#) [7004-1512-000](#) [7009-1511-004](#) [7010-1511-000](#) [7029-1511-060](#) [7101-1541-010](#) [7101-1571-002](#) [7145-1521-002](#) [7203-1571-003](#) [7209-1511-011](#) [7210-1511-015](#) [7210-1511-019](#) [73137-5015](#) [73216-2241](#) [73404-2300](#) [7405-1521-005](#) [7405-1521-802](#) [8527](#) [8547](#) [FS11V](#) [877931](#) [8808-1511-001](#) [9049-9513-000](#) [9074-9513-000](#) [9101-9573-002](#) [910A205F](#) [9130-9573-002](#) [PL11SC-026](#) [PL375-33](#) [PL40-5](#) [PL74C-221](#) [PL75MC-217](#) [PL803-7](#) [1200690078](#) [1-201144-1](#) [R107003010W](#) [R110A172100](#)