



Features

Wide input voltage ranges up to 150 VDC
1 or 2 outputs up to 48 VDC
1200 to 3000 VAC I/O electric strength test

- Extremely wide input voltage ranges
- Electrical isolation, also between outputs
- Emissions EN 55022 level A
- Immunity to IEC/EN 61000-4-2,-3,-4,-5, and -6
- High efficiency (typ. 87%)
- Input undervoltage lockout
- Shut down input, adjustable output voltages
- Flex power: Flexible load distribution on outputs
- Outputs no-load, overload and short-circuit proof
- Operating ambient temperature –40 to 85 °C
- Thermal protection
- 2" x 1.6" case with 10.5 mm profile
- Supplementary insulation: 20/40IMX15 models
- Double or reinforced insulation: 110IMY15 models



¹ For 110IMY15 models

Description

The IMX15 and IMY15 Series of board mountable 15-Watt DC-DC converters have been designed according to the latest industry requirements and standards. The converters are particularly suitable for use in mobile or stationary applications in transport, railways, industry, or telecommunication where variable input voltages or high transient voltages are prevalent.

Covering a total input voltage range from 8.4 up to 150 V with 3 different models, the units are available with single, dual and electrically-isolated double outputs from 3.3 up to 48 V externally adjustable, with flexible load distribution on dual and double output units. A shut down input allows remote converter on-off. Features include consistently high efficiency over the entire input voltage range, high reliability and excellent dynamic response to load and line changes.

The converters are designed and built according to the international safety standards IEC/EN/UL 60950 and approved by TÜV, UL and cUL. The models 20IMX15 and

40IMX15 provide supplementary insulation. Connected to a secondary circuit the 40IMX15 models provide SELV outputs, even if the bus voltage at the converter input exceeds the SELV-limit of 60 VDC. The 110IMY15 models provide double insulation and are CE marked. They may be connected for example to a rectified 110 VAC source without any further isolation barrier.

The circuit comprises of integrated planar magnetics and all components are automatically assembled and solidly soldered onto a single PCB without any wire connection. Magnetic feedback ensures maximum reliability and repeatability in the control loop over all operating conditions. Careful considerations of possible thermal stresses ensure the absence of hot spots providing long life in environments where temperature cycles are a reality. The thermal design allows operation at full load up to an ambient temperature of 85 °C in free air without using any potting material. For extremely high vibration environments the case has holes for screw mounting.

Table of Contents

Table of Contents	Page	Page	
Description	1	Electromagnetic Compatibility (EMC)	13
Model Selection	2	Immunity to Environmental Conditions	15
Part Number Description	3	Mechanical Data	16
Functional Description	4	Safety and Installation Instructions	17
Electrical Input Data	5	Description of Options	18
Electrical Output Data	7	EC Declaration of Conformity	19
Auxiliary Functions	12		

Model Selection

Table 1: Model Selection

Output 1		Output 2		Output power $P_{o\ nom}$ [W]	Input voltage $V_{i\ min}$ to $V_{i\ max}$ [VDC]	Efficiency η^6 [%]	Model	Options ²
$V_{o\ nom}$ [VDC]	$I_{o\ nom}^1$ [A]	$V_{o\ nom}$ [VDC]	$I_{o\ nom}^1$ [A]					
3.3	4.5	-	-	14.9	8.4 to 36 ⁵	84	20IMX15-03-8RG ⁷	-9, i, Z
3.3	4.0	-	-	13.2	16.8 to 75 ³	80	40IMX15-03-8R ⁷	i, Z
3.3	4.5	-	-	14.9	16.8 to 75 ³	85	40IMX15-03-8RG ⁷	-9, i, Z
3.3	4.5	-	-	14.9	50 to 150 ⁴	84	110IMY15-03-8RG ⁷	i, Z
5.1	3.5	-	-	17.5	8.4 to 36 ⁵	86	20IMX15-05-8RG ⁷	i, Z
5.1	3.5	-	-	17.5	16.8 to 75 ³	87	40IMX15-05-8RG ⁷	i, Z
5.1	3.5	-	-	17.5	50 to 150 ⁴	86	110IMY15-05-8RG ⁷	i, Z
5.1	2.3	-	-	11.7	8.4 to 36 ⁵	85	20IMX15-05-8R ⁷	-9, i, Z
5.1	2.5	-	-	12.8	16.8 to 75 ³	83	40IMX15-05-8R ⁷	-9, i, Z
5.1	2.5	-	-	12.8	50 to 150 ⁴	83	110IMY15-05-8R ⁷	i, Z
5.1	1.35	3.3	1.35	11.3	8.4 to 36 ⁵	84	20IMX15-0503-8R	-9, i, Z
5.1	1.5	3.3	1.5	12.6	16.8 to 75 ³	84	40IMX15-0503-8R	-9, i, Z
5.1	1.5	3.3	1.5	12.6	50 to 150 ⁴	82	110IMY15-0503-8R	i, Z
5	1.3	5	1.3	13.0	8.4 to 36 ⁵	86	20IMX15-05-05-8	-9, i, R, Z
5	1.4	5	1.4	14.0	16.8 to 75 ³	86	40IMX15-05-05-8	-9, i, R, Z
5	1.4	5	1.4	14.0	50 to 150 ⁴	86	110IMY15-05-05-8	i, Z
12	0.65	12	0.65	15.6	8.4 to 36 ⁵	88	20IMX15-12-12-8	-9, i, Z
12	0.7	12	0.7	16.8	16.8 to 75 ³	88	40IMX15-12-12-8	-9, i, R, Z
12	0.7	12	0.7	16.8	50 to 150 ⁴	87	110IMY15-12-12-8	i, Z
15	0.5	15	0.5	15.0	8.4 to 36 ⁵	88	20IMX15-15-15-8	-9, i, R, Z
15	0.56	15	0.56	16.8	16.8 to 75 ³	88	40IMX15-15-15-8	-9, i, R, Z
15	0.56	15	0.56	16.8	50 to 150 ⁴	87	110IMY15-15-15-8	i, R, Z
24	0.32	24	0.32	15.4	8.4 to 36 ⁵	86	20IMX15-24-24-8	-9, i, R, Z
24	0.35	24	0.35	16.8	16.8 to 75 ³	86	40IMX15-24-24-8	-9, i, R, Z
24	0.35	24	0.35	16.8	50 to 150 ⁴	86	110IMY15-24-24-8	i, Z

¹ Flexible load distribution on dual and double outputs possible up to 75% of the total output power $P_{o\ nom}$ on one of the 2 outputs. IMX/IMY15-0503 models have reduced load distribution flexibility; 1.8 A max. on one of the 2 outputs. The other output should not exceed the difference to the total output power $P_{o\ nom}$.

² See: *Description of Options*. For availability ask Power-One. **Option -9 is not recommended for new designs.**

³ Short-time operation down to $V_i = 14.4$ V possible. P_o reduced to approx. 85% of $P_{o\ nom}$.

⁴ Short-time operation down to $V_i = 43.2$ V possible. P_o reduced to approx. 85% of $P_{o\ nom}$.

⁵ Initial start-up at 9 V, main output voltage regulation down to 8.4 V.

⁶ Typ. efficiency at $V_{i\ nom}$, $I_{o\ nom}$.

⁷ These models are also available with RoHS compliance, see below. Such models are not available with option -9.

RoHS-Compliant Models

The type designation of RoHS-compliant models of the IMX/IMY15 series ends with "G". In this series an extra dash (-) is added after the existing "G", which already signifies a synchronous rectifier at the output. This is an exception to Power-One's normal nomenclature to identify RoHS-compliant products, since G is already used to designate products for higher output current fitted with a synchronous rectifier. As an example

- 20IMX15-05-8R-G means a standard version with RoHS compliance
- 20IMX15-05-8RG means a synchronous rectifier version without RoHS compliance
- 20IMX15-05-8RG-G means a synchronous rectifier version with RoHS compliance.

Please ask Power-One for availability of RoHS-compliant models.

Part Number Description

20 IMX15 - 05 - 05 - 8 R G i Z

Input voltage range V_i	
8.4 to 36 VDC	20
16.8 to 75 VDC	40
50 to 150 VDC	110
Series	IMX15, IMY15
Output voltage type output 1	03, 05, 12, 15, 24
Dash designates double output unit with two independent electrically isolated outputs	- ¹
Output voltage type output 2	03, 05, 12, 15, 24
Operating ambient temperature range T_A	
-40 ⁵ to 85 °C (standard)	-8
-40 ⁵ to 71 °C NFND	-9
Options and features:	
R input and magnetic feedback	R ^{2,3}
Synchronous rectification	G
Inhibit	i ^{2,4}
Open frame	Z

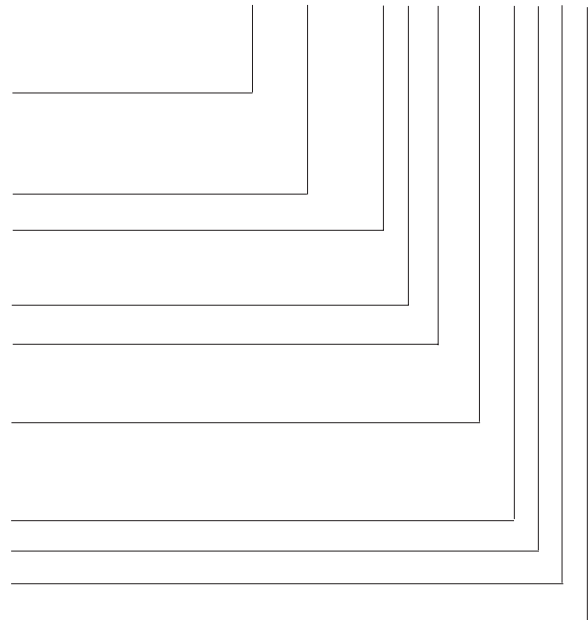

¹ Not applicable to -0503 models.
² For lead times contact Power-One. Some types require a minimum order quantity.
³ Standard features for single output and -0503- models.
⁴ Option i excludes shut down.
⁵ Only -25 °C for -RG models.

Examples: 20IMX15-05-05-8: DC-DC converter, input voltage 9 to 36 V, 2 electrically isolated outputs each providing 5 V, 1.3 A.

110IMY15-0503-8R: DC-DC converter, input voltage 50 to 150 V, 2 outputs with common return providing +5.1 V, 1.5 A and +3.3 V, 1.5 A. Unit fitted with magnetic feedback for tight output voltage regulation.

Product Marking

Basic type designation, input and output voltages and currents, applicable safety approval and recognition marks, Power-One patent nos., company logo, date code and serial numbers.

Functional Description

The IMX/IMY15 series of DC-DC converters are magnetic feedback-controlled flyback converters using current mode PWM (Pulse Width Modulation). The -05- and -0503-output voltage models as well as all double output models fitted with option R feature an active magnetic feedback loop via a pulse transformer, which results in very tight regulation of the output voltage (see the block diagrams). The output voltages of these versions can be adjusted via the R input. The R input is referenced to the secondary side and allows for programming of the output voltages in the range of approximately 80 to 105% of $V_{o\ nom}$ using either an external resistor or an external voltage source.

The voltage regulation on the dual and double output models without option R is achieved with a passive transformer feedback from the main transformer (see fig. 3: *Block diagram of double output models*). The output voltages can be adjusted via the Trim input. The Trim input is referenced to the primary side of the converter and allows for programming of the output voltages in the range 100 to 105% of $V_{o\ nom}$ via an external resistor or within 75 to 105% using an external voltage source. The load regulation output characteristic allows for paralleling of one or several double output units with equal output voltages.

Current limitation is provided by the primary circuit, thus limiting the total output power of double output types. The shut down input allows remote converter on/off.

Overtemperature protection will disable the unit under excessive overload conditions with automatic restart.

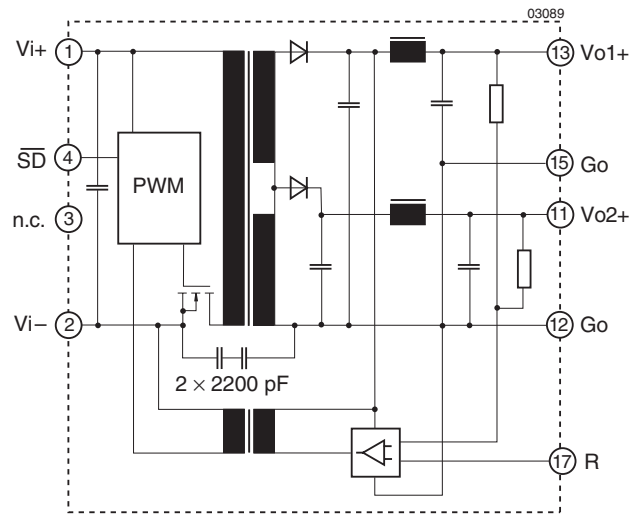

Fig. 2
Block diagram of -0503-models.

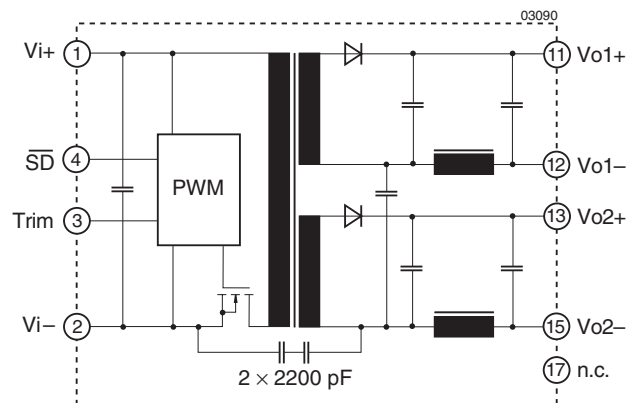

Fig. 3
Block diagram of double output models.

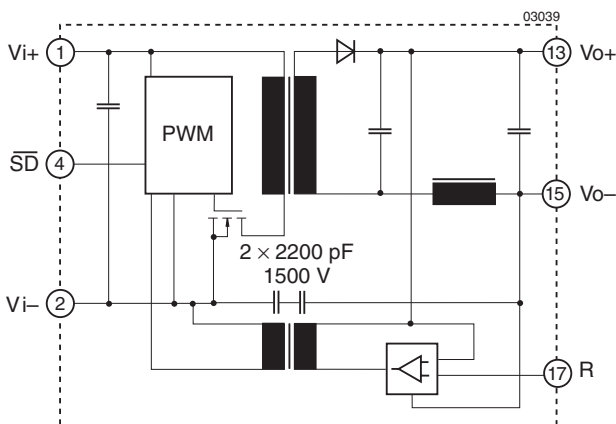

Fig. 1
Block diagram of single output models

Electrical Input Data

General conditions:

- $T_A = 25\text{ }^\circ\text{C}$, unless T_C is specified.
- Shut down pin left open-circuit.
- Trim or R input left open-circuit.

Table 2: Input Data

Input			20IMX		40IMX		110IMY		
Characteristics		Conditions	min	typ	max	min	typ	max	Unit
V_i	Input voltage range ¹	$T_{A\text{ min}}$ to $T_{A\text{ max}}$	9 ^{5,8}		36	16.8 ^{5,6}		75	VDC
$V_{i\text{ nom}}$	Nominal input voltage	$I_o = 0$ to $I_{o\text{ nom}}$	20		40		110		
$V_{i\text{ sur}}$	Repetitive surge voltage	Abs. max input (3 s)	40		100		168		
$t_{\text{start up}}$	Converter start-up time ²	Switch on	0.25	0.5	0.25	0.5	0.25	0.5	s
		$\overline{\text{SD}}$ high	0.1		0.1		0.1		
t_{rise}	Rise time ²	$V_{i\text{ nom}}$ resistive load	5		5		5		ms
		$I_{o\text{ nom}}$ capac. load	10	20	10	20	10	20	
$I_{i\text{ o}}$	No load input current	$I_o = 0$, $V_{i\text{ min}}$ to $V_{i\text{ max}}$	40		20		10		mA
I_{irr}	Reflected ripple current	$I_o = 0$ to $I_{o\text{ nom}}$	30		30		20		mA _{pp}
$I_{\text{inr p}}$	Inrush peak current ³	$V_i = V_{i\text{ nom}}$	8		9		10		A
C_i	Input capacitance	for surge calculation	1.5		0.75		0.35		μF
$V_{\overline{\text{SD}}}$	Shut down voltage	Converter shut down	-10 to 0.7		-10 to 0.7		-10 to 0.7		VDC
		Converter operating	open or 2 to 20		open or 2 to 20		open or 2 to 20		
$R_{\overline{\text{SD}}}$	Shutdown input resistance	For current calculations	approx. 10		approx. 10		approx. 10		k Ω
$I_{\overline{\text{SD}}}$	Input current when shut down	$V_{i\text{ min}}$ to $V_{i\text{ max}}$ $\overline{\text{SD}}$ connected to Vi-	6		3		1		mA
f_s	Switching frequency	$V_{i\text{ min}}$ to $V_{i\text{ max}}$, $I_o = 0$ to $I_{o\text{ nom}}$	approx. 300		approx. 300		approx. 300		kHz
$V_{i\text{ RFI}}$	Input RFI level conducted	EN 55022 ⁴	A		A		A		

¹ If V_o is set above $V_{o\text{ nom}}$ by use of the R or Trim input, $V_{i\text{ min}}$ will be proportionately increased.

² Measured with resistive and max. admissible capacitive load.

³ Source impedance according to ETS 300132-2, version 4.3.

⁴ Measured with an ceramic capacitor C_i directly across input; output lead length 0.1 m, leads twisted. Double-output models with both outputs in parallel. C_i is specified in table 11.

⁵ Input undervoltage lockout at typ. 80% of $V_{i\text{ min}}$.

⁶ Short time operation down to $V_{i\text{ min}} > 14.4\text{ V}$ possible. P_o reduced to approx. 85% of $P_{o\text{ nom}}$.

⁷ Short time operation down to $V_{i\text{ min}} > 43.2\text{ V}$ possible. P_o reduced to approx. 85% of $P_{o\text{ nom}}$.

⁸ Initial start-up at $V_i = 9\text{ V}$, main output voltage regulation down to 8.4 V.

Inrush Current

The inrush current has been kept as low as possible by choosing a very small input capacitance. A series resistor may be installed in the input line to further reduce this current.

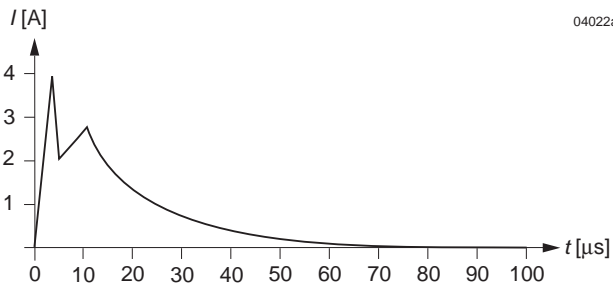

Fig. 4
Typical inrush current at $V_{i\text{nom}}$, $P_{o\text{nom}}$ versus time (40IMX15). Source impedance according to ETS 300132-2 at $V_{i\text{nom}}$.

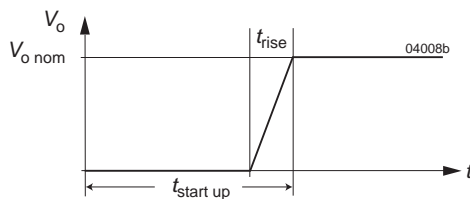

Fig. 5
Converter start-up and rise time

Input Undervoltage Lockout

A special feature of these units is the accurate undervoltage lockout protection which protects the units (and system) from large currents caused by operation at low voltages. This ensures easier start-up in distributed power systems.

Table 3: Turn-on and turn-off voltage

Type	Turn on	Turn off	Unit
20IMX	7.5 to 8	7 to 7.5	V
40IMX	12.5 to 13.5	12 to 13	
110IMY	40 to 42.5	38 to 40.5	

Fuse and Reverse Polarity Protection

The built-in suppressor diode also provides for reverse polarity protection at the input by conducting current in the reverse direction. An external fuse is required to limit this current.

Table 4: Recommended external fuses

Model	Fuse type
20IMX15	F4.0A
40IMX15	F2.0A
110IMY15	F1.0A

Input Transient Voltage Protection

A built-in suppressor diode provides effective protection against input transients, which may be caused for example by short-circuits across the input lines, where the network inductance may cause high energy pulses.

Table 5: Built-in transient voltage suppressor

Type	Breakdown voltage $V_{Br\text{nom}}$ [V]	Peak power at 1 ms P_p [W]	Peak pulse current I_{pp} [A]
20IMX15	40	1500	22
40IMX15	100	1500	9.7
110IMY15	168	600	0.5

For very high energy transients as for example to achieve compliance to IEC/EN 61000-4-5 or ETR 283 (see table: *Electromagnetic Immunity*), an external inductor and a capacitor are required, see Fig. 6. The components should have similar characteristics as listed in table 6.

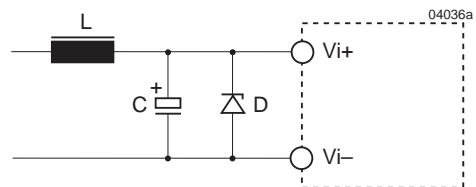

Fig. 6
Example for an external circuitry to achieve better transient immunity. The diode D is only necessary for 20IMX15 models.

Table 6: Components for external circuitry for IEC/EN 61000-4-5, level 3, or ETR 283 (19Pfl1) compliance.

Model	Inductor (L)	Capacitor (C)	Diode (D)
20IMX	68 μ H, 2.7 A	330 μ F, 63 V	1.5 k E47A
40IMX	220 μ H, 1.3 A	2 x 100 μ F, 100 V	-
110IMY	330 μ H, 0.4 A	2 x 100 μ F, 200 V	-

Electrical Output Data

We recommend to connect an external 1 μ F ceramic capacitor across the output pins.

General conditions:

- $T_A = 25^\circ\text{C}$, unless T_C is specified
- Shutdown pin and Trim or R pin left open-circuit (not connected)

Table 7a: Output data for single output models -03-8RG¹ and 05-8RG¹

Output		Conditions	3.3 V			5.1 V			Unit
Characteristics			min	typ	max	min	typ	max	
V_{o1} V_{o2}	Output voltage	$V_{i\text{nom}}$ $I_o = 0.5 I_{o\text{nom}}$	3.25		3.35	5.05		5.15	VDC
$I_{o\text{nom}}$	Output current	$V_{i\text{min}}$ to $V_{i\text{max}}$	4.5			3.5			A
	20 IMX 40 IMX/110 IMY		4.5			3.5			
I_{o1L}	Current limit ²	$V_{i\text{nom}}$, $T_C = 25^\circ\text{C}$ $V_{o1} \leq 93\% V_{o\text{nom}}$	6.0			4.6			
ΔV_o	Line/load regulation	$V_{i\text{min}}$ to $V_{i\text{max}}$, (0.1 to 1) $I_{o\text{nom}}$	± 0.5			± 0.5			%
$V_{o1/2}$	Output voltage noise	$V_{i\text{min}}$ to $V_{i\text{max}}$ $I_o = I_{o\text{nom}}$	100			100			mV _{pp}
			60			60			
V_{oL}	Output overvoltage limit. ³		115		130	115		130	%
$C_{o\text{ext}}$	Admissible capacitive load		0		4000	0		4000	μ F
V_{od}	Dynamic load regulation	Voltage deviat.	± 250			± 250			mV
t_d		Recovery time	$V_{i\text{nom}}$ $I_{o\text{nom}} \leftrightarrow 1/2 I_{o\text{nom}}$ IEC/EN 61204	1			1		
α_{V_o}	Temperature coefficient $\Delta V_o/\Delta T_C$	$V_{i\text{min}}$ to $V_{i\text{max}}$ (0.1 to 1) $I_{o\text{nom}}$	± 0.02			± 0.02			%/K

¹ All models -RG have a minimum case and operating temperature of -25°C .

² The current limit is primary side controlled. In the event of a sustained overload condition the thermal protection may cause the unit to shut down (restart on cool-down).

³ The overvoltage protection is via a primary side second regulation loop. It is not tracking with R control.

⁴ BW = 20 MHz

⁵ Measured with a probe according to EN 61204

Table 7b: Output data for -05-8R and -0503-8R models.

Output			5.1 V			5.1/3.3 V			Unit
Characteristics		Conditions	min	typ	max	min	typ	max	
V_{o1} V_{o2}	Output voltage	$V_{i\ nom}$ $I_o = 0.5 I_{o\ nom}$	5.05		5.15	5.0 3.13		5.12 3.46	VDC
$I_{o\ nom}$	Output current ¹	$V_{i\ min}$ to $V_{i\ max}$		2.3		2 x 1.35			A
	20IMX 40IMX/110IMY			2.5		2 x 1.5			
I_{o1L} I_{o2L}	Current limit ^{2,4}	$V_{i\ nom}, T_C = 25^\circ C$ $V_{o1} \leq 93\% V_{o\ nom}$		3.2		2.7 3.8			
I_{o1L} I_{o2L}			20IMX 40IMX/110 IMY		3.6		2.9 4.0		
ΔV_o	Line/load regulation	$V_{i\ min}$ to $V_{i\ max}$, (0.1 to 1) $I_{o\ nom}$		±0.5				%	
			5.1 V			+3, -5			
			3.3 V			±4.5			
$V_{o1/2}$	Output voltage noise	$V_{i\ min}$ to $V_{i\ max}$ $I_o = I_{o\ nom}$		⁵ 70 ⁶ 40		80 40		mV _{pp}	
V_{oL}	Output overvoltage limit. ⁷		115	130		115	130	%	
$C_{o\ ext}$	Admissible capacitive load			4000		total: 4000 ³		μF	
$V_{o\ d}$	Dynamic load regulation	Voltage deviat.	±250		±150		mV		
t_d		Recovery time	1		1		ms		
α_{V_o}	Temperature coefficient $\Delta U_o/\Delta T_C$	$V_{i\ min}$ to $V_{i\ max}$ (0.1 to 1) $I_{o\ nom}$		±0.02		±0.02		%/K	

¹ Flexible load distribution: 20IMX15-0503: 1.6 A max., and 40IMX15/110IMY15-0503 types: 1.8 A max. on one of the 2 outputs, the other output should not be loaded such that the total output power exceeds $P_{o\ nom}$ specified in the table: *Model Selection*.

² The current limit is primary side controlled. In the event of a sustained overload condition the thermal protection may cause the converter to shut down (restart on cool-down).

³ For -0503-models: total capacitance of both outputs.

⁴ For -0503-models: Conditions for specified output. Other output loaded with constant current $I_o = 0.5 I_{o\ nom}$.

⁵ BW = 20 MHz

⁶ Measured with a probe according to EN 61204

⁷ The overvoltage protection is via a primary side second regulation loop. It is not tracking with R control.

Table 7c: Output data for dual and double output models.

Output			2 x 5 V		2 x 12 V		2 x 15 V		2 x 24 V		Unit
Characteristics		Conditions	min	typ	max	min	typ	max	min	typ	
V_{O1} V_{O2}	Output voltage	$V_{i\ nom}$ $I_o = 0.5 I_{o\ nom}$	4.95 4.94	5.05 5.06	11.90 11.88	12.10 12.12	14.88 14.85	15.12 15.15	23.80 23.75	24.20 24.25	VDC
$I_{o\ nom}$	Output current ¹	$V_{i\ min}$ to $V_{i\ max}$	2 x 1.3		2 x 0.65		2 x 0.50		2 x 0.32		A
	20IMX 40IMX/110IMY		2 x 1.4		2 x 0.70		2 x 0.56		2 x 0.35		
I_{oL}	Current limit ^{2,4}	$V_{i\ nom}, T_C = 25\ ^\circ C$ $V_{O1} \leq 93\% V_{o\ nom}$	3.0 3.2		1.6 1.7		1.3 1.4		0.85 0.90		
ΔV_{O1} ΔV_{O2}	Line/load regulation	$V_{i\ min}$ to $V_{i\ max}, I_o\ nom$	± 1		± 1		± 1		± 1		%
	V_{O1} V_{O2}	$V_{i\ nom}$ (0.1 to 1) $I_o\ nom$	± 3		± 3		± 3		± 3		
$V_{O1/2}$	Output voltage noise	$V_{i\ min}$ to $V_{i\ max}$ $I_o = I_o\ nom$	80 40		120 60		150 70		240 120		mV _{pp}
		⁵ ⁶									
V_{oL}	Output overvoltage limit. ⁷	Min. load 1%	115	130	115	130	115	130	115	130	%
$C_{o\ ext}$	Admissible capacitive load ³		4000		680		470		180 μF		
$V_{o\ d}$ t_d	Dynamic load regulation	Voltage deviat. Recovery time	$V_{i\ nom}$ $I_o\ nom \leftrightarrow 1/2 I_o\ nom$		± 250 1		± 300 1		± 300 1		mV ms
α_{Uo}	Temperature coefficient $\Delta V_o / \Delta T_C$	$V_{i\ min}$ to $V_{i\ max}$ (0.1 to 1) $I_o\ nom$	± 0.02		± 0.02		± 0.02		± 0.02		%/K

¹ Flexible load distribution: With double or dual output units each output is capable of delivering 75% of the total output power.

The other output should not be loaded such that the total output power exceeds $P_{o\ nom}$ according to table: *Model Selection*.

² The current limit is primary side controlled. In the event of a sustained overload condition the thermal protection may cause the unit to shut down (restart on cool-down).

³ Measured with both outputs connected in parallel.

⁴ Conditions for specified output. Other output loaded with constant current $I_o = 0.5 I_o\ nom$.

⁵ BW = 20 MHz

⁶ Measured with a probe according to EN 61204

⁷ The overvoltage protection is via a primary side second regulation loop, not tracking with Trim control.

⁸ Minimum load of 10% on output 1 recommended to prevent the two output voltages to drop in unbalanced load conditions.

Thermal Considerations

If a converter, mounted on a PCB, is located in free, quasi-stationary air (convection cooling) at the indicated maximum ambient temperature $T_{A \max}$ (see table: *Temperature specifications*) and is operated at its nominal input voltage and output power, the case temperature T_C measured at the Measuring point of case temperature T_C (see: *Mechanical Data*) will approach the indicated value $T_{C \max}$ after the warm-up phase. However, the relationship between T_A and T_C depends heavily on the conditions of operation and integration into a system. The thermal conditions are influenced by input voltage, output current, airflow, temperature of surrounding components and surfaces and the properties of the printed circuit board. $T_{A \max}$ is therefore only an indicative value and under practical operating conditions, the ambient temperature T_A may be higher or lower than this value.

Caution: The case temperature T_C measured at the measuring point of case temperature T_C (see: *Mechanical Data*) may under no circumstances exceed the specified maximum value. The installer must ensure that under all operating conditions T_C remains within the limits stated in the table: *Temperature specifications*.

Overtemperature Protection

The converters are protected from possible overheating by means of an internal temperature monitoring circuit. It shuts down the unit above the internal temperature limit and attempts to automatically restart every 50 to 60 ms. This feature prevents excessive internal temperature building up, which could occur during heavy overload conditions.

Output Overvoltage Protection

The output of single-output models as well as -0503- and -05-05-models are protected against overvoltage by a second control loop. In the event of an overvoltage on one of the outputs the converter will shut down and attempt to restart in short intervals. Double and dual-output models (except -0503- and -05-05-models) are protected against overvoltage by a Zener diode across the second output. Under worst case conditions the Zener diode will short circuit. Since with double-output models both outputs track each other the protection diode is only provided in one of the outputs. The main purpose of this feature is to protect against possible overvoltage, which could occur due to a failure in the feedback control circuit. This protection circuit is not designed to withstand externally applied overvoltages.

Short Circuit Behaviour

The current limit characteristic shuts down the converter whenever a short circuit is applied to its output. It acts self-protecting, and automatically recovers after removal of the overload condition (hiccup mode).

Connection in Series

The outputs of one or several single or double output units can be connected in series without any precautions, taking into consideration that the highest output voltage should remain below 42 V to ensure that the output remains SELV.

Connection in Parallel

Double outputs of the same converter with equal output voltage (e.g., 5 V / 5 V) can be put in parallel and will share their output currents almost equally. Parallel operation of single or double outputs of two or more converters with the same output voltage may cause start-up problems at initial start-up. This is only advisable in applications, where one converter is able to deliver the full load current as, for example, required in true redundant systems.

Typical Performance Curves

General conditions:

- $T_A = 25 \text{ }^\circ\text{C}$, unless T_C is specified.
- Shut down pin left open circuit.
- Trim or R input not connected.

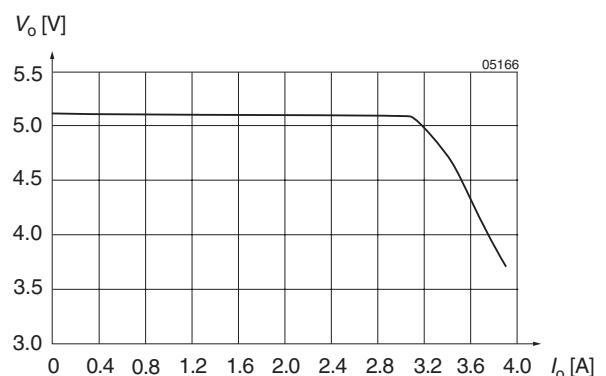

Fig. 7

V_o versus I_o (typ) of units with $V_o = 5.1 \text{ V}$.
(110IMY15-05-8R)

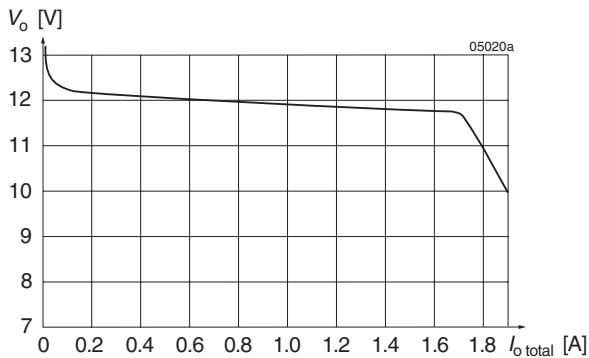

Fig. 8
 V_o versus I_o (typ.) of double-output models (2 x 12 V), with both outputs in parallel. (110IMY15-12-12-8)

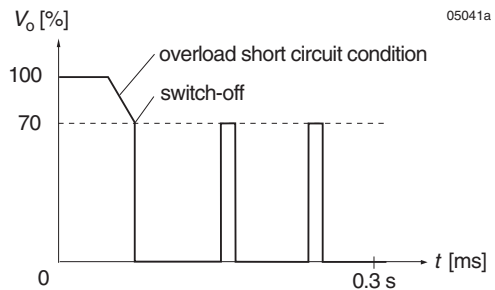

Fig. 11
Overload switch off (hiccup mode), typical values.

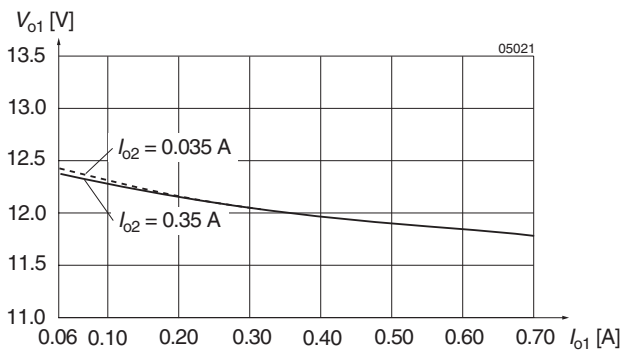

Fig. 9
Cross load regulation V_{o1} versus I_{o1} (typ.) for various I_{o2} (2 x 12 V).

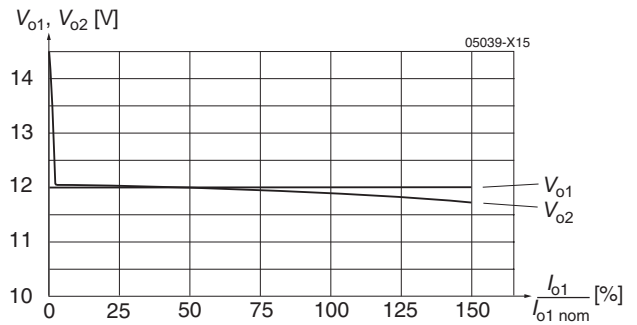

Fig. 12
Flexible load distribution on double outputs models with option R (110IMY15-12-12-8R): Load variation from 0 to 150% of $P_{o1 \text{ nom}}$ on output 1. Output 2 loaded with 50% of $P_{o2 \text{ nom}}$.

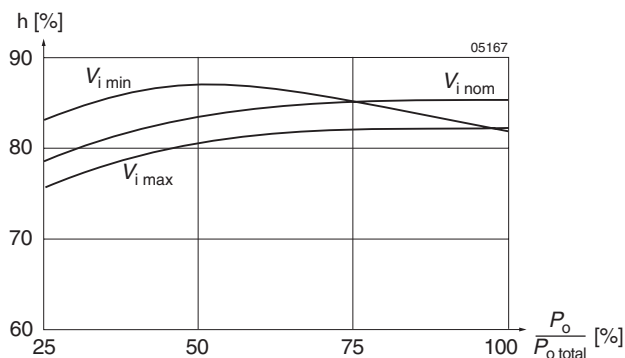

Fig. 10
Efficiency versus input voltage and load. Typical values 40IMX15-12-12-8

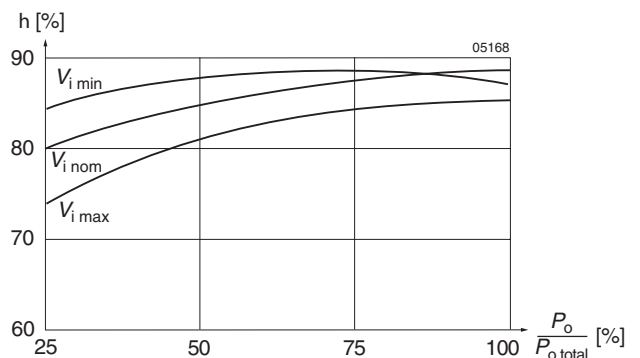

Fig. 13
Efficiency versus input voltage and load. Typical values 110IMY15-12-12-8

Auxiliary Functions

Shut Down Function

The outputs of the converters may be enabled or disabled by means of a logic signal (TTL, CMOS, etc.) applied to the shut down pin. If the shut down function is not required then it should be left open-circuit.

Converter operating: 2.0 to 20 V
Converter shut down: -10 to +0.7 V.

Adjustable Output Voltage

- R input for single output models and -0503-models
- Trim input for double output models
- R input is as option R for most double output models.

As a standard feature, the single and double output units offer adjustable output voltage(s) by using the control input R or Trim. If the control input is left open-circuit the output voltage is set to $V_{o,nom}$. For output voltages $V_o > V_{o,nom}$, the minimum input voltage $V_{i,min}$ (see: *Electrical Input Data*) increases proportionally to $V_o/V_{o,nom}$.

Single-Output models with synchronous rectifier (G):

The R input is referenced to the secondary side of the converter. Adjustment of the output voltage is possible by means of an external resistor connected between the R pin and either V_{o+} or V_{o-} .

Note: For models with synchronous rectifier the logic for V_o adjustment differs from the other models with R input.

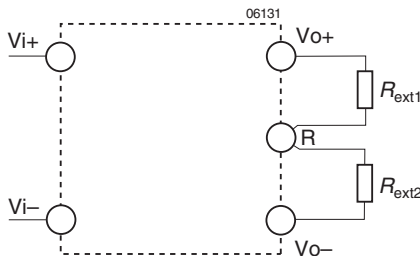

Fig. 14 Output voltage control for single output models with synchronous rectifier.

Table 8: V_o versus V_{ext} approximate values

$V_{o,nom}$ [V]	Typ. values of R_{ext1}		Typ. values of R_{ext2}	
	V_o [% of $V_{o,nom}$]	R_{ext1} [kΩ]	V_o [% of $V_{o,nom}$]	R_{ext2} [kΩ]
3.3	90	0.47	100	∞
	95	2.7	105	15
	100	∞	110	6.8
5.1	90	3.3	100	∞
	95	8.2	105	9.1
	100	∞	110	3.9

All other models fitted with R-input:

The R input is referenced to the secondary side of the converter. Adjustment of the output voltage is possible by means of either an external resistor or a voltage source.

a) Adjustment by means of an external resistor R_{ext} .

Depending upon the value of the required output voltage, the resistor shall be connected,

either: Between the R pin and V_{o-} to achieve an output voltage adjustment range of approximately $V_o = 80$ to $100\% V_{o,nom}$.

$$R_{ext1} \approx 4 \text{ k}\Omega \cdot \frac{V_o}{V_{o,nom} - V_o}$$

or: Between the R pin and V_{o+} to achieve an output voltage range of approximately $V_o = 100$ to $105\% V_{o,nom}$.

$$R_{ext2} \approx 4 \text{ k}\Omega \cdot \frac{(V_o - 2.5V)}{2.5 V \cdot (V_o/V_{o,nom} - 1)}$$

b) Adjustment by means of an external voltage V_{ext} between V_{o-} and R pins.

The control voltage range is 1.96 to 2.62 V and allows for adjustment in the range of approx. 80 to 105% of $V_{o,nom}$.

$$V_{ext} \approx \frac{V_o \cdot 2.5 V}{V_{o,nom}}$$

Attempting to adjust the output below this range will cause the converter to shut down (hiccup mode).

Note: Applying an external control voltage >2.75 V may damage the converter.

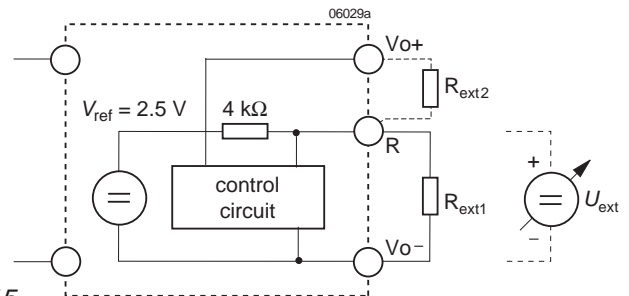

Fig. 15 Output voltage control for single output models, -0503-models and double output models fitted with option R by means of the R input.

Double-output models with Trim input:

The Trim input is referenced to the primary side. The figure below shows the circuit topology. Adjustment is possible through either an external resistor or an external voltage source V_{ext} .

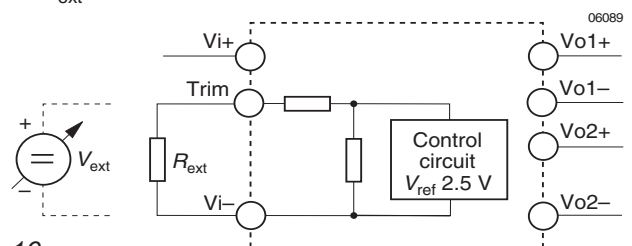

Fig. 16 Output voltage control for double output models (without option R) by means of the Trim input.

a) Adjustment by means of an external resistor R_{ext} :

Programming of the output voltage by means of an external resistor R_{ext} is possible within 100 to 105% of $V_{o\ nom}$. R_{ext} should be connected between the Trim pin and V_{i-} . Connection of R_{ext} to V_{i+} may damage the converter. The table below indicates suitable resistor values for typical output voltages under nominal conditions ($V_{i\ nom}$, $I_o = 0.5 I_{o\ nom}$), with either paralleled outputs or equal load conditions on both outputs.

Table 9a: R_{ext1} for $V_o > V_{o\ nom}$; approximate values ($V_{i\ nom}$, $I_{o1,2} = 0.5 I_{o1/2\ nom}$)

V_o [% $V_{o\ nom}$]	R_{ext} [k Ω]
105 to 108 (107 typically)	0
105	1.5
104	5.6
103	12
102	27
101	68
100	∞

b) Adjustment by an external voltage source V_{ext} :

For programming the output voltage in the range 75 to 105% of $V_{o\ nom}$ a source V_{ext} (0 to 20 V) is required, connected to the Trim pin and V_{i-} . The table below indicates typical V_o versus V_{ext} values under nominal conditions ($V_{i\ nom}$, $I_o = 0.5 I_{o\ nom}$), with either paralleled outputs or equal load conditions on both outputs. Applying a control voltage >20 V will set the converter into a hiccup mode. Direct paralleling of the Trim pins of parallel connected converters is possible.

Table 9b: V_o versus V_{ext} for $V_o = 75$ to 105% $V_{o\ nom}$; typical values ($V_{i\ nom}$, $I_{o1/2} = 0.5 I_{o1/2\ nom}$)

V_o [% $V_{o\ nom}$]	V_{ext} [V]
≥ 105	0
102	1.6
95	4.5
85	9
75	13

Electromagnetic Compatibility (EMC)

A suppressor diode together with an input filter forms an effective protection against high input transient voltages,

which typically occur in many installations, but especially in battery-driven mobile applications.

Electromagnetic Immunity

Table 10: Immunity type tests

Phenomenon	Standard	Class Level	Coupling mode ²	Value applied	Waveform	Source Imped.	Test procedure	In oper.	Per. ³ form.
Electrostatic discharge to case	IEC/EN 61000-4-2	2	contact discharge (R pin open)	4000 V _p	1/50 ns	330 Ω	10 positive and 10 negative discharges	yes	B
		3	air discharge (R pin open)	8000 V _p					
Electromagnetic field	IEC/EN 61000-4-3	3 ⁴	antenna	20 V/m	AM 80% 1 kHz	n.a.	80 to 1000 MHz	yes	A
		3	antenna	10 V/m	PM, 50% duty cycle, 200 Hz repetition frequ.	n.a.	900 MHz	yes	A
Electrical fast transient/burst	IEC/EN 61000-4-4 1	4	direct +i/-i	4000 V _p	bursts of 5/50 ns 5 kHz rep. rate transients with 15 ms burst duration and a 300 ms period	50 Ω	60 s positive 60 s negative transients per coupling mode	yes	B
Surges	IEC/EN 61000-4-5	2 3 ¹	+i/-i	1000 V _p 2000 V _p ¹	1.2/50 μ s	2 Ω	5 pos. and 5 neg. impulses per coupling mode	yes	B
Conducted disturbances	IEC/EN 61000-4-6	3	+i/-i	10 VAC (140 dB μ V)	AM modulated 80%, 1 kHz	50 Ω	0.15 to 80 MHz 150 Ω	yes	A
Transient	ETR 283 (19 Pfl 1) ¹		+i/-i	150 V _p	0.1/0.3 ms	limited to <100 A	3 positive	yes	B

¹ External components required, see Fig. 6 and table 6.

⁴ Corresponds to the railway standard EN 50121-3-2:2000, table 9.1.

² i = input, o = output.

³ A = normal operation, no deviation from specs., B = temporary deviation from specs. possible.

Conducted Emissions

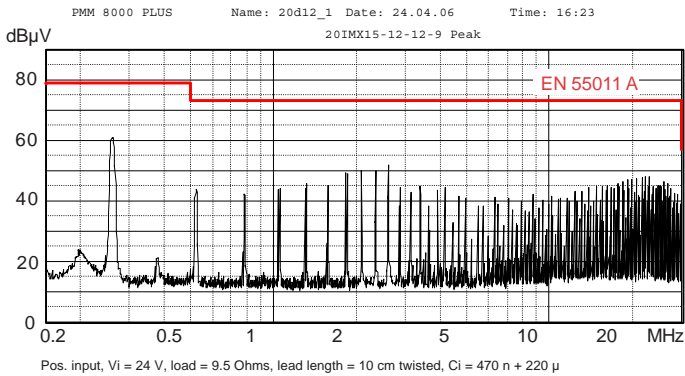

Fig. 17a
Typ. disturbance voltage (peak) at pos. input according to EN 55011/022, measured at $V_{i\text{nom}}$ and $I_{o\text{nom}}$. Output leads 0.1 m, twisted, input capacitors see fig. 11. (20IMX15-12-12-8R).

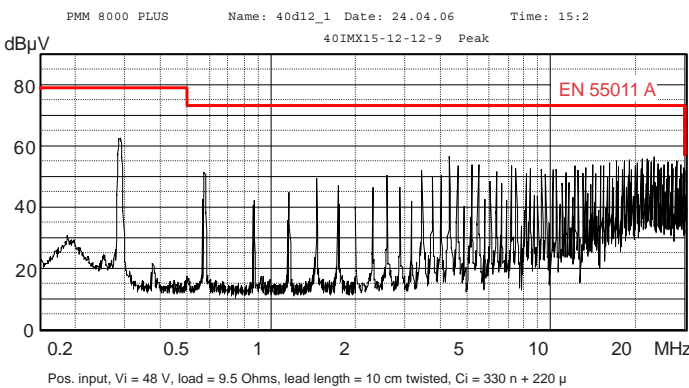

Fig. 17b
Typ. disturbance voltage (peak) at pos. input according to EN 55011/022, measured at $V_{i\text{nom}}$ and $I_{o\text{nom}}$. Output leads 0.1 m, twisted, input capacitors see tab. 11. (40IMX15-12-12-8R).

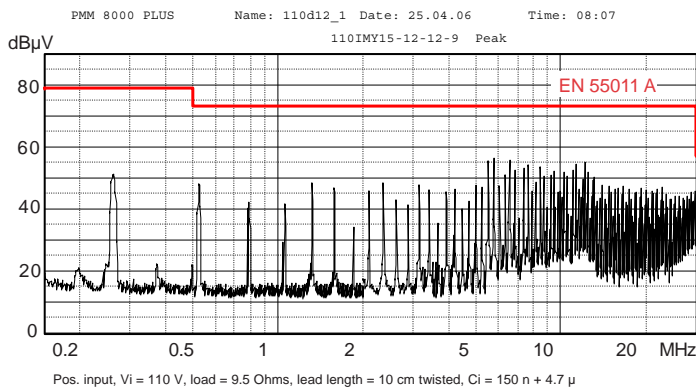

Fig. 17c
Typ. disturbance voltage (peak) at pos. input according to EN 55011/022, measured at $V_{i\text{nom}}$ and $I_{o\text{nom}}$. Output leads 0.1 m, twisted, input capacitors see tab. 11. (110IMY15-12-12-8R).

Table 11: Input capacitors to comply with EN 55011/ EN 55022, level A, conducted, see fig. 17a, b, c.

Model	Ceramic ML	Electrolytic capacitor
20IMX15	0.47 μ F/50 V	220 μ F/50 V
40IMX15	0.33 μ F/100 V	220 μ F/100 V
110IMY15	0.15 μ F/200 V	4.7 μ F/100 V

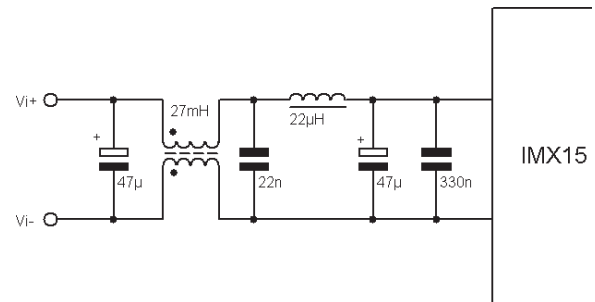

Fig. 18
Example for external circuitry to comply with EN 55011/ EN 55022, level B, conducted. This filter was designed for a 40IMX15 model. All capacitors are rated to 100 V, the chokes to 1.5 A.

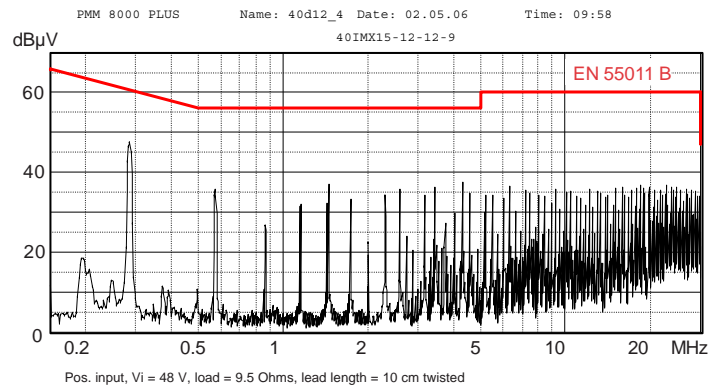

Fig. 19
Typ. disturbance voltage (peak) at pos. input according to EN 55011/022, measured at $V_{i\text{nom}}$ and $I_{o\text{nom}}$. Output leads 0.1 m, twisted, input filter see fig. 18. (40IMX15-12-12-8R).

Immunity to Environmental Conditions

Table 12: Temperature specifications

Valid for air pressure of 800 to 1200 hPa (800 to 1200 mbar)

Temperature			-9 (Option)		-8 (Standard)		Unit
Characteristics	Conditions	min	max	min	max		
T_A Ambient temperature	Operational ¹	-40 ³	71	-40 ^{2,3}	85	°C	
T_C Case temperature		-40 ³	95	-40 ^{2,3}	105		
T_S Storage temperature	Non operational	-55	100	-55	105		

¹ See: *Thermal Considerations*

² Start up at -55 °C, except -RG models.

³ -25 °C for all -RG models.

Table 13: MTBF and device hours

MTBF	Ground Benign	Ground Fixed		Ground Mobile
MTBF acc. to MIL-HDBK-217F	$T_C = 40\text{ °C}$	$T_C = 40\text{ °C}$	$T_C = 70\text{ °C}$	$T_C = 50\text{ °C}$
110IMY15-05-8R	485 000 h	255 000 h	167 000 h	223 000 h

Table 14: Mechanical stress

Test Method	Standard	Test Conditions	Status
Ca Damp heat steady state	IEC/EN 60068-2-78 MIL-STD-810D sect. 507.2	Temperature: 40 ±2 °C Relative humidity: 93 ^{+2/-3} % Duration: 56 days	Converter not operating
Ea Shock (half-sinusoidal)	IEC/EN 60068-2-27 MIL-STD-810D sect. 516.3	Acceleration amplitude: 100 $g_n = 981\text{ m/s}^2$ Bump duration: 6 ms Number of bumps: 18 (3 each direction)	Converter operating
Eb Bump (half-sinusoidal)	IEC/EN 60068-2-29 MIL-STD-810D sect. 516.3	Acceleration amplitude: 40 $g_n = 392\text{ m/s}^2$ Bump duration: 6 ms Number of bumps: 6000 (1000 each direction)	Converter operating
Fc Vibration (sinusoidal)	IEC/EN 60068-2-6	Acceleration amplitude: 0.35 mm (10 to 60 Hz) 5 $g_n = 49\text{ m/s}^2$ (60 to 2000 Hz) Frequency (1 Oct/min): 10 to 2000 Hz Test duration: 7.5 h (2.5 h each axis)	Converter operating
Fda Random vibration wide band reproducibility high	IEC/EN 60068-2-35	Acceleration spectral density: 0.05 g_n^2/Hz Frequency band: 20 to 500 Hz Acceleration magnitude: 4.9 $g_{n\text{ rms}}$ Test duration: 3 h (1 h each axis)	Converter operating
Kb Salt mist, cyclic (sodium chloride NaCl solution)	IEC/EN 60068-2-52	Concentration: 5% (30 °C) Duration: 2 h per cycle Storage: 40 °C, 93% rel. humidity Storage duration: 22 h per cycle Number of cycles: 3	Converter not operating

Mechanical Data

Dimensions in mm.

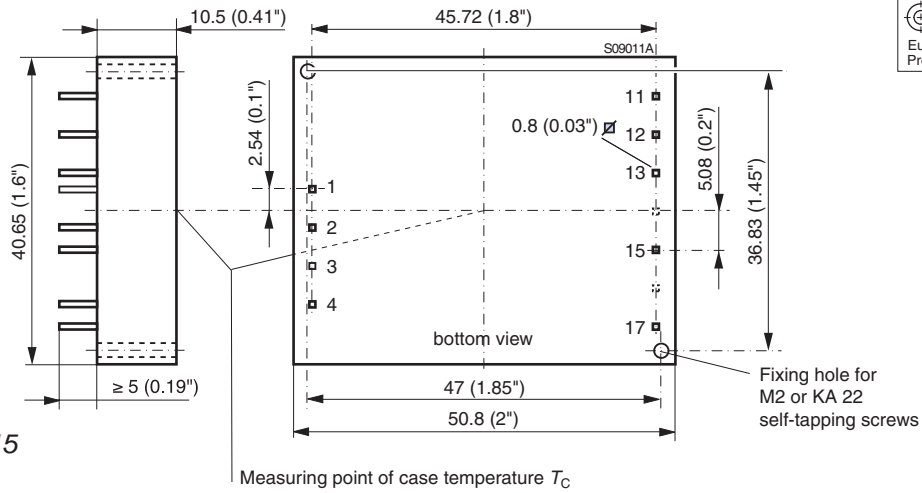
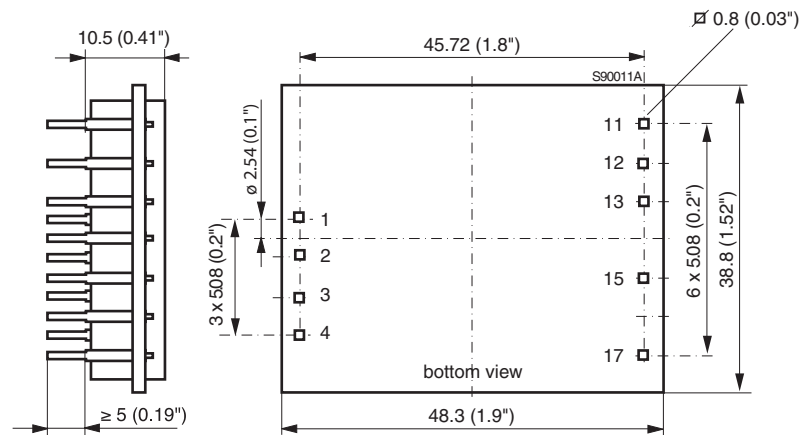

Fig. 21
Open frame (option Z)



Safety and Installation Instructions

Pin allocation

Table 15: Pin allocation

Pin	Standard and Option Z		
	single	double	-0503-
1	Vi+	Vi+	Vi+
2	Vi-	Vi-	Vi-
3	-	Trim	n.c.
4	\overline{SD}	\overline{SD}	\overline{SD}
5	-	-	-
6	-	-	-
11	-	Vo1+	Vo2+
12	-	Vo1-	Go
13	Vo+	Vo2+	Vo1+
15	Vo-	Vo2-	Go
17	R	n.c.	R

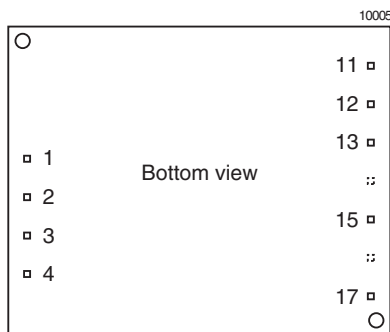

Fig. 22
Footprint

Installation Instructions

Installation of the DC-DC converters must strictly follow the national safety regulations in compliance with the enclosure, mounting, creepage, clearance, casualty, markings and segregation requirements of the end-use application.

Connection to the system shall be made via a printed circuit board with hole diameters of 1.4 mm \pm 0.1 mm for the pins.

The converter must be connected to a secondary circuit.

Check for hazardous voltages before altering any connections.

Do not open the module.

Ensure that a unit failure (e.g. by an internal short-circuit) does not result in a hazardous condition.

Input Fuse

To prevent excessive current flowing through the input supply lines in case of a malfunction an external fuse should be installed in a non-earthed input supply line (See: Table 4).

Standards and Approvals

All DC-DC converters are approved by UL and TÜV according to UL 60950, CAN/CSA C22.2 No. 950-95 and IEC/EN 60950 standards.

The converters have been evaluated for:

- Building in
- Supplementary insulation input to output, based on their maximum input voltage (IMX15 models)
- Reinforced insulation input to output, based on their maximum input voltage (IMY15 models)
- Pollution degree 2 environment (not option Z)
- Connecting the input to a secondary circuit which is subject to a maximum transient rating of 1500 V (IMX15)
- Connecting the input to a primary circuit which is subject to a maximum transient rating of 2500 V (IMY15)

The converters are subject to manufacturing surveillance in accordance with the above mentioned standards.

Railway Applications

To comply with railway standards, all components are coated with a protective lacquer (except option Z).

Protection Degree

The protection degree of the converters is IP 40, except open-frame models (option Z).

Cleaning Agents

In order to avoid possible damage, any penetration of cleaning fluids should be prevented, since the power supplies are not hermetical sealed.

However, the open-frame models (option Z) leave the factory unlacquered and may be cleaned and lacquered by the customer, for instance together with the mother board. Consult Power-One for the types of cleaning agents.

Isolation

The electric strength test is performed in the factory as routine test in accordance with EN 50116 and IEC/EN 60950, and should not be repeated in the field. Power-One will not honor any guarantee claims resulting from electric strength field tests.

Table 16: Electric strength test voltages

Characteristic	Input to output		Output to output	Unit
	IMX15	IMY15		
Factory test 1 s	1.2	3.0	0.1	kVAC
Equivalent DC voltage	1.5	4.0	0.15	kVDC
Insulation resistance at 500 VDC	>100	>100	-	M Ω
Partial discharge extinction voltage	Consult Power-One		-	kV

Description of Options

Table 17: Survey of options

Option	Function of option	Characteristic
-9	Temperature range NFND	$T_A = -40$ to 71 °C, -25 °C to 71 °C for -9RG models
R	R-input and magnetic feedback	
i	Inhibit	
Z	Open frame	See: <i>Mechanical Data</i>

Option -9 is not recommended for new designs.

Option -9 versus -8

Models with -9 (not for new designs) have a limited temperature range.

The standard models with suffix -8 are rated up to $T_A = 85$ °C (see Table: *Temperature Specifications*).

The -8 models will provide the output power in the derating curve specified in the fig. below with free air convection cooling.

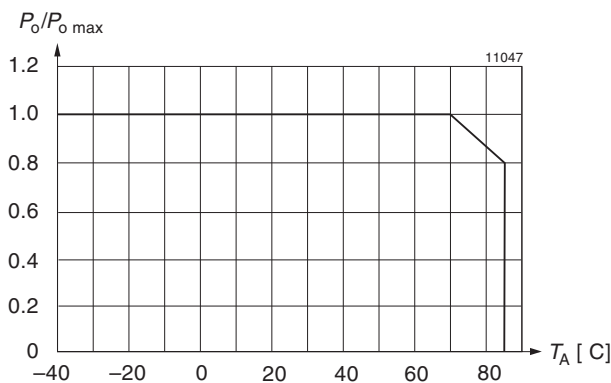

Fig. 23
Maximum allowed output power versus ambient temperature.

Option R

Magnetic feedback from the output for closer regulation of the output voltage V_{o1} of double output units (standard for single output units and -0503-models). It enables the adjustment of the output voltages via the R-input (pin 17) on the secondary side

by an external resistor or an external voltage source. This function is described in *Auxiliary Functions*.

Furthermore, the output 1 is accurately regulated like the single output models. The Trim input (pin 3) is not connected.

Option i: Inhibit

Excludes the shutdown function.

The output(s) of the converter may be enabled or disabled by means of a logic signal (TTL, CMOS, etc.) applied to the inhibit pin. No output voltage overshoot will occur, when the unit is turned on. If the inhibit function is not required, the inhibit pin should be connected to V_{i-} to enable the output (active low logic, fail safe).

Voltage on pin i:

- Converter operating: -10 V to 0.8 V
- Converter inhibited: 2.4 V to $V_{i\ max}$ (<75 V) or pin i left open-circuit:

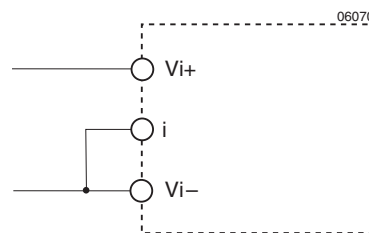

Fig. 24
If the inhibit function is not used the inhibit pin should be connected to V_{i-} .

NUCLEAR AND MEDICAL APPLICATIONS - Power-One products are not designed, intended for use in, or authorized for use as critical components in life support systems, equipment used in hazardous environments, or nuclear control systems without the express written consent of the respective divisional president of Power-One, Inc.

TECHNICAL REVISIONS - The appearance of products, including safety agency certifications pictured on labels, may change depending on the date manufactured. Specifications are subject to change without notice.

EC Declaration of Conformity

We

Power-One AG
Ackerstrasse 56, CH-8610 Uster

declare under our sole responsibility that 20/40IMX15 and 110IMY15 DC-DC converters carrying the CE-mark are in conformity with the provisions of the Low Voltage Directive (LVD) 73/23/EEC of the European Communities.

Conformity with the directives is presumed by conformity with the following harmonised standards:

- EN 61204:1995 (= IEC 61204:1993, modified)
Low-voltage power supply devices, DC output - Performance characteristics and safety requirements
- EN 60950:2000 (=IEC 60950:2000)
Safety of information technology equipment.

The installation instructions given in the corresponding data sheet describe correct installation leading to the presumption of conformity of the end product with the LVD. All 20/40IMX15 and 110IMY15 DC-DC converters are components, intended exclusively for inclusion within other equipment by an industrial assembly operation or by professional installers. They must not be operated as standalone products.

Hence conformity with the Electromagnetic Compatibility Directive 89/336/EEC (EMC Directive) needs not to be declared. Nevertheless, guidance is provided in the data sheets on how conformity of the end product with EMC standards under the responsibility of the installer can be achieved, from which conformity with the EMC Directive can be presumed.

Uster, 5 Oct. 2005

Power-One AG



Rolf Baldauf
Vice-President Engineering



Johann Milavec
Director Projects and IP

X-ON Electronics

Largest Supplier of Electrical and Electronic Components

Click to view similar products for [Isolated DC/DC Converters](#) category:

Click to view products by [Bel Fuse](#) manufacturer:

Other Similar products are found below :

[ESM6D044440C05AAQ](#) [FMD15.24G](#) [PSL486-7LR](#) [Q48T30020-NBB0](#) [JAHW100Y1](#) [SPB05C-12](#) [SQ24S15033-PS0S](#) [18952](#) [19-130041](#)
[CE-1003](#) [CE-1004](#) [GQ2541-7R](#) [RDS180245](#) [MAU228](#) [J80-0041NL](#) [DFC15U48D15](#) [XGS-0512](#) [XGS-1205](#) [XGS-1212](#) [XGS-2412](#) [XGS-](#)
[2415](#) [XKS-1215](#) [06322](#) [NCT1000N040R050B](#) [SPB05B-15](#) [SPB05C-15](#) [L-DA20](#) [DCG40-5G](#) [QME48T40033-PGB0](#) [XKS-2415](#) [XKS-2412](#)
[XKS-1212](#) [XKS-1205](#) [XKS-0515](#) [XKS-0505](#) [XGS-2405](#) [XGS-1215](#) [XGS-0515](#) [PS9Z-6RM4](#) [73-551-5038I](#) [AK1601-9RT](#) [VI-N61-CM](#) [VI-](#)
[R5022-EXWW](#) [PSC128-7iR](#) [RPS8-350ATX-XE](#) [DAS1004812](#) [PQA30-D24-S24-DH](#) [VI-M5F-CQ](#) [VI-LN2-EW](#) [VI-PJW01-CZY](#)