

Edge Connectors Product Catalog



cinch
CONNECTIVITY SOLUTIONS
a bel group



Table of Contents

CARDCON™ EDGE CONNECTOR COMMERCIAL

0.100" (2.54mm) Density Dip Solder	3
0.156" (3.96mm) Density Dip Solder	5
0.156" (3.96mm) Density Dip Solder/Solder Eyelet	7

EDGE CONNECTOR ACCESSORIES

Card Guides Polarizing Keys	9
-----------------------------	---

0.100" (2.54mm) Density Dip Solder

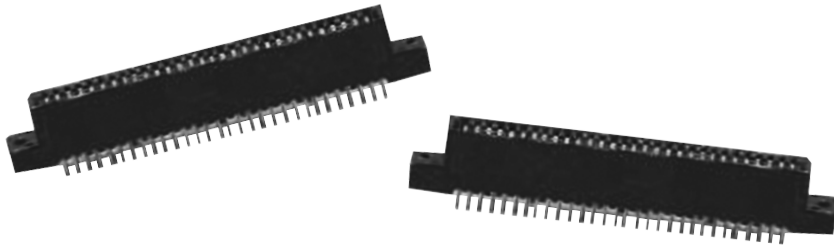

Features

- Dip solder tails on .200" (5.08mm) row centers double readout
- Bifurcated semi-bellows contacts for added contact reliability
- Ideal for applications involving vibration or board irregularities
- Accepts 0.062" (1.59mm) thick PC boards
- Meets applicable performance criteria of MIL-C-21097
- UL Recognized - file E170218 (UL1977) E130965 (UL1863)
- Available less mounting ears
- Contact positions: 18, 20 and 22

Materials

Insulation Material	UL 94V-0 rated glass-filled polyester, black
Contact Material	Spring brass
Standard Contact Plating	10µin. selective gold over nickel, 50µin. nickel in contact area, tin on tails

Environmental

Shock	Per MIL-STD-202E, Method 213, Condition C
Operating Temperature	-65°C to +105°C
Vibration	Per MIL-STD-202E, Method 204, Condition B
Humidity	Per MIL-STD-202, Method 103, Condition B
Accessories (order separately)	
Card Guide Posts	Attach to mounting ears and guide PC board into connector

Electrical

Withstanding Voltage	650 VAC RMS (@ sea level)
Current Rating	3 Amps
Contact Resistance	10 Milliohms maximum
Insulation Resistance	5000 Megohms minimum

Mechanical

Individual Contact Insertion and Separation Force	12oz. maximum with 0.070", (1.78mm) blade 1 oz. minimum with 0.054", (1.37mm) blade
--	--

CARDCON™ EDGE CONNECTOR COMMERCIAL

0.100" (2.54mm) Density Dip Solder

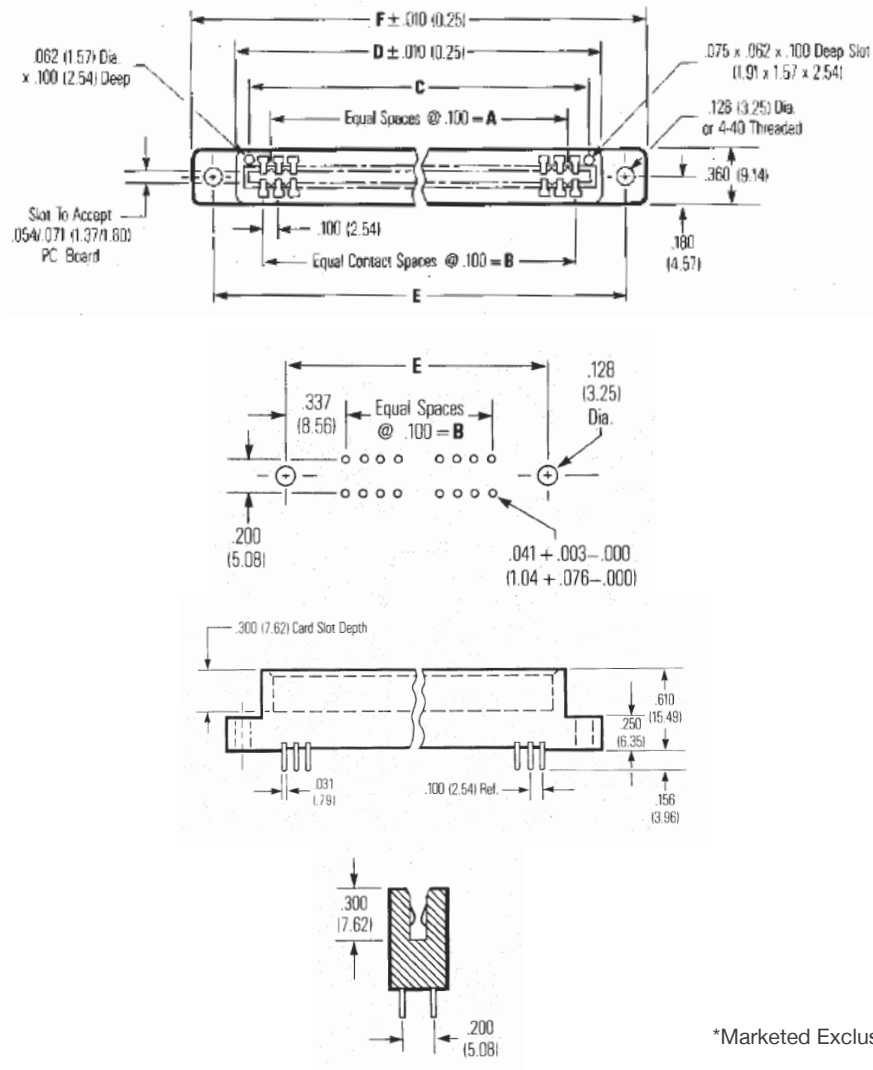

*Marketed Exclusively Through Distribution

Dimensions

Number of Positions/Contacts	A		B		C		D		E		F	
	in	mm	in	mm	in	mm	in	mm	in	mm	in	mm
18/36	1.600	40.64	1.700	43.18	1.900	48.26	2.060	52.32	2.375	60.33	2.635	66.93
20/40	1.800	45.72	1.900	48.26	2.100	53.34	2.260	57.40	2.575	65.41	2.835	72.01
22/44	2.00	50.80	2.100	53.34	2.300	58.42	2.460	62.48	2.775	70.49	3.035	77.09

Ordering Information

Number of Positions/Contacts	Less Mounting Ears Part Number
18/36	50-18SN-12
20/40	50-20SN-12
22/44	50-22SN-12

0.156" (3.96mm) Density Dip Solder

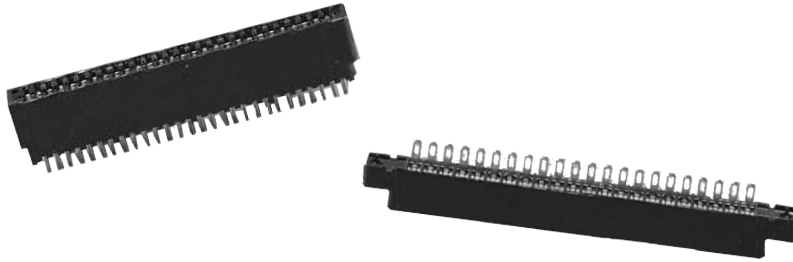

Features

- Dip solder tails single readout and double readout on 0.140" (3.56mm) row centers or 0.200" (5.08mm) row centers
- Available with unique tails for PC board retention; holds the connector firmly on the board during wave soldering operations
- Bifurcated semi-bellows contacts for added contact reliability
- Ideal for applications involving vibration or board irregularities
- Contact positions: 6, 10, 12, 15, 18, 22, 24, and 25
- Accepts single or double-sided 0.062" (1.59mm) thick PC boards
- Available with 0.128" (3.25mm) mounting hole
- Meets applicable performance criteria of MIL-C-21097
- UL Recognized - file E170218 (UL1977) E130965 (UL1863)

Materials

Insulation Material	UL 94V-0 rated glass-filled polyester, black
Contact Material	Spring brass
Standard Contact Plating	10μ" selective gold over 30μ" nickel in contact area, tin on tails

Environmental

Shock	Per MIL-STD-202E, Method 213, Condition C
Operating Temperature	-65°C to +105°C
Vibration	Per MIL-STD-202E, Method 204, Condition B
Humidity	Per MIL-STD-202, Method 103, Condition B
Accessories (order separately)	
Polarizing Key (two types, order separately)	a) for between-contact polarization b) for in-contact polarization
Card Guide Posts	Attach to mounting ears and guide PC board into connector

Electrical

Withstanding Voltage	1800 VAC RMS (@ sea level)
Current Rating	5 Amps
Contact Resistance	6 Milliohms maximum
Insulation Resistance	5000 Megohms minimum

Mechanical

Individual Contact Insertion and Separation Force	16 oz. maximum with 0.070" (1.78mm) blade 1 oz. minimum with 0.054", (1.37mm) blade
--	--

CARDCON™ EDGE CONNECTOR COMMERCIAL

0.156" (3.96mm) Density Dip Solder

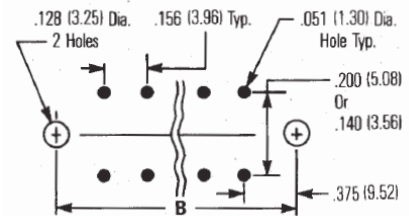
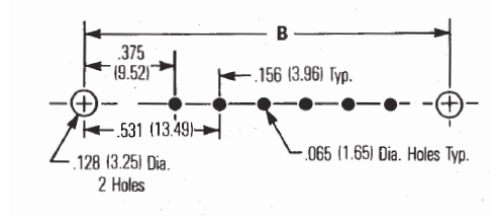
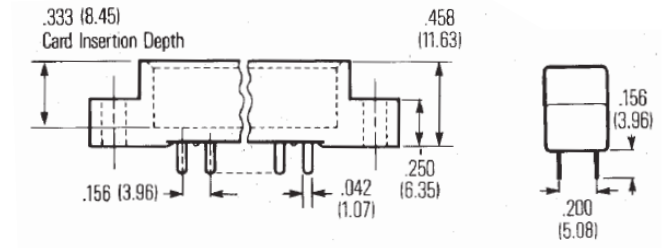
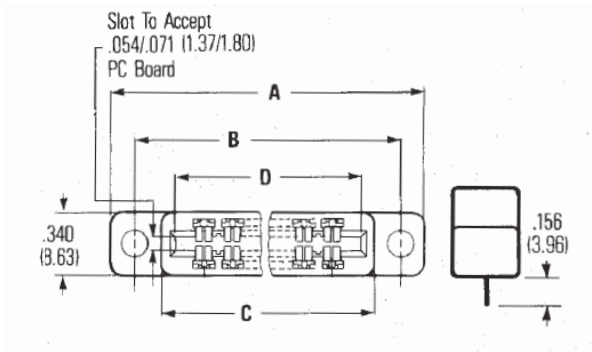

Dimensions

Number of Positions/Contacts	A		B		C		D	
	in	mm	in	mm	in	mm	in	mm
6/12	1.785	45.35	1.531	38.89	1.239	31.47	1.100	27.94
10/20	2.410	61.21	2.156	54.76	1.874	47.34	1.724	43.79
12/24	2.723	69.16	2.469	62.71	2.177	55.30	2.036	51.71
15/30	3.191	81.05	2.937	74.60	2.645	67.18	2.504	63.60
18/36	3.660	92.96	3.406	86.51	3.114	79.10	2.972	75.49
22/44	4.285	108.84	4.031	102.39	3.739	94.94	3.596	91.34
24/48	4.598	116.79	4.344	110.34	4.052	102.92	3.911	99.34
25/50	4.754	120.75	4.500	114.30	4.208	106.88	4.067	103.30

Ordering Information

Number of Positions/Contacts	0.128 Mounting Hole Catalog Number
Dip Solder Tails, Single Readout, 0.156" (3.96mm Long)	
6/6	50-6SN-5
10/20	50-10SN-5
12/12	50-12SN-5
15/15	50-15SN-5
18/18	50-18SN-5
22/22	50-22SN-5
24/24	50-24SN-5
25/25	50-25SN-5

Number of Positions/Contacts	0.128 Less Mounting Ears Catalog Number	0.128 Mounting Hole Catalog Number
Dip Solder Tails, Double Readout, 0.200" (5.08mm Long) row spacing, 0.156" (3.96mm Long)		
6/12	50-12SN-3	-
10/20	50-20SN-3	-
12/24	50-24SN-3	-
15/30	50-30SN-3	-
18/36	50-36SN-3	-
22/44	50-44SN-3	50-44SN-1
24/44	50-48SN-3	-
25/50	50-50SN-3	-

0.156" (3.96mm) Density Dip Solder/Solder Eyelet

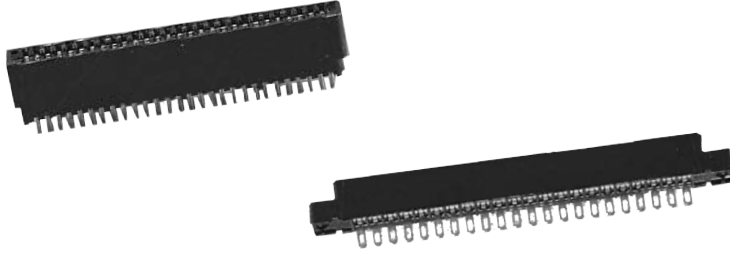

Features

- Dip solder tails single readout and double readout on 0.156" (3.96mm) long
- Dip solder tails, double readout 0.156" (3.96mm) on 0.200" (5.08mm) row spacing or 0.125" (3.18mm) long on 0.140" (3.56mm) row spacing
- Solder eyelet, single readout and double readout on .200" (5.08mm) row centers
- Bifurcated semi-bellows contacts for added contact reliability
- Ideal for applications involving vibration or board irregularities
- Contact positions: 6, 10, 12, 15, 18, 22 and 25
- Accepts single or double sided .062" (1.59mm) thick PC boards
- Available less mounting ears or with 0.128" (3.25mm) mounting hole
- Meets applicable performance criteria of MIL-C-21097

Materials

Insulation Material	UL 94V-0 rated glass-filled polyester, green
Contact Material	Spring brass
Standard Contact Plating	10 μ " selective gold over 30 μ " nickel in contact area, 5 μ " gold on tails

Environmental

Shock	Per MIL-STD-202E, Method 213, Condition C
Operating Temperature	-65°C to +105°C
Vibration	Per MIL-STD-202E, Method 204, Condition B
Humidity	Per MIL-STD-202, Method 103, Condition B
Accessories (order separately)	
Polarizing Key (two types, order separately)	a) for between-contact polarization b) for in-contact polarization
Card Guide Posts	Attach to mounting ears and guide PC board into connector

Electrical

Withstanding Voltage	1800 VAC RMS (@ sea level)
Current Rating	5 Amps
Contact Resistance	6 Milliohms maximum
Insulation Resistance	5000 Megohms minimum

Mechanical

Individual Contact Insertion and Separation Force	16 oz. maximum with 0.070" (1.78mm) blade 1 oz. minimum with 0.054" (1.37mm) blade
--	---

EDGE CONNECTOR COMMERCIAL

0.156" (3.96mm) Density Dip Solder/Solder Eyelet

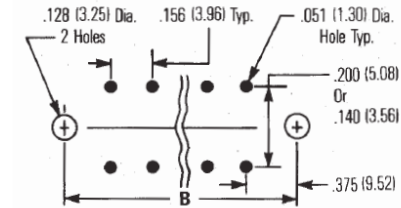
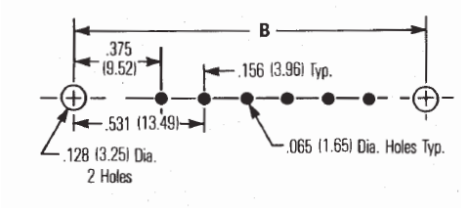
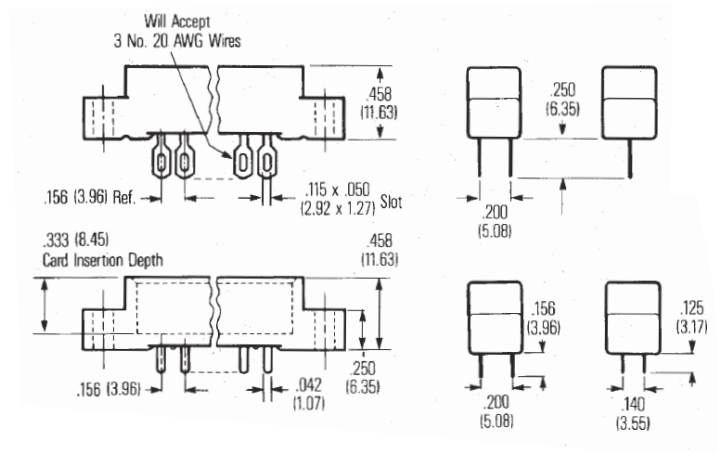
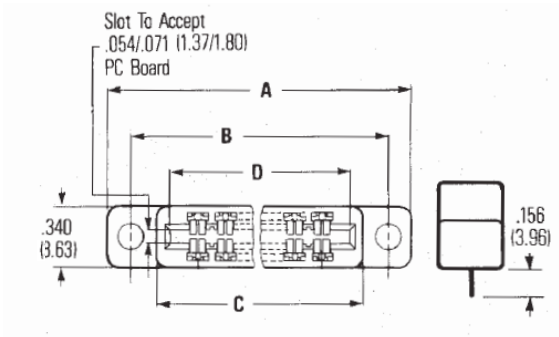

Dimensions

Number of Positions/Contacts	A		B		C		D	
	in	mm	in	mm	in	mm	in	mm
6/12	1.785	45.35	1.531	38.89	1.239	31.47	1.100	27.94
10/20	2.410	61.21	2.156	54.76	1.874	47.34	1.724	43.79
12/24	2.723	69.16	2.469	62.71	2.177	55.30	2.036	51.71
15/30	3.191	81.05	2.937	74.60	2.645	67.18	2.504	63.60
18/36	3.660	92.96	3.406	86.51	3.114	79.10	2.972	75.49
22/44	4.285	108.84	4.031	102.39	3.739	94.94	3.596	91.34
24/48	4.598	116.79	4.344	110.34	4.052	102.92	3.911	99.34
25/50	4.754	120.75	4.500	114.30	4.208	106.88	4.067	103.30

Ordering Information - Single Readout

Number of Positions/Contacts	0.128 (3.25mm) Mounting Hole	
	Solder Eyelet	Dip Solder Tails, 0.156" (3.96mm Long)
	Part Number	Part Number
6/6	50-6A-20	50-6B-10
10/10	50-10A-20	50-10B-10
12/12	50-12A-20	50-12C-10
15/15	50-15A-20	50-15B-10
18/18	50-18A-20	50-18B-10
22/22	50-22A-20	50-22B-10
25/25	50-25A-20	50-25B-10

Ordering Information - Double Readout

Number of Positions/Contacts	0.128 (3.25mm) Mounting Hole	
	Solder Eyelet	Dip Solder Tails, 0.156" (3.96mm Long)
	Part Number	Part Number
6/12	50-12A-30	50-12B-10
10/20	50-20A-30	50-20B-10
12/24	50-24A-30	50-24B-10
15/30	50-30A-30	50-30B-10
18/36	50-36A-30	50-36B-10
22/44	50-44A-30	50-44B-10
25/50	50-50A-30	50-50B-10

Card Guides Polarizing Keys

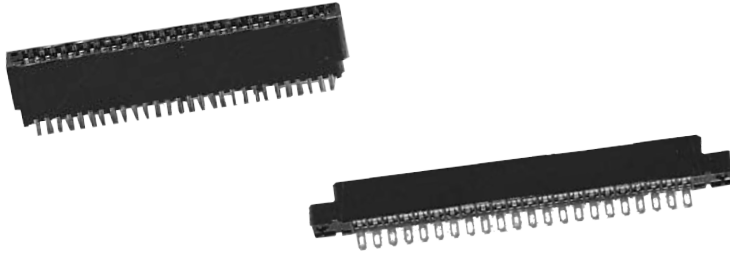

Card guide for 0.100" (2.54mm) and 0.156" (3.96mm) density edge connectors. Accepts 0.062" (1.59mm) thick PC boards. Card guides attach to mounting ears and guide printed circuit board into connector. Order separately.

Materials

Polypropylene	Part Number
Green	50-GP-1
Black	50-GP-1B

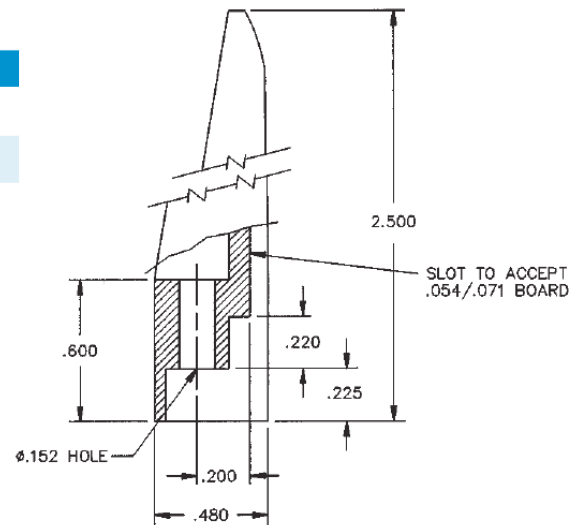

Polarizing Keys

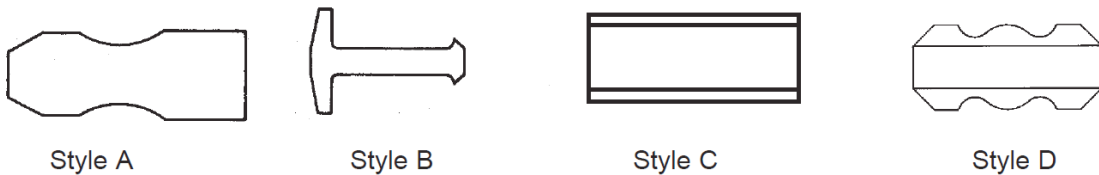

Dimensions

Description	Connector Family	Material	Style	Catalog Number
Between-contact type	0.156"	Cellulose acetate	B	50-PK
In-contact type	0.156"	Thermoset plastic	B	50-PK1
Between-contact type	0.156"	Glass epoxy	A	50-PK2

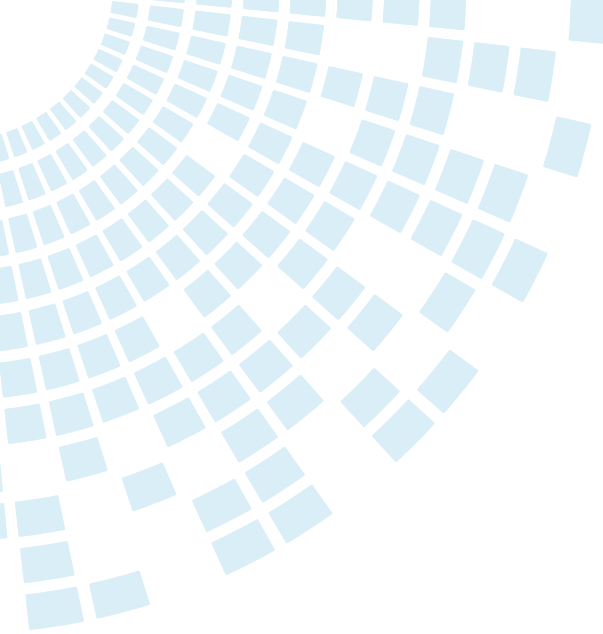

About Cinch Connectivity Solutions

For over 100 years, Cinch Connectivity Solutions has manufactured high-quality & reliable high-performance connectors & cable assemblies. Cinch is recognized as a world class connectivity supplier of RF, fiber optic, hybrid, microwave components, circular, d-subminiatures, modular rectangular, electronic enclosures & cable assemblies.

Cinch provides innovative solutions to the military, commercial aerospace, networking, telecommunication, test & measurement, oil and gas and other harsh environment industries.

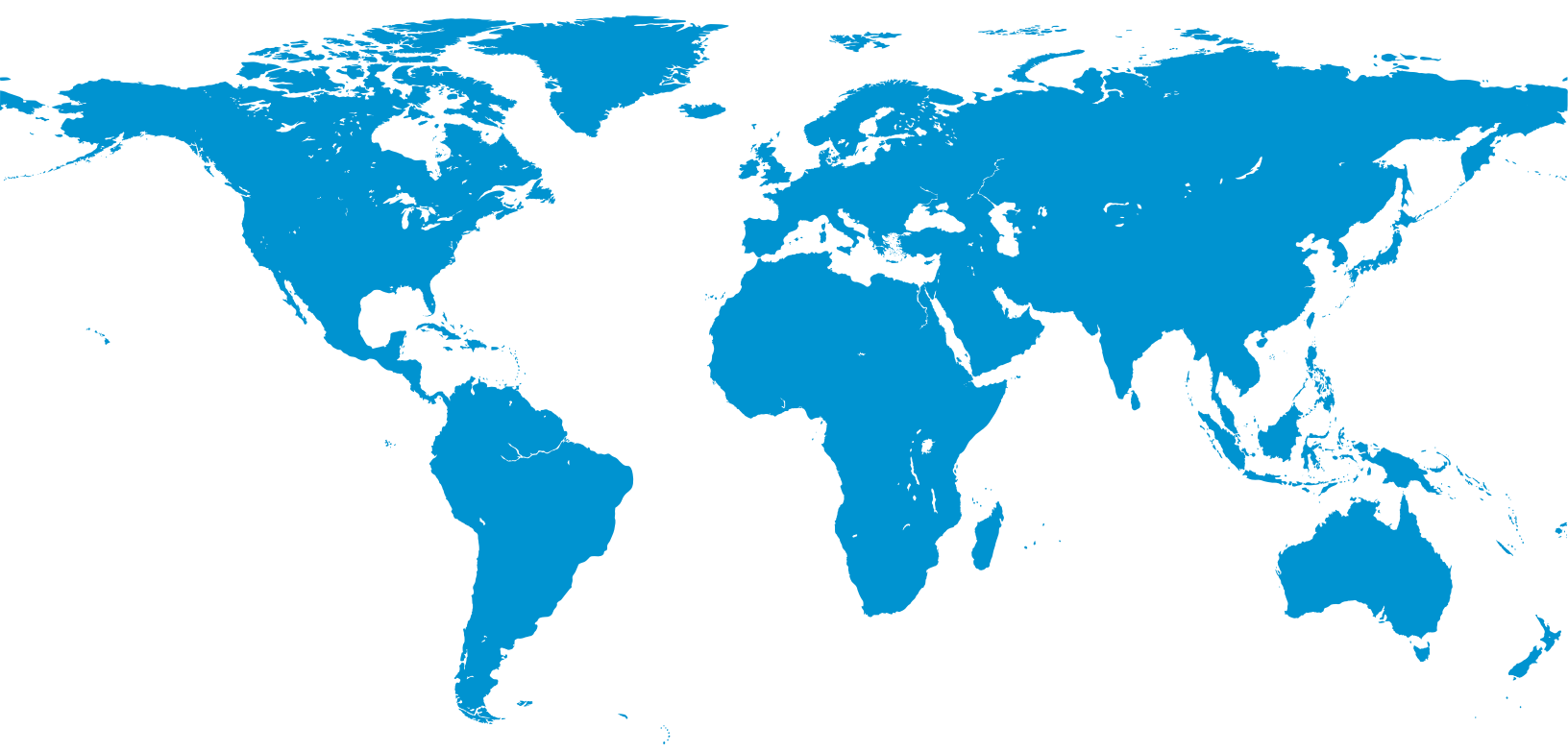

For more information, please contact us:

North America
+1 507.833.8822
ccsorders@us.cinch.com

Asia-Pacific
+86 21 5442 7668
ccs.asia.sales@as.cinch.com

Europe, Middle East
+44 (0) 1245 342060
CinchConnectivity@eu.cinch.com

belfuse.com/cinch.com

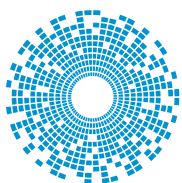

cinch
CONNECTIVITY SOLUTIONS

a bel group

X-ON Electronics

Largest Supplier of Electrical and Electronic Components

Click to view similar products for [Standard Card Edge Connectors](#) category:

Click to view products by [Bel Fuse](#) manufacturer:

Other Similar products are found below :

[CR7E-30DB-3.96E\(72\)](#) [6364499-1](#) [6565204-6](#) [PKC-156](#) [1437274-4](#) [147889-1](#) [1489165-4](#) [EBT15622B2X](#) [1-582587-1](#) [284-0102-12100](#)
[286-0052-12101A](#) [306022901000000](#) [307-012-502-202](#) [307-056-520-300](#) [2129318-1](#) [245-062-520-350](#) [287-0032-12101](#) [306-028-525-102](#)
[307-072-526-202](#) [345-060-559-303](#) [392-008-559-201](#) [534671-1](#) [341-240-317](#) [345-044-500-300](#) [346-240-318](#) [395-100-524-300](#) [09-07-2032](#)
[10035388-802LF](#) [10115859-011LF](#) [10122859-009LF](#) [10127905-B04B24BLF](#) [530555-1](#) [5-678046-1](#) [73726-0005](#) [66308-1](#) [1-1437275-6](#)
[PEC-07-02-T-S-A](#) [346-014-520-801](#) [307-048-502-202](#) [CE100F22-9-C](#) [CE100F26-7-C](#) [CE100F28-3-D](#) [CE156F18-9-C](#) [CE156F22-5-D](#)
[CE156F22-9-C](#) [CT100F22-2-D](#) [CT100F22-3-D](#) [CT100F24-2-D](#) [CT100F24-3-D](#) [CT100F24-6-C](#)