

RED INDICATES ORIGINAL

DATA CONTAINED BY THIS DOCUMENT IS PROPRIETARY TO TROMPETER ELECTRONICS, INC. AND SHALL NOT BE DISCLOSED, COPIED OR USED FOR REPRODUCTION OR MANUFACTURE WITHOUT EXPRESS WRITTEN PERMISSION.

REV		ED	DESCRIPTION	DWN	APPROVED	DATE
B	1084B		.750 MAX WAS .717 ADDED SAFETY WIRE HOLES TO SH 1	DKC	BM, FOL	9/1/94

DASH NO	MODEL NO	CENTER CONTACT / INTMD CONTACT TYPE
-1	B.J450FLP	SOCKET/PIN
-2	B.J450FLS	PIN/SOCKET
-3	B.J450FP	SOCKET/PIN
-4	B.J450FS	PIN/SOCKET
-5	B.J450RP	SOCKET/PIN
-6	B.J450RS	PIN/SOCKET
-7	B.J450WP	SOCKET/PIN
-8	B.J450WS	PIN/SOCKET

INCH	MM
.010	0.25
.028	0.66
.03	0.76
.047	1.18
.071	1.90
.075	1.91
.099	2.36
.130	3.30
.240	6.10
.274	6.88
.278	7.08
.330	8.38
.335	8.51
.438	11.13
.470	11.94
.750	19.05
.795	20.19
1.03	26.18

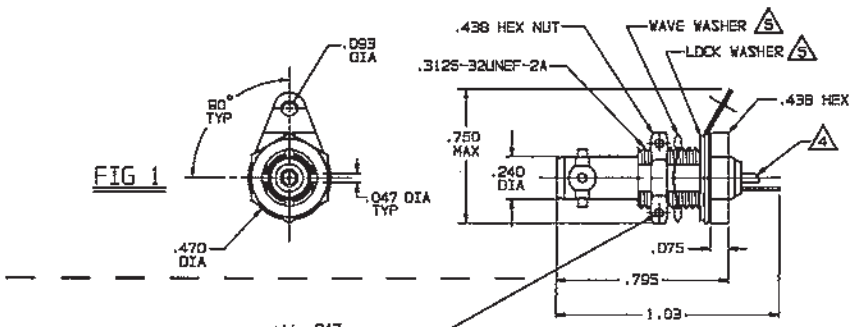

-1 SHOWN

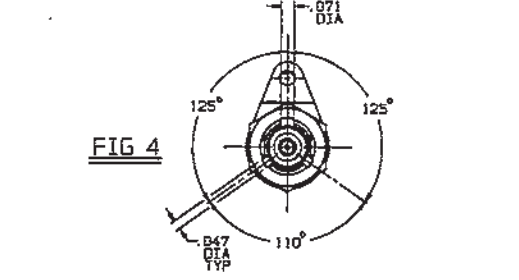
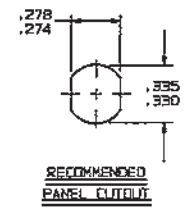
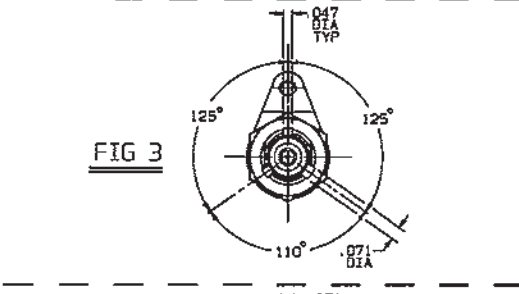
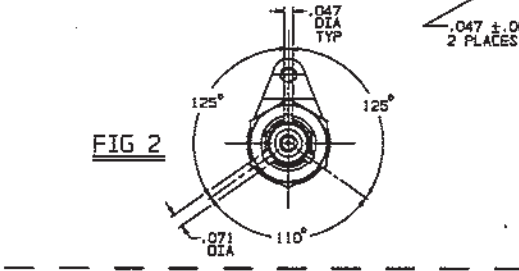

7. EXAMPLE OF COMPLETE MODEL NO:

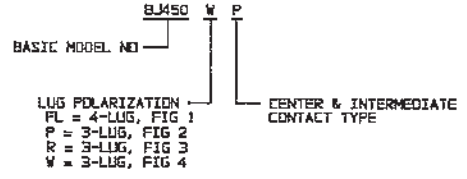

8. EXAMPLE OF COMPLETE PART NO:

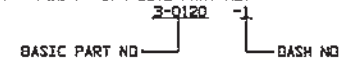

⚠ MAX PNL THK .130 WITH EITHER LOCK WASHER OR WAVE WASHER

⚠ SOLDER PdT ACCEPTS .028 MAX DIA CONDUCTOR

3. CONCENTRIC TWINAX NONINSULATED BULKHEAD MOUNT RECEPTACLE, SOCKET CENTER CONTACT AND PIN INTERMEDIATE CONTACT OR PIN CENTER CONTACT AND SOCKET INTERMEDIATE CONTACT

2. FINISH: TFS-111 (500 HRS SALT SPRAY)

1. ALL DIM ARE IN INCHES

QTY	DESCRIPTION	PART NUMBER	ITEM
TOL UNLESS SPECIFIED .XX ± .03 .XXX ± .010 .XXXX UNLESS	TROMPETER RF Connectivity	B.J450FLP/FLS,PP/ PS,RP/RS,WP/WS	
DWN DKC 8-19-84	MATERIAL	CODE IDENT	DRAWING NO.
CHK <u>BM</u> 8-31-94			<u>3-0120</u>
ENGR			REV
APPR <u>FOL</u> 9/1/94	SCALE 2/1	DATE 5-21-87	SHEET 1 OF 2

NEXT ASSY

X-ON Electronics

Largest Supplier of Electrical and Electronic Components

Click to view similar products for [RF Connectors / Coaxial Connectors](#) category:

Click to view products by [Bel Fuse](#) manufacturer:

Other Similar products are found below :

[8915-1511-000](#) [89674-0827](#) [6001-7071-019](#) [6002-7051-003](#) [6002-7551-202](#) [6059674-1](#) [619550-1](#) [630059-000](#) [M39030/3-01N](#) [6500-7071-046](#) [6769](#) [CX050L2AQ](#) [7002-1541-010](#) [7002-1542-011](#) [7004-1512-000](#) [7009-1511-004](#) [7010-1511-000](#) [7029-1511-060](#) [7101-1541-010](#) [7101-1571-002](#) [7145-1521-002](#) [7203-1571-003](#) [7209-1511-011](#) [7210-1511-015](#) [7210-1511-019](#) [73137-5015](#) [73216-2241](#) [73404-2300](#) [7405-1521-005](#) [7405-1521-802](#) [8527](#) [8547](#) [FS11V](#) [877931](#) [9049-9513-000](#) [9074-9513-000](#) [9101-9573-002](#) [910A205F](#) [9130-9573-002](#) [PL11SC-026](#) [PL375-33](#) [PL40-5](#) [PL74C-221](#) [PL75MC-217](#) [PL803-7](#) [980-8666-005](#) [1200690078](#) [1-201144-1](#) [R107003010W](#) [R110A172100](#)