

THE INFORMATION CONTAINED HEREON IS THE PROPERTY OF EMERSON NETWORK POWER, RECEIPT, POSSESSION OR TRANSMITTAL OF THIS DRAWING DOES NOT LICENSE OR IMPLY ANY RIGHT TO USE, SELL, PROTOTYPE OR MANUFACTURE FROM THIS INFORMATION. NO REPRODUCTIONS OR PUBLICATION OF THIS INFORMATION, IN WHOLE OR IN PART, SHALL BE MADE WITHOUT WRITTEN AUTHORIZATION FROM EMERSON NETWORK POWER.

DWG NO. 3-0272 SH 1

DASH NO	FIG NO	CONNECTOR TYPE	MODEL NO
-1	1	2-LUG	CBBJ79TL
-2	2	3-LUG	CBBJ79
-3	3	THREADED	CBBJ379
-4	4	4-LUG	CBBJ79FL
-5	1	2-LUG	CBBJ79TLS
-6	2	3-LUG	CBBJ79S
-7	3	THREADED	CBBJ379S
-8	4	4-LUG	CBBJ79FLS

REVISIONS			
REV	DESCRIPTION	DATE	APPROVED
C	ECO 12672	1/7/99	C.N.M.
D	ECO 52441	6/10/10	T. KOHLER

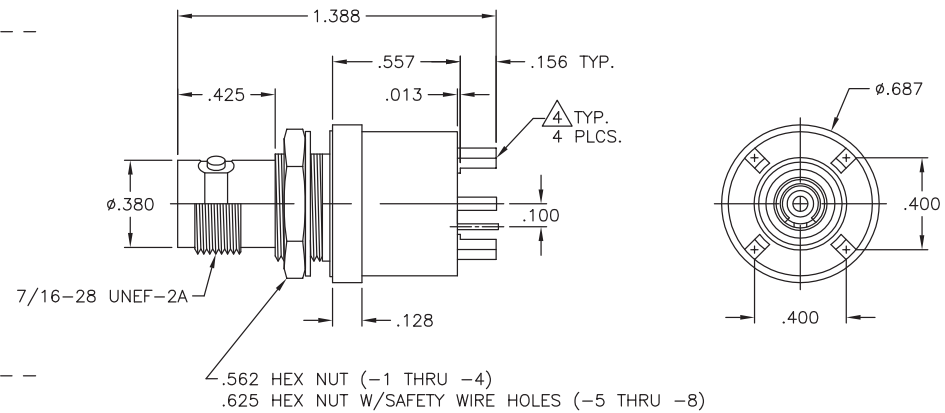
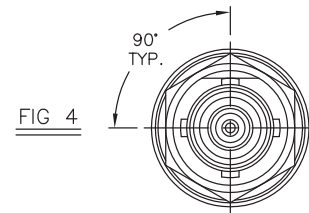
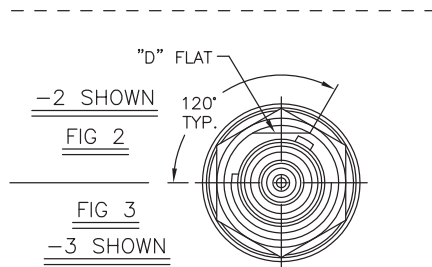
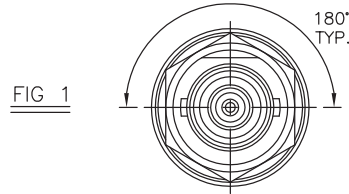

RECOMMENDED
MTG HOLE PATTERN
SCALE 2:1

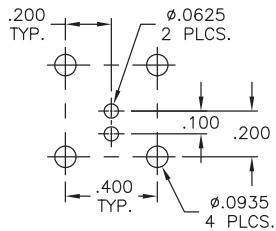

RECOMMENDED
PANEL CUTOUT
SCALE 2:1

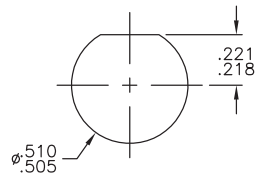

- PRE-TINNED, .0015 MAXIMUM THICKNESS WITH SN63 OR EQUIVALENT SOLDER, PER QQ-S-571, TO WITHIN .060 MAXIMUM OF SHOULDER, AFTER PLATING.
- MAXIMUM PANEL THICKNESS .109
- FEMALE 2/3/4 LUG & THREADED CONCENTRIC BOARD AND NON-INSULATED BULKHEAD MOUNT RECEPTACLE.

FINISH: TFS-1A (NICKEL)

SURFACE AREA (IN ²)	UNLESS OTHERWISE SPECIFIED DIMENSIONS ARE IN INCHES TOLERANCES ARE:		 CBBJ79/TL/FL/379 CBBJ79S/TLS/FLS/379S			
	FRACTIONS	DECIMALS			ANGLES	
MATERIAL	SIGNATURES	DATE	SIZE	CAGE CODE	DWG NO.	REV
FINISH	DRAWN BY		B	14949	3-0272	D
DO NOT SCALE DRAWING	CHECKED BY		SCALE	DATE:	SHEET	
	APPROVED BY		2:1	4/9/85	1	2
	APPROVED BY					

X-ON Electronics

Largest Supplier of Electrical and Electronic Components

Click to view similar products for [RF Connectors / Coaxial Connectors](#) category:

Click to view products by [Bel Fuse](#) manufacturer:

Other Similar products are found below :

[8915-1511-000](#) [89674-0827](#) [6001-7071-019](#) [6002-7051-003](#) [6002-7551-202](#) [6059674-1](#) [619550-1](#) [630059-000](#) [M39030/3-01N](#) [6500-7071-046](#) [6769](#) [CX050L2AQ](#) [7002-1541-010](#) [7002-1542-011](#) [7004-1512-000](#) [7009-1511-004](#) [7010-1511-000](#) [7029-1511-060](#) [7101-1541-010](#) [7101-1571-002](#) [7145-1521-002](#) [7203-1571-003](#) [7209-1511-011](#) [7210-1511-015](#) [7210-1511-019](#) [73137-5015](#) [73216-2241](#) [73404-2300](#) [7405-1521-005](#) [7405-1521-802](#) [8527](#) [8547](#) [FS11V](#) [877931](#) [9049-9513-000](#) [9074-9513-000](#) [9101-9573-002](#) [910A205F](#) [9130-9573-002](#) [PL11SC-026](#) [PL375-33](#) [PL40-5](#) [PL74C-221](#) [PL75MC-217](#) [PL803-7](#) [980-8666-005](#) [1200690078](#) [1-201144-1](#) [R107003010W](#) [R110A172100](#)