

D-SUBMINIATURE

D*KL Series

D*A Series

D*U Series

Basic D Series

Series 3 - High Reliability

Backshells/Junctionshells/Hoods

Application Tooling

HTD/HPD Series

Overmold Kits

T* Series

Series 1 - High Reliability

M24308 Series

Accessories



Cinch

The D-subminiature is one of the most popular styles of connectors in the I/O category. It is used in computer, telecom, datacom, medical, and test instrumentation applications as well as in the military and aerospace fields.

Types of D-subminiature connectors manufactured by Cinch

- Printed Circuit Board connectors:
 - Vertical connectors for panel mounting with Dip Solder PC tails.
 - Right-Angle connectors for board mounting with Dip Solder PC tails.
- Wire Termination connectors for cable assemblies or wire harnesses:
 - Crimp and Poke connectors.
 - Solder Cup connectors.
 - Insulation Displacement connectors IDCs to terminate discrete wire or flat cable.
 - Wire Wrap connectors.

How to read this section

- The information pages provide standard data common to all D-subminiature connectors. These include:
 - D-subminiature contact arrangements - see page 4-5.
 - Panel mounting specifications/hardware - see page 4-6.
 - D-subminiature shell dimensions - see page 4-7.
 - D-subminiature and combo D layouts - see pages 4-5, 4-8 thru 4-10, and 4-56.
 - General Performance Specifications - see page 4-2.
 - PCB thickness chart - see page 4-8.
- D-subminiature pages are grouped by series. A series is a family of connectors with a similar performance level. Each series shares a set of features and specifications, from economical and commercial grade product to high-reliability and military connectors. Each series begins with a page outlining general features and specifications of connectors, followed by the pages on individual connectors with drawings or features specific to that connector. Drawings reflect clarifications of dimensions not called out in the information pages of this catalog. The features of each series can be found in the chart on page 4-4.
- Accessories including backshells, junction shells, and hoods as well as hardware can be found on pages 4-80 thru 4-99.
- Termination tooling for Cinch connectors can be found at the end of the D-subminiature section of this catalog on pages 4-100 thru 4-104.



General Information

- All connectors are intermateable with any Cinch D-subminiature of comparable pin count and density, or the D-sub connector of any other manufacturer complying dimensionally with MIL-C-24308.
- Solder terminations and boardlocks meet the requirements for solderability in accordance with MIL-STD-202, Method 208.
- **DURABILITY**
 - Mated connectors are subjected to cycles of insertions and withdrawals specified on the catalog page. After the prescribed cycles the connectors will meet the Cinch requirements concerning insertion-withdrawal force, individual contact insertion-withdrawal force, and contact resistance.
- **APPROVALS**
 - Most Cinch connectors have UL recognition and CSA approval; however, the specific approvals are listed on the individual catalog pages.
- **CONTACTS**
 - Cinch connector contacts are generally offered in Gold Flash or 30 μ in. gold plating for commercial product, and 50 μ in. gold plating for M24308 Series Military D-subminiature connectors.
 - Cinch connectors utilize economical stamped and formed contacts and/or screw machine contacts for enhanced performance.
 - Standard density connectors utilize size 20 contacts.
 - Cinch 1.5 Density Series connectors utilize size 22 contacts for greater density in a standard size D-subminiature outer shell.
- **METAL SHELLS**
 - Commercial-grade steel shells are usually available in zinc plating with yellow chromate finish or tin plating.
 - Tin-plated plugs have grounding indents.
 - Military grade M24308 Series connector shells are generally steel or in certain cases non-magnetic brass with cadmium plating and yellow chromate finish.
 - Insulator materials are glass-filled polyester, glass-filled nylon, and diallyl phthalate.
- The connectors are usually available in plugs and sockets in 9, 15, 25, 37, and 50 position sizes.

Printed Circuit Board Connectors

- Cinch provides connectors in various footprints, contact diameters, and lengths in both vertical and right-angle PC mount styles with dip solder tails.
- Cinch PCB connectors have metal shells.

Connectors for Terminating Cable Wire

- Wire Wrap connectors are available in two tail lengths for two-wrap and three-wrap terminations. The contact is terminated by wrapping wire around it using a wire wrap gun. This connector is especially useful for prototyping since the wire can be unwrapped and rewrapped if necessary.
- Solder Cup connectors allow reliable long-term termination by soldering the wire directly into the connector contact. Cinch Solder Cups accommodate up to 20 AWG wire.
- Crimp and Poke connectors allow the wire to be terminated more economically than wire wrap or solder cup styles. Contacts are crimped and inserted into the connector. In our D^U Series, the contact is crimped around the conductor wire. In our D^A Series, the contact is crimped around the wire and the insulation. Crimp and Poke connectors can be selectively loaded to save labor and material cost.
- IDC connectors are an alternative to other types of wire termination connectors. IDC is much faster and very reliable when all contacts are terminated and the volume is high. IDC utilizes mass termination of the cable wire. This can save considerable time and expense in the cable assembly process. The estimated time of terminating two ends of a 25-conductor discrete wire cable with 25-position D-subminiature connectors is about 5-1/2 to 6 minutes less per cable assembly using IDC connectors and Cinch Auto-Clinch termination tooling versus using Crimp and Poke connectors. This may vary considerably based on the operator, cable wire, and process. Cinch offers IDC connectors in two versions-for discrete wire or flat ribbon termination.

Feature Guide

The chart below contains Cinch D-subminiature product features and styles grouped by series.

| Performance Level | Economical | | Commercial | | | | High-Reliability | | Military |
|----------------------------|------------|---------|------------|------|------|---------|------------------|----------|----------|
| Series | D*KL | HPD/HTD | D*A | D*U | T | Basic D | Series 1 | Series 3 | M24308 |
| Termination Type | | | | | | | | | |
| Vertical PCB | 4-12 | | | 4-26 | | 4-42 | 4-50 | | 4-76 |
| Right-Angle PCB | 4-12 | 4-16 | | 4-26 | | | 4-50 | | 4-76 |
| Crimp and Poke | | 4-16 | 4-20 | 4-26 | | | | 4-72 | 4-76 |
| Solder Cup | | | | | 4-34 | 4-42 | 4-50 | | 4-76 |
| IDC | | | | | 4-34 | | | | |
| Wire Wrap | | | | | | 4-42 | | | |
| Insulator Material | | | | | | | | | |
| G-F Nylon | | | * | * | | | | | |
| G-F Polyester | * | * | | | * | * | | | |
| Diallyl Phthalate | | | | | | | * | * | * |
| Shell Material | | | | | | | | | |
| All Plastic | | | | | * | | | | |
| Steel Shell | * | * | * | * | * | * | * | * | * |
| Shell Plating | | | | | | | | | |
| Tin-Lead Plating | * | * | * | * | * | * | * | * | |
| Zinc Plating-Y/C finish | | | * | * | * | * | * | * | |
| Cadmium Plating-Y/C finish | | | | | | | * | * | * |
| Contact Plating | | | | | | | | | |
| Gold-Flash Plating | * | * | * | * | * | * | * | * | |
| 30µin. Gold Plating | * | * | * | * | * | * | * | * | |
| 50µin. Gold Plating | | | | | | | * | * | * |
| Contact Type | | | | | | | | | |
| Stamped Contacts | * | * | * | * | * | * | | | |
| Machined Contacts | | | | * | | * | * | * | * |

Accessories information starts on page 4-80.

Tooling information starts on page 4-100.

* Applies to Combination Layout Only.

Standard Density Plug Inserts

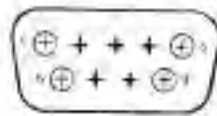

Shell Size E
(9 Position)

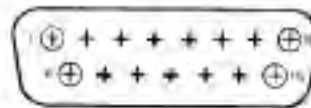

Shell Size A
(15 Position)

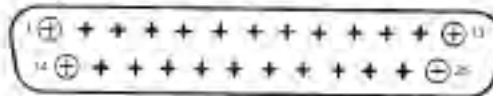

Shell Size B
(25 Position)

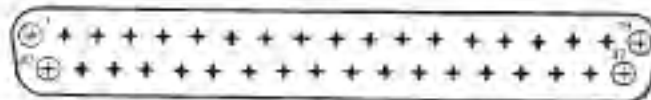

Shell Size C
(37 Position)



Shell Size D
(50 Position)

1.5 Density Plug Inserts

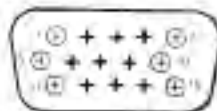

Shell Size E
(15 Position)

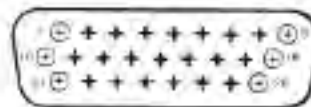

Shell Size A
(26 Position)

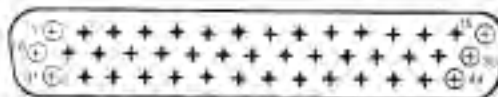

Shell Size B
(44 Position)

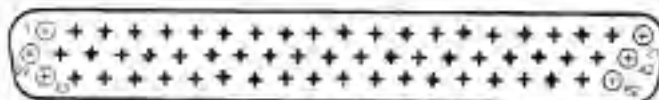

Shell Size C
(62 Position)

NOTE: Mating face of plug is shown; socket is mirror image.

Panel Mounting Specifications



Dimensions

| Shell Size | Positions | Mounting Method | | A | | B | | C | | D | | E | | F | | H | | |
|------------|-----------|------------------|------|-------|------|-------|------|-------|------|-------|------|-------|------|------|------|------|--|--|
| | | Front/Rear Panel | In | mm | In | mm | In | mm | In | mm | In | mm | In | mm | In | mm | | |
| E | 9 | Front | 0.98 | 24.89 | 0.49 | 12.45 | 0.87 | 22.10 | 0.44 | 11.18 | 0.51 | 12.95 | 0.26 | 6.60 | 0.08 | 2.03 | | |
| | | Rear | 0.98 | 24.89 | 0.49 | 12.45 | 0.81 | 20.57 | 0.40 | 10.16 | 0.45 | 11.43 | 0.23 | 5.84 | 0.13 | 3.30 | | |
| A | 15 | Front | 1.31 | 33.27 | 0.68 | 16.76 | 1.10 | 27.94 | 0.60 | 15.24 | 0.51 | 12.95 | 0.26 | 6.60 | 0.08 | 2.03 | | |
| | | Rear | 1.31 | 33.27 | 0.68 | 16.76 | 1.13 | 28.70 | 0.57 | 14.48 | 0.45 | 11.43 | 0.23 | 5.84 | 0.13 | 3.30 | | |
| B | 25 | Front | 1.85 | 46.99 | 0.93 | 23.62 | 1.74 | 44.20 | 0.87 | 22.10 | 0.51 | 12.95 | 0.26 | 6.60 | 0.08 | 2.03 | | |
| | | Rear | 1.85 | 46.99 | 0.93 | 23.62 | 1.67 | 42.42 | 0.84 | 21.34 | 0.45 | 11.43 | 0.23 | 5.84 | 0.13 | 3.30 | | |
| C | 37 | Front | 2.50 | 63.50 | 1.25 | 31.75 | 2.39 | 60.71 | 1.20 | 30.48 | 0.51 | 12.95 | 0.26 | 6.60 | 0.08 | 2.03 | | |
| | | Rear | 2.50 | 63.50 | 1.25 | 31.75 | 2.38 | 59.18 | 1.16 | 29.46 | 0.45 | 11.43 | 0.23 | 5.84 | 0.13 | 3.30 | | |
| D | 50 | Front | 2.41 | 61.21 | 1.20 | 30.48 | 2.30 | 58.42 | 1.15 | 29.21 | 0.62 | 15.75 | 0.31 | 6.60 | 0.08 | 2.03 | | |
| | | Rear | 2.41 | 61.21 | 1.20 | 30.48 | 2.22 | 56.39 | 1.11 | 28.19 | 0.56 | 14.22 | 0.28 | 5.84 | 0.13 | 3.30 | | |

4

PANEL MOUNTING HARDWARE: Aids in alignment of plug and receptacle.

Float Bushing

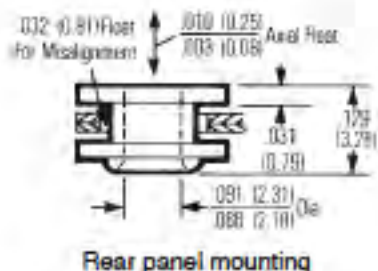

Rear panel mounting

Reverse Float Bushing

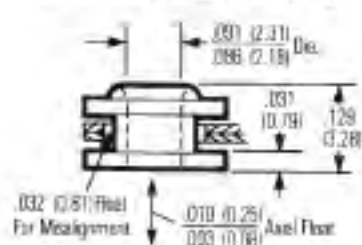

Front panel mounting

Floating Dual Bushing

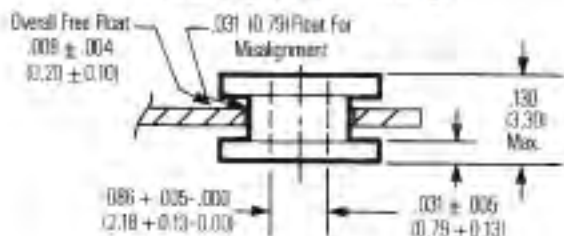

Front and rear panel mounting

4-40 Clinch Nut

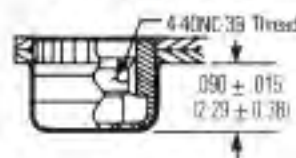

Rear panel mounting

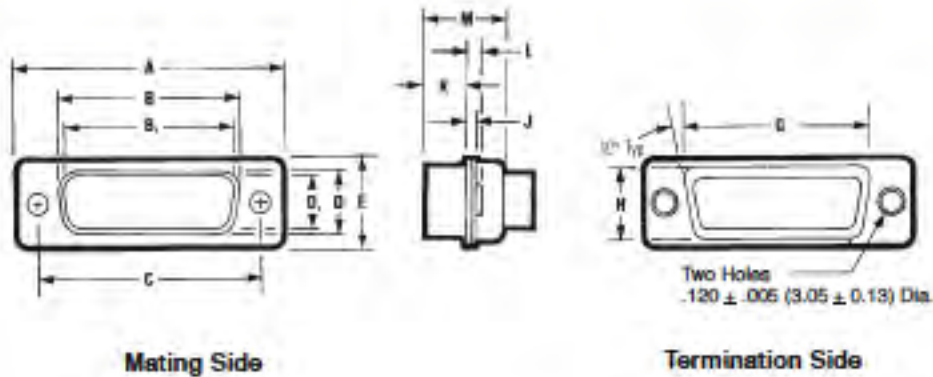

| Shell Size | Positions | Connector Type | A $\pm .015^*$ (0.38mm) | | B $\pm .010^*$ (0.25mm) | | B ₁ $\pm .005^*$ (0.13 mm) | | C $\pm .005^*$ (0.13mm) | | D $\pm .010^*$ (0.25mm) | | D ₁ $\pm .010^*$ (0.25mm) | | E $\pm .010^*$ (0.25mm) | |
|------------|-----------|----------------|----------------------------|-------|----------------------------|-------|--|-------|----------------------------|-------|----------------------------|-------|---|-------|----------------------------|-------|
| | | | in | mm | in | mm | in | mm | in | mm | in | mm | in | mm | in | mm |
| E | 9 | Plug | 1.213 | 30.81 | — | — | .666 | 16.90 | 0.984 | 24.99 | — | — | .329 | 8.40 | .494 | 12.55 |
| | | Socket | 1.213 | 30.81 | .640 | 16.26 | — | — | 0.984 | 24.99 | .308 | 7.82 | — | — | .494 | 12.55 |
| A | 15 | Plug | 1.541 | 39.14 | — | — | .994 | 25.30 | 1.312 | 33.32 | — | — | .329 | 8.40 | .494 | 12.55 |
| | | Socket | 1.541 | 39.14 | .968 | 24.59 | — | — | 1.312 | 33.32 | .308 | 7.82 | — | — | .494 | 12.55 |
| B | 25 | Plug | 2.088 | 53.04 | — | — | 1.534 | 39.00 | 1.852 | 47.04 | — | — | .329 | 8.40 | .494 | 12.55 |
| | | Socket | 2.088 | 53.04 | 1.508 | 38.30 | — | — | 1.852 | 47.04 | .308 | 7.82 | — | — | .494 | 12.55 |
| C | 37 | Plug | 2.729 | 69.32 | — | — | 2.182 | 55.40 | 2.500 | 63.50 | — | — | .329 | 8.40 | .494 | 12.55 |
| | | Socket | 2.729 | 69.32 | 2.156 | 54.76 | — | — | 2.500 | 63.50 | .308 | 7.82 | — | — | .494 | 12.55 |
| D | 50 | Plug | 2.635 | 66.93 | — | — | 2.079 | 52.80 | 2.406 | 61.11 | — | — | .436 | 11.07 | .605 | 15.37 |
| | | Socket | 2.635 | 66.93 | 2.062 | 52.34 | — | — | 2.406 | 61.11 | .420 | 10.67 | — | — | .605 | 15.37 |

| Shell Size | Positions | Connector Type | G $\pm .010^*$ (0.25mm) | | H $\pm .010^*$ (0.25mm) | | J $\pm .010^*$ (0.25 mm) | | K $\pm .005^*$ (0.25mm) | | L $\pm .010^*$ (0.25mm) | | M $\pm .010^*$ (0.25mm) | |
|------------|-----------|----------------|----------------------------|-------|----------------------------|-------|-----------------------------|------|----------------------------|------|----------------------------|------|----------------------------|-------|
| | | | in | mm | in | mm | in | mm | in | mm | in | mm | in | mm |
| E | 9 | Plug | .759 | 19.28 | .422 | 10.72 | .030 | 0.76 | .236 | 5.99 | .045 | 1.14 | .422 | 10.72 |
| | | Socket | .759 | 19.28 | .422 | 10.72 | .030 | 0.76 | .243 | 6.17 | .045 | 1.14 | .429 | 10.92 |
| A | 15 | Plug | 1.083 | 27.51 | .422 | 10.72 | .030 | 0.76 | .236 | 5.99 | .045 | 1.14 | .422 | 10.72 |
| | | Socket | 1.083 | 27.51 | .422 | 10.72 | .030 | 0.76 | .253 | 6.17 | .045 | 1.14 | .429 | 10.92 |
| B | 25 | Plug | 1.625 | 41.27 | .422 | 10.72 | .039 | 0.99 | .231 | 5.87 | .060 | 1.52 | .426 | 10.82 |
| | | Socket | 1.625 | 41.27 | .422 | 10.72 | .030 | 0.76 | .243 | 6.17 | .045 | 1.14 | .429 | 10.92 |
| C | 37 | Plug | 2.272 | 57.71 | .422 | 10.72 | .039 | 0.99 | .231 | 5.87 | .060 | 1.52 | .426 | 10.82 |
| | | Socket | 2.272 | 57.71 | .422 | 10.72 | .030 | 0.76 | .243 | 6.17 | .045 | 1.14 | .429 | 10.92 |
| D | 50 | Plug | 2.178 | 55.32 | .534 | 13.56 | .039 | 0.99 | .231 | 5.87 | .060 | 1.52 | .426 | 10.82 |
| | | Socket | 2.178 | 55.32 | .534 | 13.56 | .030 | 0.76 | .243 | 6.17 | .045 | 1.14 | .429 | 10.92 |

B and D are outside dimensions for socket. D and B are inside dimensions for plug.

**Standard Density D-subminiature
Mounting Dimensions Board Layouts
Footprints (Component side shown)**

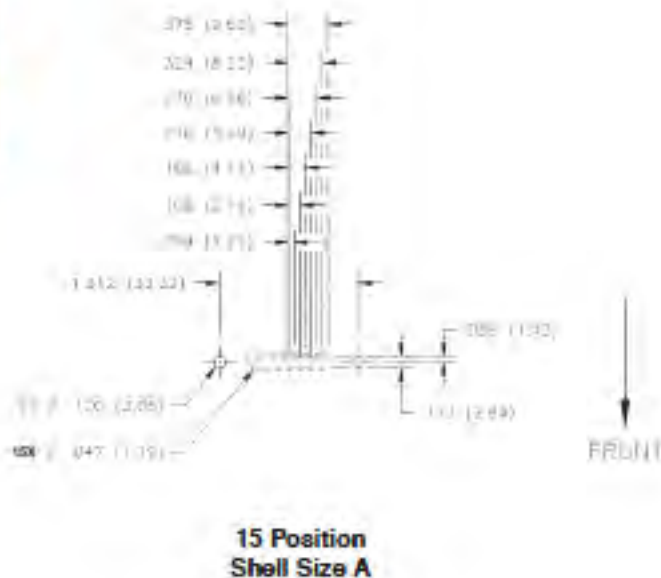
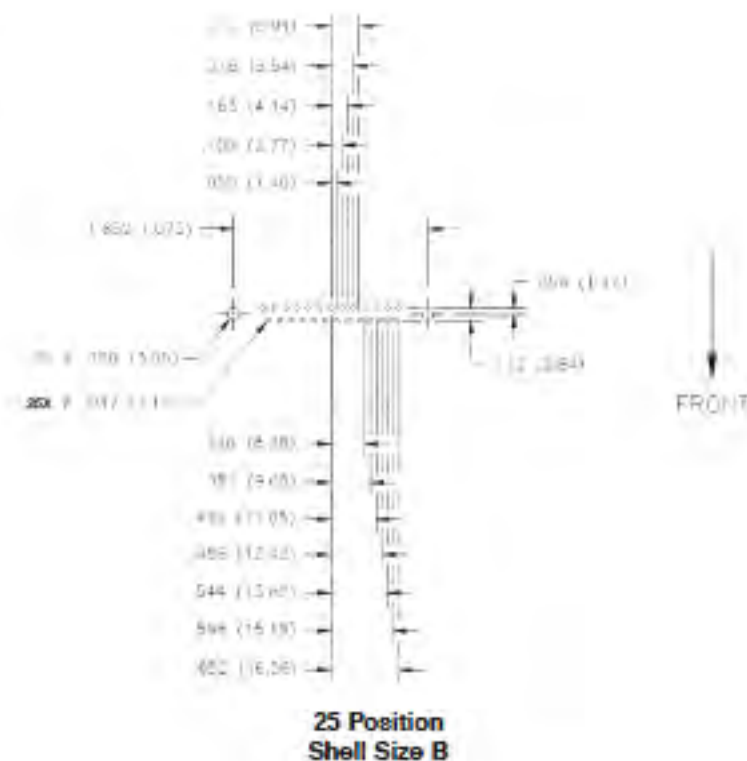
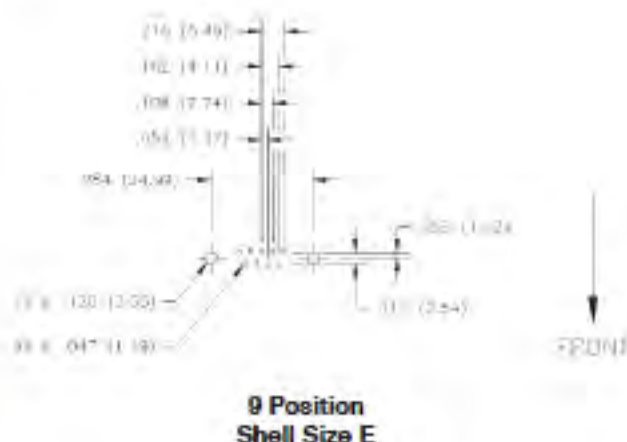

The footprints on this page are standard for all metal shell D-subminiature connectors.

On all right-angle D-subminiature connectors, the short row of contacts is positioned closest to the edge of the board.

PC Board Lead Hole Size

| Terminal Dia. | | Hole Dia. | |
|---------------|-----------|-----------|------|
| in | mm | in | mm |
| .040 | 1.02 | .055 | 1.40 |
| .030 | 0.76 | .045 | 1.14 |
| .024-.025 | 0.61-0.64 | .039 | 0.99 |

**Standard Density D-subminiature
Mounting Dimensions Board Layouts
Footprints (Component side shown)**

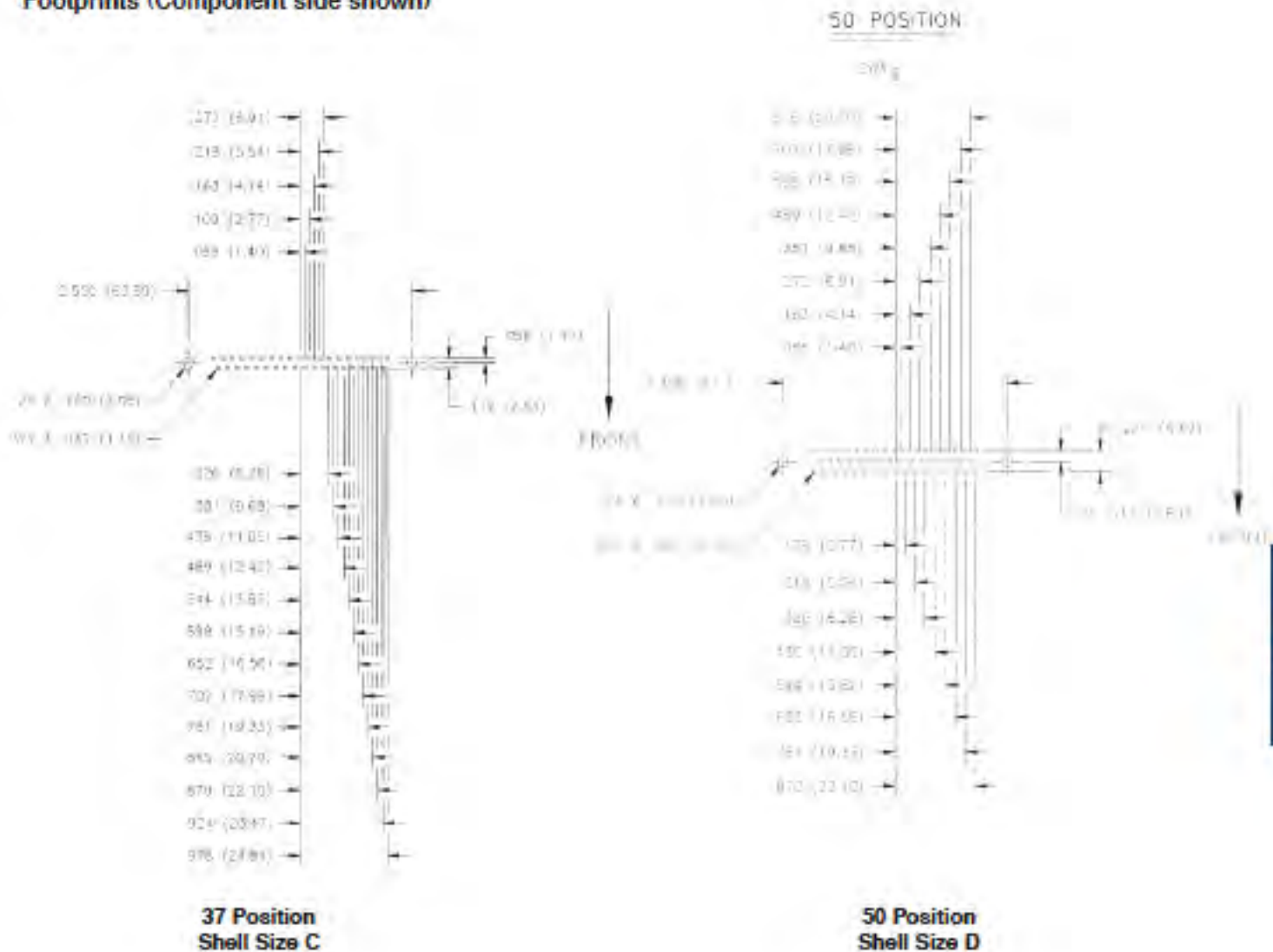

4

The footprints on this page are standard for all metal shell D-subminiature connectors.

On all right-angle D-subminiature connectors, the short row of contacts is positioned closest to the edge of the board.

PC Board Lead Hole Size

| Terminal Dia. | | Hole Dia. | |
|---------------|-----------|-----------|------|
| in | mm | in | mm |
| .040 | 1.02 | .055 | 1.40 |
| .030 | 0.76 | .045 | 1.14 |
| .024-.025 | 0.61-0.64 | .039 | 0.99 |

**1.5 Density D-subminiature
Recommended PCB Layout for
Footprint (Component side shown)**

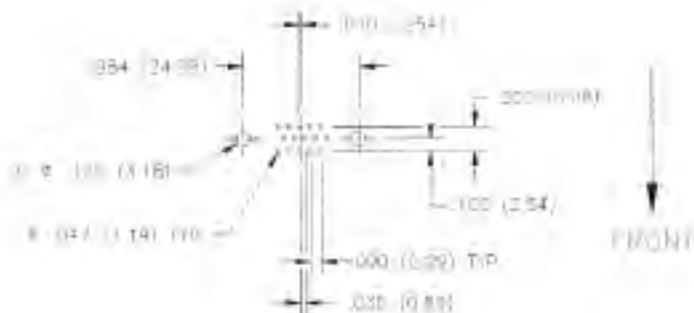

**15 Position
Shell Size E**

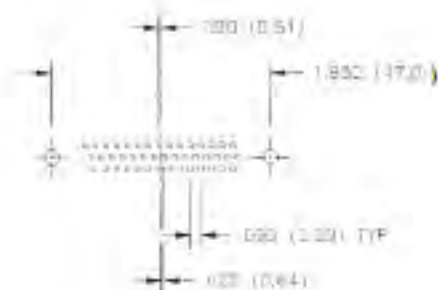

**44 Position
Shell Size B**

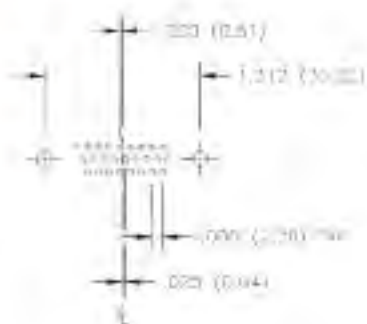

**26 Position
Shell Size A**

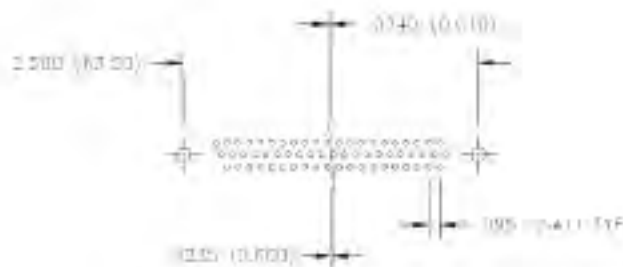

**62 Position
Shell Size C**

The footprints on this page are standard for all metal shell D-subminiature connectors.

On all right-angle D-subminiature connectors, the short row of contacts is positioned closest to the edge of the board.

PC Board Lead Hole Size

| Terminal Dia. | | Hole Dia. | |
|---------------|-----------|-----------|------|
| in | mm | in | mm |
| .040 | 1.02 | .055 | 1.40 |
| .030 | 0.76 | .045 | 1.14 |
| .024-.025 | 0.61-0.64 | .039 | 0.99 |

D-subminiature Metal Shell Right-Angle and Vertical PCB D*KL Series



FEATURES

- Offered in right-angle or vertical PCB mount versions.
- Available with gold flash or 30µin. gold plating.
- Metal Shell provides grounding and shielding capability.
- Approvals:
 - UL Recognized: File E130965.
 - CSA Approved: File LR97981.
- See pages 4-5 thru 4-10 for standard dimensions, contact arrangements, and panel mounting specifications.

MATERIALS

Insulator Material: Glass-filled polyester (black),
UL 94V-0 rated

Contact Material: Socket - Phosphor bronze (stamped)
Plug - Brass (stamped)

Contact Plating: Gold flash or 30µin. gold in mating area and
tin/lead on tails. All over nickel.

Metal Shell: Steel with tin plating (grounding indents on plug)



ENVIRONMENTAL

Operating Temperature: -55°C to +125°C

Shock: 50G peak per MIL-STD-202, Method 213, Condition G

Vibration: 12 cycles in three perpendicular directions @
10-2000Hz, per MIL-STD-202, Method 204,
Condition D

Moisture Resistance: 90-95% relative humidity @ 40°C for 96
hours per MIL-STD-202, Method 103



ELECTRICAL

Withstanding Voltage: Right Angle - minimum AC 1250V
RMS @ sea level, Vertical -
minimum AC
1000V RMS @ sea level

Current Rating: 5 Ampe

Contact Resistance: 15 milliohms maximum

Insulation Resistance: 5000 megohms maximum (initial);
1000 megohms (minimum) after
environmental testing



MECHANICAL

**Individual Contact Insertion and
Separation Force (minimum/maximum):** 0.7 oz./12 oz.

Durability: 500 mating cycles



Economical D-subminiature Metal Shell Right-Angle PCB D*KL Series

Cinch

Right-Angle Connectors

- 0.318" footprint.
- Available in 9, 15, and 25 position plugs and sockets.
- Offered with 4-40 threaded inserts for secure mounting to panels or with female screwlocks.
- Boardlocks to provide mechanical hold-down during wave soldering process.
- **Materials:**
 - Boardlock: Brass with tin plating.
 - Female Screwlock: Brass with nickel plating.

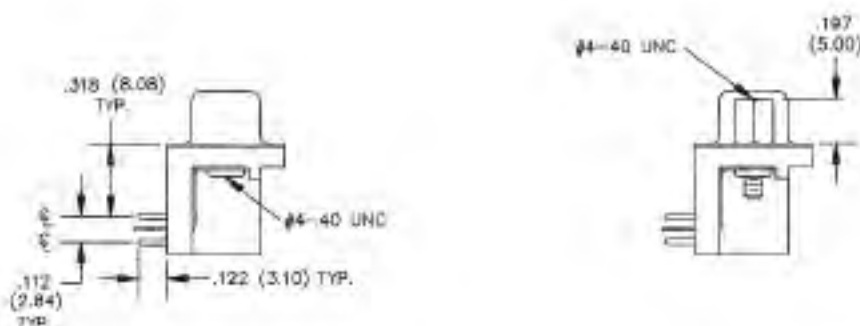

Ordering Information

Right-Angle Plugs

| Size | 4-40 Threaded Inserts | | Female Screwlocks | |
|------|-----------------------|----------------|-------------------|----------------|
| | Gold Flash | 30µin. Gold | Gold Flash | 30µin. Gold |
| 9 | DEKL-9PATI-E | DEKL-9PATI-E2 | DEKL-9PATI-F | DEKL-9PATI-F2 |
| 15 | DAKL-15PATI-E | DAKL-15PATI-E2 | DAKL-15PATI-F | DAKL-15PATI-F2 |
| 25 | DBKL-25PATI-E | DBKL-25PATI-E2 | DBKL-25PATI-F | DBKL-25PATI-F2 |

Right-Angle Sockets

| Size | 4-40 Threaded Inserts | | Female Screwlocks | |
|------|-----------------------|---------------|-------------------|---------------|
| | Gold Flash | 30µin. Gold | Gold Flash | 30µin. Gold |
| 9 | DEKL-9SAT-E | DEKL-9SAT-E2 | DEKL-9SAT-F | DEKL-9SAT-F2 |
| 15 | DAKL-15SAT-E | DAKL-15SAT-E2 | DAKL-15SAT-F | DAKL-15SAT-F2 |
| 25 | DBKL-25SAT-E | DBKL-25SAT-E2 | DBKL-25SAT-F | DBKL-25SAT-F2 |

D-subminiature Metal Shell Vertical PCB D*KL Series



Vertical Connectors:

- Available in 9, 15, 25, 37, and 50 position plugs and sockets with straight dip solder tails.
- 0.024" contact diameter.
- Offered with standard mounting holes.

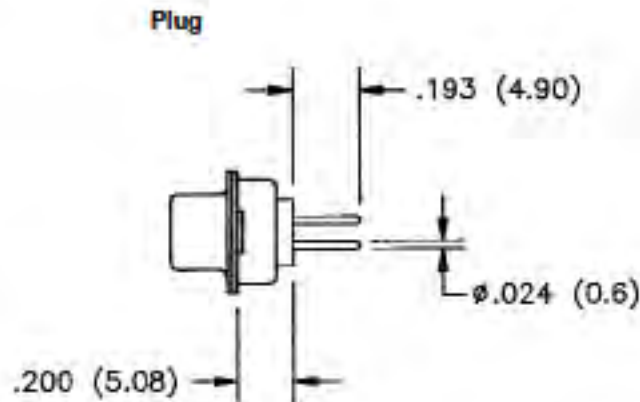

Ordering Information

4

Vertical PCB Connectors

| Size | Plugs | | Sockets | |
|------|-------------|---------------|------------|--------------|
| | Gold Flash | 30μin. Gold | Gold Flash | 30μin. Gold |
| 9 | DEKL-9PUTI | DEKL-9PUTI-2 | DEKL-9SUT | DEKL-9SUT-2 |
| 15 | DAKL-15PUTI | DAKL-15PUTI-2 | DAKL-15SUT | DAKL-15SUT-2 |
| 25 | DBKL-25PUTI | DBKL-25PUTI-2 | DBKL-25SUT | DBKL-25SUT-2 |
| 37 | DCKL-37PUTI | DCKL-37PUTI-2 | DCKL-37SUT | DCKL-37SUT-2 |
| 50 | DDKL-50PUTI | DDKL-50PUTI-2 | DDKL-50SUT | DDKL-50SUT-2 |

D-subminiature 1.5 Density Metal Shell Crimp and Poke and Right-Angle PCB HPD/HTD Series



FEATURES

- 1.5 Density means the connector uses small size #22 contacts for a higher pin count in a standard size shell. Also accepts standard D-subminiature accessories (hoods, backshells, etc.) per the following chart:

| Shell Size | 1.5 D-sub No. of Pins | Standard D-sub No. of Pins |
|------------|--------------------------|-------------------------------|
| E | 15 | 9 |
| A | 26 | 15 |
| B | 44 | 25 |
| C | 62 | 37 |

- Offered in cable plugs and right-angle PCB mount sockets.
- Metal Shell provides grounding and shielding capability.
- Approvals:
 - Plugs: • UL Recognized - Files E170218 (UL1977) & E130965 (UL1863).
 - CSA Approved - File LR31996-7.
 - Sockets: UL Recognized - File E170218.
- See pages 4-5 thru 4-10 for standard dimensions, contact arrangements, and panel mounting specifications.

MATERIALS

Connector Shell: Steel with tin plating (grounding indents on plug)

Contact Material: Phosphor bronze (stamped)

Contact Plating:

- Sockets: Gold flash or 30µin. gold in mating area and tin/lead on tails. All over nickel.
- Plugs: Gold flash or 30µin. gold in mating area and gold flash on remainder. All over nickel.



ENVIRONMENTAL

Operating Temperature: -55°C to +125°C

Shock: 50G peak per MIL-STD-202, Method 213, Condition G

Vibration: 12 cycles in three perpendicular directions @10-2000Hz, per MIL-STD-202, Method 204, Condition D

Moisture Resistance: 90-95% relative humidity @ 40°C for 96 hours per MIL-STD-202, Method 103



ELECTRICAL

Withstanding Voltage: Minimum 1000V RMS @ sea level

Current Rating: 3 Amps

Contact Resistance: 15 milliohms maximum

Insulation Resistance: 5000 megohms maximum (initial); 1000 megohms (minimum) after environmental testing



MECHANICAL

Individual Contact Insertion and

Separation Force (minimum/maximum): 0.7 oz./12 oz.

Durability:

- Plugs - 200 mating cycles
- Sockets - 200 mating cycles



D-subminiature 1.5 Density Metal Shell Crimp and Poke Plugs HTD Series

Connectors:

- Offered with .120 mounting holes.
- Shells offered with tin plating and grounding indents.
- These connectors are designed to accommodate one repair cycle.

Contacts: (Not included with connectors, order separately)

- Available with gold-flash plating or 30µin. gold.
- Crimp and Poke versions are offered in reels of 15,000 or 300 contacts.
- Solder and Poke contacts are packed loose.
- Will accommodate 22-30 AWG wire.
- Order contacts separately. See page 4-18.

Termination Tooling:

- Semi-automatic Stripper Crimper Tool for 15,000 reels: #HTD-518. See page 4-102.
- Crimp Contact Hand Tool for 300-piece reels: #HTD-266. See page 4-101.
- Semi-automatic Hand Crimping Tool for individual contact termination: #HTD-544. See page 4-101.
- Contact Insertion/Extraction Tool: Cinch #CIET-22-DF. See page 4-101.

Materials:

- Insulator Material: Black UL 94 V-0 glass-filled nylon.

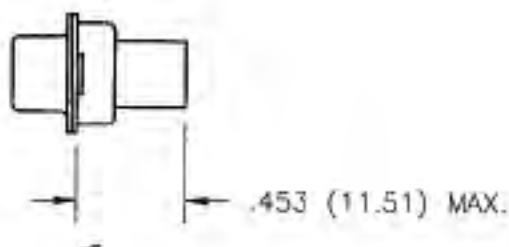

Ordering Information

HTD Series 1.5 Density Crimp and Poke Plug Connectors

| Size | Shell Size | Catalog Number |
|------|------------|----------------|
| 15 | E | HTDE-15PTI-FO |
| 26 | A | HTDA-26PTI-FO |
| 44 | B | HTDB-44PTI-FO |
| 62 | C | HTDC-62PTI-FO |

D-subminiature 1.5 Density Metal Shell Crimp and Poke Plugs HTD Series



- Use with HTD Series 1.5 D-Sub Crimp and Poke connectors and overmold kits.
- All Crimp and Poke contacts are on right-hand feed reels.

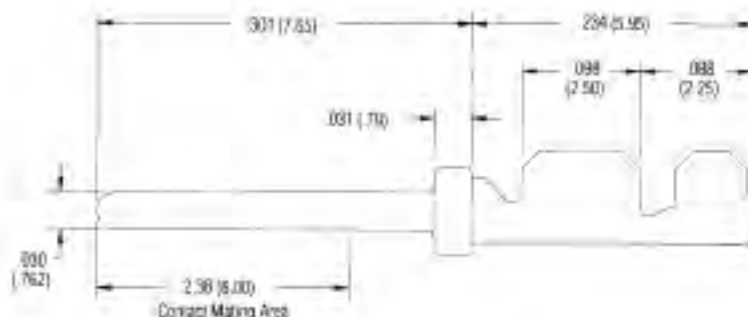

Crimp and Poke Plug Contact

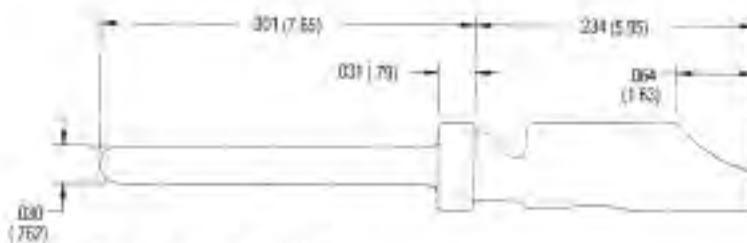

Solder and Poke Plug

4

Ordering Information

HTD Series 1.5 D-sub Male Crimp and Poke and Solder and Poke Contacts

| Type of Packing | Crimp and Poke 15,000 Reel | | Crimp and Poke 300 Reel | | Solder and Poke Loose | |
|-----------------|-------------------------------|----------------|----------------------------|--------------|--------------------------|---------------|
| | Gold Flash | 30µin. Gold | Gold Flash | 30µin. Gold | Gold Flash | 30µin. Gold |
| Pin | HTD-CP-9-15000 | HTD-CP-1-15000 | HTD-CP-9-300 | HTD-CP-1-300 | HTD-SP-9-10 | Not Available |

D-subminiature 1.5 Density Metal Shell Right-Angle PCB Sockets HPD Series



- .350" footprint.
- Offered with fixed 4-40 threaded inserts for secure mounting to panels or with assembled female screwlocks.
- Boardlocks to maintain electrical continuity between shell and PC board ground and provide mechanical hold-down during wave soldering process.
- Available in standard configuration sockets, sizes 15, 26, 44, and 62 with black insulator.
- 15 position socket also available with royal blue insulator in Windows '95® configuration with Pin #9 recessed 0.050".

Materials:

- Insulator Material: Glass-filled polyester (standard configuration - black, -9R configuration - blue), UL 94V-0 rated.
- Boardlock: Brass with tin plating.
- Female Screwlock: Brass with Nickel plating.

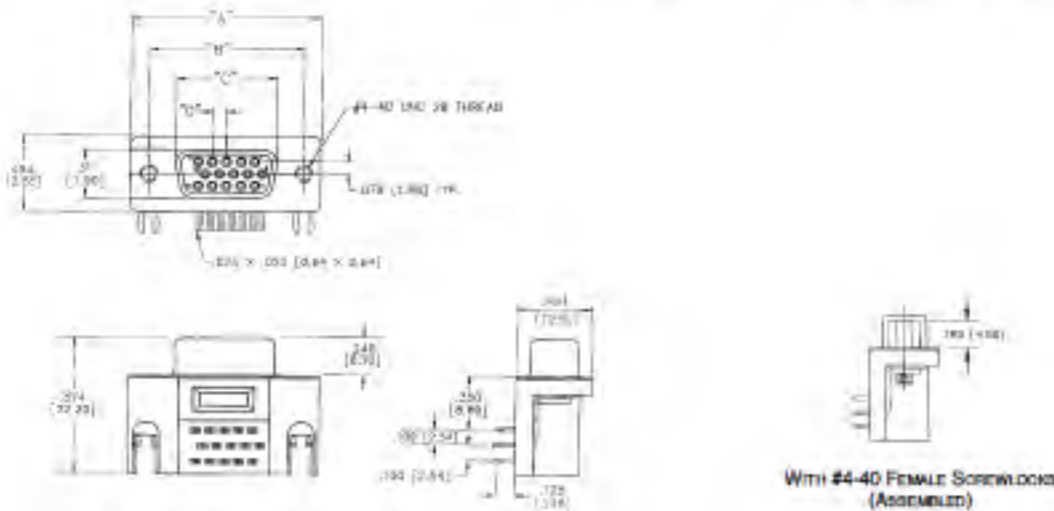

Dimensions

| Positions | A | | B | | C | | D | |
|-----------|------------------|---------------------|------------------|--------------------|------------------|--------------------|-------|------|
| | ± 0.15 in | (± 0.038) mm | ± 0.10 in | (± 0.25) mm | ± 0.10 in | (± 0.25) mm | in | mm |
| 15 | 1.214 | 30.84 | 0.984 | 24.99 | 0.640 | 16.26 | 0.090 | 2.29 |
| 26 | 1.545 | 39.24 | 1.312 | 33.32 | 0.967 | 24.56 | 0.090 | 2.29 |
| 44 | 2.088 | 53.04 | 1.852 | 47.04 | 1.508 | 38.30 | 0.090 | 2.29 |
| 62 | 2.730 | 69.34 | 2.500 | 63.50 | 2.156 | 54.76 | 0.095 | 2.41 |

Ordering Information

HPD Series 1.5 Density Right-Angle Socket Connectors

| Size | Shell | | | 4-40 Threaded Inserts | | Female Screwlocks | |
|------|-------|--------------|-------|-----------------------|-------------------|-------------------|-------------------|
| | Size | Type | Color | Gold Flash | 30µin. Gold | Gold Flash | 30µin. Gold |
| 15 | E | Standard | Black | HPDEB-15SAT-E | HPDEB-15SAT-E2 | HPDEB-15SAT-F | HPDEB-15SAT-F2 |
| 26 | A | Standard | Black | HPDAB-26SAT-E | HPDAB-26SAT-E2 | HPDAB-26SAT-F | HPDAB-26SAT-F2 |
| 44 | B | Standard | Black | HPDDB-44SAT-E | HPDDB-44SAT-E2 | HPDDB-44SAT-F | HPDDB-44SAT-F2 |
| 62 | C | Standard | Black | HPDCB-62SAT-E | HPDCB-62SAT-E2 | HPDCB-62SAT-F | HPDCB-62SAT-F2 |
| 15 | E | Windows '95® | Blue | HPDEB-15SAT-E-9R | HPDEB-15SAT-E2-9R | HPDEB-15SAT-F-9R | HPDEB-15SAT-F2-9R |

Windows '95 is a registered trademark of Microsoft.

D-subminiature Metal Shell Crimp and Poke D*A Series



FEATURES

- Offered in 9, 15, 25, 37, and 50 position plugs and sockets.
- Contacts:
 - Available with gold flash or 30µin. gold plating.
 - Offered in 15,000 contact reel or 300 contact reel, or in loose-piece bags of 100 or 1000 each.
 - Accommodate 20-24 AWG wire or 26-30 AWG wire.
 - Not included with connector - order stamped contacts separately.
- Approvals:
 - UL Recognized - Files E170218 (UL1977) and E130965 (UL1863).
 - CSA Approved - File LR31996.
- See pages 4-5 thru 4-10 for standard dimensions, contact arrangements, and panel mounting specifications.

MATERIALS

Insulator Material: Glass-filled nylon (black), UL 94 V-O rated
Connector Shell: Steel with zinc plating and yellow chromate finish or tin plating (plug has grounding indents)
Contact Material:

- Plug - Brass (stamped)
- Socket - Phosphor bronze (stamped)

Contact Plating: Gold flash or 30µin. gold in mating area and gold flash on the remainder. All over nickel.
4-40 Clinch Nut: Steel with cadmium plating and yellow chromate finish
Dual Float Bushing: Stainless steel, passivated



ENVIRONMENTAL

Operating Temperature: -65°C to + 125°C
Shock: 50G peak per MIL-STD-202, Method 213, Condition G
Vibration: 12 cycles in three perpendicular directions @ 10-2000Hz, per MIL-STD-202, Method 204, Condition D
Moisture Resistance: 90-95% relative humidity @ 40°C for 96 hours per MIL-STD-202, Method 103

ELECTRICAL

Withstanding Voltage: Minimum 1000V RMS @ sea level
Current Rating: 5 Amps
Contact Resistance: 2.7 milliohms maximum
Insulation Resistance: 5000 megohms maximum (initial); 1000 megohms (minimum) after environmental testing

MECHANICAL

Individual Contact Insertion and Separation Force (minimum/maximum): 0.7 oz./12 oz.
Durability: 500 mating cycles

D-subminiature Metal Shell Crimp and Poke Connectors D*A Series

Cinch

- Offered with .120 mounting holes or 4-40 clinch nuts.

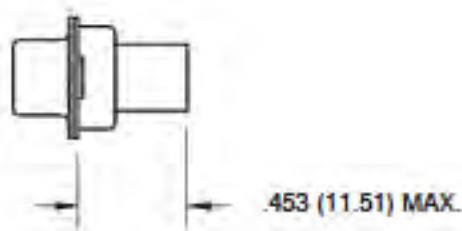

Termination Tools

- Semi-Automatic Stripper Crimper Tool for 15K reels: #GSC-20-30. See page 4-102.
- Contact Insertion/Extraction Tool: #CIET-20-HDB. See page 4-101.
- Crimp Contact Hand Tool for 300-piece reels: #GHC-B (20-28 AWG wire) or Catalog #GHC-B1 (28-30 AWG wire). See page 4-101.
- Crimp Contact Hand Tool for loose piece contacts: #HTD-544. See page 4-101.

Ordering Information

D*A Series Crimp and Poke Connectors - Plugs

| Positions | Zinc-plated shell with yellow chromate finish | | Tin-plated shell with grounding indents | |
|-----------|---|------------------|---|------------------|
| | Mounting Holes | 4-40 Clinch Nuts | Mounting Holes | 4-40 Clinch Nuts |
| 9 | DEA-9P-FO | DEAE-9P-FO | DEA-9PTI-FO | DEAE-9PTI-FO |
| 15 | DAA-15P-FO | DAAE-15P-FO | DAA-15PTI-FO | DAAE-15PTI-FO |
| 25 | DBA-25P-FO | DBAE-25P-FO | DBA-25PTI-FO | DBAE-25PTI-FO |
| 37 | DCA-37P-FO | DCAE-37P-FO | DCA-37PTI-FO | DCAE-37PTI-FO |
| 50 | DDA-50P-FO | DDAE-50P-FO | DDA-50PTI-FO | DDAE-50PTI-FO |

D*A Series Crimp and Poke Connectors - Sockets

| Positions | Zinc-plated shell with yellow chromate finish | | Tin-plated shell | |
|-----------|---|------------------|------------------|------------------|
| | Mounting Holes | 4-40 Clinch Nuts | Mounting Holes | 4-40 Clinch Nuts |
| 9 | DEA-9S-FO | DEAE-9S-FO | DEA-9ST-FO | DEAE-9ST-FO |
| 15 | DAA-15S-FO | DAAE-15S-FO | DAA-15ST-FO | DAAE-15ST-FO |
| 25 | DBA-25S-FO | DBAE-25S-FO | DBA-25ST-FO | DBAE-25ST-FO |
| 37 | DCA-37S-FO | DCAE-37S-FO | DCA-37ST-FO | DCAE-37ST-FO |
| 50 | DDA-50S-FO | DDAE-50S-FO | DDA-50ST-FO | DDAE-50ST-FO |

D-subminiature Metal Shell Crimp and Poke Insulation Grip Contacts D*A Series



Contacts

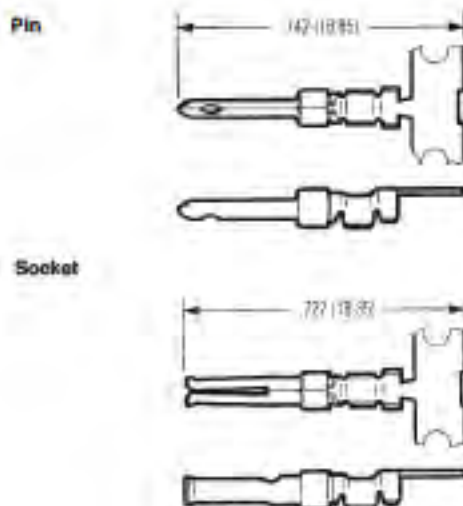

Ordering Information

D*A Series Crimp and Poke Contacts on Reels

| Contacts per Reel | 15,000 | | 15,000 | | 300 | | 300 | |
|-------------------|------------|-------------|------------|-------------|------------|-------------|------------|-------------|
| Wire Gauge | 20-24 AWG | | 26-30 AWG | | 20-24 AWG | | 26-30 AWG | |
| Plating | Gold Flash | 30µin. Gold | Gold Flash | 30µin. Gold | Gold Flash | 30µin. Gold | Gold Flash | 30µin. Gold |
| Pin | DGP-15-1 | DGP-15-2 | DGP-15-3 | DGP-15-4 | DGP-3-1 | DGP-3-2 | DGP-3-3 | DGP-3-4 |
| Socket | DGS-15-1 | DGS-15-2 | DGS-15-3 | DGS-15-4 | DGS-3-1 | DGS-3-2 | DGS-3-3 | DGS-3-4 |

D*A Series Crimp and Poke Loose-Piece Contacts

| Contacts per Bag | 100 | | 100 | | 1000 | | 1000 | |
|------------------|------------|-------------|------------|-------------|-------------|-------------|-------------|-------------|
| Wire Gauge | 20-24 AWG | | 26-30 AWG | | 20-24 AWG | | 26-30 AWG | |
| Plating | Gold Flash | 30µin. Gold | Gold Flash | 30µin. Gold | Gold Flash | 30µin. Gold | Gold Flash | 30µin. Gold |
| Pin | DGP-100L-1 | DGP-100L-2 | DGP-100L-3 | DGP-100L-4 | DGP-1000L-1 | DGP-1000L-2 | DGP-1000L-3 | DGP-1000L-4 |
| Socket | DGS-100L-1 | DGS-100L-2 | DGS-100L-3 | DGS-100L-4 | DGS-1000L-1 | DGS-1000L-2 | DGS-1000L-3 | DGS-1000L-4 |

D-subminiature Metal Shell Overmold Kits D*A and HTD Series



FEATURES

- *Cinch overmold kits enable you to overmold the connector of the cable assembly for less material and process cost (versus a metal backshell), improved appearance, and improved shielding of the connector to help meet RF/EMI requirements.*
- *An Overmold Kit catalog number consists of:*
 - *D*A or HTD Crimp and Poke connector.*
 - *Inside shielding cover.*
 - *Outside shielding cover.*
- *You will also need to order the following:*
 - *Crimp and Poke stamped contacts must be ordered separately on page 4-22 for D*A and page 4-18 for HTD connectors.*
 - *Ferrules are required, but must be ordered separately according to the size necessary to accommodate the wire. See page 4-25.*
 - *Termination tooling is required to crimp the wires on the connector.*
 - *A hand tool and appropriate crimping die are required for crimping the ferrule.*
- *All specifications on the connector portion of the overmold kit can be found on pages 4-16 thru 4-17 for HPD 1.5 density and pages 4-20 thru 4-21 for D*A series.*

MATERIALS

Shield Covers: Steel (stamped) with tin/lead finish
Ferrule: Brass

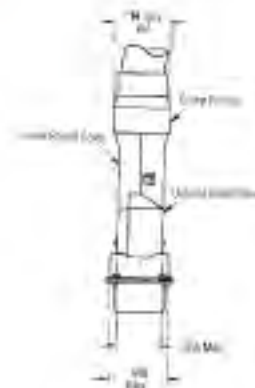
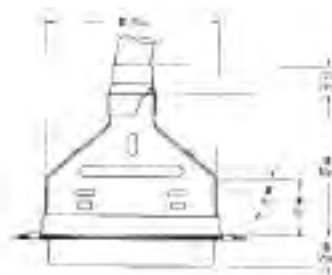

Dimensions

Overmold Shielding Kits

| Positions | C | | D | | E | | F | | G | H | |
|-----------|-------|------|-------|-------|-------|-------|-------|-------|------|-------|-------|
| | in | mm | in | mm | in | mm | in | mm | Deg. | in | mm |
| 9 Plug | 0.270 | 6.86 | 0.705 | 17.91 | 1.320 | 33.53 | 0.520 | 13.21 | 75° | 0.440 | 11.18 |
| 9 Socket | 0.285 | 7.24 | 0.705 | 17.91 | 1.320 | 33.53 | 0.520 | 13.21 | 75° | 0.440 | 11.18 |
| 15 Plug | 0.270 | 6.86 | 1.050 | 26.67 | 1.320 | 33.53 | 0.520 | 13.21 | 58° | 0.440 | 11.18 |
| 15 Socket | 0.285 | 7.24 | 1.050 | 26.67 | 1.320 | 33.53 | 0.520 | 13.21 | 58° | 0.440 | 11.18 |
| 25 Plug | 0.275 | 6.99 | 1.590 | 40.39 | 1.320 | 33.53 | 0.520 | 13.21 | 40° | 0.440 | 11.18 |
| 25 Socket | 0.285 | 7.24 | 1.590 | 40.39 | 1.320 | 33.53 | 0.520 | 13.21 | 40° | 0.440 | 11.18 |
| 37 Plug | 0.275 | 6.99 | 2.240 | 56.90 | 1.620 | 41.15 | 0.750 | 19.05 | 32° | 0.520 | 13.21 |
| 37 Socket | 0.285 | 7.24 | 2.240 | 56.90 | 1.620 | 41.15 | 0.750 | 19.05 | 32° | 0.520 | 13.21 |

D-subminiature Metal Shell Overmold Kits and Ferrules D*A and HTD Series

Overmold Kits (Cont'd)

Ordering Information

D*A Series Crimp and Poke Overmold Kits

| Positions | Tin-plated shell | |
|-----------|------------------|---------------|
| | Plugs | Sockets |
| 9 | DEAO-9PTI-FO1 | DEAO-9ST-FO1 |
| 15 | DAAO-15PTI-FO1 | DAAO-15ST-FO1 |
| 25 | DBAO-25PTI-FO1 | DBAO-25ST-FO1 |
| 37 | DCAO-37PTI-FO1 | DCAO-37ST-FO1 |

HTD Series 1.5 Density Plugs Overmold Kits

| Size | Shell Size | Catalog Number |
|------|------------|-----------------|
| 15 | E | HTDEO-15PTI-FO1 |
| 26 | A | HTDAO-26PTI-FO1 |
| 44 | B | HTDBO-44PTI-FO1 |

Crimp Ferrule

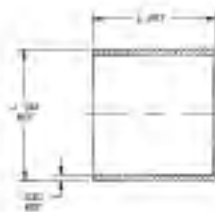

FIG. 2

Ordering Information

| Catalog Number | Type | J | | K | | L | | Crimp Die Catalog No. |
|----------------|------|------|-------|------|-------|------|-------|-----------------------|
| | | in | mm | in | mm | in | mm | |
| CF-51 | 1 | .437 | 11.10 | .200 | 5.08 | .450 | 11.43 | CD-07 |
| CF-42 | 1 | .437 | 11.10 | .235 | 5.97 | .450 | 11.43 | CD-00 |
| CF-43 | 1 | .437 | 11.10 | .250 | 6.35 | .450 | 11.43 | CD-01 |
| CF-44 | 1 | .437 | 11.10 | .325 | 8.28 | .450 | 11.43 | CD-02 |
| CF-45 | 1 | .437 | 11.10 | .350 | 8.89 | .450 | 11.43 | CD-03 |
| CF-46 | 1 | .437 | 11.10 | .375 | 9.53 | .450 | 11.43 | CD-04 |
| CF-47 | 2 | .437 | 11.10 | .437 | 11.10 | .450 | 11.43 | CD-05 |
| CF-50 | 2 | .460 | 11.68 | .460 | 11.68 | .450 | 11.43 | CD-06 |

- Pneumatic Bench Top Press for Crimping Ferrules #FCT-551. See page 4-103.
- Hand Tool for Crimping Ferrules #FCT-552. See page 4-103.

D-subminiature Metal Shell Crimp and Poke, Right-Angle and Vertical PCB D*U Series



FEATURES

- Offered in 9, 15, 25, 37, and 50 position plugs and sockets (except right-angle PCB connectors- 9, 15, and 25 positions).
- Available with gold flash or 30µin. gold plating.
- Offered with .120 mounting holes, optional 4-40 clinch nuts, or dual float bushings (except right-angle PCB connectors-mounting holes only).
- Approvals:
 - UL Recognized - Files E170218 (UL1977) and E130965 (UL1863).
 - CSA Approved - File LR31996.
- See pages 4-5 thru 4-10 for standard dimensions, contact arrangements, and panel mounting specifications.

MATERIALS

Insulator Material: Glass-filled nylon (black), UL 94 V-O rated
Connector Shell: Steel with zinc plating and yellow chromate finish or tin plating (grounding indents on plug)
4-40 Clinch Nut: Steel with cadmium plating and yellow chromate finish
Dual Float Bushing: Stainless steel, passivated

ENVIRONMENTAL

Operating Temperature: -85°C to + 125°C
Shock: 50G peak per MIL-STD-202, Method 213, Condition G
Vibration: 12 cycles in three perpendicular directions @ 10-2000Hz, per MIL-STD-202, Method 204, Condition D
Moisture Resistance: 90-95% relative humidity @ 40°C for 96 hours per MIL-STD-202, Method 103

ELECTRICAL

Withstanding Voltage: Minimum 1000V RMS @ sea level
Current Rating: 5 Amps
Contact Resistance: 2.7 milliohms maximum
Insulation Resistance: 5000 megohms maximum (initial); 1000 megohms (minimum) after environmental testing

MECHANICAL

Individual Contact Insertion and Separation Force (minimum/maximum): 0.7 oz./12 oz.
Durability: 500 mating cycles



D-subminiature Metal Shell Crimp and Poke D*U Series



- Machined contacts supplied loose with connector or can be ordered separately. Use with 20-24 AWG wire.
- Stamped Contacts (order separately) for use when ordering connector with contacts not included (-FO option). Use with 20-28 AWG wire.
 - Available in 10K reel.
 - Order reels of stamped contacts separately.

Materials

- Contact Material: Plug - Brass (stamped) or copper alloy (machined). Socket - Phosphor bronze (stamped) or copper alloy (machined).
- Contact Plating:
 - Stamped Plugs and Sockets: Gold flash or 30µin. gold and gold flash on the remainder. All over nickel.
 - Machined Plugs and Sockets: Gold flash or 30µin. gold. All over nickel.

Termination Tooling

- Semi-Automatic Stripper Crimper for Stamped Contacts on 10K PC reels: #ESC-20-3. See page 4-102.
- Contact Insertion/Extraction: #CIET-20-HDB. See page 4-101.
- Loose Contact Crimp Tool:
 - Machined Contact - #M22520/2-01. See page 4-103.
For Positioner as required see page 4-103.
 - Stamped Contacts #BT-20-HC see page 4-101.
No positioner required.

D-subminiature Metal Shell Crimp and Poke D*U Series

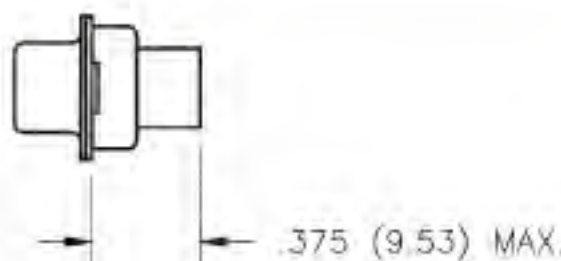

Ordering Information

D*U Crimp and Poke Plugs

Zinc-Plated Shell with Yellow Chromate Finish

| Position | Mounting Holes | | 4-40 Clinch Nuts | | Dual Float Bushings | |
|----------|-------------------|------------------|-------------------|------------------|---------------------|------------------|
| | Contacts Included | Without Contacts | Contacts Included | Without Contacts | Contacts Included | Without Contacts |
| 9 | DEU-9P | DEU-9P-FO | DEUE-9-P | DEUE-9P-FO | DEUY-9P | DEUY-9P-FO |
| 15 | DAU-15P | DAU-15P-FO | DAUE-15-P | DAUE-15-P-FO | DAUY-15P | DAUY-15P-FO |
| 25 | DBU-25P | DBU-25P-FO | DBUE-25-P | DBUE-25P-FO | DBUY-25P | DBUY-25P-FO |
| 37 | DCU-37P | DCU-37P-FO | DCUE-37-P | DCUE-37P-FO | DCUY-37P | DCUY-37P-FO |
| 50 | DDU-50P | DDU-50P-FO | DDUE-50-P | DDUE-50P-FO | DDUY-50P | DDUY-50P-FO |

Tin-Plated Shell with Grounding Indents

| Position | Mounting Holes | | 4-40 Clinch Nuts | | Dual Float Bushings | |
|----------|-------------------|------------------|-------------------|------------------|---------------------|------------------|
| | Contacts Included | Without Contacts | Contacts Included | Without Contacts | Contacts Included | Without Contacts |
| 9 | DEU-9PTI | DEU-9PTI-FO | DEUE-9PTI | DEUE-9PTI-FO | DEUY-9PTI | DEUY-9PTI-FO |
| 15 | DAU-15PTI | DAU-15PTI-FO | DAUE-15PTI | DAUE-15PTI-FO | DAUY-15PTI | DAUY-15PTI-FO |
| 25 | DBU-25PTI | DBU-25PTI-FO | DBUE-25PTI | DBUE-25PTI-FO | DBUY-25PTI | DBUY-25PTI-FO |
| 37 | DCU-37PTI | DCU-37PTI-FO | DCUE-37PTI | DCUE-37PTI-FO | DCUY-37PTI | DCUY-37PTI-FO |
| 50 | DDU-50PTI | DDU-50PTI-FO | DDUE-50PTI | DDUE-50PTI-FO | DDUY-50PTI | DDUY-50PTI-FO |

D*U Crimp and Poke Sockets

Zinc-Plated Shell with Yellow Chromate Finish

| Position | Mounting Holes | | 4-40 Clinch Nuts | | Dual Float Bushings | |
|----------|-------------------|------------------|-------------------|------------------|---------------------|------------------|
| | Contacts Included | Without Contacts | Contacts Included | Without Contacts | Contacts Included | Without Contacts |
| 9 | DEU-9S | DEU-9S-FO | DEUE-9S | DEUE-9S-FO | DEUY-9S | DEUY-9S-FO |
| 15 | DAU-15S | DAU-15S-FO | DAUE-15S | DAUE-15S-FO | DAUY-15S | DAUY-15S-FO |
| 25 | DBU-25S | DBU-25S-FO | DBUE-25S | DBUE-25S-FO | DBUY-25S | DBUY-25S-FO |
| 37 | DCU-37S | DCU-37S-FO | DCUE-37S | DCUE-37S-FO | DCUY-37S | DCUY-37S-FO |
| 50 | DDU-50S | DDU-50S-FO | DDUE-50S | DDUE-50S-FO | DDUY-50S | DDUY-50S-FO |

Tin-Plated Shell

| Position | Mounting Holes | | 4-40 Clinch Nuts | | Dual Float Bushings | |
|----------|-------------------|------------------|-------------------|------------------|---------------------|------------------|
| | Contacts Included | Without Contacts | Contacts Included | Without Contacts | Contacts Included | Without Contacts |
| 9 | DEU-9ST | DEU-9ST-FO | DEUE-9ST | DEUE-9ST-FO | DEUY-9ST | DEUY-9ST-FO |
| 15 | DAU-15ST | DAU-15ST-FO | DAUE-15ST | DAUE-15ST-FO | DAUY-15ST | DAUY-15ST-FO |
| 25 | DBU-25ST | DBU-25ST-FO | DBUE-25ST | DBUE-25ST-FO | DBUY-25ST | DBUY-25ST-FO |
| 37 | DCU-37ST | DCU-37ST-FO | DCUE-37ST | DCUE-37ST-FO | DCUY-37ST | DCUY-37ST-FO |
| 50 | DDU-50ST | DDU-50ST-FO | DDUE-50ST | DDUE-50ST-FO | DDUY-50ST | DDUY-50ST-FO |

D-subminiature Metal Shell Crimp and Poke Contacts D*U Series



Machined Contacts - 20-24 AWG Wire

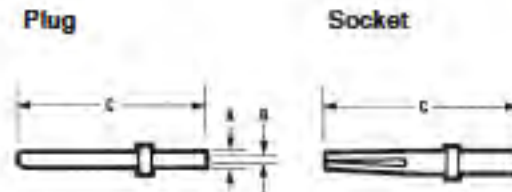

Dimensions

| Description | Wire AWG | A | | B | | C Max. | |
|-------------|-------------|------|------|------|------|--------|-------|
| | | in | mm | in | mm | in | mm |
| Pin | #20, 22, 24 | .066 | 1.67 | .045 | 1.14 | .537 | 13.64 |
| Socket | #20, 22, 24 | .066 | 1.67 | .045 | 1.14 | .523 | 13.28 |

Ordering Information

D*U Series Loose-Piece Machined Contacts

| | Gold Flash | 30µin. Gold |
|--------|--------------|--------------|
| Pin | 030-1952-000 | 030-1952-030 |
| Socket | 030-1953-000 | 030-1953-030 |

Stamped Contacts - 20-28 AWG Wire

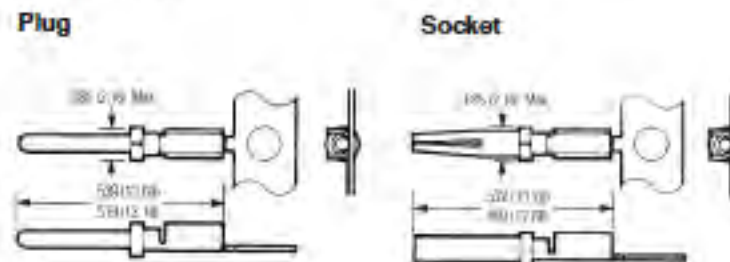

Ordering Information

D*U Series Stamped Contacts on 10K Reels

| | Gold Flash | 30µin. Gold |
|--------|--------------|-------------|
| Pin | BCL-1964-20P | D110238-034 |
| Socket | BCL-1963-20S | D110238-035 |

D-subminiature Metal Shell Right-Angle Dip Solder PCB D*U Series



- .445" footprint.
- .024" contact diameter.

Materials

- Contact Material: Socket - Copper alloy (machined), Plug - Brass (machined).
- Contact Plating: Gold flash or 30µin. gold. All over nickel.
- Mounting bracket: Black nylon. Can be removed if necessary.

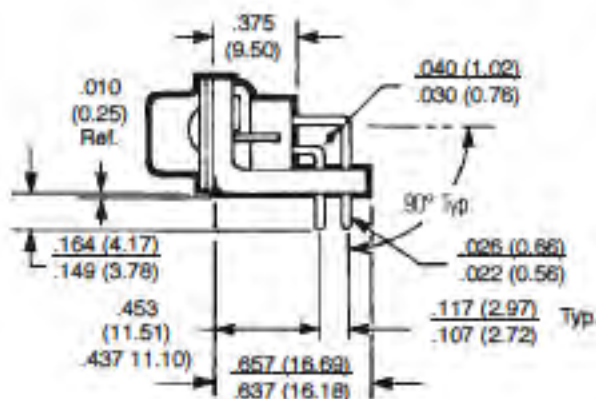

4

Ordering Information

D*U Right-Angle Plugs

| Positions | Zinc-Plated Shell with Yellow Chromate Finish | | Tin-Plated Shell with Grounding Indents | |
|-----------|---|--------------|---|----------------|
| | Gold Flash | 30µin. Gold | Gold Flash | 30µin. Gold |
| 9 | DEU-9PAD | DEU-9PAD-30 | DEU-9PADTI | DEU-9PADTI-30 |
| 15 | DAU-15PAD | DAU-15PAD-30 | DAU-15PADTI | DAU-15PADTI-30 |
| 25 | DBU-25PAD | DBU-25PAD-30 | DBU-25PADTI | DBU-25PADTI-30 |

D*U Right-Angle Sockets

| Positions | Zinc-Plated Shell with Yellow Chromate Finish | | Tin-Plated Shell | |
|-----------|---|--------------|------------------|---------------|
| | Gold Flash | 30µin. Gold | Gold Flash | 30µin. Gold |
| 9 | DEU-9SAD | DEU-9SAD-30 | DEU-9SADT | DEU-9SADT-30 |
| 15 | DAU-15SAD | DAU-15SAD-30 | DAU-15SADT | DAU-15SADT-30 |
| 25 | DBU-25SAD | DBU-25SAD-30 | DBU-25SADT | DBU-25SADT-30 |

D-subminiature Metal Shell Vertical Dip Solder PCB D*U Series



- .024" contact diameter.
- Longer rear insulator provides integral standoff from PCB.

Materials

- Contact Material: Plug - Brass (machined), Socket - Copper alloy (machined).
- Contact Plating: Gold flash or 30µin. gold. All over nickel.

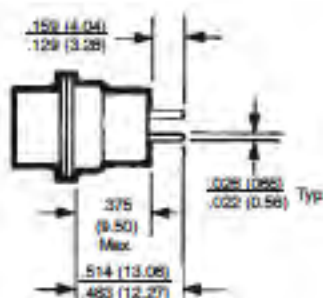

Ordering Information

Vertical Plugs

Zinc-Plated Shell with Yellow Chromate Finish

| Positions | Mounting Holes | | 4-40 Clinch Nuts | | Dual Float Bushings | |
|-----------|----------------|--------------|------------------|---------------|---------------------|---------------|
| | Gold Flash | 30µin. Gold | Gold Flash | 30µin. Gold | Gold Flash | 30µin. Gold |
| 9 | DEU-9PBF | DEU-9PBF-30 | DEUE-9PBF | DEUE-9PBF-30 | DEUY-9PBF | DEUY-9PBF-30 |
| 15 | DAU-15PBF | DAU-15PBF-30 | DAUE-15PBF | DAUE-15PBF-30 | DAUY-15PBF | DAUY-15PBF-30 |
| 25 | DBU-25PBF | DBU-25PBF-30 | DBUE-25PBF | DBUE-25PBF-30 | DBUY-25PBF | DBUY-25PBF-30 |
| 37 | DCU-37PBF | DCU-37PBF-30 | DCUE-37PBF | DCUE-37PBF-30 | DCUY-37PBF | DCUY-37PBF-30 |
| 50 | DDU-50PBF | DDU-50PBF-30 | DDUE-50PBF | DDUE-50PBF-30 | DDUY-50PBF | DDUY-50PBF-30 |

Tin-Plated Shell with Grounding Indents

| Positions | Mounting Holes | | 4-40 Clinch Nuts | | Dual Float Bushings | |
|-----------|----------------|----------------|------------------|-----------------|---------------------|-----------------|
| | Gold Flash | 30µin. Gold | Gold Flash | 30µin. Gold | Gold Flash | 30µin. Gold |
| 9 | DEU-9PBFTI | DEU-9PBFTI-30 | DEUE-9PBFTI | DEUE-9PBFTI-30 | DEUY-9PBFTI | DEUY-9PBFTI-30 |
| 15 | DAU-15PBFTI | DAU-15PBFTI-30 | DAUE-15PBFTI | DAUE-15PBFTI-30 | DAUY-15PBFTI | DAUY-15PBFTI-30 |
| 25 | DBU-25PBFTI | DBU-25PBFTI-30 | DBUE-25PBFTI | DBUE-25PBFTI-30 | DBUY-25PBFTI | DBUY-25PBFTI-30 |
| 37 | DCU-37PBFTI | DCU-37PBFTI-30 | DCUE-37PBFTI | DCUE-37PBFTI-30 | DCUY-37PBFTI | DCUY-37PBFTI-30 |
| 50 | DDU-50PBFTI | DDU-50PBFTI-30 | DDUE-50PBFTI | DDUE-50PBFTI-30 | DDUY-50PBFTI | DDUY-50PBFTI-30 |

D-subminiature Metal Shell Vertical Dip Solder PCB D*U Series



Ordering Information (Cont'd)

Vertical Sockets

Zinc-Plated Shell with Yellow Chromate Finish

| Positions | Mounting Holes | | 4-40 Clinch Nuts | | Dual Float Bushings | |
|-----------|----------------|--------------|------------------|---------------|---------------------|---------------|
| | Gold Flash | 30µin. Gold | Gold Flash | 30µin. Gold | Gold Flash | 30µin. Gold |
| 9 | DEU-9SBF | DEU-9SBF-30 | DEUE-9SBF | DEUE-9SBF-30 | DEUY-9SBF | DEUY-9SBF-30 |
| 15 | DAU-15SBF | DAU-15SBF-30 | DAUE-15SBF | DAUE-15SBF-30 | DAUY-15SBF | DAUY-15SBF-30 |
| 25 | DBU-25SBF | DBU-25SBF-30 | DBUE-25SBF | DBUE-25SBF-30 | DBUY-25SBF | DBUY-25SBF-30 |
| 37 | DCU-37SBF | DCU-37SBF-30 | DCUE-37SBF | DCUE-37SBF-30 | DCUY-37SBF | DCUY-37SBF-30 |
| 50 | DDU-50SBF | DDU-50SBF-30 | DDUE-50SBF | DDUE-50SBF-30 | DDUY-50SBF | DDUY-50SBF-30 |

Tin-Plated Shell

| Positions | Mounting Holes | | 4-40 Clinch Nuts | | Dual Float Bushings | |
|-----------|----------------|---------------|------------------|----------------|---------------------|----------------|
| | Gold Flash | 30µin. Gold | Gold Flash | 30µin. Gold | Gold Flash | 30µin. Gold |
| 9 | DEU-9SBFT | DEU-9SBFT-30 | DEUE-9SBFT | DEUE-9SBFT-30 | DEUY-9SBFT | DEUY-9SBFT-30 |
| 15 | DAU-15SBFT | DAU-15SBFT-30 | DAUE-15SBFT | DAUE-15SBFT-30 | DAUY-15SBFT | DAUY-15SBFT-30 |
| 25 | DBU-25SBFT | DBU-25SBFT-30 | DBUE-25SBFT | DBUE-25SBFT-30 | DBUY-25SBFT | DBUY-25SBFT-30 |
| 37 | DCU-37SBFT | DCU-37SBFT-30 | DCUE-37SBFT | DCUE-37SBFT-30 | DCUY-37SBFT | DCUY-37SBFT-30 |
| 50 | DDU-50SBFT | DDU-50SBFT-30 | DDUE-50SBFT | DDUE-50SBFT-30 | DDUY-50SBFT | DDUY-50SBFT-30 |

D-subminiature Metal Shell and All Plastic Solder Cup and IDC T* Series



FEATURES

- Offered in 9, 15, 25, and 37 position plugs and sockets.
- Available in Solder Cup and IDC (insulation displacement) terminations for discrete wire.
- Offered with .120 mounting holes.
- Approvals:
 - UL Recognized - Files E170218 (UL1977) and E130965 (UL1863).
 - CSA Approved - File LR31996.
- See pages 4-5 thru 4-10 for standard dimensions, contact arrangements, and panel mounting specifications.

MATERIALS

Insulator Material: Glass-filled polyester (black), UL 94 V-O rated
Connector Shell: Steel with zinc plating and yellow chromate finish or tin plating (grounding indents on plug)
Contact Material: Phosphor bronze (stamped)
Contact Plating: Gold flash or 30µin. gold in mating area and gold flash on the remainder. All over nickel.

ENVIRONMENTAL

Operating Temperature: -65°C to + 125°C
Shock: 50G peak per MIL-STD-202, Method 213, Condition G
Vibration: 12 cycles in three perpendicular directions @ 10-2000Hz, per MIL-STD-202, Method 204, Condition D
Moisture Resistance: 90-95% relative humidity @ 40°C for 96 hours per MIL-STD-202, Method 103

ELECTRICAL

Withstanding Voltage: Minimum 1000V RMS @ sea level
Current Rating: 3 Amps
Contact Resistance: 2.7 milliohms maximum
Insulation Resistance: 5000 megohms maximum (initial); 1000 megohms (minimum) after environmental testing

MECHANICAL

Individual Contact Insertion and Separation Force (minimum/maximum): 0.7 oz./12 oz.
Durability: 500 mating cycles

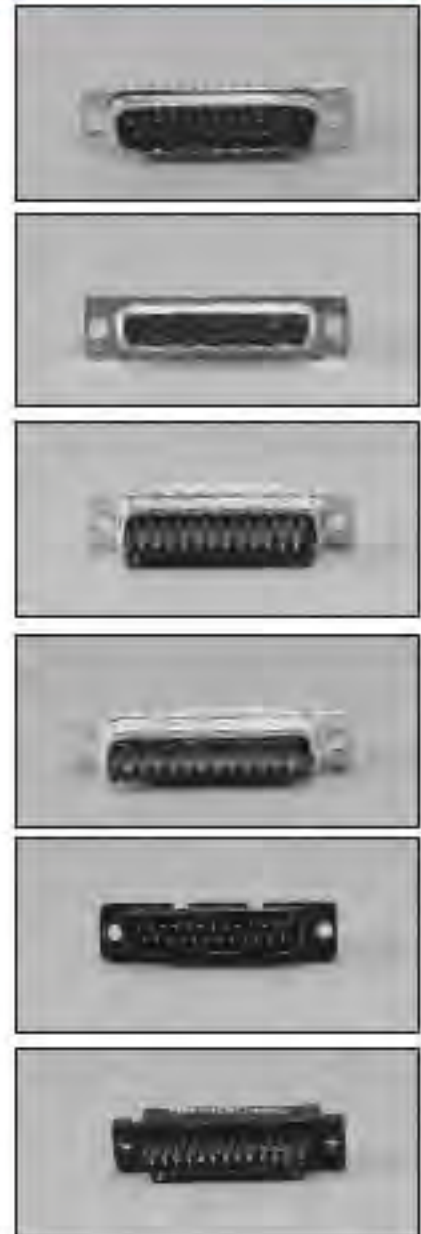

D-subminiature Metal Shell Solder Cup for Discrete Cable Wire T* Series



- Solder channels between barriers permit single-pass soldering of each row without solder bridging.
- Will accommodate up to 22 AWG wire.

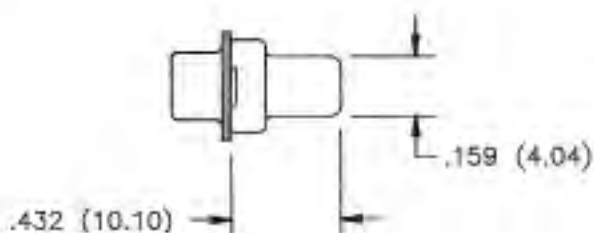

Ordering Information

Solder Cup Plugs

| Positions | Zinc-Plated Shell with Yellow Chromate Finish | | Tin-Plated Shell with Grounding Indents | |
|-----------|--|-------------|--|--------------|
| | Gold Flash | 30µin. Gold | Gold Flash | 30µin. Gold |
| 9 | TE-9PS | TE-9PS-30 | TE-9PTIS | TE-9PTIS-30 |
| 15 | TA-15PS | TA-15PS-30 | TA-15PTIS | TA-15PTIS-30 |
| 25 | TB-25PS | TB-25PS-30 | TB-25PTIS | TB-25PTIS-30 |
| 37 | TC-37PS | TC-37PS-30 | TC-37PTIS | TC-37PTIS-30 |

Solder Cup Sockets

| Positions | Zinc-Plated Shell with Yellow Chromate Finish | | Tin-Plated Shell | |
|-----------|--|-------------|------------------|-------------|
| | Gold Flash | 30µin. Gold | Gold Flash | 30µin. Gold |
| 9 | TE-9SS | TE-9SS-30 | TE-9STS | TE-9STS-30 |
| 15 | TA-15SS | TA-15SS-30 | TA-15STS | TA-15STS-30 |
| 25 | TB-25SS | TB-25SS-30 | TB-25STS | TB-25STS-30 |
| 37 | TC-37SS | TC-37SS-30 | TC-37STS | TC-37STS-30 |

D-subminiature Metal Shell IDC for Discrete Cable Wire T* Series



- Will accommodate 24-26 AWG solid or stranded PVC wire.

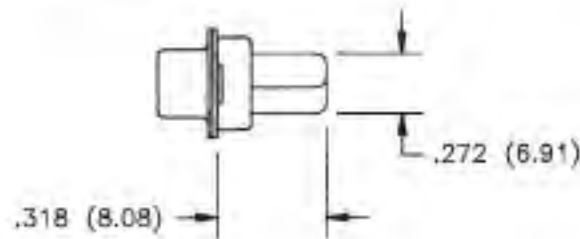

Ordering Information

IDC Plugs

| Positions | Zinc-Plated Shell with Yellow Chromate Finish | | Tin-Plated Shell with Grounding Indents | |
|-----------|--|-------------|--|--------------|
| | Gold Flash | 30µin. Gold | Gold Flash | 30µin. Gold |
| 9 | TE-9PSH | TE-9PSH-30 | TES-9PTI | TES-9PTI-30 |
| 15 | TA-15PSH | TA-15PSH-30 | TAS-15PTI | TAS-15PTI-30 |
| 25 | TB-25PSH | TB-25PSH-30 | TBS-25PTI | TBS-25PTI-30 |
| 37 | TC-37PSH | TC-37PSH-30 | TCS-37PTI | TCS-37PTI-30 |

IDC Sockets

| Positions | Zinc-Plated Shell with Yellow Chromate Finish | | Tin-Plated Shell | |
|-----------|--|-------------|------------------|-------------|
| | Gold Flash | 30µin. Gold | Gold Flash | 30µin. Gold |
| 9 | TE-9SSH | TE-9SSH-30 | TES-9ST | TES-9ST-30 |
| 15 | TA-15SSH | TA-15SSH-30 | TAS-15ST | TAS-15ST-30 |
| 25 | TB-25SSH | TB-25SSH-30 | TBS-25ST | TBS-25ST-30 |
| 37 | TC-37SSH | TC-37SSH-30 | TCS-37ST | TCS-37ST-30 |

D-subminiature Metal Shell IDC for Discrete Cable Wire T* Series



- Auto-Clinch D Semi-Automatic Termination Tool #ACD-432: See page 4-100.
 - Certi-Clinch D Manual Termination Tool #SD-CCWN: For 24-26 AWG wire: See page 4-100.
 - Uni-Clinch D Single-Wire Hand Insertion Tool #SD-UC: See page 4-100.
 - Super D Manual Stay Band Tool #SD-MSBT: See page 4-100.
-
- Optional strain relief covers for connectors when backshell is not required.

Ordering Information

| Positions | Catalog No. |
|-----------|-------------|
| 9 | SSD-WC9 |
| 15 | SSD-WC15 |
| 25 | SSD-WC25 |
| 37 | SSD-WC37 |



- One-piece cover for 9 contact size. Order one per connector. Two-piece cover for other sizes. Order two per connector.
- Cover fits both plug and socket.

D-subminiature All-Plastic IDC for Discrete Cable Wire T* Series



- For use only with SDH Series Gray Backshell on pages 4-89 thru 4-90.
- Offered in 9, 15, 25, and 37 position plugs and sockets.
- Connector will accommodate 24-28 AWG wire.
- Offered with plain flanges and .120 mounting holes, threaded bushings, latch blocks, or latch blocks and threaded bushings.

- Auto-Clinch D Semi-Automatic Termination Tool #ACD-432: See page 4-100.
- Certi-Clinch D Manual Termination Tool #SD-CC for 24-28 AWG wire: See page 4-100.
- Uni-Clinch D Single-Wire Hand Insertion Tool #SD-UC: See page 4-100.
- Super D Manual Stay Band Tool #SD-MSBT: See page 4-100.

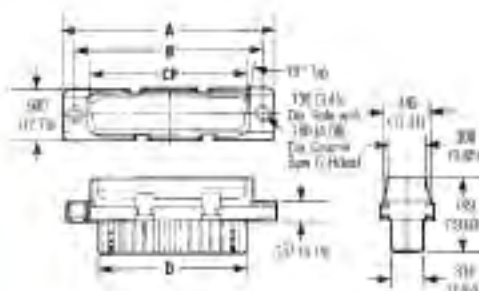

Plug with Latching Blocks

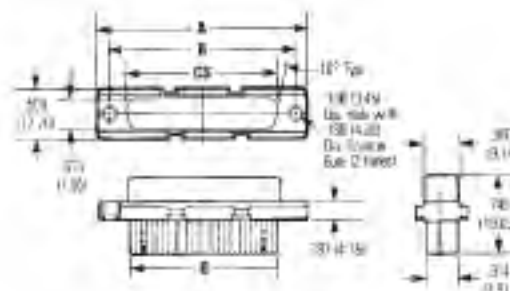

Socket with Latching Blocks

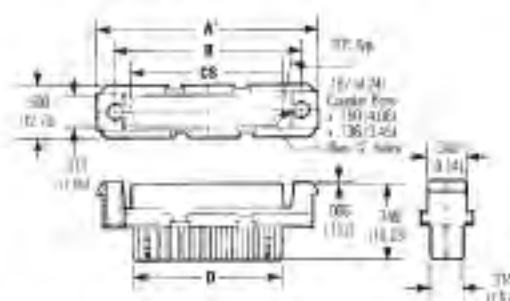
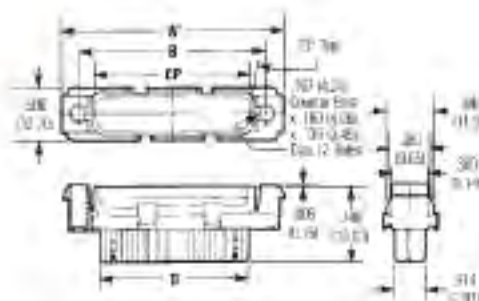

Dimensions

| Positions | A | | A | | B | | CP | | CS | | D | |
|-----------|-------|-------|-------|-------|-------|-------|-------|-------|-------|-------|-------|-------|
| | in | mm | in | mm | in | mm | in | mm | in | mm | in | mm |
| 9 | 1.209 | 30.71 | 1.309 | 33.25 | .984 | 24.99 | .668 | 16.96 | .642 | 16.31 | .592 | 15.04 |
| 15 | 1.536 | 39.01 | 1.636 | 41.55 | 1.312 | 33.32 | .995 | 25.28 | .970 | 24.64 | .918 | 23.31 |
| 25 | 2.079 | 52.81 | 2.179 | 55.35 | 1.852 | 47.04 | 1.535 | 38.99 | 1.512 | 38.40 | 1.462 | 37.13 |
| 37 | 2.724 | 69.19 | 2.824 | 71.73 | 2.500 | 63.50 | 2.183 | 55.45 | 2.158 | 54.81 | 2.114 | 53.70 |

D-subminiature All-Plastic IDC for Discrete Wire T* Series



Ordering Information

IDC All-Plastic Plugs

Plain Flange

| Positions | Mounting Holes | | 4-40 Threaded Bushings | |
|-----------|----------------|-------------|------------------------|-------------|
| | Gold Flash | 30µin. Gold | Gold Flash | 30µin. Gold |
| 9 | TE-9P | TE-9P-30 | TE-9PTB | TE-9PTB-30 |
| 15 | TA-15P | TA-15P-30 | TA-15PTB | TA-15PTB-30 |
| 25 | TB-25P | TB-25P-30 | TB-25PTB | TB-25PTB-30 |
| 37 | TC-37P | TC-37P-30 | TC-37PTB | TC-37PTB-30 |

Flange with Latch Block

| Positions | Mounting Holes | | 4-40 Threaded Bushings | |
|-----------|----------------|-------------|------------------------|---------------|
| | Gold Flash | 30µin. Gold | Gold Flash | 30µin. Gold |
| 9 | TE-9PLB | TE-9PLB-30 | TE-9PLB-1 | TE-9PLB-1-30 |
| 15 | TA-15PLB | TA-15PLB-30 | TA-15PLB-1 | TA-15PLB-1-30 |
| 25 | TB-25PLB | TB-25PLB-30 | TB-25PLB-1 | TB-25PLB-1-30 |
| 37 | TC-37PLB | TC-37PLB-30 | TC-37PLB-1 | TC-37PLB-1-30 |

IDC All-Plastic Sockets

Plain Flange

| Positions | Mounting Holes | | 4-40 Threaded Bushings | |
|-----------|----------------|-------------|------------------------|-------------|
| | Gold Flash | 30µin. Gold | Gold Flash | 30µin. Gold |
| 9 | TE-9S | TE-9S-30 | TE-9STB | TE-9STB-30 |
| 15 | TA-15S | TA-15S-30 | TA-15STB | TA-15STB-30 |
| 25 | TB-25S | TB-25S-30 | TB-25STB | TB-25STB-30 |
| 37 | TC-37S | TC-37S-30 | TC-37STB | TC-37STB-30 |

Flange with Latch Block

| Positions | Mounting Holes | | 4-40 Threaded Bushings | |
|-----------|----------------|-------------|------------------------|---------------|
| | Gold Flash | 30µin. Gold | Gold Flash | 30µin. Gold |
| 9 | TE-9SLB | TE-9SLB-30 | TE-9SLB-1 | TE-9SLB-1-30 |
| 15 | TA-15SLB | TA-15SLB-30 | TA-15SLB-1 | TA-15SLB-1-30 |
| 25 | TB-25SLB | TB-25SLB-30 | TB-25SLB-1 | TB-25SLB-1-30 |
| 37 | TC-37SLB | TC-37SLB-30 | TC-37SLB-1 | TC-37SLB-1-30 |

D-subminiature Metal Shell Solder Cup, Vertical PCB Mount, and Wire Wrap Basic D Series



FEATURES

- Offered in Wire Wrap and Solder Cup styles for wire termination and vertical style for PCB mount.
- Offered with .120 mounting holes, 4-40 clinch nuts, and dual float bushings.
- Offered in 9, 15, 25, 37, and 50 position plugs and sockets.
- Available with gold flash or 30µin. gold plating.
- Approvals:
 - UL Recognized - Files E170218 (UL1977) and E130965 (UL1863).
 - CSA Approved - File LR31996.
- See pages 4-5 thru 4-10 for standard dimensions, contact arrangements, and panel mounting specifications.

MATERIALS

Insulator Material: Glass-filled polyester (white), UL 94V-O rated
Connector Shell: Steel with zinc plating and yellow chromate finish or tin plating (grounding indents on plug)
4-40 Clinch Nut: Steel with cadmium plating and yellow chromate finish
Dual Float Bushing: Stainless steel, passivated

ENVIRONMENTAL

Operating Temperature: -85°C to + 125°C
Shock: 50G peak per MIL-STD-202, Method 213, Condition G
Vibration: 12 cycles in three perpendicular directions @ 10-2000Hz, per MIL-STD-202, Method 204, Condition D
Moisture Resistance: 90-95% relative humidity @ 40°C for 96 hours per MIL-STD-202, Method 103

ELECTRICAL

Withstanding Voltage: Minimum 1250V RMS @ sea level
Current Rating: 5 Amps
Contact Resistance: 2.7 milliohms maximum
Insulation Resistance: 5000 megohms maximum (initial); 1000 megohms (minimum) after environmental testing

MECHANICAL

Individual Contact Insertion and Separation Force (minimum/maximum): 0.7 oz./12 oz.
Durability: 500 mating cycles



D-subminiature Metal Shell Solder Cup Basic D Series



- Available with stamped or machined contacts.
- Will accommodate up to 20 AWG wire.

Materials

- Contact Material: Copper Alloy
- Contact Plating:
 - Stamped contacts with gold flash or 30µin. gold in mating area, gold flash or tin/lead on remainder. All over nickel.
 - Screw machine contacts with gold flash or 30µin. gold. All over nickel.

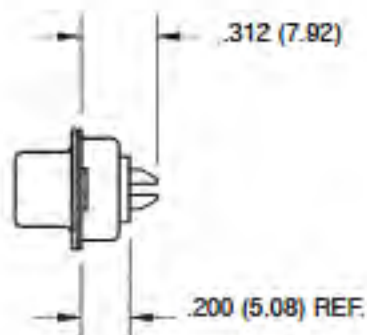

Ordering Information

Solder Cup Plugs

Zinc-Plated Shell with Yellow Chromate Finish

Stamped Contact with Gold Flash in Solder Cup

| Positions | Mounting Holes | | 4-40 Clinch Nuts | | Dual Float Bushings | |
|-----------|----------------|-------------|------------------|-------------|---------------------|-------------|
| | Gold Flash | 30µin. Gold | Gold Flash | 30µin. Gold | Gold Flash | 30µin. Gold |
| 9 | DE-9P | DE-9P-30 | DEE-9P | DEE-9P-30 | DEY-9P | DEY-9P-30 |
| 15 | DA-15P | DA-15P-30 | DAE-15P | DAE-15P-30 | DAY-15P | DAY-15P-30 |
| 25 | DB-25P | DB-25P-30 | DBE-25P | DBE-25P-30 | DBY-25P | DBY-25P-30 |
| 37 | DC-37P | DC-37P-30 | DCE-37P | DCE-37P-30 | DCY-37P | DCY-37P-30 |
| 50 | DD-50P | DD-50P-30 | DDE-50P | DDE-50P-30 | DDY-50P | DDY-50P-30 |

Stamped Contact with Tin/Lead in Solder Cup

| Positions | Mounting Holes | | 4-40 Clinch Nuts | | Dual Float Bushings | |
|-----------|----------------|--------------|------------------|---------------|---------------------|---------------|
| | Gold Flash | 30µin. Gold | Gold Flash | 30µin. Gold | Gold Flash | 30µin. Gold |
| 9 | DE-9P-II | DE-9P-II-30 | DEE-9P-II | DEE-9P-II-30 | DEY-9P-II | DEY-9P-II-30 |
| 15 | DA-15P-II | DA-15P-II-30 | DAE-15P-II | DAE-15P-II-30 | DAY-15P-II | DAY-15P-II-30 |
| 25 | DB-25P-II | DB-25P-II-30 | DBE-25P-II | DBE-25P-II-30 | DBY-25P-II | DBY-25P-II-30 |
| 37 | DC-37P-II | DC-37P-II-30 | DCE-37P-II | DCE-37P-II-30 | DCY-37P-II | DCY-37P-II-30 |
| 50 | DD-50P-II | DD-50P-II-30 | DDE-50P-II | DDE-50P-II-30 | DDY-50P-II | DDY-50P-II-30 |

Screw Machine Contact

| Positions | Mounting Holes | | 4-40 Clinch Nuts | | Dual Float Bushings | |
|-----------|----------------|--------------|------------------|---------------|---------------------|---------------|
| | Gold Flash | 30µin. Gold | Gold Flash | 30µin. Gold | Gold Flash | 30µin. Gold |
| 9 | DE-9P-SM | DE-9P-SM-30 | DEE-9P-SM | DEE-9P-SM-30 | DEY-9P-SM | DEY-9P-SM-30 |
| 15 | DA-15P-SM | DA-15P-SM-30 | DAE-15P-SM | DAE-15P-SM-30 | DAY-15P-SM | DAY-15P-SM-30 |
| 25 | DB-25P-SM | DB-25P-SM-30 | DBE-25P-SM | DBE-25P-SM-30 | DBY-25P-SM | DBY-25P-SM-30 |
| 37 | DC-37P-SM | DC-37P-SM-30 | DCE-37P-SM | DCE-37P-SM-30 | DCY-37P-SM | DCY-37P-SM-30 |
| 50 | DD-50P-SM | DD-50P-SM-30 | DDE-50P-SM | DDE-50P-SM-30 | DDY-50P-SM | DDY-50P-SM-30 |

D-subminiature Metal Shell Solder Cup Basic D Series



Ordering Information

Solder Cup Plugs (Cont'd)

Tin-Plated Shell with Grounding Indents

Stamped Contact with Gold Flash in Solder Cup

| Positions | Mounting Holes | | 4-40 Clinch Nuts | | Dual Float Bushings | |
|-----------|----------------|-------------|------------------|--------------|---------------------|--------------|
| | Gold Flash | 30µin. Gold | Gold Flash | 30µin. Gold | Gold Flash | 30µin. Gold |
| 9 | DE-9PTI | DE-9PTI-30 | DEE-9PTI | DEE-9PTI-30 | DEY-9PTI | DEY-9PTI-30 |
| 15 | DA-15PTI | DA-15PTI-30 | DAE-15PTI | DAE-15PTI-30 | DAY-15PTI | DAY-15PTI-30 |
| 25 | DB-25PTI | DB-25PTI-30 | DBE-25PTI | DBE-25PTI-30 | DBY-25PTI | DBY-25PTI-30 |
| 37 | DC-37PTI | DC-37PTI-30 | DCE-37PTI | DCE-37PTI-30 | DCY-37PTI | DCY-37PTI-30 |
| 50 | DD-50PTI | DD-50PTI-30 | DDE-50PTI | DDE-50PTI-30 | DDY-50PTI | DDY-50PTI-30 |

Stamped Contact with Tin/Lead in Solder Cup

| Positions | Mounting Holes | | 4-40 Clinch Nuts | | Dual Float Bushings | |
|-----------|----------------|----------------|------------------|-----------------|---------------------|-----------------|
| | Gold Flash | 30µin. Gold | Gold Flash | 30µin. Gold | Gold Flash | 30µin. Gold |
| 9 | DE-9PTI-II | DE-9PTI-II-30 | DEE-9PTI-II | DEE-9PTI-II-30 | DEY-9PTI-II | DEY-9PTI-II-30 |
| 15 | DA-15PTI-II | DA-15PTI-II-30 | DAE-15PTI-II | DAE-15PTI-II-30 | DAY-15PTI-II | DAY-15PTI-II-30 |
| 25 | DB-25PTI-II | DB-25PTI-II-30 | DBE-25PTI-II | DBE-25PTI-II-30 | DBY-25PTI-II | DBY-25PTI-II-30 |
| 37 | DC-37PTI-II | DC-37PTI-II-30 | DCE-37PTI-II | DCE-37PTI-II-30 | DCY-37PTI-II | DCY-37PTI-II-30 |
| 50 | DD-50PTI-II | DD-50PTI-II-30 | DDE-50PTI-II | DDE-50PTI-II-30 | DDY-50PTI-II | DDY-50PTI-II-30 |

Screw Machine Contact

| Positions | Mounting Holes | | 4-40 Clinch Nuts | | Dual Float Bushings | |
|-----------|----------------|----------------|------------------|-----------------|---------------------|-----------------|
| | Gold Flash | 30µin. Gold | Gold Flash | 30µin. Gold | Gold Flash | 30µin. Gold |
| 9 | DE-9PTI-SM | DE-9PTI-SM-30 | DEE-9PTI-SM | DEE-9PTI-SM-30 | DEY-9PTI-SM | DEY-9PTI-SM-30 |
| 15 | DA-15PTI-SM | DA-15PTI-SM-30 | DAE-15PTI-SM | DAE-15PTI-SM-30 | DAY-15PTI-SM | DAY-15PTI-SM-30 |
| 25 | DB-25PTI-SM | DB-25PTI-SM-30 | DBE-25PTI-SM | DBE-25PTI-SM-30 | DBY-25PTI-SM | DBY-25PTI-SM-30 |
| 37 | DC-37PTI-SM | DC-37PTI-SM-30 | DCE-37PTI-SM | DCE-37PTI-SM-30 | DCY-37PTI-SM | DCY-37PTI-SM-30 |
| 50 | DD-50PTI-SM | DD-50PTI-SM-30 | DDE-50PTI-SM | DDE-50PTI-SM-30 | DDY-50PTI-SM | DDY-50PTI-SM-30 |

D-subminiature Metal Shell Solder Cup Basic D Series



Ordering Information

Solder Cup Sockets

Zinc-Plated Shell with Yellow Chromate Finish

Stamped Contact with Gold Flash in Solder Cup

| Positions | Mounting Holes | | 4-40 Clinch Nuts | | Dual Float Bushings | |
|-----------|----------------|-------------|------------------|-------------|---------------------|-------------|
| | Gold Flash | 30µin. Gold | Gold Flash | 30µin. Gold | Gold Flash | 30µin. Gold |
| 9 | DE-9S | DE-9S-30 | DEE-9S | DEE-9S-30 | DEY-9S | DEY-9S-30 |
| 15 | DA-15S | DA-15S-30 | DAE-15S | DAE-15S-30 | DAY-15S | DAY-15S-30 |
| 25 | DB-25S | DB-25S-30 | DBE-25S | DBE-25S-30 | DBY-25S | DBY-25S-30 |
| 37 | DC-37S | DC-37S-30 | DCE-37S | DCE-37S-30 | DCY-37S | DCY-37S-30 |
| 50 | DD-50S | DD-50S-30 | DDE-50S | DDE-50S-30 | DDY-50S | DDY-50S-30 |

Stamped Contact Tin/Lead in Solder Cup

| Positions | Mounting Holes | | 4-40 Clinch Nuts | | Dual Float Bushings | |
|-----------|----------------|--------------|------------------|---------------|---------------------|---------------|
| | Gold Flash | 30µin. Gold | Gold Flash | 30µin. Gold | Gold Flash | 30µin. Gold |
| 9 | DE-9S-II | DE-9S-II-30 | DEE-9S-II | DEE-9S-II-30 | DEY-9S-II | DEY-9S-II-30 |
| 15 | DA-15S-II | DA-15S-II-30 | DAE-15S-II | DAE-15S-II-30 | DAY-15S-II | DAY-15S-II-30 |
| 25 | DB-25S-II | DB-25S-II-30 | DBE-25S-II | DBE-25S-II-30 | DBY-25S-II | DBY-25S-II-30 |
| 37 | DC-37S-II | DC-37S-II-30 | DCE-37S-II | DCE-37S-II-30 | DCY-37S-II | DCY-37S-II-30 |
| 50 | DD-50S-II | DD-50S-II-30 | DDE-50S-II | DDE-50S-II-30 | DDY-50S-II | DDY-50S-II-30 |

Screw Machine Contact

| Positions | Mounting Holes | | 4-40 Clinch Nuts | | Dual Float Bushings | |
|-----------|----------------|--------------|------------------|---------------|---------------------|---------------|
| | Gold Flash | 30µin. Gold | Gold Flash | 30µin. Gold | Gold Flash | 30µin. Gold |
| 9 | DE-9S-SM | DE-9S-SM-30 | DEE-9S-SM | DEE-9S-SM-30 | DEY-9S-SM | DEY-9S-SM-30 |
| 15 | DA-15S-SM | DA-15S-SM-30 | DAE-15S-SM | DAE-15S-SM-30 | DAY-15S-SM | DAY-15S-SM-30 |
| 25 | DB-25S-SM | DB-25S-SM-30 | DBE-25S-SM | DBE-25S-SM-30 | DBY-25S-SM | DBY-25S-SM-30 |
| 37 | DC-37S-SM | DC-37S-SM-30 | DCE-37S-SM | DCE-37S-SM-30 | DCY-37S-SM | DCY-37S-SM-30 |
| 50 | DD-50S-SM | DD-50S-SM-30 | DDE-50S-SM | DDE-50S-SM-30 | DDY-50S-SM | DDY-50S-SM-30 |

Tin-Plated Shell

Stamped Contact with Gold Flash in Solder Cup

| Positions | Mounting Holes | | 4-40 Clinch Nuts | | Dual Float Bushings | |
|-----------|----------------|-------------|------------------|-------------|---------------------|-------------|
| | Gold Flash | 30µin. Gold | Gold Flash | 30µin. Gold | Gold Flash | 30µin. Gold |
| 9 | DE-9ST | DE-9ST-30 | DEE-9ST | DEE-9ST-30 | DEY-9ST | DEY-9ST-30 |
| 15 | DA-15ST | DA-15ST-30 | DAE-15ST | DAE-15ST-30 | DAY-15ST | DAY-15ST-30 |
| 25 | DB-25ST | DB-25ST-30 | DBE-25ST | DBE-25ST-30 | DBY-25ST | DBY-25ST-30 |
| 37 | DC-37ST | DC-37ST-30 | DCE-37ST | DCE-37ST-30 | DCY-37ST | DCY-37ST-30 |
| 50 | DD-50ST | DD-50ST-30 | DDE-50ST | DDE-50ST-30 | DDY-50ST | DDY-50ST-30 |

Stamped Contact with Tin/Lead in Solder Cup

| Positions | Mounting Holes | | 4-40 Clinch Nuts | | Dual Float Bushings | |
|-----------|----------------|---------------|------------------|----------------|---------------------|----------------|
| | Gold Flash | 30µin. Gold | Gold Flash | 30µin. Gold | Gold Flash | 30µin. Gold |
| 9 | DE-9ST-II | DE-9ST-II-30 | DEE-9ST-II | DEE-9ST-II-30 | DEY-9ST-II | DEY-9ST-II-30 |
| 15 | DA-15ST-II | DA-15ST-II-30 | DAE-15ST-II | DAE-15ST-II-30 | DAY-15ST-II | DAY-15ST-II-30 |
| 25 | DB-25ST-II | DB-25ST-II-30 | DBE-25ST-II | DBE-25ST-II-30 | DBY-25ST-II | DBY-25ST-II-30 |
| 37 | DC-37ST-II | DC-37ST-II-30 | DCE-37ST-II | DCE-37ST-II-30 | DCY-37ST-II | DCY-37ST-II-30 |
| 50 | DD-50ST-II | DD-50ST-II-30 | DDE-50ST-II | DDE-50ST-II-30 | DDY-50ST-II | DDY-50ST-II-30 |

Screw Machine Contact

| Positions | Mounting Holes | | 4-40 Clinch Nuts | | Dual Float Bushings | |
|-----------|----------------|---------------|------------------|----------------|---------------------|----------------|
| | Gold Flash | 30µin. Gold | Gold Flash | 30µin. Gold | Gold Flash | 30µin. Gold |
| 9 | DE-9ST-SM | DE-9ST-SM-30 | DEE-9ST-SM | DEE-9ST-SM-30 | DEY-9ST-SM | DEY-9ST-SM-30 |
| 15 | DA-15ST-SM | DA-15ST-SM-30 | DAE-15ST-SM | DAE-15ST-SM-30 | DAY-15ST-SM | DAY-15ST-SM-30 |
| 25 | DB-25ST-SM | DB-25ST-SM-30 | DBE-25ST-SM | DBE-25ST-SM-30 | DBY-25ST-SM | DBY-25ST-SM-30 |
| 37 | DC-37ST-SM | DC-37ST-SM-30 | DCE-37ST-SM | DCE-37ST-SM-30 | DCY-37ST-SM | DCY-37ST-SM-30 |
| 50 | DD-50ST-SM | DD-50ST-SM-30 | DDE-50ST-SM | DDE-50ST-SM-30 | DDY-50ST-SM | DDY-50ST-SM-30 |

D-subminiature Metal Shell Vertical Dip Solder PCB Basic D Series



- .040" contact diameter.
- Short rear insulator provides low profile on PCB.
- Offered with .120 mounting holes, dual float bushings, or optional 4-40 clinch nuts.

Materials

- Contact Material: Socket - Phosphor bronze (machined), Plug - Brass (machined).
- Contact Plating: Gold flash or 30µin. gold over nickel.

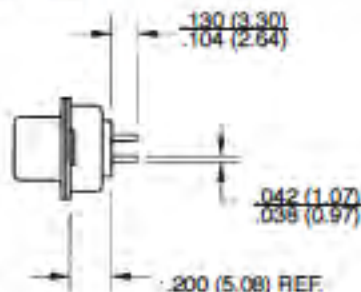

Ordering Information

Vertical PCB Plugs

Zinc-Plated Shell with Yellow Chromate Finish

| Positions | Mounting Holes | | 4-40 Clinch Nuts | | Dual Float Bushings | |
|-----------|----------------|-------------|------------------|-------------|---------------------|-------------|
| | Gold Flash | 30µin. Gold | Gold Flash | 30µin. Gold | Gold Flash | 30µin. Gold |
| 9 | DE-9PV | DE-9PV-30 | DEE-9PV | DEE-9PV-30 | DEY-9PV | DEY-9PV-30 |
| 15 | DA-15PV | DA-15PV-30 | DAE-15PV | DAE-15PV-30 | DAY-15PV | DAY-15PV-30 |
| 25 | DB-25PV | DB-25PV-30 | DBE-25PV | DBE-25PV-30 | DBY-25PV | DBY-25PV-30 |
| 37 | DC-37PV | DC-37PV-30 | DCE-37PV | DCE-37PV-30 | DCY-37PV | DCY-37PV-30 |
| 50 | DD-50PV | DD-50PV-30 | DDE-50PV | DDE-50PV-30 | DCY-50PV | DDY-50PV-30 |

Tin-Plated Shell with Grounding Indents

| Positions | Mounting Holes | | 4-40 Clinch Nuts | | Dual Float Bushings | |
|-----------|----------------|--------------|------------------|---------------|---------------------|---------------|
| | Gold Flash | 30µin. Gold | Gold Flash | 30µin. Gold | Gold Flash | 30µin. Gold |
| 9 | DE-9PVTI | DE-9PVTI-30 | DEE-9PVTI | DEE-9PVTI-30 | DEY-9PVTI | DEY-9PVTI-30 |
| 15 | DA-15PVTI | DA-15PVTI-30 | DAE-15PVTI | DAE-15PVTI-30 | DAY-15PVTI | DAY-15PVTI-30 |
| 25 | DB-25PVTI | DB-25PVTI-30 | DBE-25PVTI | DBE-25PVTI-30 | DBY-25PVTI | DBY-25PVTI-30 |
| 37 | DC-37PVTI | DC-37PVTI-30 | DCE-37PVTI | DCE-37PVTI-30 | DCY-37PVTI | DCY-37PVTI-30 |
| 50 | DD-50PVTI | DD-50PVTI-30 | DDE-50PVTI | DDE-50PVTI-30 | DCY-50PVTI | DDY-50PVTI-30 |

Vertical PCB Sockets

Zinc-Plated Shell with Yellow Chromate Finish

| Positions | Mounting Holes | | 4-40 Clinch Nuts | | Dual Float Bushings | |
|-----------|----------------|-------------|------------------|-------------|---------------------|-------------|
| | Gold Flash | 30µin. Gold | Gold Flash | 30µin. Gold | Gold Flash | 30µin. Gold |
| 9 | DE-9SV | DE-9SV-30 | DEE-9SV | DEE-9SV-30 | DEY-9SV | DEY-9SV-30 |
| 15 | DA-15SV | DA-15SV-30 | DAE-15SV | DAE-15SV-30 | DAY-15SV | DAY-15SV-30 |
| 25 | DB-25SV | DB-25SV-30 | DBE-25SV | DBE-25SV-30 | DBY-25SV | DBY-25SV-30 |
| 37 | DC-37SV | DC-37SV-30 | DCE-37SV | DCE-37SV-30 | DCY-37SV | DCY-37SV-30 |
| 50 | DD-50SV | DD-50SV-30 | DDE-50SV | DDE-50SV-30 | DCY-50SV | DDY-50SV-30 |

Tin-Plated Shell

| Positions | Mounting Holes | | 4-40 Clinch Nuts | | Dual Float Bushings | |
|-----------|----------------|-------------|------------------|--------------|---------------------|--------------|
| | Gold Flash | 30µin. Gold | Gold Flash | 30µin. Gold | Gold Flash | 30µin. Gold |
| 9 | DE-9SVT | DE-9SVT-30 | DEE-9SVT | DEE-9SVT-30 | DEY-9SVT | DEY-9SVT-30 |
| 15 | DA-15SVT | DA-15SVT-30 | DAE-15SVT | DAE-15SVT-30 | DAY-15SVT | DAY-15SVT-30 |
| 25 | DB-25SVT | DB-25SVT-30 | DBE-25SVT | DBE-25SVT-30 | DBY-25SVT | DBY-25SVT-30 |
| 37 | DC-37SVT | DC-37SVT-30 | DCE-37SVT | DCE-37SVT-30 | DCY-37SVT | DCY-37SVT-30 |
| 50 | DD-50SVT | DD-50SVT-30 | DDE-50SVT | DDE-50SVT-30 | DDY-50SVT | DDY-50SVT-30 |

4

D-subminiature Metal Shell Wire Wrap Basic D Series



- Reliable wire wrap termination.
- Two contact lengths: .375" or .585"
- .025" square contact tails.

Materials

- Contact Material: Copper alloy (machined).
- Contact Plating: Gold flash or 30µin. gold. All over nickel.

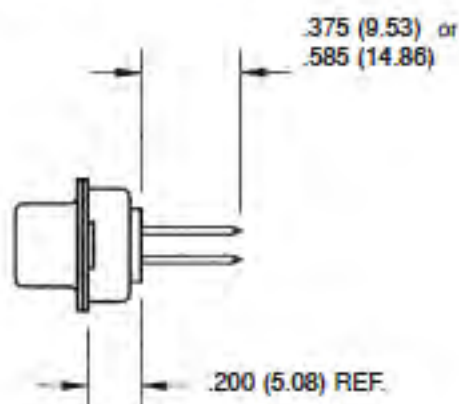

Ordering Information

Wire Wrap Plugs

.375" Tail Length

Zinc-Plated Shell with Yellow Chromate Finish

| Positions | Mounting Holes | | 4-40 Clinch Nuts | | Dual Float Bushings | |
|-----------|----------------|----------------|------------------|-----------------|---------------------|-----------------|
| | Gold Flash | 30µin. Gold | Gold Flash | 30µin. Gold | Gold Flash | 30µin. Gold |
| 9 | DE-9P-F179 | DE-9P-F179-30 | DEE-9P-F179 | DEE-9P-F179-30 | DEY-9P-F179 | DEY-9P-F179-30 |
| 15 | DA-15P-F179 | DA-15P-F179-30 | DAE-15P-F179 | DAE-15P-F179-30 | DAY-15P-F179 | DAY-15P-F179-30 |
| 25 | DB-25P-F179 | DB-25P-F179-30 | DBE-25P-F179 | DBE-25P-F179-30 | DBY-25P-F179 | DBY-25P-F179-30 |
| 37 | DC-37P-F179 | DC-37P-F179-30 | DCE-37P-F179 | DCE-37P-F179-30 | DCY-37P-F179 | DCY-37P-F179-30 |
| 50 | DD-50P-F179 | DD-50P-F179-30 | DDE-50P-F179 | DDE-50P-F179-30 | DDY-50P-F179 | DDY-50P-F179-30 |

Tin-Plated Shell with Grounding Indents

| Positions | Mounting Holes | | 4-40 Clinch Nuts | | Dual Float Bushings | |
|-----------|----------------|------------------|------------------|-------------------|---------------------|-------------------|
| | Gold Flash | 30µin. Gold | Gold Flash | 30µin. Gold | Gold Flash | 30µin. Gold |
| 9 | DE-9PTI-F179 | DE-9PTI-F179-30 | DEE-9PTI-F179 | DEE-9PTI-F179-30 | DEY-9PTI-F179 | DEY-9PTI-F179-30 |
| 15 | DA-15PTI-F179 | DA-15PTI-F179-30 | DAE-15PTI-F179 | DAE-15PTI-F179-30 | DAY-15PTI-F179 | DAY-15PTI-F179-30 |
| 25 | DB-25PTI-F179 | DB-25PTI-F179-30 | DBE-25PTI-F179 | DBE-25PTI-F179-30 | DBY-25PTI-F179 | DBY-25PTI-F179-30 |
| 37 | DC-37PTI-F179 | DC-37PTI-F179-30 | DCE-37PTI-F179 | DCE-37PTI-F179-30 | DCY-37PTI-F179 | DCY-37PTI-F179-30 |
| 50 | DD-50PTI-F179 | DD-50PTI-F179-30 | DDE-50PTI-F179 | DDE-50PTI-F179-30 | DDY-50PTI-F179 | DDY-50PTI-F179-30 |

D-subminiature Metal Shell Wire Wrap Basic D Series



Ordering Information

Wire Wrap Plugs (Cont'd)

.585" Tail Length

Zinc-Plated Shell with Yellow Chromate Finish

| Positions | Mounting Holes | | 4-40 Clinch Nuts | | Dual Float Bushings | |
|-----------|----------------|-----------------|------------------|------------------|---------------------|------------------|
| | Gold Flash | 30µin. Gold | Gold Flash | 30µin. Gold | Gold Flash | 30µin. Gold |
| 9 | DE-9P-F179C | DE-9P-F179C-30 | DEE-9P-F179C | DEE-9PF-179C-30 | DEY-9P-F179C | DEY-9P-F179C-30 |
| 15 | DA-15P-F179C | DA-15P-F179C-30 | DAE-15P-F179C | DAE-15PF-179C-30 | DAY-15P-F179C | DAY-15P-F179C-30 |
| 25 | DB-25P-F179C | DB-25P-F179C-30 | DBE-25P-F179C | DBE-25PF-179C-30 | DBY-25P-F179C | DBY-25P-F179C-30 |
| 37 | DC-37P-F179C | DC-37P-F179C-30 | DCE-37P-F179C | DCE-37PF-179C-30 | DCY-37P-F179C | DCY-37P-F179C-30 |
| 50 | DD-50P-F179C | DD-50P-F179C-30 | DDE-50P-F179C | DDE-50PF-179C-30 | DDY-50P-F179C | DDY-50P-F179C-30 |

Tin-Plated Shell with Grounding Indents

| Positions | Mounting Holes | | 4-40 Clinch Nuts | | Dual Float Bushings | |
|-----------|----------------|-------------------|------------------|--------------------|---------------------|--------------------|
| | Gold Flash | 30µin. Gold | Gold Flash | 30µin. Gold | Gold Flash | 30µin. Gold |
| 9 | DE-9PTI-F179C | DE-9PTI-F179C-30 | DEE-9PTI-F179C | DEE-9PTI-F179C-30 | DEY-9PTI-F179C | DEY-9PTI-F179C-30 |
| 15 | DA-15PTI-F179C | DA-15PTI-F179C-30 | DAE-15PTI-F179C | DAE-15PTI-F179C-30 | DAY-15PTI-F179C | DAY-15PTI-F179C-30 |
| 25 | DB-25PTI-F179C | DB-25PTI-F179C-30 | DBE-25PTI-F179C | DBE-25PTI-F179C-30 | DBY-25PTI-F179C | DBY-25PTI-F179C-30 |
| 37 | DC-37PTI-F179C | DC-37PTI-F179C-30 | DCE-37PTI-F179C | DCE-37PTI-F179C-30 | DCY-37PTI-F179C | DCY-37PTI-F179C-30 |
| 50 | DD-50PTI-F179C | DD-50PTI-F179C-30 | DDE-50PTI-F179C | DDE-50PTI-F179C-30 | DDY-50PTI-F179C | DDY-50PTI-F179C-30 |

4

D-subminiature Metal Shell Wire Wrap Basic D Series



Ordering Information

Wire Wrap Sockets

.375" Tail Length

Zinc-Plated Shell with Yellow Chromate Finish

| Positions | Mounting Holes | | 4-40 Clinch Nuts | | Dual Float Bushings | |
|-----------|----------------|----------------|------------------|-----------------|---------------------|-----------------|
| | Gold Flash | 30µin. Gold | Gold Flash | 30µin. Gold | Gold Flash | 30µin. Gold |
| 9 | DE-9S-F179 | DE-9S-F179-30 | DEE-9S-F179 | DEE-9S-F179-30 | DEY-9S-F179 | DEY-9S-F179-30 |
| 15 | DA-15S-F179 | DA-15S-F179-30 | DAE-15S-F179 | DAE-15S-F179-30 | DAY-15S-F179 | DAY-15S-F179-30 |
| 25 | DB-25S-F179 | DB-25S-F179-30 | DBE-25S-F179 | DBE-25S-F179-30 | DBY-25S-F179 | DBY-25S-F179-30 |
| 37 | DC-37S-F179 | DC-37S-F179-30 | DCE-37S-F179 | DCE-37S-F179-30 | DCY-37S-F179 | DCY-37S-F179-30 |
| 50 | DD-50S-F179 | DD-50S-F179-30 | DDE-50S-F179 | DDE-50S-F179-30 | DDY-50S-F179 | DDY-50S-F179-30 |

Tin-Plated Shell

| Positions | Mounting Holes | | 4-40 Clinch Nuts | | Dual Float Bushings | |
|-----------|----------------|-----------------|------------------|------------------|---------------------|------------------|
| | Gold Flash | 30µin. Gold | Gold Flash | 30µin. Gold | Gold Flash | 30µin. Gold |
| 9 | DE-9ST-F179 | DE-9ST-F179-30 | DEE-9ST-F179 | DEE-9ST-F179-30 | DEY-9ST-F179 | DEY-9ST-F179-30 |
| 15 | DA-15ST-F179 | DA-15ST-F179-30 | DAE-15ST-F179 | DAE-15ST-F179-30 | DAY-15ST-F179 | DAY-15ST-F179-30 |
| 25 | DB-25ST-F179 | DB-25ST-F179-30 | DBE-25ST-F179 | DBE-25ST-F179-30 | DBY-25ST-F179 | DBY-25ST-F179-30 |
| 37 | DC-37ST-F179 | DC-37ST-F179-30 | DCE-37ST-F179 | DCE-37ST-F179-30 | DCY-37ST-F179 | DCY-37ST-F179-30 |
| 50 | DD-50ST-F179 | DD-50ST-F179-30 | DDE-50ST-F179 | DDE-50ST-F179-30 | DDY-50ST-F179 | DDY-50ST-F179-30 |

.585" Tail Length

Zinc-Plated Shell with Yellow Chromate Finish

| Positions | Mounting Holes | | 4-40 Clinch Nuts | | Dual Float Bushings | |
|-----------|----------------|-----------------|------------------|------------------|---------------------|------------------|
| | Gold Flash | 30µin. Gold | Gold Flash | 30µin. Gold | Gold Flash | 30µin. Gold |
| 9 | DE-9S-F179C | DE-9S-F179C-30 | DEE-9S-F179C | DEE-9S-F179C-30 | DEY-9S-F179C | DEY-9S-F179C-30 |
| 15 | DA-15S-F179C | DA-15S-F179C-30 | DAE-15S-F179C | DAE-15S-F179C-30 | DAY-15S-F179C | DAY-15S-F179C-30 |
| 25 | DB-25S-F179C | DB-25S-F179C-30 | DBE-25S-F179C | DBE-25S-F179C-30 | DBY-25S-F179C | DBY-25S-F179C-30 |
| 37 | DC-37S-F179C | DC-37S-F179C-30 | DCE-37S-F179C | DCE-37S-F179C-30 | DCY-37S-F179C | DCY-37S-F179C-30 |
| 50 | DD-50S-F179C | DD-50S-F179C-30 | DDE-50S-F179C | DDE-50S-F179C-30 | DDY-50S-F179C | DDY-50S-F179C-30 |

Tin-Plated Shell

| Positions | Mounting Holes | | 4-40 Clinch Nuts | | Dual Float Bushings | |
|-----------|----------------|------------------|------------------|-------------------|---------------------|-------------------|
| | Gold Flash | 30µin. Gold | Gold Flash | 30µin. Gold | Gold Flash | 30µin. Gold |
| 9 | DE-9ST-F179C | DE-9ST-F179C-30 | DEE-9ST-F179C | DEE-9ST-F179C-30 | DEY-9ST-F179C | DEY-9ST-F179C-30 |
| 15 | DA-15ST-F179C | DA-15ST-F179C-30 | DAE-15ST-F179C | DAE-15ST-F179C-30 | DAY-15ST-F179C | DAY-15ST-F179C-30 |
| 25 | DB-25ST-F179C | DB-25ST-F179C-30 | DBE-25ST-F179C | DBE-25ST-F179C-30 | DBY-25ST-F179C | DBY-25ST-F179C-30 |
| 37 | DC-37ST-F179C | DC-37ST-F179C-30 | DCE-37ST-F179C | DCE-37ST-F179C-30 | DCY-37ST-F179C | DCY-37ST-F179C-30 |
| 50 | DD-50ST-F179C | DD-50ST-F179C-30 | DDE-50ST-F179C | DDE-50ST-F179C-30 | DDY-50ST-F179C | DDY-50ST-F179C-30 |

D-subminiature Metal Shell Solder Cup, Right-Angle, and Vertical PCB Series 1 - High Reliability



FEATURES

- Available in vertical and right-angle dip solder PCB connectors and solder cup version for wire termination.
- Commercial version of M24308 military connectors with tin-plated or zinc-plated shell and 30µin. gold plating.
- Monoblock green diallyl phthalate insulator for improved electrical performance.
- Machined contacts for precision performance.
- Offered in 9, 15, 25, 37, and 50 (except right-angle version) position plugs and sockets.
- Offered with .120 mounting holes, 4-40 clinch nuts (except right-angle version), or dual float bushings (except right-angle version).
- Approvals:
 - UL Recognized - Files E170218 (UL1977) and E130965 (UL1863).
 - CSA Approved - File LR31996.
- See pages 4-5 thru 4-10 for standard dimensions, contact arrangements, and panel mounting specifications.

MATERIALS

Insulator Material: Glass-filled diallyl phthalate (green)
UL 94V-0 rated

Connector Shell: Steel with zinc plating and yellow chromate finish or tin plating (grounding indents on plug)

Contact Material: Plug - Brass (machined), Socket - Phosphor bronze (machined)

Contact Plating: 30µin. gold over nickel

4-40 Clinch Nut: Steel with cadmium plating and yellow chromate finish

Dual Float Bushing: Stainless steel, passivated



ENVIRONMENTAL

Operating Temperature: -85°C to + 125°C

Shock: 50G peak per MIL-STD-202, Method 213, Condition G

Vibration: 12 cycles in three perpendicular directions @ 10-2000Hz, per MIL-STD-202, Method 204, Condition D

Moisture Resistance: 90-95% relative humidity @ 40°C for 96 hours per MIL-STD-202, Method 103



ELECTRICAL

Withstanding Voltage: Minimum 1250V RMS @ sea level

Current Rating: 5 Ampe

Contact Resistance: 2.7 milliohms maximum

Insulation Resistance: 5000 megohms maximum (initial);
1000 megohms (minimum) after environmental testing



MECHANICAL

Individual Contact Insertion and Separation Force (minimum/maximum): 0.7 oz./12 oz.

Durability: 500 mating cycles



D-subminiature Metal Shell Solder Cup Series 1 - High Reliability



- Will accommodate up to 20 AWG wire.

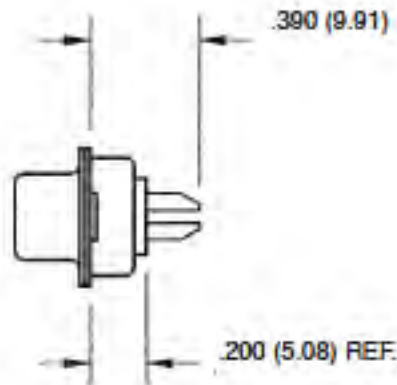

Ordering Information

Solder Cup Plugs

| Positions | Zinc-Plated Shell with Yellow Chromate Finish | | | Tin-Plated Shell with Grounding Indents | | |
|-----------|---|-----------------|---------------------|---|-----------------|---------------------|
| | Mounting Hole | 4-40 Clinch Nut | Dual Float Bushings | Mounting Hole | 4-40 Clinch Nut | Dual Float Bushings |
| 9 | DEM-9P | DEME-9P | DEMY-9P | DEM-9PTI | DEME-9PTI | DEMY-9PTI |
| 15 | DAM-15P | DAME-15P | DAMY-15P | DAM-15PTI | DAME-15PTI | DAMY-15PTI |
| 25 | DBM-25P | DBME-25P | DBMY-25P | DBM-25PTI | DBME-25PTI | DBMY-25PTI |
| 37 | DCM-37P | DCME-37P | DCMY-37P | DCM-37PTI | DCME-37PTI | DCMY-37PTI |
| 50 | DDM-50P | DDME-50P | DDMY-50P | DDM-50PTI | DDME-50PTI | DDMY-50PTI |

Solder Cup Sockets

| Positions | Zinc-Plated Shell with Yellow Chromate Finish | | | Tin-Plated Shell | | |
|-----------|---|-----------------|---------------------|------------------|-----------------|---------------------|
| | Mounting Hole | 4-40 Clinch Nut | Dual Float Bushings | Mounting Hole | 4-40 Clinch Nut | Dual Float Bushings |
| 9 | DEM-9S | DEME-9S | DEMY-9S | DEM-9ST | DEME-9ST | DEMY-9ST |
| 15 | DAM-15S | DAME-15S | DAMY-15S | DAM-15ST | DAME-15ST | DAMY-15ST |
| 25 | DBM-25S | DBME-25S | DBMY-25S | DBM-25ST | DBME-25ST | DBMY-25ST |
| 37 | DCM-37S | DCME-37S | DCMY-37S | DCM-37ST | DCME-37ST | DCMY-37ST |
| 50 | DDM-50S | DDME-50S | DDMY-50S | DDM-50ST | DDME-50ST | DDMY-50ST |

D-subminiature Metal Shell Right-Angle Dip Solder PCB Series 1 - High Reliability



- .283" footprint uses minimal board space.
- Available with three contact tail lengths (.125", .158", and .185") and two contact diameters (.030" and .040").

Materials

- Mounting bracket: Black nylon. Can be removed if necessary.

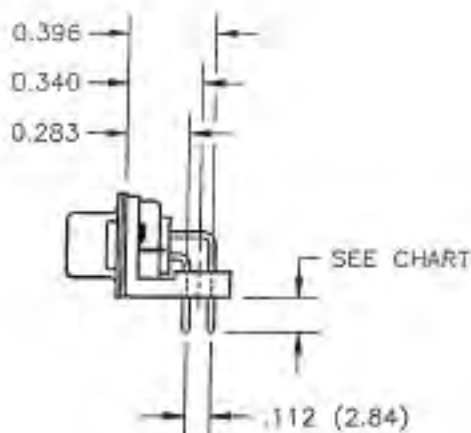

4

Ordering Information

Right-Angle PCB Plugs

Zinc-Plated Shell with Yellow Chromate Finish

| Positions | .125 Tail Length | .158 Tail Length | .185 Tail Length | .125 Tail Length | .158 Tail Length | .185 Tail Length |
|-----------|-----------------------|-----------------------|-----------------------|-----------------------|-----------------------|-----------------------|
| | .030 Contact Diameter | .030 Contact Diameter | .030 Contact Diameter | .040 Contact Diameter | .040 Contact Diameter | .040 Contact Diameter |
| 9 | DEM-9PD | DEM-9PL | DEM-9PS | DEM-9PA | DEM-9PG | DEM-9PW |
| 15 | DAM-15PD | DAM-15PL | DAM-15PS | DAM-15PA | DAM-15PG | DAM-15PW |
| 25 | DBM-25PD | DBM-25PL | DBM-25PS | DBM-25PA | DBM-25PG | DBM-25PW |
| 37 | DCM-37PD | DCM-37PL | DCM-37PS | DCM-37PA | DCM-37PG | DCM-37PW |

Tin-Plated Shell with Grounding Indents

| Positions | .125 Tail Length | .158 Tail Length | .185 Tail Length | .125 Tail Length | .158 Tail Length | .185 Tail Length |
|-----------|-----------------------|-----------------------|-----------------------|-----------------------|-----------------------|-----------------------|
| | .030 Contact Diameter | .030 Contact Diameter | .030 Contact Diameter | .040 Contact Diameter | .040 Contact Diameter | .040 Contact Diameter |
| 9 | DEM-9PDTI | DEM-9PLTI | DEM-9PSTI | DEM-9PATI | DEM-9PGTI | DEM-9PWTI |
| 15 | DAM-15PDTI | DAM-15PLTI | DAM-15PSTI | DAM-15PATI | DAM-15PGTI | DAM-15PWTI |
| 25 | DBM-25PDTI | DBM-25PLTI | DBM-25PSTI | DBM-25PATI | DBM-25PGTI | DBM-25PWTI |
| 37 | DCM-37PDTI | DCM-37PLTI | DCM-37PSTI | DCM-37PATI | DCM-37PGTI | DCM-37PWTI |

D-subminiature Metal Shell Right-Angle Dip Solder PCB Series 1 - High Reliability



Ordering Information

Right-Angle PCB Sockets

Zinc-Plated Shell with Yellow Chromate Finish

| Positions | .125 Tail Length | .158 Tail Length | .185 Tail Length | .125 Tail Length | .158 Tail Length | .185 Tail Length |
|-----------|--------------------------|--------------------------|--------------------------|--------------------------|--------------------------|--------------------------|
| | .030 Contact Diameter | .030 Contact Diameter | .030 Contact Diameter | .040 Contact Diameter | .040 Contact Diameter | .040 Contact Diameter |
| 9 | DEM-9SD | DEM-9SL | DEM-9SS | DEM-9SA | DEM-9SG | DEM-9SW |
| 15 | DAM-15SD | DAM-15SL | DAM-15SS | DAM-15SA | DAM-15SG | DAM-15SW |
| 25 | DBM-25SD | DBM-25SL | DBM-25SS | DBM-25SA | DBM-25SG | DBM-25SW |
| 37 | DCM-37SD | DCM-37SL | DCM-37SS | DCM-37SA | DCM-37SG | DCM-37SW |

Tin-Plated Shell

| Positions | .125 Tail Length | .158 Tail Length | .185 Tail Length | .125 Tail Length | .158 Tail Length | .185 Tail Length |
|-----------|--------------------------|--------------------------|--------------------------|--------------------------|--------------------------|--------------------------|
| | .030 Contact Diameter | .030 Contact Diameter | .030 Contact Diameter | .040 Contact Diameter | .040 Contact Diameter | .040 Contact Diameter |
| 9 | DEM-9SDT | DEM-9SLT | DEM-9SST | DEM-9SAT | DEM-9SGT | DEM-9SWT |
| 15 | DAM-15SDT | DAM-15SLT | DAM-15SST | DAM-15SAT | DAM-15SGT | DAM-15SWT |
| 25 | DBM-25SDT | DBM-25SLT | DBM-25SST | DBM-25SAT | DBM-25SGT | DBM-25SWT |
| 37 | DCM-37SDT | DCM-37SLT | DCM-37SST | DCM-37SAT | DCM-37SGT | DCM-37SWT |

D-subminiature Metal Shell Vertical Dip Solder PCB Series 1 - High Reliability



- Available with three contact tail lengths (.125", .158", and .185") and two contact diameters (.030" and .040").

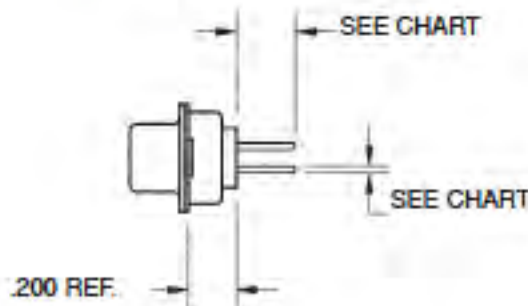

Ordering Information

Vertical PCB Plugs

Zinc-Plated Shell with Yellow Chromate Finish

| Positions | .125 Tail Length | .158 Tail Length | .185 Tail Length | .125 Tail Length | .158 Tail Length | .185 Tail Length |
|-----------|-----------------------|-----------------------|-----------------------|-----------------------|-----------------------|-----------------------|
| | .030 Contact Diameter | .030 Contact Diameter | .030 Contact Diameter | .040 Contact Diameter | .040 Contact Diameter | .040 Contact Diameter |
| 9 | DEM-9PE | DEM-9PM | DEM-9PZ | DEM-9PB | DEM-9PH | DEM-9PX |
| 15 | DAM-15PE | DAM-15PM | DAM-15PZ | DAM-15PB | DAM-15PH | DAM-15PX |
| 25 | DBM-25PE | DBM-25PM | DBM-25PZ | DBM-25PB | DBM-25PH | DBM-25PX |
| 37 | DCM-37PE | DCM-37PM | DCM-37PZ | DCM-37PB | DCM-37PH | DCM-37PX |
| 50 | DDM-50PE | DDM-50PM | DDM-50PZ | DDM-50PB | DDM-50PH | DDM-50PX |

Zinc-Plated Shell with Yellow Chromate Finish and 4-40 Clinch Nuts

| Positions | .125 Tail Length | .158 Tail Length | .185 Tail Length | .125 Tail Length | .158 Tail Length | .185 Tail Length |
|-----------|-----------------------|-----------------------|-----------------------|-----------------------|-----------------------|-----------------------|
| | .030 Contact Diameter | .030 Contact Diameter | .030 Contact Diameter | .040 Contact Diameter | .040 Contact Diameter | .040 Contact Diameter |
| 9 | DEME-9PE | DEME-9PM | DEME-9PZ | DEME-9PB | DEME-9PH | DEME-9PX |
| 15 | DAME-15PE | DAME-15PM | DAME-15PZ | DAME-15PB | DAME-15PH | DAME-15PX |
| 25 | DBME-25PE | DBME-25PM | DBME-25PZ | DBME-25PB | DBME-25PH | DBME-25PX |
| 37 | DCME-37PE | DCME-37PM | DCME-37PZ | DCME-37PB | DCME-37PH | DCME-37PX |
| 50 | DDME-50PE | DDME-50PM | DDME-50PZ | DDME-50PB | DDME-50PH | DDME-50PX |

Zinc-Plated Shell with Yellow Chromate Finish and Dual Float Bushings

| Positions | .125 Tail Length | .158 Tail Length | .185 Tail Length | .125 Tail Length | .158 Tail Length | .185 Tail Length |
|-----------|-----------------------|-----------------------|-----------------------|-----------------------|-----------------------|-----------------------|
| | .030 Contact Diameter | .030 Contact Diameter | .030 Contact Diameter | .040 Contact Diameter | .040 Contact Diameter | .040 Contact Diameter |
| 9 | DEMY-9PE | DEMY-9PM | DEMY-9PZ | DEMY-9PB | DEMY-9PH | DEMY-9PX |
| 15 | DAMY-15PE | DAMY-15PM | DAMY-15PZ | DAMY-15PB | DAMY-15PH | DAMY-15PX |
| 25 | DBMY-25PE | DBMY-25PM | DBMY-25PZ | DBMY-25PB | DBMY-25PH | DBMY-25PX |
| 37 | DCMY-37PE | DCMY-37PM | DCMY-37PZ | DCMY-37PB | DCMY-37PH | DCMY-37PX |
| 50 | DDMY-50PE | DDMY-50PM | DDMY-50PZ | DDMY-50PB | DDMY-50PH | DDMY-50PX |

D-subminiature Metal Shell Vertical Dip Solder PCB Series 1 - High Reliability



Ordering Information

Vertical PCB Plugs (Cont'd)

Tin-Plated Shell with Grounding Indents

| Positions | .125 Tail Length | .158 Tail Length | .185 Tail Length | .125 Tail Length | .158 Tail Length | .185 Tail Length |
|-----------|-----------------------|-----------------------|-----------------------|-----------------------|-----------------------|-----------------------|
| | .030 Contact Diameter | .030 Contact Diameter | .030 Contact Diameter | .040 Contact Diameter | .040 Contact Diameter | .040 Contact Diameter |
| 9 | DEM-9PETI | DEM-9PMTI | DEM-9PZTI | DEM-9PBTI | DEM-9PHTI | DEM-9PXTI |
| 15 | DAM-15PETI | DAM-15PMTI | DAM-15PZTI | DAM-15PBTI | DAM-15PHTI | DAM-15PXTI |
| 25 | DBM-25PETI | DBM-25PMTI | DBM-25PZTI | DBM-25PBTI | DBM-25PHTI | DBM-25PXTI |
| 37 | DCM-37PETI | DCM-37PMTI | DCM-37PZTI | DCM-37PBTI | DCM-37PHTI | DCM-37PXTI |
| 50 | DDM-50PETI | DDM-50PMTI | DDM-50PZTI | DDM-50PBTI | DDM-50PHTI | DDM-50PXTI |

Tin-Plated Shell with Grounding Indents and 4-40 Clinch Nuts

| Positions | .125 Tail Length | .158 Tail Length | .185 Tail Length | .125 Tail Length | .158 Tail Length | .185 Tail Length |
|-----------|-----------------------|-----------------------|-----------------------|-----------------------|-----------------------|-----------------------|
| | .030 Contact Diameter | .030 Contact Diameter | .030 Contact Diameter | .040 Contact Diameter | .040 Contact Diameter | .040 Contact Diameter |
| 9 | DEME-9PETI | DEME-9PMTI | DEME-9PZTI | DEME-9PBTI | DEME-9PHTI | DEME-9PXTI |
| 15 | DAME-15PETI | DAME-15PMTI | DAME-15PZTI | DAME-15PBTI | DAME-15PHTI | DAME-15PXTI |
| 25 | DBME-25PETI | DBME-25PMTI | DBME-25PZTI | DBME-25PBTI | DBME-25PHTI | DBME-25PXTI |
| 37 | DCME-37PETI | DCME-37PMTI | DCME-37PZTI | DCME-37PBTI | DCME-37PHTI | DCME-37PXTI |
| 50 | DDME-50PETI | DDME-50PMTI | DDME-50PZTI | DDME-50PBTI | DDME-50PHTI | DDME-50PXTI |

Tin-Plated Shell with Grounding Indents and Dual Float Bushings

| Positions | .125 Tail Length | .158 Tail Length | .185 Tail Length | .125 Tail Length | .158 Tail Length | .185 Tail Length |
|-----------|-----------------------|-----------------------|-----------------------|-----------------------|-----------------------|-----------------------|
| | .030 Contact Diameter | .030 Contact Diameter | .030 Contact Diameter | .040 Contact Diameter | .040 Contact Diameter | .040 Contact Diameter |
| 9 | DEMY-9PETI | DEMY-9PMTI | DEMY-9PZTI | DEMY-9PBTI | DEMY-9PHTI | DEMY-9PXTI |
| 15 | DAMY-15PETI | DAMY-15PMTI | DAMY-15PZTI | DAMY-15PBTI | DAMY-15PHTI | DAMY-15PXTI |
| 25 | DBMY-25PETI | DBMY-25PMTI | DBMY-25PZTI | DBMY-25PBTI | DBMY-25PHTI | DBMY-25PXTI |
| 37 | DCMY-37PETI | DCMY-37PMTI | DCMY-37PZTI | DCMY-37PBTI | DCMY-37PHTI | DCMY-37PXTI |
| 50 | DDMY-50PETI | DDMY-50PMTI | DDMY-50PZTI | DDMY-50PBTI | DDMY-50PHTI | DDMY-50PXTI |

Vertical PCB Sockets

Zinc-Plated Shell with Yellow Chromate Finish

| Positions | .125 Tail Length | .158 Tail Length | .185 Tail Length | .125 Tail Length | .158 Tail Length | .185 Tail Length |
|-----------|-----------------------|-----------------------|-----------------------|-----------------------|-----------------------|-----------------------|
| | .030 Contact Diameter | .030 Contact Diameter | .030 Contact Diameter | .040 Contact Diameter | .040 Contact Diameter | .040 Contact Diameter |
| 9 | DEM-9SE | DEM-9SM | DEM-9SZ | DEM-9SB | DEM-9SH | DEM-9SX |
| 15 | DAM-15SE | DAM-15SM | DAM-15SZ | DAM-15SB | DAM-15SH | DAM-15SX |
| 25 | DBM-25SE | DBM-25SM | DBM-25SZ | DBM-25SB | DBM-25SH | DBM-25SX |
| 37 | DCM-37SE | DCM-37SM | DCM-37SZ | DCM-37SB | DCM-37SH | DCM-37SX |
| 50 | DDM-50SE | DDM-50SM | DDM-50SZ | DDM-50SB | DDM-50SH | DDM-50SX |

D-subminiature Metal Shell Vertical Dip Solder PCB Series 1 - High Reliability



Ordering Information

Vertical PCB Sockets (Cont'd)

Zinc-Plated Shell with Yellow Chromate Finish and 4-40 Clinch Nuts

| Positions | .125 Tail Length | .158 Tail Length | .185 Tail Length | .125 Tail Length | .158 Tail Length | .185 Tail Length |
|-----------|-----------------------|-----------------------|-----------------------|-----------------------|-----------------------|-----------------------|
| | .030 Contact Diameter | .030 Contact Diameter | .030 Contact Diameter | .040 Contact Diameter | .040 Contact Diameter | .040 Contact Diameter |
| 9 | DEME-9SE | DEME-9SM | DEME-9SZ | DEME-9SB | DEME-9SH | DEME-9SX |
| 15 | DAME-15SE | DAME-15SM | DAME-15SZ | DAME-15SB | DAME-15SH | DAME-15SX |
| 25 | DBME-25SE | DBME-25SM | DBME-25SZ | DBME-25SB | DBME-25SH | DBME-25SX |
| 37 | DCME-37SE | DCME-37SM | DCME-37SZ | DCME-37SB | DCME-37SH | DCME-37SX |
| 50 | DDME-50SE | DDME-50SM | DDME-50SZ | DDME-50SB | DDME-50SH | DDME-50SX |

Zinc-Plated Shell with Yellow Chromate Finish and Dual Float Bushings

| Positions | .125 Tail Length | .158 Tail Length | .185 Tail Length | .125 Tail Length | .158 Tail Length | .185 Tail Length |
|-----------|-----------------------|-----------------------|-----------------------|-----------------------|-----------------------|-----------------------|
| | .030 Contact Diameter | .030 Contact Diameter | .030 Contact Diameter | .040 Contact Diameter | .040 Contact Diameter | .040 Contact Diameter |
| 9 | DEMY-9SE | DEMY-9SM | DEMY-9SZ | DEMY-9SB | DEMY-9SH | DEMY-9SX |
| 15 | DAMY-15SE | DAMY-15SM | DAMY-15SZ | DAMY-15SB | DAMY-15SH | DAMY-15SX |
| 25 | DBMY-25SE | DBMY-25SM | DBMY-25SZ | DBMY-25SB | DBMY-25SH | DBMY-25SX |
| 37 | DCMY-37SE | DCMY-37SM | DCMY-37SZ | DCMY-37SB | DCMY-37SH | DCMY-37SX |
| 50 | DDMY-50SE | DDMY-50SM | DDMY-50SZ | DDMY-50SB | DDMY-50SH | DDMY-50SX |

Tin-Plated Shell

| Positions | .125 Tail Length | .158 Tail Length | .185 Tail Length | .125 Tail Length | .158 Tail Length | .185 Tail Length |
|-----------|-----------------------|-----------------------|-----------------------|-----------------------|-----------------------|-----------------------|
| | .030 Contact Diameter | .030 Contact Diameter | .030 Contact Diameter | .040 Contact Diameter | .040 Contact Diameter | .040 Contact Diameter |
| 9 | DEM-9SET | DEM-9SMT | DEM-9SZT | DEM-9SBT | DEM-9SHT | DEM-9SXT |
| 15 | DAM-15SET | DAM-15SMT | DAM-15SZT | DAM-15SBT | DAM-15SHT | DAM-15SXT |
| 25 | DBM-25SET | DBM-25SMT | DBM-25SZT | DBM-25SBT | DBM-25SHT | DBM-25SXT |
| 37 | DCM-37SET | DCM-37SMT | DCM-37SZT | DCM-37SBT | DCM-37SHT | DCM-37SXT |
| 50 | DDM-50SET | DDM-50SMT | DDM-50SZT | DDM-50SBT | DDM-50SHT | DDM-50SXT |

Tin-Plated Shell with 4-40 Clinch Nuts

| Positions | .125 Tail Length | .158 Tail Length | .185 Tail Length | .125 Tail Length | .158 Tail Length | .185 Tail Length |
|-----------|-----------------------|-----------------------|-----------------------|-----------------------|-----------------------|-----------------------|
| | .030 Contact Diameter | .030 Contact Diameter | .030 Contact Diameter | .040 Contact Diameter | .040 Contact Diameter | .040 Contact Diameter |
| 9 | DEME-9SET | DEME-9SMT | DEME-9SZT | DEME-9SBT | DEME-9SHT | DEME-9SXT |
| 15 | DAME-15SET | DAME-15SMT | DAME-15SZT | DAME-15SBT | DAME-15SHT | DAME-15SXT |
| 25 | DBME-25SET | DBME-25SMT | DBME-25SZT | DBME-25SBT | DBME-25SHT | DBME-25SXT |
| 37 | DCME-37SET | DCME-37SMT | DCME-37SZT | DCME-37SBT | DCME-37SHT | DCME-37SXT |
| 50 | DDME-50SET | DDME-50SMT | DDME-50SZT | DDME-50SBT | DDME-50SHT | DDME-50SXT |

Tin-Plated Shell with Dual Float Bushings

| Positions | .125 Tail Length | .158 Tail Length | .185 Tail Length | .125 Tail Length | .158 Tail Length | .185 Tail Length |
|-----------|-----------------------|-----------------------|-----------------------|-----------------------|-----------------------|-----------------------|
| | .030 Contact Diameter | .030 Contact Diameter | .030 Contact Diameter | .040 Contact Diameter | .040 Contact Diameter | .040 Contact Diameter |
| 9 | DEMY-9SET | DEMY-9SMT | DEMY-9SZT | DEMY-9SBT | DEMY-9SHT | DEMY-9SXT |
| 15 | DAMY-15SET | DAMY-15SMT | DAMY-15SZT | DAMY-15SBT | DAMY-15SHT | DAMY-15SXT |
| 25 | DBMY-25SET | DBMY-25SMT | DBMY-25SZT | DBMY-25SBT | DBMY-25SHT | DBMY-25SXT |
| 37 | DCMY-37SET | DCMY-37SMT | DCMY-37SZT | DCMY-37SBT | DCMY-37SHT | DCMY-37SXT |
| 50 | DDMY-50SET | DDMY-50SMT | DDMY-50SZT | DDMY-50SBT | DDMY-50SHT | DDMY-50SXT |

D-subminiature Metal Shell - Combination Layout Solder Cup and Vertical PCB Series 1 - High Reliability



- Shell Sizes (equivalent to standard size): E (Size 9), A (Size 15), B (Size 25), C (Size 25), and D (Size 25).
- Offered in a variety of combination layouts in vertical style for PCB mount or solder cup style for wire termination.
- Signal Contacts (Size 20) are fixed and non-removable.
 - Vertical Dip Solder Contacts are available with three contact tail lengths (.125", .158", and .185") and two contact diameters (.030" and .040").
- Removable Coaxial, High Power, High Voltage contacts must be ordered separately.
- See Series 1 page 4-48 for specifications.
- Available with 30 μ in. or 50 μ in. gold contact plating.

Materials

Connector Shell:

- Steel with zinc or cadmium plating and yellow chromate finish or tin plating (grounding indents on plug).



D-subminiature Metal Shell Crimp and Poke Series 3 - High Reliability



FEATURES

- *High-reliability in a commercial grade connector.*
- *Monoblock diallyl phthalate insulator for improved electrical performance.*
- *Offered in 9, 15, 25, 37, and 50 position plugs and sockets.*
- *Offered with .120 mounting holes, 4-40 clinch nuts, or dual float bushings.*
- *Commercial version of M24308 Military connectors with tin-plated or zinc-plated shell and 30µin. gold contact plating.*
- *Screw Machine Crimp and Poke contacts available as follows:*
 - *Note that all contacts are packed loose.*
 - *Plating options: 30µin. gold.*
 - *Can be included with the connector or purchased separately (FO part numbers).*
- *See pages 4-5 thru 4-10 for standard dimensions, contact arrangements, and panel mounting specifications.*

MATERIALS

Insulator Material: Glass fiber-filled diallyl phthalate (green), UL 94V-0
Connector Shell: Steel with zinc plating and yellow chromate finish
Contact Material: Plug - Brass (machined), Socket - Phosphor bronze (machined)
Contact Plating: 30µin. gold over nickel
4-40 Clinch Nut: Steel with cadmium plating and yellow chromate finish
Dual Float Bushing: Stainless steel, passivated

ENVIRONMENTAL

Operating Temperature: -65°C to + 125°C
Shock: 50G peak per MIL-STD-202, Method 213, Condition G
Vibration: 12 cycles in three perpendicular directions @ 10-2000Hz, per MIL-STD-202, Method 204, Condition D
Moisture Resistance: 90-95% relative humidity @ 40°C for 96 hours per MIL-STD-202, Method 103

ELECTRICAL

Withstanding Voltage: Minimum 1250V RMS @ sea level
Current Rating: 5 Amps
Contact Resistance: 2.7 milliohms maximum
Insulation Resistance: 5000 megohms maximum (initial); 1000 megohms (minimum) after environmental testing

MECHANICAL

Individual Contact Insertion and Separation Force (minimum/maximum): 0.7 oz./12 oz.
Durability: 500 mating cycles

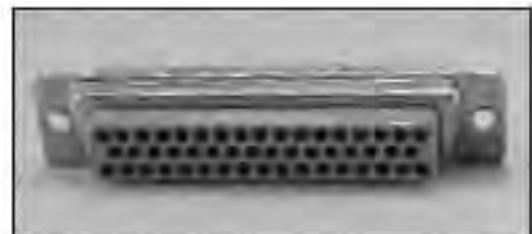

D-subminiature Metal Shell Crimp and Poke Series 3 - High Reliability

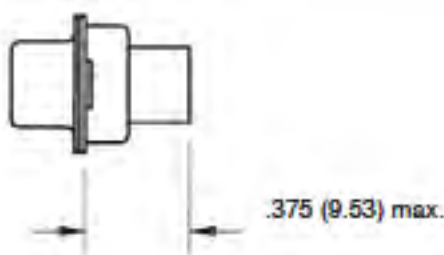

Termination Tooling

- Contact Insertion/Extraction Tool: #CIET-20-HD (Military #M81969/39-01). See page 4-103.
- Crimp Contact Hand Tool: Military #M22520/2-01. See page 4-103. Contact Positioner (below) required.
- Positioner for machine contacts for Hand Tool #M22520/2-01 (locates contact in the correct position): #M22520/2-08. See page 4-103.

Ordering Information

Crimp and Poke - Plugs

Zinc-Plated Shell with Yellow Chromate Finish

| Positions | Mounting Holes | | 4-40 Clinch Nuts | | Dual Float Bushings | |
|-----------|----------------------|------------------|----------------------|------------------|----------------------|------------------|
| | 30µin. Gold Contacts | Without Contacts | 30µin. Gold Contacts | Without Contacts | 30µin. Gold Contacts | Without Contacts |
| 9 | DEMA-9P | DEMA-9P-FO | DEMAE-9P | DEMAE-9P-FO | DEMAY-9P | DEMAY-9P-FO |
| 15 | DAMA-15P | DAMA-15P-FO | DAMAE-15P | DAMAE-15P-FO | DAMAY-15P | DAMAY-15P-FO |
| 25 | DBMA-25P | DBMA-25P-FO | DBMAE-25P | DBMAE-25P-FO | DBMAY-25P | DBMAY-25P-FO |
| 37 | DCMA-37P | DCMA-37P-FO | DCMAE-37P | DCMAE-37P-FO | DCMAY-37P | DCMAY-37P-FO |
| 50 | DDMA-50P | DDMA-50P-FO | DDMAE-50P | DDMAE-50P-FO | DDMAY-50P | DDMAY-50P-FO |

Tin-Plated Shells with Grounding Indents

| Positions | Mounting Holes | | 4-40 Clinch Nuts | | Dual Float Bushings | |
|-----------|----------------------|------------------|----------------------|------------------|----------------------|------------------|
| | 30µin. Gold Contacts | Without Contacts | 30µin. Gold Contacts | Without Contacts | 30µin. Gold Contacts | Without Contacts |
| 9 | DEMA-9PTI | DEMA-9PTI-FO | DEMAE-9PTI | DEMAE-9PTI-FO | DEMAY-9PTI | DEMAY-9PTI-FO |
| 15 | DAMA-15PTI | DAMA-15PTI-FO | DAMAE-15PTI | DAMAE-15PTI-FO | DAMAY-15PTI | DAMAY-15PTI-FO |
| 25 | DBMA-25PTI | DBMA-25PTI-FO | DBMAE-25PTI | DBMAE-25PTI-FO | DBMAY-25PTI | DBMAY-25PTI-FO |
| 37 | DCMA-37PTI | DCMA-37PTI-FO | DCMAE-37PTI | DCMAE-37PTI-FO | DCMAY-37PTI | DCMAY-37PTI-FO |
| 50 | DDMA-50PTI | DDMA-50PTI-FO | DDMAE-50PTI | DDMAE-50PTI-FO | DDMAY-50PTI | DDMAY-50PTI-FO |

D-subminiature Metal Shell Crimp and Poke Series 3 - High Reliability



Ordering Information

Crimp and Poke - Sockets

Zinc-Plated Shell with Yellow Chromate Finish

| Positions | Mounting Holes | | 4-40 Clinch Nuts | | Dual Float Bushings | |
|-----------|----------------------|------------------|----------------------|------------------|----------------------|------------------|
| | 30pin. Gold Contacts | Without Contacts | 30pin. Gold Contacts | Without Contacts | 30pin. Gold Contacts | Without Contacts |
| 9 | DEMA-9S | DEMA-9S-FO | DEMAE-9S | DEMAE-9S-FO | DEMAY-9S | DEMAY-9S-FO |
| 15 | DAMA-15S | DAMA-15S-FO | DAMAE-15S | DAMAE-15S-FO | DAMAY-15S | DAMAY-15S-FO |
| 25 | DBMA-25S | DBMA-25S-FO | DBMAE-25S | DBMAE-25S-FO | DBMAY-25S | DBMAY-25S-FO |
| 37 | DCMA-37S | DCMA-37S-FO | DCMAE-37S | DCMAE-37S-FO | DCMAY-37S | DCMAY-37S-FO |
| 50 | DDMA-50S | DDMA-50S-FO | DDMAE-50S | DDMAE-50S-FO | DDMAY-50S | DDMAY-50S-FO |

Tin-Plated Shell

| Positions | Mounting Holes | | 4-40 Clinch Nuts | | Dual Float Bushings | |
|-----------|----------------------|------------------|----------------------|------------------|----------------------|------------------|
| | 30pin. Gold Contacts | Without Contacts | 30pin. Gold Contacts | Without Contacts | 30pin. Gold Contacts | Without Contacts |
| 9 | DEMA-9ST | DEMA-9ST-FO | DEMAE-9ST | DEMAE-9ST-FO | DEMAY-9ST | DEMAY-9ST-FO |
| 15 | DAMA-15ST | DAMA-15ST-FO | DAMAE-15ST | DAMAE-15ST-FO | DAMAY-15ST | DAMAY-15ST-FO |
| 25 | DBMA-25ST | DBMA-25ST-FO | DBMAE-25ST | DBMAE-25ST-FO | DBMAY-25ST | DBMAY-25ST-FO |
| 37 | DCMA-37ST | DCMA-37ST-FO | DCMAE-37ST | DCMAE-37ST-FO | DCMAY-37ST | DCMAY-37ST-FO |
| 50 | DDMA-50ST | DDMA-50ST-FO | DDMAE-50ST | DDMAE-50ST-FO | DDMAY-50ST | DDMAY-50ST-FO |

4

Crimp and Poke Machined Contacts

- Will accommodate 20, 22, and 24 AWG wire.



Ordering Information

Contacts

Description

| | |
|--------|---------------|
| Pin | M39029/64-369 |
| Socket | M39029/63-368 |

**D-subminiature Metal Shell
MIL-C-24308
M24308 Series**



FEATURES

- Meets all MIL-C-24308 Class G specifications.
- Offered in Crimp and Poke and Solder Cup and PCB vertical and right-angle.
- Offered in 9, 15, 25, 37, and 50 position plugs and sockets except right-angle (9 to 37 positions).
- Monoblock green diallyl phthalate insulator for improved electrical performance.
- See pages 4-5 thru 4-10 for standard dimensions, contact arrangements, and panel mounting specifications.

MATERIALS

Insulator Material: Glass-filled diallyl phthalate (green) per MIL-M-14, Type SDG-F
Connector Shell: Steel with cadmium plating and yellow chromate finish
Contact Material: Plug - Brass (machined), Socket - Phosphor bronze (machined)
Contact Plating: 50µin. gold over copper or nickel
Dual Float Bushing: Stainless steel, passivated or non-magnetic brass

ENVIRONMENTAL

Operating Temperature: -85°C to + 125°C
Shock: 50G peak per MIL-STD-202, Method 213, Condition G
Vibration: 12 cycles in three perpendicular directions @ 10-2000Hz, per MIL-STD-202 Method 204, Condition D
Moisture Resistance: 90-95% relative humidity @ 40°C for 96 hours per MIL-STD-202, Method 103

ELECTRICAL

Withstanding Voltage: Minimum 1250V RMS @ sea level
Current Rating: 5 Ampe
Contact Resistance: 2.7 milliohms maximum
Insulation Resistance: 5000 megohms maximum (initial); 1000 megohms (minimum) after environmental testing

MECHANICAL

Individual Contact Insertion and Separation Force (minimum/maximum): 0.7 oz./12 oz.
Durability: 500 mating cycles

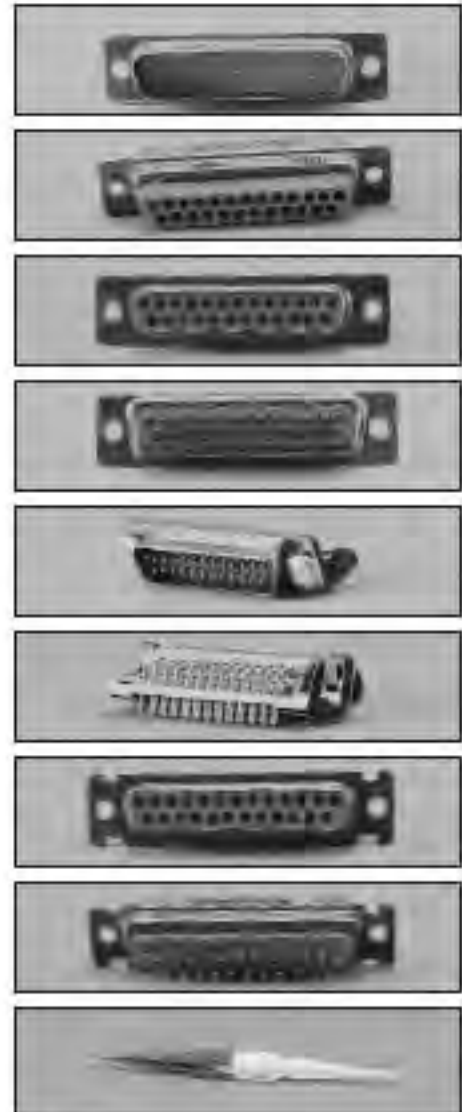

D-subminiature Metal Shell MIL-C-24308 Crimp and Poke M24308 Series

Cinch

- Available with .120 mounting holes, float bushings, or dual float bushings.
- Order with contacts included or separately.
- Order with contact Insertion/Extraction Tool included or order tool #CIET-20-HD separately. See page 4-103.

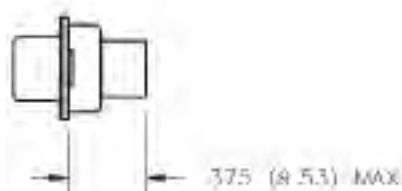

Ordering Information

Crimp and Poke Plugs

Steel Shell

Contacts Included. Insertion/Extraction Tool Not Included.

| Positions | Mounting Holes | Float Bushings | Dual Float Bushings |
|-----------|----------------|----------------|---------------------|
| 9 | M24308/4-1F | M24308/4-302F | M24308/4-435F |
| 15 | M24308/4-2F | M24308/4-303F | M24308/4-436F |
| 25 | M24308/4-3F | M24308/4-304F | M24308/4-437F |
| 37 | M24308/4-4F | M24308/4-305F | M24308/4-438F |
| 50 | M24308/4-5F | M24308/4-306F | M24308/4-439F |

Contacts Included. Insertion/Extraction Tool Included.

| Positions | Mounting Holes | Float Bushings | Dual Float Bushings |
|-----------|----------------|----------------|---------------------|
| 9 | M24308/4-6F | M24308/4-313F | M24308/4-446F |
| 15 | M24308/4-7F | M24308/4-314F | M24308/4-447F |
| 25 | M24308/4-8F | M24308/4-315F | M24308/4-448F |
| 37 | M24308/4-9F | M24308/4-316F | M24308/4-449F |
| 50 | M24308/4-10F | M24308/4-317F | M24308/4-450F |

Contacts Not Included. Insertion/Extraction Tool Not Included.

| Positions | Mounting Holes | Float Bushings | Dual Float Bushings |
|-----------|----------------|----------------|---------------------|
| 9 | M24308/4-259F | M24308/4-324F | M24308/4-457F |
| 15 | M24308/4-260F | M24308/4-325F | M24308/4-458F |
| 25 | M24308/4-261F | M24308/4-326F | M24308/4-459F |
| 37 | M24308/4-262F | M24308/4-327F | M24308/4-460F |
| 50 | M24308/4-263F | M24308/4-328F | M24308/4-461F |

D-subminiature Metal Shell MIL-C-24308 Crimp and Poke M24308 Series



Ordering Information

Crimp and Poke Sockets

Steel Shell

Contacts Included. Insertion/Extraction Tool Not Included.

| Positions | Mounting Holes | Float Bushings | Dual Float Bushings |
|-----------|----------------|----------------|---------------------|
| 9 | M24308/2-1F | M24308/2-23F | M24308/2-342F |
| 15 | M24308/2-2F | M24308/2-24F | M24308/2-343F |
| 25 | M24308/2-3F | M24308/2-25F | M24308/2-344F |
| 37 | M24308/2-4F | M24308/2-26F | M24308/2-345F |
| 50 | M24308/2-5F | M24308/2-27F | M24308/2-346F |

Contacts Included. Insertion/Extraction Tool Included.

| Positions | Mounting Holes | Float Bushings | Dual Float Bushings |
|-----------|----------------|----------------|---------------------|
| 9 | M24308/2-6F | M24308/2-34F | M24308/2-353F |
| 15 | M24308/2-7F | M24308/2-35F | M24308/2-354F |
| 25 | M24308/2-8F | M24308/2-36F | M24308/2-355F |
| 37 | M24308/2-9F | M24308/2-37F | M24308/2-356F |
| 50 | M24308/2-10F | M24308/2-38F | M24308/2-357F |

Contacts Not Included. Insertion/Extraction Tool Not Included.

| Positions | Mounting Holes | Float Bushings | Dual Float Bushings |
|-----------|----------------|----------------|---------------------|
| 9 | M24308/2-281F | M24308/2-292F | M24308/2-482F |
| 15 | M24308/2-282F | M24308/2-293F | M24308/2-483F |
| 25 | M24308/2-283F | M24308/2-294F | M24308/2-484F |
| 37 | M24308/2-284F | M24308/2-295F | M24308/2-485F |
| 50 | M24308/2-285F | M24308/2-296F | M24308/2-486F |

D-subminiature Metal Shell MIL-C-24308 Crimp and Poke M24308 Series



Ordering Information

Tooling

- Contact Insertion/Extraction Tool: #CIET-20-HD (Military #M81969/39-01). See page 4-103.
- Wire termination hand tool: #M22520/2-01. See page 4-103.
- Positioner for machine contacts for hand tool #M22520/2-08 (locates contact in the correct position). See page 4-103.

Crimp and Poke Contacts



Ordering Information

- Will accommodate 20, 22, and 24 AWG wire.

| Description | |
|-------------|---------------|
| Pin | M39029/84-369 |
| Socket | M39029/83-368 |

D-subminiature Metal Shell MIL-C-24308 Solder Cup M24308 Series



- Available with .120" mounting holes, float bushings, or dual float bushings.
- Will accommodate up to 20 AWG wire.

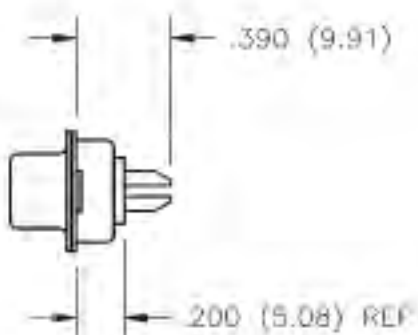

Ordering Information

Solder Cup Plugs

Steel Shell

| Positions | Mounting Holes | Float Bushings | Dual Float Bushings |
|-----------|----------------|----------------|---------------------|
| 9 | M24308/3-1F | M24308/3-12F | M24308/3-17F |
| 15 | M24308/3-2F | M24308/3-13F | M24308/3-18F |
| 25 | M24308/3-3F | M24308/3-14F | M24308/3-19F |
| 37 | M24308/3-4F | M24308/3-15F | M24308/3-20F |
| 50 | M24308/3-5F | M24308/3-16F | M24308/3-21F |

Brass Non-Magnetic Shell

| Positions | Mounting Holes | Float Bushings | Dual Float Bushings |
|-----------|----------------|----------------|---------------------|
| 9 | M24308/7-1F | M24308/7-12F | M24308/7-17F |
| 15 | M24308/7-2F | M24308/7-13F | M24308/7-18F |
| 25 | M24308/7-3F | M24308/7-14F | M24308/7-19F |
| 37 | M24308/7-4F | M24308/7-15F | M24308/7-20F |
| 50 | M24308/7-5F | M24308/7-16F | M24308/7-21F |

Solder Cup Sockets

Steel Shell

| Positions | Mounting Holes | Float Bushings | Dual Float Bushings |
|-----------|----------------|----------------|---------------------|
| 9 | M24308/1-1F | M24308/1-12F | M24308/1-23F |
| 15 | M24308/1-2F | M24308/1-13F | M24308/1-24F |
| 25 | M24308/1-3F | M24308/1-14F | M24308/1-25F |
| 37 | M24308/1-4F | M24308/1-15F | M24308/1-26F |
| 50 | M24308/1-5F | M24308/1-16F | M24308/1-27F |

Brass Non-Magnetic Shell

| Positions | Mounting Holes | Float Bushings | Dual Float Bushings |
|-----------|----------------|----------------|---------------------|
| 9 | M24308/5-1F | M24308/5-12F | M24308/5-23F |
| 15 | M24308/5-2F | M24308/5-13F | M24308/5-24F |
| 25 | M24308/5-3F | M24308/5-14F | M24308/5-25F |
| 37 | M24308/5-4F | M24308/5-15F | M24308/5-26F |
| 50 | M24308/5-5F | M24308/5-16F | M24308/5-27F |

D-subminiature Metal Shell MIL-C-24308 PCB M24308 Series



Right-Angle Connector

- .283" footprint requires minimal PCB space.
- Available with three contact tail lengths (.127", .158", and .183") with .030" contact diameter.
- Available with two contact tail lengths (.127" and .183") with .040" contact diameter.
- Offered with .120" mounting holes.
- Mounting bracket: Black nylon. Can be removed if necessary.

Right-Angle

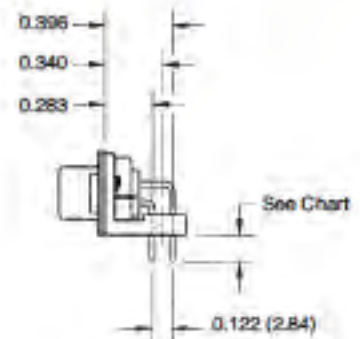

Ordering Information

Right-Angle PCB Plugs (Sockets not available)

Steel Shell

| Positions | .127 Tail Length .030 Contact Diameter | .158 Tail Length .030 Contact Diameter | .183 Tail Length .030 Contact Diameter | .127 Tail Length .040 Contact Diameter | .183 Tail Length .040 Contact Diameter |
|-----------|---|---|---|---|---|
| 9 | M24308/24-25F | M24308/24-31F | M24308/24-49F | M24308/24-37F | M24308/24-55F |
| 15 | M24308/24-26F | M24308/24-32F | M24308/24-50F | M24308/24-38F | M24308/24-56F |
| 25 | M24308/24-27F | M24308/24-33F | M24308/24-51F | M24308/24-39F | M24308/24-57F |
| 37 | M24308/24-28F | M24308/24-34F | M24308/24-52F | M24308/24-40F | M24308/24-58F |

Vertical Connector

- Available with two contact tail lengths (.158" and .183") and two contact diameters (.030" and .040").
- Offered with .120" mounting holes.

Vertical

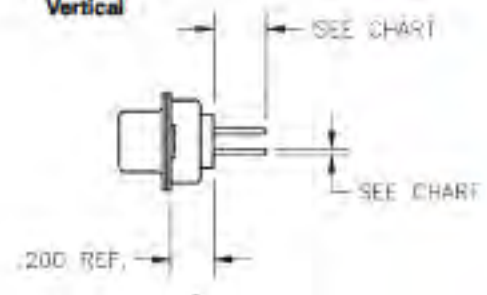

Ordering Information

Vertical PCB Plugs

Steel Shell

| Positions | .158 Tail Length .030 Contact Diameter | .183 Tail Length .030 Contact Diameter | .158 Tail Length .040 Contact Diameter | .183 Tail Length .040 Contact Diameter |
|-----------|---|---|---|---|
| 9 | M24308/24-1F | M24308/24-7F | M24308/24-13F | M24308/24-19F |
| 15 | M24308/24-2F | M24308/24-8F | M24308/24-14F | M24308/24-20F |
| 25 | M24308/24-3F | M24308/24-9F | M24308/24-15F | M24308/24-21F |
| 37 | M24308/24-4F | M24308/24-10F | M24308/24-16F | M24308/24-22F |
| 50 | M24308/24-5F | M24308/24-11F | M24308/24-17F | M24308/24-23F |

Vertical PCB Sockets

Steel Shell

| Positions | .158 Tail Length .030 Contact Diameter | .183 Tail Length .030 Contact Diameter | .158 Tail Length .040 Contact Diameter | .183 Tail Length .040 Contact Diameter |
|-----------|---|---|---|---|
| 9 | M24308/23-1F | M24308/23-7F | M24308/23-13F | M24308/23-19F |
| 15 | M24308/23-2F | M24308/23-8F | M24308/23-14F | M24308/23-20F |
| 25 | M24308/23-3F | M24308/23-9F | M24308/23-15F | M24308/23-21F |
| 37 | M24308/23-4F | M24308/23-10F | M24308/23-16F | M24308/23-22F |
| 50 | M24308/23-5F | M24308/23-11F | M24308/23-17F | M24308/23-23F |



Cinch backshells are offered in a variety of styles, each having a specific strength.

- **Backshells** have two-piece construction and are frequently used where appearance is a major factor. RF/EMI shielding capability is also an option:
 - Plastic Backshells: No shielding.
 - Metallized Plastic: Economical method of shielding.
 - Diecast Backshells: Maximum shielding.
- Cinch SDH Series backshells utilize Cinch's Latch-N-Lock™ system with quick release disconnect. Just squeeze the latch levers to release the connector. Also available with standard 4-40 mounting hardware.
- **Junction Shells** come in a variety of sizes and shapes including right-angle and low profile. They are generally of one-piece construction with an adjustable clamp, but there is no shielding.
- **Hoods** have an improved appearance versus junction shells but no shielding. They are all-plastic and come in right-angle or straight configurations.
- **Hardware**, in the form of adjustable grommets or strain relief clamps and 4-40 screws, is generally supplied with the product; however, a variety of optional hardware is also available in the accessories section of this catalog.

D-subminiature Backshells/Junction Shells/Hoods Accessories



The following is a summary of the various backshells, junction shells, and hoods that Cinch offers:

Backshells

| Type | 2-Piece | | 2-Piece | | Super-D Connection System | |
|--|---------|------------|-----------|----------|---------------------------|--------------|
| | Plastic | Metallized | Diecast | Diecast | Black Plastic | Gray Plastic |
| Material | DPH | DCH | DMH | Ethernet | SDH - B | SDH - G |
| Series | | | | | | |
| Shell Sizes ^a | E A B C | E A B C D | E A B C D | A | E A B C | E A B C |
| Cable Exit | 180° | 180° | 180° | 90°/180° | 90°/180° | 90°/180° |
| Fits Connector Series marked with "•": | | | | | | |
| D*A Series | • | • | • | • | • | |
| HTD Series | • | • | • | | | |
| D*U Series | • | • | • | • | • | |
| Series 3 | • | • | • | • | • | |
| T Series Metal Shell | • | • | • | • | • | |
| T Series All-Plastic | | | | | | • |
| Basic D | • | • | • | • | • | |
| Series 1 | • | • | • | • | • | |

Junction Shells/Hoods

| Type | Junction Shells | | | | | Hoods | | |
|--|-----------------|-------------|-----------------|---------------------|-----------------|------------------|------------------|-------------------|
| | Straight Clamp | Round Clamp | Rt. Angle Clamp | Deep Straight Clamp | Switching Shell | Phenolic Plastic | Straight Plastic | Rt. Angle Plastic |
| Material | Metal | Metal | Metal | Metal | Metal | Plastic | Plastic | Plastic |
| Shell Sizes ^a | A B C D | A B C D | E A B C D | E A B C D | A B C D | A B | E A B | A B |
| Cable Exit | 180° | 180° | 90° | 180° | 180° | 180° | 180° | 90° |
| Fits Connector Series marked with "•": | | | | | | | | |
| D*A Series | • | • | • | • | • | • | • | • |
| D*U Series | • | • | • | • | • | • | • | • |
| Series 3 | • | • | • | • | • | • | • | • |
| T Series Metal Shell | • | • | • | • | • | • | • | • |
| T Series All-Plastic | | | | | | | | |
| Basic D Series | • | • | • | • | • | • | • | • |
| Series 1 | • | • | • | • | • | • | • | • |

^aConversion Chart between Standard Density Connectors and HPD/HTD Series 1.5 Density Connectors

| Shell Size | Standard D-sub | 1.5 D-Sub HTD |
|------------|----------------|---------------|
| E | 9 | 15 |
| A | 15 | 26 |
| B | 25 | 44 |
| C | 37 | 62 |
| D | 50 | N/A |

D-subminiature Backshells - Two-Piece D*H Series

Cinch

- Standard two-piece construction available in plastic, metallized plastic, or diecast zinc versions with 180° straight cable entry.
- Fits standard metal shell D-subminiature plugs and sockets as well as HTD Series 1.5 D-sub.
- Ethernet hoods are available in diecast 15 position versions only with both 90° and 180° cable entry.
- Included in all backshells:
 - Hardware: 4-40 screws, hex nuts, 4-40 screw mounting bracket.
 - Grommets: To accommodate most cable sizes. Grommets also function as strain reliefs.
- Backshells are individually bagged.
- Note that slide locks may not be used with these backshells.
- Optional thumbscrew for backshell must be ordered separately if required.

Materials

- 4-40 screws, hex nuts, mounting bracket: Steel with zinc plating and clear chromate coating.
- Standard Backshells:
 - Plastic Backshells: ABS (black), hardware - steel with zinc plating, grommets - polyphenylene, (black).
 - Metallized Plastic Backshells: ABS with nickel over copper plating, hardware - steel with zinc plating, grommets - PVC (black).
 - Diecast Backshells: Diecast zinc, grommets - PVC (black).
- Ethernet Backshells: Diecast zinc, grommets - PVC (black).

4



Plastic



Metallized



Diecast



Ethernet Straight



Ethernet Right-Angle

D-subminiature Backshells - Two-Piece D*H Series



Straight (180°) Standard Backshells

Plastic and Metallized Plastic Backshells

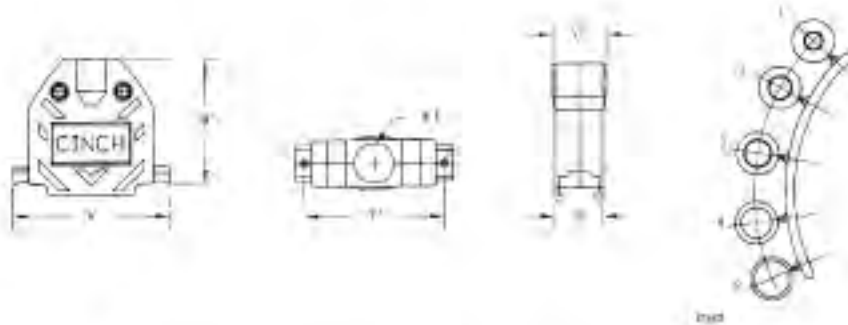

Dimensions

| Shell Size | A | | B | | C | | D | | E | | F | |
|------------|-------|-------|-------|-------|-------|-------|-------|-------|-------|-------|-------|-------|
| | in | mm | in | mm | in | mm | in | mm | in | mm | in | mm |
| E | 1.225 | 31.12 | 1.547 | 39.29 | 0.640 | 16.26 | 0.645 | 16.38 | 0.400 | 10.16 | 0.984 | 24.99 |
| A | 1.540 | 39.12 | 1.516 | 38.51 | 0.640 | 16.26 | 0.645 | 16.38 | 0.400 | 10.16 | 1.312 | 33.32 |
| B | 2.090 | 53.09 | 1.655 | 42.04 | 0.710 | 18.03 | 0.645 | 16.38 | 0.522 | 13.26 | 1.857 | 47.17 |
| C | 2.730 | 69.34 | 1.830 | 46.48 | 0.906 | 23.01 | 0.645 | 16.38 | 0.725 | 18.42 | 2.500 | 63.50 |
| D | 2.645 | 67.18 | 1.855 | 41.12 | 0.940 | 23.88 | 0.750 | 19.05 | 0.725 | 18.42 | 2.406 | 61.11 |

D-subminiature Backshells - Two-Piece D*H Series



EMVRFI Shielded Diecast Backshells

9 and 15 Position

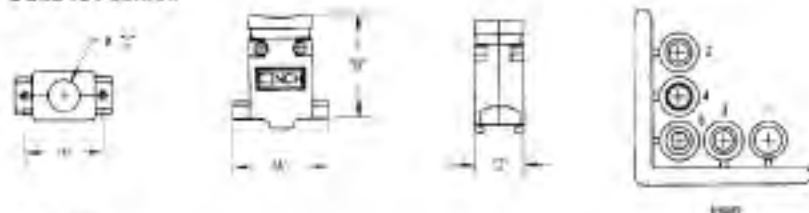

25 Position

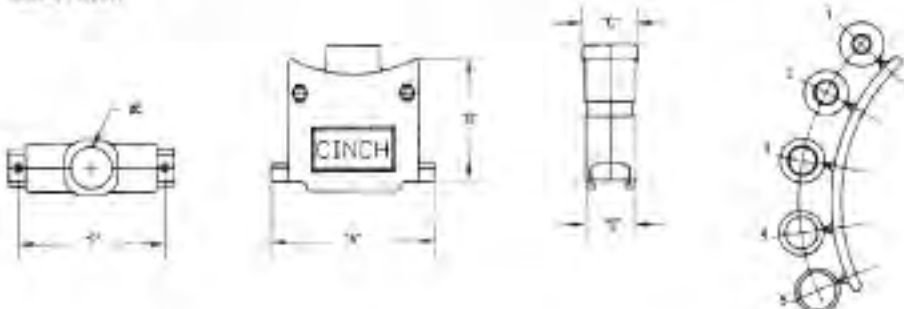

37 and 50 Position

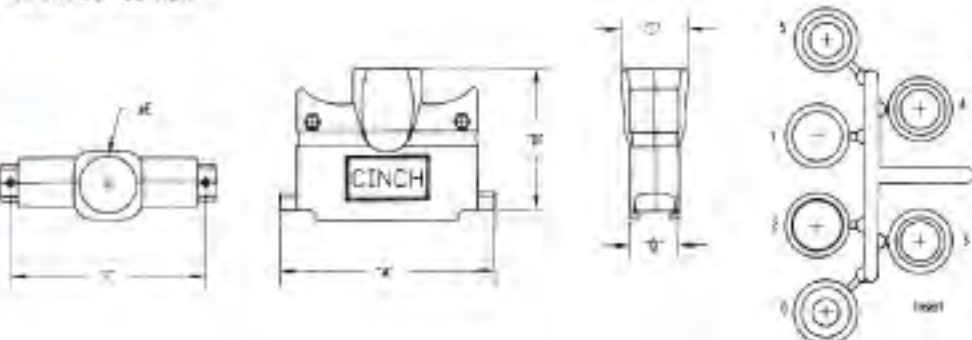

Dimensions

| Shell | A | | B | | C | | D | | E | | F | |
|-------|-------|-------|-------|-------|-------|-------|-------|-------|-------|-------|-------|-------|
| Size | in | mm | in | mm | in | mm | in | mm | in | mm | in | mm |
| E | 1.225 | 31.12 | 1.485 | 37.21 | 0.620 | 15.75 | 0.620 | 15.75 | 0.400 | 10.16 | 0.984 | 24.99 |
| A | 1.540 | 39.12 | 1.600 | 40.64 | 0.620 | 15.75 | 0.620 | 15.75 | 0.400 | 10.16 | 1.312 | 33.32 |
| B | 2.090 | 53.09 | 1.570 | 39.88 | 0.690 | 17.53 | 0.620 | 15.75 | 0.525 | 13.34 | 1.857 | 47.17 |
| C | 2.730 | 69.34 | 1.810 | 45.97 | 0.862 | 21.89 | 0.620 | 15.75 | 0.725 | 18.42 | 2.500 | 63.50 |
| D | 2.624 | 66.65 | 1.800 | 45.72 | 0.862 | 21.89 | 0.730 | 18.54 | 0.725 | 18.42 | 2.406 | 61.11 |

Ordering Information

D*H Two-Piece Backshells

| Shell Size | Fits Standard Density | Fits HTD 1.5 Density | Cable Entry Style | Plastic | Cable Dia. (in) | Metallized Plastic | Cable Dia. (in) | Diecast Metal | Cable Dia. (in) |
|------------|-----------------------|----------------------|-------------------|-----------|-----------------|--------------------|-----------------|---------------|-----------------|
| E | 9 | 15 | Straight (180°) | DPH-E-001 | .210-.320 | DCH-E-001 | .210-.350 | DMH-E-001 | .210-.320 |
| A | 15 | 26 | Straight (180°) | DPH-A-001 | .210-.320 | DCH-A-001 | .210-.350 | DMH-A-001 | .210-.320 |
| B | 25 | 44 | Straight (180°) | DPH-B-001 | .230-.450 | DCH-B-001 | .230-.450 | DMH-B-001 | .230-.450 |
| C | 37 | 62 | Straight (180°) | DPH-C-001 | .350-.650 | DCH-C-001 | .350-.640 | DMH-C-001 | .350-.650 |
| D | 50 | N/A | Straight (180°) | DPH-D-001 | .350-.650 | DCH-D-001 | .350-.640 | DMH-D-001 | .350-.640 |

D-subminiature Backshells - Two-Piece D*H Series



Straight (180°) Diecast Ethernet Backshells

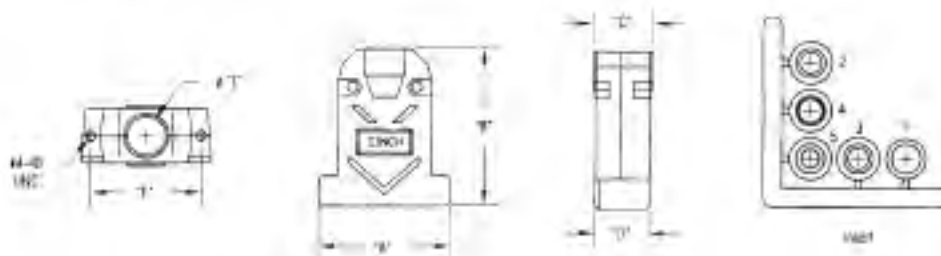

Type 2

Right-Angle (90°) Diecast Ethernet Backshells

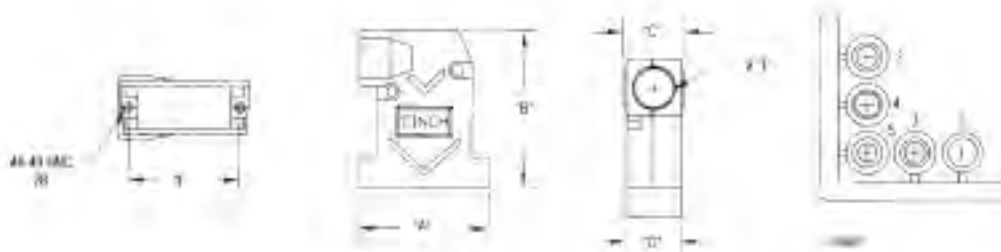

Ordering Information

D*H Ethernet Diecast Backshells

| Fits Shell Size | Fits Standard Density | Cable Diameter (in) | Cable Entry Style | A | | B | | C | | D | | E | | F | | |
|-----------------------|-----------------------------|------------------------|----------------------|-------------|-------|-------|-------|-------|-------|-------|------|-------|-------|-------|-------|-------|
| | | | | in | mm | in | mm | in | mm | in | mm | in | mm | in | mm | |
| A | 15 | .210-.320 | Straight (180°) | DMH-A-001XL | 1.550 | 39.37 | 1.880 | 47.75 | 0.710 | 18.03 | 0.64 | 16.26 | 0.522 | 13.26 | 1.312 | 33.32 |
| A | 15 | .210-.320 | Rt. Angle (90°) | DMH-A-901X | 1.550 | 39.37 | 1.880 | 47.75 | 0.710 | 18.03 | 0.64 | 16.26 | 0.522 | 13.26 | 1.312 | 33.32 |



THUMBSCREWS (OPTIONAL) FOR D*H BACKSHELLS
 Order #4-40-THMB-1 (two each required per backshell).
 (Will not work with ethernet type backshells)

FEATURES

- *The Cinch Super D Interconnection System is a simple, fast, economical, and reliable way for mating connectors from cable to cable or cable to panel.*
- *Snap-on Super D plastic hoods captivate connectors providing positive, self-latching, audible mating with reliable retention and Latch-N-Lock quick release disconnect.*
- *Snap-on Super-D plastic hoods are also available with filler ends to utilize 4-40 mounting hardware.*
- *Super D hoods are available:*
 - *Straight (180°) or Right-Angle (90°) cable entry.*
 - *Sizes: 9, 15, 25, and 37.*
 - *Sizes 15, 25, and 37 are available in standard or large cable openings.*
- *Black SDH backshells accommodate any standard metal shell IDC, solder cup, or crimp and poke D-subminiature connector.*
- *Gray SDH backshells accommodate the Cinch All-Plastic IDC T-Series connector on pages 4-38 thru 4-39.*
- *Each Super-D plastic hood includes a stay band to strain relief the cable wire. Stay band tool SD-MSBT is required. Extra stay bands are available on page 4-90.*

MATERIALS

Hood: Modified phenylene oxide - black for metal shell connectors or gray for all-plastic IDC connectors

Latch Block: Diecast zinc

Screws for Latching Blocks: Steel with nickel plating

Stay Band: Steel with zinc plating and clear chromate finish



D-subminiature Backshells - For use with Metal Shell Connectors

SDH Series



Straight (180°) Cable Entry Black Backshells for Metal Shell Connectors

Adapter Hood with Filler Ends

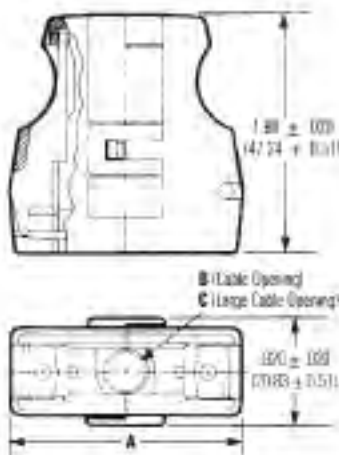

Adapter Hood with Latches

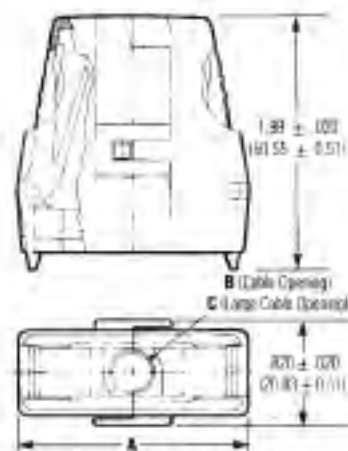

Right-Angle (90°) Cable Entry Black Backshells for Metal Shell Connectors

Right-Angle Adapter Hood

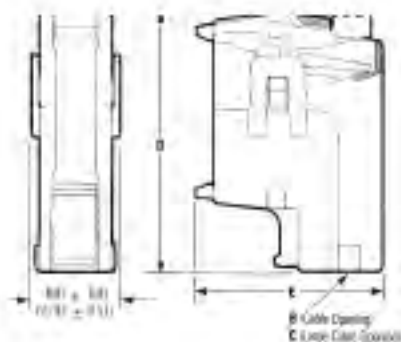

Dimensions

| Positions | A ± .020" (.58mm) | | B ± .020" (.58mm) | | C ± .020" (.58mm) | | D ± .020" (.58mm) | | E ± .020" (.58mm) | |
|-----------|-------------------|-------|-------------------|------|-------------------|-------|-------------------|-------|-------------------|-------|
| | in | mm | in | mm | in | mm | in | mm | in | mm |
| 9 | 1.47 | 37.34 | .31 | 7.87 | - | - | 1.94 | 49.21 | 1.25 | 31.75 |
| 15 | 1.80 | 45.72 | .31 | 7.87 | .41 | 10.41 | 2.25 | 57.15 | 1.34 | 34.13 |
| 25 | 2.35 | 59.69 | .33 | 8.40 | .47 | 11.94 | 2.94 | 74.61 | 1.50 | 38.10 |
| 37 | 2.99 | 75.95 | .37 | 9.40 | .50 | 12.70 | 3.59 | 91.28 | 1.53 | 38.89 |

D-subminiature Backshells - For use with Metal Shell Connectors SDH Series



Ordering Information

Straight (180°) Cable Entry Black Backshells for Metal Shell Connectors

| Positions | Latches | | Filler Ends | | Filler Ends w/4-40 Screws | |
|-----------|------------------------|---------------------|------------------------|---------------------|---------------------------|---------------------|
| | Standard Cable Opening | Large Cable Opening | Standard Cable Opening | Large Cable Opening | Standard Cable Opening | Large Cable Opening |
| 9 | SDH-9BL | N/A | SDH-9BF | N/A | SDH-9BFCS | N/A |
| 15 | SDH-15BL | SDH-15BLL | SDH-15BF | SDH-15BFL | SDH-15BFCS | SDH-15BFLCS |
| 25 | SDH-25BL | SDH-25BLL | SDH-25BF | SDH-25BFL | SDH-25BFCS | SDH-25BFLCS |
| 37 | SDH-37BL | SDH-37BLL | SDH-37BF | SDH-37BFL | SDH-37BFCS | SDH-37BFLCS |

Right-Angle (90°) Cable Entry Black Backshells for Metal Shell Connectors

Ordering Information

| Positions | Standard Cable Opening | Latches | |
|-----------|------------------------|---------------------|---------------------|
| | | Large Cable Opening | Large Cable Opening |
| 9 | SDH-9RBL | N/A | |
| 15 | SDH-15RBL | SDH-15RBLL | |
| 25 | SDH-25RBL | SDH-25RBLL | |
| 37 | SDH-37RBL | SDH-37RBLL | |

Latching Blocks for Super D Adapter System

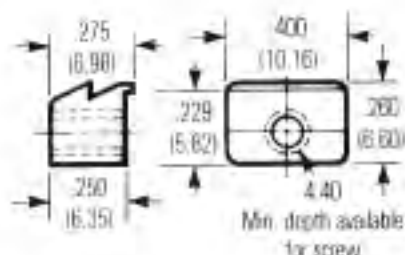

Ordering Information

| Description | For Panel Thickness | Qty per pack | Qty Required Per SDH Hood | Catalog Number |
|--|---------------------|--------------|---------------------------|----------------|
| Latching Block | N/A | 1 each | 2 each | SD-LB |
| Latching Block with SEM Screws | Up to .060" | 2 each | 2 each | SD-LB-060 |
| Removable Mounting Screws for Adapter Hood | N/A | 1 each | 2 each | 4-40UNC2AX3/4 |
| Latching Block with SEM Screws | .060" to .080" | 2 each | 2 each | SD-LB-060-080 |
| Latching Block with SEM Screws | .080" to .125" | 2 each | 2 each | SD-LB-125 |

D-subminiature Backshells - Gray with All-Plastic Connectors SDH Series



- Fits only T Series All-Plastic IDC connector on pages 4-38 thru 4-39.

Straight (180°) Cable Entry Gray Backshells for All-Plastic Connectors

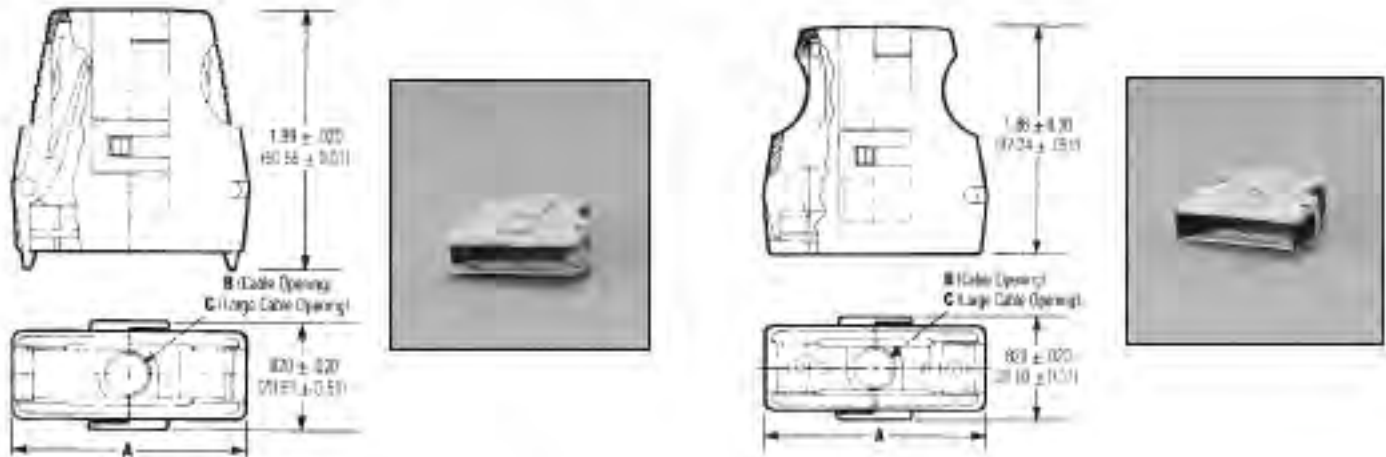

Dimensions

| Positions | A ±.020" (.58mm) | | B ±.020" (.58mm) | | C ±.020" (.58mm) | |
|-----------|------------------|-------|------------------|------|------------------|-------|
| | in | mm | in | mm | in | mm |
| 9 | 1.47 | 37.34 | .31 | 7.87 | — | — |
| 15 | 1.80 | 45.72 | .31 | 7.87 | .41 | 10.41 |
| 25 | 2.35 | 59.69 | .33 | 8.40 | .47 | 11.94 |
| 37 | 2.99 | 75.95 | .37 | 9.40 | .50 | 12.70 |

Ordering Information

Straight (180°) Cable Entry Gray Backshells for All-Plastic Connectors

| Positions | Latches | | Filler Ends | | Filler Ends w/4-40 Screws | |
|-----------|------------------------|---------------------|------------------------|---------------------|---------------------------|---------------------|
| | Standard Cable Opening | Large Cable Opening | Standard Cable Opening | Large Cable Opening | Standard Cable Opening | Large Cable Opening |
| 9 | SDH-9GL | N/A | SDH-9GF | N/A | SDH-9GFCS | N/A |
| 15 | SDH-15GL | SDH-15GLL | SDH-15GF | SDH-15GFL | SDH-15GFCS | SDH-15GFLCS |
| 25 | SDH-25GL | SDH-25GLL | SDH-25GF | SDH-25GFL | SDH-25GFCS | SDH-25GFLCS |
| 37 | SDH-37GL | SDH-37GLL | SDH-37GF | SDH-37GFL | SDH-37GFCS | SDH-37GFLCS |

D-subminiature Backshells - Gray use with All-Plastic Connectors SDH Series



Right-Angle (90°) Cable Entry Gray Backshells for All-Plastic Connectors

- Fits only IDC connectors on pages 4-38 thru 4-39.



Dimensions

| Positions | A $\pm .020^*$ (.58mm) | | B $\pm .020^*$ (.58mm) | | C $\pm .020^*$ (.58mm) | | D $\pm .020^*$ (.58mm) | |
|-----------|------------------------|-------|------------------------|------|------------------------|-------|------------------------|-------|
| | in | mm | in | mm | in | mm | in | mm |
| 9 | 1.94 | 49.21 | .31 | 7.87 | — | — | 1.25 | 31.75 |
| 15 | 2.25 | 57.15 | .31 | 7.87 | .41 | 10.41 | 1.34 | 34.13 |
| 25 | 2.94 | 74.61 | .33 | 8.40 | .47 | 11.94 | 1.50 | 38.10 |
| 37 | 3.59 | 91.28 | .37 | 9.40 | .50 | 12.70 | 1.53 | 38.89 |

Ordering Information

Right-Angle (90°) Cable Entry Gray Backshells for All-Plastic Connectors

| Positions | Latches | |
|-----------|------------------------|---------------------|
| | Standard Cable Opening | Large Cable Opening |
| 9 | SDH-9RGL | N/A |
| 15 | SDH-15RGL | SDH-15RGLL |
| 25 | SDH-25RGL | SDH-25RGLL |
| 37 | SDH-37RGL | SDH-37RGLL |

Ordering Information

Accessories for Gray Backshells

| Positions | Optional Strain Reliefs* | Additional Stay Bands** |
|-----------|--------------------------|-------------------------|
| 9 | SD-WC9 | SD-9-15-SB |
| 15 | SD-WC15 | SD-9-15-SB |
| 25 | SD-WC25 | SD-25-37-SB |
| 37 | SD-WC37 | SD-25-37-SB |

* Two each required per backshell.

** Stay band tool #SD-MSBT required. See page 4-100.



Screw for screwlocking connector assembly - (2 each required): 4-40UNC2AX3/4.

See page 4-85 for latch block drawing.

- **Shell Material:** Zinc-plated low carbon steel with yellow chromate finish.
- **Clamp:** Zinc-plated steel with yellow chromate finish.
- **Screw:** Zinc-plated steel with yellow chromate finish.
- **Stop Nut:** Zinc-plated brass with yellow chromate finish.

Straight Clamp

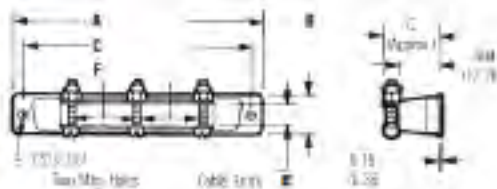

| Shell Size | Positions | A | | B | | C | | E | | F | | G | |
|------------|-----------|-------|-------|------|-------|-------|-------|------|------|------|-------|------|-------|
| | | in | mm | in | mm | in | mm | in | mm | in | mm | in | mm |
| A | 15 | 1.531 | 38.89 | .500 | 12.70 | 1.312 | 33.32 | .296 | 7.52 | .312 | 7.92 | .640 | 16.26 |
| B | 25 | 2.078 | 52.78 | .500 | 12.70 | 1.852 | 47.04 | .296 | 7.52 | .796 | 20.22 | .640 | 16.26 |
| C | 37 | 2.718 | 69.04 | .500 | 12.70 | 2.500 | 63.50 | .296 | 7.52 | .687 | 17.45 | .640 | 16.26 |
| D | 50 | 2.625 | 66.68 | .609 | 15.47 | 2.406 | 61.11 | .390 | 9.91 | .687 | 17.45 | .703 | 17.86 |

Round Clamp

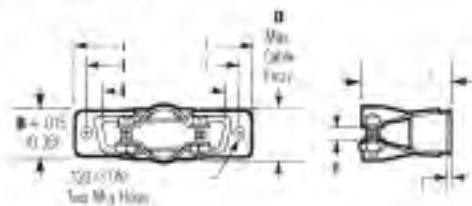

| Shell Size | Positions | A | | B | | C | | D | | E | | F | | G | |
|------------|-----------|-------|-------|------|-------|-------|-------|------|-------|-------|-------|------|------|-------|-------|
| | | in | mm | in | mm | in | mm | in | mm | in | mm | in | mm | in | mm |
| A | 15 | 1.531 | 38.89 | .500 | 12.70 | 1.312 | 33.32 | .406 | 10.31 | .984 | 23.72 | .125 | 3.18 | 1.031 | 26.19 |
| B | 25 | 2.078 | 52.78 | .500 | 12.70 | 1.852 | 47.04 | .593 | 15.06 | 1.515 | 38.48 | .187 | 4.75 | 1.062 | 26.97 |

Right-Angle Clamp

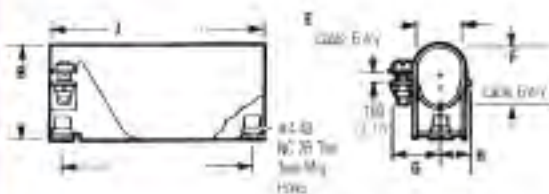

| Shell Size | Positions | A | | B | | C | | E | | F | | G | | H | |
|------------|-----------|-------|-------|-------|-------|-------|-------|------|-------|------|-------|------|-------|------|------|
| | | in | mm | in | mm | in | mm | in | mm | in | mm | in | mm | in | mm |
| E | 9 | 1.203 | 30.56 | 0.718 | 18.24 | .984 | 24.99 | .437 | 11.10 | .437 | 11.10 | .468 | 11.89 | .281 | 7.14 |
| A | 15 | 1.531 | 38.89 | 0.718 | 18.24 | 1.312 | 33.32 | .437 | 11.10 | .437 | 11.10 | .468 | 11.89 | .281 | 7.14 |
| B | 25 | 2.078 | 52.78 | 0.968 | 24.59 | 1.852 | 47.04 | .437 | 11.10 | .625 | 15.88 | .468 | 11.89 | .281 | 7.14 |
| C | 37 | 2.718 | 69.04 | 1.187 | 30.15 | 2.500 | 63.50 | .437 | 11.10 | .812 | 20.62 | .468 | 11.89 | .281 | 7.14 |
| D | 50 | 2.625 | 66.68 | 1.250 | 31.75 | 2.406 | 61.11 | .562 | 14.27 | .906 | 23.01 | .531 | 13.49 | .343 | 8.71 |

D-subminiature Junction Shells



Deep Straight Clamp

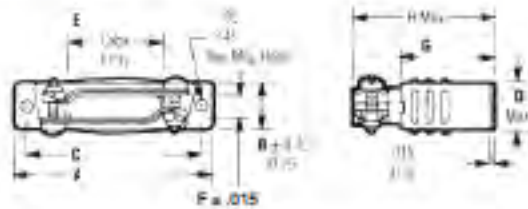

| Shell Size | Positions | A in | A mm | B in | B mm | C in | C mm | D in | D mm | E in | E mm | F in | F mm | G in | G mm | H in | H mm |
|------------|-----------|-------|-------|------|-------|-------|-------|------|-------|-------|-------|------|-------|-------|-------|-------|-------|
| E | 9 | 1.203 | 30.56 | .484 | 12.29 | 0.984 | 24.99 | .578 | 14.68 | .375 | 9.53 | .375 | 9.53 | .750 | 19.05 | 1.219 | 30.96 |
| A | 15 | 1.531 | 38.89 | .484 | 12.29 | 1.312 | 33.32 | .578 | 14.68 | .713 | 18.11 | .312 | 7.92 | .750 | 19.05 | 1.250 | 31.75 |
| B | 25 | 2.078 | 52.78 | .484 | 12.29 | 1.852 | 47.04 | .578 | 14.68 | 1.000 | 25.40 | .312 | 7.92 | 1.000 | 25.40 | 1.531 | 38.89 |
| C | 37 | 2.718 | 69.04 | .484 | 12.29 | 2.500 | 63.50 | .578 | 14.68 | 1.375 | 34.93 | .312 | 7.92 | 1.000 | 25.40 | 1.531 | 38.89 |
| D | 50 | 2.625 | 66.68 | .593 | 15.06 | 2.406 | 61.11 | .667 | 17.45 | 1.406 | 35.71 | .406 | 10.31 | 1.125 | 28.58 | 1.656 | 42.06 |

Switching Shell

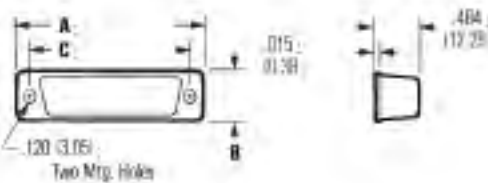

| Shell Size | Positions | A in | A mm | B in | B mm | C in | C mm |
|------------|-----------|-------|-------|------|-------|-------|-------|
| A | 15 | 1.531 | 38.89 | .500 | 12.70 | 1.312 | 33.32 |
| B | 25 | 2.078 | 52.78 | .500 | 12.70 | 1.852 | 47.04 |
| C | 37 | 2.718 | 69.04 | .500 | 12.70 | 2.500 | 63.50 |
| D | 50 | 2.625 | 66.68 | .609 | 15.47 | 2.406 | 61.11 |

Ordering Information

Junction Shells - Metal

| Shell Size | Fits | | | | | |
|------------|------------------|----------------|-------------|-------------------|---------------------|-----------------|
| | Standard Density | Straight Clamp | Round Clamp | Right-Angle Clamp | Deep Straight Clamp | Switching Shell |
| E | 9 | N/A | N/A | DE-19977-5 | DE-24657 | N/A |
| A | 15 | DA-19678-1 | DA-20961 | DA-19977-1 | DA-24658 | DA-19678-6 |
| B | 25 | DB-19678-2 | DB-20962 | DB-19977-2 | DB-24659 | DB-19678-7 |
| C | 37 | DC-19678-3 | N/A | DC-19977-3 | DC-24660 | DC-19678-8 |
| D | 50 | DD-19678-4 | N/A | DD-19977-4 | DD-24661 | DD-19678-9 |

D-subminiature Plastic Hoods

Cinch

Phenolic Hood

Shell Material: Phenolic (black).
#4-40 Screws: Steel with nickel plating.

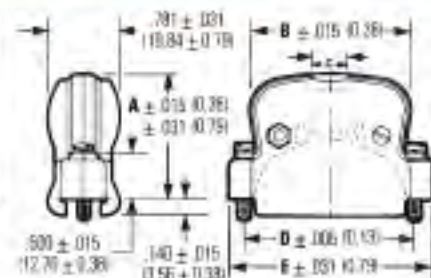

| Shell Size | Positions | A | | B | | C | | D | | E | |
|------------|-----------|-------|-------|-------|-------|------|------|-------|-------|-------|-------|
| | | in | mm | in | mm | in | mm | in | mm | in | mm |
| A | 15 | 1.297 | 32.94 | 1.219 | 30.96 | .268 | 6.76 | 1.312 | 33.32 | 1.641 | 41.68 |
| B | 25 | 1.406 | 35.71 | 1.797 | 45.64 | .328 | 8.33 | 1.852 | 47.04 | 2.203 | 55.96 |

All-Plastic Straight (180°) Hood

Shell Material: Nylon (gray).
#4-40 Screws: Steel with nickel plating.



Connector Not Included

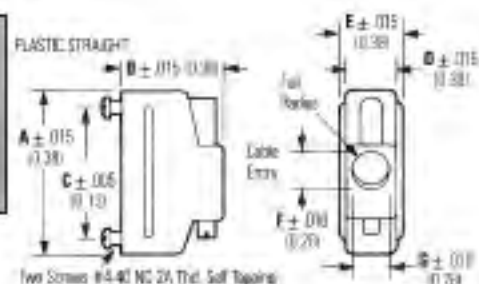

| Shell Size | Positions | A | | B | | C | | D | | E | | F | | G | |
|------------|-----------|-------|-------|-------|-------|-------|-------|------|-------|------|-------|------|-------|------|------|
| | | in | mm | in | mm | in | mm | in | mm | in | mm | in | mm | in | mm |
| E | 9 | 1.218 | 30.94 | 1.000 | 25.40 | .984 | 23.72 | .500 | 12.70 | .562 | 14.27 | .281 | 7.14 | .218 | 7.14 |
| A | 15 | 1.546 | 38.27 | 1.000 | 25.40 | 1.312 | 33.32 | .500 | 12.70 | .562 | 14.27 | .360 | 9.14 | .360 | 9.14 |
| B | 25 | 2.093 | 53.18 | 1.250 | 31.75 | 1.852 | 47.04 | .500 | 12.70 | .562 | 14.27 | .493 | 12.52 | .360 | 9.14 |

All-Plastic Right-Angle (90°) Hood

Shell Material: Nylon (gray).
#4-40 Screws: Steel with nickel plating.



Connector Not Included

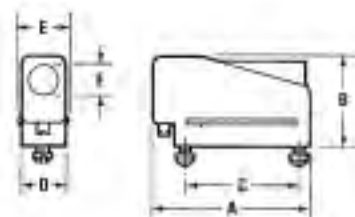

| Shell Size | Positions | A | | B | | C | | D | | E | | F | |
|------------|-----------|-------|-------|-------|-------|-------|-------|------|-------|------|-------|------|------|
| | | in | mm | in | mm | in | mm | in | mm | in | mm | in | mm |
| A | 15 | 1.822 | 46.28 | 1.000 | 25.40 | 1.312 | 33.32 | .500 | 12.70 | .562 | 14.28 | .360 | 9.14 |
| B | 25 | 2.368 | 60.15 | 1.250 | 31.75 | 1.852 | 47.04 | .500 | 12.70 | .562 | 14.28 | .360 | 9.14 |

Ordering Information

Plastic Hoods

| Shell Size | Standard Density | Phenolic Hood | Straight Hood | Right Angle |
|------------|------------------|---------------|---------------|-------------|
| E | 9 | N/A | DE-51218-1 | N/A |
| A | 15 | DA-51225-1 | DA-51210-1 | DA-51211-1 |
| B | 25 | DB-51226-1A | DB-51212-1 | DB-51213-1 |
| C | 37 | N/A | N/A | N/A |
| D | 50 | N/A | N/A | N/A |

Dust Caps

- For use with all Cinch D-subminiature connectors.
- Used to protect connector contacts when connector is not mated.
- Made of polyethylene (black).

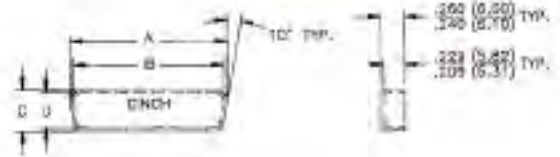

Ordering Information

| Fits Shell Size | Fits Standard Density | Catalog No. | Description | A | | B | | C | | D | |
|-----------------|-----------------------|-------------|-------------|-------|-------|-------|-------|------|-------|------|-------|
| | | | | in | mm | in | mm | in | mm | in | mm |
| E | 9 | DE-59-20 | Socket | .694 | 17.63 | .627 | 15.93 | .362 | 9.19 | .295 | 7.49 |
| E | 9 | DE-60-20 | Plug | .749 | 19.02 | .692 | 17.32 | .412 | 10.46 | .345 | 8.76 |
| A | 15 | DA-59-20 | Socket | 1.022 | 25.95 | .955 | 24.25 | .362 | 9.19 | .295 | 7.49 |
| A | 15 | DA-60-20 | Plug | 1.077 | 27.36 | 1.010 | 25.65 | .412 | 10.46 | .345 | 8.76 |
| B | 25 | DB-59-20 | Socket | 1.562 | 39.67 | 1.495 | 37.97 | .362 | 9.19 | .295 | 7.49 |
| B | 25 | DB-60-20 | Plug | 1.635 | 41.52 | 1.568 | 39.83 | .430 | 10.92 | .363 | 9.22 |
| C | 37 | DC-59-20 | Socket | 2.210 | 56.13 | 2.143 | 54.43 | .362 | 9.19 | .295 | 7.49 |
| C | 37 | DC-60-20 | Plug | 2.283 | 57.99 | 2.216 | 56.29 | .430 | 10.92 | .363 | 9.22 |
| D | 50 | DD-59-20 | Socket | 2.116 | 53.75 | 2.049 | 52.04 | .474 | 12.04 | .407 | 10.34 |
| D | 50 | DD-60-20 | Plug | 2.179 | 55.35 | 2.112 | 53.64 | .538 | 13.61 | .469 | 11.91 |

Guide Pin Plates

- Aligns connectors before actual mating. Generally used in blind mate applications.
- Male or female guide plates will accommodate Cinch male or female connectors.
- Plate: Cold-rolled steel with cadmium plating and yellow chromate finish.
- Guide pin (male): Stainless steel, passivated.
- Screws, rivets (male plate), washers (male plate): Steel with cadmium plating and yellow chromate finish.

Plug

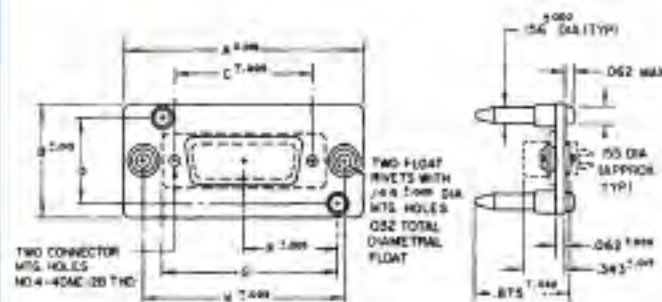

Socket

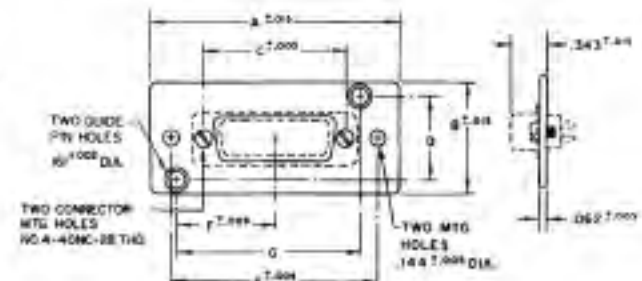

Ordering Information

| Fits Shell Size | Fits Standard Density | Plug | Socket | A | | B | | C | | D | | F | | G | | K | |
|-----------------|-----------------------|----------|----------|-------|-------|-------|-------|-------|--------|------|-------|-------|-------|-------|-------|-------|-------|
| | | | | in | mm | in | mm | in | mm | in | mm | in | mm | in | mm | in | mm |
| E | 9 | N/A | N/A | | | | | | | | | | | | | | |
| A | 15 | DA-22213 | DA-22214 | 2.281 | 57.93 | 1.000 | 25.40 | 1.312 | 33.32 | .750 | 19.05 | .898 | 22.81 | 1.603 | 42.24 | 1.906 | 48.41 |
| B | 25 | DB-22255 | DB-22254 | 2.820 | 71.63 | 1.000 | 25.40 | 1.852 | 47.04 | .750 | 19.05 | 1.168 | 29.67 | 2.203 | 55.96 | 2.446 | 62.13 |
| C | 37 | DC-22070 | DC-22071 | 3.468 | 88.09 | 1.000 | 25.40 | 2.500 | 63.50 | .750 | 19.05 | 1.492 | 37.90 | 2.851 | 72.42 | 3.094 | 78.59 |
| D | 50 | DD-21962 | DD-21961 | 3.375 | 85.73 | 1.125 | 28.58 | 2.406 | 61.112 | .874 | 21.88 | 1.437 | 36.50 | 2.749 | 69.82 | 3.000 | 76.20 |

Slide Lock Assemblies

- A slide lock assembly is a metal bracket offered with hardware necessary to mount into the standard connector mounting holes. It consists of the lock retainer plate, two screws, two washers, and two nuts. Two lock posts are required to fit into the mounting holes of the mating connector. These must be ordered separately.
- Compatible with all Cinch Backshells, Hoods, and Junction Shells except D*H Series, SDH Series, and phenolic hood.
- Compatible with all Cinch metal shell D-subminiature connectors.

Materials

- Slide Lock Plate: Stainless steel, passivated.
- Slide lock hex nut, washer #4-40 screw: Steel with zinc plating and yellow chromate finish.
- Lockpost, washer, lockwasher, and hex nut: Steel with zinc plating and yellow chromate finish.

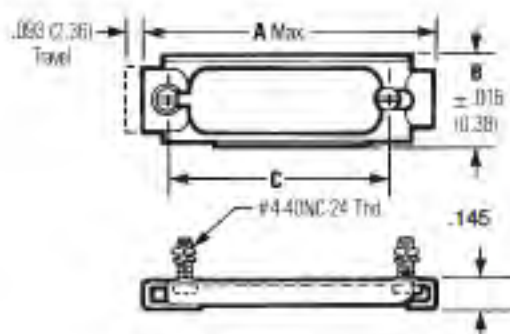

Consists of Lock Retainer and two lock posts (order separately).
NOTE: Not compatible with D*H Series or SDH Series backshells.

Ordering Information

| Shell Size | Fits Standard Density | Lock Retainer | A | | B | | C | |
|------------|-----------------------|---------------|-------|-------|------|-------|-------|-------|
| | | | in | mm | in | mm | in | mm |
| E | 9 | DE-51224-1 | 1.442 | 36.63 | .500 | 12.70 | 0.984 | 24.99 |
| A | 15 | DA-51220-1 | 1.770 | 44.96 | .500 | 12.70 | 1.312 | 33.27 |
| B | 25 | DB-51221-1 | 2.293 | 58.24 | .500 | 12.70 | 1.852 | 47.04 |
| C | 37 | DC-51222-1 | 2.958 | 75.13 | .500 | 12.70 | 2.500 | 63.50 |
| D | 50 | DD-51223-1 | 2.847 | 72.31 | .609 | 15.47 | 2.406 | 62.48 |

Lock Post: #D53018. Two (2) required with each Slide Lock Assembly.

Screwlocks

- Screwlocks are designed to retain the same size mated connectors together or to secure the connector to a rack/panel. Screwlocks may be used on plugs or sockets.
- Female screwlocks consist of one #4-40 screw with a #4-40 hole in the top, two flat washers to accommodate different panel thicknesses, one lockwasher, and one #4-40 nut. Military female screwlocks include three flat washers.
- Male screwlocks consist of one #4-40 slotted screw and a spring tension clip. Different sizes accommodate the various connector flange sizes and types of backshells or hoods (if applicable).
- Two screwlocks are required per connector.
- Military screwlocks meet all requirements of MIL-C-24308.

Materials

Commercial Screwlock Assemblies:

- Male Screwlock Assembly: Clip and screw are steel with zinc plating and yellow chromate finish.
- Female Screwlock Assembly: Washers (2), lockwashers, hex nuts, and nuts are steel with zinc plating and yellow chromate finish.

M24308 Military Screwlock Assemblies:

- Male Screwlock Assembly: Clip and screw are steel with cadmium plating and yellow chromate finish.
- Female Screwlock Assembly: Washers (3), lockwashers, hex nuts, and nuts are steel with cadmium plating and yellow chromate finish.



Female Screwlock



Male Screwlock

- Screwlock assemblies will not fit D*H or SDH Series backshells.

Male Screwlocks



Ordering Information

| Shell Size Positions | A | | B | | E | A | B | C | D |
|------------------------------|--------------|-------|-------|------|-----|-----|------|------|------|
| | in | mm | in | mm | 9 | 15 | 25 | 37 | 50 |
| Commercial: | | | | | | | | | |
| D20419-0 | 0.250 | 56.35 | 0.033 | 0.84 | P/S | P/S | S | S | |
| D20419-16 | 0.250 | 56.35 | 0.048 | 1.22 | S* | S* | P/S* | P/S* | |
| D20419-21 | 0.281 | 63.34 | 0.059 | 1.50 | | P* | P* | | |
| D20420-0 | 0.250 | 56.35 | 0.033 | 0.84 | | | | | S |
| D20420-12 | 0.281 | 63.34 | 0.048 | 1.22 | | | | | P/S* |
| D20420-15 | 0.281 | 63.34 | 0.059 | 1.50 | | | | | P* |
| Military MIL-C-24308: | | | | | | | | | |
| M24308/25-9F | Per MIL spec | | | | P/S | P/S | P/S | P/S | |
| M24308/25-10F | Per MIL spec | | | | | | | | P/S |

NOTE: P = Plug, S = Socket
* Indicates use with junction shell

Female Screwlocks

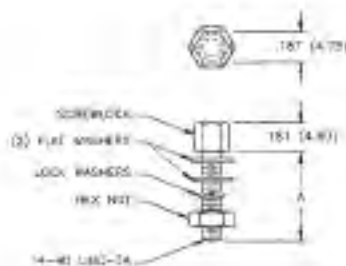

Ordering Information

| Shell Size Positions | A | | E | A | B | C | D |
|------------------------------|--------------|--------|-----|-----|-----|-----|-----|
| | in | mm | 9 | 15 | 25 | 37 | 50 |
| Commercial: | | | | | | | |
| D20418-2 | 0.312 | 70.32 | P/S | P/S | P/S | P/S | P/S |
| D20418-39 | 0.628 | 141.55 | P/S | P/S | P/S | P/S | P/S |
| Military MIL-C-24308: | | | | | | | |
| M24308/26-1F | Per MIL spec | | P/S | P/S | P/S | P/S | P/S |
| M24308/26-2F | Per MIL spec | | P/S | P/S | P/S | P/S | P/S |

NOTE: P = Plug, S = Socket

Auto-Clinch™ D Semi-Automatic Termination Tool

Auto Clinch D is a semi-automatic, pneumatically powered, and electrically controlled termination machine designed to terminate IDC D-subminiature connectors. It employs a selective programmer and a common nest for all four connector sizes and can be equipped to terminate metal shell connectors. It can also be optionally equipped with remote visual color code display for training sequences. It has a provision for omission of wires.

Part No.: ACD-432

**Auto-Clinch D Tool****Certi-Clinch™ D Field Termination Tool**

*For 24-26 AWG Wire

Certi-Clinch D is designed for mass termination of individual wires, eliminating wire stripping, soldering, and crimping. It handles all four connector sizes, is readily portable, and requires no set-up time and little operator time. Rugged, all-metal construction affords trouble-free long life.

For metal shell IDC D-subminiature connectors.

Part No. SD-CCWN

For all-plastic IDC D-subminiature connectors.

Part No. SD-CC

Conversion nest for converting all-plastic type to metal shell.

Part No. SD-CCN

**Certi-Clinch D Field Termination Tool****Uni-Clinch™ D Single-Wire Hand Insertion Tool**

Designed to insert one 22-26 AWG wire at a time, Uni-Clinch D is used as a field repair tool by field service engineers.

Part No. SD-UC

**Uni-Clinch Hand Insertion Tool****Super D™ Manual Stay Band Tool**

Designed for applying the steel stay band/strain relief to the cable before termination of wires to the connector, the manual Stay Band Tool applies both stay band sizes to the full range of cable sizes.

Part No. SD-MSBT

**Manual Tool**

NOTE: All termination tools on this page are used in conjunction with T[®] Series D-subminiature connectors.

Hand Crimping Tool for Stamped Contact 300 PC Reels

Two types of transport for connector chains are available with crimping ranges of 20 through 30 AWG for B crimpings

| | Part Number |
|--------------------------------------|-------------|
| D*A Series 20 through 26 AWG Wire | GHC-B |
| D*A Series 28 through 30 AWG Wire | GHC-B1 |
| HTD Series | HTD-266 |



Contact Crimp Hand Tool
(300 Contact Reel)

Hand Crimping Tool for Loose Stamped Contacts

| | Part Number |
|------------|-------------|
| D*A Series | HTD-544 |
| D*U Series | BT-20-HC |
| HTD Series | HTD-544 |



Contact Crimp Hand Tool
(HTD-544)

Contact Insertion/Extraction Tool for Stamped Contacts

| | Part Number |
|------------|-------------|
| D*A Series | CIET-20-HDB |
| D*U Series | CIET-20-HDB |
| HTD Series | CIET-22-DF |



Contact Crimp Hand Tool
(BT-20-HC)



Contact Insertion/Extraction Hand Tool
For D*A and D*U Series for Stamped
Contacts
(CIET-20-HDB)



Contact Insertion/Extraction Hand Tool
For D1/2 Contacts
(CIET-22-DF)

Semi-Automatic Stripping and Crimping Tool

Advantages and Characteristics

- Stripping and crimping in one easy operation
- Easy to install and adjust
- Requires little maintenance
- Wearing parts replaced in a matter of minutes
- Long service life thanks to best-quality materials
- Different quick change applicators in the same stripper crimper
- Increased productivity



Our GSC-20-30 crimp machine in operation with stripper crimper and quick change tool

Ordering Information

Stripper Crimper

| Description | Part Number | Comments | Catalog Number |
|--|---------------|---|----------------|
| D'A Series Stripper Crimper Only | 599-11-11-578 | Comes equipped with the applicator for 20-24 AWG contacts | GSC-20-30 |
| D'A Series Applicator Only For 20-24 AWG | 598-98-97-630 | Applicator only For 20-24 AWG contacts | ASC-20-24 |
| D'A Series Applicator Only For 26-30 AWG | 598-98-97-632 | Applicator only For 26-30 AWG contacts | ASC-26-30 |
| HTD Series Stripper Crimper Only | 599-11-11-518 | Comes equipped with applicator for 22-28 AWG contacts | HTD-518 |
| HTD Series Applicator Only 22-28 AWG | 598-98-97-636 | Applicator only For 22-28 AWG contacts | ASC-DH |
| D'U Series Stripper Crimper Only | 599-11-11-258 | Comes equipped with applicator for 20-28 AWG contacts | ESC-20-3 |
| D'U Series Applicator Only 20-28 | 598-98-97-638 | Applicator only For 20-28 AWG contacts | ASC-DU |

Stripper Crimper Spare Parts

| Part Number | Description | Catalog Number |
|---------------|-------------------------------------|----------------|
| 598-98-97-631 | D'A Punch & Anvil Kit 20-24 AWG | SCPA-631 |
| 598-98-97-633 | D'A Punch & Anvil Kit 26-30 AWG | SCPA-633 |
| 598-98-97-637 | HTD Series Punch & Anvil Kit | SCPA-637 |
| 598-98-97-639 | D'U Series Punch & Anvil Kit | SCPA-639 |
| 598-98-97-640 | Stripping Blades for 20-24 AWG Wire | SCSB-640 |
| 598-98-97-641 | Stripping Blades for 26-30 AWG Wire | SCSB-641 |
| 598-98-97-642 | D'A Series Contact shear blade | SCCS-642 |
| 598-98-97-643 | Shear blade holder | SCSH-643 |
| 598-98-97-644 | Sensor switch | SCSS-644 |
| 598-98-97-645 | Strip blade holder | SCBH-645 |



M22520/2-01

Metal Shell High-Reliability Crimp and Poke Termination Tool

Hand crimping tool for high-reliability machined D⁹U, Series 3, and M24308 Crimp and Poke contacts.
M22520/2-01

NOTE: Positioner required with crimping tool

Positioner—A device when attached to a crimping tool that locates the contact in the correct position.

Positioner for machined contacts
D⁹U Series Positioner
Part No.: 599-11-11-580
Catalog No.: EP-580
Series 3 and M24308 Connector Positioner
Part No.: 598-98-97-618
Catalog No.: M22520/2-08



CIET-20-HD

Metal Shell Military Crimp and Poke Insertion/Extraction Tool

For inserting or extracting machined D⁹U, Series 3, or M24308 Crimp and Poke contacts.
Part No.: CIET-20-HD



CET-20-11

Military Extraction Tip Only

For extracting high-reliability machined D⁹U, Series 3, or M24308 Crimp and Poke contacts.
Part No.: CET-20-11



CET-C6B

Coaxial and High-Voltage Contact Extraction Tool

For extracting co-axial and high-voltage contacts from metal shell high-reliability connectors.
Part No.: CET-C6B



FCT-551

Pneumatic Bench Top Press for Crimping Ferrules

This lightweight, portable press is used to crimp the ferrules on the overmold shielding hardware kits. Crimp dies ordered separately.

Part No.: 599-11-11-551
Catalog No.: FCT-551



FCT-552

Hand Tool for Crimping Ferrules and Coax Contacts

Uses same crimp dies as pneumatic tool.
Part No.: 599-11-11-552
Catalog No.: FCT-552

Crimp Ferrule

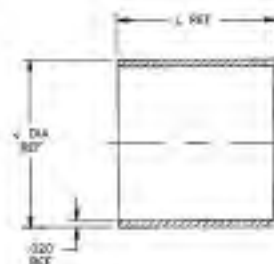

| Catalog Number | Part Number | Type | Crimp Die Part No. | Crimp Die Catalog No. |
|----------------|---------------|------|--------------------|-----------------------|
| CF-51 | 482-44-22-451 | 1 | 598-98-97-607 | CD-07 |
| CF-42 | 482-44-22-442 | 1 | 598-98-97-600 | CD-00 |
| CF-43 | 482-44-22-443 | 1 | 598-98-97-601 | CD-01 |
| CF-44 | 482-44-22-444 | 1 | 598-98-97-602 | CD-02 |
| CF-45 | 482-44-22-445 | 1 | 598-98-97-603 | CD-03 |
| CF-46 | 482-44-22-446 | 1 | 598-98-97-604 | CD-04 |
| CF-47 | 482-44-22-447 | 2 | 598-98-97-605 | CD-05 |
| CF-50 | 482-44-22-450 | 2 | 598-98-97-606 | CD-06 |

X-ON Electronics

Largest Supplier of Electrical and Electronic Components

Click to view similar products for [D-Sub Standard Connectors](#) category:

Click to view products by [Bel Fuse](#) manufacturer:

Other Similar products are found below :

[LV242999-142T12](#) [015-0341-000](#) [015-0349-000](#) [015-0350-000](#) [015-8544-011](#) [015-8755-001](#) [017041-0005](#) [020419-0104](#) [020745-0008](#) [609-25P](#) [609-9P](#) [M243084305F](#) [CT0-24-10SC](#) [CT0E20-8PS](#) [CT0F16S-1PS](#) [CT0F16S-1SC](#) [CT0TA16-11SXCA232](#) [CT0U22-14PSA206F127](#) [CT1F22-14PC-G9](#) [CT1FC22-2PC](#) [CT2-10SL-3SC](#) [CT2-14S-2PCA34](#) [CT2-18-11PCAU](#) [CT2-22-19SC](#) [CT2-24-28PSF127A206](#) [CT2-28-12SC](#) [CT2-28-12SCA232](#) [CT2-28-12SSA232](#) [CT6-10SL-3SC](#) [CT6-10SL-4SC](#) [CT6-14S-2SC](#) [CT6-16-12SC](#) [CT6-18-10SSF127A206](#) [CT6A16S-5PC](#) [CT6E14S-5SC](#) [CT6E14SA7SC](#) [CT6E22-14PC](#) [CT6E22-14PS](#) [CT6E22-19PS](#) [CT6E22-22PS](#) [CT6E24-10SC](#) [CT6F14S-5SC](#) [CT6F16-10SWC](#) [CT6F16S-1SC](#) [CT6FA10SL-4PS](#) [CT6M16S-5PS](#) [CT6M20-19SS](#) [6STD15PCM99B70X](#) [6STD15SCT99S40X](#) [6STF09PCM05B70X](#)