

# Plug

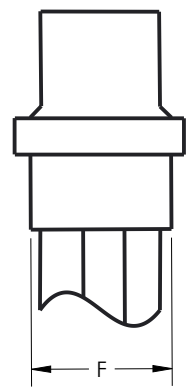

Wire Terminated

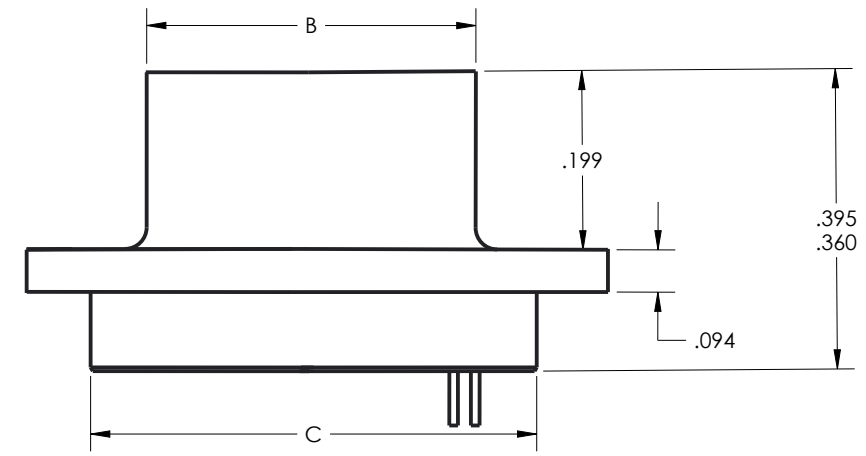
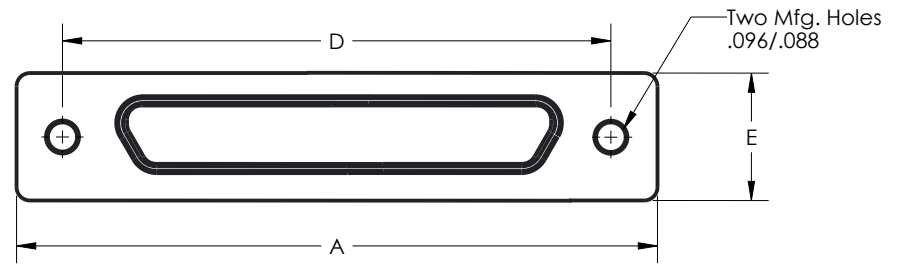
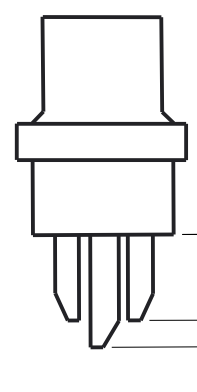

Solder Cup

# Socket

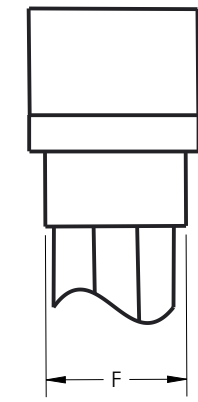
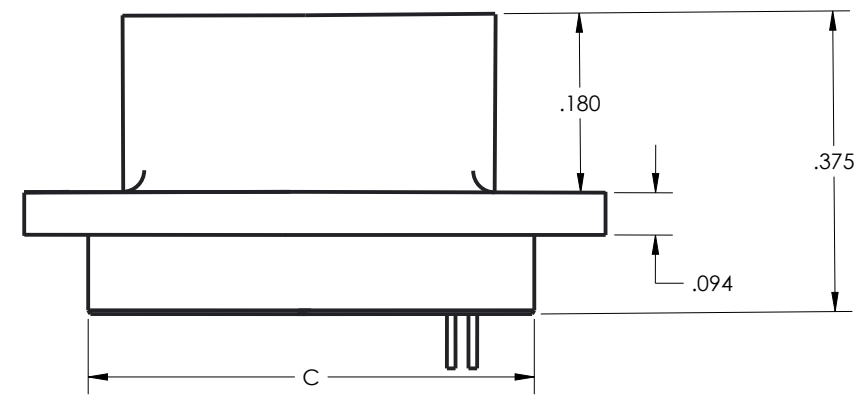
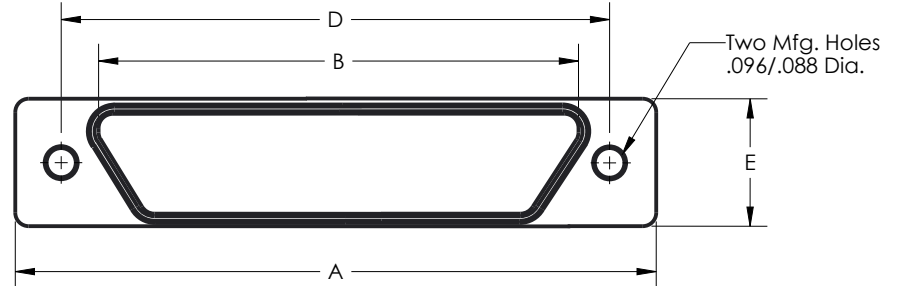

Wire Terminated

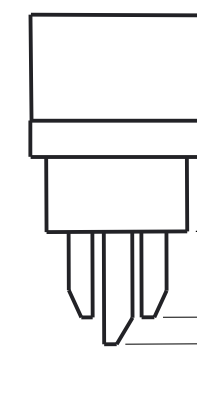

Solder Cup

## DRAWING REVISIONS (RELEASE DATE ON FILE)

REV	DOCUMENT	APP	APPROVAL DATE
1	CCS XXXXX	JW	ON FILE

NO. OF CONTACTS	A ± .010"	B MAX. (Plug) Min. (Socket)	C +.010" -.018"	D ±.005"	E ± .010"	F Max.
9 Plug	.778	.292	.398	.565	.208	.173
9 Socket	.778	.292	.398	.565	.208	.173
15 Plug	.928	.442	.548	.715	.208	.173
15 Socket	.928	.442	.548	.715	.208	.173
21 Plug	1.078	.592	.698	.865	.208	.173
21 Socket	1.078	.592	.698	.865	.208	.173
25 Plug	1.178	.692	.798	.965	.208	.173
25 Socket	1.178	.692	.798	.965	.208	.173
31 Plug	1.328	.842	.948	1.115	.208	.173
31 Socket	1.328	.842	.948	1.115	.208	.173
37 Plug	1.478	.992	1.098	1.265	.208	.173
37 Socket	1.478	.992	1.098	1.265	.208	.173
51 Plug	1.428	.942	1.048	1.215	.250	.220
51 Socket	1.428	.942	1.048	1.215	.250	.220

UNITS <b>ENGLISH INCHES</b>	DESIGN ENGINEER <b>J. WARRAICH</b>	DATE <b>3/14/22</b>	TITLE <b>DURA-CON ALL PLASTIC MICRO-D, SOLDER CUP AND WIRE TERMINATED</b>
CATALOG DRAWING UNLESS OTHERWISE SPECIFIED: ALL DIMENSIONS ARE IN INCHES		PRO/E APPROVALS ON FILE	MATERIAL CONTROL SPEC NUMBER MATERIAL SPEC NUMBER FINISH PROJECT NUMBER
CONFIDENTIAL THIS DOCUMENT IS THE PROPERTY OF CINCH. NEITHER THIS DOCUMENT NOR ANY OF THE INFORMATION CONTAINED IN IT MAY BE DUPLICATED OR DISCLOSED WITHOUT PRIOR WRITTEN CONSENT OF CINCH. ©COPYRIGHT 2009 CINCH		CAD FILE NUMBER <b>DCDAXXXX</b> CAGE IDENT NO. <b>71785</b>	DRAWING NUMBER <b>DCDAXXXX</b> SCALE NONE SHEET 1 OF 2

8

7

6

5

4

3

2

1

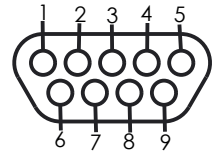

9 CONTACTS

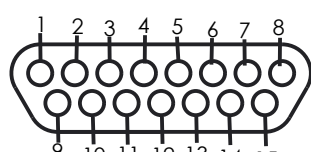

15 CONTACTS

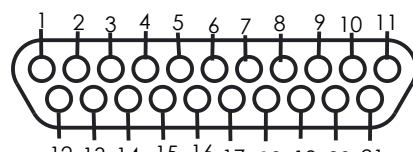

21 CONTACTS

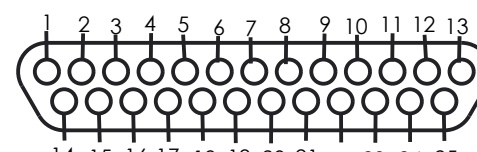

25 CONTACTS

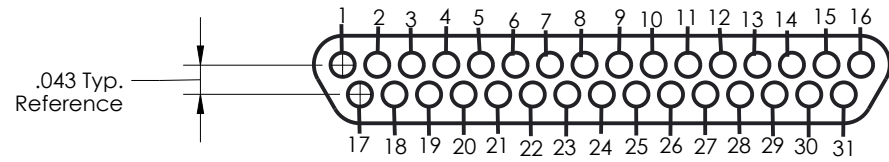

31 CONTACTS

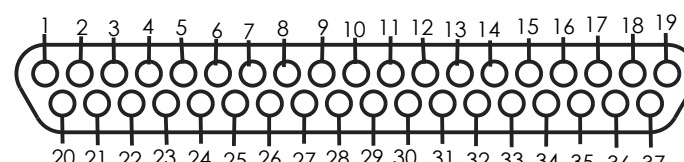

37 CONTACTS

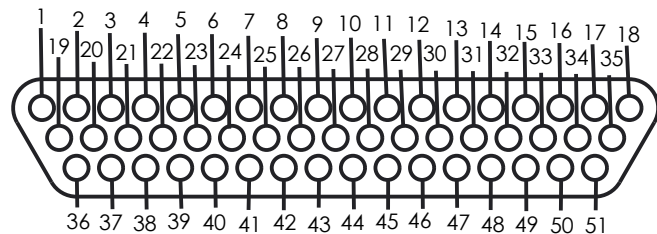

51 CONTACTS

**PRODUCT OPTIONS**

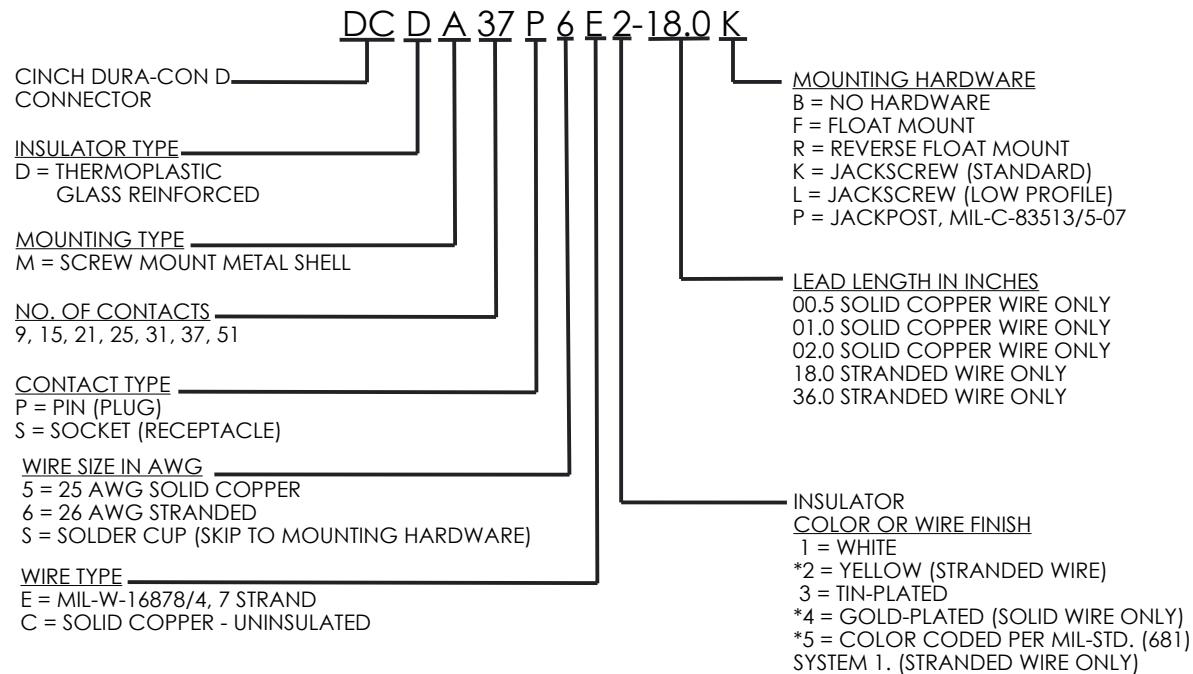

\* FOR OTHER OPTIONS, CONSULT FACTORY

UNITS <b>ENGLISH INCHES</b>		<b>CINCH</b>		1700 FINLEY RD LOMBARD, IL. 60148	
CATALOG DRAWING		TITLE DURA-CON ALL PLASTIC MICRO-D, SOLDER CUP AND WIRE TERMINATED			
UNLESS OTHERWISE SPECIFIED: ALL DIMENSIONS ARE IN INCHES		<b>PRO/E DRAWING</b>			
CONFIDENTIAL THIS DOCUMENT IS THE PROPERTY OF CINCH. NEITHER THIS DOCUMENT NOR ANY OF THE INFORMATION CONTAINED IN IT MAY BE DUPLICATED OR DISCLOSED WITHOUT PRIOR WRITTEN CONSENT OF CINCH. ©COPYRIGHT 2009 CINCH		CAD FILE NUMBER DCDAXXXX	DRAWING NUMBER DCDAXXXX	SCALE NONE	REV 1
CAGE IDENT NO. 71785	SIZE B	SHEET 2 OF 2			

8

7

6

5

4

3

2

1

## X-ON Electronics

Largest Supplier of Electrical and Electronic Components

*Click to view similar products for [D-Sub MIL Spec Connectors](#) category:*

*Click to view products by [Bel Fuse](#) manufacturer:*

Other Similar products are found below :

[M85049/50-5F](#) [MDM-15PH006M7-A174](#) [MDM-15SH001M7-A174](#) [MDM-15SH003M7-A174](#) [MDM-15SH006M7-A174](#) [MDM-21PH046F](#)  
[MDM-21SH006B-A174](#) [MDM-21SH006P-A174](#) [MDM-21SH011P](#) [MDM-21SH011P-A174](#) [MDM-21SH034B-A174](#) [MDM25SL61P](#) [850-](#)  
[056-0812](#) [1218697-4](#) [DA-59-20](#) [1484349-1](#) [17D25HV](#) [1996840-1](#) [243082-15](#) [308-CP3C1001-076](#) [1757682-1](#) [17D-E51218-1](#) [17SDA15S](#)  
[1883533-1](#) [1883889-1](#) [192900-0377](#) [308-CP6P0441-024H](#) [M83513/03-E09C](#) [443961-3](#) [MDM-15PH001F](#) [MDM-15PH001P-A174](#) [MDM-](#)  
[15PH011P](#) [MDM-15PH011P-A174](#) [MDM-15SH006M7](#) [MDM-15SH011F-A174](#) [MDM-15SH011P](#) [MDM-15SH011P-A174](#) [MDM-](#)  
[21PH006M7](#) [MDM-21PH041F](#) [MDM-21PH048F](#) [MDM-21SH003K-F222](#) [MDM-21SH046B-A174](#) [MDM-25PH001M7-A174](#) [MDM-](#)  
[25SH011P](#) [MDM-9SH001F](#) [MDM-9SH006P-A174](#) [5-1218949-1](#) [550-031NF1R6K](#) [3-1236089-2](#) [550E001NF1R3J0L](#)