

High Temperature "DCHM" Dura-Con[™] Micro-D Plug Connectors

Plug Connector Technology

Cinch has teamed our proven twist pin technology with these custom designed insulators capable of meeting the extreme mechanical and electrical needs in the harshest environments of military/aerospace and industrial applications such as Down Hole Directional Drilling.

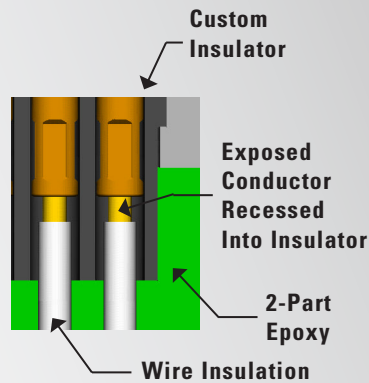

Cinch's unique plug insulators are designed to provide increased electrical protection between contact cavities preventing any potential shorts due to exposed wire or epoxy voids. Comprised of LCP material these connectors offer superior performance and long life in severe environments.

Product Offerings

- Full harnessing capabilities ranging from simple point-point to complex with many branches
- Custom configurations and modifications available to fit unique packaging and design requirements

Cinch's Twist Pin Advantage

- Combine the twist pin performance with increased temperature range
- BeCu wire strands provide seven points of electrical contact
- Achieve high mating cycles and better resistance to shock and vibration
- Approved system applications (Aerospace, Defense and Geo-Thermal)
- Qualified and approved to Mil-DTL-83513



Detail of Dura-Con[™] Twist Pin

Contact Arrangements

(Face View)

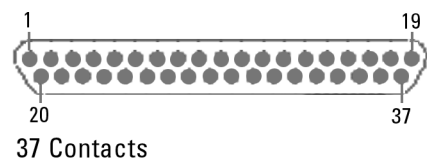
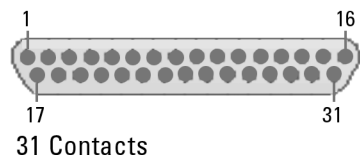
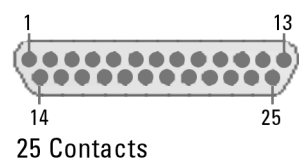
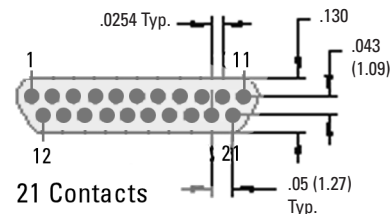
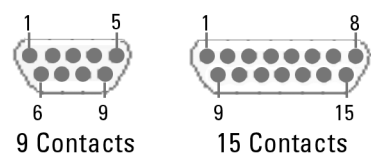

Shell Dimensions

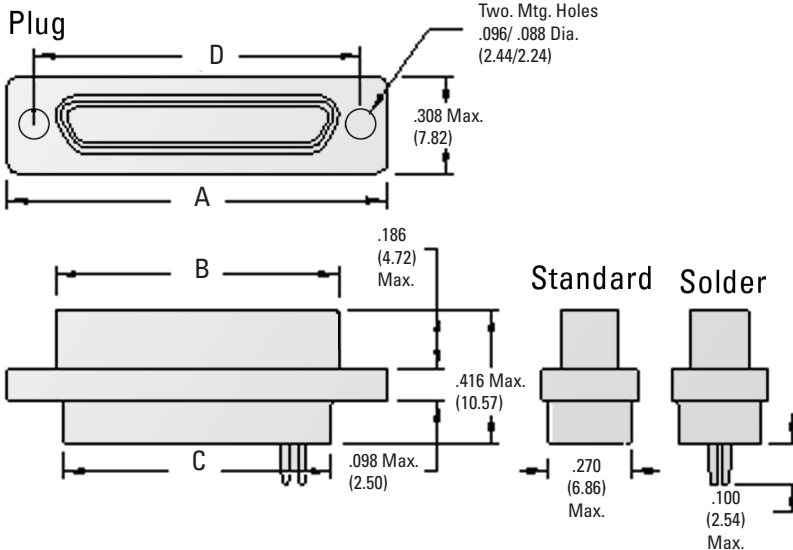

No. of Contacts	A Max.		B Max.		C Max.		D Nominal	
	In.	mm.	in.	mm.	in.	mm.	in.	mm.
9 Plug	0.785	19.94	0.334	8.48	0.400	10.16	0.565	14.35
15 Plug	0.935	23.74	0.484	12.29	0.550	13.97	0.715	18.16
21 Plug	1.085	27.56	0.634	16.10	0.700	17.78	0.865	21.97
25 plug	1.185	30.10	0.734	18.64	0.800	20.32	0.965	24.51
31 Plug	1.335	33.97	0.884	22.45	0.950	24.13	1.115	28.32
37 Plug	1.485	37.72	1.034	26.26	1.100	27.94	1.265	32.13

How to Order

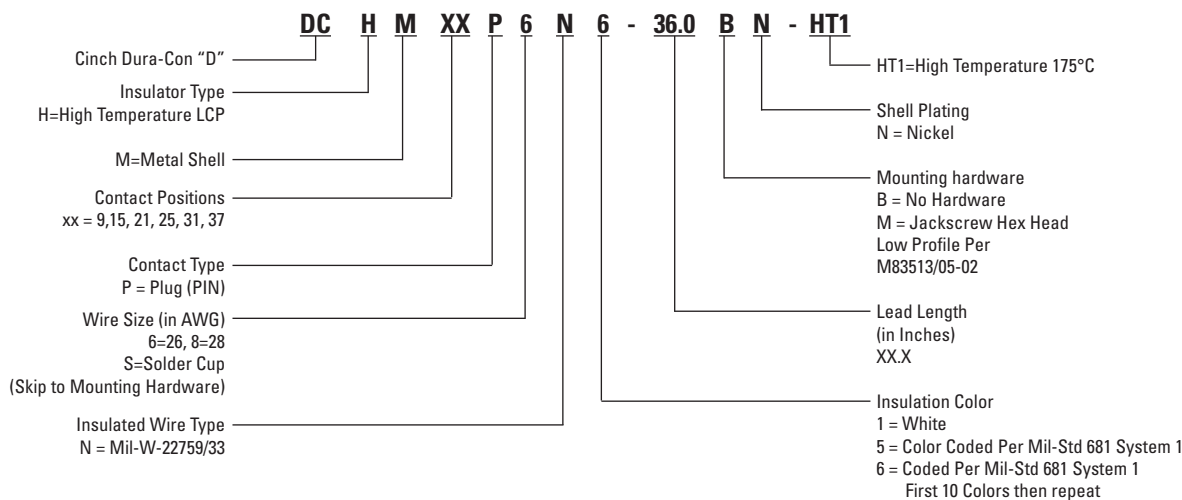

Performance Characteristics

Operating Temperature	-40°C to 175°C (-40°F to 347°F)
Shock	50 G's per MIL-STD-1344, Method 2004, Condition E (EIA-364-27, Condition E)
Vibration	20 G's per MIL-STD-1344, Method 2005, Condition IV (EIA-364-28, Condition IV)
Sizes	9, 15, 21, 25, 31 and 37. Please consult factory for larger sizes.

X-ON Electronics

Largest Supplier of Electrical and Electronic Components

Click to view similar products for [D-Sub Micro-D Connectors](#) category:

Click to view products by [Bel Fuse](#) manufacturer:

Other Similar products are found below :

[M243082311F](#) [M2430834F](#) [M24308/4-6F](#) [65-1920-15](#) [M83513/01-HN](#) [M83513/03-A10N](#) [M83513/03-B14C](#) [M83513/03-D09C](#) [M83513/03-D11N](#) [M83513/03-G02N](#) [M83513/03-G05N](#) [M83513/03-G08C](#) [M83513/03-G09N](#) [M83513/03-G12N](#) [M83513/03-H13N](#) [M83513/04-E15N](#) [M83513/04-G04C](#) [M83513/10-E01NP](#) [M83513/13-B01NP](#) [M83513/13-C01NN](#) [M83513/16-A01CP](#) [M83513/22-D01NP](#) [M83513/25-B01NP](#) [6R2004A30F015](#) [6R4006A28A120](#) [703006A13F060](#) [704002A03F200](#) [705001A13F120](#) [7-1532020-5](#) [748567-1-P](#) [MDB1-31SH003](#) [MDM-15PBS-L58](#) [MDM-15PCBRM7T](#) [MDM-15PH003B-A174](#) [75-068624-59S](#) [MDM-15PH034B](#) [MDM-15SH001L](#) [MDM-15SH004B](#) [MDM-21PH003K](#) [MDM-25PH003B-A174](#) [MDM-25PHW01F-A174](#) [MDM-37PH006L-A174](#) [MDM-37PH048M5-A174](#) [MDM-37SCBRP-A174](#) [MDM-51PBS-L56](#) [MDM-51PSF](#) [MDM-51SH003M7](#) [MDM-51SSM7-A174](#) [MDM-9PBSP-L58](#) [MDM-9PH003M7](#)