

# DP7130G

## 30A DC-DC Intelligent dPOL

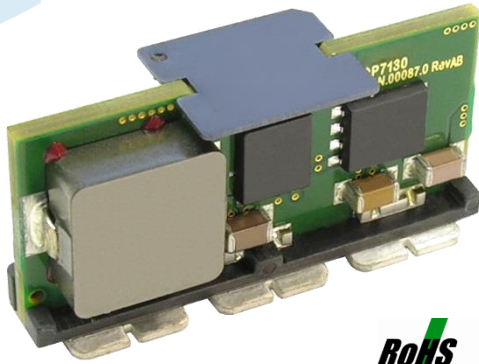

### Key Features & Benefits

- Input voltage range: 8 V–14 V
- Output voltage range: 0.7 V–3.6 V at 0 – 30 A
- Programmable dynamic output voltage positioning for better load transient response
- 500 KHz switching for high efficiency
- Flexible Fault Response features
- Multiple turn-on/off slew rates and delays
- Digital Filter Compensation
- Synchronous operation with other supplies
- Real time performance monitoring
- GUI based configuration for short development time
- Small footprint SMT package: 8 x 32 x15 mm
- Approved to the latest edition and amendment of ITE Safety standards, UL/CSA 60950-1 and IEC60950-1

Bel Power Solutions **DP7130G** is an intelligent, fully programmable step-down point-of-load DC-DC converter integrating digital power conversion and intelligent power management. It works with the DM7300 Series Digital Power Managers (DPM) which provides for synchronizing all system Power-On-Load regulators, for an elegant, flexible, low noise power system solution.

All key parameters, sequencing, tracking, fault protection, and compensation parameters of the DP7130G are programmable via Bel Power Solutions I<sup>2</sup>C based GUI. All settings can be changed by a user at any time during product development and service. Once programmed, the DPM remembers all settings and configures the DP7130G through a self-clocking single wire communication bus.

FLASH memory in the DPM allows changes to be made without the need to solder or rewire the regulator.

#### North America

+1-866.513.2839

#### Asia-Pacific

+86.755.29885888

#### Europe, Middle East

+353 61 225 977

tech.support@psbel.com  
[belpowersolutions.com](http://belpowersolutions.com)

# DP7130G

## 1. ORDERING INFORMATION

| DP             | 71                         | 30             | G   | -    | zz   |
|----------------|----------------------------|----------------|---|------|--|
| PRODUCT FAMILY | SERIES                     | OUTPUT CURRENT | RoHS COMPLIANCE                           | DASH | PACKAGING OPTIONS <sup>1</sup>                             |
| d-pwer®        | Intelligent dPOL Converter | 30 A           | G - RoHS compliant for all six substances |      | R100 - 100pc T&R<br>Sample quantity orders have no suffix. |

Example: **DP7130G-R100**: A 100-piece reel of RoHS compliant dPOL converters. Each dPOL converter is labelled DP7130G.

## Reference Documents

- DM7300 Digital Power Manager Data Sheet
- DM7300 Digital Power Manager Programming Manual
- Bel Power Solutions I<sup>2</sup>C Graphical User Interface
- DM00056-KIT USB to I<sup>2</sup>C Adapter Kit. User Manual

## 2. ABSOLUTE MAXIMUM RATINGS

Stresses in excess of the absolute maximum ratings may cause performance degradation, adversely affect long term reliability, and cause permanent damage to the converter.

| PARAMETER   | CONDITIONS / DESCRIPTION              | MIN | MAX | UNITS |
|---|---------------------------------------|-----|-----|-------|
| Inductor or Printed Circuit Board (PCB) Temperature | Input Voltage applied                 | -40 | 125 | °C    |
| Input Voltage                                       | 250 ms Transient                      |     | 15  | VDC   |
| Output Current                                      | (See Output Current De-rating Curves) | -24 | 30  | ADC   |

## 3. ELECTRICAL SPECIFICATIONS

Specifications apply at the input voltage from 8 V to 14 V, output load from 0 to 30 A, ambient temperature from -40°C to 85°C. Test conditions include an output filter with 5 x 470 µF 12mΩ solid electrolytic, plus 2 x 22 µF X7R ceramic output capacitors, unless otherwise noted.

### 3.1 INPUT SPECIFICATIONS

| PARAMETER                  | CONDITIONS / DESCRIPTION                            | MIN | NOM | MAX  | UNITS |
|----------------------------|---|-----|-----|------|-------|
| Input Voltage ( $V_{IN}$ ) |   | 8.0 |     | 14.0 | VDC   |
| Input Current (at no load) | $V_{IN} = 14.0\text{ V}$ , $V_{OUT} = 3.3\text{ V}$ |     | 132 |      | mADC  |
| Undervoltage Lockout       | Ramping Up  |     |     | 7.5  | VDC   |
|                            | Ramping Down  | 5.0 |     | 5.0  | VDC   |

<sup>1</sup> Packaging option is used only for ordering and not included in the part number printed on the dPOL converter label.

# DP7130G

## 3.2 OUTPUT SPECIFICATIONS

| PARAMETER                                    | CONDITIONS / DESCRIPTION                                    | MIN              | NOM                         | MAX | UNITS            |
|--|---|------------------|-----------------------------|-----|------------------|
| Output Voltage Range ( $V_{OUT}$ )           | $V_{IN} = 8$ to $14$ VDC                                    | 0.7              |                             | 5.5 | VDC              |
| Output Voltage Setpoint Resolution           |   |                  | 2.5 mV (1 LSB)              |     |                  |
| Output Voltage Setpoint Accuracy             | 2 <sup>nd</sup> $V_o$ Loop Enabled                          |                  | $\pm(0.6\% + 5 \text{ mV})$ |     |                  |
| Output Current ( $I_{OUT}$ )                 | $V_{IN \text{ MIN}}$ to $V_{IN \text{ MAX}}$                | -11 <sup>2</sup> |                             | 30  | ADC              |
| Line Regulation                              | $V_{IN \text{ MIN}}$ to $V_{IN \text{ MAX}}$                |                  | $\pm 0.3$                   |     | $\%V_{OUT}$      |
| Load Regulation                              | 0 to $I_{OUT \text{ MAX}}$                                  |                  | $\pm 0.2$                   |     | $\%V_{OUT}$      |
| Dynamic Regulation                           | Slew rate $1A/\mu s$ , 50 -75% load step                    |                  | 168                         |     | mV               |
| Peak Deviation                               | $F_{SW} = 500$ kHz to 10% of peak deviation                 |                  | 60                          |     | $\mu s$          |
| Settling Time                                | See Output Load Transient Section                           |                  |                             |     |                  |
|  | $V_{IN} = 8.0$ V, $V_{OUT} = 0.7$ V                         |                  | 10                          |     | mV               |
|  | $V_{IN} = 8.0$ V, $V_{OUT} = 2.5$ V                         |                  | 20                          |     | mV               |
| Output Voltage Peak-to-Peak Ripple and Noise | $V_{IN} = 8.0$ V, $V_{OUT} = 3.6$ V                         |                  | 40                          |     | mV               |
| Scope BW = 20 MHz                            | $V_{IN} = 14$ V, $V_{OUT} = 0.7$ V                          |                  | 18                          |     | mV               |
| Full Load                                    | $V_{IN} = 14$ V, $V_{OUT} = 2.5$ V                          |                  | 35                          |     | mV               |
|  | $V_{IN} = 14$ V, $V_{OUT} = 3.6$ V                          |                  | 50                          |     | mV               |
| Temperature Coefficient                      | $V_{IN} = 12$ V, $I_{OUT} = 0.5 \times I_{OUT \text{ MAX}}$ |                  | 20                          |     | ppm/ $^{\circ}C$ |
| Switching Frequency                          |   |                  | 500                         |     | kHz              |
| Duty Cycle Limit                             | Default   |                  | 90.5                        |     | %                |
|  | Programmable, 1.56% steps                                   | 3.125            |                             | 100 | %                |

## 3.3 PROTECTION SPECIFICATIONS

| PARAMETER                            | CONDITIONS / DESCRIPTION  | MIN                          | NOM | MAX | UNITS           |
|--------------------------------------|---|------------------------------|-----|-----|-----------------|
| <b>Output Overcurrent Protection</b> |   |                              |     |     |                 |
| Type                                 | Default   | Non-Latching, 130 ms period  |     |     |                 |
|                                      | Programmable  | Latching/Non-Latching        |     |     |                 |
| Threshold                            | Default   |                              | 132 |     | $\%I_{OUT}$     |
|                                      | Programmable in 11 steps  | 36                           |     | 132 | $\%I_{OUT}$     |
| Threshold Accuracy                   |   | -20                          |     | +20 | $\%I_{OCP.SET}$ |
| <b>Output Overvoltage Protection</b> |   |                              |     |     |                 |
| Type                                 | Default   | Non-Latching, 130 ms period  |     |     |                 |
|                                      | Programmable  | Latching/Non-Latching        |     |     |                 |
| Threshold                            | Default   |                              | 130 |     | $\%V_{O.SET}$   |
|                                      | Programmable in 10% steps   | 110                          |     | 130 | $\%V_{O.SET}$   |
| Threshold Accuracy                   | Measured at $V_{O.SET} = 2.5$ V   | -2                           |     | 2   | $\%V_{OVP.SET}$ |
| Delay                                | From instant when threshold is exceeded until the turn-off command is generated |                              | 6   |     | $\mu s$         |
| Turn Off Behavior <sup>3</sup>       | Default   | Emergency Off                |     |     |                 |
|                                      | Programmable to   | Critical Off / Emergency Off |     |     |                 |

<sup>2</sup> At negative (sink) output current (bus terminator mode) the efficiency of the DP7130 degrades resulting in increased internal power dissipation and switching noise. Therefore maximum allowable negative current under specific conditions is lower than the current determined from the derating curves shown in section 5.

<sup>3</sup> Sequenced Off: The turn-off follows the turn-off delay and slew-rate settings; Critical Off: At turn-off both low and high switches are immediately disabled; Catastrophic Off: At turn-off the high side switch is disabled and the low side switch is enabled.

# DP7130G

| <b>Output Undervoltage Protection</b>         |   |   |      |                       |
|---|---|---|------|-----------------------|
| Type  | Default<br>Programmable   | Non-Latching, 130 ms period<br>Latching/Non-Latching  |      |                       |
| Threshold                                     | Default<br>Programmable in 5% steps   | 75  |      | %V <sub>O.SET</sub>   |
| Threshold Accuracy                            | Measured at V <sub>O.SET</sub> = 2.5 V  | -2  | 2    | %V <sub>UVP.SET</sub> |
| Delay   | From instant when threshold is exceeded until the turn-off command is generated       | 6   |      | μs                    |
| Turn Off BehaviorError! Bookmark not defined. | Default<br>Programmable to  | Sequenced Off<br>Sequenced / Critical Off   |      |                       |
| <b>Overtemperature Protection</b>             |   |   |      |                       |
| Type  | Default<br>Programmable   | Non-Latching, 130 ms period<br>Latching/Non-Latching  |      |                       |
| Turn Off Threshold                            | Temperature is increasing   | 120   |      | °C                    |
| Turn On Threshold                             | Temperature is decreasing after the module was shut down by OTP <sup>4</sup>          | 110   |      | °C                    |
| Threshold Accuracy                            |   | -5  | 5    | °C                    |
| Delay   | From instant when threshold is exceeded until the turn-off command is generated       | 6   |      | μs                    |
| Turn Off BehaviorError! Bookmark not defined. | Default<br>Programmable to  | Sequenced Off<br>Sequenced / Critical Off   |      |                       |
| <b>Tracking Protection (when Enabled)</b>     |   |   |      |                       |
| Type  | Default<br>Programmable   | Disabled<br>Latching/Non-Latching, 130 ms   |      |                       |
| Threshold                                     | Enabled during output voltage ramping up  |   | ±250 | mVDC                  |
| Threshold Accuracy                            |   | -50   | 50   | mVDC                  |
| Delay   | From instant when threshold is exceeded until the turn-off command is generated       | 6   |      | μs                    |
| <b>Overtemperature Warning</b>                |   |   |      |                       |
| Threshold                                     | Always enabled, reported in Status register (TW bit) <sup>5</sup>                     | 110   |      | °C                    |
| Threshold Accuracy                            | From Nominal Set Point  | -5  | +5   | °C                    |
| Hysteresis                                    |   | 1.7   |      | °C                    |
| <b>Power Good Signal (PG pin)</b>             |   |   |      |                       |
| Logic   | V <sub>OUT</sub> is inside the PG window<br>V <sub>OUT</sub> is outside the PG window | High<br>Low   |      |                       |
| Lower Threshold                               | Default<br>Programmable in 5% steps   | 90  | 95   | %V <sub>O.SET</sub>   |
| Upper Threshold                               | Default<br>Programmable in 5% steps   | 105   | 110  | %V <sub>O.SET</sub>   |
| Threshold Accuracy                            | Measured at V <sub>O.SET</sub> = 2.5 V  | -2  | 2    | %V <sub>O.SET</sub>   |
| PG On Delay <sup>6</sup>                      | Default<br>Programmable at  | 0<br>0, 10, 50, 150   |      |                       |
| PG Off Delay                                  | Default<br>Programmable same as PG On Delay   | PG disabled when V <sub>OUT</sub> ≤ V <sub>UV</sub> threshold<br>PG disabled at turn-off command (Reset function) |      |                       |

<sup>4</sup> OTP clears when Overtemp Warning (Status Register TW bit) turns off.

<sup>5</sup> Temp Warning error same sign and proportional with OTP error.

<sup>6</sup> From instant when threshold is exceeded until status of PG signal changes high

# DP7130G

## 3.4 FEATURE SPECIFICATIONS

| PARAMETER  | CONDITIONS / DESCRIPTION                     | MIN   | NOM                 | MAX   | UNITS       |
|--|--|-------|---------------------|-------|-------------|
| <b>Current Share</b>                                       |  |       |                     |       |             |
| Type   |  |       | Active, Single Line |       |             |
| Maximum Number of Modules Connected in Parallel            | $I_{OUT} \geq 0$                             |       | 4                   |       |             |
| Current Share Accuracy                                     | $I_{OUT\ MIN} \geq 20\% \times I_{OUT\ NOM}$ |       |                     | ±20   | % $I_{OUT}$ |
| <b>Interleave</b>  |  |       |                     |       |             |
| Interleave (Phase Shift)                                   | Default                                      |       | 0                   |       | Degree      |
|  | Programmable in 22.5° steps                  | 0     |                     | 337.5 | Degree      |
| <b>Sequencing<sup>7</sup></b>                              |  |       |                     |       |             |
| Turn ON Delay  | Default                                      |       | 0                   |       | ms          |
|  | Programmable in 1ms steps                    | 0     |                     | 255   | ms          |
| Turn OFF Delay   | Default                                      |       | 0                   |       | ms          |
|  | Programmable in 1ms steps                    | 0     |                     | 63    | ms          |
| <b>Tracking</b>  |  |       |                     |       |             |
| Turn ON Slew Rate  | Default                                      |       | 0.05                |       | V/ms        |
|  | Programmable in 7 steps                      | 0.05  |                     | 2.08  | V/ms        |
| Turn OFF Slew Rate   | Default                                      |       | -0.05               |       | V/ms        |
|  | Programmable in 7 steps                      | -0.05 |                     | -2.08 | V/ms        |
| <b>Optimal Voltage Positioning</b>                         |  |       |                     |       |             |
| Load Regulation  | Default                                      |       | 0                   |       | mV/A        |
|  | Programmable in 7 steps                      | 0     |                     | 2.45  | mV/A        |
| <b>Feedback Loop Compensation</b>                          |  |       |                     |       |             |
| Proportional (Kr)  | Programmable                                 | 0.01  |                     | 2     |             |
| Integral (Ti)  | Programmable                                 | 1     |                     | 100   | µs          |
| Differential (Td)  | Programmable                                 | 1     |                     | 100   | µs          |
| Differential Roll-Off (Tv)                                 | Programmable                                 | 1     |                     | 100   | µs          |
| <b>Monitoring</b>  |  |       |                     |       |             |
| Voltage Monitoring Accuracy                                | 12 Bit Resolution over 0.5...5.5 V           | -0.5  |                     | 0.5   | %           |
| Current Monitoring Accuracy                                | $20\% I_{OUT\ NOM} < I_{OUT} < I_{OUT\ NOM}$ | -20   |                     | +20   | % $I_{OUT}$ |
| Temperature Monitoring Accuracy                            | Junction temperature of dPOL controller      | -5    |                     | +5    | °C          |
| <b>Remote Voltage Sense (+VS and -VS pins)<sup>9</sup></b> |  |       |                     |       |             |
| Voltage Drop Compensation                                  | Between +VS and VOUT                         |       |                     | 300   | mV          |
| Voltage Drop Compensation                                  | Between -VS and PGND                         |       |                     | 100   | mV          |

<sup>7</sup> Timing based on SD clock and subject to tolerances of SD.

<sup>8</sup> Achieving fast slew rates under specific line and load conditions may require feedback loop adjustment. The possible settings are: 0.05V/ms, 0.1V/ms, 0.2V/ms, 0.25V/ms, 0.5V/ms, 1.0V/ms and 2.0V/ms (plus and minus)

<sup>9</sup> For remote sense, it is recommended to place a 0.01-0.1µF ceramic capacitor between +VS and -VS pins as close to the dPOL converter as possible.

# DP7130G

## 3.5 SIGNAL SPECIFICATIONS

| PARAMETER                                | CONDITIONS/DESCRIPTION                     | MIN              | NOM | MAX        | UNITS            |
|--|--|------------------|-----|------------|------------------|
| VDD                                      | Internal supply voltage                    | 3.15             | 3.3 | 3.45       | V                |
| Logic In Max                             | Pull Up Logic max safe input               |                  |     | VDD+0.5    | V                |
| <b><i>SYNC/DATA Line (SD pin)</i></b>    |  |                  |     |            |                  |
| ViL_sd                                   | LOW level input voltage                    | -0.5             |     | 0.3 x VDD  | V                |
| ViH_sd                                   | HIGH level input voltage                   | 0.75 x VDD       |     | VDD + 0.5  | V                |
| Vhyst_sd                                 | Hysteresis of input Schmitt trigger        | 0.25 x VDD       |     | 0.45 x VDD | V                |
| VoL                                      | LOW level sink current @ 0.5V              | 16               |     | 60         | mA               |
| Tr_sd                                    | Maximum allowed rise time 10/90%VDD        |                  |     | 300        | ns               |
| Cnode_sd                                 | Added node capacitance                     |                  | 5   | 10         | pF               |
| Ipu_sd                                   | Pull-up current source at Vsd=0V           | 0.25             |     | 0.75       | mA               |
| Freq_sd                                  | Clock frequency of external SD line        | 475              |     | 525        | kHz              |
| Tsynq                                    | Sync pulse duration                        | 22               |     | 28         | % of clock cycle |
| T0                                       | Data=0 pulse duration                      | 72               |     | 78         | % of clock cycle |
| <b><i>ADDR0:ADDR4</i></b>                |  |                  |     |            |                  |
| ViL_ADDR                                 | LOW level input voltage                    | -0.5             |     | 0.3 x VDD  | V                |
| ViH_ADDR                                 | HIGH level input voltage                   | 0.5 x VDD - 0.25 |     | VDD+0.5    | V                |
| Rup_ADDRx                                | Internal pull-up resistor                  | 6                |     | 14         | KΩ               |
| <b><i>PGD and OK Inputs/Outputs</i></b>  |  |                  |     |            |                  |
| Iup_PG                                   | Pull-up current source input forced low PG | 30               |     | 100        | μA               |
| Iup_OK                                   | Pull-up current source input forced low OK | 85               |     | 250        | μA               |
| ViL_x                                    | LOW level input voltage                    | -0.5             |     | 0.3 x VDD  | V                |
| ViH_x                                    | HIGH level input voltage                   | 0.7 x VDD        |     | VDD+0.5    | V                |
| Vhyst_x                                  | Hysteresis of input Schmitt trigger        | 0.1 x VDD        |     | 0.3 x VDD  | V                |
| IoL                                      | LOW level sink current at 0.5V             | 2                |     |            | mA               |
| <b><i>Current Share Bus (CS pin)</i></b> |  |                  |     |            |                  |
| Iup_CS                                   | Pull-up current source at VCS = 0V         | 0.84             |     | 2.5        | mA               |
| ViL_CS                                   | LOW level input voltage                    | -0.5             |     | 0.3 x VDD  | V                |
| ViH_CS                                   | HIGH level input voltage                   | 0.75 x VDD       |     | VDD+0.5    | V                |
| Vhyst_CS                                 | Hysteresis of input Schmitt trigger        | 0.25 x VDD       |     | 0.45 x VDD | V                |
| IoL                                      | LOW level sink current at 0.5V             | 16               |     |            | mA               |
| Tr_CS                                    | Maximum allowed rise time 10/90% VDD       |                  |     | 100        | ns               |

# DP7130G

## 4. PIN ASSIGNMENTS AND DESCRIPTIONS

| PIN NAME | PIN NUMBER | PIN TYPE | BUFFER TYPE | PIN DESCRIPTION        | NOTES   |
|----------|------------|----------|-------------|------------------------|---|
| VIN      | 1          | P        |             | Input Voltage          | Connected internally to VIN Pin 25  |
| DNC      | 2          |          |             | Do Not Connect         | Leave floating  |
| DNC      | 3          |          |             | Do Not Connect         | Leave floating  |
| DNC      | 4          |          |             | Do Not Connect         | Leave floating  |
| DNC      | 5          |          |             | Do Not Connect         | Leave floating  |
| DNC      | 6          |          |             | Do Not Connect         | Leave floating  |
| DNC      | 7          |          |             | Do Not Connect         | Leave floating  |
| DNC      | 8          |          |             | Do Not Connect         | Leave floating  |
| DNC      | 9          |          |             | Do Not Connect         | Leave floating  |
| DNC      | 10         |          |             | Optional No Connect    | Leave Floating or Connect to PGND   |
| OK       | 11         | I/O      | PU          | Fault/Status Condition | Connect to OK pin of the DPM and any other dPOLs of the same group.                           |
| SD       | 12         | I/O      | PU          | Sync/Data Line         | Connect to SD pin of DPM and all other DPols  |
| PG       | 13         | I/O      | PU          | Power Good             | Pin state reflected in Status Register.   |
| DNC      | 14         |          |             | Do Not Connect         | Leave floating  |
| CS       | 15         | I/O      | PU          | Current Share          | Connect to CS pins of other dPOLs connected in parallel. Leave floating if not on shared bus. |
| ADDR4    | 16         | I        | PU          | dPOL Address Bit 4     | Tie to PGND for 0 or leave floating for 1   |
| ADDR3    | 17         | I        | PU          | dPOL Address Bit 3     | Tie to PGND for 0 or leave floating for 1   |
| ADDR2    | 18         | I        | PU          | dPOL Address Bit 2     | Tie to PGND for 0 or leave floating for 1   |
| ADDR1    | 19         | I        | PU          | dPOL Address Bit 1     | Tie to PGND for 0 or leave floating for 1   |
| ADDR0    | 20         | I        | PU          | dPOL Address Bit 0     | Tie to PGND for 0 or leave floating for 1   |
| -VS      | 21         | I        | PU          | Negative Voltage Sense | Connect to the negative point close to the desired sensing point or PGND                      |
| +VS      | 22         | I        | PU          | Positive Voltage Sense | Connect to the positive point close to the desired sensing point or VOUT                      |
| VOUT     | 23         | P        |             | Output Voltage         |   |
| PGND     | 24         | P        |             | Power Ground           |   |
| VIN      | 25         | P        |             | Input Voltage          |   |

Legend: I=input, O=output, I/O=input/output, P=power, A=analog, PU= pulled up to internal 3.3V bus

# DP7130G

## 5. TYPICAL PERFORMANCE CHARACTERISTICS

### 5.1 THERMAL DERATING AT $T_c \leq 125^\circ\text{C}$ FOR $V_{OUT} = 3.3\text{ V}$

Figure 1: Available output current vs. ambient air temperature and airflow rates for converter DP7130G mounted horizontally with air flowing from pin 1 to pin 22, MOSFET temperature  $\leq 125^\circ\text{C}$ ,  $V_{in} = 12\text{ V}$ .

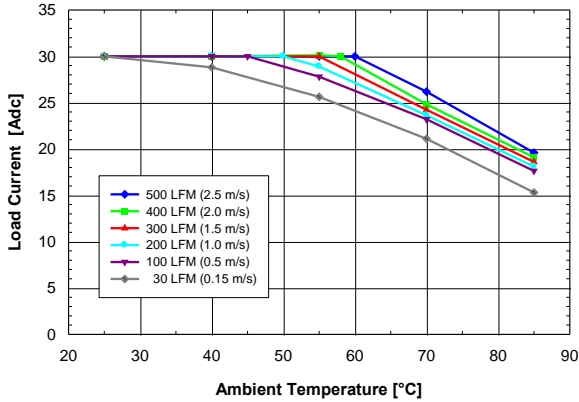
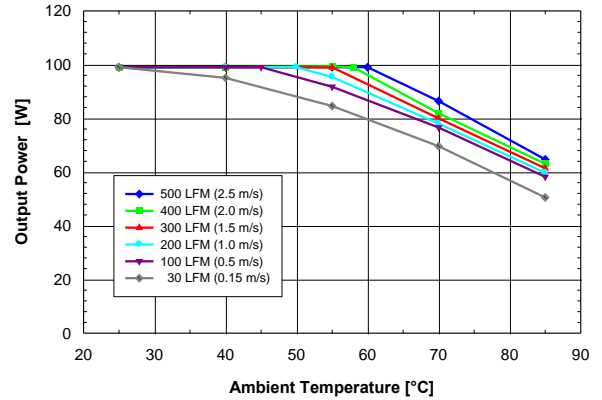

Figure 2: Available output power vs. ambient air temperature and airflow rates for converter DP7130G mounted horizontally with air flowing from pin 1 to pin 22, MOSFET temperature  $\leq 125^\circ\text{C}$ ,  $V_{in} = 12\text{ V}$ .



### 5.2 THERMAL DERATING AT $T_c \leq 125^\circ\text{C}$ FOR $V_{OUT} = 1.2\text{ V}$

Figure 3: Available output current vs. ambient air temperature and airflow rates for converter DP7130G mounted horizontally with air flowing from pin 1 to pin 22, MOSFET temperature  $\leq 125^\circ\text{C}$ ,  $V_{in} = 12\text{ V}$ .

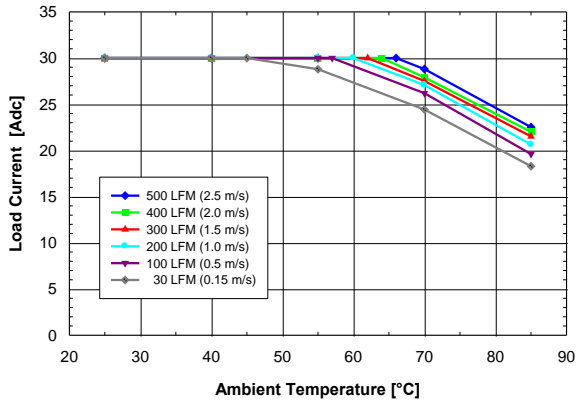
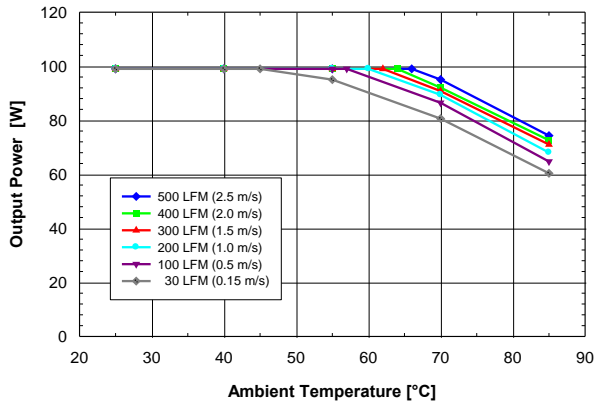

Figure 4: Available output power vs. ambient air temperature and airflow rates for converter DP7130G mounted horizontally with air flowing from pin 1 to pin 22, MOSFET temperature  $\leq 125^\circ\text{C}$ ,  $V_{in} = 12\text{ V}$ .





# DP7130G

## 5.3 EFFICIENCY AT 25°C

Figure 5: Efficiency vs. load current and output voltage for converter DP7130G at 8V in, Ta = 25 °C.

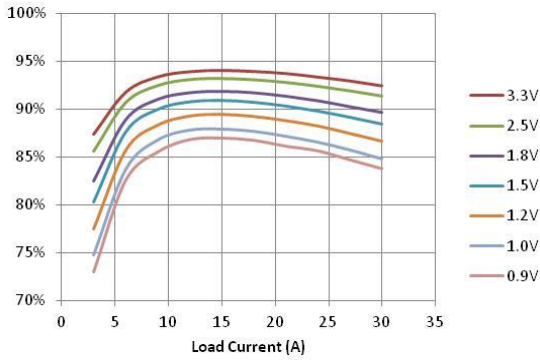

Figure 6: Efficiency vs. load current and input voltage for converter DP7130G at 12V in, Ta = 25 °C.

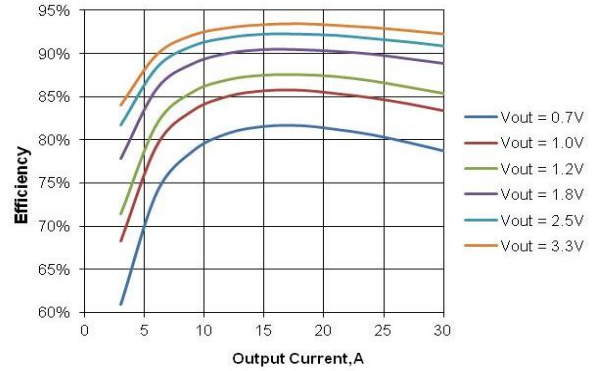
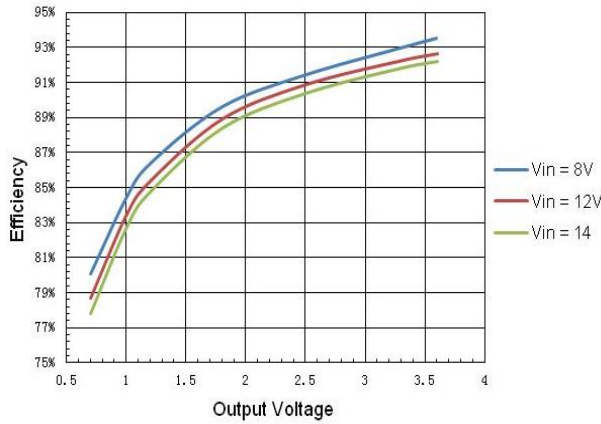

Figure 7: Efficiency vs. Output voltage for converter DP7130, with 30A load, input voltage at 8, 12 and 14V, at Ta = 25 °C.



## 5.4 POWER DISSIPATION AT 25°C

Figure 8: Power dissipation vs. load for converter DP7130, with Vin = 8.0V in Ta = 25 °C.

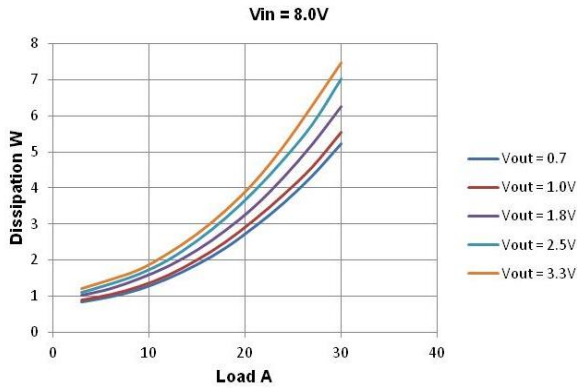
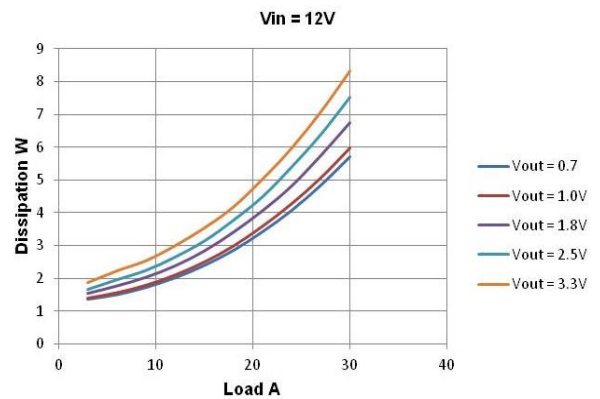

Figure 9: Power dissipation vs. load for converter DP7130, with Vin = 12V in Ta = 25 °C.



# DP7130G

## 6. PROGRAMMABLE FEATURES

Performance parameters of DP7130G dPOL converters are programmed by the system DPM over a self-clocking single wire bus as need. Each parameter is stored in FLASH memory in the DPM and loaded into volatile memory registers in the dPOL control chip detailed in Table 1. Setup registers 00h through 14h are programmed at the system power-up. When the input voltage is removed, the dPOL controller's default values are restored.

Table 1. DP7130G Memory Registers

| CONFIGURATION REGISTERS |  |         |
|-------------------------|--|---------|
| Name                    | Register                                   | Address |
| PC1                     | Protection Configuration 1                 | 0x00    |
| PC2                     | Protection Configuration 2                 | 0x01    |
| PC3                     | Protection Configuration 3                 | 0x02    |
| TC                      | Tracking Configuration                     | 0x03    |
| INT                     | Interleave and Frequency Configuration     | 0x04    |
| DON                     | Turn-On Delay                              | 0x05    |
| DOF                     | Turn-Off Delay                             | 0x06    |
| VLC                     | Voltage Loop Configuration                 | 0x07    |
| CLS                     | Current Limit Set-point                    | 0x08    |
| DCL                     | Duty Cycle Limit                           | 0x09    |
| PC4                     | Protection Configuration 4                 | 0x0A    |
| V1H                     | Output Voltage Setpoint 1 (Low Byte)       | 0x0B    |
| V1L                     | Output Voltage Setpoint 1 (High Byte)      | 0x0C    |
| V2H                     | Output Voltage Setpoint 2 (Low Byte)       | 0x0D    |
| V2L                     | Output Voltage Setpoint 2 (High Byte)      | 0x0E    |
| V3H                     | Output Voltage Setpoint 3 (Low Byte)       | 0x0F    |
| V3L                     | Output Voltage Setpoint 3 (High Byte)      | 0x10    |
| CP                      | Controller Proportional Coefficient        | 0x11    |
| CI                      | Controller Integral Coefficient            | 0x12    |
| CD                      | Controller Derivative Coefficient          | 0x13    |
| B1                      | Controller Derivative Roll-Off Coefficient | 0x14    |
| STATUS REGISTERS        |  |         |
| Name                    | Register                                   | Address |
| RUN                     | Run enable / status                        | 0x15    |
| ST                      | Status                                     | 0x16    |
| MONITORING REGISTERS    |  |         |
| Name                    | Register                                   | Address |
| VOH                     | Output Voltage High Byte (Monitoring)      | 0x17    |
| VOL                     | Output Voltage Low Byte (Monitoring)       | 0x27    |
| IO                      | Output Current (Monitoring)                | 0x18    |
| TMP                     | Temperature (Monitoring)                   | 0x19    |

DP7130G converters can be programmed using the Graphical User Interface or directly via the I<sup>2</sup>C bus by using high and low level commands as described in the "DPM Programming Manual".

DP7130G parameters can be reprogrammed at any time during the system operation and service except for the digital filter coefficients, the switching frequency and the duty cycle limit, that can only be changed when the dPOL output is turned off.

# DP7130G

## 6.1 OUTPUT VOLTAGE

The output voltage can be programmed in the GUI Output Configuration window shown in the Figure 10 or directly via the I<sup>2</sup>C bus by writing into the VOS register shown in Figure 11.

Figure 10. Output Configuration Window

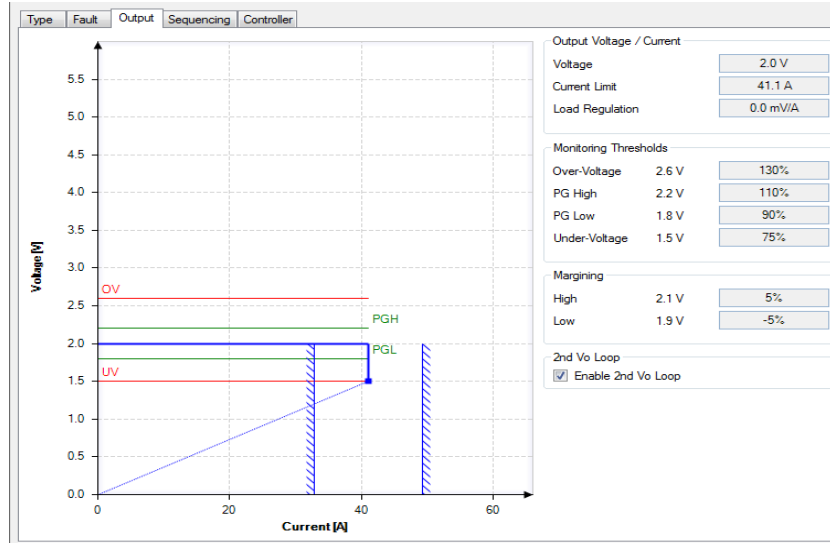

Note that the GUI shows the effect of setting PG, OV and UV limits as both values and graphical limit bars. Vertical hashed lines are error bars for the Overcurrent (OC) limit.

### 6.1.1 Output Voltage Setpoint

The output voltage programming range is from 0.7 V to 3.6 V. The resolution is constant across the range and is 2.5 mV. A Total of 3 registers are provided: one should be used for the normal setpoint voltage; the other two can be used to define a low/high margining voltage setpoint. Note that each register is 16bit wide and that the high byte needs always to be written / read first. The writing of the low byte triggers the refresh of the whole 16bit register (the high byte is written to a shadow register). Changes to VOS can be made while the output is enabled.

Unlike other configuration registers, the dPOL controller's VOS registers are dynamic. Changes to VOS values can be made while the output is enabled over the I<sup>2</sup>C bus through register bypass commands and the dPOL will change its output immediately.

Figure 11. Output Voltage Setpoint Register VOS

| VOS: Output Voltage Set-Point<br>Address: 0x0B ... 0x10                |                              |   |      |         |
|--|------------------------------|---|------|---------|
|  | Coefficient                  | Addr  | Bits | Default |
| V1H  | First Vo Setpoint High Byte  | 0x0B  | 8    |         |
| V1L  | First Vo Setpoint Low Byte   | 0x0C  | 8    |         |
| V2H  | Second Vo Setpoint High Byte | 0x0D  | 8    |         |
| V2L  | Second Vo Setpoint Low Byte  | 0x0E  | 8    |         |
| V3H  | Third Vo Setpoint High Byte  | 0x0F  | 8    |         |
| V3L  | Third Vo Setpoint Low Byte   | 0x10  | 8    |         |
| <b>Mapping:</b><br>- 12 bit data word, left aligned<br>- 1LSB = 2.5 mV |                              | <b>Note:</b><br>- all registers are readable and writeable<br>- always write and read the high byte first |      |         |

# DP7130G

## 6.1.2 Output Voltage Margining

If the output voltage needs to be varied by a certain percentage, the margining function can be utilized. The margining can be programmed in the dPOL Configuration window or directly via the I<sup>2</sup>C bus using high level commands as described in the "DM7300 Digital Power Manager Programming Manual".

In order to properly margin dPOLs that are connected in parallel, the dPOLs must be members of one of the Parallel Buses. Refer to the GUI System Configuration Window shown in Figure 50.

## 6.1.3 Output Load Regulation Control

When Load Regulation is programmed to be non-zero, the output voltage will decrease as the output current increases, so the VI characteristic will have a negative slope at the point of regulation. This can be programmed in the GUI Output Configuration window shown in Figure 10 or directly via the I<sup>2</sup>C bus. In the DP7007 Load Regulation can be set to one of eight values: 0, 0.25, 0.49, 0.74, 0.98, 1.23, 1.47, or 1.72 mV/A.

Figure 12. Concept of Optimal Voltage Positioning

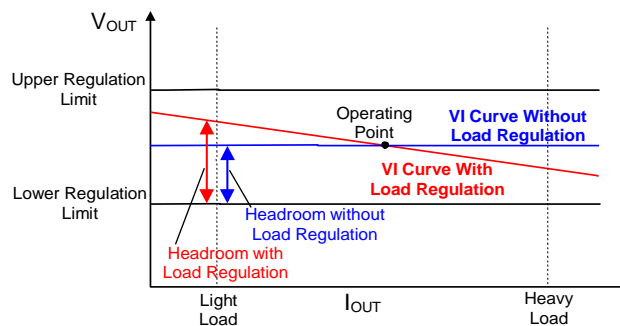

Figure 13 shows a DP7130G dPOL with 0 mV/A (load current) regulation. Alternating high and low output load currents causes large transients in  $V_{out}$  to appear with each change.

Figure 13. Transient Response with Regulation set to 0 mV/A.

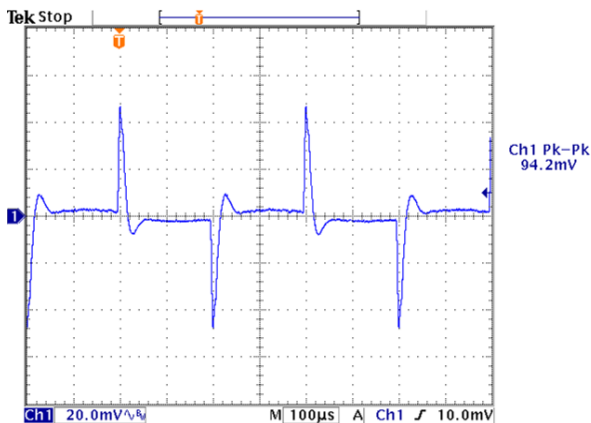
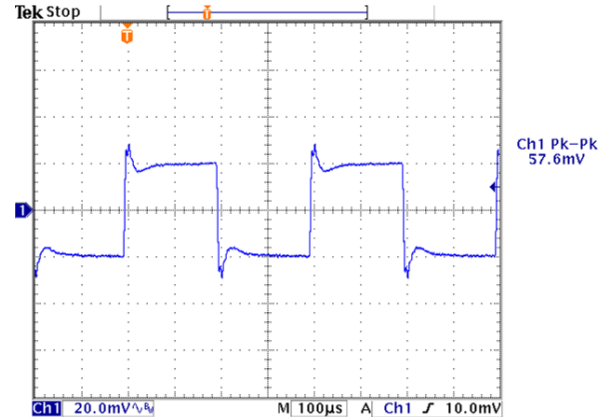

Figure 14. Transient Response with non-zero Regulation.



## 6.2 SEQUENCING AND TRACKING

Turn-on delay, turn-off delay, and rising and falling output voltage slew rates can be programmed in the GUI dPOL Sequencing/Tracking window shown in Figure 15 or directly via the I<sup>2</sup>C bus by writing into the DON, DOF, and TC registers, respectively. The registers are shown in Figure 16, Figure 18 and Figure 19.

Figure 15. Sequencing/Tracking Window

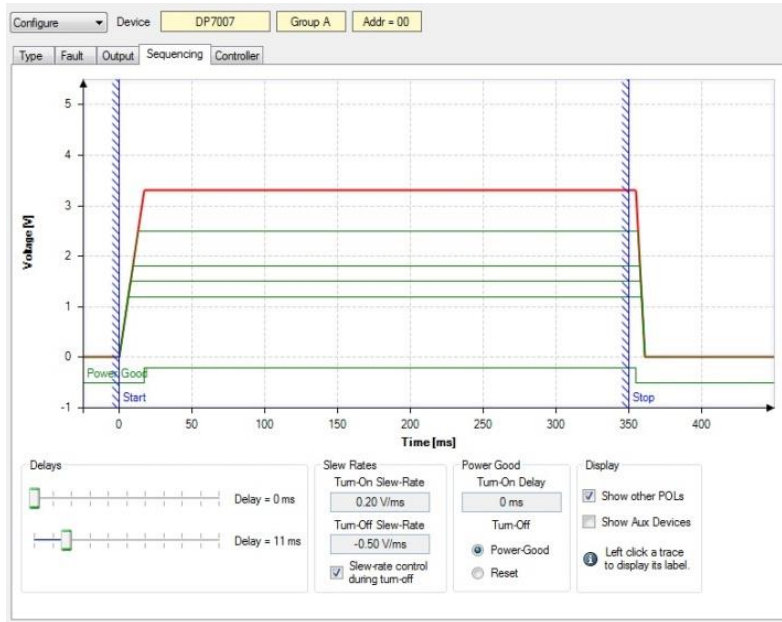

## 6.2.1 Turn-On Delay

Turn-on delay is defined as an interval from the application of the Turn-On command until the output voltage starts ramping up.

Figure 16. Turn-On Delay Register DON

DON: Turn-On Delay Configuration  
Address: 0x05

| R/W-0  | R/W-0 | R/W-0 | R/W-0 | R/W-0 | R/W-0 | R/W-0 | R/W-0 |
|--|-------|-------|-------|-------|-------|-------|-------|
| DON7   | DON6  | DON5  | DON4  | DON3  | DON2  | DON1  | DON0  |
| Bit 7  |       |       |       |       |       |       | Bit 0 |
| <p><b>DON[7:0]:</b> Turn-On delay in ms<br/>                     0x00 = 0ms (default)<br/>                     0x01 = 1ms<br/>                     ...<br/>                     0xFF = 255ms</p> |       |       |       |       |       |       |       |

## 6.2.2 Turn-Off Delay

Turn-off delay is defined as an interval from the application of the Turn-Off command until the output voltage reaches zero (if the falling slew rate is programmed) or until both high side and low side switches are turned off (if the slew rate is not programmed). Therefore, for the slew rate controlled turn-off the ramp-down time is included in the turn-off delay as shown in Figure 17.

Figure 17. Relationship between Turn-Off Delay and Falling Slew Rate

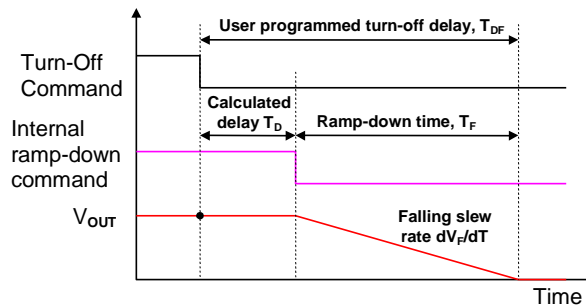

# DP7130G

As it can be seen from the figure, the internally calculated delay  $T_D$  is determined by the equation below.

$$T_D = T_{DF} - \frac{V_{OUT}}{dV_F/dT}$$

For proper operation  $T_D$  shall be greater than zero. The appropriate value of the turn-off delay needs to be programmed to satisfy the condition.

If the falling slew rate control is not utilized, the turn-off delay only determines an interval from the application of the Turn-Off command until both high side and low side switches are turned off. In this case, the output voltage ramp-down process is determined by load parameters.

Figure 18. Turn-Off Delay Register DOF

| DOF: Turn-Off Delay Configuration<br>Address: 0x06 |                                       |       |       |       |       |       |       |
|--|---------------------------------------|-------|-------|-------|-------|-------|-------|
| U  | U                                     | R/W-0 | R/W-0 | R/W-1 | R/W-0 | R/W-1 | R/W-1 |
| ---  | ---                                   | DOF5  | DOF4  | DOF3  | DOF2  | DOF1  | DOF0  |
| Bit 7  |                                       |       |       |       |       |       | Bit 0 |
| Bit 7:6  | <b>Unimplemented:</b> read as '0'     |       |       |       |       |       |       |
|  | <b>DOF[5:0]:</b> Turn-Off delay in ms |       |       |       |       |       |       |
|  | 0x00 = 0ms                            |       |       |       |       |       |       |
|  | 0x01 = 1ms                            |       |       |       |       |       |       |
| Bit 5:0  | ...                                   |       |       |       |       |       |       |
|  | 0x0B = 11ms (default)                 |       |       |       |       |       |       |
|  | ...                                   |       |       |       |       |       |       |
|  | 0x3F = 63ms                           |       |       |       |       |       |       |

## 6.3 TURN-ON/OFF CONTROL

Once delays are accounted for, turn on characteristics are simply a function of slew rates, which are selectable.

### 6.3.1 Rising and Falling Slew Rates

Output voltage ramp up (and down) control is accomplished by programming the rising and falling slew rates of the output voltage, supported in the GUI as shown in Figure 15 which is implemented through writing data to the TC register, Figure 19.

To achieve programmed slew rates, the output voltage is being changed in 10mV steps where duration of each step determines the slew rate. For example, ramping up the 1.0V output with a slew rate of 0.5V/ms will require 100 steps with duration of 20μs each.

Duration of each voltage step is calculated by dividing the master clock frequency generated by the DPM (500KHZ). Since all dPOLs in the system are synchronized to the master clock, the matching of voltage slew rates of different outputs is very accurate as it can be seen in Figure 20 and Figure 25.

During the turn on process, a dPOL not only delivers current required by the load ( $I_{LOAD}$ ), but also charges the load capacitance. The charging current can be determined from the equation below:

$$I_{CHG} = C_{LOAD} \times \frac{dV_R}{dt}$$

Where,  $C_{LOAD}$  is load capacitance,  $dV_R/dt$  is rising voltage slew rate, and  $I_{CHG}$  is charging current.

Figure 19. Tracking Configuration Register TC

| TC: Tracking Configuration<br>Address: 0x03 |   |       |       |       |       |       |       |
|---|---|-------|-------|-------|-------|-------|-------|
| U   | R/W-0   | R/W-0 | R/W-1 | R/W-1 | R/W-1 | R/W-0 | R/W-0 |
| ---   | R2  | R1    | R0    | SC    | F2    | F1    | F0    |
| Bit 7                                       |   |       |       |       |       |       | Bit 0 |
| Bit 7                                       | <b>Unimplemented:</b> read as '0'<br><b>R[2:0]:</b> Vo rising slew rate<br>0 = 0.05 V/ms (default when in bus terminator mode)<br>1 = 0.1 V/ms (default)<br>2 = 0.2 V/ms<br>3 = 0.25 V/ms<br>4 = 0.5 V/ms<br>5 = 1.0 V/ms<br>6 = 2.0 V/ms<br>7 = Reserved |       |       |       |       |       |       |
| Bit 6:4                                     | <b>SC:</b> Turn-off slew rate control<br>0 = disabled<br>1 = enabled (default)  |       |       |       |       |       |       |
| Bit 3                                       | <b>F[2:0]:</b> Vo falling slew rate<br>0 = -0.05 V/ms<br>1 = -0.1 V/ms<br>2 = -0.2 V/ms<br>3 = -0.25 V/ms (default when in bus terminator mode)<br>4 = -0.5 V/ms (default)<br>5 = -1.0 V/ms<br>6 = -2.0 V/ms<br>7 = Reserved                              |       |       |       |       |       |       |
| Bit 2:0                                     |   |       |       |       |       |       |       |

When selecting the rising slew rate, a user needs to ensure that

$$I_{LOAD} + I_{CHG} < I_{OCP}$$

Where  $I_{OCP}$  is the overcurrent protection threshold of the DP7130. If the condition is not met, then the overcurrent protection will be triggered during the turn-on process. To avoid this,  $dV_R/dt$  and the overcurrent protection threshold should be programmed to meet the condition above.

### 6.3.2 Delay and Slew Rate Combination

The effect of setting slew rates and turn on/off delays is illustrated in the following sets of figures.

Figure 20. Tracking Turn-On. Rising Slew Rate is Programmed at 0.5V/ms. Vin=12V

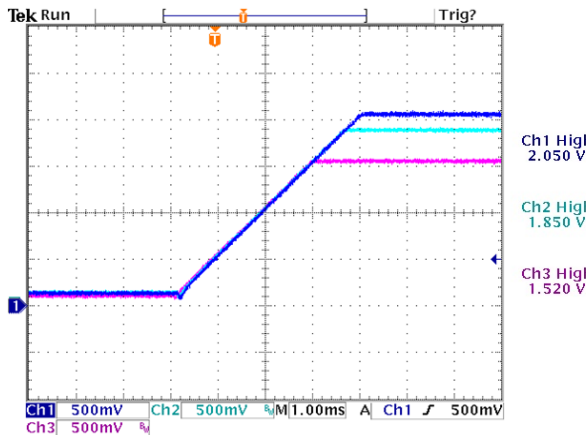
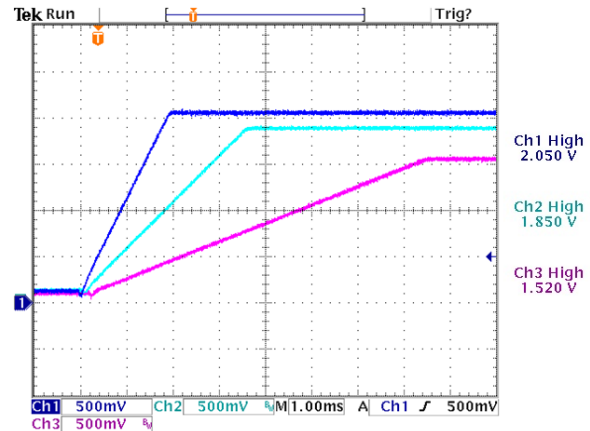

Figure 21. Turn-On with Different Rising Slew Rates. V1-and V2- 0.5V/ms, V3-0.2V/ms. Vin=12V



# DP7130G

Figure 22. Staggered Turn on at 2ms intervals. Rising Slew Rate is Programmed at 0.5V/ms.

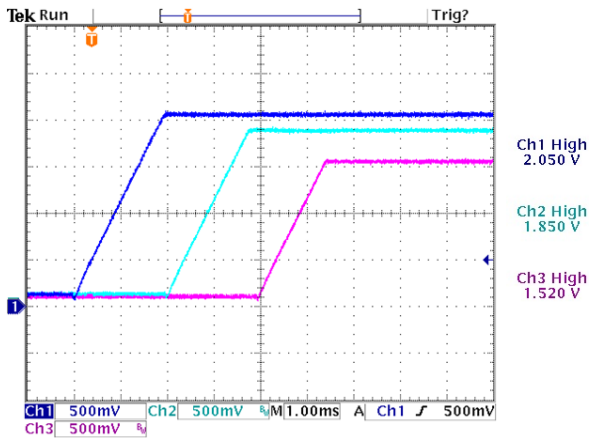
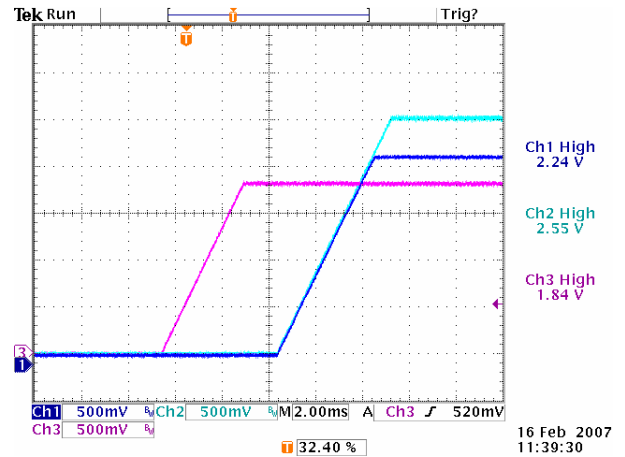

Figure 23 Two outputs delayed 5ms. All slew rates at 0.5V/ms.



## 6.3.3 Pre-Bias

The d-pwer<sup>®</sup> controller in the dPOL holds off turn on its output until the desired ramp up point crosses the pre-bias point, as seen in Figure 24.

Figure 24. Turn On into Prebiased Load. V1 and V2 are Prebiased by V3 via a Diode.

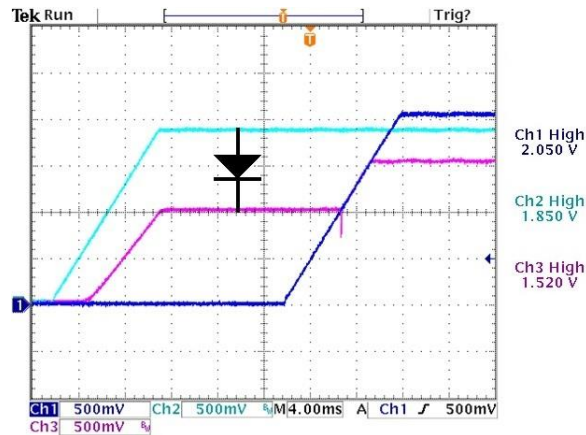

Figure 24 was captured with an actual system where a diode was added to pre-bias a 1.5V bus from a 1.85V bus in order to simulate the effect of current leakage through protection circuits of unpowered logic connected to powered logic outputs (a common source of pre-bias in power systems).

## 6.4 TURN-OFF CHARACTERISTICS

Turn of captures show that combining turn off delays and ramp rates. Note that while turnoff delays have a lower upper time limit as compared to turn on delays, all ramp down rates are available independently to turn on and off.



# DP7130G

Figure 25. Tracking Turn-Off. Falling Slew Rate is 0.5V/ms.

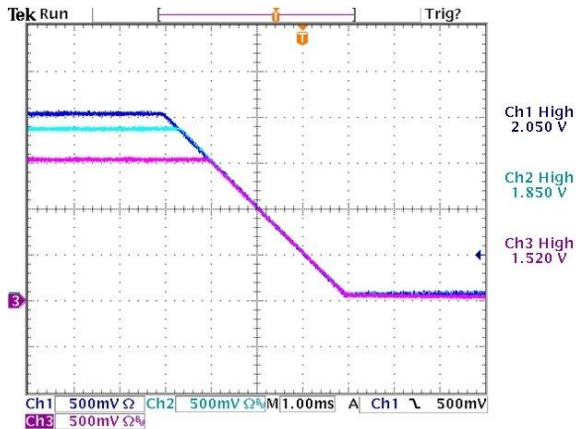
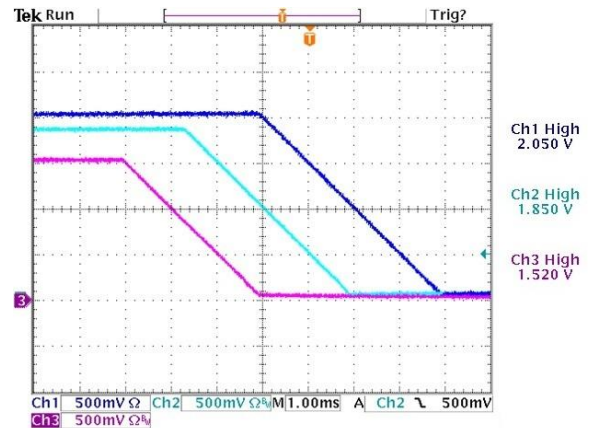

Figure 26. Turn-Off with Tracking and Sequencing. Falling Slew Rate is 0.5V/ms.



## 6.5 FAULT, ERROR AND WARNINGS

All dPOL series converters have a comprehensive set of programmable fault and error protection functions that can be classified into three groups based on their effect on system operation: warnings, faults, and errors. These are *warnings*, *errors* and *faults*. Warnings include Thermal (Overtemperature limit near) and Power Good (a warning in a negative sense.)

Faults in the DP7130G dPOL include overcurrent protection, overvoltage, overtemperature and tracking failure detection. Errors include only undervoltage. Control of responses to Faults and Errors are distributed between different dPOL registers and are configurable in the GUI.

Thresholds of overcurrent, over- and undervoltage protections, and Power Good limits can be programmed in the GUI Output Configuration window Figure 10, or directly via the I<sup>2</sup>C bus by writing into the PC2 register shown in Figure 27.

Figure 27. Protection Configuration Register PC2

| PC2: Protection Configuration Register 2 <sup>1)</sup> |  |       |       |       |       |       |       |
|--|--|-------|-------|-------|-------|-------|-------|
| Address: 0x01  |  |       |       |       |       |       |       |
| U  | U  | R/W-0 | R/W-0 | R/W-1 | R/W-0 | R/W-0 | R/W-0 |
| ---  | ---  | PGHL  | PGLL  | OVPL1 | OVPL0 | UVPL1 | UVPL0 |
| Bit 7  |  |       |       |       |       |       | Bit 0 |
| Bit7:6   | <b>Unimplemented:</b> read as '0'  |       |       |       |       |       |       |
|  | <b>PGHL:</b> Power Good High Level   |       |       |       |       |       |       |
| Bit 5  | 1 = 105% of Vo<br>0 = 110% of Vo (default)   |       |       |       |       |       |       |
|  | <b>PGLL:</b> Power Good Low Level  |       |       |       |       |       |       |
| Bit 4  | 1 = 95% of Vo<br>0 = 90% of Vo (default)   |       |       |       |       |       |       |
|  | <b>OVPL:</b> Over Voltage Protection Level   |       |       |       |       |       |       |
|  | 00 = 110% of Vo<br>01 = 120% of Vo<br>10 = 130% of Vo (default)<br>11 = 130% of Vo |       |       |       |       |       |       |
| Bit 3:2  | <b>UVPL:</b> Under Voltage Protection Level  |       |       |       |       |       |       |
|  | 00 = 75% of Vo (default)<br>01 = 80% of Vo<br>10 = 85% of Vo<br>11 = 90% of Vo     |       |       |       |       |       |       |
| Bit 1:0  |  |       |       |       |       |       |       |

<sup>1)</sup> This register can only be written when PWM is not active (RUN[RUN] is '0')

Note that the overvoltage and undervoltage protection thresholds and Power Good limits are defined as percentages of the output voltage. Therefore, the absolute levels of the thresholds change when the output voltage setpoint is changed either by output voltage adjustment or by margining.

# DP7130G

Overcurrent limits are set either in the GUI dPOL Output configuration dialog or in the dPOL's CLS register as shown in Figure 28. Note that the CLS register includes bits which control the Regulation option settings. When writing into this register be careful to not change Regulation by accident.

Figure 28. Current Limit Setpoint Register CLS

| CLS: Current Limit Setting<br>Address: 0x08  |       |       |       |       |       |       |       |
|--|-------|-------|-------|-------|-------|-------|-------|
| R/W-0  | R/W-0 | R/W-0 | R/W-1 | R/W-1 | R/W-0 | R/W-1 | R/W-1 |
| LR2  | LR1   | LR0   | TCE   | CL3   | CL2   | CL1   | CL0   |
| Bit 7  |       |       |       |       |       |       | Bit 0 |
| <b>LR[2:0]:</b> Load Regulation setting<br>0 = 0 V/A/Ω (default)<br>1 = 0.39 V/A/Ω<br>2 = 0.78 V/A/Ω<br>3 = 1.18 V/A/Ω<br>4 = 1.57 V/A/Ω<br>5 = 1.96 V/A/Ω<br>6 = 2.35 V/A/Ω<br>7 = 2.75 V/A/Ω |       |       |       |       |       |       |       |
| <b>TCE:</b> Temperature Compensation for Current Limitation Enable<br>0 = disabled<br>1 = enabled (default)  |       |       |       |       |       |       |       |
| <b>CLS[3:0]:</b> Current Limit set-point when Vo Stationary or Falling<br>0x0 = 37%<br>0x1 = 47%<br>...<br>0xB = 140% (default)<br>values higher than 0xB are translated to 0xB (140%)         |       |       |       |       |       |       |       |

## 6.5.1 Warnings

This group includes Overtemperature Warning and Power Good Signal. The warnings do not turn off dPOLs but rather generate signals that can be transmitted to a host controller via the I<sup>2</sup>C bus.

### 6.5.1.1 Overtemperature Warning

The Overtemperature Warning is generated when temperature of the controller exceeds 120°C. The Overtemperature Warning changes the TW bit of the status register ST. When the temperature falls below 117°C, the PT bit is cleared and the Overtemperature Warning is removed.

### 6.5.1.2 Power Good

Power Good (PG) is an open collector output with a weak constant current pull-up that is pulled low if the output voltage is outside of the Power Good window. The window is formed by the Power Good High threshold that is programmable at 105 or 110% of the output voltage and the Power Good Low threshold that can be programmed at 90 or 95% of the output voltage.

Power Good protection is only enabled after the output voltage reaches its steady state level. A programmable delay can be set between 0 and 150ms to delay the release of the PG pin after the voltage has reached the steady state level (see Figure 15). This allows using the PG pin to reset load circuits properly. The Power Good protection remains active during margining voltage transitions. This allows using the PG pin to reset load circuits properly. Power Good protection remains active during margining voltage transitions. The threshold will vary proportionally to the voltage change (see Figure 29).

Power Good Warning pulls the PG pin low and changes the PG bit of the status register ST to 0. When the output voltage returns within the Power Good window, the PG pin is released high, the PG bit is cleared and the Power Good Warning is removed. The Power Good pin can also be pulled low by an external circuit to initiate the Power Good Warning.

At turn-off the PG pin can be programmed to either be pulled low immediately following the turn-off command, or when the output voltage actually starts to ramp down (Reset vs. Power Good functionality in Figure 15).

**NOTE:** To retrieve status information, Status Monitoring in the GUI DPM Configure Devices window should be enabled (refer to Digital Power Manager Data Sheet). The DPM will retrieve the status information from each dPOL on a continuous basis.

# DP7130G

## 6.5.2 Faults

This group includes overcurrent, overtemperature, undervoltage, and tracking protections. Triggering any protection in this group will turn off the dPOL.

### 6.5.2.1 Overcurrent Protection

Overcurrent protection is active whenever the output voltage of the dPOL exceeds the prebias voltage (if any). When the output current reaches the OC threshold, the POL control chip asserts an OC fault. The dPOL sets the OC bit in the register ST to 0. Both high side and low side switches of the dPOL are turned off instantly (fast turn-off).

Current sensing is across the dPOLs choke. To compensate for copper winding  $T_c$ , compensation is added to keep the OC threshold approximately constant at temperatures above room temperature. Note that the temperature compensation can be disabled in the dPOL Configure Output window or directly via the I<sup>2</sup>C by writing into the CLS register. However, it is recommended to keep the temperature compensation enabled.

### 6.5.2.2 Undervoltage Protection

The undervoltage protection is only active during steady state operation of the dPOL to prevent nuisance tripping. If the output voltage decreases below the UV threshold and there is no OC fault, the UV fault signal is generated, the dPOL turns off, and the UV bit in the register ST is changed to 0. The dPOL switch-off can be programmed to follow a sequenced or critical turn-off.

### 6.5.2.3 Overtemperature Protection

Overtemperature protection is active whenever the dPOL is powered up. If temperature of the controller exceeds 120°C, the OT fault is generated, dPOL turns off, and the OT bit in the register ST is changed to 0. The dPOL switch-off can be programmed to follow a sequenced or critical turn-off.

If non-latching OTP is programmed, the dPOL will restart as soon as the temperature of the controller decreases below the Overtemperature Warning threshold of 110°C.

### 6.5.2.4 Tracking Protection

Ramp up and down operations are under control by the dPOL. Tracking protection, however, is active only when the output voltage is ramping up. The purpose of the protection is to ensure that the voltage differential between multiple rails being tracked does not exceed 250mV. This protection eliminates the need for external clamping diodes between different voltage rails which are frequently recommended by ASIC manufacturers.

When the tracking protection is enabled, the dPOL continuously compares actual value of the output voltage to its programmed value as defined by the output voltage and its rising slew rate. If absolute value of the difference exceeds 250mV, the tracking fault signal is generated, the dPOL turns off, and the TR bit in the register ST is changed to 0. Both high side and low side switches of the dPOL are turned off instantly (fast turn-off).

The tracking protection can be disabled, if it contradicts requirements of a particular system (for example turning into high capacitive load where rising slew rate is not important). It can be disabled in the dPOL Configure Fault window or directly via the I<sup>2</sup>C bus by writing into the PC1 register.

## 6.5.3 Faults and Margining

Under and Over voltage limits are applicable when output margining is engaged. The percent limit settings apply to the instantaneous ramp values as well as high and low steady state margin values. This is illustrated in Figure 29. The middle polot of  $V_o$  ( $V_{out}$ ) level is the result of a Low Margining command. Note that Tracking is not re-enabled during changes to  $V_{out}$  from margining commands

# DP7130G

Figure 29. Conditions When Types of Protections Are Enabled

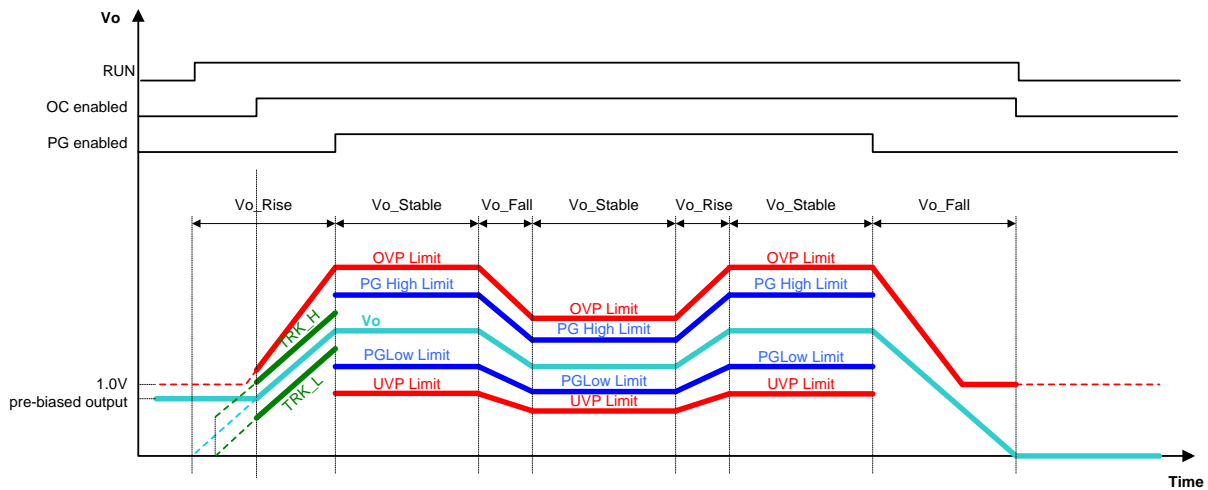

## 6.5.4 Errors

This protection group includes only overvoltage protection.

### 6.5.4.1 Overvoltage Protection

The overvoltage protection is set as a percentage of  $V_{out}$ . It is active whenever the output voltage of the dPOL exceeds the pre-bias voltage (if any). If the output voltage exceeds the overvoltage protection threshold, the overvoltage error signal is generated, the dPOL turns off, and the OV bit in the register ST is changed to 0. The high side switch is turned off instantly, and simultaneously the low side switch is turned on to ensure reliable protection of sensitive loads. The low side switch provides low impedance path to quickly dissipate energy stored in the output filter and achieve effective voltage limitation. The OV threshold can be programmed from 110% to 130% of the output voltage setpoint, but not lower than 0.5V. Also the OV threshold will always be at least 0.25V above the setpoint.

## 6.5.5 Fault and Error Latching

The user has the option of setting up any protection option as either latching/non-latching and propagating or non propagating. Propagation and Latching for each dPOL is set in the GUI (Figure 30), or directly via the I<sup>2</sup>C interface by writing into the PC1 register shown in Figure 31.

Figure 30. dPOL Fault Propagation Option Window

| Type | Fault                   | Output                              | Sequencing               | Controller                          |                 |
|------|-------------------------|-------------------------------------|--------------------------|-------------------------------------|-----------------|
|      | <b>Trigger</b>          | <b>Enable</b>                       | <b>Latching</b>          | <b>Propagate</b>                    | <b>Turn-Off</b> |
|      | Tracking Differential → | <input type="checkbox"/>            | <input type="checkbox"/> | <input checked="" type="checkbox"/> | Critical        |
|      | Over-Temperature →      | <input type="checkbox"/>            | <input type="checkbox"/> | <input checked="" type="checkbox"/> | Sequenced       |
|      | Over-Current →          | <input type="checkbox"/>            | <input type="checkbox"/> | <input checked="" type="checkbox"/> | Critical        |
|      | Under-Voltage →         | <input type="checkbox"/>            | <input type="checkbox"/> | <input checked="" type="checkbox"/> | Sequenced       |
|      | Over-Voltage →          | <input checked="" type="checkbox"/> | <input type="checkbox"/> | <input checked="" type="checkbox"/> | Emergency       |

If the non-latching protection is selected, a dPOL will attempt to restart every 130 ms until the condition that triggered the protection is removed. When restarting, the output voltages follow tracking and sequencing settings.

If the latching type is selected, a dPOL will turn off and stay off. The dPOL can be turned on after 130 ms, if the condition that caused the fault is removed and the respective bit in the ST register was cleared, or the Turn On command was recycled, or the input voltage was recycled.

Figure 31. Protection Configuration Register PC1

| PC1: Protection Configuration Register 1<br>Address: 0x00 |                                  |       |       |       |       |       |       |
|---|----------------------------------|-------|-------|-------|-------|-------|-------|
| R/W-0   | R/W-1                            | R/W-0 | R/W-0 | R/W-0 | R/W-0 | R/W-1 | R/W-1 |
| TRE   | PVE                              | TRC   | OTC   | OCC   | UVC   | OVC   | PVC   |
| Bit 7   |                                  |       |       |       |       |       | Bit 0 |
| <b>TRE:</b> Tracking fault enable                         |                                  |       |       |       |       |       |       |
| Bit 7   | 1 = enabled<br>0 = disabled      |       |       |       |       |       |       |
| <b>PVE:</b> Phase voltage error enable                    |                                  |       |       |       |       |       |       |
| Bit 6   | 1 = enabled<br>0 = disabled      |       |       |       |       |       |       |
| <b>TRC:</b> Tracking Fault Protection Configuration       |                                  |       |       |       |       |       |       |
| Bit 5   | 1 = latching<br>0 = non-latching |       |       |       |       |       |       |
| <b>OTC:</b> Over Temperature Protection Configuration     |                                  |       |       |       |       |       |       |
| Bit 4   | 1 = latching<br>0 = non-latching |       |       |       |       |       |       |
| <b>OCC:</b> Over Current Protection Configuration         |                                  |       |       |       |       |       |       |
| Bit 3   | 1 = latching<br>0 = non-latching |       |       |       |       |       |       |
| <b>UVC:</b> Under Voltage Protection Configuration        |                                  |       |       |       |       |       |       |
| Bit 2   | 1 = latching<br>0 = non-latching |       |       |       |       |       |       |
| <b>OVC:</b> Over Voltage Protection Configuration         |                                  |       |       |       |       |       |       |
| Bit 1   | 1 = latching<br>0 = non-latching |       |       |       |       |       |       |
| <b>PVC:</b> Phase Voltage Protection Configuration        |                                  |       |       |       |       |       |       |
| Bit 0   | 1 = latching<br>0 = non-latching |       |       |       |       |       |       |

## 6.5.6 Fault and Error Turn Off Control

In the GUI dPOL Fault dialog is a column of spin controls which set the Turn-Off style OT, UV and OV events. The choices are defined as:

**Sequenced:** Outputs shut down according to ramp down rate control settings. This is the method used when a dPOL is told to do a normal, controlled shut down.

**Critical:** Both high side and low side switches of the dPOL are turned off instantly

**Emergency:** The high side switch is turned off instantly, and simultaneously the low side switch is turned on to ensure reliable protection of sensitive loads

## 6.5.7 Fault and Error Status

Status of dPOL protection logic is stored in the dPOL's ST register shown in Figure 32.

When Status monitoring is enabled for a group, the DPM will read this register and make the information available for uses such as GUI Monitor display.

Figure 32. Protection Status Register ST

| ST: Status register<br>Address: 0x16                               |  |                     |                     |                     |                     |                     |                     |
|--|--|---------------------|---------------------|---------------------|---------------------|---------------------|---------------------|
| R-1  | R-0  | R/W-1 <sup>1)</sup> | R/W-1 <sup>1)</sup> | R/W-1 <sup>1)</sup> | R/W-1 <sup>1)</sup> | R/W-1 <sup>1)</sup> | R/W-1 <sup>1)</sup> |
| TW   | PG   | TR                  | OT                  | OC                  | UV                  | OV                  | PV                  |
| Bit 7  |  |                     |                     |                     |                     |                     | Bit 0               |
| Bit 7  | <b>TW:</b> Temperature Warning               |                     |                     |                     |                     |                     |                     |
| Bit 6  | <b>PG:</b> Power Good Warning (high and low) |                     |                     |                     |                     |                     |                     |
| Bit 5  | <b>TR:</b> Tracking Fault                    |                     |                     |                     |                     |                     |                     |
| Bit 4  | <b>OT:</b> Over Temperature Fault            |                     |                     |                     |                     |                     |                     |
| Bit 3  | <b>OC:</b> Over Current Fault                |                     |                     |                     |                     |                     |                     |
| Bit 2  | <b>UV:</b> Under Voltage Fault               |                     |                     |                     |                     |                     |                     |
| Bit 1  | <b>OV:</b> Over Voltage Error                |                     |                     |                     |                     |                     |                     |
| Bit 0  | <b>PV:</b> Phase Voltage Error               |                     |                     |                     |                     |                     |                     |
| Note: an activated fault is encoded as '0'                         |  |                     |                     |                     |                     |                     |                     |
| Writing a '1' into a fault/error bit clears a latching fault/error |  |                     |                     |                     |                     |                     |                     |

# DP7130G

## 6.5.8 Fault and Error Propagation

The feature adds flexibility to the fault management scheme by giving users control over propagation of fault signals within and outside of the system. The propagation means that a fault in one dPOL can be programmed to turn off other dPOLs and devices in the system, even if they are not directly affected by the fault.

### 6.5.8.1 Fault Propagation

When propagation is enabled, the faulty dPOL pulls its OK pin low. This signals to the DPM and any other dPOL connected to that signal, that the dPOL has a Fault or Error condition. A low OK line initiates turn-off of other dPOLs connected to the same OK line with the same turn-off behavior as the faulty dPOL. The turn-off type is encoded into the OK line when it transitions from high to low.

### 6.5.8.2 Grouping of dPOLs

d-pwer® dPOLs can be arranged in groups of up to 4, 8, 16 or 32 dPOLs (depending upon the DPM model used). Membership in a group is set in the GUI in the **DPM / Configure / Devices** dialog, and implemented in hardware by connecting the OK pins of each dPOL in the group to the matching OK input on the DPM.

In order for a particular Fault or Error to propagate, Propagation needs to be checked in the GUI dPOL **Configure / Fault Management Window**. This read in the dPOLs PC3 register shown in Figure 33.

Figure 33. Protection Configuration Register PC3

| PC3: Protection Configuration Register 3 |   |       |       |       |       |       |       |
|--|---|-------|-------|-------|-------|-------|-------|
| Address: 0x02                            |   |       |       |       |       |       |       |
| U  | U   | R/W-1 | R/W-1 | R/W-1 | R/W-1 | R/W-1 | R/W-1 |
| ---                                      | ---   | TRP   | OTP   | OCP   | UVP   | OVP   | PVP   |
| Bit 7                                    |   |       |       |       |       |       | Bit 0 |
| Bit 7:6                                  | <b>Unimplemented:</b> Read as '0'                   |       |       |       |       |       |       |
|  | <b>TRP:</b> Tracking Protection Propagation         |       |       |       |       |       |       |
| Bit 5                                    | 0 = disabled<br>1 = enabled                         |       |       |       |       |       |       |
|  | <b>OTP:</b> Over Temperature Protection Propagation |       |       |       |       |       |       |
| Bit 4                                    | 0 = disabled<br>1 = enabled                         |       |       |       |       |       |       |
|  | <b>OCP:</b> Over Current Protection Propagation     |       |       |       |       |       |       |
| Bit 3                                    | 0 = disabled<br>1 = enabled                         |       |       |       |       |       |       |
|  | <b>UVP:</b> Under Voltage Protection Propagation    |       |       |       |       |       |       |
| Bit 2                                    | 0 = disabled<br>1 = enabled                         |       |       |       |       |       |       |
|  | <b>OVP:</b> Over Voltage Protection Propagation     |       |       |       |       |       |       |
| Bit 1                                    | 0 = disabled<br>1 = enabled                         |       |       |       |       |       |       |
|  | <b>PVP:</b> Phase Voltage Protection Propagation    |       |       |       |       |       |       |
| Bit 0                                    | 0 = disabled<br>1 = enabled                         |       |       |       |       |       |       |

Note that the turn-off type of the fault as it propagates through the DPM will remain unchanged. Propagation options for dPOLs can be read or set in the dPOL PC3 register shown in Figure 34.

Figure 34. DPM Configure Faults Window

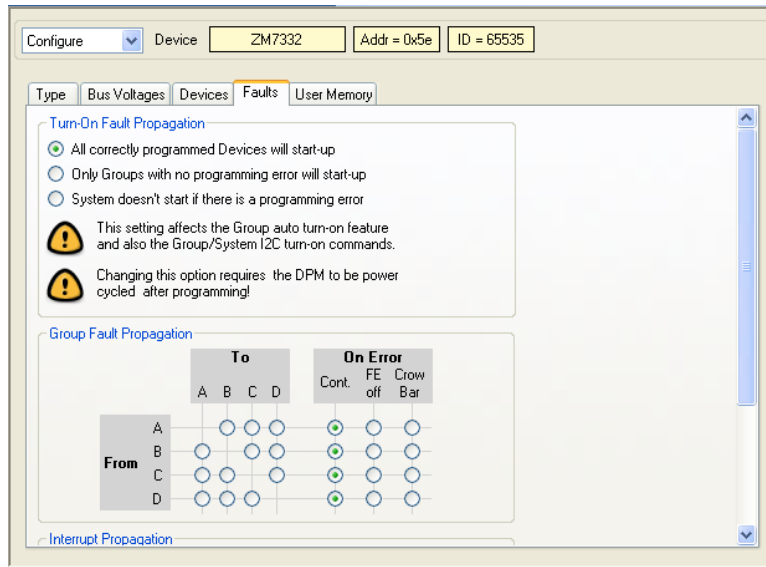

### 6.5.8.3 Front End and Crowbar

If an error is propagated to at least the Group level, the DPM can also be configured to generate commands to turn off a front end (a DC-DC converter generating the intermediate bus voltage) and to trigger an optional crowbar protection to accelerate removal of the IBV voltage.

### 6.5.8.4 Fault Propagation Examples

Understanding Fault and Error propagation is easier with the following examples.

The First example is of non-propagation from a dPOL, as shown in Figure 35. An undervoltage error shuts down the Vo, but since propagation was not enabled, OK-A is not pulled down and Vo2 stays up.

Figure 35. In Group Fault Propagation

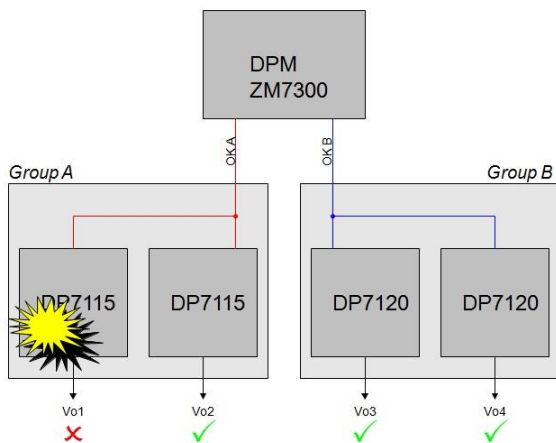

Figure 36. Turn-On into UVP on V3. The UV Fault Is Programmed To Be Non-Latching. Ch1 – Vo1, Ch2 – Vo2(Group A), Ch3 – Vo3 (Group B) Vo4 not shown.

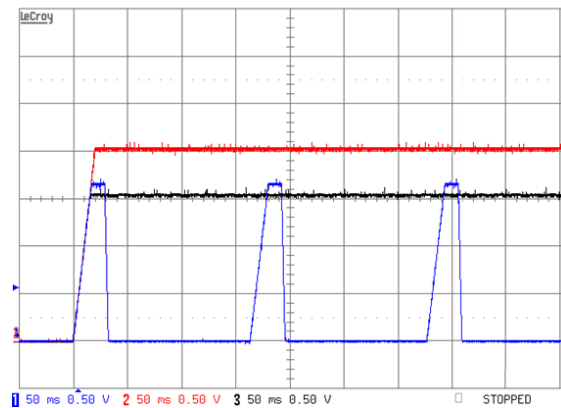

Figure 36 shows a scope capture an actual system when undervoltage error detection is set to not propagate.

In this example, the dPOL connected to scope Ch 1 encounters the undervoltage fault after turn-on. Because fault propagation is not enabled for this dPOL, it alone turns off and generates the UV fault signal. Because a UV fault triggers the sequenced turn-off, the dPOL meets its turn-off delay and falling slew rate settings during the turn-off process as shown in the trace for Ch1. Since the UV fault is programmed to be non-latching, the dPOL will attempt to restart every 130 ms, repeating the process described

# DP7130G

above until the condition causing the undervoltage is removed. The 130ms hiccup interval is guaranteed regardless of the turn-off delay setting.

The next example is intra-group propagation, the dPOL propagates its fault or error events. Here fault propagation between dPOLs is enabled.

In Figure 37 the dPOL powering output Vo1 again encounters an undervoltage error. It pulls its OK line low. Since the dPOL powering output Vo2 (Ch3 in the picture) belongs to the same group (A in this case), pulling down OK-A tells that dPOL to execute a regular turn-off.

Figure 37. Intra Group Fault Propagation

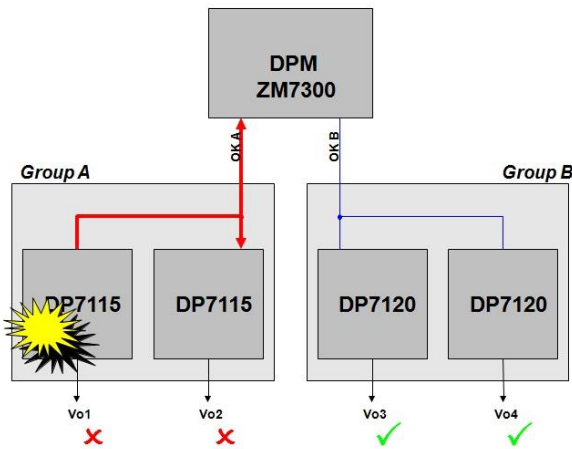
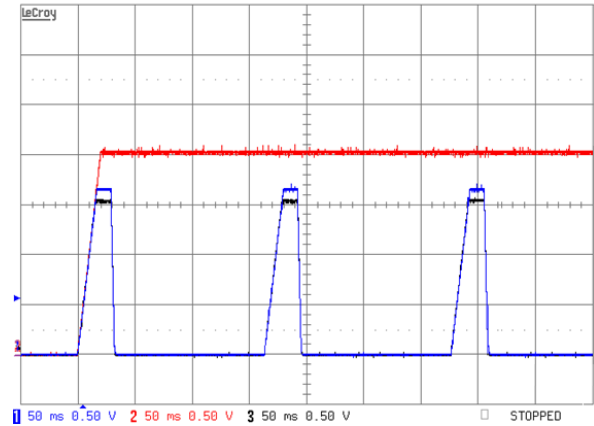

Figure 38. Turn-On into UVP on V3. The UV Fault Is Programmed To Be Non-Latching and Propagate From Group C to Group A. Ch1 - V3 (Group C), Ch2 - V2, Ch3 - V1 (Group A)



Since both Vo1 and Vo2 have the same delay and slew rate settings they will continue to turn off and on synchronously every 130ms as shown in Figure 38 until the condition causing the undervoltage is removed.

Note that the dPOL powering the output Vo2 (Ch3) actually reaches its voltage set point before the error in Vo1 is detected.

The turn-off type of a dPOL fault/error as propagated by the faulty dPOL via the OK line is propagated through the DPM to other dPOLs connected to other Groups through its connection to their OK line or lines.

This behavior assures that all dPOLs configured to be affected through Group linkages will switch off with the same turn-off type.

## 6.5.9 Protection Summary

A summary of protection support, their parameters and features, are shown in Table 2.

Table 2. Summary of Protection Parameters and Features

| CODE | NAME                | TYPE    | WHEN ACTIVE                    | TURN OFF | LOW SIDE SWITCH | PROPAGATION           | DISABLE |
|------|---------------------|---------|--------------------------------|----------|-----------------|-----------------------|---------|
| TW   | Temperature Warning | Warning | Whenever $V_{IN}$ is applied   | No       | N/A             | Status Bit            | No      |
| PG   | Power Good          | Warning | During steady state            | No       | N/A             | PG                    | No      |
| TR   | Tracking            | Fault   | During ramp up                 | Fast     | Off             | Critical              | Yes     |
| OT   | Overtemperature     | Fault   | Whenever $V_{IN}$ is applied   | Regular  | Off             | Sequenced or Critical | No      |
| OC   | Overcurrent         | Fault   | When $V_{OUT}$ exceeds prebias | Fast     | Off             | Critical              | No      |
| UV   | Undervoltage        | Fault   | During steady state            | Regular  | Off             | Sequenced or Critical | No      |
| OV   | Overvoltage         | Error   | When $V_{OUT}$ exceeds prebias | Fast     | On              | Critical or Emergency | No      |



# DP7130G

## 6.6 OK FAULT AND ERROR CODING

d-pwer® dPOLs have an additional functionality added to the OK line signal. The OK line is used to propagate and receive information from other devices in the power system belonging to the same group as to the kind of turn-off procedure a device has initiated because of a fault.

Figure 39 shows the three types of OK encoding. The bubbles show when the SD and OK line logic levels are sampled by dPOL and DPM logic.

Figure 39. OK Severity Encoding Waveforms

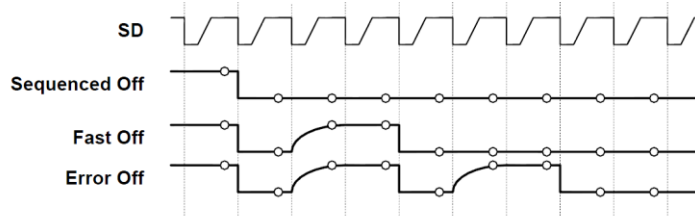

Note that the OK line state changes are always executed by dPOLs at the negative edge of the SD line.

The chart shows shut down response types as the user can select the kind of response desired for each type of Fault or Error (within the limits of choice provided for each type of Fault or Error). All dPOL devices in the same Group are expected to trigger the same turn-off procedure in order to maintain overall tracking of output voltages in the system. And when fault propagation is set to go from one group to another, the encoding is passed along un-changed.

## 6.7 SWITCHING AND COMPENSATION

d-pwer® dPOLs utilize the digital PWM controller. The controller enables users to program most of the PWM performance parameters, such as switching frequency, interleave, duty cycle, and feedback loop compensation.

### 6.7.1 Switching Frequency

Each dPOL is equipped with a PLL that locks to the 500 KHz SD signal which is generated by the DPM. This sets up for switching actions to be synchronous to the falling edge of SD by all dPOLs, which are thereby kept coordinated to each other.

The switching frequency for the DP7130G *cannot* be changed through the GUI. Switching at 1MHz is not supported in this model. *Bypassing or the GUI to set 1MHz switching is not recommended.*

Although synchronized to SD, switching frequencies of each dPOL in a system is independent of every other dPOL, with the exception of shared load bus groups, where are dPOLs sharing the load are forced to use the same frequency by the GUI. Working around this restriction is not recommended.

Figure 40. Controller Compensation Window

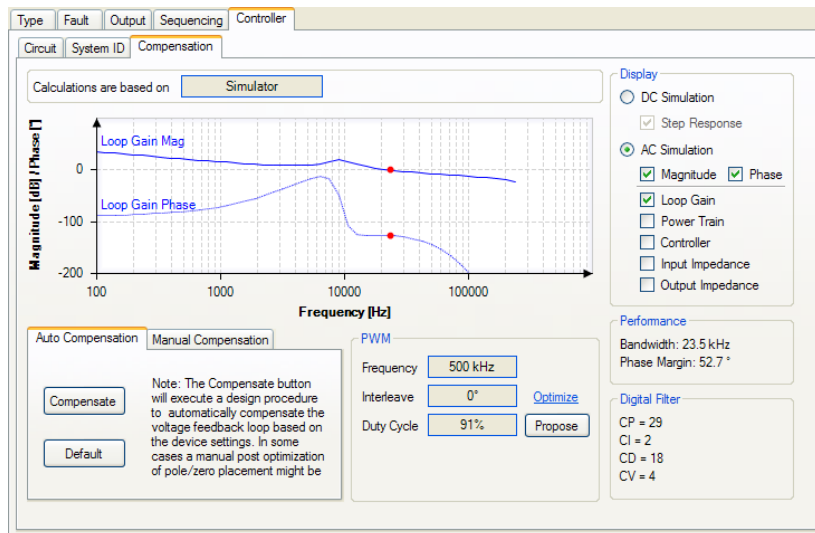

+1.866.513.2839

tech.support@psbel.com

belpowersolutions.com

# DP7130G

In some applications, switching at higher frequencies is desirable even though efficiency is lower, because it allows for better transient response or lower application system noise.

## 6.7.2 Interleave Selection

Within the same PWM dialog is the switching Interleave control. Interleave is defined as a phase delay between the synchronizing slope of the master clock on the SD pin and the start of each dPOL PWM cycle. This parameter can be programmed in the dPOL Controller Configure Compensation window or directly via the I<sup>2</sup>C bus by writing into the INT register in 22.5° steps.

Figure 41. Interleave Configuration Register INT

|   |             |            |            |             |             |             |             |
|---|-------------|------------|------------|-------------|-------------|-------------|-------------|
| INT: Interleave Configuration<br>Address: 0x04  |             |            |            |             |             |             |             |
| R   | R           | R/W-0      | U          | R/W-0       | R/W-0       | R/W-0       | R/W-0       |
| <b>PHS1</b>   | <b>PHS0</b> | <b>FRQ</b> | <b>---</b> | <b>INT3</b> | <b>INT2</b> | <b>INT1</b> | <b>INT0</b> |
| Bit 7   |             |            |            |             |             |             | Bit 0       |
| <p><b>PHS[1:0]:</b> Phase selection<br/>           0 = Single phase (PWM0)<br/>           1 = Dual phase (PWM0 and PWM2)<br/>           2 = Triple phase (PWM0, PWM1 and PWM2)<br/>           3 = Quad phase (PWM0, PWM1, PWM2 and PWM3)</p> <p><b>FRQ:</b> PWM frequency selection<br/>           0 = 500 KHz (default)<br/>           1 = 1000 KHz (<i>not allowed for DP7130</i>)</p> <p><b>Unimplemented:</b> Read as '0'</p> <p><b>INT[3:0]:</b> PWM interleave phase with respect to SD line<br/>           0x00 = 0° phase lag<br/>           0x01 = 22.5° phase lag<br/>           0x02 = 45° phase lag<br/>           ...<br/>           0x1F = 337.5° phase lag</p> |             |            |            |             |             |             |             |
| Bit 7:6   |             |            |            | Bit 5       |             |             |             |
| Bit 3:0   |             |            |            |             |             |             |             |

## 6.7.3 Interleave and Input Bus Noise

When a dPOL turns on its high side switch there is an inrush of current. If no interleave is programmed, inrush current spikes from all dPOLs in the system reflect back into the input source at the same time, adding together as shown in Figure 42.

Figure 42. Input Voltage Noise, No Interleave

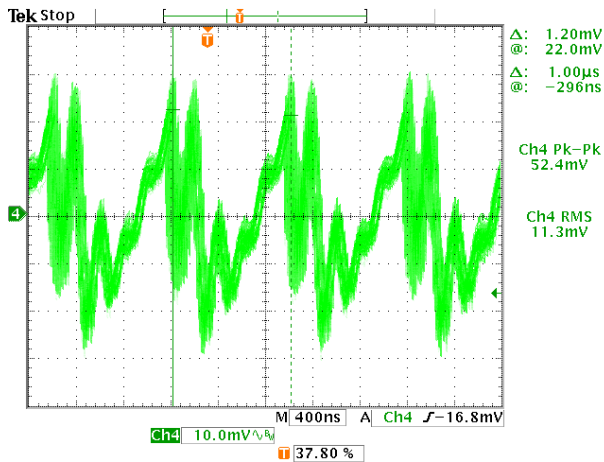
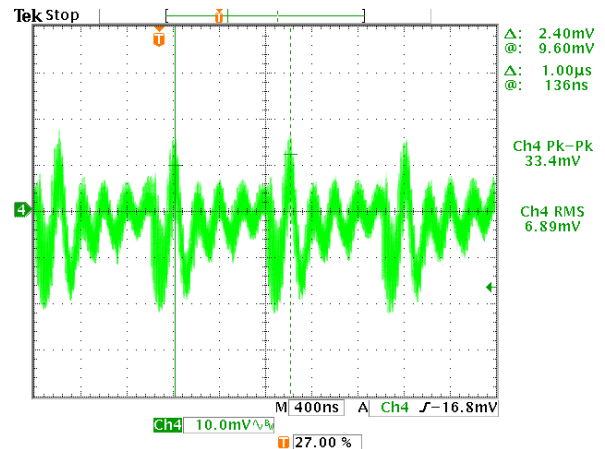

Figure 43. Input Voltage Noise with Interleave



# DP7130G

Figure 43 shows the input voltage noise of the three-output system with programmed interleave. Instead of all three dPOLs switching at the same time as in the previous example, the switching cycle of dPOLs V1, V2, and V3 start at 67.5°, 180°, and 303.75° of phase delay, respectively. Noise is spread evenly across the switching cycle resulting in more than 1.5 times reduction.

Similar noise reduction can be achieved with the output of dPOLs connected in parallel. Figure 44 and Figure 45 show the output noise of two dPOLs connected in parallel without and with a 180° interleave, respectively. Resulting noise reduction is more than 2 times and is equivalent to doubling switching frequency or adding extra capacitance on the output of the dPOLs.

Figure 44. Output Voltage Noise, Full Load, No Interleave

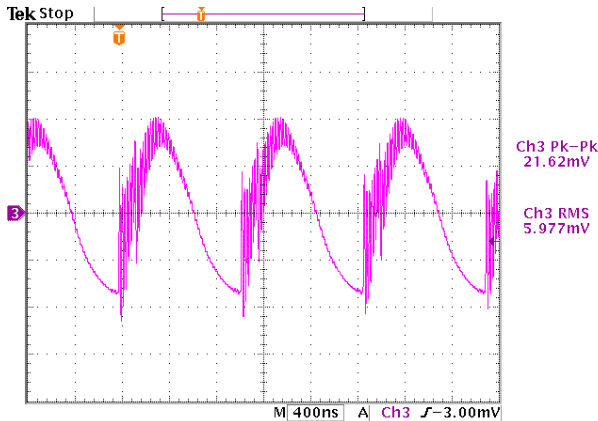
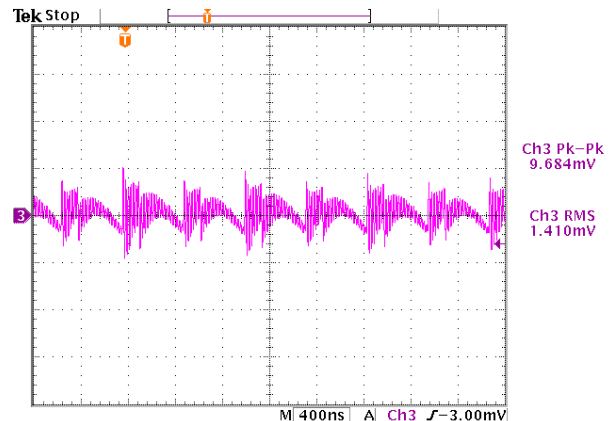

Figure 45. Output Voltage Noise, Full Load, 180° Interleave



## 6.7.4 Duty Cycle Limit

The DP7130G is a step-down converter therefore  $V_{OUT}$  is always less than  $V_{IN}$ . The relationship between the two parameters is characterized by the duty cycle and can be estimated from the following equation:

$$DC = \frac{V_{OUT}}{V_{IN}}$$

Where, DC is the duty cycle,  $V_{OUT}$  is the required maximum output voltage (including margining),  $V_{IN,MIN}$  is the minimum input voltage. The dPOL controller sets PWM duty cycle higher or lower than the above to compensate for drive train losses or to pull excess charge out of the output filter to keep the output voltage where it is supposed to be.

A side effect of PWM duty cycle is it also sets the rate of change of current into the output filter. A high limit helps deal with transients. However, if this is too high, an overcurrent alarm can be tripped. Thus DC limiting must be a compromise between supplying drive train losses and avoiding nuisance trips from transient load responses.

The duty cycle limit can be programmed in the GUI PWM Controller window Figure 40 or directly via the I<sup>2</sup>C bus by writing into the DCL register as shown in Figure 46.

Figure 46. Duty Cycle Limit Register

|   |             |             |             |             |             |       |     |
|---|-------------|-------------|-------------|-------------|-------------|-------|-----|
| DCL: Duty Cycle Limitation                |             |             |             |             |             |       |     |
| Address: 0x09                             |             |             |             |             |             |       |     |
| R/W-1                                     | R/W-1       | R/W-1       | R/W-0       | R/W-1       | R/W-0       | U     | U   |
| <b>DCL5</b>                               | <b>DCL4</b> | <b>DCL3</b> | <b>DCL2</b> | <b>DCL1</b> | <b>DCL0</b> | ---   | --- |
| Bit 7                                     |             |             |             |             |             | Bit 0 |     |
| <b>DCL[5:0]: Duty Cycle Limitation</b>    |             |             |             |             |             |       |     |
| 0x00 = 0                                  |             |             |             |             |             |       |     |
| 0x01 = 1/64                               |             |             |             |             |             |       |     |
| 0x02 = 2/64                               |             |             |             |             |             |       |     |
| ...                                       |             |             |             |             |             |       |     |
| 0x1F = 63/64                              |             |             |             |             |             |       |     |
| Bit 1:0 <b>Unimplemented:</b> Read as '0' |             |             |             |             |             |       |     |

# DP7130G

## 6.7.5 Feedback Loop Compensation

Programming feedback loop compensation allows optimizing dPOL performance for various application conditions. For example, increase in bandwidth can significantly improve dynamic response.

The dPOL controller implements a programmable PID (Proportional, Integral, and Derivative) loop filter configured by digital values to shape the closed loop transfer function for desired bandwidth and phase/gain margin.

Feedback loop compensation can be programmed in the GUI PWM Controller window by setting Kr (Proportional), Ti (Integral), Td (Derivative), and Tv (Derivative roll-off) parameters or directly writing into the respective registers (CP, CI, CD, B1). Note that the coefficient Kr and the timing parameters (Ti, Td, Tv) displayed in the GUI do not map directly to the register values. It is therefore strongly recommended to use only the GUI to set the compensation values.

The GUI offers 3 ways to compensate the feedback loop:

**Auto-Compensation:** The GUI will calculate compensation settings from either information entered as to output capacitors in the application circuit, or, if the SysID function has been run, the frequency response measured through the SysID function in the target dPOL. This method is usually sufficient, but is sensitive to accurate accounting of capacitor values and esr. The GUI displays the results of running Auto-Compensation as a set of graphs and compensation values.

**Manual Compensation:** The GUI supports manually adjusting feedback compensation parameters. As the parameters are changed the GUI recalculates expected frequency and phase performance.

**System Identification (SysID) and Auto-Compensation:** Hardware built into the dPOL controller that injects pseudo random bit sequence (PRBS) noise into PWM calculations and observes the response of the output voltage. The GUI collects this data and calculates actual system frequency response. Having frequency response data allows the Auto-Compensation function to have a better idea of actual output filter characteristics when it calculates feedback coefficients.

Using noise to plumb the output filter requires current values for compensation be good enough that injected signal can be extracted from system noise and the added noise does not trip a fault or error response. A moderately workable solution for compensation must be obtained by calculating from assumed system component values before invoking SysID.

## 6.8 TRANSIENT RESPONSE

The picture below shows the deviation of the output voltage in response to alternating 25 / 75 % rated load step loads applied at  $1A/\mu s$ . In all tests the DP7130G converters had the switching frequency of 500 KHz and a total of  $1 \times 47\mu F$  ceramic and  $5 \times 470\mu F$  tantalum polyester capacitors connected across the output pins. Bandwidth of the feedback loop was programmed for over-damped transient response.

Figure 47. Transient Response with Regulation set to 0.0 mv/A.

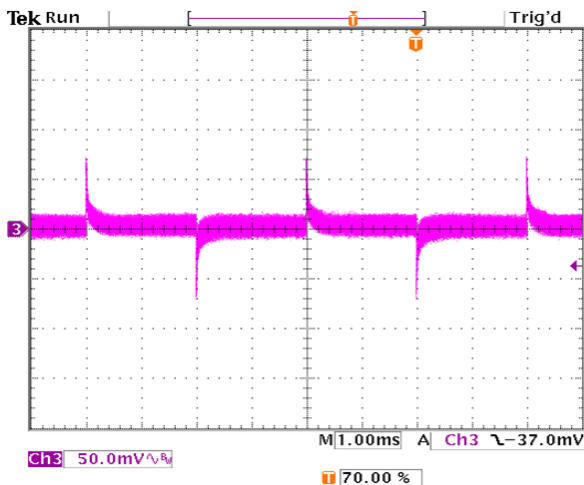
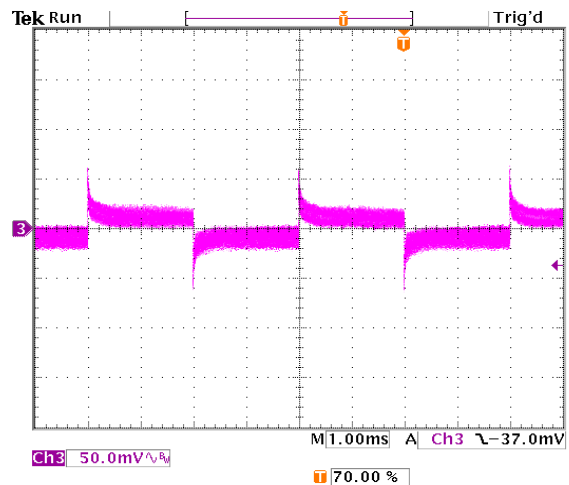

Figure 48. Transient Response with Regulation set to 1.89 mv/A.



As noted earlier, increasing the Load Regulation parameter provides load dependant dynamic load positioning. This shows up in the following figure.

# DP7130G

## 6.9 LOAD CURRENT SHARING

The DP7130G is equipped with a patented active digital current share function. Setting up for current sharing requires both hardware and software configuration actions.

To set up for the current sharing, interconnect the CS pins of the dPOLs that are to share the load in parallel. This pulse width modulated digital signal drives the output currents of all dPOLs to approximately the same level (the dominant, or master dPOL will tend to carry slightly more of the load than the others).

In addition to the CS interconnection, the DPM must be informed of the sharing configuration. This is done in the **DPM / Configure / Devices** window shown in Figure 50. Just to the right of each dPOL address, set the spin control to one of 10 possible sharing busses (the number is an accounting aid for firmware.)

The GUI automatically copies common parameters changed in one dPOL's setup information into all dPOLs connected to the parallel bus. Some parameters, such as load sharing, must be set independently.

### 6.9.1 CS and Regulation

Load Regulation is an important part of setting up two or more dPOLs to share load. The dPOL designated the "master" should have a lower Load Regulation setting than the other dPOL(s) connected to its sharing bus.

In operation, the negative CS duty cycle in each dPOL is proportional to the unit's load current. As the loading goes up, the negative period gets wider. A dPOL which sees CS duty greater than its internally calculated value will increase its output voltage to increase its load share.

Non-zero regulation, on the other hand, tends to lower output voltage as loading increases. It also tends to retard the calculated CS period. The effect of these two actions, regulation and CS tracking, cause the dPOL or dPOLs with higher regulation values to track the loading of the dPOL with a lower regulation value. The Load Regulation setting insures the master will carry a slightly higher share of the common load.

Load Regulation is set in the **Device / Configure / Output** dialog as noted earlier. Best sharing is done when the slave devices have two to three steps higher Load Regulation values. Less and sharing is slightly unstable (ripple noise increases), more regulation and sharing becomes much less equal. Note that the GUI does not automatically bump up regulation for dPOLs attached to the same regulation bus. This must be done by hand. Also, it is recommended that the dPOL closest to the biggest load element on the shared output bus be set up to act as the group's master.

### 6.9.2 CS and Interleave

Since shared busses tend to have relatively high currents, interleaving switching of shared bus dPOLs is generally desirable. The lowest noise generation is usually achieved when shared bus dPOL interleave phasing is set to approximately equally spaced intervals.

## 6.10 MONITORING

Along with status information, dPOL converters can monitor their own performance parameters such as output voltage, output current, and temperature.

The output voltage is measured at the output sense pins, output current is measured using the ESR of the output inductor and temperature is measured by the thermal sensor built into the controller IC. Output current readings are adjusted based on temperature readings to compensate for the change of ESR of the inductor with temperature.

A 12-Bit Analog to Digital Converter (ADC) converts the output voltage, output current, and temperature into a digital signal to be transmitted via the serial interface (12Bits for the Voltage, 8 Bits for the Current and Temperature).

Monitored parameters are stored in registers (VOM, IOM, and TMON) that are continuously updated in the DPM at a fixed refresh rate of 1sec. These monitoring values can be accessed via the I<sup>2</sup>C interface with high and low level commands as described in the "DPM Programming Manual".

Shown in Figure 49 is a capture of the GUI System Monitor while operating the ZM7300 Evaluation board.

+1.866.513.2839

tech.support@psbel.com

[belpowersolutions.com](http://belpowersolutions.com)

# DP7130G

## 6.10.1 In System Monitoring

In system parametric and status monitoring is implemented through the I<sup>2</sup>C interface. The appropriate protocols are covered in the ZM7300 DPM Programming Manual. The GUI uses the published commands.

In writing software for I<sup>2</sup>C bus transactions, it is important to note that I<sup>2</sup>C responses are lower in priority in DPM operation than SD bus transactions. If an I<sup>2</sup>C transaction overlaps an SD bus transaction, the DPM will put the I<sup>2</sup>C bus on "hold" until it completes its SD activity. The GUI is aware of this and such delays are transparent.

When directly polling dPOLs for information, setting I<sup>2</sup>C bus timeouts too low can cause hangups where the DPM is waiting for the I<sup>2</sup>C master to complete a transaction and the master has timed out. To avoid such timeout related problems, set I<sup>2</sup>C interface timeout to greater than the time required for polling all dPOLs, or 150ms (whichever is greater). See the programming manual referenced above for the equation used to calculated worst case polling duration.

Figure 49. DPM Monitoring Window

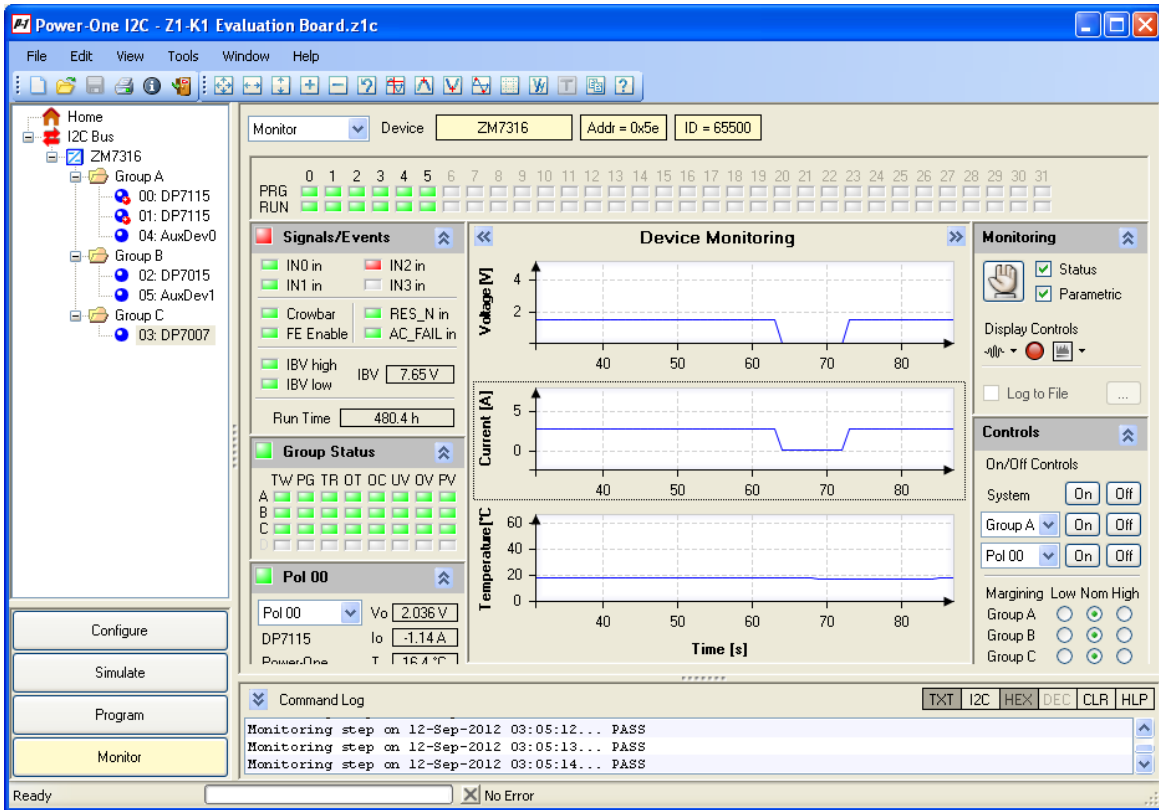

# DP7130G

## 7. ADDING DPOLS INTO THE SYSTEM

dPOL converters are added to a d-pwer® system through the DPM Configuration/Devices dialog. Clicking on an empty address location brings up a menu which allows specifying which dPOL type is needed. Figure 50 below is an example using all of the DP7000 series devices currently offered.

Note that Auto-On, P-Monitor and S-Monitor options are only configurable by Group, and not by individual dPOL configuration. These options affect only DPM behavior. Enabling them does not burden a dPOL.

**Auto-On** sets a group to turn on once all IBV power is available and dPOLs are configured.

**P-Monitor** enables periodic query of Vout, Iout and Temp values from each dPOL in the group where it is enabled (dPOLs will always measure these parameters in an ongoing basis even if Vout is not enabled).

**S-Monitor** enables periodic query of dPOL Status. While a DPM will always be able to detect a low OK condition, it requires this option enabled for Monitor function to query status registers.

Figure 50 Evaluation Board Configuration Showing Current Share Bus Assignment

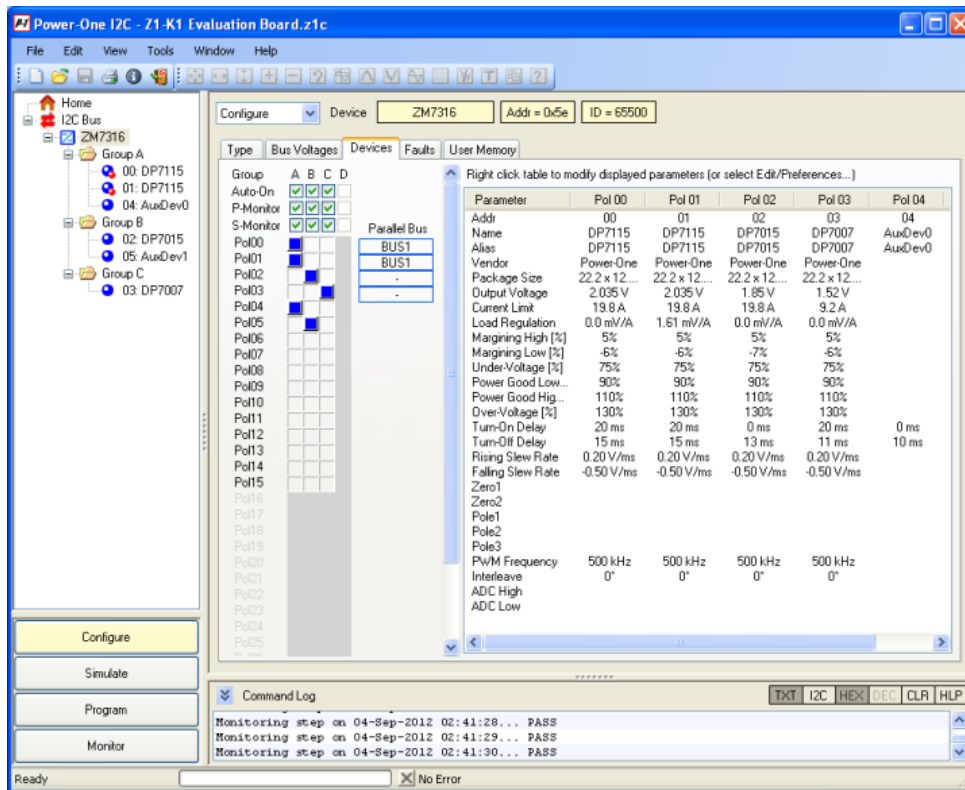

## 8. TESTING FAULT AND ERROR RESPONSE

Included in the architecture of d-pwer® dPOLs is a mechanism for simulating errors and faults. This allows the designer to test their response configuration without actually needing to induce the fault.

The Bel Power Solutions GUI supports this feature in the Monitor window when monitoring is active (See Figure 51). When monitoring is off, the Fault Injection control boxes are disabled and grayed out.

# DP7130G

Figure 51. Fault Injection Controls In Monitor Window

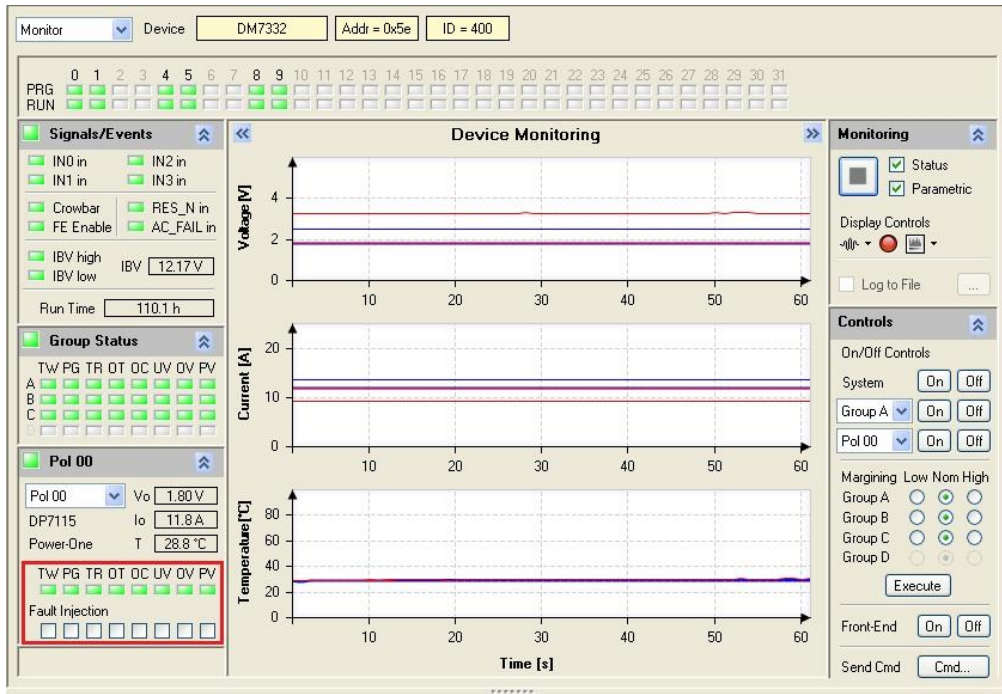

Fault injection into a dPOL requires selecting that dPOL in the POL status dialog in the left column of the Monitoring dialog window. As long as the checkbox is checked, the fault trigger is present in the dPOL. An injected fault is handled by the dPOL in the same fashion as an actual fault. It therefore gets propagated to the other dPOLs / Groups and shuts down in the programmed way the dPOL/Group/System as programmed for that fault.

Figure 52. Example Overtemp Fault Injection in the GUI

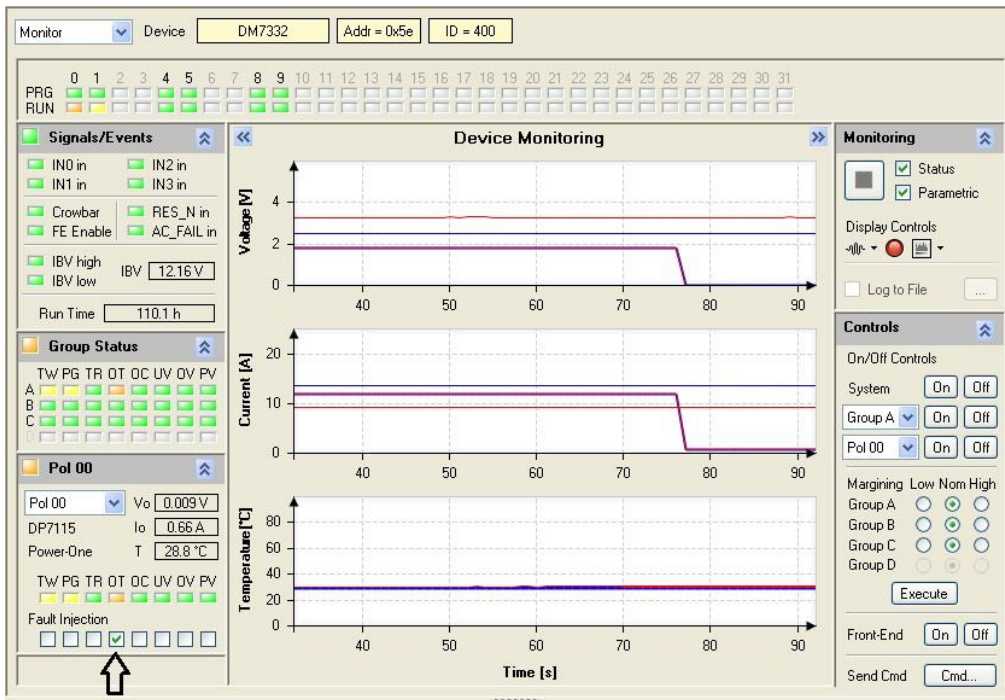

+1.866.513.2839

tech.support@psbel.com

belpowersolutions.com



# DP7130G

In Figure 52 we see the effects of injecting an Overtemp (OT) fault. Note that dPOL-0 shows an OT fault. dPOL-0 and -1 are in the same Group and fault propagation for the dPOL is to propagate to the group. dPOL -4 and above are in Groups B and C. Propagation is not enabled from Group A to B.

The OT fault shows up as an orange indicator in the dPOL and RUN status LEDs. Group LEDs show yellow, indicating all of the members of the group have shut down.

Fault recovery depends whether the fault is a latching or non-latching fault:

A non latching fault is cleared by unchecking the checkbox (clears the fault trigger). The dPOL will re-start after the 130ms time out of non-latching faults (hiccup time) (Group and System follows restart).

Latching faults clear in one of two ways. The first method is to clear the fault trigger (uncheck the checkbox) (note: the dPOL remains off since the fault is latching).

Alternately, a latched fault can be cleared by toggling the EN pin or by commanding the dPOL to turn-off and turn-off again via the GUI interface (obviously more convenient). Therefore, once the fault trigger is cleared, click the "Off" button of the dPOL or Group (clears the fault, status LEDs turn back to green) and then the "On" button of the dPOL or Group to re-enable it.

## 9. APPLICATION

Shown in Figure 53 is a block diagram of a multiple dPOL power system. The key interconnections needed between the DPM and the dPOLs are Intermediate Voltage Bus (IBV), SD, OK (A - D), and, between the first two dPOLs which share a bus load, their CS connections. Each dPOL has its own output bulk filter capacitors. This illustrates how simple a dPOL based system is to implement in hardware. SD provides synchronization of all dPOLs as well as communication. PG, not shown, is optional, though this is usually used with auxiliary power supplies that are not digitally controlled.

Figure 53. Multi-dPOL Power System Diagram

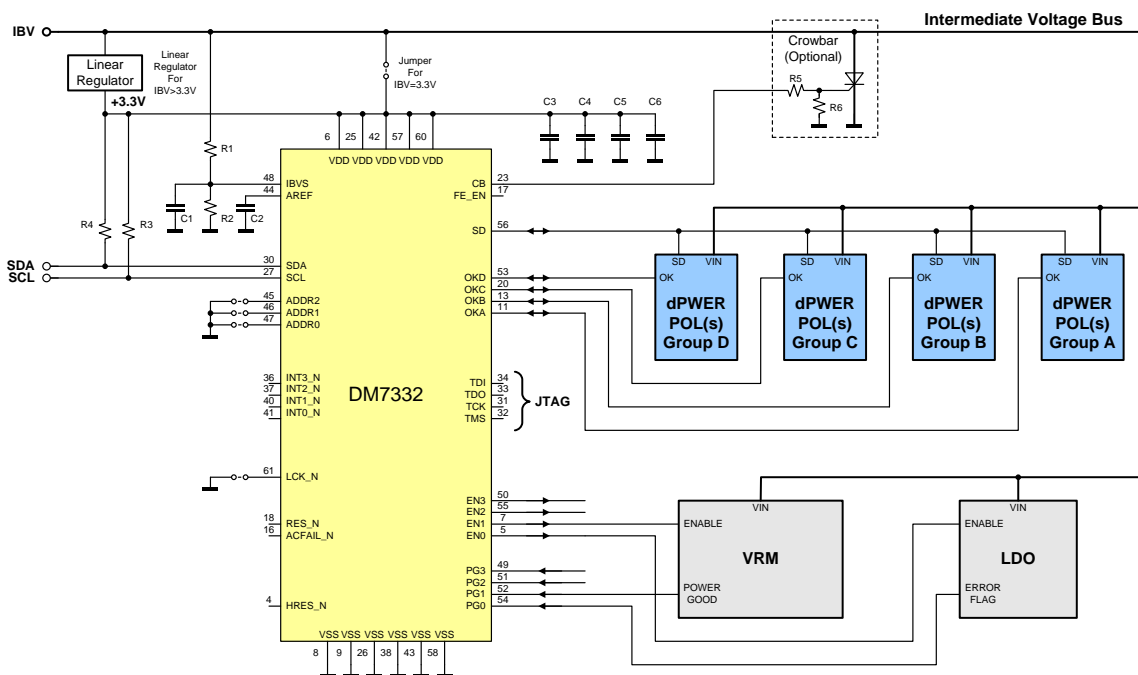

Shown in Figure 54 is a schematic of a typical application of a DP7130G point-of-load converters. The system includes a DM7300 series Digital Power Manager (DPM), at least one DP7130G dPOL, and may include additional DP7130G dPOLs and other d-power® series dPOLs. All dPOLs are connected to the DPM and to each other via a single-wire SD (sync/data) line.

The SD line provides synchronization of all dPOLs to the master clock generated by the DPM and simultaneously performs data transfer between dPOLs and the DPM. Each dPOL has a unique 5-bit address programmed by grounding respective address pins. To enable the current sharing, CS pins of dPOLs connected in parallel are interconnected.

In addition to the SD line, the DP7130G is connected to OK-A. Any other dPOLs added should connect their OK pins to the OK pins of the DPM associated with their respective Group assignments.

The type, value, and the number of output capacitors shown in the schematic are required to meet the specifications published in the data sheet. However, DP7130G dPOLs are fully operational with different configurations of output capacitors. The feedback loop compensation may need to be adjusted to optimize performance of the dPOLs for specific parameters of the output capacitors.

+1.866.513.2839

tech.support@psbel.com

belpowersolutions.com

# DP7130G

The supervisory reset circuit in the above diagram, U2, is recommended for systems where the 3.3V supply to the DPM does not turn on faster than 0.5 V/ms.

**Note:** The DP7130G is footprint compatible with the ZY7120—No change in PCB is needed to upgrade to d-pwer® parts. However, configuration data must be altered through the Bel Power Solutions I<sup>2</sup>C GUI and programmed into the DPM. *Mixing ZY and DP series devices is not recommended. All parts must be upgraded.*

Figure 54: Block Diagram of Typical Multiple Output Application with Digital Power Manager and I2C Interface

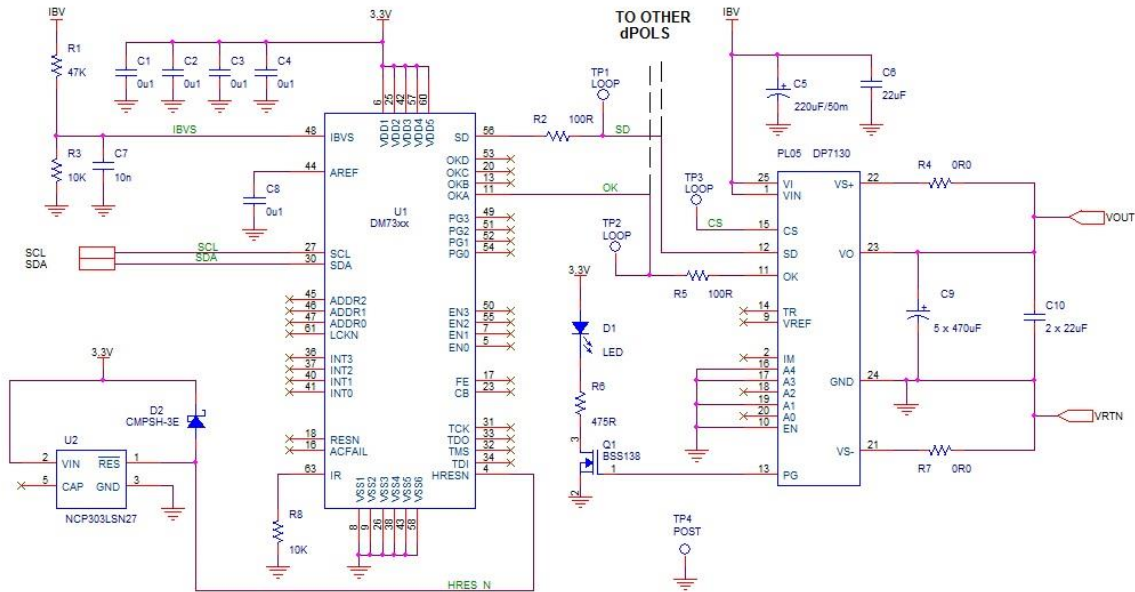

## 10. SAFETY

The DP7130G dPOL converters **do not provide isolation** from input to output. The input devices powering DP7130G must provide relevant isolation requirements according to all IEC60950 based standards. Nevertheless, if the system using the converter needs to receive safety agency approval, certain rules must be followed in the design of the system. In particular, all of the creepage and clearance requirements of the end-use safety requirements must be observed. These requirements are included in UL60950 - CSA60950-00 and EN60950, although specific applications may have other or additional requirements.

The DP7130G dPOL converters have no internal fuse. If required, the external fuse needs to be provided to protect the converter from catastrophic failure. Refer to the “Input Fuse Selection for DC/DC converters” application note on [www.belpowersolutions.com](http://www.belpowersolutions.com) for proper selection of the input fuse. Both input traces and the chassis ground trace (if applicable) must be capable of conducting current of 1.5 times of the fault current value of the fuse rating. The fuse must not be placed in the grounded input line.

All abnormal conditions and component failure tests were conducted with the dPOL input protected by a fast-acting 32V, 25A fuse. If a fuse rated greater than 25A is used, additional testing may be required.

In order for the output of the DP7130G dPOL converter to be considered as SELV (Safety Extra Low Voltage), according to all IEC60950 based standards, the input to the dPOL needs to be supplied by an isolated secondary source providing a SELV.

## 11. ENVIRONMENTAL

| PARAMETER                      | CONDITIONS / DESCRIPTION                     | MIN                                      | NOM | MAX | UNITS |
|--------------------------------|--|--|-----|-----|-------|
| Ambient Temperature Range (Ta) |  | -40                                      |     | 85  | °C    |
| Storage Temperature (Ts)       |  | -50                                      |     | 125 | °C    |
| MTBF                           | Calculated Per Telcordia Technologies SR-332 | 14.3                                     |     |     | MHrs  |
| Peak Reflow Temperature        | DP7130G                                      |  | 245 | 260 | °C    |
| Lead Plating                   | DP7130G                                      | 100% Matte Tin or 1.5µm Ag over 1.5µm Ni |     |     |       |
| Moisture Sensitivity Level     | DP7130G                                      |  |     | 3   |       |

+1.866.513.2839

tech.support@psbel.com

[belpowersolutions.com](http://belpowersolutions.com)

# DP7130G

## 12. MECHANICAL DRAWINGS

| PARAMETER  | CONDITIONS / DESCRIPTION | MIN  | NOM  | MAX  | UNITS |
|------------|--------------------------|------|------|------|-------|
| Dimensions | Width                    | 31.7 | 32   | 32.3 |       |
|            | Height                   | 15   | 15.3 | 15.6 | mm    |
|            | Depth                    | 7.95 | 8.25 | 8.55 |       |
| Weight     |                          |      | 15   |      | g     |

Figure 55: Mechanical Drawing

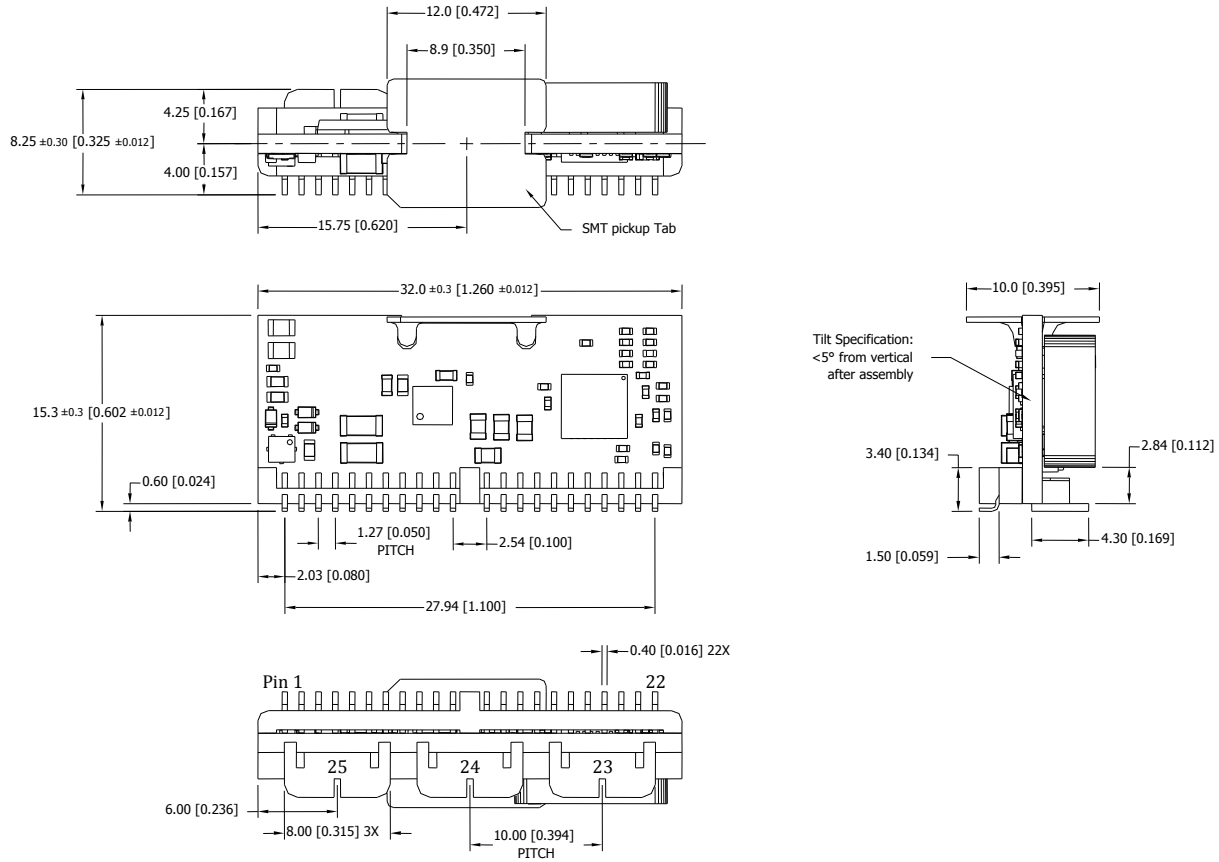
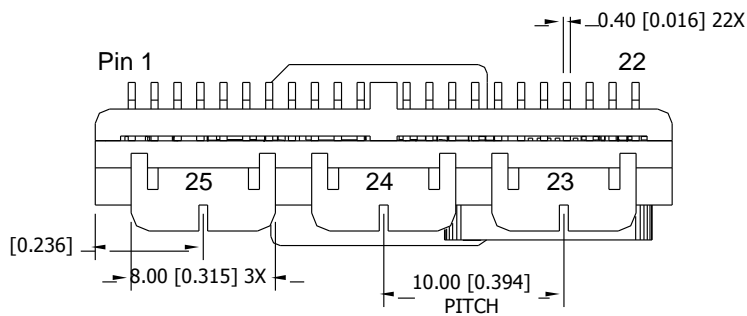

Figure 56: Pinout Diagram (Bottom View)



# DP7130G

Figure 57: Recommended Pad Sizes

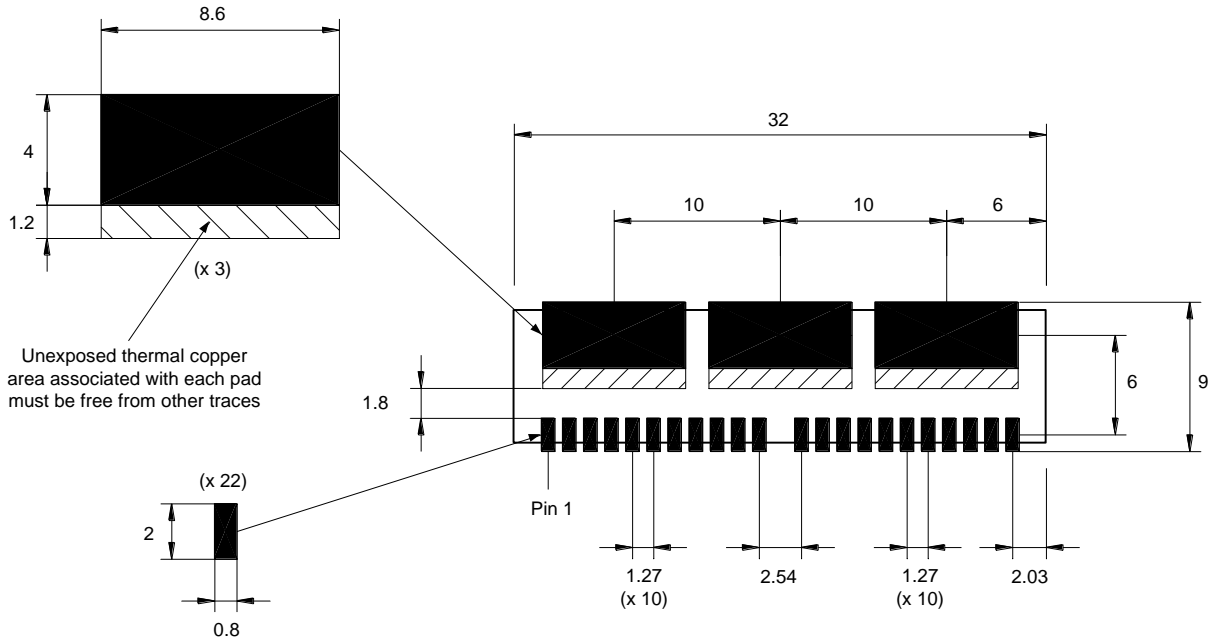
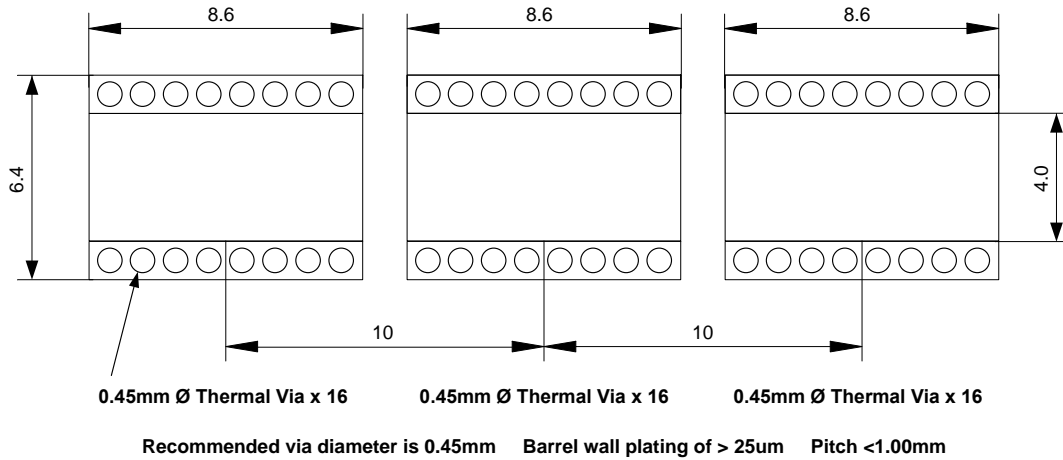

Figure 58: Recommended PCB Layout for Multilayer PCBs



**Note:** I<sup>2</sup>C is a trademark of Philips Corporation.

**For more information on these products consult: [tech.support@psbel.com](mailto:tech.support@psbel.com)**

**NUCLEAR AND MEDICAL APPLICATIONS** - Products are not designed or intended for use as critical components in life support systems, equipment used in hazardous environments, or nuclear control systems.

**TECHNICAL REVISIONS** - The appearance of products, including safety agency certifications pictured on labels, may change depending on the date manufactured. Specifications are subject to change without notice.

## X-ON Electronics

Largest Supplier of Electrical and Electronic Components

*Click to view similar products for [Non-Isolated DC/DC Converters](#) category:*

*Click to view products by [Bel Fuse](#) manufacturer:*

Other Similar products are found below :

[PSR152.5-7IR](#) [APTH003A0X-SRZ](#) [SPM1004-3V3C](#) [R-785.0-05](#) [10E24-P15-10PPM](#) [1E24-P4-25PPM-SHV-5KV](#) [CA-17205-L4](#)  
[PROPOWER-3.3V](#) [MYGTM01210BZN](#) [40C24-N250-I5-H](#) [40A24-P30-E](#) [3V12-P0.8](#) [10C24-N250-I10-AQ-DA](#) [4AA24-P20-M-H](#) [3V12-](#)  
[N0.8](#) [3V24-P1](#) [3V24-N1](#) [BMR4672010/001](#) [BMR4652010/001](#) [6AA24-P30-I5-M](#) [6AA24-N30-I5-M](#) [BM2P101X-Z](#) [35A24-P30](#) [2.5M24-P1](#)  
[PTV03010WAD](#) [PTV05020WAH](#) [PTV12010LAH](#) [PTV12020WAD](#) [R-7212D](#) [R-7212P](#) [R-78AA15-0.5SMD](#) [R-78AA5.0-1.0SMD](#) [30A24-](#)  
[N15-E](#) [10A12-P4-M](#) [10C24-N250-I5](#) [10C24-P125](#) [10C24-P250-I5](#) [6A24-P20-I10-F-M-25PPM](#) [1A24-P30-F-M-C](#) [TSR 1-24150SM](#)  
[1/2AA24-N30-I10](#) [1C24-N125](#) [12C24-N250](#) [V7806-1500](#) [PTV12020LAH](#) [PTV05010WAH](#) [PTN04050CAZT](#) [PTH12020WAD](#)  
[PTH12020LAS](#) [PTH05050YAH](#)