

**Features**

- RoHS lead-free-solder and lead-solder-exempted products are available
- Input voltage up to 144 VDC
- Single output of 5.1 to 48 VDC
- No input-to-output isolation
- High efficiency up to 96%
- Extremely wide input voltage range
- Low input-to-output differential voltage
- Very good dynamic properties
- Input undervoltage lockout
- Output voltage adjustment and inhibit function
- Continuously no-load and short-circuit proof
- All boards are coated with a protective lacquer

Safety-compliant to IEC/EN 60950-1 and UL/CSA 60950-1 2<sup>nd</sup> Ed.



**Description**

The PSB Series of positive switching regulators are designed as power supplies for electronic systems, where no input-to-output isolation is required. Their major advantages include a high level of efficiency, high reliability, low output ripple, and excellent dynamic response. Models with input voltages up to 144 V are specially designed for secondary switched and battery-driven mobile applications. The converters are

suitable for railway applications according to EN 50155 and EN 50121.

The case design allows for operation up to 71 °C. The PSB Series is designed for wall or chassis mounting with faston connections.

Various options are available to adapt the converters to different applications.

**Table of Contents**

	Page		Page
Description .....	1	Electromagnetic Compatibility (EMC) .....	11
Model Selection .....	2	Immunity to Environmental Conditions .....	12
Functional Description .....	3	Mechanical Data .....	13
Electrical Input Data .....	4	Safety and Installation Instructions .....	13
Electrical Output Data .....	6	Description of Options .....	14
Auxiliary Functions .....	10	Accessories .....	15



## Model Selection

Table 1: PSB Series

Output voltage $V_{o\ nom}$ [V]	Output current $I_{o\ nom}$ [A]	Operating input voltage range $V_i$ [V]	Nom. input voltage $V_{i\ nom}$ [V]	Efficiency <sup>2</sup>		Type designation	Options
				$\eta_{min}$ [%]	$\eta_{typ}$ [%]		
5.1	4 <sup>3</sup>	15 – 144 <sup>1</sup>	60	76	80	PSB5A4-9iR	-7, L, P, C, G
5.1	6	8 – 80	40	79	82.5	PSB5A6-9iR	-7, L, P, C, G
5.1	7	7 – 40	20	83	84.5	PSB5A7-9iR	-7, L, P, C, G
5.1	8	7 – 40	20	82.5	84	PSB5A8-2	iR <sup>5</sup>
12	3 <sup>4</sup>	18 – 144 <sup>1</sup>	60	87	88.5	PSB123-9iR	-7, L, P, C, G
12	5	15 – 80	40	89	90.5	PSB125-9iR	-7, L, P, C, G
12	6	15 – 40	20	89.5	91	PSB126-2	iR <sup>5</sup>
15	3 <sup>4</sup>	22 – 144 <sup>1</sup>	60	89	90	PSB153-9iR	-7, L, P, C, G
15	5	19 – 80	40	90.5	92.5	PSB155-9iR	-7, L, P, C, G
15	6	19 – 40	30	91	92.5	PSB156-2	iR <sup>5</sup>
24	3 <sup>4</sup>	31 – 144 <sup>1</sup>	60	92.5	94	PSB243-9iR	-7, L, P, C, G
24	5	29 – 80	50	93.5	95	PSB245-9iR	-7, L, P, C, G
24	6	29 – 60	40	94	96	PSB246-2	iR <sup>5</sup>
36	3 <sup>4</sup>	44 – 144 <sup>1</sup>	80	94	95	PSB363-9iR	-7, L, P, C, G
36	5	42 – 80	60	95.5	96.5	PSB365-9iR	-7, L, P, C, G
48	3 <sup>4</sup>	58 – 144 <sup>1</sup>	80	95.5	96.5	PSB483-9iR	-7, L, P, C, G

<sup>1</sup> Surges up to 156 V for 2 s; see *Electrical Input Data*

<sup>2</sup> Efficiency at  $V_{i\ nom}$  and  $I_{o\ nom}$

<sup>3</sup>  $I_{o\ max} = 5\ A$  at  $V_i \leq 80\ V$ ; for  $V_i > 80\ V$ , see fig. 4.

<sup>4</sup>  $I_{o\ max} = 4\ A$  at  $V_i \leq 80\ V$ ; for  $V_i > 80\ V$ , see fig. 4.

<sup>5</sup> Options iR in a package

NFND: Not for new designs.

Preferred for new designs

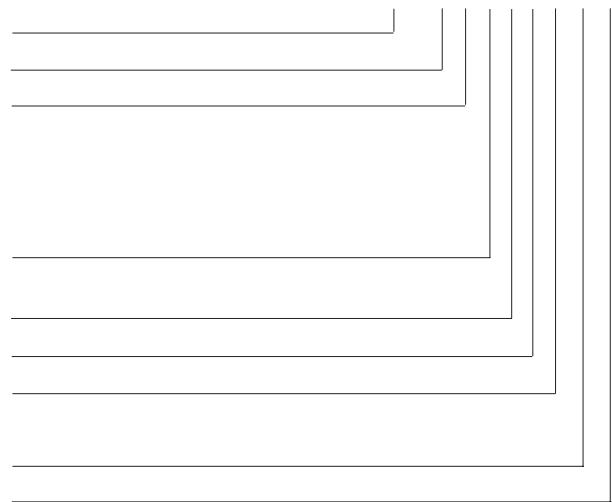
**Note:** The sequence of options must follow the order above.

### Part Number Description

Positive switching regulator in case B02 ..... PSB  
 Nominal output voltage in volt ..... 5.1 to 48  
 Nominal output current in Ampère ..... 3 to 8  
 Operational ambient temperature range  $T_A$   
   –10 to 50 °C ..... -2  
   –25 to 50 °C ..... -5  
   –25 to 71 °C (option) ..... -7  
   –40 to 71 °C ..... -9  
   other (customer-specific models) ..... -0  
 Input filter (option) ..... L  
 Inhibit input ..... i  
 Control input for output voltage adjustment<sup>1</sup> ..... R  
 Potentiometer<sup>1</sup> (option) ..... P  
 Thyristor crowbar (option) ..... C  
 RoHS-compliant for all 6 substances ..... G

<sup>1</sup> Feature R excludes option P and vice versa.

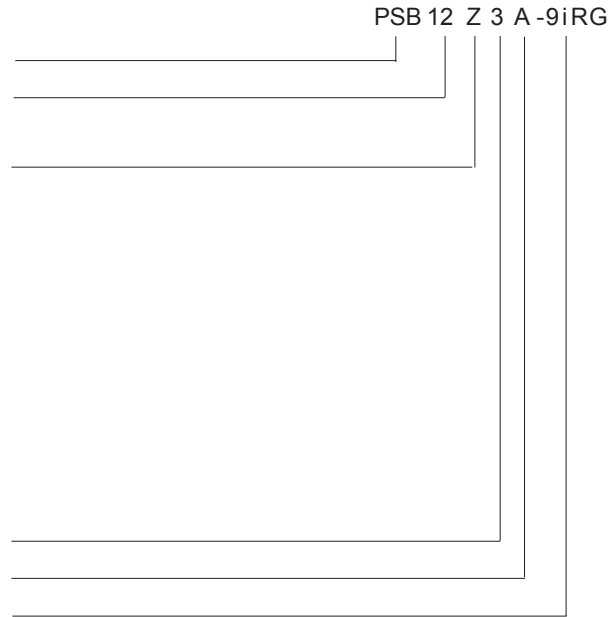
PSB 12 3 -9 L i R C G



Example: PSB123-9LiPCG designates a positive switching regulator with output 12 V, 3 A, ambient temperature range of –40 to 71 °C, input filter, inhibit input, output adjust potentiometer, thyristor crowbar, and RoHS-compliant.

### Customer-specific Models

Positive switching regulator in case B01 .....	PSB
Nominal output voltage in Volt (without decimals) .....	12
Decimal places:	
0.0 V .....	Z
0.1 V .....	A
0.15 V .....	B
0.2 V .....	C
0.25 V .....	D
0.3 V .....	E
0.4 V .....	F
0.5 V .....	G
0.6 V .....	H
0.7 V .....	J
0.8 V .....	K
0.9 V .....	L
other .....	Y
Output current in Ampère .....	3
Identification character .....	A, B, ..
Temperature range and options .....	-9iRG



### Produkt Marking

Type designation, applicable safety approval marks, warnings, pin allocation, patent nos., and company logo.

Input voltage range, nominal output voltage and current, pin allocation of auxiliary functions and options, and protection

degree. Identification of LED and the optional potentiometer.

Label with input voltage range, nominal output voltage and current, protection degree, batch no., serial no., and data code including production site, version (modification status), date of production.

### Functional Description

This switching regulator uses the buck converter topology. The input is not electrically isolated from the output. During the on period of the switching transistor, current is transferred to the output, and energy is stored in the output choke. During the off period, this energy forces the current to keep flowing through the output, to the load, and back through the freewheeling diode. Regulation is accomplished

by varying the duty cycle (on/ratio) of the power switch. The regulator is equipped with a undervoltage lockout, but no overvoltage shutdown.

These regulators are ideal for a wide range of applications, where input to output isolation is not necessary, or where already provided by an external front end (e.g., a transformer with rectifier). To optimize customer's needs, additional options and accessories are available.

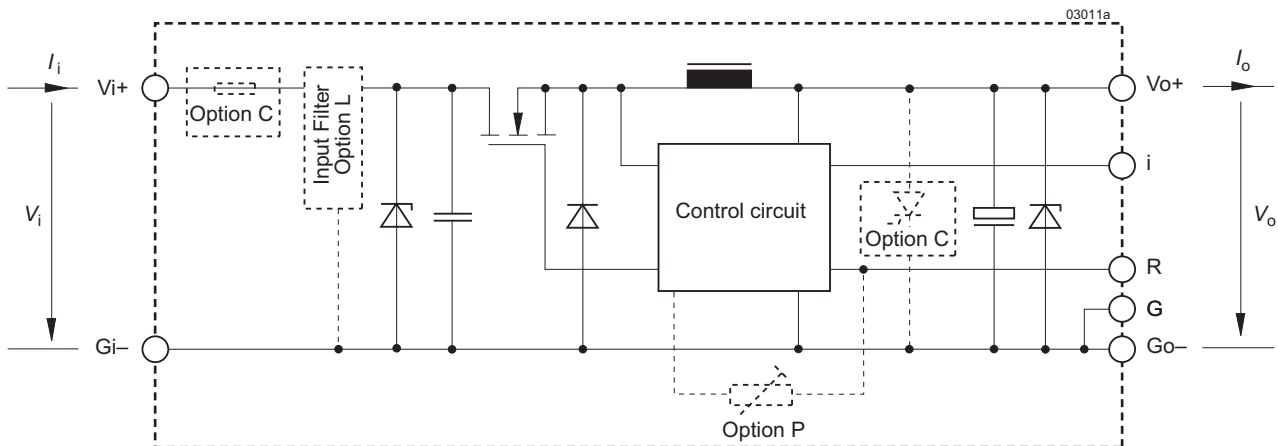


Fig. 1  
 Block diagram PSB

## Electrical Input Data

General Conditions:  $T_A = 25^\circ\text{C}$ , unless  $T_C$  is specified

Table 2a: Input data

Model		Conditions	PSB5A8			PSB126			PSB156			PSB246			Unit
Characteristics			min	typ	max	min	typ	max	min	typ	max	min	typ	max	
$V_i$	Operating input voltage	$I_o = 0 - I_{o\text{ nom}}$ $T_C\text{ min} - T_C\text{ max}$	7	40		15	40		19	40		29	60	V	
$\Delta V_{i\text{ o min}}$	Min. diff. voltage $V_i - V_o$			1.9			3			4			5		
$V_{i\text{ UVL}}$	Undervoltage lockout			7.3			7.3			7.3			12		
$I_{i\text{ o}}$	No load input current	$I_o = 0, V_{i\text{ min}} - V_{i\text{ max}}$		50			50			50			50	mA	
$I_{i\text{ nr p}}$	Peak value of inrush current	$V_{i\text{ nom}}$		75			75			150			150	A	
$t_{i\text{ nr r}}$	Rise time of inrush current			5			5			5			5	$\mu\text{s}$	
$t_{i\text{ nr h}}$	Time to half-value			40			40			40			40		
$V_{i\text{ RFI}}$	EN 55011, 0.15 – 30 MHz	$V_{i\text{ nom}}, I_{o\text{ nom}}$		A			A			A			A	Class	

Tab. 2b: Input data

Model		Conditions	PSB5A7			PSB5A6			PSB125			Unit
Characteristics			min	typ	max	min	typ	max	min	typ	max	
$V_i$	Operating input voltage	$I_o = 0 - I_{o\text{ nom}}$ $T_C\text{ min} - T_C\text{ max}$	7		40	8		80	15		80	V
$\Delta V_{i\text{ o min}}$	Min. diff. voltage ( $V_i - V_o$ )				1.9			2.9			3	
$V_{i\text{ UVL}}$	Undervoltage lockout				6.3			7.3			7.3	
$I_{i\text{ o}}$	No load input current	$I_o = 0, V_{i\text{ min}} - V_{i\text{ max}}$			45			40			35	mA
$I_{i\text{ nr p}}$	Peak value of inrush current	$V_{i\text{ nom}}$ without option L			75			150			150	A
$t_{i\text{ nr r}}$	Rise time of inrush current				5			5			5	$\mu\text{s}$
$t_{i\text{ nr h}}$	Time to half-value				40			40			40	
$I_{i\text{ nr p}}$	Peak value of inrush current	$V_{i\text{ nom}}$ with option L			100			180			180	A
$t_{i\text{ nr r}}$	Rise time				15			15			15	$\mu\text{s}$
$t_{i\text{ nr h}}$	Time to half-value				100			100			100	
$V_{i\text{ RFI}}$	EN 55011 0.15 – 30 MHz	$V_{i\text{ nom}}, I_{o\text{ nom}}$ with option L			B			B			B	Class

Tab. 2c: Input data

Model		Conditions	PSB155			PSB245			PSB365			Unit
Characteristics			min	typ	max	min	typ	max	min	typ	max	
$V_i$	Operating input voltage	$I_o = 0 - I_{o\text{ nom}}$ $T_C\text{ min} - T_C\text{ max}$	19		80	29		80	42		80	V
$\Delta V_{i\text{ o min}}$	Min. diff. voltage ( $V_i - V_o$ )				4			5			6	
$V_{i\text{ UVL}}$	Undervoltage lockout				7.3			12			19	
$I_{i\text{ o}}$	No load input current	$I_o = 0, V_{i\text{ min}} - V_{i\text{ max}}$			35			35			40	mA
$I_{i\text{ nr p}}$	Peak value of inrush current	$V_{i\text{ nom}}$ without option L			150			150			150	A
$t_{i\text{ nr r}}$	Rise time of inrush current				5			5			5	$\mu\text{s}$
$t_{i\text{ nr h}}$	Time to half-value				40			40			40	
$I_{i\text{ nr p}}$	Peak value of inrush current	$V_{i\text{ nom}}$ with option L			180			180			180	A
$t_{i\text{ nr r}}$	Rise time				15			15			15	$\mu\text{s}$
$t_{i\text{ nr h}}$	Time to half-value				100			100			100	
$V_{i\text{ RFI}}$	EN 55011 0.15 – 30 MHz	$V_{i\text{ nom}}, I_{o\text{ nom}}$ with option L			B			B			B	Class

Tab. 2d: Input data. General Conditions as per table 2 a

Model			PSB5A4			PSB123			PSB153			Unit
Characteristics		Conditions	min	typ	max	min	typ	max	min	typ	max	
$V_i$	Operating input voltage	$I_o = 0 - I_{o\ nom}$ $T_C\ min - T_C\ max$	15	144 <sup>1</sup>		18	144 <sup>1</sup>		22	144 <sup>1</sup>		V
$\Delta V_{i\ o\ min}$	Min. diff. voltage ( $V_i - V_o$ )				9.9			6			7	
$V_{i\ UVL}$	Undervoltage lockout			10			12			15		
$I_{i\ 0}$	No load input current	$I_o = 0, V_{i\ min} - V_{i\ max}$			40			35			35	mA
$I_{inr\ p}$	Peak value of inrush current	$V_{i\ nom}$ without option L		150			150			150		A
$t_{inr\ r}$	Rise time			5			5			5		$\mu$ s
$t_{inr\ h}$	Time to half-value			40			40			40		
$I_{inr\ p}$	Peak value of inrush current	$V_{i\ nom}$ with option L		180			180			180		A
$t_{inr\ r}$	Rise time of inrush current			15			15			15		$\mu$ s
$t_{inr\ h}$	Time to half-value			100			100			100		
$V_{i\ RFI}$	EN 55011 0.15 – 30 MHz	$V_{i\ nom}, I_{o\ nom}$ with option L		A B <sup>2</sup>			A B <sup>2</sup>			A B <sup>2</sup>		Class

Tab. 2e: Input data

Model			PSB243			PSB363			PSB483			Unit
Characteristics		Conditions	min	typ	max	min	typ	max	min	typ	max	
$V_i$	Operating input voltage	$I_o = 0 - I_{o\ nom}$ $T_C\ min - T_C\ max$	31	144 <sup>1</sup>		44	144 <sup>1</sup>		58	144 <sup>1</sup>		V
$\Delta V_{i\ o\ min}$	Min. diff. voltage ( $V_i - V_o$ )				7			8			10	
$V_{i\ UVL}$	Undervoltage lockout			19			29			40		
$I_{i\ 0}$	No load input current	$I_o = 0, V_{i\ min} - V_{i\ max}$			35			40			45	mA
$I_{inr\ p}$	Peak value of inrush current	$V_{i\ nom}$ without option L		150			150			150		A
$t_{inr\ r}$	Rise time of inrush current			5			5			5		$\mu$ s
$t_{inr\ h}$	Time to half-value			40			40			40		
$I_{inr\ p}$	Peak value of inrush current	$V_{i\ nom}$ with option L		180			180			180		A
$t_{inr\ r}$	Rise time			15			15			15		$\mu$ s
$t_{inr\ h}$	Time to half-value			100			100			100		
$V_{i\ RFI}$	EN 55011 0.15 – 30 MHz	$V_{i\ nom}, I_{o\ nom}$ with option L		A B <sup>2</sup>			A B <sup>2</sup>			A B <sup>2</sup>		Class

<sup>1</sup> Surges up to 156 V for 2 s

<sup>2</sup> With external input capacitor  $C_i = 470\ \mu\text{F}/200\ \text{V}$  and option L

### External Input Circuitry and Fuse

The sum of the lengths of the supply lines to the source or to the nearest capacitor  $\geq 100\ \mu\text{F}$  (a + b) should not exceed 5 m,

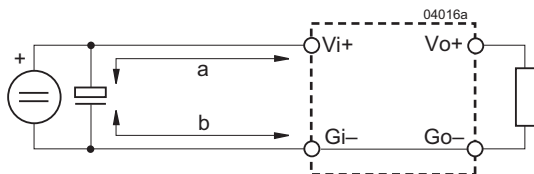


Fig. 2  
Switching regulator with long supply lines.

unless option L is fitted. This option is recommended in order to prevent power line oscillations and reduce superimposed interference voltages.

Regulators with option C are fitted with an input fuse.

## Electrical Output Data

General conditions:

- $T_A = 25\text{ }^\circ\text{C}$ , unless  $T_C$  is specified
- R-input open (or  $V_o$  set to  $V_{o\text{ nom}}$  with option P)

Table 3a: Output data

Model			PSB5A8		PSB126		PSB156		PSB246		Unit	
Characteristics			min	typ	max	min	typ	max	min	typ		max
$V_o$	Output voltage		$V_{i\text{ nom}}, I_{o\text{ nom}}$	5.05	5.15	11.6	12.4	14.5	15.5	23.3	24.7	V
$I_{o\text{ nom}}$	Output current		$V_{i\text{ min}} - V_{i\text{ max}}$	0	8.0	0	6.0	0	6.0	0	6.0	A
$I_{oL}$	Output current limitation		$T_{C\text{ min}} - T_{C\text{ max}}$	8.0	10.4	6.0	7.8	6-0	7.8	6.0	7.8	
$v_o$	Output voltage noise	Switching frequ.	$V_{i\text{ nom}}, I_{o\text{ nom}}$	40		150		200		300		mV <sub>pp</sub>
		Total	IEC/EN 61204 BW = 20 MHz	45		160		210		310		
$\Delta V_{oV}$	Static line regulation		$V_{i\text{ min}} - V_{i\text{ max}}, I_{o\text{ nom}}$	100		240		300		480		mV
$\Delta V_{oI}$	Static load regulation		$V_{i\text{ nom}}, I_o = 0 - I_{o\text{ nom}}$	100		180		200		300		
$v_{o d}$	Dynamic voltage regulation	Voltage deviation	$V_{i\text{ nom}}$	150		360		450		700		$\mu\text{s}$
$t_d$		Recovery time	$I_{o\text{ nom}} \leftrightarrow \frac{1}{3} I_{o\text{ nom}}$ IEC/EN 61204	100		120		120		160		
$\alpha_{V_o}$	Temperature coefficient $\Delta V_o / \Delta T_C (T_{C\text{ min}} - T_{C\text{ max}})$		$V_{i\text{ min}} - V_{i\text{ max}}$ $I_o = 0 - I_{o\text{ nom}}$	$\pm 0.02$		$\pm 0.02$		$\pm 0.02$		$\pm 0.02$		%/K

Table 3b: Output data

Model			PSB5A7			PSB5A6			PSB125			Unit	
Characteristics			min	typ	max	min	typ	max	min	typ	max		
$V_o$	Output voltage		$V_{i\text{ nom}}, I_{o\text{ nom}}$	5.07	5.13	5.07	5.13	11.93	12.07			V	
$I_{o\text{ nom}0}$	Output current		$V_{i\text{ min}} - V_{i\text{ max}}$	0	7.0	0	6.0	0	5.0			A	
$I_{oL}$	Output current limitation		$T_{C\text{ min}} - T_{C\text{ max}}$	7.0	9.1	6.0	7.8	5.0	6.5				
$v_o$	Output voltage noise	Switching frequ.	$V_{i\text{ nom}}, I_{o\text{ nom}}$	15	25	15	35	25	45			mV <sub>pp</sub>	
		Total	IEC/EN 61204 BW = 20 MHz	19	29	19	39	29	49				
$\Delta V_{oV}$	Static line regulation		$V_{i\text{ min}} - V_{i\text{ max}}, I_{o\text{ nom}}$	100			100			240			mV
$\Delta V_{oI}$	Static load regulation		$V_{i\text{ nom}}, I_o = 0 - I_{o\text{ nom}}$	100			100			120			
$v_{o d}$	Dynamic load regulation	Voltage deviat.	$V_{i\text{ nom}}$	150			130			360			$\mu\text{s}$
$t_d$		Recovery time	$I_{o\text{ nom}} \leftrightarrow \frac{1}{3} I_{o\text{ nom}}$ IEC/EN 61204	50			50			60			
$\alpha_{V_o}$	Temperature coefficient $\Delta V_o / \Delta T_C (T_{C\text{ min}} - T_{C\text{ max}})$		$V_{i\text{ min}} - V_{i\text{ max}}$ $I_o = 0 - I_{o\text{ nom}}$	$\pm 0.02$			$\pm 0.02$			$\pm 0.02$			%/K

**Table 3c: Output data. General conditions as per table 3a**

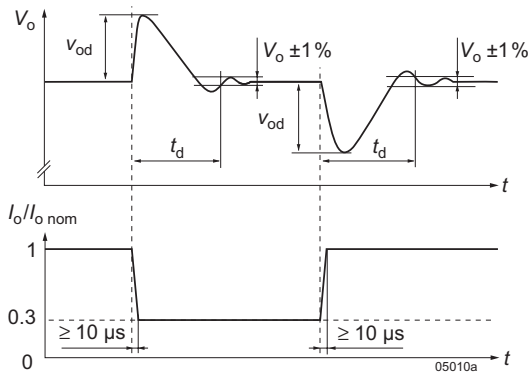
Model			PSB155			PSB245			PSB365			Unit			
Characteristics			Conditions			min	typ	max	min	typ	max	min	typ	max	
$V_o$	Output voltage		$V_{i\ nom}, I_{o\ nom}$			14.91		15.09	23.68		24.14	35.78		36.22	V
$I_{o\ nom}$	Output current		$V_{i\ min} - V_{i\ max}$			0		5.0	0		5.0	0		5.0	A
$I_{oL}$	Output current limitation		$T_{C\ min} - T_{C\ max}$			5.0		6.5	5.0		6.5	5.0		6.5	
$v_o$	Output voltage noise	Switching freq.	$V_{i\ nom}, I_{o\ nom}$			40	70		45	120		70	180		mV <sub>pp</sub>
		Total	IEC/EN 61204 BW = 20 MHz			44	74		50	125		75	185		
$\Delta V_{oV}$	Static line regulation		$V_{i\ min} - V_{i\ max}, I_{o\ nom}$			40	75		70	150		100	200		mV
$\Delta V_{oI}$	Static load regulation		$V_{i\ nom}, I_o = 0 - I_{o\ nom}$			30	65		70	120		120	160		
$v_{oD}$	Dynamic load regulation	Voltage deviat.	$V_{i\ nom}$			100			120			180			$\mu$ s
$t_d$		Recovery time	$I_{o\ nom} \leftrightarrow 1/3 I_{o\ nom}$ IEC/EN 61204			60			80			100			
$\alpha_{Vo}$	Temperature coefficient $\Delta V_o / \Delta T_C (T_{C\ min} - T_{C\ max})$		$V_{i\ min} - V_{i\ max}$ $I_o = 0 - I_{o\ nom}$					$\pm 0.02$			$\pm 0.02$			$\pm 0.02$	%/K

**Table 3d: Output data**

Model			PSB5A4			PSB123			PSB153			Unit			
Characteristics			Conditions			min	typ	max	min	typ	max	min	typ	max	
$V_o$	Output voltage		$V_{i\ nom}, I_{o\ nom}$			5.07		5.13	5.07		5.13	11.93		12.07	V
$I_{o\ nom}$	Output current nominal		$V_{i\ min} - V_{i\ max}$				4.0			4.0			4.0		A
$I_{o\ max}$	Output current max		$V_{i\ min} - 80\ V$				5.0			5.0			5.0	A	
$I_{oL}$	Output current limitation		$T_{C\ min} - T_{C\ max}$				5.0		6.5	4.0		5.2	4.0		5.2
$v_o$	Output voltage noise	Switching frequ.	$V_{i\ nom}, I_{o\ nom}$			15	35		25	45		40	70		mV <sub>pp</sub>
		Total	IEC/EN 61204 BW = 20 MHz			19	39		29	49		44	74		
$\Delta V_{oV}$	Static line regulation		$V_{i\ min} - V_{i\ max}, I_{o\ nom}$			20	45		30	55		50	75		mV
$\Delta V_{oI}$	Static load regulation		$V_{i\ nom}, I_o = 0 - I_{o\ nom}$			20	35		25	40		30	65		
$v_{oD}$	Dynamic load regulation	Voltage deviat.	$V_{i\ nom}$			100			100			100			$\mu$ s
$t_d$		Recovery time	$I_{o\ nom} \leftrightarrow 1/3 I_{o\ nom}$ IEC/EN 61204			50			50			60			
$\alpha_{Vo}$	Temperature coefficient $\Delta V_o / \Delta T_C (T_{C\ min} - T_{C\ max})$		$V_{i\ min} - V_{i\ max}$ $I_o = 0 - I_{o\ nom}$					$\pm 0.02$			$\pm 0.02$			$\pm 0.02$	%/K

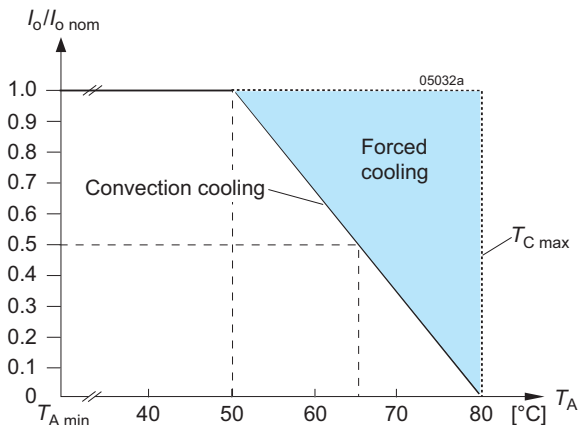
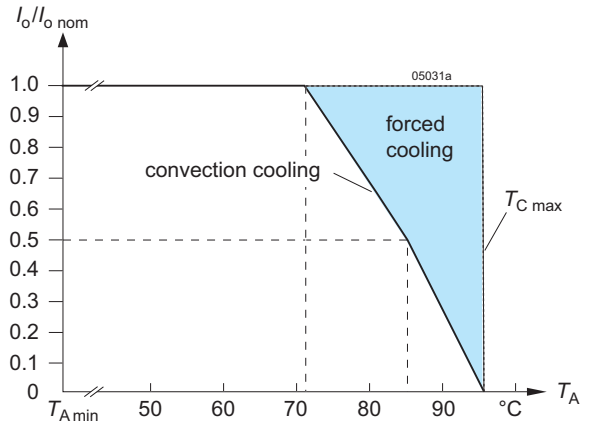
Table 3e: Output data. General conditions as per table 3a

Model		PSB243			PSB363			PSB483			Unit		
Characteristics		Conditions		min	typ	max	min	typ	max	min	typ	max	
$V_o$	Output voltage	$V_{i\text{nom}}, I_{o\text{nom}}$		23.86	24.14		35.78	36.22		47.71	48.29		V
$I_{o\text{nom}}$	Output current nominal	$V_{i\text{min}} - V_{i\text{max}}$			4.0			4.0			4.0		A
$I_{o\text{max}}$	Output current	$V_{i\text{min}} - 80\text{ V}$			4.0			4.0			4.0		A
$I_{oL}$	Output current limitation	$T_{C\text{min}} - T_{C\text{max}}$		4.0		5.2	4.0		5.2	5.0		5.2	
$v_o$	Output voltage noise	Switching freq.	$V_{i\text{nom}}, I_{o\text{nom}}$		45	120		70	180		90	190	mV <sub>pp</sub>
		Total	IEC/EN 61204 BW = 20 MHz		50	125		75	185		95	195	
$\Delta V_{oV}$	Static line regulation	$V_{i\text{min}} - V_{i\text{max}}, I_{o\text{nom}}$		70	150		100	200		150	300		mV
$\Delta V_{oI}$	Static load regulation	$V_{i\text{nom}}, I_o = 0 - I_{o\text{nom}}$		70	120		120	160		150	250		
$v_{oD}$	Dynamic load regulation	Voltage deviat.	$V_{i\text{nom}}$		120			140			150		
$t_d$		Recovery time	$I_{o\text{nom}} \leftrightarrow 1/3 I_{o\text{nom}}$ IEC/EN 61204		80			100			100		
$\alpha_{V_o}$	Temperature coefficient $\Delta V_o / \Delta T_C (T_{C\text{min}} - T_{C\text{max}})$	$V_{i\text{min}} - V_{i\text{max}}$ $I_o = 0 - I_{o\text{nom}}$				$\pm 0.02$			$\pm 0.02$			$\pm 0.02$	%/K

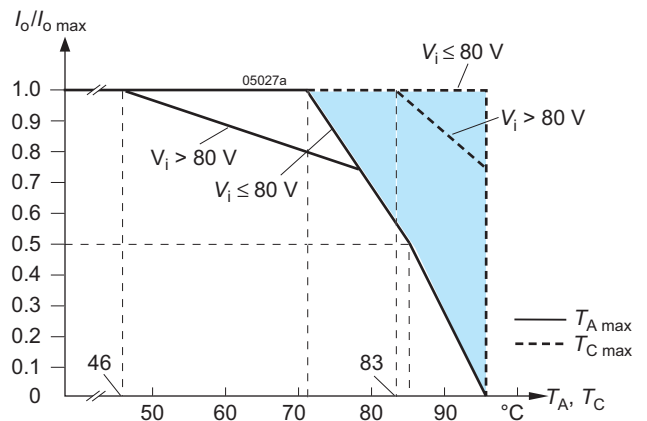

 Fig. 3  
 Switching regulator with long supply lines.

### Thermal Considerations

When a switching regulator is located in free, quasi-stationary air (convection cooling) at a temperature  $T_A = 71^\circ\text{C}$  and is operated at  $I_{o\text{nom}}$ , the case temperature  $T_C$  will be about  $95^\circ\text{C}$


 Fig. 4a  
 Output current versus temperature (models -2)

 Fig. 4b  
 Output current versus temperature (models -7 or -9 and with  $V_{i\text{max}} \leq 80\text{ V}$ )

after the warm-up phase, measured at the measuring point of case temperature  $T_C$ ; see *Mechanical Data*.

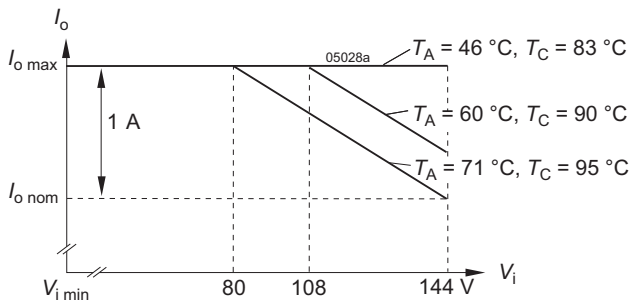

 Fig. 4c  
 Output current versus temperature (models with  $V_{i\text{max}} = 144\text{ V}$ )



Under practical operating conditions,  $T_A$  may exceed  $71\text{ }^\circ\text{C}$ , provided that additional measures (heat sink, fan, etc.) are taken to ensure that the case temperature  $T_C$  does not exceed  $T_{C\text{max}}$ .

The regulators with  $V_{i\text{max}} = 144\text{ V}$  withstand  $156\text{ V}$  for  $2\text{ s}$  in order to comply with railway standards. However,  $I_{o\text{max}}$  is only continuously available for  $V_i \leq 80\text{ V}$  or for reduced  $T_A$  and  $T_C$ ; see fig. 4c.

For operation of regulators with  $V_{i\text{max}} = 144\text{ V}$  at  $T_A \geq 46\text{ }^\circ\text{C}$ , an internal PTC (thermistor) starts reducing  $I_{oL}$ , if  $V_i$  is greater than  $80\text{ V}$ . At most unfavorable conditions,  $I_{oL}$  is reduced by  $1\text{ A}$ ; see fig. 5.

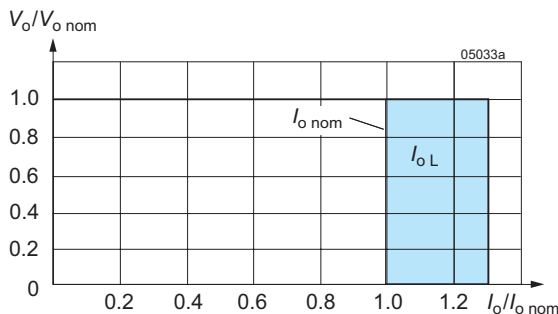


**Fig. 5**  
 Typ. dependance of  $I_{oL}$  of temperature

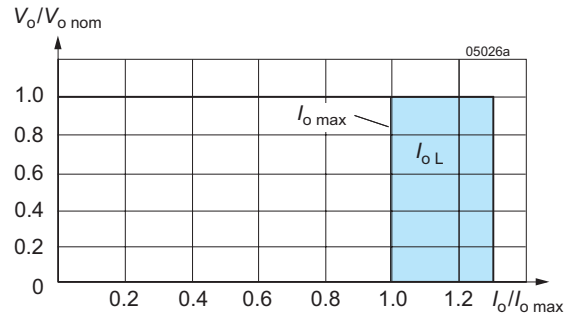
### Output Protection and Short Circuit Behaviour

A voltage suppressor diode, which in worst case conditions fails into a short circuit (or a thyristor crowbar, option C), protects the output against an internally generated overvoltage. Such an overvoltage could occur due to a failure of either the control circuit or the switching transistor. The output protection is not designed to withstand externally applied overvoltages.

A constant current limitation circuit holds the output current almost constant, when an overload or a short circuit is applied to the output. It acts self-protecting and recovers automatically after removal of the overload or short circuit condition.



**Fig. 6a**  
 Short-circuit behaviour  $V_o$  vs.  $I_o$  for regulators with  $V_{i\text{max}} \leq 80\text{ V}$



**Fig. 6b**  
 Short-circuit behaviour  $V_o$  versus  $I_o$  for regulators with  $V_{i\text{max}} = 144\text{ V}$ .

### Parallel and Series Connection

Outputs of equal nominal voltages can be parallel-connected. However, the use of a single regulator with higher output power, is always the better solution.

In parallel-connected operation, one or several outputs may operate continuously at their current limit knee-point which will cause an increase of the heat generation. Consequently, the max. ambient temperature should be reduced by  $10\text{ K}$ .

Outputs can be series-connected with any other regulator. In series-connection the maximum output current is limited by the lowest current limitation, but electrically separated source voltages are needed for each regulator.

## Auxiliary Functions

### i Inhibit (Remote On / Off)

The inhibit input allows for disabling the switching regulator by a control signal. In systems with several converters, this

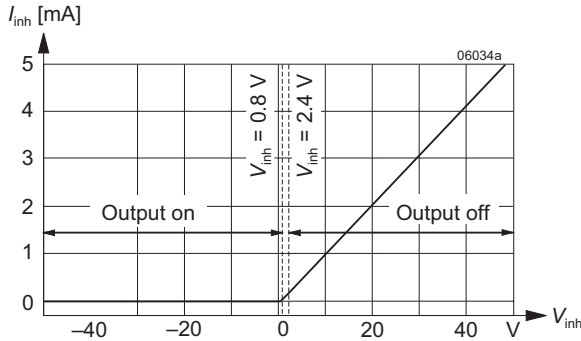


Fig. 7  
 Typical inhibit current  $I_{inh}$  versus inhibit voltage  $V_{inh}$

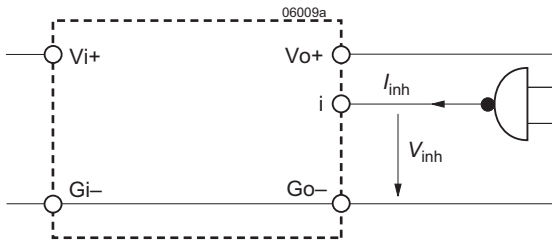


Fig. 8  
 Definition of  $I_{inh}$  and  $V_{inh}$

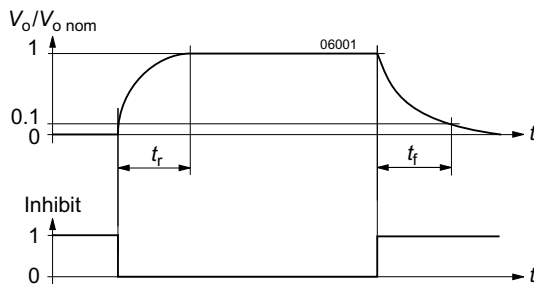


Fig. 9  
 Output response as a function of inhibit signal

Table 4: Inhibit characteristics

Characteristics		Conditions	min	typ	max	Unit
$V_{inh}$	Inhibit input voltage	$V_o = \text{on}$	$V_{i \min} - V_{i \max}$	-50	+0.8	V
		$V_o = \text{off}$	$T_C \min - T_C \max$	+2.4	+50	
$t_r$	Switch-on time	$V_i = V_{i \text{ nom}}$		130	ms	
$t_f$	Switch-off time	$R_L = V_{o \text{ nom}} / I_{o \text{ nom}}$		25		
$I_{i \text{ inh}}$	Input current when inhibited	$V_i = V_{i \text{ nom}}$		25	mA	

feature can be used, for example, to control the activation sequence of converters by a logic signal. An output voltage overshoot will not occur at switch on.

**Note:** With open i-pin, the output is enabled.

### R Output Voltage Adjust

**Note:** With open R input,  $V_o \approx V_{o \text{ nom}}$ .

The output voltage  $V_o$  can either be adjusted with an external voltage source ( $V_{ext}$ ) or with an external resistor ( $R_1$  or  $R_2$ ). The adjustment range is 0 – 108% of  $V_{o \text{ nom}}$ . The minimum differential voltage  $\Delta V_{io \text{ min}}$  between input and output (see *Electrical Input Data*) should be maintained.

a)  $V_o = 0 - V_{o \text{ max}}$ , using  $V_{ext}$  between pins R and G:

$$V_{ext} \approx 2.5 \text{ V} \cdot \frac{V_o}{V_{o \text{ nom}}} \quad V_o \approx V_{o \text{ nom}} \cdot \frac{V_{ext}}{2.5 \text{ V}}$$

**Caution:** To prevent damage,  $V_{ext}$  should not exceed 20 V, nor be negative.

b)  $V_o = 0$  to  $V_{o \text{ nom}}$ , using  $R_{ext1}$  between pins R and G:

$$R_{ext1} \approx \frac{4000 \Omega \cdot V_o}{V_{o \text{ nom}} - V_o} \quad V_o \approx \frac{V_{o \text{ nom}} \cdot R_{ext1}}{R_{ext1} + 4000 \Omega}$$

c)  $V_o = V_{o \text{ nom}}$  to  $V_{o \text{ max}}$ , using  $R_{ext2}$  between pins R and G:

$$R_{ext2} \approx \frac{4000 \Omega \cdot V_o \cdot (V_{o \text{ nom}} - 2.5 \text{ V})}{2.5 \text{ V} \cdot (V_o - V_{o \text{ nom}})}$$

$$V_o \approx \frac{V_{o \text{ nom}} \cdot 2.5 \text{ V} \cdot R_{ext2}}{2.5 \text{ V} \cdot (R_{ext2} + 4000 \Omega) - V_{o \text{ nom}} \cdot 4000 \Omega}$$

**Caution:** To prevent damage,  $R_{ext2}$  should never be less than 47 k $\Omega$ .

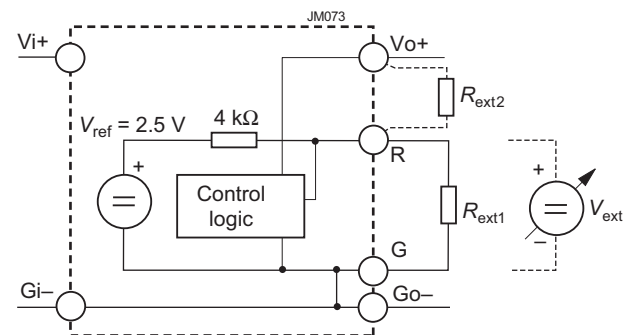


Fig. 10  
 Output voltage adjustment via R-input

### LED Output Voltage Indicator

A yellow LED indicator is illuminated, when the output voltage is higher than approx. 3 V (not for -2 models).

## Electromagnetic Compatibility (EMC)

### Electromagnetic Immunity

General condition: Case not earthed.

Table 5: Immunity type tests

Phenomenon	Standard	Class Level	Coupling mode <sup>1</sup>	Value applied	Waveform	Source Imped.	Test procedure	In oper.	Perf. crit. <sup>2</sup>
Voltage surge <sup>3</sup>	IEC 60571-1	3 <sup>3</sup>	i/c, +i/-i	800 V <sub>p</sub>	100 μs	100 Ω	1 pos. and 1 neg. surge per coupling mode	yes	B
				1500 V <sub>p</sub>	50 μs				
				3000 V <sub>p</sub>	5 μs				
				4000 V <sub>p</sub>	1 μs				
				7000 V <sub>p</sub>	100 ns				
Electrostatic discharge	IEC/EN 61000-4-2	3 <sup>3</sup> 2 <sup>4</sup>	contact discharge to case	6000 V <sub>p</sub> <sup>3</sup> 4000 V <sub>p</sub> <sup>4</sup>	1/50 ns	330 Ω	10 positive and 10 negative discharges	yes	B <sup>4</sup> 5
Electromagnetic field	IEC/EN 61000-4-3	3 <sup>3</sup> 2 <sup>4</sup>	antenna	10 V/m <sup>3</sup> 3 V/m <sup>4</sup>	AM 80% 1 kHz		80 – 1000 MHz	yes	A
Electrical fast transients/burst	IEC/EN 61000-4-4	3	i/c, +i/-i	2000 V <sub>p</sub>	bursts of 5/50 ns 5 kHz rep. rate transients with 15 ms burst duration and a 300 ms period	50 Ω	60 s positive 60 s negative transients per coupling mode	yes	A <sup>5</sup> , B <sup>4</sup>
Surges	IEC/EN 61000-4-5	2 <sup>3</sup>	i/c	1000 V <sub>p</sub>	1.2/50 μs	12 Ω	5 pos. and 5 neg. surges per coupling mode	yes	A <sup>5</sup>
		2 <sup>3</sup>	+i/-i	500 V <sub>p</sub>		2 Ω			
Conducted disturbances	IEC/EN 61000-4-6	3 <sup>3</sup> 2 <sup>4</sup>	i, o, signal wires	10 VAC <sup>3</sup> 3 VAC <sup>4</sup>	AM 80% 1 kHz	150 Ω	0.15 – 80 MHz	yes	A

<sup>1</sup> i = input, o = output, c = case.

<sup>2</sup> A = Normal operation, no deviation from specifications, B = Normal operation, temporary loss of function or deviation from specs possible

<sup>3</sup> Not applicable for -2 models

<sup>4</sup> Valid for -2 models

<sup>5</sup> Option L necessary; with option C, manual reset might be necessary.

### Electromagnetic Emission

For emission levels refer to *Electrical Input Data*.

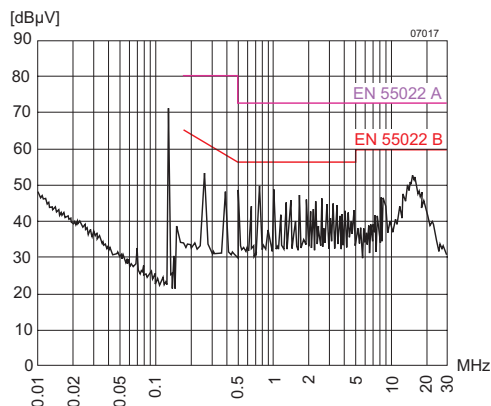


Fig. 11  
 Typical disturbance voltage (quasi-peak) at the input according to EN 55011, measured at  $V_{i\text{nom}}$  and  $I_{o\text{nom}}$ .

## Immunity to Environmental Conditions

Table 6: Mechanical and climatic stress

Test	Method	Standard	Test Conditions	Status
Cab	Damp heat steady state	IEC/EN 60068-2-78 MIL-STD-810D section 507.2	Temperature: 40 ±2 °C Relative humidity: 93 ±2/-3 % Duration: 56 days	Regulator not operating
Ea	Shock (half-sinusoidal)	IEC/EN 60068-2-27 MIL-STD-810D section 516.3	Acceleration amplitude: 50 g <sub>n</sub> = 490 m/s <sup>2</sup> Bump duration: 11 ms Number of bumps: 18 (3 each direction)	Regulator operating
Eb	Bump (half-sinusoidal)	IEC/EN 60068-2-29 MIL-STD-810D section 516.3	Acceleration amplitude: 25 g <sub>n</sub> = 245 m/s <sup>2</sup> Bump duration: 11 ms Number of bumps: 6000 (1000 each direction)	Regulator operating
Fc	Vibration (sinusoidal)	IEC/EN 60068-2-6 MIL-STD-810D section 514.3	Acceleration amplitude: 0.35 mm (10 – 60 Hz) 5 g <sub>n</sub> = 49 m/s <sup>2</sup> (60 – 2000 Hz) Frequency (1 Oct/min): 10 – 2000 Hz Test duration: 7.5 h (2.5 h each axis)	Regulator operating
Fda	Random vibration wide band Reproducibility high	IEC/EN 60068-2-35 DIN 40046 part 23	Acceleration spectral density: 0.05 g <sup>2</sup> /Hz Frequency band: 20 – 500 Hz Acceleration magnitude: 4.9 g <sub>n rms</sub> Test duration: 3 h (1 h each axis)	Regulator operating
Kb	Salt mist, cyclic (sodium chloride NaCl solution)	IEC/EN 60068-2-52	Concentration: 5% (30 °C) Duration: 2 h per cycle Storage: 40 °C, 93% rel. humidity Storage duration: 22 h per cycle Number of cycles: 3	Regulator not operating

## Temperatures

Table 7: Temperature specifications, valid for an air pressure of 800 - 1200 hPa (800 - 1200 mbar)

Temperature			-2		-7		-9 (Option)		
Characteristics	Conditions		min	max	min	max	min	max	Unit
T <sub>A</sub>	Ambient temperature <sup>1</sup>	Regulator operating	-10	50	-25	71	-40	71	°C
T <sub>C</sub>	Case temperature		-10	80	-25	95	-40	95	
T <sub>S</sub>	Storage temperature <sup>1</sup>	Non operational	-25	100	-40	100	-55	100	

<sup>1</sup> See *Thermal Considerations and Overtemperature Protection*.

## Reliability

Table 8: Typical MTBF and device hours

MTBF	Ground Benign	Ground Fixed		Ground Mobile	Device Hours <sup>1</sup>
MTBF accord. to MIL-HDBK-217F	T <sub>C</sub> = 40 °C	T <sub>C</sub> = 40 °C	T <sub>C</sub> = 70 °C	T <sub>C</sub> = 50 °C	13 000 000 h
	625 000 h	207 000 h	96 000 h	46 000 h	

<sup>1</sup> Statistical values, based on an average of 4300 working hours per year and in general field use



## Mechanical Data

Dimensions in mm.

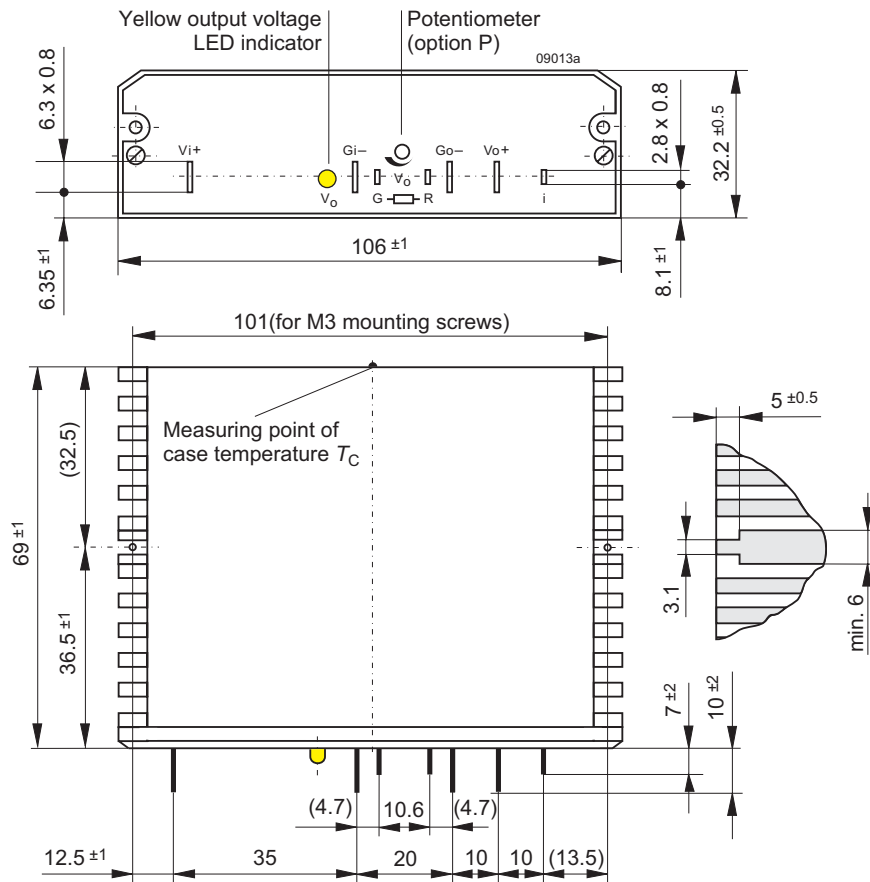


Fig. 12  
Case B02, weight 230 g  
Aluminium, black finish and  
self cooling

## Safety and Installation Instructions

### Installation Instruction

Installation must strictly follow the national safety regulations in compliance with the enclosure, mounting, creepage, clearance, casualty, markings, and segregation requirements of the end-use application.

Check for hazardous voltages before connecting.

The input and the output circuit are not separated, i.e., the negative path is internally interconnected.

Do not open the regulator !

Ensure that a regulator failure (e.g., by an internal short-circuit) does not result in a hazardous condition.

### Cleaning Liquids

In order to avoid possible damage, any penetration of

cleaning fluids must be prevented, since the power supplies are not hermetically sealed.

### Protection Degree

The protection degree is IP 30 (IP 20, if equipped with option P).

### Standards and Approvals

All switching regulators have been approved according to UL 60950, CSA 60950, and IEC/EN 60950-1 2<sup>nd</sup> Ed.

The regulators have been evaluated for:

- Building in
- The use in a pollution degree 2 environment
- Connecting the input to a secondary circuit, which is subject to a maximum transient rating of 1500 V.

The switching regulators are subject to manufacturing surveillance in accordance with the above mentioned standards and with ISO 9001:2008.

### Isolation

Electric strength test voltage between input connected with output against case: 1500 VDC,  $\geq 1$  s (for some PSB models only with version V103 or higher).

These tests are performed in the factory as routine test in accordance with EN 50116 and IEC/EN 60950. The electric strength test should not be repeated by the customer.

### Railway Application

The regulators have been developed observing the railway standards EN 50155 and EN 50121. All boards are coated with a protective lacquer.

## Description of Options

### -9 Extended Temperature Range

This option defines an extended temperature range as specified in table 7.

### P Potentiometer

**Note:** Option P is not recommended, if several regulators are operated in parallel connection.

Option P excludes R function; the R-input (pin 16) should be left open-circuit. The output voltage  $V_o$  is preset to 108 % of  $V_{o,nom}$  and can be adjusted in the range 90 – 108% of  $V_{o,nom}$ .

However, the minimum differential voltage  $\Delta V_{i,o,min}$  between input and output specified in *Electrical Input Data* should be observed.

### L Input Filter

Option L is recommended to reduce superimposed interference voltages and to prevent oscillations, if input lines exceed the length of approx. 5 m in total. The fundamental wave (approx. 120 kHz) of the reduced interference voltage between  $V_{i+}$  and  $G_{i-}$  has, with an input line inductance of 5  $\mu$ H, a maximum magnitude of 4 mVAC.

The input impedance of the switching regulator at 120 kHz is

about 3.5  $\Omega$ . The harmonics are small in comparison with the fundamental wave.

With option L, the maximum permissible additionally superimposed ripple  $v_i$  of the input voltage (rectifier mode) at a specified input frequency  $f_i$  has the following values:

$$v_{i,max} = 10 V_{pp} \text{ at } 100 \text{ Hz or } V_{pp} = 1000 \text{ Hz} / f_i \times 1 \text{ V}$$

### C Thyristor Crowbar

Option C protects the load against power supply malfunction. It is not designed to sink external currents. A fixed-value monitoring circuit checks the output voltage  $V_o$ . When the trigger voltage  $V_{o,c}$  (see table 9) is reached, the thyristor crowbar triggers and disables the output. It can be deactivated by removal of the input voltage. In case of a defect switching transistor, the internal fuse prevents excessive current.

Type of the fuse:

- Regulators with  $I_{o,nom} = 3$  A: 5 A / 250 V, slow, 5  $\times$  20 mm
- Regulators with  $I_{o,nom} > 3$  A: 8 A / 250 V, slow, 5  $\times$  20 mm

**Note:** The crowbar can be reset by removal of the input voltage only. The inhibit signal cannot deactivate the thyristor.

### G RoHS Compliance

Models with G are RoHS-compliant for all six substances.

Table 9: Crowbar trigger levels

Characteristics		Conditions	$V_o = 5.1 \text{ V}$		$V_o = 12 \text{ V}$		$V_o = 15 \text{ V}$		$V_o = 24 \text{ V}$		$V_o = 36 \text{ V}$		Unit
			min	typ	max	min	typ	max	min	typ	max	min	
$V_{o,c}$	Trigger voltage	$T_{C,min} - T_{C,max}$	5.8	6.8	13.5	16	16.5	19	27	31	40	45	V
$t_s$	Delay time	$V_{i,min} - V_{i,max}$ $I_o = 0 - I_{o,nom}$		1.5		1.5		1.5		1.5		1.5	$\mu$ s

### Accessories

A variety of electrical and mechanical accessories are available including:

- PCB-tags and isolation pads for easy and safe PCB-mounting.
- Solder-tags for direct mounting of the regulator to a PCB board
- Ring core chokes for ripple and interference reduction.
- Battery sensor [S-KSMH...] for using the regulator as battery charger. Different cell characteristics can be selected; see BCD20024 on our web site.

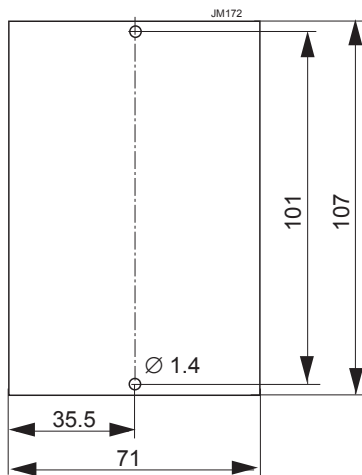


Fig. 13  
Isolation pad HZZ01205-G  
(ISOLATIONB,B01)  
0.3 mm thick

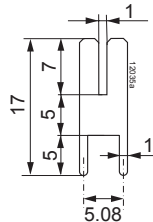


Fig. 14  
Solder tag HZZ01204-G  
(LOETGABEL(10x))  
Delivery content: 10 pieces

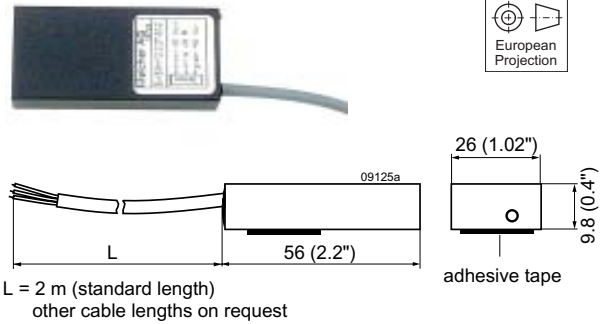


Fig. 15  
Battery temperature sensor

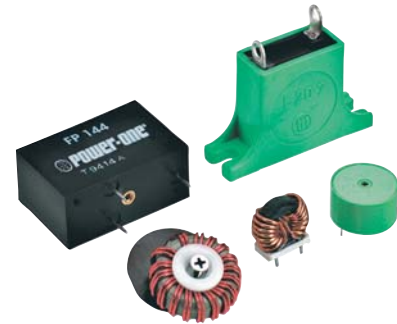


Fig. 16  
Different filters

For additional accessory product information, see the accessory data sheets listed with each product series at our web site.

NUCLEAR AND MEDICAL APPLICATIONS - These products are not designed or intended for use as critical components in life support systems, equipment used in hazardous environments, or nuclear control systems.

TECHNICAL REVISIONS - The appearance of products, including safety agency certifications pictured on labels, may change depending on the date manufactured. Specifications are subject to change without notice.

## X-ON Electronics

Largest Supplier of Electrical and Electronic Components

*Click to view similar products for [Isolated DC/DC Converters](#) category:*

*Click to view products by [Bel Fuse](#) manufacturer:*

Other Similar products are found below :

[ESM6D044440C05AAQ](#) [FMD15.24G](#) [PSL486-7LR](#) [PSR152.5-7IR](#) [Q48T30020-NBB0](#) [AVO240-48S12B-6L](#) [AVO250-48S28B-6L](#) [NAN-0505](#) [HW-L16D](#) [JAHW100Y1](#) [217-1617-001](#) [22827](#) [SPB05C-12](#) [SQ24S15033-PS0S](#) [18952](#) [19-130041](#) [CE-1003](#) [CE-1004](#) [GQ2541-7R](#) [PSE1000DCDC-12V](#) [RDS180245](#) [MAU228](#) [419-2065-201](#) [449-2075-101](#) [TME 0303S](#) [TME 0505S](#) [TME 1205S](#) [TME 1212S](#) [TME 2405S](#) [TME 2412S](#) [V300C24C150BG](#) [419-2062-200](#) [419-2063-401](#) [419-2067-101](#) [419-2067-501](#) [419-2068-001](#) [DCG40-5G](#) [DFC15U48D15](#) [449-2067-000](#) [XGS-0512](#) [XGS-1205](#) [XGS-1212](#) [XGS-2412](#) [XGS-2415](#) [XKS-1215](#) [033456](#) [NCT1000N040R050B](#) [SPB05B-15](#) [SPB05C-15](#) [TME 0509S](#)