

MBC450 Series

AC-DC Open Frame Power Supplies

Medical

The MBC450 Series of open-frame medical power supplies, with its wide universal 90-264 VAC input range, is available at 450 W of output power and a variety of single output voltages.

The MBC series is designed and approved to the latest Medical standards (EN/IEC 60601-1), providing 2 x MOPP isolation for Class I applications.

These medical power supplies are ideal for monitoring, home health equipment as well as surgical devices.



Key Features & Benefits

- 4 x 6.5 x 1.61 inches
- Approved to EN/IEC 60601-1
- Dual Fusing
- Peak Power Capability
- Class B EMI & Medical (BF) Safety Approvals
- Side Fan or Top Fan Mounting Option
- Current Sharing Option
- Class B EMI & Medical (BF) Safety Approvals
- RoHS Compliant
- CE marked

Applications

- Diagnostic
- Drug Pump
- Dialysis
- Hospital Beds
- Home Health Care
- Monitoring
- Imaging
- Therapy Devices

1. MODEL SELECTION

MODEL ¹	OUTPUT VOLTAGE	MAX LOAD		MINIMUM LOAD	RIPPLE & NOISE ²	POWER
		CONVECTION	420 LFM			
MBC450-1T05G	5 VDC	31.0 A	55.0 A	0.0 A	2%	275 W
MBC450-1T12G	12 VDC	20.83 A	37.5 A	0.0 A	2%	450 W
MBC450-1T15G	15 VDC	16.66 A	30.0 A	0.0 A	2%	450 W
MBC450-1T24G	24 VDC	12.30 A	18.75 A	0.0 A	2%	450 W
MBC450-1T30G	30 VDC	10.0 A	15.0 A	0.0 A	2%	450 W
MBC450-1T48G	48 VDC	6.25 A	9.37 A	0.0 A	2%	450 W

¹ For Side Fan Mounting option, add suffix -S to the part number (e.g.: MBC450-1T12G-S)

For Top Fan Mounting option add suffix -T to the part number (e.g.: MBC450-1T24G-T)

For Current Sharing option, add suffix -I to the part number (e.g.: MBC450-1T48G-I or MBC450-1T48G-I-S)

² Ripple is peak to peak with 20 MHz bandwidth and 10 μ F (Electrolytic capacitor) in parallel with a 0.1 μ F capacitor at rated line voltage and load ranges. Please contact factory/ sales representative for minimum load required for ripple to be within specification.

2. INPUT SPECIFICATIONS

Specifications are for nominal input voltage, 25°C unless otherwise stated.

PARAMETER	DESCRIPTION / CONDITION	SPECIFICATIONS
Input Voltage	Universal	90 – 264 VAC / 120 – 390 VDC
Input Frequency		47 – 63 Hz
Input Current	120 VAC: 230 VAC:	4.5 A max. 2.3 A max.
No Load Power	120 VAC: 230 VAC:	0.4 W 0.8 W
Inrush Current	120 VAC: 230 VAC:	40 A max. 75 A max.
Leakage Current	Earth Leakage Current Touch Leakage Current	270 μ A 45 μ A @ 120 VAC / 63 Hz
Input Protection	Dual fusing, in Live & Neutral	T8A / 250 V
No Load Power	120 VAC: 230 VAC:	0.4 0.3
Switching Frequency	PFC converter: Variable Resonant converter: Variable	45 – 160 kHz typical 35 – 250 kHz, 90 kHz typical

3. OUTPUT SPECIFICATIONS

PARAMETER	DESCRIPTION / CONDITION		SPECIFICATIONS
Output Voltage			5 to 48 V
Output Power ^{3,4}	475 W for 24 V, 30 V models & 500 W for 48 V model only for 5 seconds max.		155 to 450 W
Standby Output ⁵			5 VDC
Fan Output ⁶			12 V
Efficiency (Full Load)	120 VAC	24, 30 & 48 V models 12 & 15 V models 5 V model	88% 86% 83% typical
	230 VAC	24, 30 & 48 V models	90%
Hold Up Time	120 / 230 VAC		10 ms
Power Factor	120 VAC		0.98
	230 VAC		0.95
Line Regulation			± 0.5%
Load Regulation			± 3%
Transient Response	<10%, 50% to 100% load change, 50 Hz, 50% duty cycle, 0.1 A/μs		Recovery time < 5 ms
Rise Time			< 100 ms
Set Point Tolerance			± 1%
Output Voltage Adjustment	V1		± 3 %
Over Voltage Protection	Latch Type		>114%
Over Current Protection	Hiccup type		120 to 150%
Short Circuit Protection	Short term, auto recovery		
Over Temperature Protection	Automatic recovery		130°C primary heat sink
Current Share	Up to 2 supplies connected in parallel (optional)		
Cooling	Convection	5 V model	155 W
		12 & 15 V models	250 W
		24, 30 & 48 V models	300 W
	With 420 LFM	5 V model	275 W
	12 & 15 V models	450 W	
	24, 30 & 48 V models	450 W	

³ Combined output power of main output, fan supply and standby supply shall not exceed max. power rating.

⁴ Derate output power linearly to 80% from 90 VAC to 80 VAC input.

⁵ Standby output voltage 5 V / 1.5 A (convection) / 2 A (420 LFM) with tolerance including set point accuracy, line & load regulation is +/-10%. Ripple and noise is less than 5%.

⁶ Fan supply output voltage 12V / 500 mA with tolerance including set point accuracy, line and load regulation is +/-30% and needs min. 1% load on main output to be within regulation band. Ripple and noise is less than 10%.

4. SIGNALS

PARAMETER	DESCRIPTION / CONDITION
Power Good Signal	TTL signal goes high after main output is within regulation band, delay is 0.1 to 0.3 s
Remote Sense	Compensates for 200 mV drop
Remote on/off	To turn on PSU short remote pin to ground

5. EMC SPECIFICATIONS

PARAMETER	DESCRIPTION / CONDITION	SPECIFICATION
Conducted Emissions	EN 55011-B, CISPR22-B, FCC PART15-B	Pass
Radiated Emissions	EN 55011 B	Pass
Input Current Harmonics	EN 61000-3-2	Class D
Voltage Fluctuation and Flicker	EN 61000-3-3	Pass
ESD Immunity	EN 61000-4-2	Level 4, Criterion A
Radiated Field Immunity	EN 61000-4-3	Level 3, Criterion A
Electrical Fast Transient Immunity	EN 61000-4-4	Level 3, Criterion A
Surge Immunity	EN 61000-4-5	Level 3, Criterion A
Conducted Immunity	EN 61000-4-6	Level 3, Criterion A
Magnetic Field Immunity	EN 61000-4-8	Level 4, Criterion A
Voltage Dips, Interruptions	EN 61000-4-11	Criterion A & B

6. SAFETY SPECIFICATIONS

PARAMETER	DESCRIPTION / CONDITION	SPECIFICATION
Isolation Voltage	Input to Output, 2MOPP	5940 VDC
	Input to Earth, 1MOPP	2121 VDC
	Output to GDN for type BF	1500 VAC
Safety Standards	EN 60601-1, IEC 60601-1 (ed.3), ANSI / AAMI ES 60601 - 1, CSA C22.2 No. 60601-1	
Agency Approvals	Nemko, UL, C-UL	
CE mark	Complies with LVD Directive	

7. ENVIRONMENTAL SPECIFICATIONS

PARAMETER	DESCRIPTION / CONDITION	SPECIFICATIONS
Operating Temperature	Refer to derating curves	0 to +70°C
	-20 to 0°C, start-up is guaranteed	
Storage Temperature		-40 to 85° C
Humidity	Non-Condensing	95% HR
Altitude	Operating:	10,000 ft.
	Non-Operating:	40,000 ft.
Reliability	MTBF according to Telcordia -SR332-Issue 3	1.28 million hours

DERATING CURVES

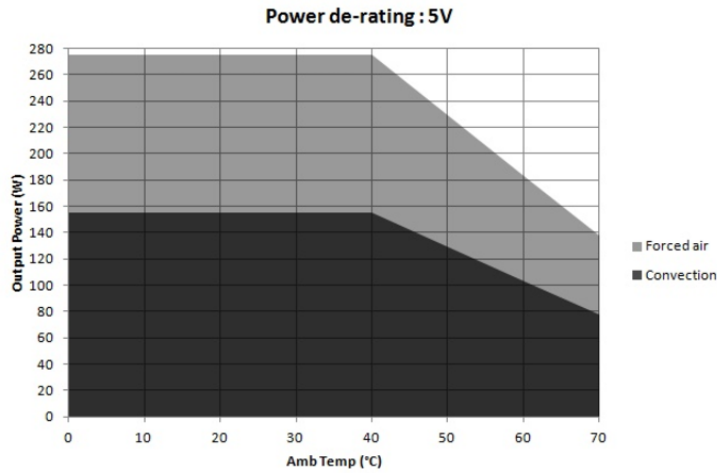

Convection load: 155 W up to 40 °C
De-rate above 40 °C @ 1.67% per °C

Forced air cooled load: 275 W up to 40°C
De-rate above 40 °C @ 1.67% per °C

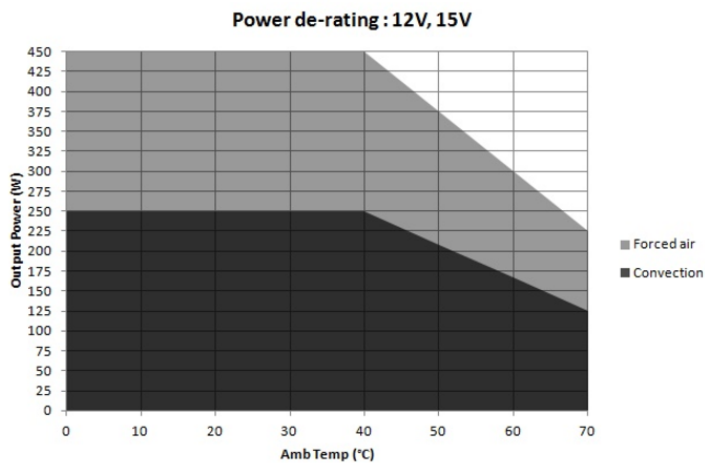

Convection load: 250 W up to 40 °C
De-rate above 40 °C @ 1.67% per °C

Forced air cooled load: 450 W up to 40°C
De-rate above 40 °C @ 1.67% per °C

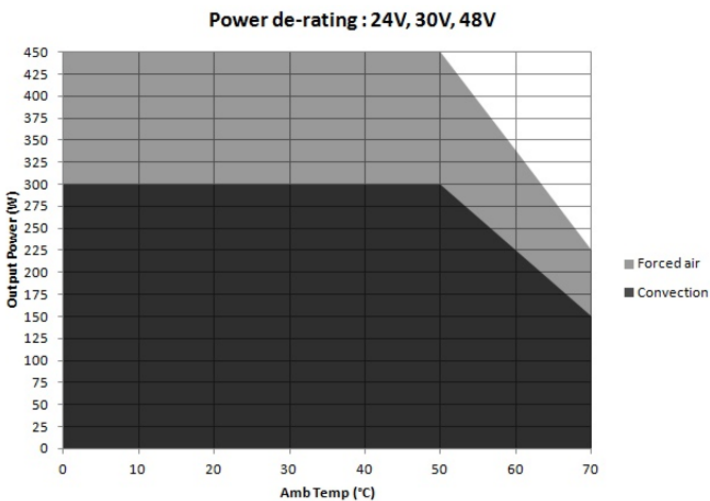

Convection load: 300 W up to 50 °C
De-rate above 50 °C @ 2.5% per °C

Forced air cooled load: 450 W up to 50°C
De-rate above 50 °C @ 2.5% per °C

Figure 1. Derating Curves

8. CONNECTOR & PIN DESCRIPTION

CONNECTOR	PIN	DESCRIPTION / CONDITION	MANUFACTURER / PN
AC Input Connector	J1	Pin 1 Pin 3 Pin 5	AC line AC neutral Earth
DC Output Connector	J2	Lug 1 Lug 2	+V1 RTN
Signals ⁷	J3	Pin 1 Pin 2 Pin 3 Pin 4 Pin 5 Pin 6 Pin 7 Pin 8 Pin 9 Pin 10	NC Power Fail Power Good DC Return +5Vstby +VE Remote Sense -VE Remote Sense CS DC Return Remote On/Off
Fan	J4	Pin 1 Pin 2	+VE -VE
Earth (Spade Connector) ⁸	J5		

⁷ PSU is supplied with J3 housing, pin-9 and pin-10 shorted to enable main output without remote on/off feature.

⁸ The J5 (Earth) spade connector can be used for U-Channel option products only. When fan options are required the earth connection provided in the input AC connector should be used (Pin 5 – J1)

9. MECHANICAL SPECIFICATIONS

PARAMETER	DESCRIPTION / CONDITION
Weight	900 g (1.98 lbs)
Dimensions	101.6 x 165.0 x 41.0 mm (4.0 x 6.5 x 1.6 in)

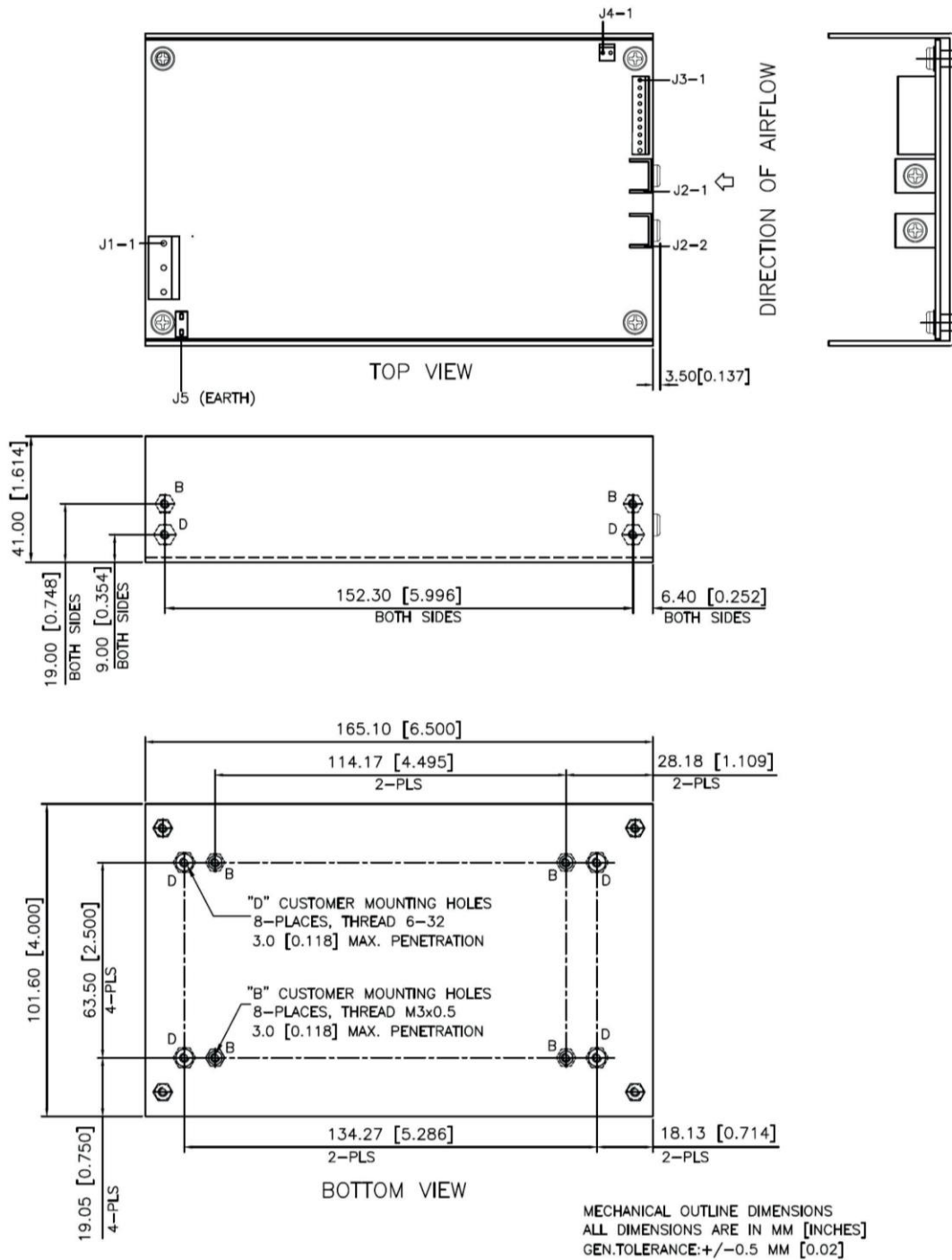

Figure 2. Mechanical Drawing (Without Fan Mounting)

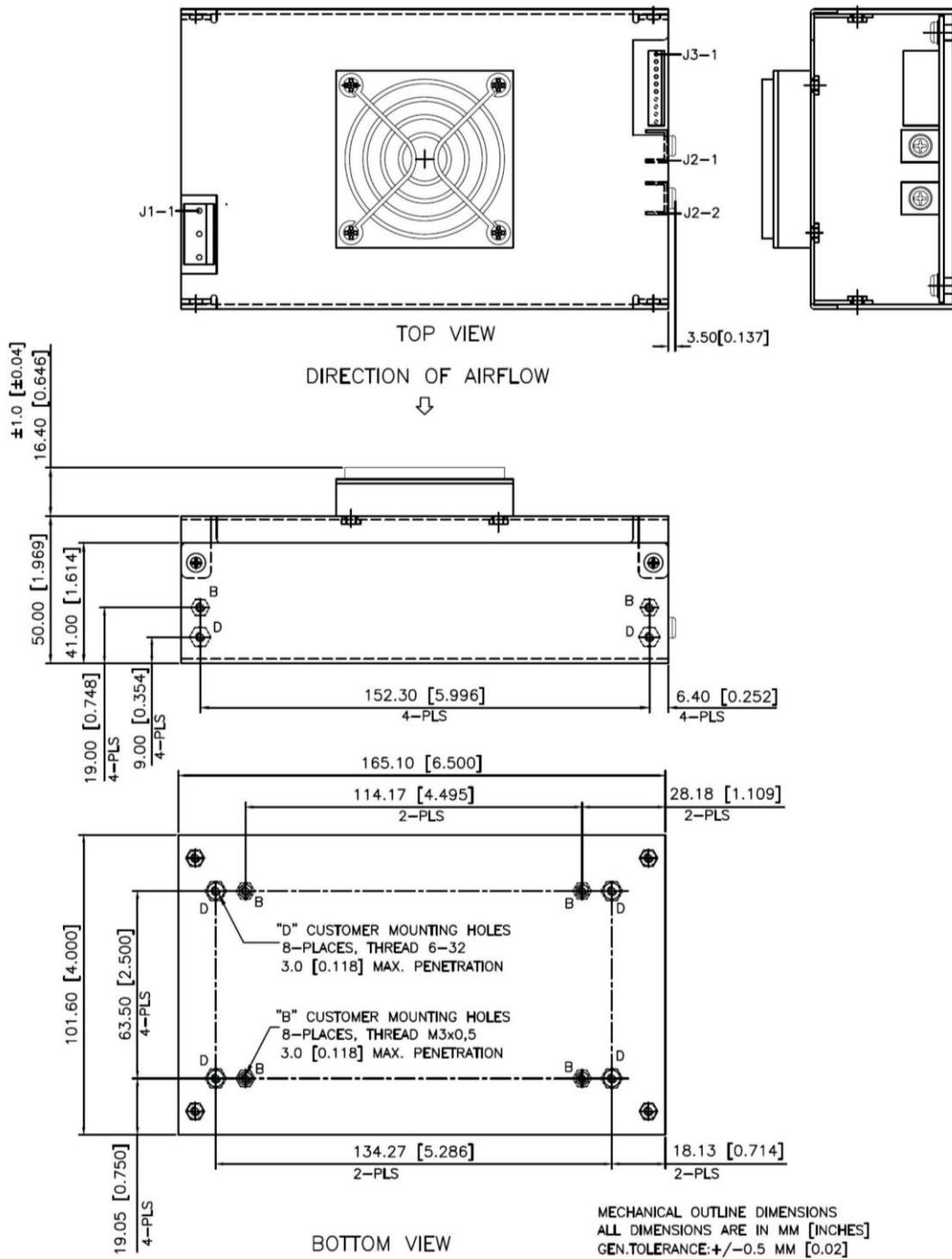

Figure 3. Mechanical Drawing (With Top Fan Mounting)

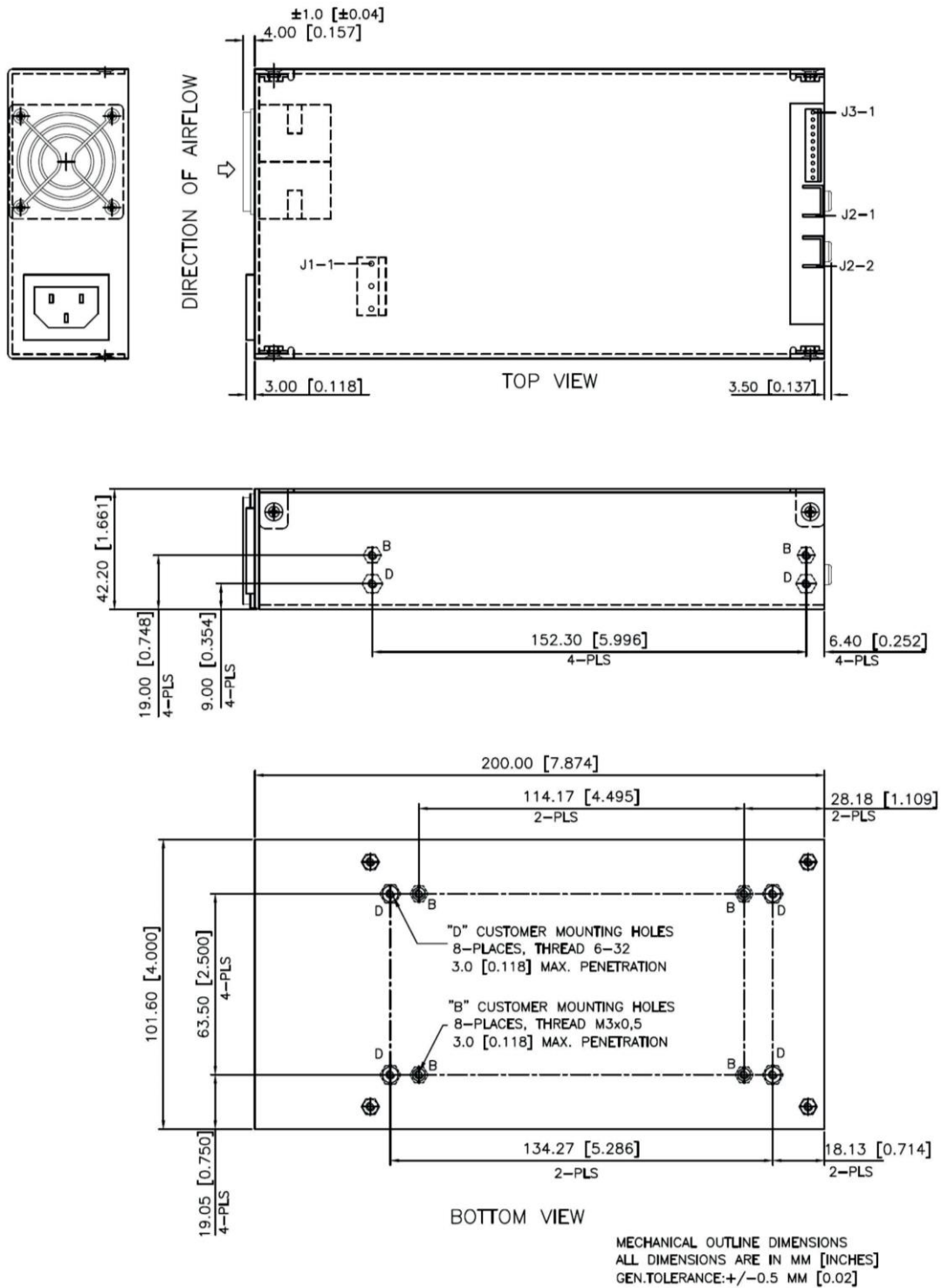

Figure 4. Mechanical Drawing (With Side Fan Mounting)

10. INSTALLATION INSTRUCTION FOR CURRENT SHARING

During the installation and setup of parallel supplies in a system it is important that a single remote sense point be used for all the supplies.

The remote sense voltage between the supplies must be adjusted to within 2% to ensure the supplies are inside the 3% capture window.

If the supplies are not initially adjusted inside the capture window the supplies will not current share.

NOTE:

“CURRENT SHARING” facility is inclusive with the unit only with ordering of the “CURRENT SHARING” option by adding suffix -I to the part number, i.e. MBC450-1XXX-I or MBC450-1XXX-I.

SET-UP PROCEDURE:

- 1 Connect load cables to the outputs of each supply.
- 2 Connect the remote sense lines to the load in twisted style. (A common remote sense point must be used for all the supplies in parallel).
- 3 Connect all the “current share” pins on the J3 connector between the supplies.
- 4 Adjust remote sense voltage of each supply to within 1% of rated output voltage or readjust to required set point. (Adjustment to be done with all other parallel supplies off).
- 5 Current sharing between the supplies can be verified by monitoring the output current of each supply with a hall effect DC current probe. The supplies should share to within 10% of the total load current.
- 6 The current share circuit has a capture window voltage of +/- 3% of the rated output voltage. If the output remote sense voltage of one of the supplies is adjusted outside the 3% window the supplies will not current share.

CURRENT SHARING BLOCK DIAGRAM

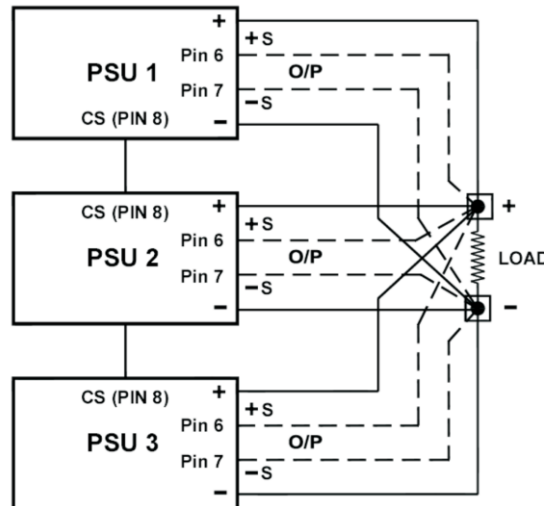

For more information on these products consult: tech.support@psbel.com

NUCLEAR AND MEDICAL APPLICATIONS - Products are not designed or intended for use as critical components in life support systems, equipment used in hazardous environments, or nuclear control systems.

TECHNICAL REVISIONS - The appearance of products, including safety agency certifications pictured on labels, may change depending on the date manufactured. Specifications are subject to change without notice.

X-ON Electronics

Largest Supplier of Electrical and Electronic Components

Click to view similar products for [Switching Power Supplies](#) category:

Click to view products by [Bel Fuse](#) manufacturer:

Other Similar products are found below :

[70841011](#) [73-551-0005](#) [73-551-0048](#) [PS3E-B12F](#) [PS3E-E12F](#) [AAD600S-4-OP](#) [R22095](#) [KD0204](#) [9021](#) [LDIN100150](#) [LPM000-BBAR-01](#)
[LPX17S-C](#) [EVS57-10R6/R](#) [FP80](#) [FRV7000G](#) [22929](#) [PS3E-F12F](#) [CQM1IA121](#) [40370121900](#) [VI-PU22-EXX](#) [40370121910](#) [LDIN5075](#)
[LPM615-CHAS](#) [LPX140-C](#) [09-160CFG](#) [70841025](#) [VPX3000-CBL-DC](#) [VI-LUL-IU](#) [LPM000-BBAR-05](#) [LPM000-BBAR-08](#) [LPM124-](#)
[OUTA1-48](#) [LPM000-BBAR-07](#) [LPM109-OUTA1-10](#) [LPM616-CHAS](#) [08-30466-1055G](#) [08-30466-2175G](#) [08-30466-2125G](#) [DMB-EWG](#)
[TVQF-1219-18S](#) [6504-226-2101](#) [CQM1IPS01](#) [SP-300-5](#) [CQM1-IPS02](#) [VI-MUL-ES](#) [22829](#) [08-30466-0065G](#) [VI-RU031-EWWX](#) [08-30466-](#)
[0028G](#) [EP3000AC48INZ](#) [VP-C2104853](#)