

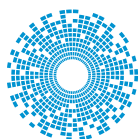

## PWF Series

# Crimp/Bayonet Coupling Connectors

MIL-C-26482, Series I Crimp  
Commercial and Military QPL'd



**cinch**  
CONNECTIVITY SOLUTIONS  
a bel group

+1 305.234.1000  
[cinch.com](http://cinch.com)

## PRODUCT INDEX

# Crimp/Bayonet Coupling Connectors MIL-C-26482, Series I Crimp Commercial and Military QPL'd

### Contents

Product Data and Polarization	3
Nomenclature Guide and Cross Reference	4
Contacts Arrangements	5
Panel Mounting Data	6
Series PWF00/MS3120 Wall Mount Receptacle	7
Series PWF01/MS3121 In-Line Receptacle	8
Series PWF02/MS3122 Box Mount Receptacle	9
Series PWF07/MS3124 Jam Nut Receptacle	10
Series PWF06/MS3126 Straight Plug	11
Series PW80/MS3180 and PW81/MS3181 Protective Caps	12
Contact Data	13
Crimping Instructions	14

### Features

Cinch's PWF family of connectors meet or exceed the requirements of MIL-C-26482

Series I Crimp and are listed in the U.S. Department of Defense Qualified Parts List.

These connectors are available in 9 shell sizes and 24 insert arrangements, all inter-mateable and interchangeable with connectors produced in accordance with MIL-C-26482 Series I and Series II. Standard contact termination is by crimping using standard crimp tools: either automated wire stripping and crimping machines or manually with the use of hand crimping tools. Contact insertion and extraction is also accomplished with the use of standard tools.

Designed for wire sizes AWG 16 through 24, these highly durable connectors are used in wide variety of applications including aerospace, military equipment, machine tools, robotics, communications, medical equipment, automation equipment, and industrial sensors to name just a few.

Shells and hardware are made of high strength aluminum alloys and are available with a variety of plated or anodized finishes. Contacts are machined from solid copper alloy and gold plated in accordance with MIL-G-45204 type II. With a standard operating temperature range of -55°C to +125°C available with a variety of accessories and features, Cinch's PWF series is widely called out by design engineers and specifiers seeking reliability and durability throughout a broad range of environmental requirements.

Cinch Connectivity Solutions produces high quality products. These products are intended to be used in accordance with the specifications described in this catalog. Any use or application that deviates from the stated operating specifications is not recommended and may be unsafe. A limited warranty is applicable. Except for obligations assumed by Cinch Connectivity Solutions under

warranty, Cinch will be not be liable for any loss, damage, repairs, incidental or consequential damages of any kind, whether or not based upon expressed or implied warranty, contract, negligence, or liability arising from the application or manufacture or repair of these products. This catalog is not a contractual offering; it is for informational purposes only.

# PWF / MS Receptacle

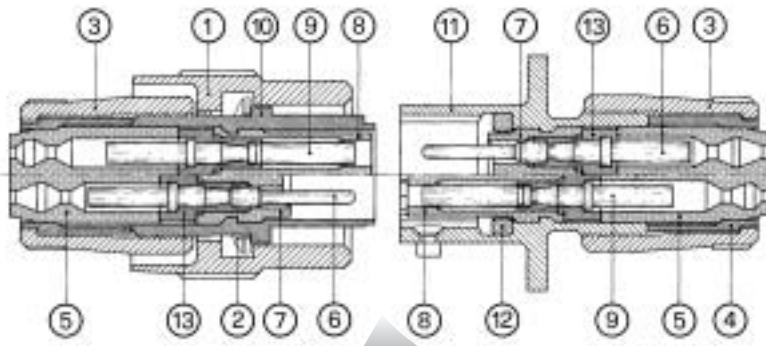

- 1) Coupling nut
- 2) Wave washer
- 3) Back shell
- 4) Compression sleeve
- 5) Grommet
- 6) Pin contact
- 7) Pin insert
- 8) Socket insert
- 9) Socket contact
- 10) Plug shell
- 11) Receptacle shell
- 12) Gasket
- 13) Contact retention disk

Nine shell sizes are available and twenty-four insert arrangements with both pin and socket contacts.



**PWF00/MS3120**  
Wall Mount Receptacle



**PWF01/MS3121**  
In-Line Receptacle



**PWF02/MS3122**  
Box Mount Receptacle



**PWF06/MS3126**  
Straight Plug



**PWF07/MS3124**  
Jam Nut Receptacle (Environmental)

# Product Data

## Electrical

Contact Termination	(PWF) Crimp
Number of Contacts	3 to 61
Wire Size, AWG	16 to 24
Wire Range Accomodations	Insulation O.D. Limits

Contact Size	AWG Wire Size	Min.	Max.
20	24, 22 and 20	.066 (1.52)	.083 (2.11)
16	20, 18 and 16	.066 (1.68)	.109 (2.77)

### Contact Rating

Contact Size	Rated Amps	Test current	Max. Millivolt Drop
20	7.5	7.5	55
16	13.0	13.0	49

### Voltage Rating

Altitude	Service Rating	Test Voltage		Max. Working Voltage	
		AC(rms)	DC	AC(rms)	DC
Sea Level	1	1500	2100	600	850
	2	2300	3200	1000	1400
70,000 ft.	1	375	535	300	510
	2	500	770	450	740

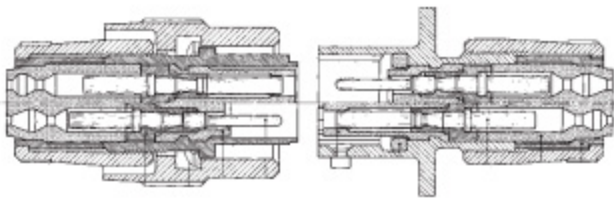

## Standard Material and Finishes

Shell (Mil-Std)	Aluminum alloy, conductive olive drab chromate over cadmium finish per QQ-P-416. (Consult Factory for Commercial options.)
Insulator	Synthetic Rubber
Grommet and Seal	Synthetic Rubber
Contacts	Cooper alloy, gold plate per MIL-G-45204 type II.
Temperature Range	-55°C to +125°C

## Mechanical

Shell Styles	00 - Wall mounting receptacle 01 - Cable in line receptacle 02 - Box mounting receptacle 06 - Straight plug 07 - Jam nut receptacle 08 - 90° Angle plug
Shell Size	8 thru 24
Polarization/Coupling	Five keyway/three point bayonet locking.

Service Classes  
 E - Grommet seal  
 F - Grommet seal with strain relief  
 N - No back end, no termination hardware  
 P - Potted

## Engaging Face-Pin Inserts

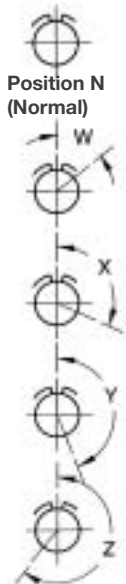

## Polarization

The diagrams indicate alternate insert positions. The five positions (W, X, Y, Z and Normal) differ in degree of rotation for various size and layouts. The exact angle of rotation for the combinations are listed in the table below.

Shell Size	Layout	Position			
		W	X	Y	Z
8	3A	60°	-	-	-
	33	90°	-	-	-
10	6	90°	-	-	-
	7	90°	-	-	-
12	3	-	-	180°	-
	8	90°	112°	203°	292°
	10	60°	155°	270°	295°
14	5	40°	92°	184°	273°
	12	43°	90°	-	-
	15	17°	110°	155°	234°
	18	15°	90°	180°	270°
	19	30°	165°	315°	-

Shell Size	Layout	Position			
		W	X	Y	Z
8	8	54°	152°	180°	331°
	23	158°	270°	-	-
16	26	60°	-	275°	338°
	11	62°	119°	241°	340°
18	32	85°	138°	222°	265°
	16	238°	318°	333°	347°
20	39	63°	144°	252°	333°
	41	45°	126°	225°	-
22	21	16°	135°	175°	349°
	41	39°	135°	264°	-
24	55	30°	142°	226°	314°
	61	90°	180°	270°	324°

Note: for polarization data for the other contact arrangements, consult factory.

# Nomenclature Guide

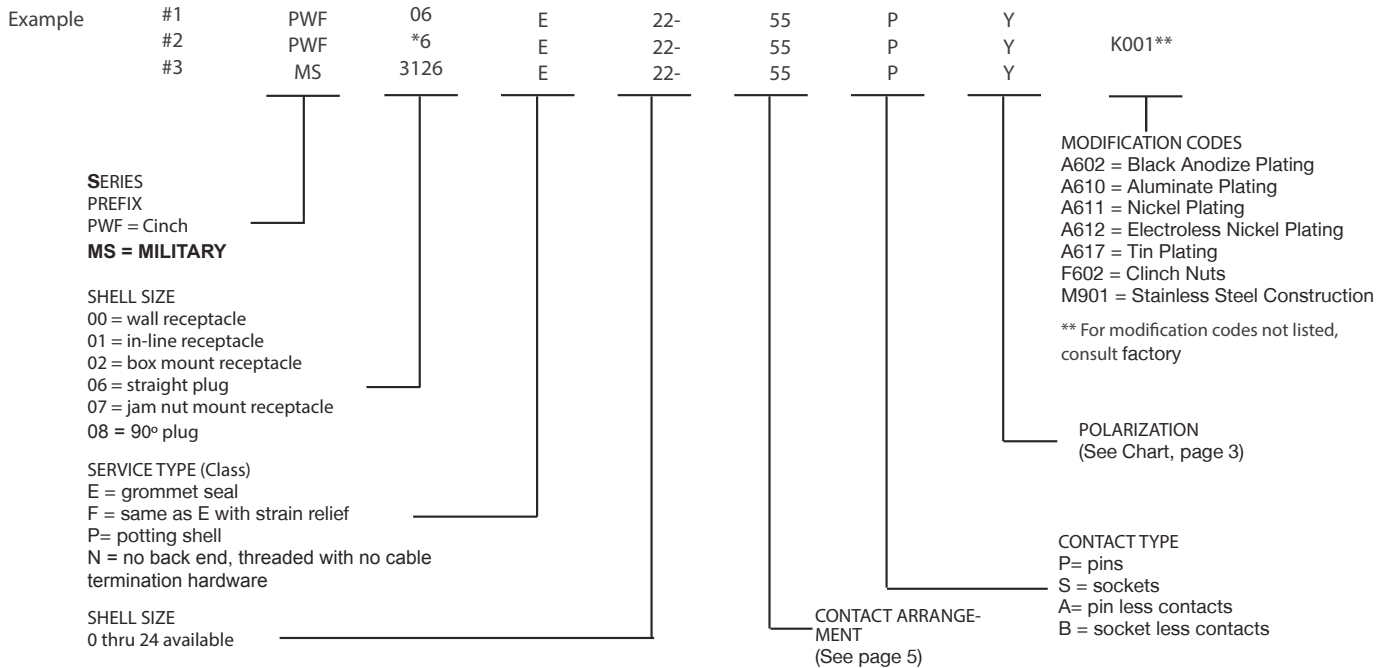

\*NOTE: When modification to a standard plug or receptacle is required, delete the "0" between the PWF and the "6" as in example #2.

## Cross Reference

MIL SPEC PART NOS.	LEADING SUPPLIERS' COMMERCIAL EQUIVALENT					
	Cinch	AMPHENOL-BENDIX	CANNON	FCI/BURNDY	SOURIAU	VEAM
MS3120E*	PWF00E*	PT00SE*	KPSE00E*	L*TE*O*A	851-00R*50*	VPT00SE*
MS3120F*	PWF00F*	PT00SE*(SR)	KPSE00F*	L*TF*O*A	851-00RC*50	VPT00SE*(SR)
MS3120P*	PWF00P*	PT00SP*	KPSE00P*	L*TP*O*A	851-00RP*50	VPT00SP*
MS3121E*	PWF01E*	PT01SE*	KPSE01E*	L*TE*1*A	851-01R*50	VPT01SE*
MS3121F*	PWF01F*	PT01SE*(SR)	KPSE01F*	L*TF*1*A	851-01RC*50	VPT01SE*(SR)
MS3121P*	PWF01P*	PT01SP*	KPSE01P*	L*TP*1*A	851-01RP*50	VPT01SP*
MS3122E*	PWF02E*	PT02SE*	KPSE02E*	L*TE*2*A	851-02R*50	VPT02SE*
MS3124E*	PWF07E*	PT07SE*	KPSE07E*	L*TE*4*A	851-07R*50	VPT07SE*
MS3124F*	PWF07F*	PT07SE*(SR)	KPSE07F*	L*TF*4*A	851-07RC*50	VPT07SE*(SR)
MS3124P*	PWF07P*	PT07SP*	KPSE07P*	L*TP*4*A	851-07RP*50	VPT07SP*
MS3126E*	PWF06E*	PT06SE*	KPSE06E*	L*TE*6*A	851-06R*50	VPT06SE*
MS3126F*	PWF06F*	PT06SE*(SR)	KPSE06F*	L*TF*6*A	851-06RC*50	VPT06SE*(SR)
MS3126P*	PWF06P*	PT06SP*	KPSE07P*	L*TP*6*A	851-06RP*50	VPT06SP*
~~~~~	PWF08* 90o Cable Entry Plug	PT08SE* (No MS drawing.	KPSE08* Do not confuse with MS3128)		851-08RP*50	VPT08SE*
~~~~~	PWF**N* No rear accessories	PT03/4/5SE* (Commercial part numbering only)	KPSE03/4/5*			
MS3127E* Box Mount, Special Large Flange (Special)	PWF05*	MF02S*	KP27E*	L*TE*7*A		
MS3128E* Wall Mount, Special Wide Flange (Special)	PWF04*	MF00SE*	KP28E*	L*TE*8*A		





















**NOTES:**

- Souriau is "commercial only". Not on QPL.
- For MS connectors "without contacts", include "less contacts" after the complete connector MS number. The MS number does not change.
- Connectors per MS have spare contacts and sealing plugs. Connectors per supplier's commercial part number do not have these additional parts.

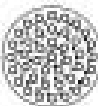

# Contact Arrangement (Engaging Face of Pin Insert)

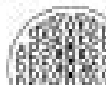
(For contact arrangements not shown, contact factory)

08	<p>3A 3 No. 20 Contacts</p> 	<p>33 3 No. 20 Contacts</p> 	
10	<p>6 6 No. 20 Contacts</p> 	<p>7 7 No. 20 Contacts</p> 	
12	<p>3 3 No. 16 Contacts</p> 	<p>8 8 No. 20 Contacts</p> 	<p>10 10 No. 20 Contacts</p> 
14	<p>3 3 No. 16 Contacts</p> 	<p>8 8 No. 20 Contacts</p> 	<p>10 10 No. 20 Contacts</p> 
16	<p>8 8 No. 16 Contacts</p> 	<p>23 1 No. 16 Contact 22 No. 20 Contacts</p> 	<p>26 26 No. 20 Contacts</p> 
18	<p>11 11 No. 16 Contacts</p> 	<p>32 32 No. 20 Contacts</p> 	
20	<p>16 16 No. 16 Contacts</p> 	<p>39 2 No. 16 Contacts 37 No. 20 Contacts</p> 	<p>41 41 No. 20 Contacts</p> 
22	<p>21 21 No. 16 Contacts</p> 	<p>41 14 No. 16 Contacts 27 No. 20 Contacts</p> 	<p>55 55 No. 20 Contacts</p> 
24	<p>61 61 No. 20 Contacts</p> 	<p>** Commercial arrangement.                      ° MIL-C-26482 Series 1 Contact arrangements, per MIL-STD-1669</p>	

# Panel Mounting Data

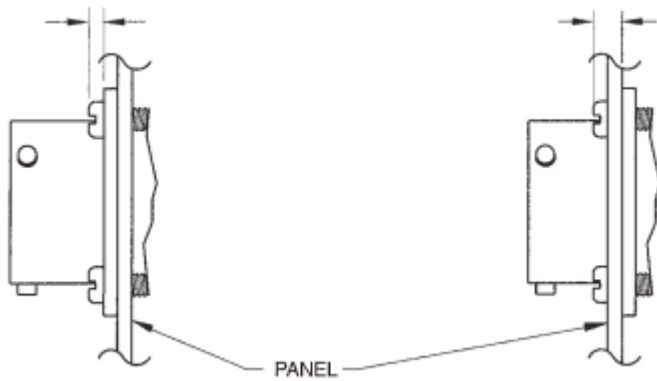

Front Panel Mounting

Rear Panel Mounting

## Max Panel & Screw Heads

SHELL SIZE	PW00	PW02
8		
10		
12	0.087	0.087
14		
16		
18		
20		
22	0.212	0.212
24		

Note: All dimensions relate to distance in front of flange required for proper mating.

# Series PW Panel Cutout Dimensions

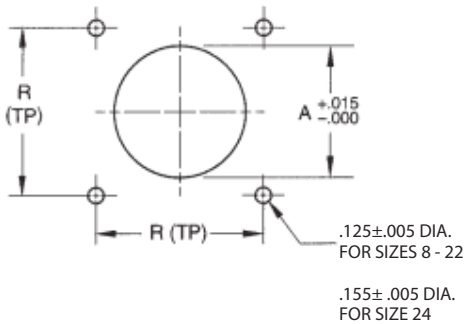

## Wall & Box Mounting Receptacle 00, 02

Square flange PWF receptacles are normally front panel mounted, using dimensions indicated. Hole location "R" is true position and is located within .005 dia. of (TP). When back panel mounting, provision must be made for bayonet pin and coupling clearance.

SHELL SIZE	INCHES		MILLIMETERS	
	A	R	A	R
8	.479	.594	12.17	15.08
10	.603	.719	15.32	18.28
12	.730	.812	18.54	20.61
14	.855	.906	21.72	23.00
16	.979	.969	24.87	24.60
18	1.103	1.062	28.02	27.00
20	1.223	1.156	30.56	29.36
22	1.350	1.250	33.78	31.75
24	1.475	1.375	36.96	33.98

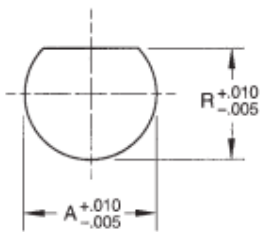

## Jam Nut Receptacle 07

PWF jam nut receptacles are rear panel mounted in a "D" shaped mounting hole. Minimum panel thickness is .062", maximum is .125" for sizes 8 through 18 and .250" for sizes 20 through 24.

SHELL SIZE	INCHES		MILLIMETERS	
	A	R	A	R
8	.572	.540	14.53	13.72
10	.697	.665	17.70	16.90
12	.885	.828	22.45	21.03
14	1.010	.952	25.67	24.20
16	1.135	1.076	28.87	27.35
18	1.260	1.201	32.00	30.75
20	1.385	1.326	35.18	33.65
22	1.510	1.451	38.35	36.83
24	1.635	1.576	41.50	40.00

# Series PWF00/MS3120 Wall Mount Receptacle

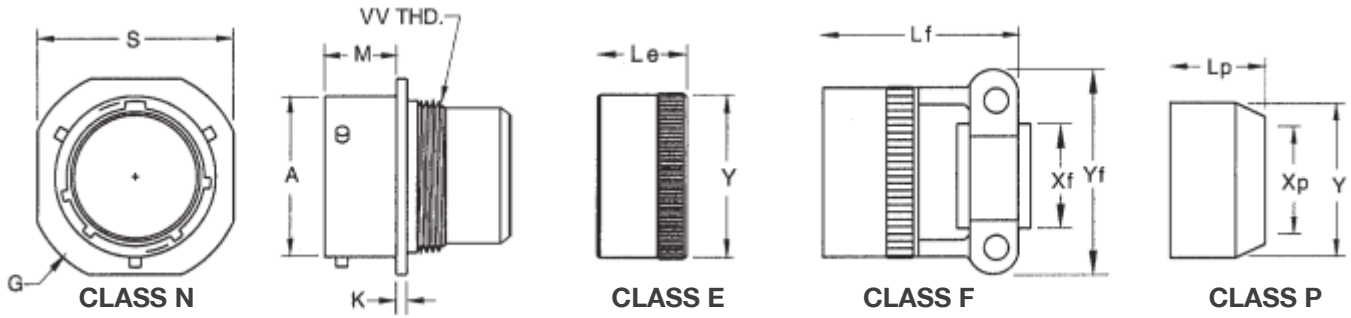

Application: Wall Mounting Connector.

Note: L\* = Total connector length including cable accessory.

## Dimensions in Inches

SHELL SIZE	Xf MIN.	Xp MIN.	K± .016	YMAX.	Yf MAX.	M+.031 -.000	A±.003	SMAX.	T±.005	V V THREAD CLASS 2A
8	.234	.317	.062	.608	.828	.431	.471	.828	.120	7/16-28 UNEF
10	.297	.434	.062	.734	.891	.431	.588	.954	.120	9/16-24 UNEF
12	.422	.548	.062	.858	1.016	.431	.748	1.047	.120	11/16-24 UNEF
14	.547	.673	.062	.984	1.141	.431	.873	1.141	.120	13/16-20 UNEF
16	.609	.798	.062	1.110	1.203	.431	.998	1.234	.120	15/16-20 UNEF
18	.734	.899	.062	1.234	1.469	.431	1.123	1.328	.120	1 1/16-18 UNEF
20	.734	1.024	.094	1.360	1.469	.556	1.248	1.453	.120	1 3/16-18 UNEF
22	.922	1.149	.094	1.484	1.656	.556	1.373	1.578	.120	1 5/16-18 UNEF
24	.984	1.274	.094	1.610	1.750	.589	1.498	1.703	.147	1 7/16-18 UNEF

## Dimensions in Millimeters

SHELL SIZE	Xf MIN.	Xp MIN.	K± .406	YMAX.	Yf MAX.	M+ .787 -.000	A± .076	SMAX.	T± .127	V V THREAD CLASS 2A
8	5.95	8.05	1.57	15.44	21.03	10.95	11.99	21.03	3.05	7/16-28 UNEF
10	7.54	11.02	1.57	18.64	22.63	10.95	14.94	24.23	3.05	9/16-24 UNEF
12	10.72	13.92	1.57	21.79	25.81	10.95	19.00	26.59	3.05	11/16-24 UNEF
14	13.89	17.09	1.57	24.99	28.98	10.95	22.17	28.98	3.05	13/16-20 UNEF
16	15.47	20.27	1.57	28.19	30.56	10.95	25.35	31.34	3.05	15/16-20 UNEF
18	18.64	22.83	1.57	31.34	37.31	10.95	28.52	33.73	3.05	1 1/16-18 UNEF
20	18.64	26.01	2.39	34.54	37.31	14.12	31.70	36.91	3.05	1 3/16-18 UNEF
22	23.42	29.18	2.39	37.82	42.06	14.12	34.27	40.08	3.05	1 5/16-18 UNEF
24	24.99	32.26	2.39	40.89	44.45	14.96	38.05	43.26	3.73	1 7/16-18 UNEF



# Series PWF01 /MS3121 In-Line Receptacle

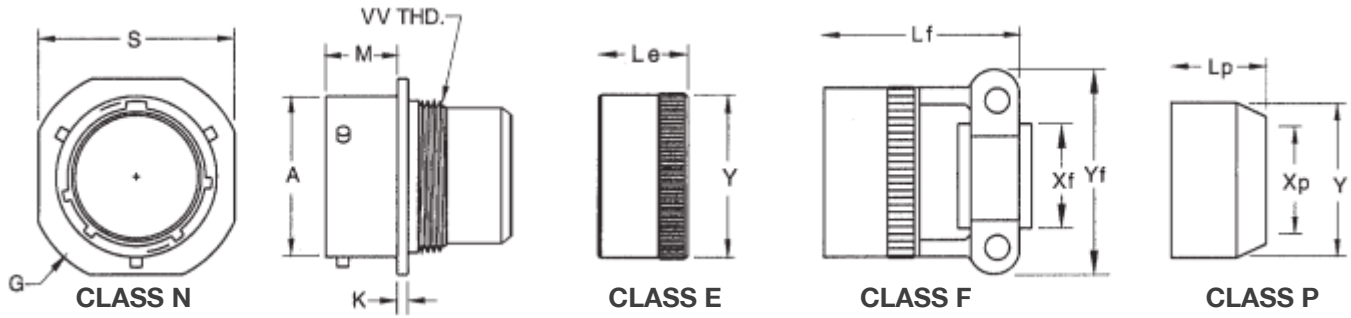

Application: Wall Mounting Connector.

## Dimensions in Inches

SHELL SIZE	Xf MIN.	Xp MIN.	K± .010	YMAX.	Yf MAX.	M+.031 -.000	A±.003	G±.020	SMAX.	V V THREAD CLASS 2A
8	.234	.317	.094	.608	.828	.400	.471	.938	.828	7/16-28 UNEF
10	.297	.434	.094	.734	.891	.400	.588	1.062	.954	9/16-24 UNEF
12	.422	.548	.094	.858	1.016	.400	.748	1.156	1.047	11/16-24 UNEF
14	.547	.673	.094	.984	1.141	.400	.873	1.250	1.141	13/16-20 UNEF
16	.609	.798	.094	1.110	1.203	.400	.998	1.344	1.234	15/16-20 UNEF
18	.734	.899	.094	1.234	1.469	.400	1.123	1.438	1.328	1 1/16-18 UNEF
20	.734	1.024	.115	1.360	1.469	.535	1.248	1.562	1.453	1 3/16-18 UNEF
22	.922	1.149	.115	1.484	1.656	.535	1.373	1.688	1.578	1 5/16-18 UNEF
24	.984	1.274	.115	1.610	1.750	.568	1.498	1.812	1.70	1 7/16-18 UNEF

## Dimensions in Millimeters

SHELL SIZE	Xf MIN.	Xp MIN.	K± .254	YMAX.	Yf MAX.	M+.787 -.000	A± .076	G± .508	SMAX.	V V THREAD CLASS 2A
8	5.94	8.05	2.39	15.44	21.03	10.16	11.99	21.03	3.05	7/16-28 UNEF
10	7.54	11.02	2.39	18.64	22.63	10.16	14.94	24.23	3.05	9/16-24 UNEF
12	10.72	13.92	2.39	21.79	25.81	10.16	19.00	26.59	3.05	11/16-24 UNEF
14	13.89	17.09	2.39	24.99	28.98	10.16	22.17	28.98	3.05	13/16-20 UNEF
16	15.47	20.27	2.39	28.19	30.56	10.16	25.35	31.34	3.05	15/16-20 UNEF
18	18.64	22.83	2.39	31.34	37.31	10.16	28.52	33.73	3.05	1 1/16-18 UNEF
20	18.64	26.01	2.92	34.54	37.31	13.59	31.70	36.91	3.05	1 3/16-18 UNEF
22	23.42	29.18	2.92	37.82	42.06	13.59	34.27	40.08	3.05	1 5/16-18 UNEF
24	24.99	32.26	2.92	40.89	44.45	14.43	38.05	43.26	3.73	1 7/16-18 UNEF

# Series PWF02/MS3122 Box Mount Receptacle

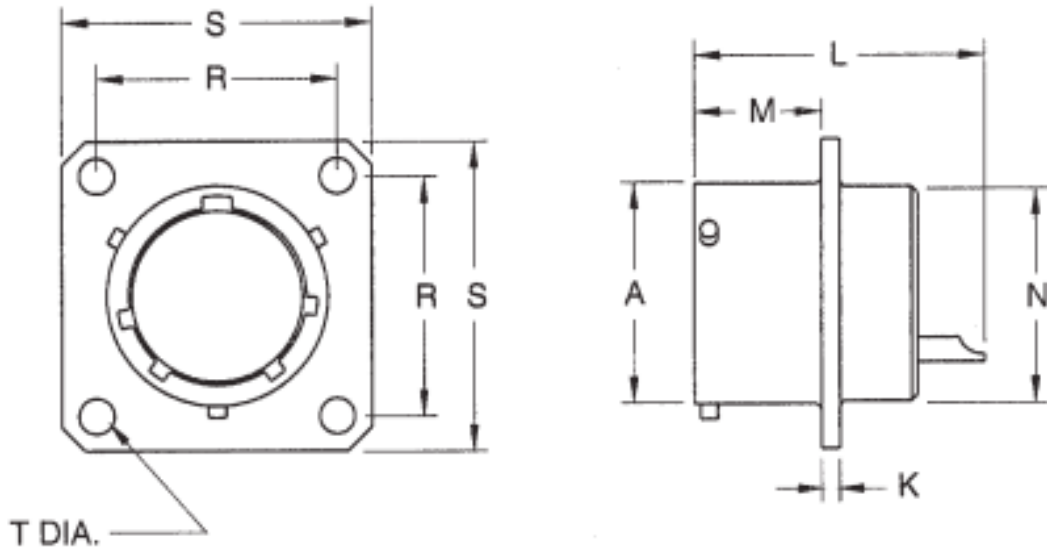

Application: Box Mount Receptacle.

## Dimensions in Inches

SHELL SIZE	A±.003	K± .010	L MAX.	M+.031 -.000	N± .015	R(Tp)	SMAX.	T± .005
8	.471	.062	1.320	.431	.438	.594	.828	.120
10	.588	.062	1.320	.431	.558	.719	.954	.120
12	.748	.062	1.320	.431	.688	.812	1.047	.120
14	.873	.062	1.320	.431	.812	.906	1.141	.120
16	.998	.062	1.320	.431	.938	.969	1.234	.120
18	1.123	.062	1.320	.431	1.062	1.062	1.328	.120
20	1.248	.094	1.367	.556	1.188	1.156	1.453	.120
22	1.373	.094	1.367	.556	1.312	1.250	1.578	.120
24	1.498	.094	1.418	.589	1.438	1.375	1.703	.147

## Dimensions in Millimeters

SHELL SIZE	A± .076	K± .254	L MAX.	M+.787 -.000	N± .381	R(Tp)	SMAX.	T± .127
8	12.01	1.57	33.53	10.95	11.13	15.09	21.03	3.05
10	14.99	1.57	33.53	10.95	14.27	18.26	24.23	3.05
12	19.05	1.57	33.53	10.95	17.48	20.62	26.59	3.05
14	22.23	1.57	33.53	10.95	20.62	23.01	28.98	3.05
16	25.40	1.57	33.53	10.95	23.83	24.61	31.34	3.05
18	28.58	1.57	33.53	10.95	26.97	26.97	33.73	3.05
20	31.75	2.39	34.72	14.12	30.18	29.36	36.91	3.05
22	34.93	2.39	34.72	14.12	33.32	31.75	40.08	3.05
24	38.10	2.39	36.02	14.96	36.53	34.93	43.26	3.73



# Series PWF07/MS3124 Jam Nut Receptacle

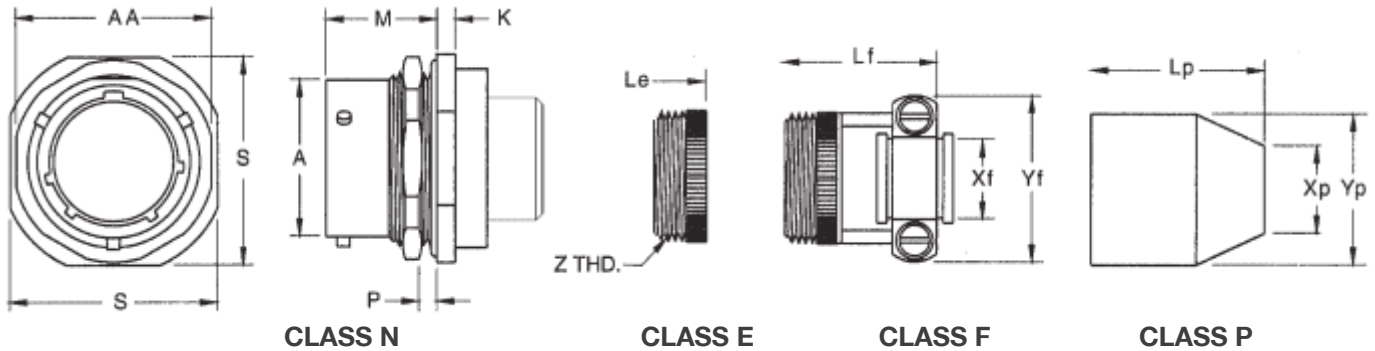

Application: Jam Nut Mounting with O-ring to D-shaped Chassis Hole. (See panel cutout dimensions on page 6.)

Note: L\* = Total connector length including cable accessory.

## Dimensions in Inches

SHELL SIZE	Xf MIN.	P MIN. MAX.	Xp MIN.	K±.020	Yf MAX.	Yp MAX.	Le MAX.	Lf MAX.	Lp MAX.	A±.003	AA MAX.	S MAX.	Z THREAD	
8	.234	.062 .125	.317	.117	.828	.608	1.547	2.422	1.675	.691	.471	.767	.954	5/8-24 UNEF
10	.297	.062 .125	.434	.117	.891	.734	1.547	2.422	1.675	.691	.588	.892	1.078	3/4-20 UNEF
12	.422	.062 .125	.548	.117	1.016	.858	1.547	2.422	1.675	.691	.748	1.079	1.266	7/8-20 UNEF
14	.547	.062 .125	.673	.117	1.141	.984	1.547	2.422	1.675	.691	.873	1.205	1.391	1-20 UNEF
16	.609	.062 .125	.798	.117	1.203	1.110	1.547	2.537	1.675	.691	.998	1.329	1.516	1 1/8-18 UNEF
18	.734	.062 .125	.899	.117	1.469	1.234	1.547	2.537	1.675	.691	1.123	1.455	1.641	1 1/4-18 UNEF
20	.734	.062 .250	1.024	.148	1.469	1.360	1.709	2.824	1.963	.879	1.248	1.579	1.828	1 3/8-18 UNEF
22	.922	.062 .250	1.149	.148	1.656	1.484	1.709	2.824	1.963	.879	1.373	1.705	1.954	1 1/2-18 UNEF
24	.984	.062 .250	1.274	.148	1.750	1.610	1.709	2.900	2.025	.912	1.498	1.829	2.078	1 5/8-18 UNEF

## Dimensions in Millimeters

SHELL SIZE	Xf MIN.	P MIN. MAX.	Xp MIN.	K±.508	Yf MAX.	Yp MAX.	Le MAX.	Lf MAX.	Lp MAX.	AA MAX.	S MAX.	Z THREAD		
8	5.94	1.57 3.18	8.05	2.97	21.03	15.44	39.29	61.52	42.55	17.90	11.99	19.48	24.23	5/8-24 UNEF
10	7.54	1.57 3.18	11.02	2.97	22.63	18.64	39.29	61.52	42.55	17.90	14.94	22.66	27.38	3/4-20 UNEF
12	10.72	1.57 3.18	13.92	2.97	25.81	21.79	39.29	61.52	42.55	17.90	19.00	27.41	32.16	7/8-20 UNEF
14	13.89	1.57 3.18	17.09	2.97	29.98	24.99	39.29	61.52	42.55	17.90	22.17	30.61	35.33	1-20 UNEF
16	15.47	1.57 3.18	20.27	2.97	30.56	28.19	39.29	64.44	42.55	17.90	25.35	33.76	38.51	1 1/8-18 UNEF
18	18.64	1.57 3.18	22.83	2.97	37.31	31.34	39.29	64.44	42.55	17.90	28.52	36.96	41.68	1 1/4-18 UNEF
20	18.64	1.57 6.35	26.01	3.76	37.31	34.54	43.41	71.73	49.86	22.68	31.70	40.11	46.43	1 3/8-18 UNEF
22	23.42	1.57 6.35	29.18	3.76	42.06	39.69	43.41	71.73	49.86	22.68	34.87	43.31	49.63	1 1/2-18 UNEF
24	24.99	1.57 6.35	32.36	3.76	44.45	40.89	43.41	73.66	51.44	23.52	38.05	46.46	52.78	1 5/8-18 UNEF

# Series PWF06/MS3126 Straight Plug

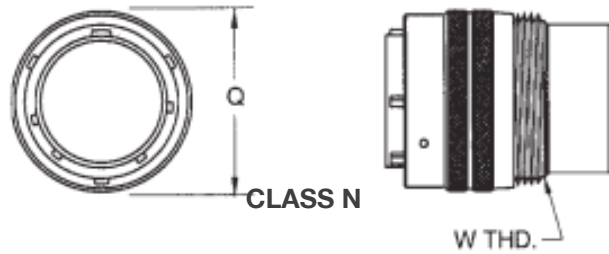

Application: Straight Plug Connector, General Cable Coupling.

Note: L\* = Total connector length including cable accessory.

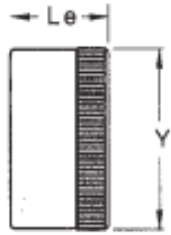

CLASS E

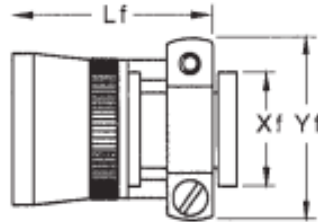

CLASS F

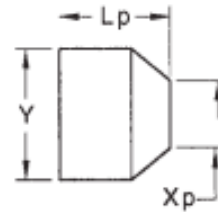

CLASS P

## Dimensions in Inches

SHELL SIZE	Xf MIN.	Xp MIN.	YMAX.	Yf MAX.	Le MAX.	Lf MAX.	Lp MAX.	QMAX.	V V THREAD
8	.234	.317	.608	.828	1.513	2.413	1.750	.782	7/16-28 UNEF
10	.297	.434	.734	.891	1.513	2.413	1.750	.926	9/16-24 UNEF
12	.422	.548	.858	1.016	1.513	2.413	1.750	1.043	11/16-24 UNEF
14	.547	.673	.984	1.141	1.513	2.413	1.750	1.183	13/16-20 UNEF
16	.609	.798	1.110	1.203	1.513	2.528	1.750	1.305	15/16-20 UNEF
18	.734	.899	1.234	1.469	1.513	2.528	1.750	1.391	1 1/16-18 UNEF
20	.734	1.024	1.360	1.469	1.638	2.753	1.892	1.531	1 3/16-18 UNEF
22	.922	1.149	1.484	1.656	1.638	2.753	1.892	1.656	1 5/16-18 UNEF
24	.984	1.274	1.610	1.750	1.638	2.830	1.892	1.777	1 7/16-18 UNEF

## Dimensions in Millimeters

SHELL SIZE	Xf MIN.	Xp MIN.	YMAX.	Yf MAX.	Le MAX.	Lf MAX.	Lp MAX.	QMAX.	V V THREAD
8	5.94	8.05	15.44	21.03	38.43	61.29	44.45	19.86	7/16-28 UNEF
10	7.54	11.02	18.64	22.63	38.43	61.29	44.45	23.52	9/16-24 UNEF
12	10.72	13.92	21.79	25.81	38.43	61.29	44.45	26.49	11/16-24 UNEF
14	13.89	17.09	24.99	28.98	38.43	61.29	44.45	30.05	13/16-20 UNEF
16	15.47	20.27	28.19	30.56	38.43	64.21	44.45	33.15	15/16-20 UNEF
18	18.64	22.83	31.34	37.31	38.43	64.21	44.45	35.33	1 1/16-18 UNEF
20	18.64	26.01	34.54	37.31	41.61	69.93	48.06	38.89	1 3/16-18 UNEF
22	23.42	29.18	37.82	42.06	41.61	69.93	48.06	42.06	1 5/16-18 UNEF
24	24.99	32.26	40.89	44.45	41.61	71.88	49.61	45.14	1 7/16-18 UNEF

# PW80/MS3180 and PW81/MS3181 Protective Caps

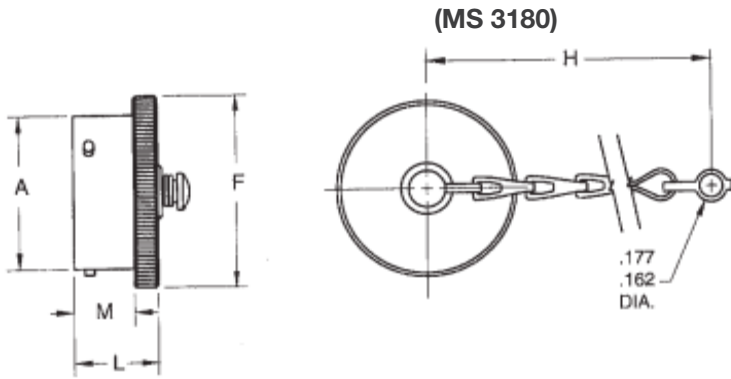

Part No. PW80-\*\* or MS3180-\*\*\*="Dash Number"

## Dimensions in Inches

SHELL SIZE	DASH NO.		A +.001 -.005	F MAX.	H ±.25	L MAX.	M ±.010
	WITHOUT CHAIN	WITH CHAIN					
8	G1	G11	.473	.719	3.00	.562	.378
10	G2	G12	.590	.844	3.00	.562	.378
12	G3	G13	.750	1.000	3.50	.562	.378
14	G4	G14	.875	1.125	3.50	.562	.378
16	G5	G15	1.000	1.250	3.50	.562	.378
18	G6	G16	1.125	1.375	3.50	.562	.378
20	G7	G17	1.250	1.500	4.00	.625	.440
22	G8	G18	1.375	1.625	4.00	.625	.440
24	G9	G19	1.500	1.750	4.00	.658	.473

## Dimensions in Millimeters

SHELL SIZE	DASH NO.		A +.03 -.13	F MAX.	H ±6.35	L MAX.	M ±.25
	WITHOUT CHAIN	WITH CHAIN					
8	G1	G11	12.01	18.28	76.20	14.27	9.60
10	G2	G12	14.98	21.41	76.20	14.27	9.60
12	G3	G13	19.05	25.40	88.90	14.27	9.60
14	G4	G14	22.21	28.58	88.90	14.27	9.60
16	G5	G15	25.40	31.75	88.90	14.27	9.60
18	G6	G16	28.58	34.93	88.90	14.27	9.60
20	G7	G17	31.75	38.10	101.60	15.87	11.17
22	G8	G18	34.93	41.28	101.60	15.87	11.17
24	G9	G19	38.10	44.45	101.60	16.71	12.01

(MS 3181)

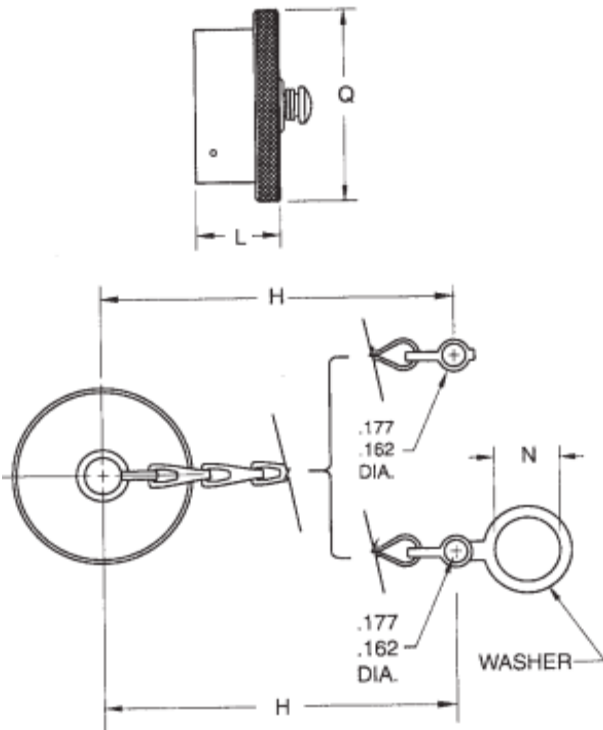

Part No. PW81-\*\* or MS3181-\*\*\*="Dash Number"

## Dimensions in Inches

SHELL SIZE	DASH NO.			H	L MAX.	N MIN.	Q MAX.
	WITH CHAIN	WITH CHAIN &					
8	G1	G11	G21	3.00	.562	.578	.719
10	G2	G12	G22	3.00	.562	.703	.812
12	G3	G13	G23	3.50	.562	.891	1.000
14	G4	G14	G24	3.50	.562	1.016	1.125
16	G5	G15	G25	3.50	.562	1.141	1.250
18	G6	G16	G26	3.50	.562	1.266	1.375
20	G7	G17	G27	4.00	.562	1.391	1.500
22	G8	G18	G28	4.00	.562	1.516	1.625
24	G9	G19	G29	4.00	.602	1.641	1.750

## Dimensions in Millimeters

SHELL SIZE	DASH NO.			H	L MAX.	N MIN.	Q MAX.
	WITH CHAIN	WITH CHAIN &					
8	G1	G11	G21	76.20	14.27	14.68	18.26
10	G2	G12	G22	76.20	14.27	17.86	20.64
12	G3	G13	G23	88.90	14.27	22.63	25.40
14	G4	G14	G24	88.90	14.27	25.80	28.58
16	G5	G15	G25	88.90	14.27	28.98	31.75
18	G6	G16	G26	88.90	14.27	32.15	34.93
20	G7	G17	G27	101.60	14.27	35.33	38.10
22	G8	G18	G28	101.60	14.27	38.50	41.28
24	G9	G19	G29	101.60	15.29	41.68	44.45

+1 305.234.1000  
cinch.com

# Contact Data

## Contact ratings

Contact size	20	16
Rated current	7.5 A	13 A
Test current	7.5 A	13 A
Voltage drop	55 mV	50 mV

## Ratings (sea level)

Class	I	II
Service	600 VAC eff. 850 VDC	1000 VAC eff. 1450 VDC
Test	1500 VAC eff.	2300 VAC eff.

## Material

Contact	Copper alloy - Gold plate over nickel
---------	---------------------------------------

MS 312\_ and PWF\_ connectors are normally supplied with size 20 contacts with wire well support.  
All crimp contacts can be crimped, inserted and removed with commercially available appropriate tooling.

## Contacts for MS 312\_ and PWF Series

### Contact size

Socket 20 with wire well support	857-0668-XXX
Socket 20	857-0670-XXX
Socket 16	857-0672-XXX
Pin 20 with wire well support	806-0673-XXX
Pin 20	806-0687-XXX
Pin16	806-0688-XXX

### Crimp contacts

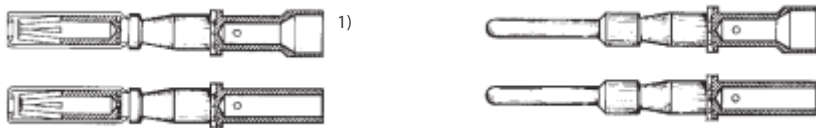

1) Socket and pin with wire well support (size 20 only)

Contact size		Cinch P/N	MS P/N	Handcrimping tool	Insertion Tool	Removal Tool
20 w/support cup	P	806-0673-XXX	M39029/31-240	M22520/2-01 + M22520/1-01 +	MS24256A20	MS24256R20
20 w/support cup	S	857-0668-XXX	M39029/32-259	M22520/1-02 M22520/2-02	MS24256A20	MS24256R20
16	P	806-0688-XXX	M39029/31-228	↓	MS24256A16	MS24256R16
16	S	857-0672-XXX	M39029/32-247		MS24256A16	MS24256R16
20 w/o support cup	P	806-0687-XXX	M39029/31-223	M22520/2-01 +	MS24256A20	MS24256R20
20 w/o support cup	S	857-0670-XXX	M39029/32-242	M22520/2-02	MS24256A20	MS24256R20



# Crimping Instructions

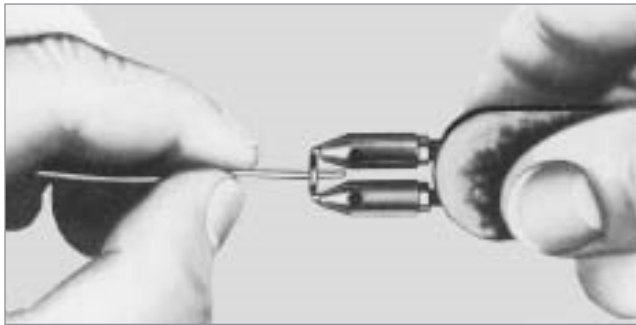

Cut wire to length and strip 1/4 inch of insulation from end for use with size 16 contacts. Strip 3/16 inch from end for use with size 20 contacts. Hot wire stripping is recommended. Avoid nicking individual strands if other methods are used.

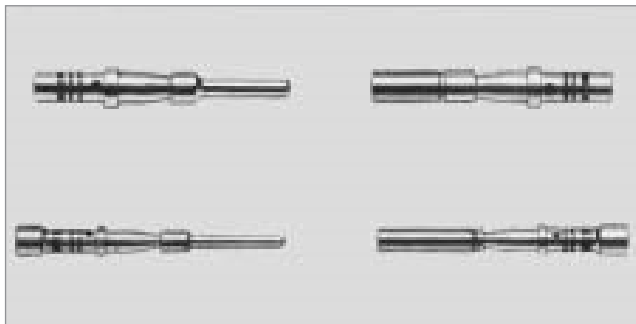

Insert and bottom wire in contact. Insulation must extend into insulation wire well support. Check to make certain strands are visible in the inspection hole provided.



Insert wired contact into crimping tool, previously arranged; see table on page 13.

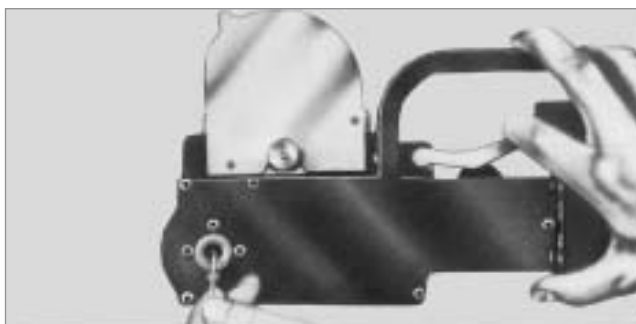

A pneumatic crimping tool provided with magazine for large capacity production is available on specialized market.

# Crimping Instructions

The automatic or hand crimping tool assures a crimp joint which will meet MIL-T-22520. Both tools, if properly maintained by a periodic inspection, will provide a complete and uniform crimp over many thousands of cycles.

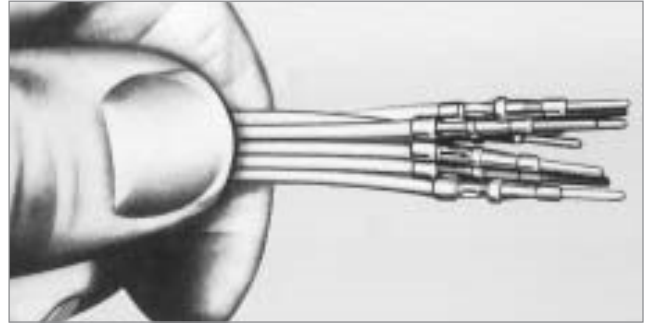

Insert the contact into the correct contact hole. Contact insertion tools are listed on the table on page 13.



Insert the contact into the correct contact hole of the integral grommet at the rear of the assembly. Push contact forward in a line parallel to the assembly until the contact bottoms. A slight pressure may be noticed just before contact reaches its fully seated position. Sealing plugs must be used in all unused circuits by placing the correct size plug behind each uncrimped contact. Use MS27488-20 sealing plug for size 20 and MS27488-16 for size 16.



Remove the contact by inserting tools listed on the table on page 13. Fully bottom the tools tip by slightly rotating the tool. Push the thrust assist knob forward. The contact is now disengaged and may be removed at the rear of the assembly.



# Other Quality Connectors



QPL'd MIL-C-5015 & Special Connectors for Commercial Applications

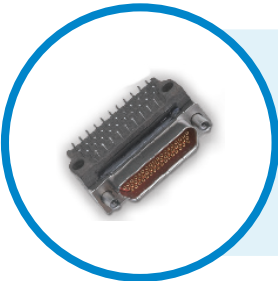

Dura-Con Microminiature-D Connectors



QPL'd MIL-C-26482 Series I Solder and Crimp Connectors

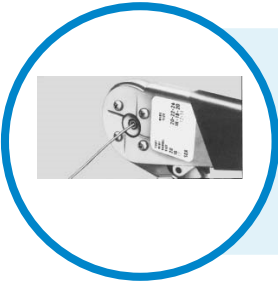

Quick Disconnect Connectors Solder and Crimp Types



Buffet/Galley Connectors Solder and Crimp Connectors



Expanded Beam Fiber Optics



Filtered Connectors Solder and Crimp Connectors

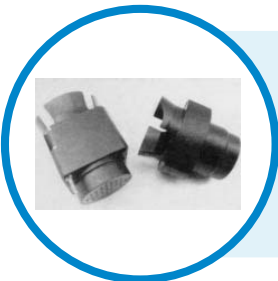

Special Cryogenic Connectors



Omega MIL-C-26500 - Cylindrical Connectors



Rugged Acme Thread Connectors for Industrial Electrical Equipment







## Proven Excellence

In operation since 1917, Cinch supplies high quality, high performance connectors and cables globally to the Aerospace, Military/Defense, Commercial Transportation, Oil & Gas, High End Computer, and other markets. We provide custom solutions with our creative, hands on engineering and end to end approach.

Our diverse product offerings include: connectors, enclosures and cable assemblies utilizing multiple contact technologies including copper and fiber optics. Our product engineering and development activities employ cutting edge technologies for design and modeling, and our various technologies and expertise enable us to deliver custom solutions and products for our strategic partnerships. We also serve a broad range of commercial markets, largely through our highly efficient distribution network.

We aim to exceed our customer's expectations, and to continually provide innovative solutions to the rapidly changing needs of the markets, and customers, we serve.

### Cinch Connectivity Solutions

Cinch Connectivity Solutions  
12400-8 S.W. 134th Court  
Miami, Florida 33186 USA  
+1 305.234 1000  
inquiry@cinch.com  
[cinch.com](http://cinch.com)





## X-ON Electronics

Largest Supplier of Electrical and Electronic Components

*Click to view similar products for [Circular MIL Spec Connector](#) category:*

*Click to view products by [Bel Fuse](#) manufacturer:*

Other Similar products are found below :

[0025-262-542](#) [0025-264-3014](#) [58-570121-04S](#) [0134-202-1200](#) [0134-207-1206](#) [0134-207-1800](#) [0134-207-2207](#) [0134-213-0806](#) [0134-213-1007](#) [0134-213-1009](#) [0134-213-1208](#) [0134-213-1800](#) [0134-213-2209](#) [0025-258-000](#) [015-9516-002](#) [60-042217-10P](#) [60-042722-19P](#) [0114-201-1278](#) [602GB06EG24-61SN](#) [0134-201-1207](#) [0134-201-1806](#) [0134-201-2006](#) [0134-201-2007](#) [0134-201-2010](#) [0134-202-1400](#) [0134-207-0809](#) [0134-207-1208](#) [0134-207-2009](#) [0134-213-1006](#) [6104-207-2302](#) [6104-208-1902](#) [6131-202-19149P](#) [6131-204-21149P](#) [6131-207-13149P](#) [6131-208-13149P](#) [6131-209-17149P](#) [6131-210-11149P](#) [6131-211-19149P](#) [6131-216-19149P](#) [6131-220-25149P](#) [6131-259-11149P](#) [6131-259-21149P](#) [6131-259-23149P](#) [6131-263-19149P](#) [6131-265-17149P](#) [6131-265-19149P](#) [CS3102A-20-15P](#) [CS3102A-20-15S](#) [CS3102A-28-15S](#) [CS3106A-10SL-53S](#)