



UIQ48T48050

DC-DC Converter

18-75 VDC Input, 5 VDC, 48 A, 240 W Output

The high performance 48A UIQ48T48050 DC-DC converter provides a high efficiency single output, in a 1/4 brick package. Specifically designed for operation in systems that have limited airflow and increased ambient temperatures, the UIQ48T48050 converter utilizes the same pinout and Input/Output functionality of the industry-standard Quarter bricks. In addition, a baseplate / heat spreader feature is available (-xDxBx suffix) that provides an effective thermal interface for coldplate and heat sinking options.

The UIQ48T48050 converter thermal performance is accomplished through the use advanced circuits, packaging, and processing techniques to achieve ultra-high efficiency, excellent thermal management, and a low-body profile.

Operating from a wide-range 18-75V input, the UIQ48T48050 converter utilizes digital control and provides a fully regulated 5.0V output voltage. The designer can expect reliability improvement over other available converters because of the UIQ48T48050's optimized thermal efficiency.

Key Features & Benefits

- Industry-standard quarter-brick pin-out
- Ultra wide input voltage range
- Delivers 240W at 92% efficiency
- Paste In Hole (PIH) compatible
- Withstands 100V input transient for 100ms
- Fixed-frequency operation
- On-board input differential LC-filter
- Start-up into pre-biased load
- No minimum load required
- Minimum of 2250 VDC I/O isolation
- Fully protected (OTP, OCP, OVP, UVLO)
- Positive or negative logic ON/OFF option
- Low height of 0.44" (11.18mm)
- Weight: 48g without baseplate / heat spreader, 62g with baseplate / heat spreader
- High reliability: MTBF = 14.3 million hours, calculated per Telcordia SR-332, Method I Case 1
- Approved to the latest edition of the following standards: UL/CSA60950-1, IEC60950-1 and EN60950-1.
- Designed to meet Class B conducted emissions per FCC and EN55022 when used with external filter
- All materials meet UL94, V-0 flammability rating

Applications

- Intermediate Bus Architectures
- Data communications/processing
- LAN/WAN
- Servers, storage, instrumentation, embedded equipment

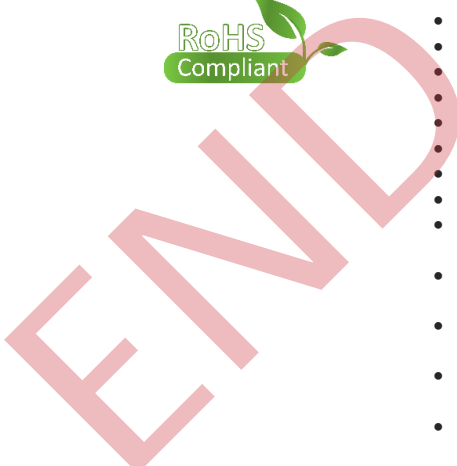

bel POWER SOLUTIONS & PROTECTION

a bel group

belpowersolutions.com

1. ELECTRICAL SPECIFICATIONS

Conditions: $T_A = 25\text{ }^\circ\text{C}$, Airflow = 300 LFM (1.5 m/s), $V_{in} = 48\text{ VDC}$, $C_{in} = 100\text{ }\mu\text{F}$, unless otherwise specified.

PARAMETER	NOTES	MIN	TYP	MAX	UNITS
ABSOLUTE MAXIMUM RATINGS					
Input Voltage	Continuous	-0.3		80	VDC
	Transient (100ms)			100	VDC
Operating Temperature (See Derating Curves)	Ambient (T_A)	-40		85	$^\circ\text{C}$
	Component (T_C) ¹	-40		125	$^\circ\text{C}$
Storage Temperature		-55		125	$^\circ\text{C}$
ISOLATION CHARACTERISTICS					
Isolation Voltage	Input to Output	2250			VDC
	Input to Baseplate	1500			VDC
	Output to Baseplate	1500			VDC
Isolation Resistance		10			M Ω
Isolation Capacitance			750		pF
FEATURE CHARACTERISTICS					
Switching Frequency			250		kHz
Output Overvoltage Protection	Non-latching	115	120	130	%
Over Temperature Shutdown	Non-latching Component (T_C) ¹		130		$^\circ\text{C}$
Auto-Restart Period	Applies to all protection features		500		ms
Turn-On Time from V_{in}	Time from UVLO to $V_o = 90\% V_{OUT(NOM)}$, Resistive load		100	130	ms
Turn-On Time from ON/OFF Control	Time from ON to $V_o = 90\% V_{OUT(NOM)}$, Resistive load		100	130	ms
Turn-On Time from V_{in}	Time from UVLO to $V_o = 90\% V_{OUT(NOM)}$		100	130	ms
Turn-On Time from ON/OFF Control (w/ C_o max.)	Resistive load, $C_{EXT} = 10000\text{ }\mu\text{F}$ load		100	130	ms
Turn-On Time from ON/OFF Control (w/ C_o max.)	Time from ON to $V_o = 90\% V_{OUT(NOM)}$ Resistive load, $C_{EXT} = 10000\text{ }\mu\text{F}$ load		100	130	ms
ON/OFF Control (Positive Logic)	Converter Off (logic low)	-15		0.8	VDC
	Converter On (logic high)	2.4		15	VDC
ON/OFF Control (Negative Logic)	Converter Off (logic low)	2.4		15	VDC
	Converter On (logic high)	-15		0.8	VDC
INPUT CHARACTERISTICS					
Operating Input Voltage Range		18	48	75	VDC
Input Undervoltage Lockout					
Turn-on Threshold		16.8	17.2	17.8	VDC
Turn-off Threshold		14.9	15.5	16.1	VDC
Lockout Hysteresis Voltage		0.5	1.7	2.3	VDC
Maximum Input Current	$P_o = 240\text{ W @ }18\text{ VDC In}$				ADC
Input Standby Current	$V_{in} = 48\text{ V}$, converter disabled		3	5	mA
Input No Load Current	$V_{in} = 48\text{ V}$, converter enabled (No load on the output)	40	100	160	mA
Input Reflected-Ripple Current, i_c			2300		mA _{PK-PK}
	$V_{in} = 48\text{ V}$, 20 MHz bandwidth, $P_o = 240\text{ W}$ (Figs. 14,15, 16)		850		mA _{RMS}
Input Reflected-Ripple Current, i_s			26		mA _{PK-PK}
			3		mA _{RMS}
Input Voltage Ripple Rejection	120 Hz		45		dB

¹ Reference Figure G for component T_C locations.

OUTPUT CHARACTERISTICS						
Output Voltage Setpoint	$V_{IN} = 48\text{ V}$, $I_{OUT} = 0\text{ A}$, $T_A = 25^\circ\text{C}$		4.90	5.00	5.10	VDC
Output Voltage Trim Range ²	Industry-std. equations ⁴		-20		+10	%
Remote Sense Compensation ³	Percent of V_{OUT} (NOM) ⁴				+10	%
Output Regulation						
Over Line	$I_{OUT} = 48\text{ A}$, $T_A = 25^\circ\text{C}$			±24	±48	mV
Over Load	$V_{IN} = 48\text{ V}$, $T_A = 25^\circ\text{C}$			±15	±30	mV
Output Voltage Range	Over line, load and temperature		4.85		5.15	VDC
Output Ripple and Noise	20 MHz bandwidth, $I_{OUT} = 48\text{ A}$, $C_{EXT} = 10\text{ }\mu\text{F}$ tantalum + $1\text{ }\mu\text{F}$ ceramic			100	200	mV _{PK-PK}
Admissible External Load Capacitance ²	$I_{OUT} = 48\text{ A}$ (resistive)	C_{EXT}	0		6000	μF
		ESR	1			m Ω
Output Current Range			0		48	ADC
Current Limit Inception	Non-latching		53	60	67	ADC
RMS Short-Circuit Current	Non-latching Short = $10\text{ m}\Omega$			6	10	A _{RMS}
DYNAMIC RESPONSE						
Load Change	50%-75%-50% of I_{OUT} Max ($di/dt = 0.1\text{ A}/\mu\text{s}$) $C_{EXT} = 10\mu\text{F}$ tantalum + $1\mu\text{F}$ ceramic + $470\mu\text{F}$ E-cap				250	mV
Settling Time	to 1% of V_{OUT}			200		μs
EFFICIENCY						
	@ 100% Load	$48V_{IN}$, $T_A = 25^\circ\text{C}$, 300LFM		92		%
	@ 60% Load			92.5		

2. ENVIRONMENT AND MECHANICAL SPECIFICATIONS

PARAMETER	NOTES	MIN	TYP	MAX	UNITS
ENVIRONMENTAL					
Operating Humidity	Non-condensing			95	%
Storage Humidity	Non-condensing			95	%
MECHANICAL					
Weight	Without baseplate / heat spreader		48		g
	With baseplate / heat spreader		62		g
Vibration	GR-63-CORE, Sect. 5.4.2	1			g
Shocks	Half Sinewave, 3-axis	50			g
RELIABILITY					
MTBF	Telcordia SR-332, Method I Case 1 50% electrical stress, 40°C components		14.3		MHrs
EMI AND REGULATORY COMPLIANCE					
Conducted Emissions	CISPR 22 B with external EMI filter network				

² For input voltage >22 V

³ See "Input Output Impedance", Page 4

3. OPERATIONS

3.1. INPUT AND OUTPUT IMPEDANCE

These power converters have been designed to be stable with no external capacitors when used in low inductance input and output circuits.

However, in some applications, the inductance associated with the distribution from the power source to the input of the converter can affect the stability of the converter. A 100 μF electrolytic capacitor with adequate ESR based on input impedance is recommended to ensure stability of the converter.

In many end applications, a high capacitance value is applied to the converter's output via distributed capacitors. The power converter will exhibit stable operation with external load capacitance up to 6,000 μF .

3.2. ON/OFF (PIN 2)

The ON/OFF pin is used to turn the power converter on or off remotely via a system signal. There are two remote control options available, positive and negative logic, with both referenced to $V_{in} (-)$. A typical connection is shown in Figure A. The positive logic version turns on when the ON/OFF pin is at a logic high or left open and turns off when it is at a logic low. See the Electrical Specifications for logic high/low definitions.

Fig. A: Typ. Circuit configuration for ON/OFF function.

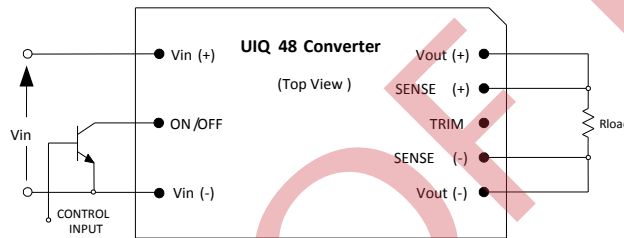

The negative logic version turns on when the ON/OFF pin is at a logic low and turns off when the pin is at logic high. To enable automatic power up of the converter without the need of an external control signal the ON/OFF pin can be hard wired directly to $V_{in} (-)$ for N and left open for P version.

A properly de-bounced mechanical switch, open-collector transistor, or FET can be used to drive the input of the ON/OFF pin. The device must be capable of sinking up to 0.2 mA at a low level voltage of ≤ 0.8 V. An external voltage source (± 15 V maximum) may be connected directly to the ON/OFF input, in which case it must be capable of sourcing or sinking up to 1 mA depending on the signal polarity. If optocoupler is used to control the on/off, then the ON/OFF pin should be tied to a 3V3 rail via 3.3k Ω resistor to prevent optocoupler leakage from affecting the on/off function. See the Startup Information section for system timing waveforms associated with use of the ON/OFF pin.

3.3. SENSE (PINS 5 AND 7)

The remote sense feature of the converter compensates for voltage drops occurring between the output pins of the converter and the load. The SENSE (-) (Pin 5) and SENSE (+) (Pin 7) pins should be connected at the load or at the point where regulation is required (see Fig. B).

Fig. B: Remote sense circuit configuration.

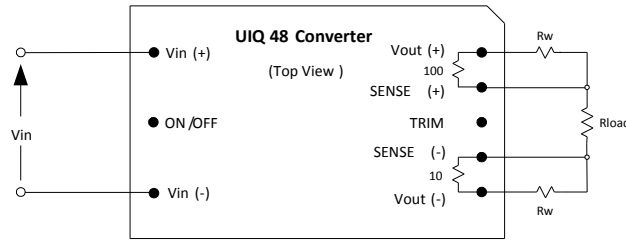

CAUTION

If remote sensing is not utilized, the SENSE (-) pin must be connected to the Vout (-) pin (Pin 4), and the SENSE (+) pin must be connected to the Vout (+) pin (Pin 8) to ensure the converter will regulate at the specified output voltage. If these connections are not made, the converter will deliver an output voltage that is higher than the specified data sheet value.

Because the sense leads carry minimal current, large traces on the end-user board are not required. However, sense traces should be run side by side and located close to a ground plane to minimize system noise and ensure optimum performance. The converter’s output overvoltage protection (OVP) senses the voltage across Vout (+) and Vout (-), and not across the sense lines, so the resistance (and resulting voltage drop) between the output pins of the converter and the load should be minimized to prevent unwanted triggering of the OVP.

When utilizing the remote sense feature, care must be taken not to exceed the maximum allowable output power capability of the converter, which is equal to the product of the nominal output voltage and the allowable output current for the given conditions.

When using remote sense, the output voltage at the converter can be increased by as much as 10% above the nominal rating in order to maintain the required voltage across the load. Therefore, the designer must, if necessary, decrease the maximum current (originally obtained from the derating curves) by the same percentage to ensure the converter’s actual output power remains at or below the maximum allowable output power.

3.4. OUTPUT VOLTAGE ADJUST /TRIM (PIN 6)

The output voltage can be adjusted up 10% or down 20%, relative to the rated output voltage by the addition of an externally connected resistor.

The TRIM pin should be left open if trimming is not being used. To minimize noise pickup, a 0.1 μF capacitor is connected internally between the TRIM and SENSE (-) pins.

To increase the output voltage, refer to Fig. C. A trim resistor, R_{T-INCR} , should be connected between the TRIM (Pin 6) and SENSE (+) (Pin 7), with a value of:

$$R_{T-INCR} = \frac{5.11(100 + \Delta)V_{O-NOM} - 626}{1.225\Delta} - 10.22 \text{ [k}\Omega\text{]}$$

where,

R_{T-INCR} = Required value of trim-up resistor kΩ

V_{O-NOM} = Nominal value of output voltage [V]

$$\Delta = \left| \frac{(V_{O-REQ} - V_{O-NOM})}{V_{O-NOM}} \right| \times 100 \text{ [%]}$$

V_{O-REQ} = Desired (trimmed) output voltage [V].

When trimming up, care must be taken not to exceed the converter’s maximum allowable output power. See the previous section for a complete discussion of this requirement.

Fig. C: Configuration for increasing output voltage.

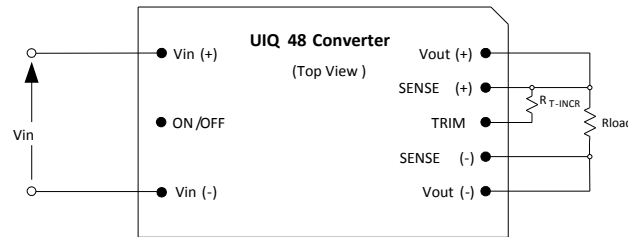

To decrease the output voltage (Fig. D), a trim resistor, R_{T-DECR} , should be connected between the TRIM (Pin 6) and SENSE(-) (Pin 5), with a value of:

$$R_{T-DECR} = \frac{511}{|\Delta|} - 10.22 \quad [\text{k}\Omega]$$

where,

R_{T-DECR} = Required value of trim-down resistor [kΩ] and Δ is defined above.

NOTE: The above equations for calculation of trim resistor values match those typically used in conventional industry-standard quarter-bricks.

Fig. D: Configuration for decreasing output voltage.

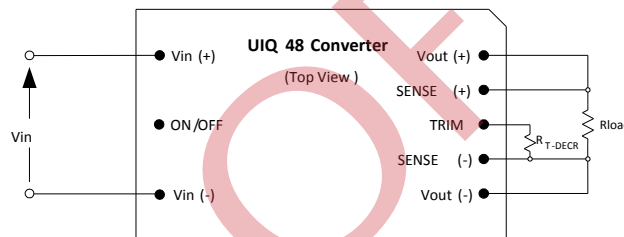

Trimming/sensing beyond 110% of the rated output voltage is not an acceptable design practice, as this condition could cause unwanted triggering of the output overvoltage protection (OVP) circuit. The designer should ensure that the difference between the voltages across the converter's output pins and its sense pins does not exceed 10% of $V_{OUT(NOM)}$, or:

$$[V_{OUT(+)} - V_{OUT(-)}] - [V_{SENSE(+)} - V_{SENSE(-)}] \leq V_{O-NOM} \times 10\% [V]$$

This equation is applicable for any condition of output sensing and/or output trim.

4. PROTECTION FEATURES

4.1. INPUT UNDERVOLTAGE LOCKOUT (UVLO)

Input undervoltage lockout is standard with this converter. The converter will shut down when the input voltage drops below a pre-determined voltage.

The input voltage must be typically 17.2V for the converter to turn on. Once the converter has been turned on, it will shut off when the input voltage drops typically below 15.5V. This feature is beneficial in preventing deep discharging of batteries used in telecom applications.

4.2. OUTPUT OVERCURRENT PROTECTION (OCP)

The converter is protected against overcurrent or short circuit conditions. Upon sensing an overcurrent condition, the converter will shut down after entering the constant current mode of operation, regardless of the value of the output voltage.

Once the converter has shut down, it will enter hiccup mode with attempt to restart every 500 ms until the overload or short circuit conditions are removed.

4.3. OUTPUT OVERVOLTAGE PROTECTION (OVP)

The converter will shut down if the output voltage across Vout(+) and Vout(-) exceeds the threshold of the OVP circuitry. Once the converter has shut down, it will attempt to restart every 500 ms until the OVP condition is removed.

4.4. OVERTEMPERATURE PROTECTION (OTP)

The converter will shut down under an overtemperature condition to protect itself from overheating caused by operation outside the thermal derating curves, or operation in abnormal conditions. The converter will automatically restart after it has cooled to a safe operating temperature.

4.5. SAFETY REQUIREMENTS

The converters are safety approved to UL/CSA60950-1 2nd Ed, EN60950-1 2nd Ed, and IEC60950-1 2nd Ed. Basic Insulation is provided between input and output.

The converters have no internal fuse. To comply with safety agencies requirements, an input line fuse must be used external to the converter. The fuse must not be placed in the grounded input line.

The UIQ48 converter is UL approved for a fuse rating of 20 Amps.

4.6. ELECTROMAGNETIC COMPATIBILITY (EMC)

EMC requirements must be met at the end-product system level, as no specific standards dedicated to EMC characteristics of board mounted component dc-dc converters exist. However, Bel Power Solutions tests its converters to several system level standards, primary of which is the more stringent EN55022, Information technology equipment - Radio disturbance characteristics - Limits and methods of measurement.

An effective internal LC differential filter significantly reduces input reflected ripple current, and improves EMC.

With the addition of an external filter, the UIQ48T48050 converter will pass the requirements of Class B conducted emissions per EN55022 and FCC requirements. Refer to Figures 18 – 20 for typical performance with external filter.

4.7. STARTUP INFORMATION (USING NEGATIVE ON/OFF)

Scenario #1: Initial Startup From Bulk Supply

ON/OFF function enabled, converter started via application of V_{IN} . See Figure E.

Time	Comments
t_0	ON/OFF pin is ON; system front-end power is toggled on, V_{IN} to converter begins to rise.
t_1	V_{IN} crosses undervoltage Lockout protection circuit threshold; converter enabled.
t_2	Converter begins to respond to turn-on command (converter turn-on delay).
t_3	Converter V_{OUT} reaches 100% of nominal value.

For this example, the total converter startup time ($t_3 - t_1$) is typically 100 ms.

Fig. E: Startup scenario #1.

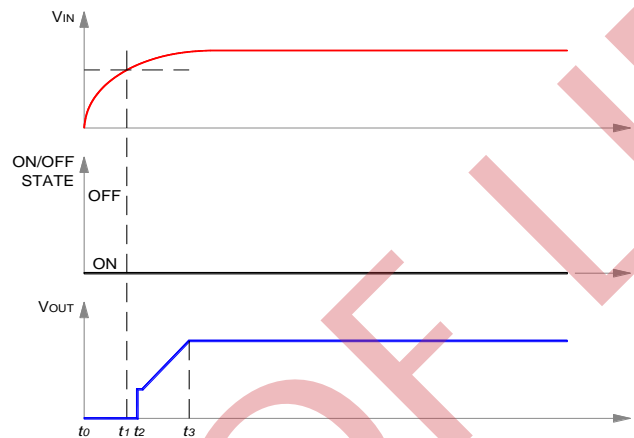

Scenario #2: Initial Startup Using ON/OFF Pin

With V_{IN} previously powered, converter started via ON/OFF pin. See Figure F.

Time	Comments
t_0	V_{IN} at nominal value.
t_1	Arbitrary time when ON/OFF pin is enabled (converter enabled).
t_2	End of converter turn-on delay.
t_3	Converter V_{OUT} reaches 100% of nominal value.

For this example, the total converter startup time ($t_3 - t_1$) is typically 100 ms.

Fig. F: Startup scenario #2.

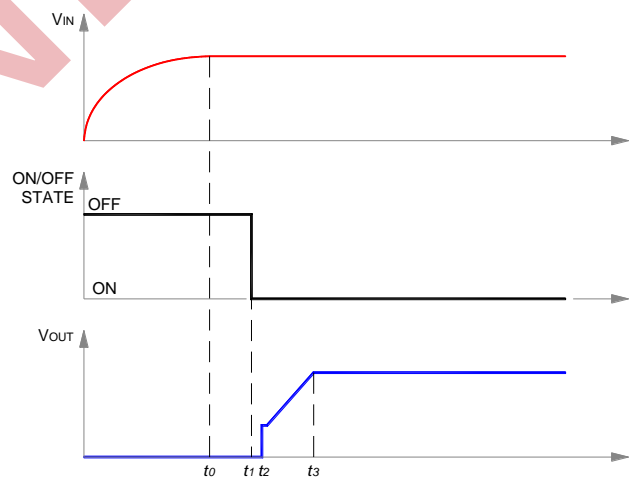

5. CHARACTERIZATION

5.1. GENERAL INFORMATION

The converter has been characterized for many operational aspects, to include thermal derating (maximum load current as a function of ambient temperature and airflow), efficiency, startup and shutdown parameters, output ripple and noise, transient response to load step-change, overcurrent, and short circuit.

The following pages contain specific plots or waveforms associated with the converter. Additional comments for specific data are provided below.

5.2. TEST CONDITIONS

All data presented were taken with the converter soldered to a test board, specifically a 0.060" thick printed wiring board (PWB) with four layers. The top and bottom layers were not metalized. The two inner layers, comprised of two-ounce copper, were used to provide traces for connectivity to the converter.

The lack of metallization on the outer layers as well as the limited thermal connection ensured that heat transfer from the converter to the PWB was minimized. This provides a worst-case but consistent scenario for thermal derating purposes.

All measurements requiring airflow were made in the vertical and horizontal wind tunnel using Infrared (IR) thermography and thermocouples for thermometry.

Ensuring components on the converter do not exceed their ratings is important to maintaining high reliability. If one anticipates operating the converter at or close to the maximum loads specified in the derating curves, it is prudent to check actual operating temperatures in the application. Thermographic imaging is preferable; if this capability is not available, then thermocouples may be used. The use of AWG #40 gauge thermocouples is recommended to ensure measurement accuracy. Careful routing of the thermocouple leads will further minimize measurement error. Refer to Figure H for the optimum measuring thermocouple location.

5.3. THERMAL DERATING – AIR COOLED

Load current vs. ambient temperature and airflow rates are given in Figures 1 for converter w/o baseplate / heat spreader, and in Figures 5 for converter with baseplate / heat spreader equipped with a .45" finned heat sink. Ambient temperature was varied between 25°C and 85°C, with airflow rates from 30 to 500LFM (0.15 to 2.5m/s) and with $V_{IN}=48V$.

Load current vs. ambient temperature and airflow rates are given in Figure 3 for a converter w/o baseplate / heat spreader. Ambient temperature was varied between 25°C and 85°C, with airflow rates from 30 to 500LFM (0.15 to 2.5m/s) and with $V_{IN}=24V$.

Note that the use of baseplate / heat spreader alone without heatsink or attachment to cold plate provides lower power rating than open frame due to the restriction of airflow across the module.

For each set of conditions, the maximum load current was defined as the lowest of:

- (i) The output current at which any FET junction temperature does not exceed a maximum temperature of 125°C as indicated by the thermal measurement, the user should design for $T_B \leq 105^\circ C$.
- (ii) The output current at which the temperature at the thermocouple locations T_{C1} and T_{C2} do not exceed 125°C (Figure G).
- (iii) The nominal rating of the converter (48A/240W).

Fig. G: Locations of the thermocouples for thermal testing.

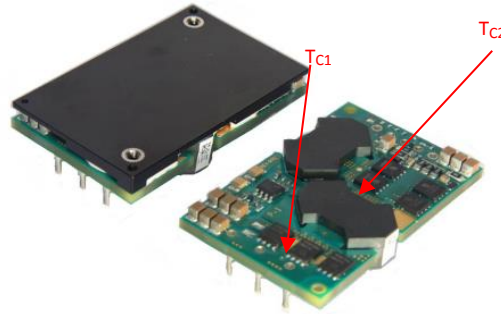

5.4. EFFICIENCY

Figure 7 shows the efficiency vs. load current plot for ambient temperature (T_A) of 25°C and for converter w/o baseplate / heat spreader, air flowing from pin 3 to pin 1 at a rate of 300LFM (1.5m/s) with vertically mounting and input voltages of 18V, 24V, 36V, 48V, 60V and 75V.

5.5. POWER DISSIPATION

Figure 8 shows the power dissipation vs. load current plot for ambient temperature (T_A) of 25°C and for converter w/o baseplate / heat spreader, air flowing from pin 3 to pin 1 at a rate of 300 LFM (1.5 m/s) with vertically mounting and input voltages of 18V, 24V, 36V, 48V, 60V and 75V.

5.6. STARTUP

Output voltage waveforms, during the turn-on transient using the ON/OFF pin for full rated load currents (resistive load) are shown with and without external load capacitance in Figure 9 and 10, respectively.

5.7. RIPPLE AND NOISE

Figure 13 shows the output voltage ripple waveform, measured at full rated load current with a 10µF tantalum and a 1µF ceramic capacitor across the output. Note that all output voltage waveforms are measured across the 1µF ceramic capacitor.

The input reflected-ripple current waveforms are obtained using the test setup shown in Figure 14. The corresponding waveforms are shown in Figure 15 and Figure 16.

Fig. 1: Available load current vs. ambient air temperature and airflow rates for UIQ48T48050 converter w/o baseplate mounted vertically with air flowing from pin 3 to pin 1, MOSFET temperature $\leq 125^\circ\text{C}$, $V_{in}=48\text{V}$

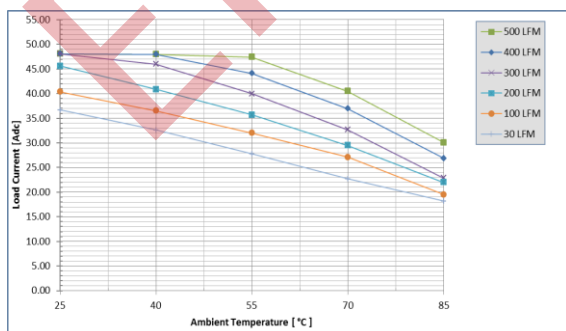

Fig. 2: Power derating vs. ambient air temperature and airflow rates for UIQ48T48050 converter w/o baseplate mounted vertically with air flowing from pin 3 to pin 1, MOSFET temperature $\leq 125^\circ\text{C}$, $V_{in}=48\text{V}$

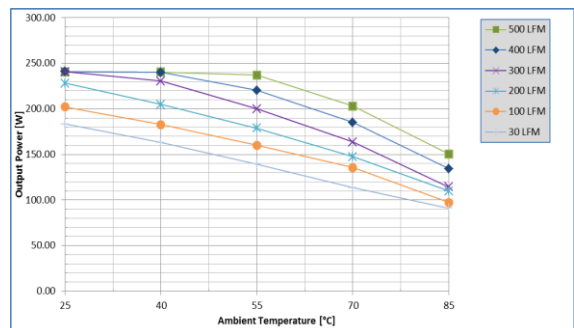

Fig. 3: Available load current vs. ambient air temperature and airflow rates for UIQ48T48050 converter w/o baseplate mounted vertically with air flowing from pin 3 to pin 1, MOSFET temperature $\leq 125^{\circ}\text{C}$, $V_{in}=24\text{V}$

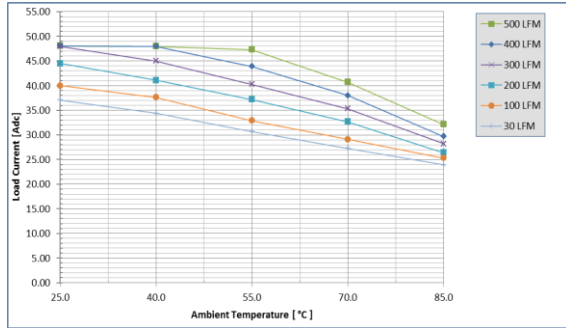

Fig. 4: Power derating vs. ambient air temperature and airflow rates for UIQ48T48050 converter w/o baseplate mounted vertically with air flowing from pin 3 to pin 1, MOSFET temperature $\leq 125^{\circ}\text{C}$, $V_{in}=24\text{V}$

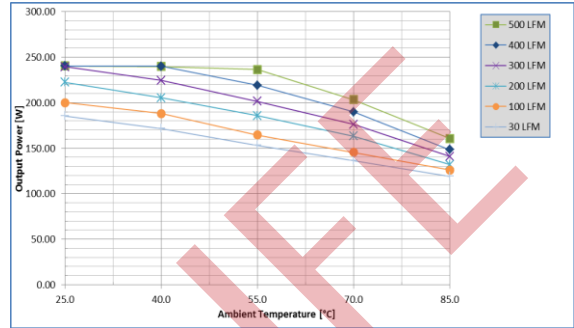

Fig. 5: Available load current vs. ambient air temperature and airflow rates for UIQ48T48050 converter with baseplate equipped with .45" finned heatsink mounted vertically with air flowing from pin 3 to pin 1, MOSFET temperature $\leq 125^{\circ}\text{C}$, $V_{in}=48\text{V}$

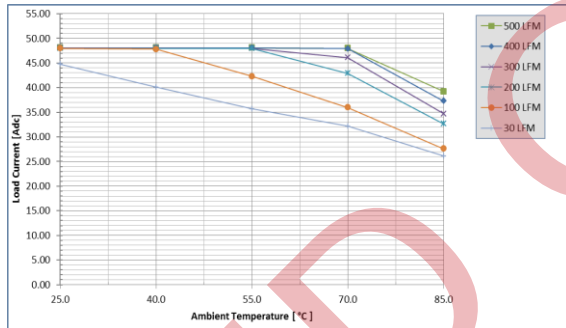

Fig. 6: Power derating vs. ambient air temperature and airflow rates for UIQ48T48050 converter with baseplate equipped with .45" finned heatsink mounted vertically with air flowing from pin 3 to pin 1, MOSFET temperature $\leq 125^{\circ}\text{C}$, $V_{in}=48\text{V}$

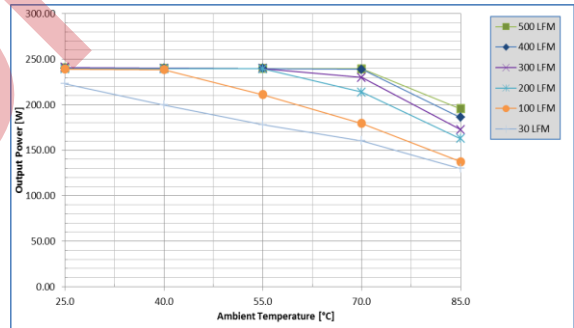

Fig. 7: Efficiency vs. load current and input voltage for UIQ48T48050 converter w/o baseplate mounted vertically with air flowing from pin 3 to pin 1 at a rate of 300 LFM (1.5 m/s) and $T_a = 25^{\circ}\text{C}$.

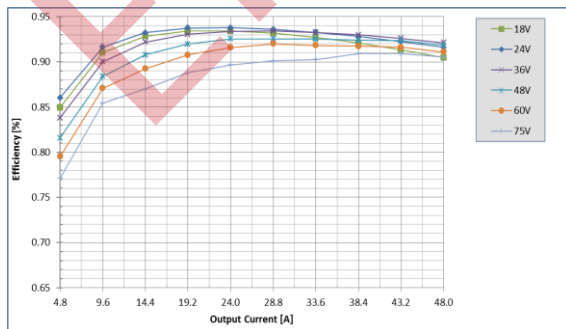

Fig. 8: Power dissipation vs. load current and input voltage for UIQ48T48050 converter w/o baseplate mounted vertically with air flowing from pin 3 to pin 1 at a rate of 300 LFM (1.5 m/s) and $T_a = 25^{\circ}\text{C}$

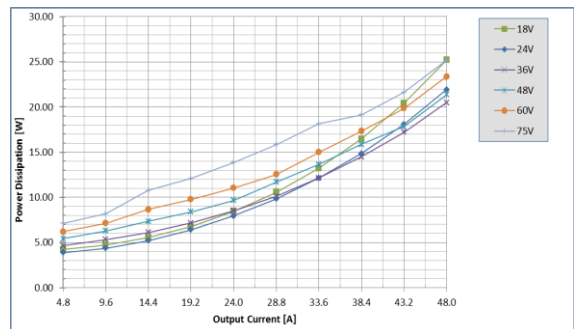

Fig. 9: Turn-on transient at full rated load current (resistive) with C_{out} 10 μ F tantalum + 1 μ F ceramic at V_{in} = 48 V, triggered via ON/OFF pin. Top trace: ON/OFF signal (2 V/div.). Bottom trace: output voltage (2V/div.). Time scale: 50 ms/div.

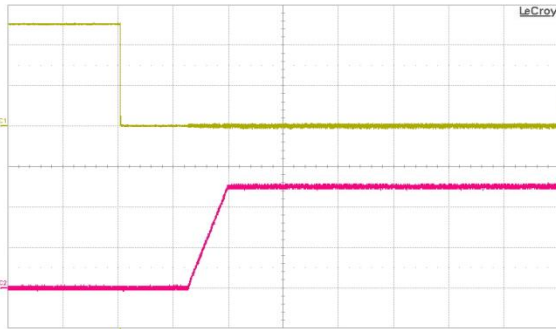

Fig. 10: Turn-on transient at full rated load current (resistive) plus 6000 μ F at V_{in} = 48 V, triggered via ON/OFF pin. Top trace: ON/OFF signal (2V/div.). Bottom trace: output voltage (2V/div.). Time scale: 50 ms/div.

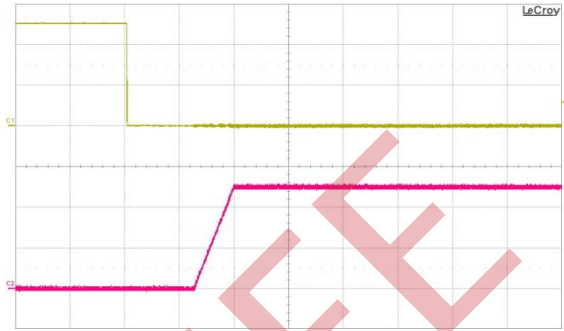

Fig. 11: Output voltage response to load current step change (24A – 36A –24A) at V_{in} = 48 V. Top trace: output voltage(200mV/div.). Bottom trace: load current (20 A/div.). Current slew rate: 0.1 A/ μ s. C_o = 1 μ F ceramic + 10 μ F tantalum. Time scale: 200 μ s/div.

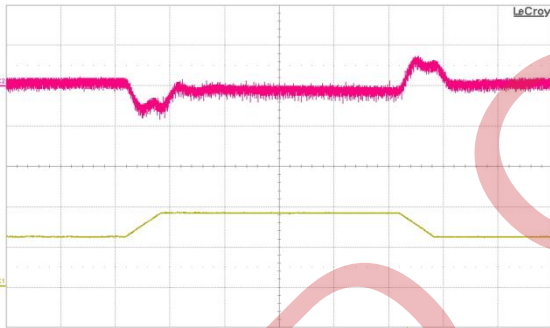

Fig. 12: Output voltage response to load current step change (24 A – 36A –24 A) at V_{in} = 48V. Top trace: output voltage (500mV/div.). Bottom trace: load current (10A/div.). Current slew rate: 1A/ μ s. C_o = 1 μ F ceramic + 6000 μ F + 10 μ F tantalum. Time scale: 200 μ s/div.

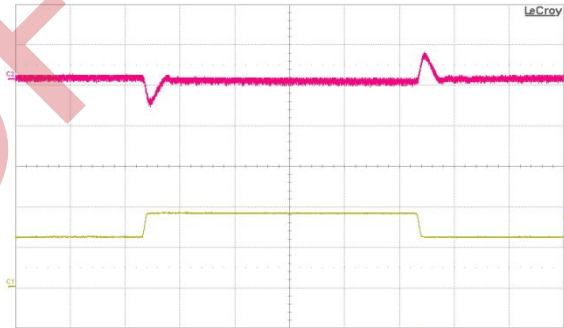

Fig. 13: Output voltage ripple (50 mV/div.) at full rated load current C_o = 10 μ F tantalum + 1 μ F ceramic and V_{in} = 48 V. Time scale: 1 μ s/div.

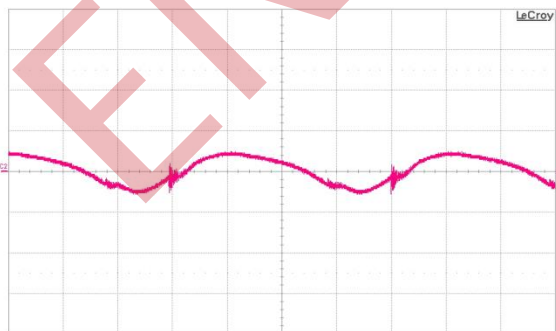

Fig. 14: Test setup for measuring input reflected ripple currents, i_c and i_s .

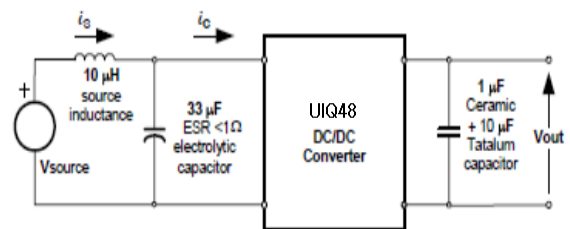

Fig. 15: Input reflected ripple current, i_c (1 A/div.), measured at input terminals at full rated load current and $V_{in} = 48$ V. Refer to Fig. 14 for test setup. Time scale: 1 μ s/div.

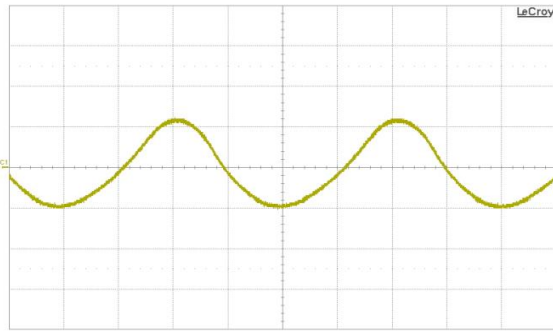

Fig. 16: Input reflected ripple current, i_s (20 mA/div.), measured through 10 μ H at the source at full rated load current and $V_{in} = 48$ V. Refer to Fig. 14 for test setup. Time scale: 1 μ s/div.

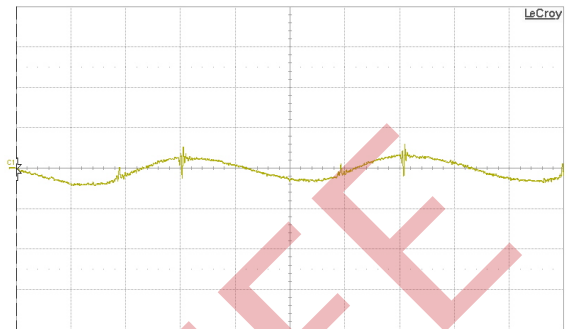

Fig. 17: Load current (top trace, 50 A/div., 100 ms/div.) into a 10m Ω short circuit during restart, at $V_{in} = 48$ V. Bottom trace (50 A/div., 10 ms/div.) is an expansion of the on-time portion of the top trace

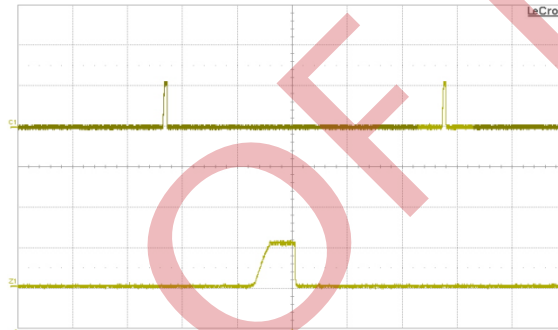
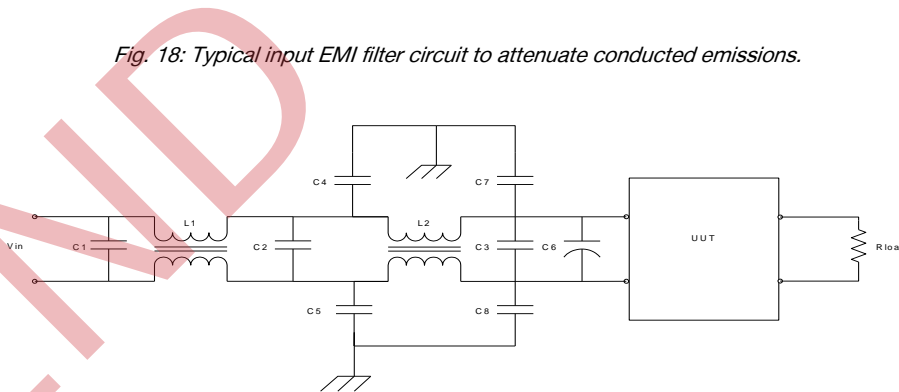

Fig. 18: Typical input EMI filter circuit to attenuate conducted emissions.



COMP. DES.	DESCRIPTION
C1, C2, C3	2 μ F, 100V ceramic cap
C6	100 μ F, 100V electrolytic cap
L1, L2	0.59mH, Pulse P0353NL
C4, C5	4700pF, ceramic cap
C7, C8	4700pF, ceramic cap

Fig. 19: Vin+ Peak Detector EMI waveform

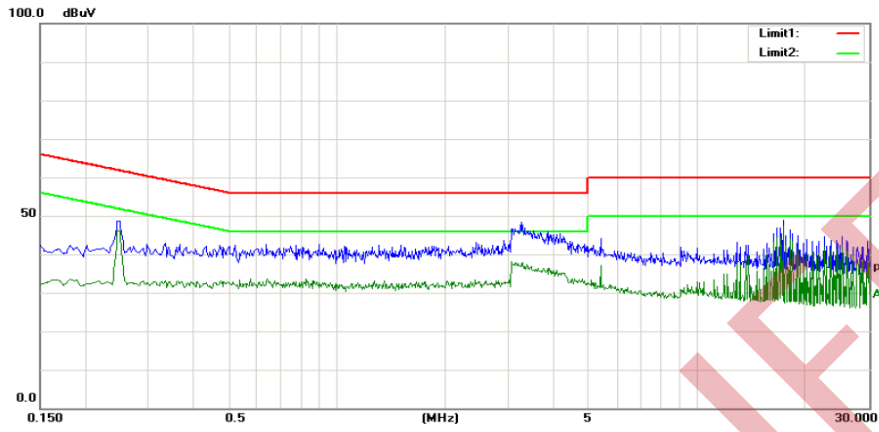
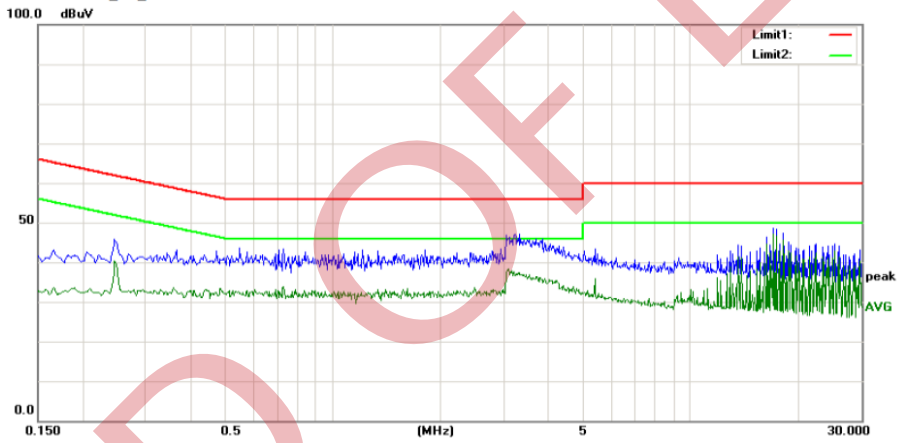
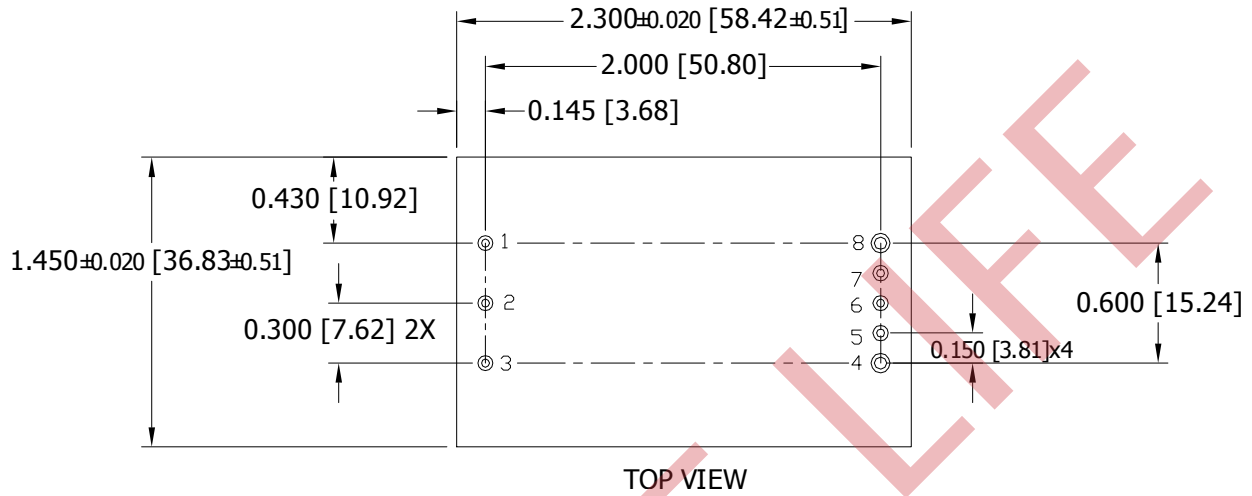

Fig. 20: Vin- Peak Detector EMI waveform



6. PHYSICAL INFORMATION

6.1. UIQ48T PINOUT (THROUGH-HOLE)



PAD/PIN CONNECTIONS	
PAD/PIN #	FUNCTION
1	V _{IN} (+)
2	ON/OFF
3	V _{IN} (-)
4	V _{OUT} (-)
5	V _{OUT} (-) Sense
6	Trim
7	V _{OUT} (+) Sense
8	V _{OUT} (+)

UIQ48T Platform Notes

- All dimensions are in inches [mm]
- Pins 1,2,3,5,6,7 are Ø 0.040" [1.02] with Ø 0.076" [1.93] shoulder
- Pins 4 and 8 are Ø 0.062" [1.57] with are Ø 0.096" [2.44] shoulder
- Pin Material: Brass Alloy 360
- Pin Finish: Tin over Nickel

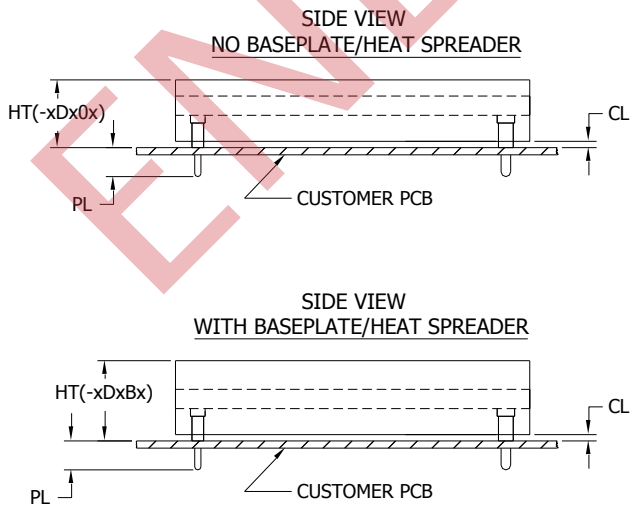

	HEIGHT [HT]	MIN CLEARANCE [CL]	SPECIAL FEATURES
	0.440" [11.18] Max	0.028" [0.71]	0
D	0.500" +/-0.020 [12.70 +/-0.51]	0.028" [0.71]	B

PIN OPTION	PIN LENGTH [PL]
	±0.005" [±0.13]
A	0.188" [4.78]
B	0.145" [3.68]

6.2. BASEPLATE / HEAT SPREADER INTERFACE INFORMATION

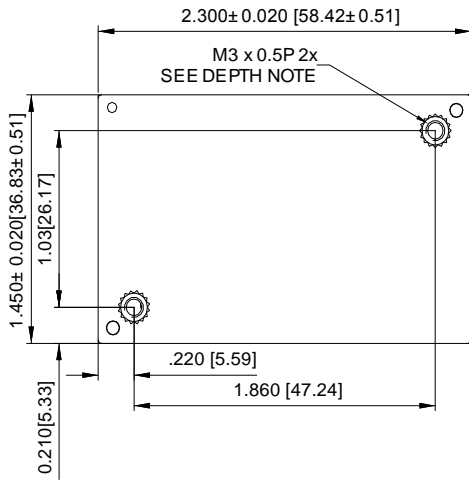

DEPTH NOTE:
SCREW LENGTH MUST BE SELECTED TO
LIMIT HEAT SPREADER PENETRANTION TO 0.08[2.0] MAX.

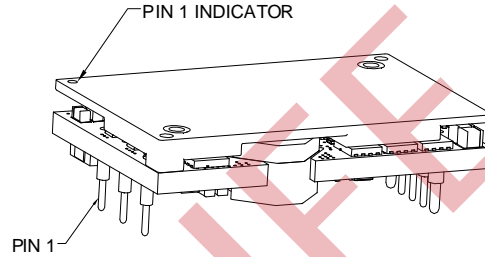

6.3. CONVERTER PART NUMBERING/ORDERING INFORMATION

PRODUCT SERIES	INPUT VOLTAGE	MOUNTING SCHEME	RATED CURRENT	OUTPUT VOLTAGE	ON/OFF LOGIC	MAXIMUM HEIGHT [HT]	PIN LENGTH [PL]	SPECIAL FEATURES	RoHS
UIQ	48	T	48	050	- N	D	A	B	G
Quarter Brick Format	18-75 V	T ⇒ Through-hole	48 ⇒ 48 ADC	050 ⇒ 5.0 V	N ⇒ Negative P ⇒ Positive	D ⇒ 0.440" for -xDx0x 0.520" for -xDxBx	Through hole A ⇒ 0.188" B ⇒ 0.145"	0 ⇒ Standard B ⇒ Baseplate option	G ⇒ RoHS compliant for all six substances

The example above describes P/N UIQ48T48050-NDABG: 18-75V input, through-hole, 48A@5V output, negative ON/OFF logic, maximum height of 0.52", 0.188" pin length with baseplate / heat spreader option, RoHS compliant for all 6 substances. Consult factory for availability of other options.

7. SOLDERING INFORMATION

7.1. THROUGH HOLE SOLDERING

Below table lists the temperature and duration for wave soldering

WAVE SOLDER PROCESS SPECIFICATION	PB-FREE	SN/PB EUTECTIC
Maximum Preheat Temperature	130°C	110°C
Maximum Pot Temperature	265°C	255°C
Maximum Solder Dwell Time	7 Sec	6 Sec

7.2. LEAD FREE REFLOW SOLDERING

The unit is Paste In Hole (PIH) compatible. The profile below is provided as a guideline for Pb-free reflow only. There are many other factors which will affect the result of reflow soldering. Please check with your process engineer thoroughly.

Fig. 21: Lead Free solder reflow profile

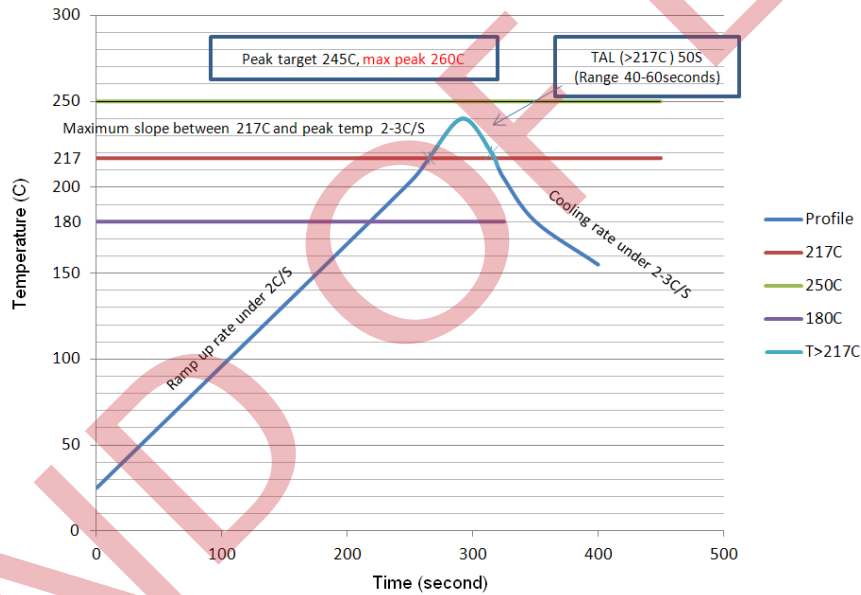

For PIH reflow process, the unit has a MSL rating of 1.

For more information on these products consult: tech.support@psbel.com

NUCLEAR AND MEDICAL APPLICATIONS - Products are not designed or intended for use as critical components in life support systems, equipment used in hazardous environments, or nuclear control systems.

TECHNICAL REVISIONS - The appearance of products, including safety agency certifications pictured on labels, may change depending on the date manufactured. Specifications are subject to change without notice.

X-ON Electronics

Largest Supplier of Electrical and Electronic Components

Click to view similar products for [Isolated DC/DC Converters](#) category:

Click to view products by [Bel Fuse](#) manufacturer:

Other Similar products are found below :

[ESM6D044440C05AAQ](#) [FMD15.24G](#) [PSL486-7LR](#) [Q48T30020-NBB0](#) [JAHW100Y1](#) [SPB05C-12](#) [SQ24S15033-PS0S](#) [18952](#) [19-130041](#)
[CE-1003](#) [CE-1004](#) [GQ2541-7R](#) [RDS180245](#) [MAU228](#) [J80-0041NL](#) [DFC15U48D15](#) [XGS-0512](#) [XGS-1205](#) [XGS-1212](#) [XGS-2412](#) [XGS-2415](#) [XKS-1215](#) [06322](#) [NCT1000N040R050B](#) [SPB05B-15](#) [SPB05C-15](#) [L-DA20](#) [DCG40-5G](#) [QME48T40033-PGB0](#) [XKS-2415](#) [XKS-2412](#)
[XKS-1212](#) [XKS-1205](#) [XKS-0515](#) [XKS-0505](#) [XGS-2405](#) [XGS-1215](#) [XGS-0515](#) [PS9Z-6RM4](#) [73-551-5038I](#) [AK1601-9RT](#) [VI-N61-CM](#) [VI-R5022-EXWW](#) [PSC128-7iR](#) [RPS8-350ATX-XE](#) [DAS1004812](#) [PQA30-D24-S24-DH](#) [VI-M5F-CQ](#) [VI-LN2-EW](#) [VI-PJW01-CZY](#)