



**MELCHER™**  
The Power Partners.

# RCM60 Series

## 60 W DC-DC Converters



The RCM Series converters are Melcher branded power supplies for railway and transportation applications.

The input voltage ranges cover all common battery voltages from 12 to 110 V. The output delivers 60 W at 12, 15 or 24 V. The converters are designed for chassis mounting in an enclosed housing.

Options available include - output ORing FET for redundant operation, input fuse and output voltage monitoring (solid state relay contact).

### FEATURES

- Ultra-wide input voltage range
- Single output voltage
- Overtemperature, overvoltage, overcurrent and short-circuit protection
- 20 ms interruption time (EN50155 Class S3)
- Low inrush current
- Primary shutdown input
- Conformal coated PCB
- Extremely high efficiency and high power density
- Extremely wide ambient temperature range -40 to 70°C
- Dimensions 50 x 32 x 172 mm (1.97 x 1.26 x 6.77 in)
- Compliant to EN50155, EN50121-3-2, EN61373 and AREMA
- Fire & Smoke inspected according EN45545-2 and NFPA 130
- RoHS Compliant
- 5 year warranty
- Safety approved to the latest edition of IEC 62368-1 and CSA/UL 62368-1
- 12RCM60 Series is E-mark approved to the UN Regulation R10 (Report No. E13\*10R06/01\*15947\*00)



10R - 06 15947

### Table of Contents

Description.....	1
Model Selection .....	2
Functional Description .....	3
Electrical Input Data .....	4
Electrical Output Data.....	6
Description of Options .....	9

Electromagnetic Compatibility (EMC).....	10
Immunity to Environmental Conditions .....	13
Mechanical Data .....	14
Safety and Installation Instructions.....	15
Accessories .....	17



[belfuse.com/power-solutions](http://belfuse.com/power-solutions)

BCD.00989\_C

13 March 2023

### MODEL SELECTION

Table 1: Standard models

Input voltage					Output		Power	Efficiency <sup>2</sup>		Model	Options
$V_{I\ min}^1$ [V]	$V_{I\ min}$ [V]	$V_{I\ cont}$ [V]	$V_{I\ max}$ [V]	$V_{I\ max}^1$ [V]	$V_{o\ nom}$ [V]	$I_{o\ nom}$ [A]	$P_{o\ nom}$ [W]	$\eta_{min}$ [%]	$\eta_{typ}$ [%]		
7.2	8		36	40	12	5.0	60	87	88	12RCM60-12	D, Q, F, K
					15	4.0	60	87	88	12RCM60-15	
					24	2.5	60	87	88	12RCM60-24	
14.4	16.8		137.5	154	12	5.0	60	87	88	XRCM60-12	
					15	4.0	60	87	88	XRCM60-15	
					24	2.5	60	87	88	XRCM60-24	

<sup>1</sup> Short time; see table 2 for details  
<sup>2</sup> Efficiency at  $T_A = 25\ ^\circ\text{C}$ ,  $V_{I\ nom}$ ,  $I_{o\ nom}$

### Part Number Description

Operating input voltage  $V_{I\ cont}$  (continuously):

- 8 – 36 VDC ..... 12
- 16.8 – 137.5 VDC ..... X

Series ..... RCM

Output power:

- 60 W ..... 60

Nominal output voltage:

- 12 V ..... -12
- 15 V ..... -15
- 24 V ..... -24

Auxiliary functions and options:

- Output Voltage Monitor ..... D
- ORing FET ..... Q
- Built-in Fuse ..... F
- Pluggable Connectors ..... K

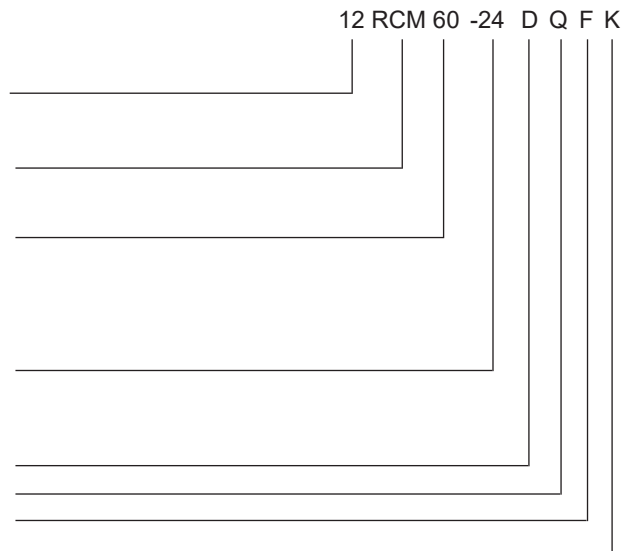

Available combinations of options:  
 RCM60-xx (K)  
 RCM60-xxD (K)  
 RCM60-xxDF (K)  
 RCM60-xxDQ (K)  
 RCM60-xxDQF (K)

Note: The sequence of options must follow the order above.  
 Note: All models are RoHS-compliant for all six substances.

Example: XRCM60-24DQFK: DC-DC converter, input voltage range 16.8 to 137.5 V continuously, output providing 24 V / 2.5 A, monitoring relay, shutdown input, interruption time 20 ms, integrated ORing FET, pluggable connectors, operating ambient temperature  $T_A = -40$  to  $70\ ^\circ\text{C}$ , RoHS-compliant for all six substances.

### Product Marking

Type designation, applicable safety approval and recognition marks, CE mark, pin allocation, and product logo. Input voltage range and input current, nominal output voltage and current, degree of protection, batch no., serial no., and data code including production site, version (modification status) and date of production.



Asia-Pacific +86 755 298 85888 EMEA +353 61 49 8941 North America +1 866 513 2839

tech.support@psbel.com  
 belfuse.com/power-solutions

© 2023 Bel Fuse Inc. BCD.00989\_C 13 March 2023

### FUNCTIONAL DESCRIPTION

The converters are designed with two stage topology having a booster at input followed by an active clamp forward converter with a switching frequency of approximately 140 kHz. The built-in high-efficient input filter together with an inrush limiter circuit ensures very low inrush current of short duration. An antiparallel diode acts as reverse polarity protection together with the external circuit breaker or fuse.

The circuitry providing the 20 ms ride through time is located after the input filter and booster stage.

The rectification on the secondary side is provided by rectifier diodes. The output voltage control logic is located on the secondary side and influences the primary logic and PWM control circuit.

An output ORing FET is available (option Q) for use in a redundant power system architecture. If there are no external circuit breakers, it is possible to order the converter with incorporated fuse (option F). Because this fuse is not accessible, a serial FET provides reverse polarity protection (only with option F).

Option D encompasses an output voltage monitor by a solid state relay.

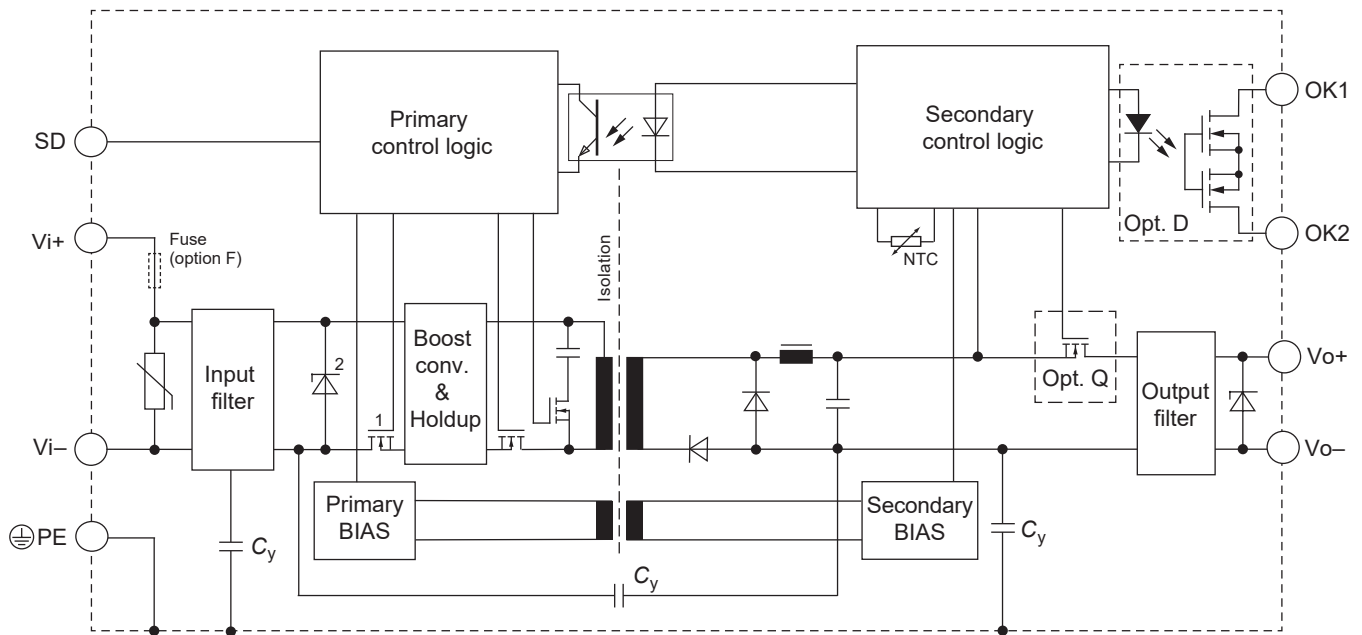

- <sup>1</sup> Serial FET, only fitted with opt. F
- <sup>2</sup> Bipolar suppressor diode with opt. F

Fig. 1  
Block diagram

### ELECTRICAL INPUT DATA

General conditions:

- $T_A = 25\text{ °C}$ , unless  $T_C$  is specified.

Table 2: Input data of RCM60 models

Model	Characteristics	Conditions	12RCM60			XRCM60			Unit
			min	typ	max	min	typ	max	
$V_{i\text{cont}}$	Operating input voltage continuous	$I_o = 0 - I_{o\text{nom}}$ $T_C \text{ min} - T_C \text{ max}$	8		36	16.8		137.5	V
$V_{i2s}$	for $\leq 100\text{ ms}$	without shutdown	7.2		40	14.4		154	
$V_{i\text{nom}}$	Nominal input voltage			12, (24)		(24), (36), (72), (96), 110			
$V_{i\text{abs}}$	Input voltage limits	2 s without damage	0		45	0		160	
$I_i$	Maximum input current	$V_{i\text{min}}, I_{o\text{nom}}$			10.5			5	A
$P_{i0}$	No-load input power	$V_{i\text{min}} - V_{i\text{max}}, I_o = 0$			6			6	W
$P_{i\text{SD}}$	Idle input power	$V_{i\text{min}} - V_{i\text{max}}, V_{\text{SD}} = 0\text{ V}$			1.5			1.5	
$C_i$	Input capacitance <sup>1</sup>			520		40			$\mu\text{F}$
$R_i$	Input resistance				100			100	$\text{m}\Omega$
$I_{\text{inr p}}$	Peak inrush current	$V_i = V_{i\text{max}}, P_{o\text{nom}}$			30			15	A
$t_{\text{inr d}}$	Duration of inrush current				0.5			0.5	
$t_{\text{on}}$	Start-up time	$0 \rightarrow V_{i\text{min}}, P_{o\text{nom}}$		1000		1000			ms
	Start-up time after removal of shutdown	$V_{i\text{min}}, P_{o\text{nom}}$ $V_{\text{SD}} = 0 \rightarrow 5\text{ V}$			500		500		

<sup>1</sup> Not smoothed by the inrush current limiter at start-up (for inrush current calculation)

### Input Transient and Reverse Polarity Protection

A suppressor diode, varistor and a symmetrical input filter form an effective protection against input transients, which typically occur in many installations, but especially in battery-driven mobile applications.

If the input voltage has the wrong polarity, the incorporated antiparallel diode causes the external input circuit breaker or fuse to trip. With option F (incorporated fuse), an active reverse-polarity protection circuit prevents from any damage.

### Input Under-/Overvoltage Lockout

If the input voltage is out of range, an internally generated inhibit signal disables the converter to avoid any damage.

### Inrush Current and Stability with Long Supply Lines

The converter operates with relatively small input capacitance  $C_i$  resulting in low inrush current of short duration.

If a converter is connected to the power source through supply lines with reasonable length (<50 m), no additional measures are necessary to ensure stable operation.

Only in the case of very long supply lines exhibiting a considerable inductance  $L_{\text{ext}}$ , an additional external capacitor  $C_{\text{ext}}$  connected across the input pins improves the stability and prevents oscillations; see fig. 2.

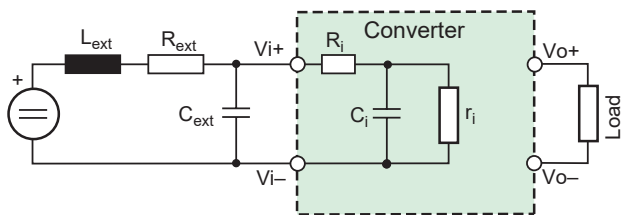

Fig. 2  
Input configuration

### Efficiency

The efficiency depends on the model and on the input voltage.

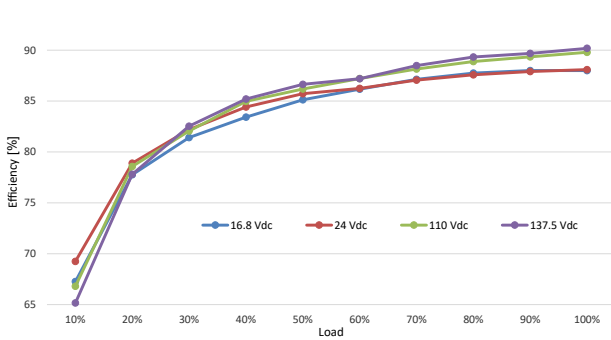

Fig. 3a  
Efficiency versus  $V_i$  and  $P_o$  (XRCM60-24DQF)

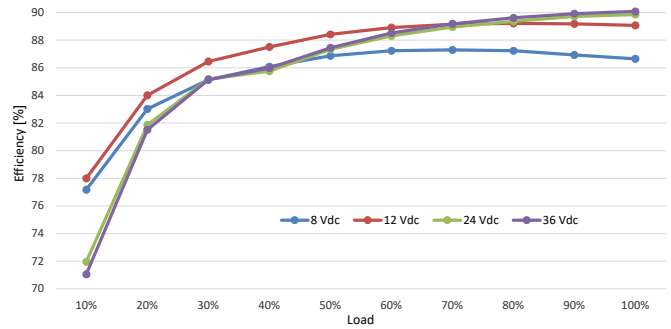

Fig. 3b  
Efficiency versus  $V_i$  and  $P_o$  (12RCM60-24)

### Primary Shutdown (SD)

The output of the converter may be enabled or disabled by a logic signal (e.g. CMOS) applied between the shutdown pin SD and SD0 (= Vi-). If the shutdown function is not required, pin SD can be left open-circuit. Voltage on pin SD:

- Converter operating: 12 to 154 V (XRCM), 8 to 40 V (12RCM) or open-circuit
- Converter disabled: -2 to +2 V

Note: In systems consisting of several converters, this feature may be used to control the activation sequence by logic signals or to enable the power source to start up, before full load is applied.

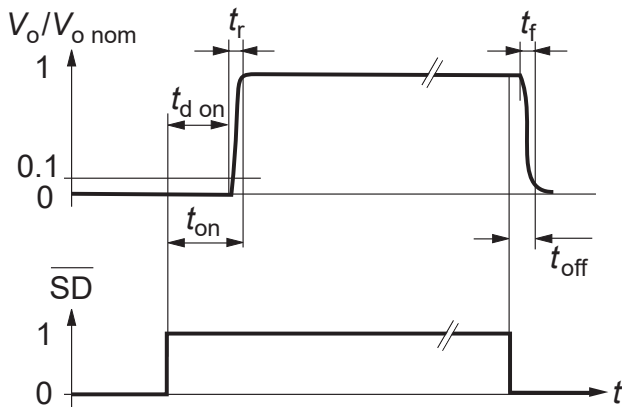

Fig. 4a  
Typical output response to the SD-signal.

### Interruption Time

The interruption time  $t_{hu}$  is specified in the railway standard EN 50155:2017 clause 5.1.1.4: It is tested at the nominal battery voltage for interruption and short-circuit of the input. After such an event, the system is ready for another such event after 10 s.

For XRCM60  $t_{hu} = 20$  ms (Class S3)

For 12RCM60  $t_{hu} = 10$  ms (Class S2) - Valid for 24 V input.

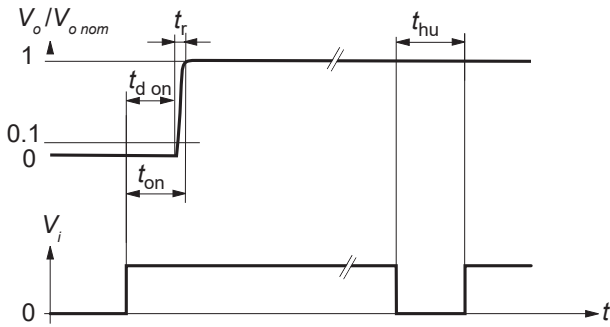

Fig. 4b  
Typical output response to  $V_i$ .

### ELECTRICAL OUTPUT DATA

General conditions:  
-  $T_A = 25\text{ °C}$ , unless  $T_C$  is specified.

Table 3: Output data of RCM60 models.

Output			12 V			15 V			24 V			Unit
Characteristics		Conditions	min	typ	max	min	typ	max	min	typ	max	
$V_o$	Output voltage	$V_{i,nom}, 0.5 I_{o,nom}$	11.88	12	12.12	14.75	15	15.15	23.76	24	24.24	V
$V_{ow}$	Worst case output voltage	$V_{i,min} - V_{i,max}$ $T_{C,min} - T_{C,max}, 0 - I_{o,nom}$	11.64		12.36	14.55		15.45	23.28		24.72	
$V_{o,droop}$	Output voltage droop			-20			-30			-40		mV/A
$V_{oL}$	Overvoltage shutdown <sup>5</sup>			14			17.5			28		V
$V_{oP}$	Overvoltage protection <sup>1</sup>		14.3	15	15.8	17.8	18.8	19.8	28.5	30	31.5	
$I_{o,nom}$	Nominal output current			5			4			2.5		A
$I_{oL}$	Output current limit	$T_{C,min} - T_{C,max}$	5.5		6.5	4.4		5.2	2.75		3.25	
$V_o$	Output noise <sup>2</sup>	Switching frequency		50			50			80		mV <sub>pp</sub>
		Total incl. spikes		60			75			120		
$V_{od}$	Dynamic load regulation	Voltage deviation <sup>4</sup>		700			800			1000		ms
$t_d$ <sup>3</sup>		Recovery time	$V_{i,nom}, 0.1 \leftrightarrow 0.9 I_{o,nom}$		5		5			5		
$\alpha_{vo}$	Temperature coefficient of $v_o$ (NTC)	$0 - I_{o,nom}, T_{C,min} - T_{C,max}$	-0.02		0	-0.02		0	-0.02		0	%/K

<sup>1</sup> Breakdown voltage of the incorporated suppressor diode at 1 mA. Exceeding this value might damage the suppressor diode.

<sup>2</sup> Measured according to IEC/EN 61204 with a probe described in annex A

<sup>3</sup> Recovery time until  $V_o$  returns to  $\pm 1\%$  of  $V_o$ ; see fig. 5.

<sup>4</sup> No overshoot at switch on.

<sup>5</sup> Output overvoltage protection by an electronic circuitry.

### Output Voltage Regulation

Line and load regulation of the output is so good that input voltage and output current have virtually no influence to the output voltage.

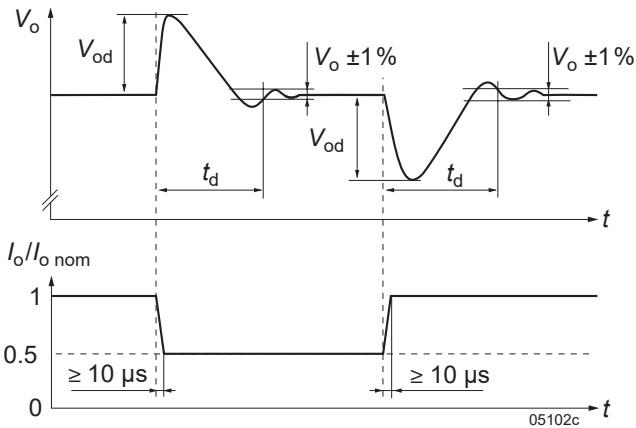

Fig. 5  
Typical dynamic load regulation of output voltage

### Thermal Considerations and Protection

A temperature protection is incorporated in the secondary control logic. It generates an internal protection, which enters output voltage hiccup mode in case of overtemperature. The converter automatically recovers, when the temperature drops below the limit. The relationship between  $T_A$  and  $T_C$  depends heavily upon the conditions of operation and integration into a system.

Caution: The installer must ensure that under all operating conditions  $T_C$  remains within the limits stated in table 7.

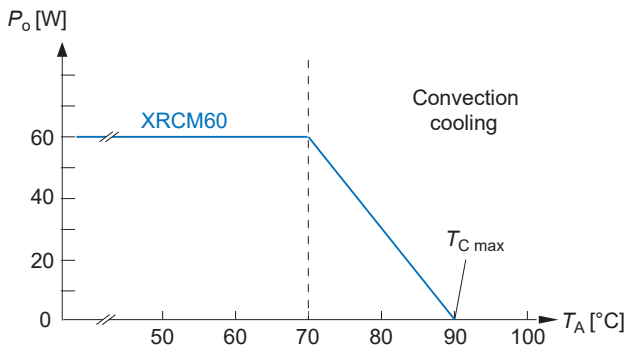

Fig. 6  
Typical output power derating versus temperature; free convection cooling.

### Output Current Limitation

The output is continuously protected against open-circuit (no load), overload and short-circuit by an electronic current limitation with rectangular characteristic; see fig. 7.

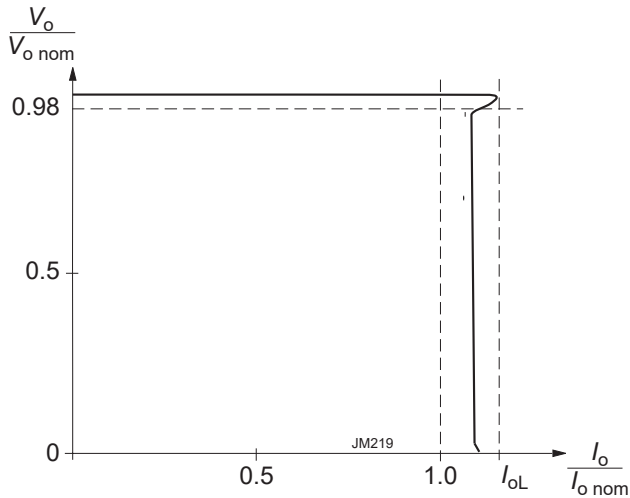

Fig. 7  
Rectangular current limitation

### Series and Parallel Connection

The outputs of several RCM Series converters may be connected in series.

Note: If the sum of the output voltages is greater than 60 V, it cannot be considered as ES1 (Safety Extra Low Voltage) according to the safety standard IEC/UL 62368-1.

Several RCM models of the same type can be operated in parallel connection. To ensure proper current sharing, the load lines should have equal length and section. The output voltage exhibits a slight droop characteristic, which facilitates current sharing. In addition, the output voltage tends to be lowered with increasing temperature.

### Redundant Systems

For redundant systems, we recommend the options Q and D, see Options.

### LED Indicator

The converters exhibit a green LED “Out OK”, signalling that the output voltage is within the specified range.



### DESCRIPTION OF OPTIONS

General conditions:

- $T_A = 25\text{ °C}$ , unless  $T_C$  is specified.

#### Option D: Output Voltage Monitor

Option D encompasses an output voltage monitor by a solid state relay. When  $V_o$  is in range, a solid state relay is activated (connecting OK1 with OK2). Max. data of relay contacts: 0.2 A / 120 VDC

Note: The trigger levels are typ.  $\pm 5\%$  of  $V_o$ .

#### Option Q: ORing FET for Redundant Systems

The outputs of 2 parallel connected converters are separated with ORing diodes (built by FETs). If one converter fails, the remaining one must be capable to still deliver the full power to the load. If more power is needed, the system may be extended to more parallel converters (n+1 redundancy).

Current sharing must be ensured by load lines of equal section and length. In addition, a slight droop characteristic of the output voltage and a negative temperature coefficient improve the load sharing as well.

To keep the losses as small as possible, the ORing diode is replaced by a FET. The voltage drop is approx. 22 mV (not dependent of  $I_o$ ).

Note: In the case of a failing converter, the output voltage is maintained by the redundant converters. However, the failing item should be identified and replaced. We recommend the Out OK function (option D).

#### Option F: Incorporated Fuse

The railway standard EN 50155 disadvises fuses in the converters. Consequently, the installer must preview an external fuse or circuit breaker. However, when this is not possible, an incorporated fuse is available (option F). This fuse is not accessible and will not trip, except if the converter is defect.

Note: Converters with option F are protected against input reverse polarity by a series FET.

Table 4: Recommended external fuses (same as incorporated with option F)

Converter	Specification
12RCM60	15 A fast acting
XRCM60	8 A fast acting

#### Option K: Pluggable Connectors

This option allows the use of pre-assembled pluggable connectors; for details see Accessories.

Note: Female connectors must be ordered separately.

## ELECTROMAGNETIC COMPATIBILITY (EMC)

### Electromagnetic Immunity

Table 5: Electromagnetic immunity (type tests). Corresponds or Exceeds EN50121-3-2:2016 and AREMA

Phenomenon	Standard	Level	Coupling mode <sup>1</sup>	Value applied	Waveform	Source imped.	Test procedure	In oper.	Perf. crit. <sup>2</sup>
Electrostatic discharge (to case)	IEC/EN 61000-4-2	4	contact discharge	6000 V <sub>p</sub>	1/50 ns	330 Ω 150 pF	10 pos. & 10 neg. discharges	yes	A
			air discharge	8000 V <sub>p</sub>					
Electromagnetic field	IEC/EN 61000-4-3	x	antenna	20 V/m	AM 80% / 1 kHz	N/A	80 – 800 MHz	yes	A
			antenna	20 V/m	AM 80% / 1 kHz	N/A	800 – 1000 MHz		
				20 V/m <sup>7</sup>			1400 – 2000 MHz		
				5 V/m			2000 – 2700 MHz		
3 V/m	5100 – 6000 MHz								
Electrical fast transients/burst	IEC/EN 61000-4-4	3	capacitive, o/c	±2000 V <sub>p</sub>	bursts of 5/50 ns; 2.5/5 kHz over 15 ms; burst period: 300 ms	50 Ω	60 s positive 60 s negative transients per coupling mode	yes	A
		3	i/c, +i/-i direct coupling						
Surges	IEC/EN 61000-4-5	3	i/c	±2000 V <sub>p</sub>	1.2 / 50 μs	42 Ω 0.5 μF	5 pos. & 5 neg. surges per coupling mode	yes	A
			+i/-i	±1000 V <sub>p</sub>					
Surges	Arema 11.5.2		i/c, +i/-i	±2000 V <sub>p</sub>	1.2 / 50 μs	12 Ω 9 μF	5 pos. & 5 neg. surges per coupling mode	yes	B
						2 Ω 18 μF <sup>3</sup>			
Conducted disturbances	IEC/EN 61000-4-6	3	i, o, signal wires	10 VAC (140 dBμV)	AM 80% / 1 kHz	150 Ω	0.15 – 80 MHz	yes	A
Electromagnetic radiation - Absorber chamber <sup>6</sup>	ISO 11452-2	-	antenna	30 V/m (rms)	AM 80% / 1 kHz PM / (ton 577 us, period 4600 us)	-	400 – 800 MHz 800 - 2000 MHz	yes	A
Electromagnetic radiation - Bulk current injection <sup>6</sup>	ISO 11452-4	-	current injection probe	60 mA (rms)	80% AM, 1 kHz	-	20 to 400 MHz	yes	A
Transient disturbances along supply lines <sup>6</sup>	ISO 7637-2	3	+i/-i	See standard	See standard	-	Test Pulses: 1, 2a, 2b, 3a, 3b & 4	yes	<sup>4</sup>
Supply line switching <sup>6</sup>	ISO 7637-2	-	+i/-i	See standard	See standard	-	See standard	yes	<sup>5</sup>

<sup>1</sup> i = input, o = output, c = case

<sup>2</sup> A = normal operation, no deviation from specs.; B = normal operation, temporary loss of function or deviation from specs possible

<sup>3</sup> Test is applicable for 12RCM models only.

<sup>4</sup> Functional Criterion during the test: Related to immunity-related functions

<sup>5</sup> Functional Criterion during the test: Maximum allowed pulse amplitudes: + 75V / -100V for 12V system, +150V / -450V for 24V system

<sup>6</sup> Tests listed per standards ISO 11452-2, ISO 11452-4 & ISO 7637-2 are applicable for 12RCM60 models only.

<sup>7</sup> Tested value 20 V/m is required by AREMA; 10 V/m is valid for EN50121-3-2

### Electromagnetic Emissions

All conducted emissions (fig. 8) have been tested as per EN 55011, group 1, class A. These limits are much stronger than requested in EN 50121-3-2:2016, table 2.1, and coincide with EN 50121-4:2016, table 1.1. Figures 8a & 8b show an example of Conducted Emissions on model XRCM60-24 as a representative for the whole RCM60 series (XRCM60 & 12RCM60).

The average values must respect a margin of 10 dB $\mu$ V below the limits for quasipeak.

Radiated emissions have been tested according to EN 55011, group 1, class A. These limits are similar to the requirements of EN 50121-3-2:2016 and EN 50121-4:2016, both calling up EN 61000-6-4+A1:2011, table 1. The tests were executed with horizontal and vertical polarization. Figures 9a & 9b show an example of Radiated Emissions on model XRCM60-24 as a representative for the whole RCM60 series (XRCM60 & 12RCM60).

Note: The highest frequency of the internal sources of EUT is less than 108 MHz. Hence, Radiated Measurement was made up to 1 GHz. Non-accredited measurement up to 6 GHz are available on request.

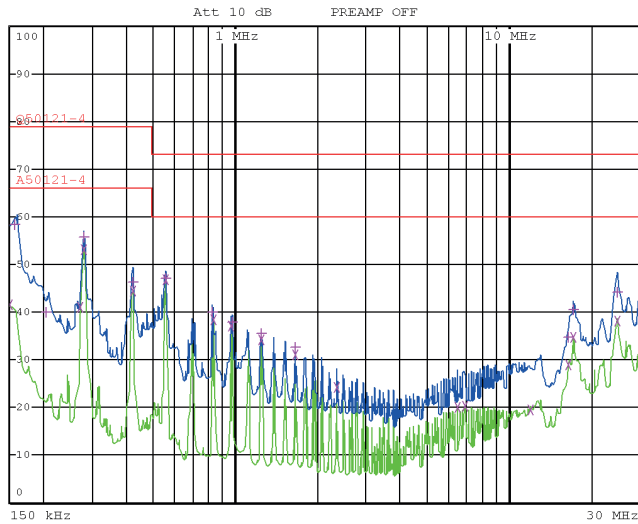

**Fig. 8a**  
XRCM60-24: Typ. disturbance voltage at the input  
( $V_i = 16.8$  V,  $I_{i,nom}$ , resistive load, quasi peak and average)

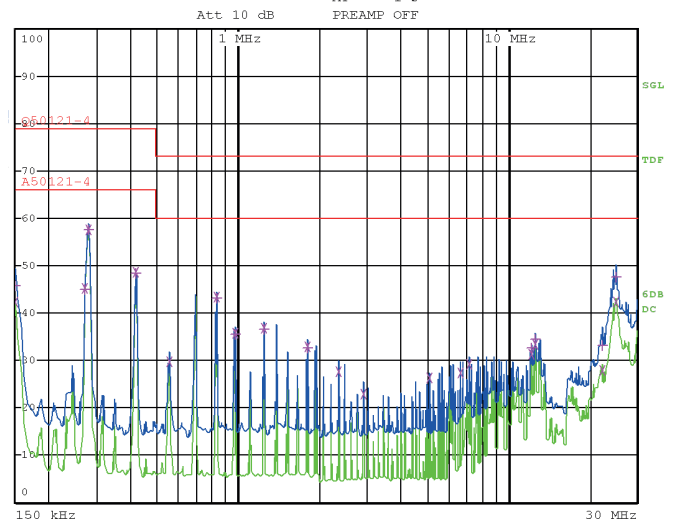

**Fig. 8b**  
XRCM60-24: Typ. disturbance voltage at the input  
( $V_i = 137.5$  V,  $I_{i,nom}$ , resistive load, quasi peak and average)

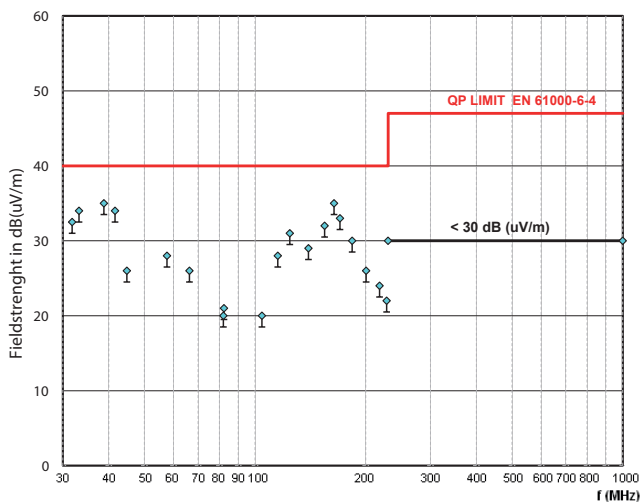

**Fig. 9a**  
XRCM60-24: Typ. radiated disturbances in 10 m distance  
( $V_i = 16.8$  V,  $I_{i,nom}$ , resistive load, quasi peak).

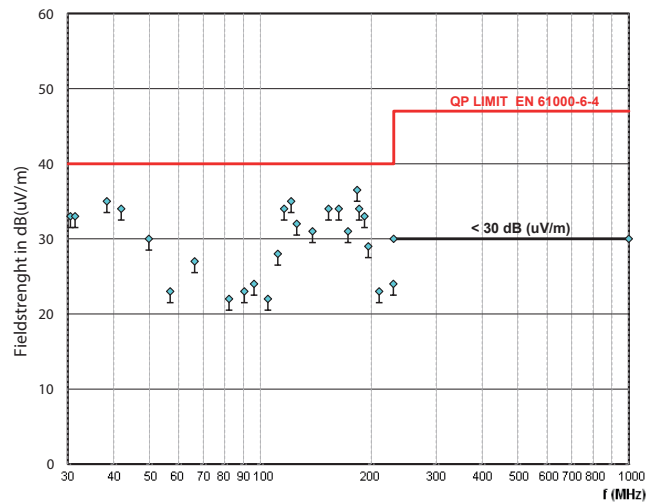

**Fig. 9b**  
XRCM60-24: Typ. radiated disturbances in 10 m distance  
( $V_i = 137.5$  V,  $I_{i,nom}$ , resistive load, quasi peak).

### Broadband & Narrowband Emissions

In addition, 12RCM60 Series is qualified to broadband & narrowband emissions defined in the UN reg. No. 10. Annex 7 and Annex 8 of this regulation defines two groups of tests for radiated emissions:

- 1) Broadband emissions caused by ignition systems, brushed DC motors and on-board battery-charging units, and
- 2) Narrowband emissions from switching power supplies, clock harmonics and so forth.

Following are the test results for broadband (represented by Peak waveform) and narrowband (Avg waveform) electromagnetic emissions. Resolution bandwidth of 120 kHz. The test is performed according to CISPR 25. Vertical polarisation of antenna is depicted.

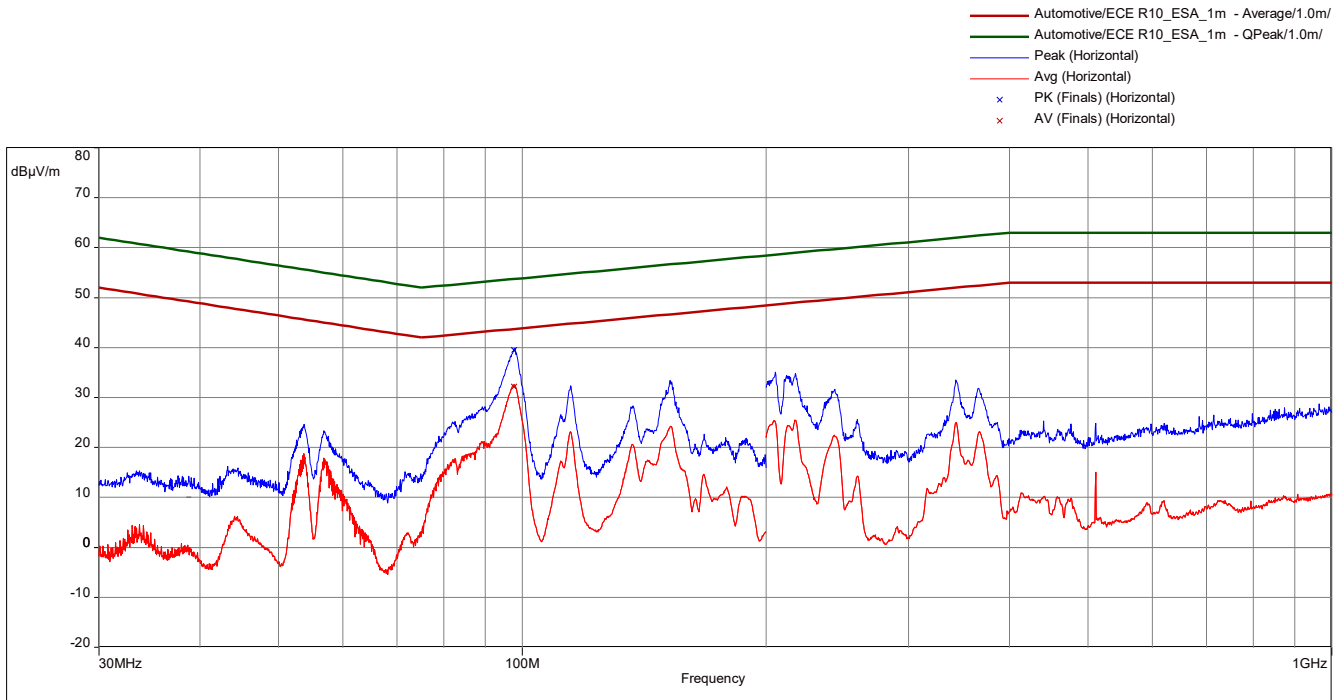

Fig. 10  
12RCM60-24: Typ. radiated disturbances in 1 m distance ( $V_i = 13.5 V$ ,  $I_{i_{nom}}$  resistive load, peak & average)

### IMMUNITY TO ENVIRONMENTAL CONDITIONS

Table 6: Mechanical and climatic stress. Air pressure 700 – 1200 hPa

Test method		Standard	Test Conditions		Operating Condition
Ad	Low temperature start-up test	EN 50155:2017, clause 13.4.4 IEC/EN 60068-2-1	Temperature, duration:	- 40 °C, 2 h	Operating perf. crit. A
			Performance test:	+25 °C	
Be	Dry heat test, cycle A	EN 50155:2017, clause 13.4.5 IEC/EN 60068-2-2	Temperature:	70 °C	Operating perf. crit. A
			Duration:	6 h	
Db 2	Cyclic damp heat test	EN 50155:2017, clause 13.4.7 IEC/EN 60068-2-30	Temperature:	55 °C and 25 °C	Not operating
			Cycles (respiration effect):	2	
			Duration:	2x 24 h	
Ka	Salt mist test sodium chloride (NaCl) solution	EN 50155:2017, clause 13.4.10 IEC/EN 60068-2-11	Temperature:	35 ±2 °C	Converter not operating
			Duration:	48 h	
-	Functional random vibration test	EN 50155:2017 clause 13.4.11.4 EN 61373:2010 clause 8, class B, body mounted <sup>1</sup>	Acceleration amplitude:	0.1 g <sub>n</sub> = 1.01 m/s <sup>2</sup>	Operating perf. crit. A
			Frequency band:	5 – 150 Hz	
			Test duration:	30 min (10 min in each axis)	
-	Simulated long life testing	EN 50155:2017 clause 13.4.11.2 EN 61373:2010 clause 9, class B, body mounted <sup>1</sup>	Acceleration amplitude:	0.58 g <sub>n</sub> = 5.72 m/s <sup>2</sup>	Not operating
			Frequency band:	5 – 150 Hz	
			Test duration:	15 h (5 h in each axis)	
-	Shock test	EN 50155:2017 clause 13.4.11.3 EN 61373:2010 clause 10, class B, body mounted <sup>1</sup>	Acceleration amplitude:	5.1 g <sub>n</sub>	Operating perf. crit. A
			Bump duration:	30 ms	
			Number of bumps:	18 (3 in each direction)	
-	Vibration sinusoidal	AREMA Part. 11.5.1 class C, D, E, I, J	Displacement amplitude:	0.3" (5 – 10 Hz) 0.07" (5 – 20 Hz)	Operating perf. crit. A
			Acceleration amplitude:	1.5 g <sub>n</sub> = 14.7 m/s <sup>2</sup> (10 – 200 Hz)	
			Frequency:	5 – 200 Hz	
			Test duration:	12 h (4 h in each axis)	
-	Mechanical shock	AREMA Part. 11.5.1 class C, D, E, I, J	Acceleration amplitude:	10 g <sub>n</sub> = 98 m/s <sup>2</sup>	Operating perf. crit. A
			Bump duration:	11 ms	
			Number of bumps:	18 (3 in each direction)	

<sup>1</sup> Body mounted = chassis of a railway coach

### Temperatures

Table 7: Temperature specifications, valid for an air pressure of 700 – 1200 hPa (700 – 1200 mbar)

Temperature			EN 50155:2017 Class OT4			Unit
Characteristics		Conditions	min	max	10 minutes	
T <sub>A</sub>	Ambient temperature	Converter operating	- 40	70	85	°C
T <sub>C</sub>	Case temperature <sup>1</sup>		- 40	90		
T <sub>S</sub>	Storage temperature	Not operational	- 55	85		

<sup>1</sup> Measured at the measurement point T<sub>C</sub>; see Mechanical Data.

### Reliability

Table 8: MTBF and device hours

Ratings at specified case temperature between failures	Model	MTBF
According to IEC 61709 / SN 29500	XRCM60-24DQF	1.24 million hours



Asia-Pacific  
+86 755 298 85888

EMEA  
+353 61 49 8941

North America  
+1 866 513 2839

tech.support@psbel.com  
[belfuse.com/power-solutions](http://belfuse.com/power-solutions)

**MECHANICAL DATA**

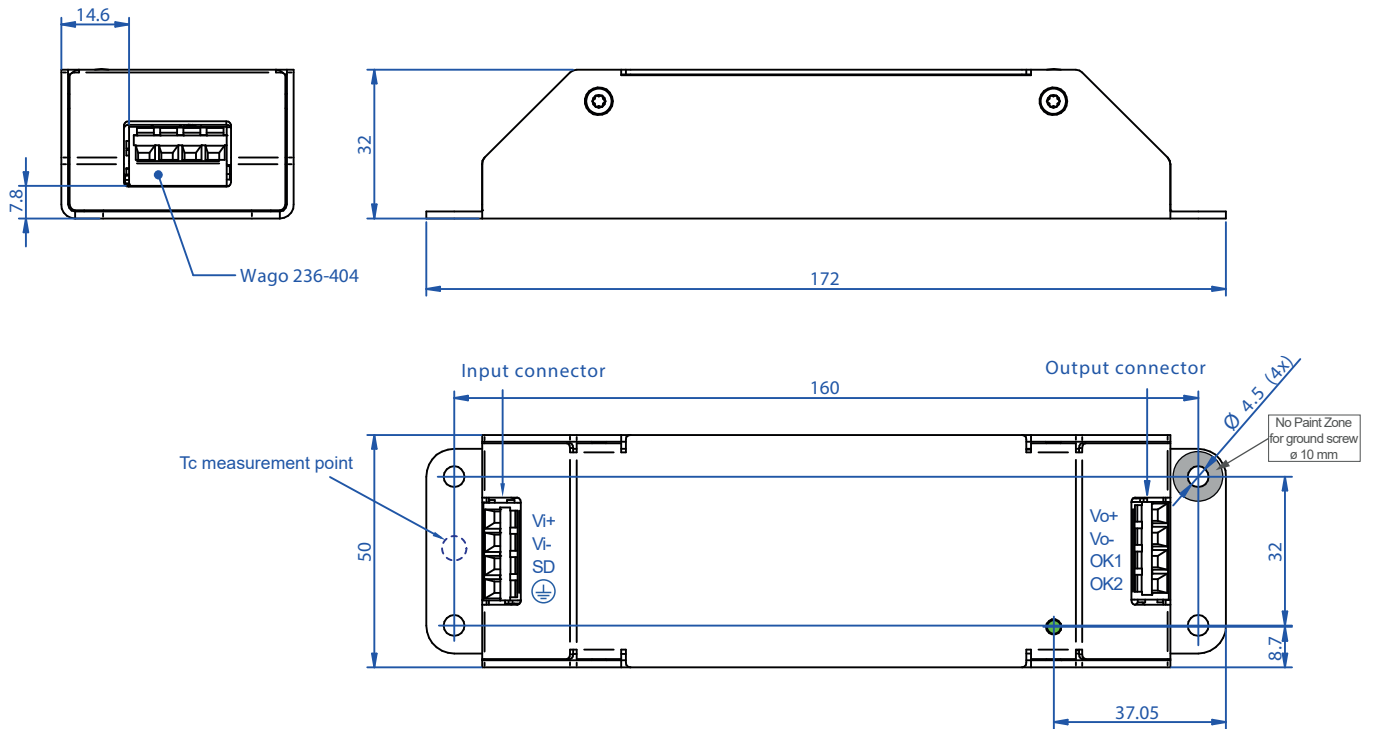

Fig. 11  
Case of RCM60 with standard cage clamp terminals, Aluminum, EP-powder coated  
Weight approx. 350 g

### SAFETY AND INSTALLATION INSTRUCTION

#### Connectors and Pin Allocation

##### RCM60 (standard version)

- Input connector:
  - 4 pins: Wago 236-404: Vi+, Vi-, SD, PE
  - wire section: 0.08 – 2.5 mm<sup>2</sup>, 28 – 12 AWG
- Output connector:
  - 4 pins: Wago 236-404: Vo+, Vo-, OK1/n.c., OK2/n.c.
  - wire section: 0.08 – 2.5 mm<sup>2</sup>, 28 – 12 AWG

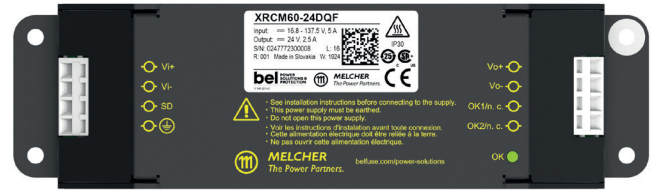

Fig. 12  
Pin allocation of RCM60 (standard version)

Table 9a: Input connector (standard version)

Pin no.	Pin description	Function
1	Vi+	Input positive
2	Vi-	Input negative
3	SD	Primary shutdown
4	⊕	Protective earth PE

Table 9b: Output connector (standard version)

Pin no.	Pin description	Function
1	Vo+	Output positive
2	Vo-	Output negative
3	OK1/n.c.	Relay contact 1 / Not connected <sup>1</sup>
4	OK2/n.c.	Relay contact 2 / Not connected <sup>1</sup>

<sup>1</sup> Not connected if option D is not fitted

##### RCM60 (K option)

- Input connector:
  - 4 pins: Phoenix 1923995: Vi+, Vi-, SD, PE
- Output connector:
  - 5 pins: Phoenix 1827897: Vo+, Vo-; n.c., OK1/n.c., OK2/n.c.

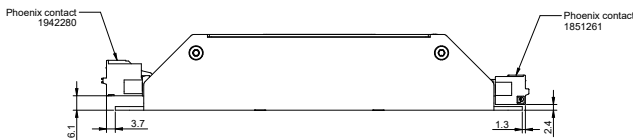

Fig. 13a  
Assembled input and output connector RCM60 (K option)

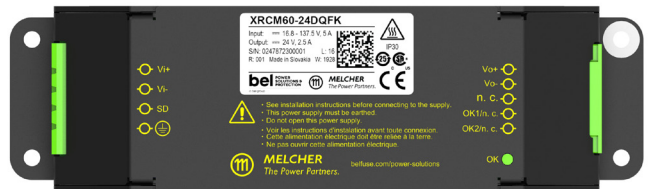

Fig. 13b  
Pin allocation of RCM60 (K option)

Table 10a: Input connector (K option)

Pin no.	Pin description	Function
1	Vi+	Input positive
2	Vi-	Input negative
3	SD	Primary shutdown
4	⊕	Protective earth PE

Table 10b: Output connector (K option)

Pin no.	Pin description	Function
1	Vo+	Output positive
2	Vo-	Output negative
3	n.c.	Not connected
4	OK1/n.c.	Relay contact 1 / Not connected <sup>1</sup>
5	OK2/n.c.	Relay contact 2 / Not connected <sup>1</sup>

<sup>1</sup> Not connected if option D is not fitted

### Installation Instruction

These converters are components, intended exclusively for inclusion by an industrial assembly process or by a professionally competent person. Installation must strictly follow the national safety regulations in respect of the enclosure, mounting, creepage distances, clearances, markings and segregation requirements of the end-use application.

Connection to the system is allowed only with cables having suitable wire section, (see section “Connectors and Pin Allocation”).

Other installation methods may not meet the safety requirements. Check that PE is safely connected to protective earth.

No fuse is incorporated in the converter (except for option F). An external circuit breaker or a fuse in the wiring to one or both input pins.

Do not open the converters, or the warranty will be invalidated. Make sure that there is sufficient airflow available for convection cooling and that the temperature of the bottom plate is within the specified range. This should be verified by measuring the case temperature at the specified measuring point, when the converter is operated in the end-use application.  $T_{C\max}$  should not be exceeded. Ensure that a failure of the converter does not result in a hazardous condition.

### Standards and Approvals

The RCM Series converters are approved according to the last edition of IEC/EN 62368-1 and UL/CSA 62368-1. They have been evaluated for:

- Class I equipment
- Building in
- Reinforced insulation between input and output
- Basic insulation between input and chassis, input and relay contacts (OK1, OK2) and output to relay contacts (OK1, OK2)
- Pollution degree 2 environment
- Altitude 3000 m

The converters are subject to manufacturing surveillance in accordance with the above mentioned safety standards and with ISO 9001:2015, IRIS ISO/TS 22163:2017 certified quality and business management system.

### Cleaning Liquids and Protection Degree

The converters are not hermetically sealed. In order to avoid possible damage, any penetration of liquids shall be avoided.

The converters correspond to protection degree IP 30.

### Railway Applications

The RCM Series converters have been designed observing the railway standards EN 50155:2021, EN 50121-3-2:2016, EN 50124-1:2017 and AREMA. All boards are coated with a protective lacquer.

The converters comply with the fire & smoke standard EN 45545:2016, HL1 to HL3.

### Insulation Test

The electric strength test is performed in the factory as routine test in accordance with EN 62911, EN 50155:2021 and AREMA. It should not be repeated in the field, and the Company will not honor warranty claims resulting from incorrectly executed electric strength tests.

Table 11: Isolation

Characteristics	Input to Output <sup>1</sup>	Input to Case	Output to Case	OK contacts to			Unit
				Input	Case	Outputs	
Voltage withstand levels (tested acc. to IEC 62368-1)	4.2	2.2	1.5	2.2	2.2	2.2	kVDC
Voltage withstand levels (designed to meet AREMA and factory tested)	4.2 <sup>1</sup>	2.86	2.86	2.86	2.86	2.86	kVDC
Insulation resistance <sup>2</sup>	>300	>300	>300	>300	>300	>300	MΩ
Creepage distances	5.0	2.5	2.5	2.5	2.5	2.5	mm

<sup>1</sup> Pretest of subassemblies in accordance with IEC/EN 62368-1

<sup>2</sup> Tested at 500 VDC





## ACCESSORIES

### Female Connectors

For converters RCM60 with option K, use (see Fig.14):

- Input plug: Phoenix Contact P/N: 1942280 (HZZ00151-G)  
Wire section: 0.2 – 2.5 mm<sup>2</sup>, 24 – 12 AWG
- Output plug: Phoenix Contact P/N: 1851261 (HZZ00152-G)  
Wire section: 0.14 - 1.5mm<sup>2</sup>, 26 - 16 AWG

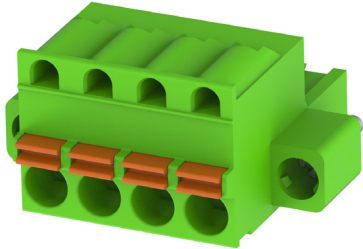

Fig. 14a  
Input plug for RCM60 with option K

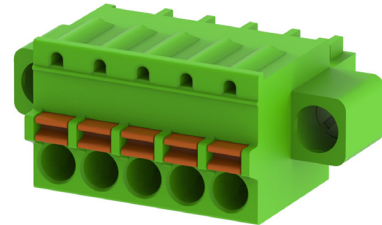

Fig. 14b  
Output plug for RCM60 with option K

### DIN-Rail Mounting Bracket DMB

A suitable DIN-Rail mounting bracket HZZ00625-G is available; see Fig. 15.

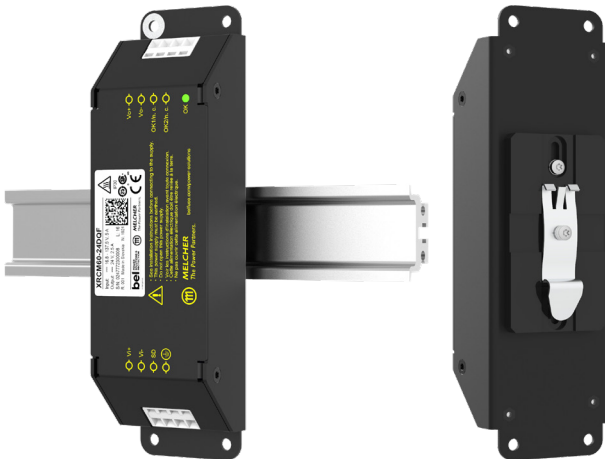

Fig. 15  
DIN-Rail mounting bracket for RCM series HZZ00625-G

**NUCLEAR AND MEDICAL APPLICATIONS** - These products are not designed or intended for use as critical components in life support systems, equipment used in hazardous environments, or nuclear control systems.

**TECHNICAL REVISIONS** - The appearance of products, including safety agency certifications pictured on labels, may change depending on the date manufactured. Specifications are subject to change without notice.

## X-ON Electronics

Largest Supplier of Electrical and Electronic Components

*Click to view similar products for [Isolated DC/DC Converters - Chassis Mount](#) category:*

*Click to view products by [Bel Fuse](#) manufacturer:*

Other Similar products are found below :

[RPS8-350ATX-XE](#) [AK-1615-7R](#) [EBC4050N042N75](#) [FK1601-7RT](#) [AM3040-9G](#) [BQ2660-9RF](#) [B62SR24125CC](#) [B40SR12424CC](#)  
[VTD24SC24-O](#) [VTB05SC110-O](#) [B62SR13722AC](#) [TMDC 20-4811](#) [TMDC 20-4815](#) [TMDC 40-2411](#) [TMDC 40-4811](#) [TMDC 60-2411](#)  
[TMDC 60-4815](#) [RSD-300D-5](#) [STMGFS152412](#) [TMDC 20-2411](#) [TMDC 20-2412](#) [TMDC 20-2418](#) [TMDC 60-4811](#) [TMDC 60-4812](#) [TMDC](#)  
[60-4818](#) [VHK150W-Q24-S48](#) [EQ2001-9RG](#) [SD-100A-12](#) [RSD-30G-3.3](#) [RSD-30H-3.3](#) [RSD-30H-5](#) [RSD-30L-3.3](#) [RSD-30L-5](#) [RSD-60G-5](#)  
[RSD-60H-24](#) [RSD-60H-3.3](#) [RSD-60H-5](#) [RSD-30G-5](#) [VHK200W-Q24-S12](#) [RSD-60L-5](#) [MGFS32412](#) [VHK150W-Q24-S12](#) [TEQ 300-](#)  
[7216WIR](#) [MGFS32415](#) [MGFS3243R3](#) [PS8-250ATX-ZE](#) [RPS8-750ATX-XE](#) [PS8-300ATX-ZBE](#) [RPM40-2412DG](#) [TEQ 300-7215WIR](#)