

16V 500mA Low Consumption Linear Regulator

DESCRIPTION

BL8075 series is a group of positive voltage output, low power consumption, low dropout voltage regulator. It can provide 300mA output current when input / output voltage differential drops to 600mV ($V_{out}=3.3V$), and it also provides foldback short-circuit protection, thermal protection and output current limit function. The very low power consumption of BL8075 ($I_q=10\mu A$) can greatly improve natural life of batteries.

BL8075 can provide output value in the range of 1.2V~5.0V in 0.1V steps. It also can customize on command.

BL8075 includes high accuracy voltage reference, error amplifier, current limit circuit and output driver module.

BL8075 has well load transient response and good temperature characteristic, And it uses trimming technique to guarantee output voltage accuracy within $\pm 2\%$.

TYPICAL APPLICATION

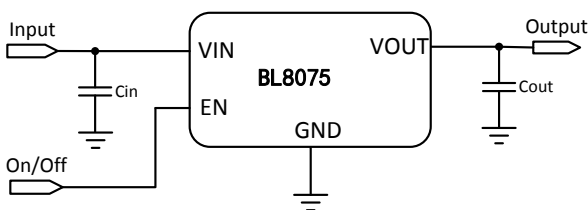

NOTE: Input capacitor ($C_{in}=1\mu F$) and Output capacitor ($C_{out}=1\mu F$) are recommended in all application circuit. Ceramic capacitor is recommended.

FEATURES

- Low Power Consumption: 10 μA (Typ.)
- Maximum Output Current: 500mA
- Small Dropout Voltage
600mV@300mA ($V_{out}=3.3V$)
1.2V@500mA ($V_{out}=3.3V$)
- Input Voltage Range: 3V~16V
- Output Voltage Range: 1.2V~5.0V (customized on command in 0.1V steps)
- Highly Accurate: $\pm 2\%$ ($\pm 1\%$ customized)
- Output Current Limit: 650mA

APPLICATIONS

- Battery Powered equipment
- Power Management of MP3、PDA、DSC、Mouse、PS2 Games
- Reference Voltage Source Regulation after Switching Power

ELECTRICAL CHARACTERISTICS

Load Regulation

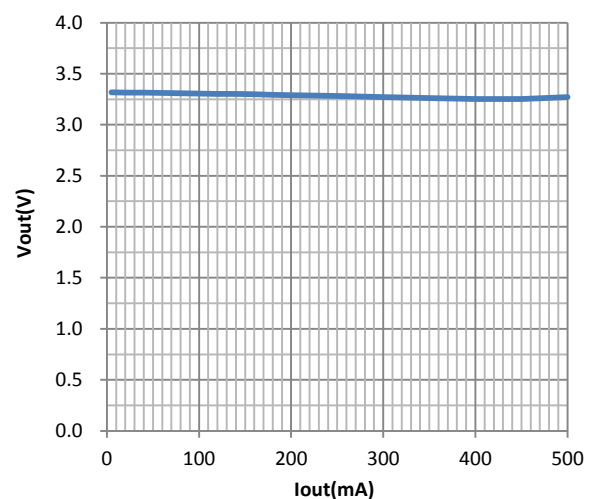

ORDERING INFORMATION

BL8075 ①②③④⑤

| Code | Description |
|------|---|
| ① | Temperature&Rohs: C:-40~85°C ,Pb Free Rohs Std. |
| ② | Package type: B5:SOT-23-5 C3:SOT-89-3 |
| ③ | Packing type: TR:Tape&Reel (Standard) |
| ④ | Output voltage: e.g. 12=1.2V 15=1.5V 50=5.0V |
| ⑤ | Voltage accuracy: 1= ± 1% Blank(default)= ± 2% |

ABSOLUTE MAXIMUM RATING

| Parameter | Value | |
|--|--------------|-------|
| Max Input Voltage | 20V | |
| Operating Junction Temperature(Tj) | 125°C | |
| Ambient Temperature(Ta) | -40°C -85°C | |
| Power Dissipation (P _D @Ta=25°C) | SOT-23-5 | 400mW |
| | SOT-89-3 | 500mW |
| Storage Temperature(Ts) | -40°C -150°C | |
| Lead Temperature & Time | 260°C,10S | |

Note:

Exceed these limits to damage to the device.
Exposure to absolute maximum rating conditions may affect device reliability.

PIN CONFIGURATION

| | | | |
|------------------------|-------------------|----------------|--------|
| Product Classification | | BL8075CB5TR□□□ | |
| Marking | | SOT-23-5 | |
| PXYW | P:Product Code | VIN 1 | 5 VOUT |
| | X:Output Voltage | GND 2 | PXYW |
| | YW:Date Code | EN 3 | 4 NC |
| Product Classification | | BL8075CC3TR□□□ | |
| Marking | | SOT-89-3 | |
| PXX LLXYW | P:Product Code | 1 GND | |
| | XX:Output Voltage | 2 VIN | |
| | LL:LOT NO. | 3 VOUT | |
| | X:FAB Code | PXX LLXYW | |
| YW:Date Code | 1 2 3 | | |

Y: The Year of manufacturing, "1" stands for year 2011, "2" stands for year 2012, and "8" stands for year 2018.
W: The week of manufacturing. "A" stands for week 1, "Z" stands for week 26, "Ā" stands for week 27, "Z̄" stands for week 52.

RECOMMENDED WORK CONDITIONS

| Item | Min | Recom- mended | Max. | Unit |
|---------------------|-----|------------------|------|------|
| Input Voltage Range | 3 | | 16 | V |
| Ambient Temperature | -40 | | 85 | °C |

ELECTRICAL CHARACTERISTICS

(Test Conditions: $C_{in}=1\mu F$, $C_{out}=1\mu F$, $T_a=25^\circ C$, Unless Otherwise Specified)

| Symbol | Parameter | Conditions | Min | Type | Max | Units |
|--|--|--|---|-----------|-----------------------|-----------------|
| V_{in} | Input Voltage | | 3 | | 16 | V |
| V_{out} | Output Voltage | $V_{out}>1.5V$ | $V_{in}-V_{out}=1.2V$ $1mA \leq I_{out} \leq 30mA$ | Vout | $V_{out} \times 0.98$ | V |
| | | $V_{out} \leq 1.5V$ | | | -0.03 | |
| $I_{out(Max.)}$ | Maximum Output Current | $V_{in}-V_{out}=1.2V$ | 500 | | | mA |
| Dropout Voltage | Input-Output Voltage Differential | $I_{out}=300mA$, $V_{out} = 3.3V$ | | 600 | | mV |
| $\frac{\Delta V_{out}}{\Delta V_{in} \cdot V_{out}}$ | Line Regulation | $I_{out}=10mA$, $4V \leq V_{in} \leq 16V$ | | 0.2 | 0.3 | %/V |
| ΔV_{out} | Load Regulation | $V_{in} = \text{Set } V_{out} + 1V$ $1mA \leq I_{out} \leq 100mA$ | | 20 | 40 | mV |
| I_q | Quiescent Current | $V_{in} = \text{Set } V_{out} + 1V$, $V_{EN} = "H"$ | | 10 | 20 | μA |
| | | $V_{in} = 12V$, $V_{EN} = 0V$ | | | 1 | μA |
| $\frac{\Delta V_{out}}{\Delta T \cdot V_{out}}$ | Output Voltage Temperature Coefficient | $I_{out}=10mA$ | | ± 100 | | ppm/ $^\circ C$ |
| V_{enh} | EN Input Voltage "H" | | 1.5 | | V_{in} | V |
| V_{enl} | EN Input Voltage "L" | | 0 | | 0.4 | V |
| | Thermal Shutdown | | | 150 | | $^\circ C$ |

BLOCK DIAGRAM

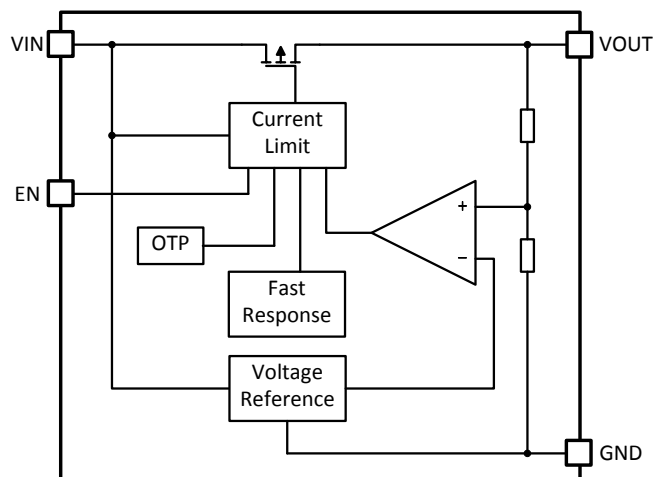

EXPLANATION

BL8075 is a series of low dropout voltage and low power consumption regulator. Its application circuit is very simple, which only needs two outside capacitors. It is composed of these modules: high accuracy voltage reference, current limit circuit, error amplifier, output driver and power transistor.

Current Limit module can keep chip and power system away from danger when load current is more than 500mA.

BL8075 uses trimming technique to assure the accuracy of output value within $\pm 2\%$, at the same time, temperature compensation is elaborately considered in this chip, which makes BL8075's temperature coefficient within $\pm 100\text{ppm}/^\circ C$.

TYPICAL PERFORMANCE CHARACTERISTICS

Load Regulation

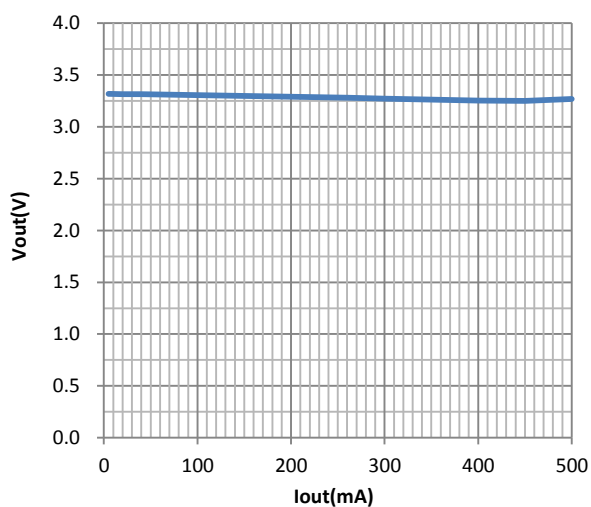

Line Regulation

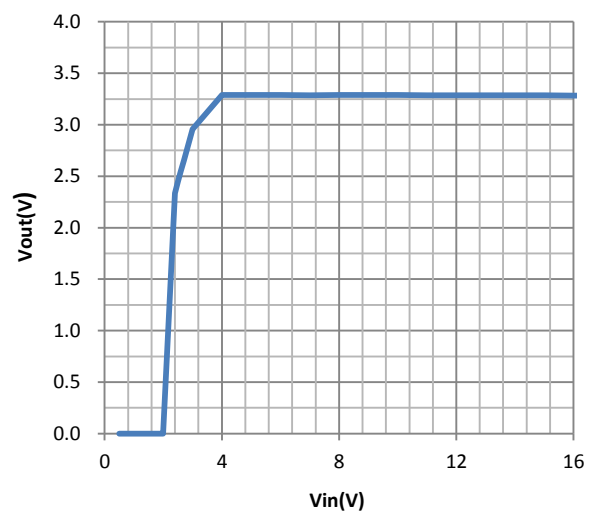

Dropout

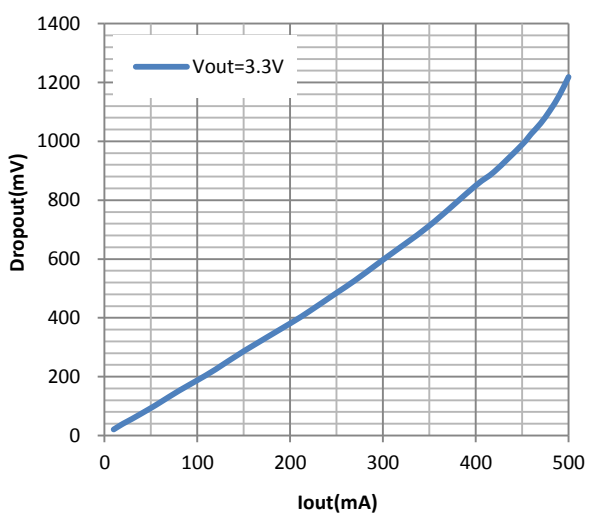

Iq

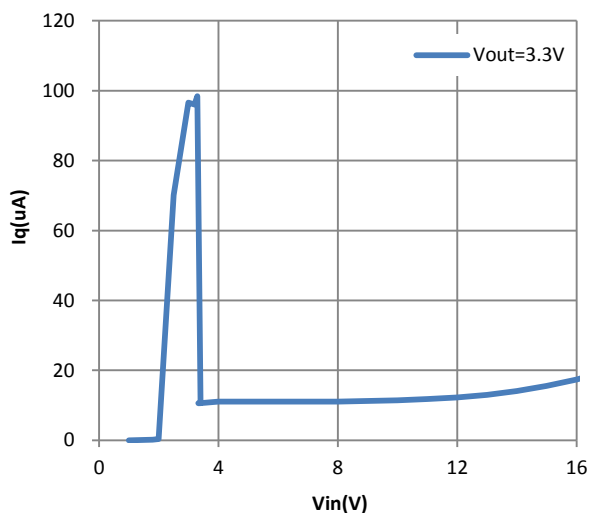

Current Limit

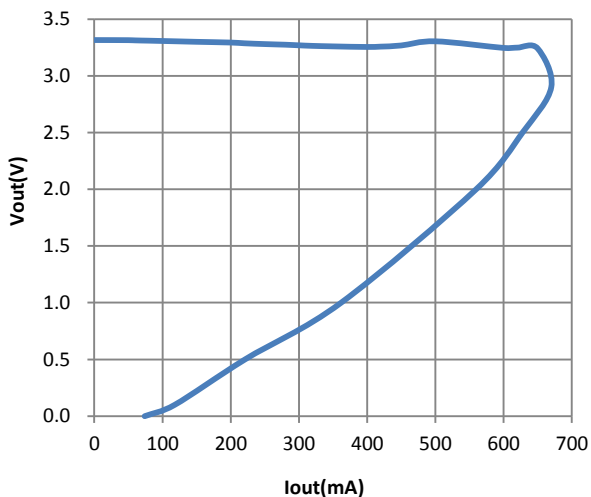

Line transient response

Vin=5V~6V, Iout=10mA
Ch1—Vin, Ch2—Vout

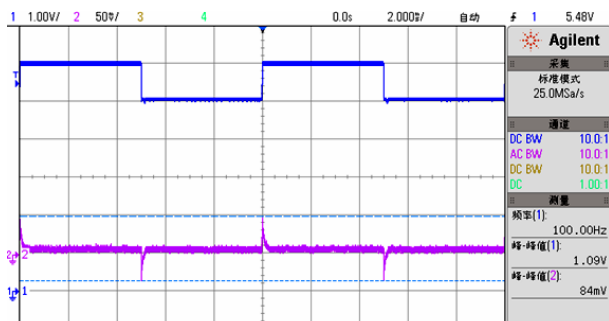

Load transient response

Vin=5V, Iout=5mA~150mA
Ch2—Vout, Ch4—Iout

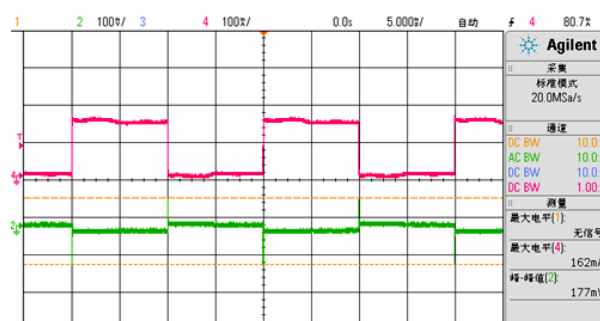

PACKAGE LINE

| Package | SOT-23-5 | Devices per reel | 3000Pcs | Unit | mm |
|--------------------|----------|------------------|---------|------|----|
| Package dimension: | | | | | |
| | | | | | |

BL8075

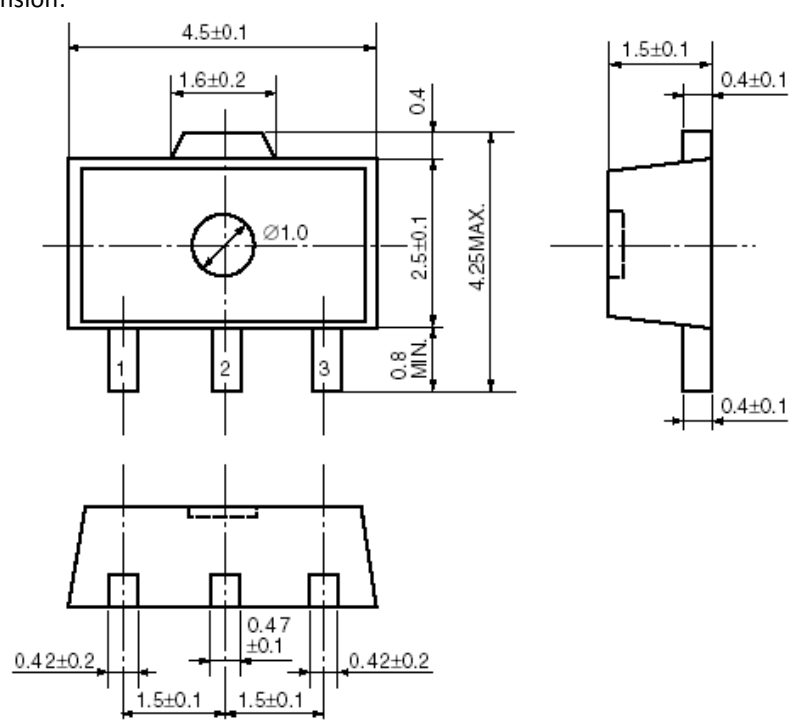
| Package | SOT-89-3 | Devices per reel | 1000Pcs | Unit | mm |
|---|----------|------------------|---------|------|----|
| Package Dimension: | | | | | |
|  <p>The technical drawing illustrates the BL8075 SOT-89-3 package in three views: top, side, and bottom. The top view shows a rectangular package with a width of 4.5 ± 0.1 mm and a central circular feature with a diameter of $\varnothing 1.0$ mm. A trapezoidal feature is located at the top, with a width of 1.6 ± 0.2 mm and a height of 0.4 mm. The package has three leads labeled 1, 2, and 3, with a minimum lead height of 0.8 mm. The total height of the package is 2.5 ± 0.1 mm, with a maximum height of 4.25 mm. The side view shows a trapezoidal profile with a top width of 1.5 ± 0.1 mm and a bottom width of 0.4 ± 0.1 mm. The bottom view shows the lead spacing, with a lead width of 0.42 ± 0.2 mm, a lead-to-lead distance of 1.5 ± 0.1 mm, and a lead-to-center distance of 0.47 ± 0.1 mm.</p> | | | | | |

X-ON Electronics

Largest Supplier of Electrical and Electronic Components

Click to view similar products for [Linear Voltage Regulators](#) category:

Click to view products by [Belling](#) manufacturer:

Other Similar products are found below :

[LV56831P-E](#) [LV5684PVD-XH](#) [MCDTSA6-2R](#) [L7815ACV-DG](#) [PQ3DZ53U](#) [LV56801P-E](#) [TLE42794G](#) [L78L05CZ/1SX](#) [L78LR05DL-MA-E](#) [636416C](#) [714954EB](#) [BA033LBSG2-TR](#) [LV5680P-E](#) [L78M15CV-DG](#) [TLS202B1MBV33HTSA1](#) [L79M05T-E](#) [TLS202A1MBVHTSA1](#) [L78LR05D-MA-E](#) [NCV317MBTG](#) [NTE7227](#) [LV5680NPVC-XH](#) [LT1054CN8](#) [MP2018GZD-5-Z](#) [MP2018GZD-33-Z](#) [MIC5281-3.3YMM](#) [RT9078-28GQZ](#) [MC78L06BP-AP](#) [TA48LS05F\(TE85L,F\)](#) [TA78L12F\(TE12L,F\)](#) [TC47BR5003ECT](#) [TCR2LN12,LF\(S](#) [TCR2LN28,LF\(S](#) [TCR2LN30,LF\(S](#) [TCR3DF295,LM\(CT](#) [TCR3DF40,LM\(CT](#) [BA178M20CP-E2](#) [L78M12ABDT](#) [LM7812SX/NOPB](#) [LR645N3-G-P003](#) [LR645N3-G-P013](#) [ZXTR2005P5-13](#) [SCD7812BTG](#) [TCR3DF335,LM\(CT](#) [ZXTR2012K-13](#) [TLE42994E V33](#) [ZXTR2008K-13](#) [ZXTR2005K-13](#) [LA5693D-E](#) [L88R05DL-E](#) [ADP3300ARTZ-2.7RL7](#)